

# Altivar Machine ATV340

## Variable Speed Drives for Asynchronous and Synchronous Motors

### Programming Manual

NVE61643.08  
03/2023



# Legal Information

The Schneider Electric brand and any trademarks of Schneider Electric SE and its subsidiaries referred to in this guide are the property of Schneider Electric SE or its subsidiaries. All other brands may be trademarks of their respective owners.

This guide and its content are protected under applicable copyright laws and furnished for informational use only. No part of this guide may be reproduced or transmitted in any form or by any means (electronic, mechanical, photocopying, recording, or otherwise), for any purpose, without the prior written permission of Schneider Electric.

Schneider Electric does not grant any right or license for commercial use of the guide or its content, except for a non-exclusive and personal license to consult it on an "as is" basis. Schneider Electric products and equipment should be installed, operated, serviced, and maintained only by qualified personnel.

As standards, specifications, and designs change from time to time, information contained in this guide may be subject to change without notice.

To the extent permitted by applicable law, no responsibility or liability is assumed by Schneider Electric and its subsidiaries for any errors or omissions in the informational content of this material or consequences arising out of or resulting from the use of the information contained herein.

As part of a group of responsible, inclusive companies, we are updating our communications that contain non-inclusive terminology. Until we complete this process, however, our content may still contain standardized industry terms that may be deemed inappropriate by our customers.

# Table of Contents

Safety Information .....	9
Qualification of Personnel .....	10
Intended Use .....	10
Product Related Information .....	10
About the Book .....	15
Document Scope .....	15
Validity Note .....	15
Related Documents .....	15
Electronic product data sheet .....	17
Terminology .....	18
Contact us .....	18
Introduction .....	19
Setup .....	20
Initial Steps .....	21
Steps for Setting-Up the Drive .....	23
Software Enhancements .....	24
Overview .....	27
Display Terminals .....	28
Product LEDs .....	34
Multipoint Screen .....	37
Structure of the Parameter Table .....	39
Finding a Parameter in This Document .....	40
Cyber Security .....	41
Overview .....	41
Password .....	47
Upgrades Management .....	48
Programming .....	49
<b>[Simply Start]</b> <b>SYS</b> - .....	50
<b>[Simply start]</b> <b>SIM</b> - Menu .....	51
<b>[My menu]</b> <b>MYMN</b> - Menu .....	53
<b>[Modified parameters]</b> <b>LMD</b> - Menu .....	53
<b>[Dashboard]</b> <b>DSH</b> - .....	54
<b>[System]</b> <b>DST</b> - Menu .....	55
<b>[Dashboard]</b> <b>DSH</b> - Menu .....	57
<b>[kWh Counters]</b> <b>KWC</b> - menu .....	58
<b>[Dashboard]</b> <b>DSH</b> - Menu .....	60
<b>[Diagnostics]</b> <b>DIA</b> - .....	61
<b>[Diag. data]</b> <b>DDT</b> - .....	62
<b>[Error history]</b> <b>PFH</b> - Menu .....	65
<b>[Error history]</b> <b>PFH</b> - Menu .....	65
<b>[Warnings]</b> <b>ALR</b> - Menu .....	67
<b>[Display]</b> <b>MON</b> - .....	69
<b>[Energy parameters]</b> .....	70
<b>[Elec Ener Input Counter]</b> <b>ELI</b> - Menu .....	70
<b>[Elec Ener Output Counter]</b> <b>ELO</b> - Menu .....	71
<b>[Mechanical Energy]</b> <b>MEC</b> - Menu .....	74
<b>[Energy Saving]</b> <b>ESA</b> - Menu .....	76
<b>[Application Parameters]</b> .....	78

<b>[M/S Parameters]</b> .....	79
<b>[M/S Local Display]</b> <b>MSO</b> – Menu .....	79
<b>[M/S System Display]</b> <b>MSR</b> – Menu .....	80
<b>[Motor parameters]</b> .....	83
<b>[Drive parameters]</b> .....	85
<b>[Thermal monitoring]</b> .....	89
<b>[PID display]</b> .....	90
<b>[Counter Management]</b> .....	91
<b>[Other State]</b> .....	93
<b>[Other State]</b> <b>SST</b> – Menu .....	93
<b>[I/O Map]</b> .....	94
<b>[Communication map]</b> .....	98
<b>[Communication map]</b> <b>CMM</b> – Menu .....	98
<b>[Data logging]</b> .....	103
<b>[Complete settings]</b> <b>CST</b> – .....	106
<b>[Motor parameters]</b> <b>MPA</b> – Menu .....	107
<b>[Motor parameters]</b> <b>MPA</b> – Menu .....	107
<b>[data]</b> <b>MTD</b> – Menu .....	112
<b>[Angle test setting]</b> <b>ASA</b> – Menu .....	125
<b>[Motor tune]</b> <b>MTU</b> – Menu .....	128
<b>[Motor tune]</b> <b>MTU</b> – – <b>[Rotation Tune]</b> <b>TRAM</b> – Menu .....	137
<b>[Motor monitoring]</b> <b>MOP</b> – Menu .....	146
<b>[Thermal monitoring]</b> <b>TPP</b> – Menu .....	147
<b>[Motor monitoring]</b> <b>MOP</b> – Menu .....	157
<b>[Motor control]</b> <b>DRC</b> – Menu .....	160
<b>[Fluxing by DI]</b> <b>FLI</b> – Menu .....	164
<b>[Spd Loop Optimization]</b> <b>MCL</b> – Menu .....	167
<b>[Motor control]</b> <b>DRC</b> – Menu .....	178
<b>[Switching frequency]</b> <b>SWF</b> – Menu .....	181
<b>[Input Filter]</b> <b>DCR</b> – Menu .....	184
<b>[Define system units]</b> .....	185
<b>[Command and Reference]</b> <b>CRP</b> – Menu .....	187
<b>[Master/Slave]</b> .....	204
<b>[Hoisting Functions]</b> .....	232
<b>[Brake logic control]</b> <b>BLC</b> – Menu .....	232
<b>[High speed hoisting]</b> <b>HSH</b> – Menu .....	253
<b>[Load Sharing]</b> <b>LDS</b> – Menu .....	260
<b>[Rope Slack Handling]</b> <b>SDR</b> – Menu .....	263
<b>[Hoisting monitoring]</b> .....	264
<b>[Dynamic load detect.]</b> <b>DLD</b> – Menu .....	264
<b>[Machine Functions]</b> .....	266
<b>[Load Sharing]</b> <b>LDS</b> – Menu .....	266
<b>[Backlash compensation]</b> <b>BSQM</b> – Menu .....	267
<b>[Positioning by sensors]</b> <b>LPO</b> – Menu .....	278
<b>[Brake logic control]</b> <b>BLC</b> – Menu .....	278
<b>[Torque control]</b> <b>TOR</b> – Menu .....	278
<b>[Generic functions] - [Speed Limits]</b> .....	279
<b>[Generic functions] - [Ramp]</b> .....	282
<b>[Generic functions] - [Ramp switching]</b> .....	286
<b>[Generic functions] - [Stop configuration]</b> .....	288
<b>[Generic functions] - [Auto DC injection]</b> .....	295

[Generic functions] - [Ref. operations] .....	299
[Generic functions] - [Preset speeds].....	301
[Generic functions] - [+/- speed].....	304
[Generic functions] - [+/- speed around ref] .....	307
[Generic functions] - [Jump frequency] .....	310
[Generic functions] - [PID controller] .....	312
[Generic functions] - [Threshold reached] .....	333
[Generic functions] - [Mains contactor command] .....	336
[Generic functions] - [Output contactor cmd] .....	339
[Generic functions] - [Reverse disable].....	343
[Generic functions] - [Torque limitation] .....	344
[Generic functions] - [2nd current limit.] .....	349
[Generic functions] - [Jog] .....	351
[Generic functions] - [High Speed Switching] .....	353
[Generic functions] - [Memo reference frequency].....	355
[Generic functions] - [Brake logic control] .....	356
[Generic functions] - [Limit switches] .....	357
[Generic functions] - [Positioning by sensors].....	359
[Generic functions] - [Torque control].....	368
[Generic functions] - [Parameters switching].....	376
[Generic functions] - [Stop after speed timeout] .....	381
[Generic functions] - [DC bus supply].....	383
[Generic functions] - [Multimotors config] .....	385
[Generic functions] - [24V Supply Output] .....	389
[Generic functions] - [External weight meas.].....	390
[Generic functions] - [Power Backup].....	393
[Generic monitoring].....	396
[Process underload] ULD- Menu .....	396
[Process overload] OLD- Menu .....	399
[Stall monitoring] STPR- Menu.....	401
[Thermal monitoring] TPP- Menu.....	403
[Frequency meter] FQF- Menu .....	404
[Input/Output] - [I/O assignment].....	407
[DI1 Assignment] L1A- to [DI8 Assignment] L8A- Menus .....	407
[DI11 Assignment] L11A- to [DI16 Assignment] L16A- Menus .....	408
[DI7 Pulse Input Assign] PI7A- Menu .....	409
[DI8 Pulse Input Assign] PI8A- Menu .....	410
[Encoder Pulse Assign] PTGA- Menu .....	410
[RP assignment] PIA- Menu.....	411
[AI1 assignment] AI1A- to [AI5 assignment] AI5A- Menus .....	411
[AIV1 assignment] AV1A- Menu .....	412
[Input/Output] - [DI/DQ] .....	413
[DI1 Configuration] DI1- to [DI8 Configuration] DI8- Menus .....	413
[DI11 Configuration] DI11- to [DI16 Configuration] DI16- Menus .....	414
[DI7 Pulse Config] PAI7- Menu.....	415
[DI8 Pulse Config] PAI8- Menu.....	417

[Pulse Input] <b>PTI</b> – Menu .....	418
[Encoder Config] <b>PG</b> – Menu .....	421
[PTO configuration] <b>PTO</b> – Menu .....	423
[PTO configuration] <b>PTOO</b> – Menu .....	425
[DQxx Configuration] <b>Doxx</b> – Menu .....	428
[Input/Output] - [AI/AQ] .....	432
[AI1 configuration] <b>AI1</b> – Menu.....	432
[AI2 configuration] <b>AI2</b> – Menu.....	435
[AI3 configuration] <b>AI3</b> – Menu.....	436
[AI4 configuration] <b>AI4</b> – Menu.....	438
[AI5 configuration] <b>AI5</b> – Menu.....	440
[AQ1 configuration] <b>AO1</b> – Menu .....	442
[AQ2 configuration] <b>AO2</b> – Menu .....	447
[Virtual AI1] <b>AV1</b> – Menu .....	448
[Input/Output] - [Relay] .....	450
[Relay] <b>RELA</b> – Menu .....	450
[Input/Output] <b>IO</b> – Menu .....	457
[Encoder configuration] .....	459
[Embedded Encoder] .....	467
[Error/Warning handling] .....	471
[Auto Fault Reset] <b>ATR</b> – Menu.....	471
[Fault reset] <b>RST</b> – Menu .....	473
[Catch on the fly] <b>FLR</b> – Menu .....	476
[Error detect disabling] <b>INH</b> – Menu.....	478
[External error] <b>ETF</b> – Menu .....	480
[External error] – [Monitoring circuit A] <b>CMCA</b> – to [Monitoring circuit D] <b>CMCD</b> – Menus .....	482
[Output phase loss] <b>OPL</b> – Menu .....	485
[Input phase loss] <b>IPL</b> – Menu.....	486
[4-20 mA loss] <b>LFL</b> – Menu .....	487
[Fallback speed] <b>LFF</b> – Menu .....	489
[Spd Maint Behavior] <b>RLS</b> – Menu .....	490
[Fieldbus monitoring] <b>CLL</b> – Menu .....	491
[Embedded modbus TCP] <b>EMTC</b> – Menu .....	493
[Communication Module] <b>COMO</b> – Menu .....	495
[Undervoltage handling] <b>USB</b> – Menu.....	498
[Ground Fault] <b>GRFL</b> – Menu .....	501
[Motor thermal monit] <b>THT</b> – Menu.....	502
[Encoder monitoring] <b>SDD</b> – Menu .....	504
[Braking Resistor monit] <b>BRP</b> – Menu .....	505
[Torque or I limit detect] <b>TID</b> – Menu.....	507
[Drive overload monit] <b>OBR</b> – Menu .....	508
[Warn grp 1 definition] <b>A1C</b> – to [Warn grp 5 definition] <b>A5C</b> – Menus .....	511
[ON lock settings] <b>LKON</b> – Menu.....	512
[Maintenance] .....	515
[Diagnostics] <b>DAU</b> – Menu .....	515
[Customer event 1] <b>CE1</b> – Menu .....	516
[Customer event 2] <b>CE2</b> – to [Customer event 5] <b>CE5</b> – Menus .....	517
[Customer events] <b>CUEV</b> – Menu .....	518

---

<b>[Fan management]</b> <b>FAMA</b> – Menu .....	519
<b>[Maintenance]</b> <b>CSMA</b> – Menu.....	520
<b>[Communication]</b> .....	521
<b>[Communication]</b> <b>COM</b> – .....	521
<b>[File management]</b> <b>FMT</b> – .....	523
<b>[Transfer config file]</b> <b>TCF</b> – Menu .....	524
<b>[Factory settings]</b> <b>FCS</b> Menu.....	525
<b>[Firmware update]</b> <b>FWUP</b> – Menu .....	527
<b>[My preferences]</b> <b>MYP</b> – .....	528
<b>[LANGUAGE]</b> .....	528
<b>[Password]</b> .....	529
<b>[Parameter access]</b> .....	531
<b>[Customization]</b> .....	533
<b>[My menu config.]</b> <b>MYC</b> – Menu.....	533
<b>[Display screen type]</b> <b>MSC</b> – Menu.....	534
<b>[Bar Selection]</b> <b>PBS</b> – Menu.....	534
<b>[Custom parameters]</b> <b>CYP</b> – Menu.....	535
<b>[Service Message]</b> <b>SER</b> – Menu .....	535
<b>[Date/Time Settings]</b> .....	536
<b>[Date/Time Settings]</b> <b>RTC</b> – Menu .....	536
<b>[Access Level]</b> <b>LAC</b> – Menu .....	537
<b>[Webserver]</b> .....	538
<b>[Functions key mgnt]</b> .....	539
<b>[LCD settings]</b> .....	540
<b>[QR code]</b> .....	541
<b>[Pairing password]</b> .....	542
Maintenance .....	543
Diagnostics and Troubleshooting .....	545
Warning Codes.....	546
Error Codes .....	548
FAQ .....	615
Glossary .....	617





# Safety Information

## Important Information

Read these instructions carefully, and look at the equipment to become familiar with the device before trying to install, operate, service, or maintain it. The following special messages may appear throughout this documentation or on the equipment to warn of potential hazards or to call attention to information that clarifies or simplifies a procedure.



The addition of this symbol to a “Danger” or “Warning” safety label indicates that an electrical hazard exists which will result in personal injury if the instructions are not followed.



This is the safety alert symbol. It is used to alert you to potential personal injury hazards. Obey all safety messages that follow this symbol to avoid possible injury or death.

<b>⚠ DANGER</b>
<b>DANGER</b> indicates a hazardous situation which, if not avoided, <b>will result in</b> death or serious injury.
<b>⚠ WARNING</b>
<b>WARNING</b> indicates a hazardous situation which, if not avoided, <b>could result in</b> death or serious injury.
<b>⚠ CAUTION</b>
<b>CAUTION</b> indicates a hazardous situation which, if not avoided, <b>could result in</b> minor or moderate injury.
<b>NOTICE</b>
<b>NOTICE</b> is used to address practices not related to physical injury.

## Please Note

Electrical equipment should be installed, operated, serviced, and maintained only by qualified personnel. No responsibility is assumed by Schneider Electric for any consequences arising out of the use of this material.

A qualified person is one who has skills and knowledge related to the construction and operation of electrical equipment and its installation, and has received safety training to recognize and avoid the hazards involved.

## Qualification of Personnel

Only appropriately trained persons who are familiar with and understand the contents of this manual and all other pertinent product documentation are authorized to work on and with this product. In addition, these persons must have received safety training to recognize and avoid hazards involved. These persons must have sufficient technical training, knowledge and experience and be able to foresee and detect potential hazards that may be caused by using the product, by changing the settings and by the mechanical, electrical and electronic equipment of the entire system in which the product is used. All persons working on and with the product must be fully familiar with all applicable standards, directives, and accident prevention regulations when performing such work.

## Intended Use

This product is intended for industrial use according to this manual.

The product may only be used in compliance with all applicable safety standard and local regulations and directives, the specified requirements and the technical data. The product must be installed outside the hazardous ATEX zone. Prior to using the product, you must perform a risk assessment in view of the planned application. Based on the results, the appropriate safety measures must be implemented. Since the product is used as a component in an entire system, you must ensure the safety of persons by means of the design of this entire system (for example, machine design). Any use other than the use explicitly permitted is prohibited and can result in hazards.

## Product Related Information

**Read and understand these instructions before performing any procedure with this drive.**

### **DANGER**

#### **HAZARD OF ELECTRIC SHOCK, EXPLOSION OR ARC FLASH**

- Only appropriately trained persons who are familiar with and fully understand the contents of the present manual and all other pertinent product documentation and who have received all necessary training to recognize and avoid hazards involved are authorized to work on and with this drive system.
- Installation, adjustment, repair and maintenance must be performed by qualified personnel.
- Verify compliance with all local and national electrical code requirements as well as all other applicable regulations with respect to grounding of all equipment.
- Only use properly rated, electrically insulated tools and measuring equipment.
- Do not touch unshielded components or terminals with voltage present.
- Prior to performing any type of work on the drive system, block the motor shaft to prevent rotation.
- Insulate both ends of unused conductors of the motor cable.
- Do not short across the DC bus terminals or the DC bus capacitors or the braking resistor terminals.

**Failure to follow these instructions will result in death or serious injury.**

**⚡⚠ DANGER****HAZARD OF ELECTRIC SHOCK, EXPLOSION, OR ARC FLASH**

Before performing work on the drive system:

- Disconnect all power, including external control power that may be present. Take into account that the circuit breaker or main switch does not de-energize all circuits.
- Place a "Do Not Turn On" label on all power switches related to the drive system.
- Lock all power switches in the open position.
- Wait 15 minutes to allow the DC bus capacitors to discharge.
- Verify the absence of voltage. (1)

Before applying voltage to the drive system:

- Verify that the work has been completed and that the entire installation cannot cause hazards.
- If the mains input terminals and the motor output terminals have been grounded and short-circuited, remove the ground and the short circuits on the mains input terminals and the motor output terminals.
- Verify proper grounding of all equipment.
- Verify that all protective equipment such as covers, doors, grids is installed and/or closed.

**Failure to follow these instructions will result in death or serious injury.**

(1) Refer to Verifying the Absence of Voltage in the Installation manual of the product.

Damaged products or accessories may cause electric shock or unanticipated equipment operation.

**⚡⚠ DANGER****ELECTRIC SHOCK OR UNANTICIPATED EQUIPMENT OPERATION**

Do not use damaged products or accessories.

**Failure to follow these instructions will result in death or serious injury.**

Contact your local Schneider Electric sales office if you detect any damage whatsoever.

This equipment has been designed to operate outside of any hazardous location. Only install this equipment in zones known to be free of a hazardous atmosphere.

**⚠ DANGER****POTENTIAL FOR EXPLOSION**

Install and use this equipment in non-hazardous locations only.

**Failure to follow these instructions will result in death or serious injury.**

Your application consists of a whole range of different interrelated mechanical, electrical, and electronic components, the drive being just one part of the application. The drive by itself is neither intended to nor capable of providing the entire functionality to meet all safety-related requirements that apply to your application. Depending on the application and the corresponding risk assessment to be conducted by you, a whole variety of additional equipment is required such as, but not limited to, external encoders, external brakes, external monitoring devices, guards, etc.

As a designer/manufacturer of machines, you must be familiar with and observe all standards that apply to your machine. You must conduct a risk assessment and determine the appropriate Performance Level (PL) and/or Safety Integrity Level (SIL) and design and build your machine in compliance with all applicable standards. In doing so, you must consider the interrelation of all components of the machine. In addition, you must provide instructions for use that enable the user of your machine to perform any type of work on and with the machine such as operation and maintenance in a safe manner.

The present document assumes that you are fully aware of all normative standards and requirements that apply to your application. Since the drive cannot provide all safety-related functionality for your entire application, you must ensure that the required Performance Level and/or Safety Integrity Level is reached by installing all necessary additional equipment.

## **▲ WARNING**

### **INSUFFICIENT PERFORMANCE LEVEL/SAFETY INTEGRITY LEVEL AND/OR UNINTENDED EQUIPMENT OPERATION**

- Conduct a risk assessment according to EN ISO 12100 and all other standards that apply to your application.
- Use redundant components and/or control paths for all critical control functions identified in your risk assessment.
- Implement all monitoring functions required to avoid any type of hazard identified in your risk assessment, for example, slipping or falling loads, in particular, if you do not operate the drive in closed loop mode which provides certain internal monitoring functions such as BRH3 [BRH b3], BRH4 [BRH b4] and BRH5 [BRH b5].
- Verify that the service life of all individual components used in your application is sufficient for the intended service life of your overall application.
- Perform extensive commissioning tests for all potential error situations to verify the effectiveness of the safety-related functions and monitoring functions implemented, for example, but not limited to, speed monitoring by means of encoders, short circuit monitoring for all connected equipment, correct operation of brakes and guards.
- Perform extensive commissioning tests for all potential error situations to verify that the load can be brought to a safe stop under all conditions.

**Failure to follow these instructions can result in death, serious injury, or equipment damage.**

A specific application note NHA80973 is available on hoisting machines and can be downloaded on [se.com](http://se.com).

Product may perform unexpected movements because of incorrect wiring, incorrect settings, incorrect data or other errors.

## **▲ WARNING**

### **UNANTICIPATED EQUIPMENT OPERATION**

- Carefully install the wiring in accordance with the EMC requirements.
- Do not operate the product with unknown or unsuitable settings or data.
- Perform a comprehensive commissioning test.

**Failure to follow these instructions can result in death, serious injury, or equipment damage.**

**▲ WARNING****LOSS OF CONTROL**

- The designer of any control scheme must consider the potential failure modes of control paths and, for critical control functions, provide a means to achieve a safe state during and after a path failure. Examples of critical control functions are emergency stop, overtravel stop, power outage and restart.
- Separate or redundant control paths must be provided for critical control functions.
- System control paths may include communication links. Consideration must be given to the implications of unanticipated transmission delays or failures of the link.
- Observe all accident prevention regulations and local safety guidelines (1).
- Each implementation of the product must be individually and thoroughly tested for proper operation before being placed into service.

**Failure to follow these instructions can result in death, serious injury, or equipment damage.**

(1) For USA: Additional information, refer to NEMA ICS 1.1 (latest edition), Safety Guidelines for the Application, Installation, and Maintenance of Solid State Control and to NEMA ICS 7.1 (latest edition), Safety Standards for Construction and Guide for Selection, Installation and Operation of Adjustable-Speed Drive Systems.

The temperature of the products described in this manual may exceed 80 °C (176 °F) during operation.

**▲ WARNING****HOT SURFACES**

- Ensure that any contact with hot surfaces is avoided.
- Do not allow flammable or heat-sensitive parts in the immediate vicinity of hot surfaces.
- Verify that the product has sufficiently cooled down before handling it.
- Verify that the heat dissipation is sufficient by performing a test run under maximum load conditions.

**Failure to follow these instructions can result in death, serious injury, or equipment damage.**

Machines, controllers, and related equipment are usually integrated into networks. Unauthorized persons and malware may gain access to the machine as well as to other devices on the network/fieldbus of the machine and connected networks via insufficiently secure access to software and networks.

**▲ WARNING****UNAUTHORIZED ACCESS TO THE MACHINE VIA SOFTWARE AND NETWORKS**

- In your hazard and risk analysis, consider all hazards that result from access to and operation on the network/fieldbus and develop an appropriate cyber security concept.
- Verify that the hardware infrastructure and the software infrastructure into which the machine is integrated as well as all organizational measures and rules covering access to this infrastructure consider the results of the hazard and risk analysis and are implemented according to best practices and standards covering IT security and cyber security (such as: ISO/IEC 27000 series, Common Criteria for Information Technology Security Evaluation, ISO/IEC 15408, IEC 62351, ISA/IEC 62443, NIST Cybersecurity Framework, Information Security Forum - Standard of Good Practice for Information Security, SE recommended Cybersecurity Best Practices\*).
- Verify the effectiveness of your IT security and cyber security systems using appropriate, proven methods.

**Failure to follow these instructions can result in death, serious injury, or equipment damage.**

(\*) : SE Recommended Cybersecurity Best Practices can be downloaded on SE.com.

## **▲ WARNING**

### **LOSS OF CONTROL**

Perform a comprehensive commissioning test to verify that communication monitoring properly detects communication interruptions

**Failure to follow these instructions can result in death, serious injury, or equipment damage.**

## ***NOTICE***

### **DESTRUCTION DUE TO INCORRECT MAINS VOLTAGE**

Before switching on and configuring the product, verify that it is approved for the mains voltage.

**Failure to follow these instructions can result in equipment damage.**

# About the Book

## Document Scope

The purpose of this document is to:

- help you to set up the drive,
- show you how to program the drive,
- show you the different menus, modes, and parameters,
- help you in maintenance and diagnostics.

## Validity Note

Original instructions and information given in the present document have been written in English (before optional translation).

This documentation is valid for the Altivar MachineATV340 drives.

The technical characteristics of the devices described in the present document also appear online. To access the information online, go to the Schneider Electric home page [www.se.com/ww/en/download/](http://www.se.com/ww/en/download/).

The characteristics that are described in the present document should be the same as those characteristics that appear online. In line with our policy of constant improvement, we may revise content over time to improve clarity and accuracy. If you see a difference between the document and online information, use the online information as your reference.

Step	Action
1	Go to the Schneider Electric home page <a href="http://www.se.com">www.se.com</a> .
2	In the <b>Search</b> box type the reference of the product or the name of a product range. <ul style="list-style-type: none"> <li>• Do not include blank spaces in the reference or product range.</li> <li>• To get information on grouping similar modules, use asterisks (*).</li> </ul>
3	If you entered a reference, go to the <b>Product Datasheets</b> search results and click on the reference that interests you.  If you entered the name of a product range, go to the <b>Product Ranges</b> search results and click on the product range that interests you.
4	If more than one reference appears in the <b>Products</b> search results, click on the reference that interests you.
5	Depending on the size of your screen, you may need to scroll down to see the data sheet.
6	To save or print a data sheet as a .pdf file, click <b>Download XXX product datasheet</b> .

## Related Documents

Use your tablet or your PC to quickly access detailed and comprehensive information on all our products on [www.se.com](http://www.se.com).

The internet site provides the information you need for products and solutions:

- The whole catalog for detailed characteristics and selection guides,
- The CAD files to help design your installation, available in over 20 different file formats,
- All software and firmware to maintain your installation up to date,
- A large quantity of White Papers, Environment documents, Application solutions, Specifications... to gain a better understanding of our electrical systems and equipment or automation,
- And finally all the User Guides related to your drive, listed below:

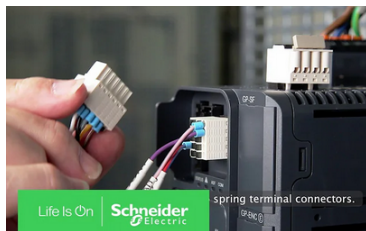
Title of Documentation	Catalog Number
ATV340 Catalog	DIA2ED2160701EN (English) DIA2ED2160701FR (French)
ATV340 Getting Started - Video	FA367923 FAQ (English) 
ATV340 Getting Started	NVE37643 (English) NVE37642 (French) NVE37644 (German) NVE37646 (Spanish) NVE37647 (Italian) NVE37648 (Chinese) NVE37643PT (Portuguese)
ATV340 Getting Started Annex (SCCR)	NVE37641 (English)
Wiring Diagrams for Frame Sizes S1, S2, S3	NVE97896 (English)
ATV340 Installation Manual	NVE61069 (English) NVE61071 (French) NVE61074 (German) NVE61075 (Spanish) NVE61078 (Italian) NVE61079 (Chinese) NVE61069PT (Portuguese) NVE61069TR (Turkish)
ATV340 Programming Manual	NVE61643 (English) NVE61644 (French) NVE61645 (German) NVE61647 (Spanish) NVE61648 (Italian) NVE61649 (Chinese) NVE61643PT (Portuguese) NVE61643TR (Turkish)
ATV340 Modbus manual (Embedded)	NVE61654 (English)
ATV340 Ethernet manual (Embedded)	NVE61653 (English)
ATV340 PROFIBUS DP manual (VW3A3607)	NVE61656 (English)
ATV340 DeviceNet manual (VW3A3609)	NVE61683 (English)
Altivar dPAC Module user guide (VW3A3530D)	NNZ13577 (English)
ATV340 PROFINET manual (VW3A3627)	NVE61678 (English)
ATV340 CANopen manual (VW3A3608, 618, 628)	NVE61655 (English)
ATV340 POWERLINK manual - (VW3A3619)	NVE61681 (English)
ATV340 EtherCAT manual - (VW3A3601)	NVE61686 (English)
ATV340 Sercos III manual (embedded)	PHA33735 (English) PHA33737 (French) PHA33738 (German) PHA33739 (Spanish) PHA33740 (Italian) PHA33741 (Chinese)



Title of Documentation	Catalog Number
ATV340 Communication Parameters	NVE61728 (English)
ATV340 Embedded Safety Function Manual	NVE64143 (English)
ATV340 DC Bus Sharing Technical Note PHA25027	PHA25027 (English)
ATV340 Safety functions Manual with Module VW3A3802	NVE61741 (English) NVE61742 (French) NVE61745 (German) NVE61747 (Spanish) NVE61749 (Italian) NVE61752 (Chinese) NVE61741PT (Portuguese) NVE61741TR (Turkish)
ATV340 CIP Safety functions manual with Module VW3A3809	JYT89148 (English)
SoMove FDT	SoMove_FDT (English, French, German, Spanish, Italian, Chinese)
Altivar 340: DTM	ATV340_DTM_Library_EN (English) ATV340_DTM_Lang_FR (French) ATV340_DTM_Lang_DE (German) ATV340_DTM_Lang_SP (Spanish) ATV340_DTM_Lang_IT (Italian) ATV340_DTM_Lang_CN (Chinese)
Altivar Application Note for Hoisting	NHA80973 (English)
Recommended Cybersecurity Best Practices	CS-Best-Practices-2019-340 (English)

(Other option manuals and Instruction sheets are available on [www.se.com](http://www.se.com))

You can download these technical publications and other technical information from our website at [www.se.com/en/download](http://www.se.com/en/download)

## Electronic product data sheet

Scan the QR code in front of the drive to get the product data sheet.

## Terminology

The technical terms, terminology, and the corresponding descriptions in this manual normally use the terms or definitions in the relevant standards.

In the area of drive systems this includes, but is not limited to, terms such as **error**, **error message**, **failure**, **fault**, **fault reset**, **protection**, **safe state**, **safety function**, **warning**, **warning message**, and so on.

Among others, these standards include:

- IEC 61800 series: Adjustable speed electrical power drive systems
- IEC 61508 Ed.2 series: Functional safety of electrical/electronic/programmable electronic safety-related
- EN 954-1 Safety of machinery - safety-related parts of control systems
- ISO 13849-1 & 2 Safety of machinery - safety related parts of control systems
- IEC 61158 series: Industrial communication networks - Fieldbus specifications
- IEC 61784 series: Industrial communication networks - Profiles
- IEC 60204-1: Safety of machinery - Electrical equipment of machines – Part 1: General requirements
- IEC 62443: Security for industrial automation and control systems

In addition, the term **zone of operation** is used in conjunction with the description of specific hazards, and is defined as it is for a **hazard zone** or **danger zone** in the EC Machinery Directive (2006/42/EC) and in ISO 12100-1.

Also see the glossary at the end of this manual.

## Contact us

Select your country on [www.se.com/contact](http://www.se.com/contact).

Schneider Electric Industries SAS

Head Office

35, rue Joseph Monier

92500 Rueil-Malmaison

France

# Introduction

## What's in This Part

Setup .....	20
Overview .....	27
Cyber Security .....	41

# Setup

## What's in This Chapter

Initial Steps .....	21
Steps for Setting-Up the Drive .....	23
Software Enhancements .....	24

## Initial Steps

### Before Powering up the Drive

#### **▲ WARNING**

##### **UNANTICIPATED EQUIPMENT OPERATION**

Before switching on the device, verify that no unintended signals can be applied to the digital inputs that could cause unintended movements.

**Failure to follow these instructions can result in death, serious injury, or equipment damage.**

If the drive was not connected to mains for an extended period of time, the capacitors must be restored to their full performance before the motor is started.

#### **NOTICE**

##### **REDUCED CAPACITOR PERFORMANCE**

- Apply mains voltage to the drive for one hour before starting the motor if the drive has not been connected to mains for the specified periods of time.(1)
- Verify that no Run command can be applied before the period of one hour has elapsed.
- Verify the date of manufacture if the drive is commissioned for the first time and run the specified procedure if the date of manufacture is more than 12 months in the past.

**Failure to follow these instructions can result in equipment damage.**

(1) Period of time:

- 12 months at a maximum storage temperature of +50°C (+122°F)
- 24 months at a maximum storage temperature of +45°C (+113°F)
- 36 months at a maximum storage temperature of +40°C (+104°F)

If the specified procedure cannot be performed without a Run command because of internal mains contactor control, perform this procedure with the power stage enabled, but the motor being at a standstill so that there is no appreciable mains current in the capacitors.

### Mains Contactor

#### **NOTICE**

##### **RISK OF DAMAGE TO THE DRIVE**

Do not switch on the drive at intervals of less than 60 s.

**Failure to follow these instructions can result in equipment damage.**

### Using a Motor with a Lower Rating or Dispensing with a Motor Altogether

In factory settings, the motor output phase loss detection is active:

**[OutPhaseLoss Assign] OPL** is set to **[OPF Error Triggered] YES**. For details, refer to the parameter description, page 485. For commissioning tests or maintenance phase, the drive could be connected to a small motor power size and thus trigger an error **[Output Phase Loss] OPF2** or **[Single output phase loss]**

OPF1 when a Run command is applied. For that purpose, the function can be disabled by setting [OutPhaseLoss Assign] OPL to [Function Inactive] NO.

Set also [Motor control type] CTT to [SVC V] VVC in [Motor parameters] MPA-. For details, refer to .

## NOTICE

### MOTOR OVERHEATING

Install external thermal monitoring equipment under the following conditions:

- If a motor with a nominal current of less than 20% of the nominal current of the drive is connected.
- If you use the function Motor Switching.

**Failure to follow these instructions can result in equipment damage.**

## DANGER

### HAZARD OF ELECTRIC SHOCK, EXPLOSION OR ARC FLASH

If output phase monitoring is disabled, phase loss and, by implication, accidental disconnection of cables, are not detected.

- Verify that the setting of this parameter does not result in unsafe conditions.

**Failure to follow these instructions will result in death or serious injury.**

## Steps for Setting-Up the Drive



①

Refer to the installation manual, page 15.

②

Switch ON the drive without active run command.

③

Configure:

- The nominal frequency of the motor **[Motor Standard] BFR** if this is not 50 Hz.
- The motor parameters including **[Motor Th Current] ITH** in the **[Motor parameters] MPA-** menu, only if the factory configuration of the drive is not suitable.
- The application functions in the **[Complete settings] CST-** menu, only if the factory configuration of the drive is not suitable.

④

In the **[Simply Start] SYS-** menu, adjust the following parameters:

- **[Acceleration] ACC** and **[Deceleration] DEC**.
- **[Low Speed] LSP** and **[High Speed] HSP**.

⑤

Start the drive.

Product may perform unexpected movements because of incorrect wiring, incorrect settings, incorrect data or other errors.

### ⚠ WARNING

#### UNANTICIPATED EQUIPMENT OPERATION

- Carefully install the wiring in accordance with the EMC requirements.
- Do not operate the product with unknown or unsuitable settings or data.
- Perform a comprehensive commissioning test.

**Failure to follow these instructions can result in death, serious injury, or equipment damage.**

## Tips

Use the **[Config. Source] FCSI** parameter to restore the factory settings at any time.

**NOTE:** The following operations must be performed for optimum drive performance in terms of accuracy and response time:

- Enter the values indicated on the motor nameplate in the **[Motor parameters] MPA-** menu.
- Perform autotuning with the motor cold and connected using the **[Autotuning] TUN** parameter.

# Software Enhancements

## Overview

Since the ATV340 was first launched, it has benefited from the addition of several new functions. The software version has been updated to V3.6.

Although this documentation relates to version V3.6, it can still be used with earlier versions.

**NOTE:** The only software version available for ATV340\*\*\*\*S is the version V1.4.

## Enhancements Made to Version V3.6 in Comparison to V3.5

New possible setting **[STO fct status]** **STOS** is now available on drive outputs (digital outputs and relays). It allows to show the status of the Safe Torque Off STO function.

In the menu **[Motor monitoring]** **MOP**, new parameter **[Torque Filter Time]** **TPFV** has been added to define a filter time constant applicable on the non-filtered output torque and power.

It is now possible to set the parameter **[Braking Resistor]** **BRC** to **[No]** **NO** even when **[Dec.Ramp Adapt]** **BRA** is also set to **[No]** **NO**, which results in the deceleration ramp adaptation and braking resistor both deactivated at the same time.

## Enhancements Made to Version V3.5 in Comparison to V3.3

New warning **[Pwr Backup Warn]** **RFTA** has been added to indicate when the function **[Power Backup]** **RFT-** is activated.

RSTP settings are now accessible via the Graphic Display terminal, a new **[RSTP configuration]** **RSTP-** menu is available, including its related parameters.

More information on the error codes is now displayed on the Plain Text Display Terminal.

**[Relative d-axis error]** **RDAE** is accessible for asynchronous motors to perform adjustments on **[Magnetizing Current]** **IDA** for asynchronous motors.

New possible setting is available for **[Ground Fault Activation]** **GRFL**.

Parameters **[Nom Motor Tq Scaling]** **TQNC**, **[Plate Nom Motor Tq]** **TQNP** and **[Expert Motor Tq]** **TQNO** have been added to define the reference of the nominal motor torque.

In **[Error/Warning handling]** **CSWM-** menu, **[Spd Maint Behavior]** **RLS-** menu is available to determine the drive behavior after an AI loss event.

## Enhancements Made to Version V3.3 in Comparison to V3.1

Improvements related to cybersecurity. By default, user authentication is necessary to connect to the drive via PC software tools such as SoMove-DTM (using Modbus TCP communication through Ethernet). **[User authentication]** **SECE-** menu has been added in **[Embd Eth Config]** **ETE-** menu and **[User authentication]** **SECP-** has been added in **[Profinet]** **PNC-**. For more information refer to DTM online help.

**NOTE:** To fully support this evolution with Profinet module, the minimum firmware version of Profinet module must be V1.9IE19.



In the menu **[Fault reset]** *RST*- menu, **[Extended Fault Reset]** *HRFC* parameter is now available.

**[Autotuning Usage]** *TUNU* factory setting is now **[Therm mot]** *TM*. Additionally, setting **[Brake assignment]** *BLC* to an output preset **[Autotuning Usage]** *TUNU* to **[Therm mot]** *TM*.

**[Fallback Channel]** *AFFL* has been added to handle automatic channel fallback in case of fieldbus communication interruption.

New possible settings are available on drive outputs (digital outputs and relays).

In the **[Generic functions]** *CSGF*- menu, the **[Power Backup]** *RFT*- menu is available, including its related parameters.

In the **[Error/Warning handling]** *CSWM*- menu, the **[ON lock settings]** *LKON*- menu is available, including its related parameters.

In the **[External error]** *ETF*- menu, **[Monitoring circuit A]** *CMCA*-...**[Monitoring circuit D]** *CMCD*- menus are available, including their parameters.

## Enhancements Made to Version V3.1 in Comparison to V2.1

Fallback feature is added on drive outputs. When the corresponding output is controlled by fieldbus, the output is reset if an error is triggered.

Advanced motor control is available via **[Adv. Motor Control]** *AEMC* parameter in the menu **[Motor parameters]** *MPA*- , page 110. By default, this new feature is enabled. To complete the advanced motor control, a new tuning is added: the **[Rotation Tune]** *TRAM*- , page 137.

In **[Ramp]** *RAMP*- menu, **[Braking Current Level]** *BDCL* is added to modify the maximum current level for braking deceleration.

## Enhancements Made to Version V2.1 in Comparison to V1.7

In the tab **[data]** *MTD*- of the **[Motor data]** *MOA*- menu, **[Torque Scaling]** *INRT* parameter is added. It allows to show and modify the scaling of parameters such as **[Nom Motor torque]** *TQS*.

In the **[Positioning by sensors]** *LPO*- menu, **[Memo Slowdown]** *MSLO* parameter is added. It allows to enable or disable the memorization of the slowdown.

## Enhancements Made to Version V1.7 in Comparison to V1.6

In the **[Motor parameters]** *MPA*- menu, the **[Input Filter]** *DCR*- menu is available, including its related parameters.

Improvements on **[Brake logic control]** *BLC*- function, refer to the new parameters **[BRH b5]** *BRH5*, **[Load Maintain Time]** *MDFT* and **[Load Maintain Delay]** *MTBF*.

## Enhancements Made to Version V1.6 in Comparison to V1.5

Improvements on **[Brake logic control]** *BLC*- function. Parameters linked to brake relay feedback have been added and **[BRH b4]** *BRH4* function can be used to trigger an error.

**[Output contactor cmd]** *OCC*- and **[External weight meas.]** *ELM*- functions are now available.

Improvement of the password protection to limit the access to the menus.

## Enhancements Made to Version V1.5 in Comparison to V1.4

Support of VW3A3619 POWERLINK fieldbus module.

In the **[Motor control]** **DRC**– menu, "Output Voltage Management and Over modulation" function is added.

A new possible behavior is added for the STOP/RESET key, see **[Stop Key Enable]** **PST** parameter.

Improvements and new functionalities on **[Brake logic control]** **BLC**– functions can be found in their related menus. New parameters are available and the calculation of the **[Auto]** **AUTO** setting values have been updated.

The virtual analog input type is now settable with **[AIV1 Type]** **AV1T** parameters.

Support of bidirectional scaled analog inputs, see **[Aix range]** **AIxL** parameters.

In the **[Complete settings]** **CST**–menu, the **[Encoder configuration]** **IEN**– has been updated with parameters and affectations added to support the VW3A3424 HTL encoder interface module.

In the **[Catch on the fly]** **FLR**– menu, a new selection has been added to allow the function to be active after stop types different than freewheel.

From this new version, the selection of **[Never]** **STP** on **[Fan mode]** **FFM** has no effect.

**[Input Phase Loss]** **PHF** is cleared as soon as its cause has been removed.

## Enhancements Made to Version V1.4 in Comparison to V1.1

Firmware evolution to support Altivar Machine ATV340 Sercos III offer (ATV340•••••S).

# Overview

## What's in This Chapter

Display Terminals .....	28
Product LEDs.....	34
Multipoint Screen .....	37
Structure of the Parameter Table .....	39
Finding a Parameter in This Document .....	40

# Display Terminals

## Introduction

The drive is compatible with the Plain Text Display Terminal (VW3A1113) or with the Graphic Display Terminal (VW3A1111). These display terminals can be ordered separately.

**NOTE:** In this manual, the term Display Terminal is used when it concerns both display terminals.

## Description of the Plain Text Display Terminal (VW3A1113)

The Plain Text Display Terminal is a local control unit which can be either plugged on the drive or mounted on the door of an enclosure with its dedicated door mounting kit (VW3A1114).



**1 STOP / RESET:** Stop command / apply a Fault Reset.

**2 ESC:** used to quit a menu/parameter or remove the currently displayed value in order to revert to the previous value retained in the memory

**3 Graphic display.**

**4 Home:** access directly the home page.

**5 RUN:** executes the function assuming it has been configured.

**6 Touch wheel / OK:** used to save the current value or access the selected menu/parameter. It also allows to access more details on the displayed error codes. The touch wheel is used to scroll fast into the menus. Up/down arrows are used for precise selections, right/left arrows are used to select digits when setting a numerical value of a parameter.

**NOTE:** Keys 1, 5 and 6 can be used to control the drive if control via the Display Terminal is activated. To activate the keys on the Display Terminal, you first need to set **[Ref Freq 1 Config] FR1** to **[HMI] LCC**.

## Description of the Graphic Display

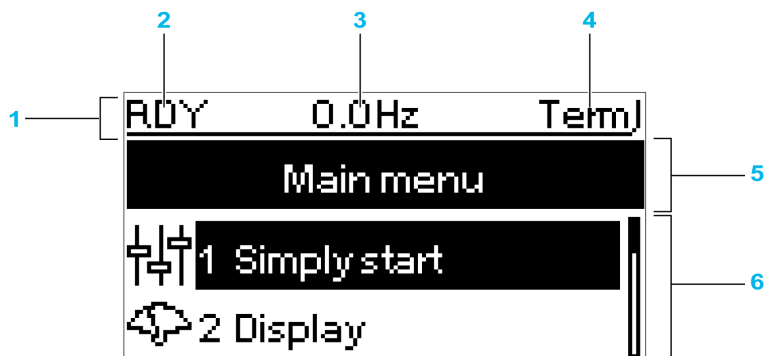

Key	
1	Display line: its content can be configured
2	<b>[Device State]</b> <i>HMI S</i>
3	Customer defined
4	Active control channel <ul style="list-style-type: none"> <li>• TERM: Terminals</li> <li>• HMI: Display Terminal</li> <li>• MDB: Integrated Modbus serial</li> <li>• CAN: CANopen®</li> <li>• NET: Fieldbus module</li> <li>• ETH: Integrated Ethernet (for ATV340•••N4E)</li> <li>• PWS: DTM-based commissioning software</li> </ul>
5	Menu line: indicates the name of the current menu or submenu
6	Menus, submenus, parameters, values, bar charts, and so on, are displayed in drop-down window format on a maximum of 2 lines. The line or value selected by the navigation button is displayed in reverse video

## Description of the Graphic Display Terminal (VW3A1111)

The Graphic Display Terminal is a local control unit which can be mounted on the door of an enclosure with its dedicated door mounting kit (VW3A1112). The Graphic Display Terminal embeds a real-time clock used for the time stamping of logged data and all other functions which require time information.

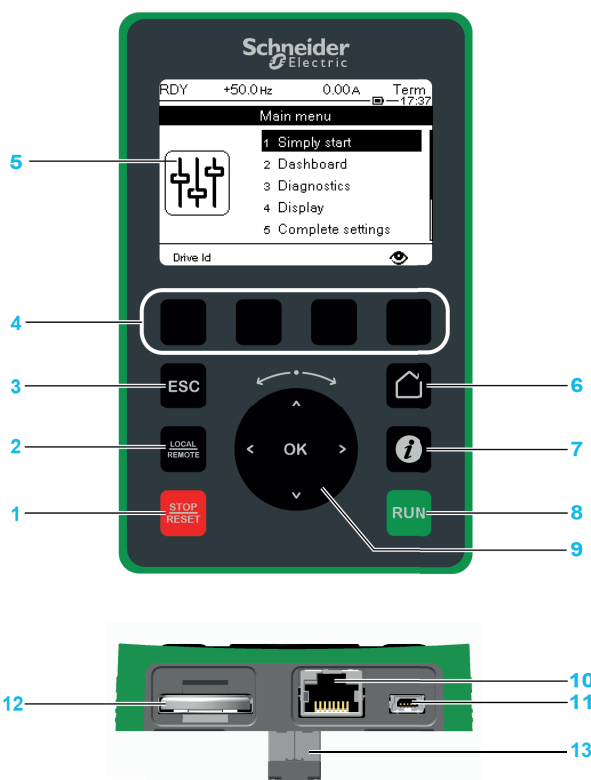

**1 STOP / RESET:** Stop command / apply a Fault Reset.

**2 LOCAL / REMOTE:** used to switch between local and remote control of the drive.

**3 ESC:** used to quit a menu/parameter or remove the currently displayed value in order to revert to the previous value retained in the memory

**4 F1 to F4:** function keys used to access drive id, QR code, quick view, and submenus. Simultaneous press of F1 and F4 keys generates a screenshot file in the Graphic Display Terminal internal memory.

**5 Graphic display.**

**6 Home:** used to access directly at the home page.

**7 Information:** used to have more information about parameters. The selected parameter code is displayed on the first line of the information page.

**8 RUN:** executes the function assuming it has been configured.

**9 Touch wheel / OK:** used to save the current value or access the selected menu/parameter. The touch wheel is used to scroll fast into the menus. Up/down arrows are used for precise selections, right/left arrows are used to select digits when setting a numerical value of a parameter.

**10 RJ45 Modbus serial port:** used to connect the Graphic Display Terminal to the drive in remote control.

**11 Mini-B USB port:** used to connect the Graphic Display Terminal to a computer.

**12 Battery** (10 years service life. Type: CR2032). The battery positive pole points to the front face of the Graphic Display Terminal .

**13 RJ45 male connector:** used to plug the Display Terminal on the Altivar or the door mounting kit. .

**NOTE:** Keys 1, 8 and 9 can be used to control the drive if control via the Display Terminal is activated. To activate the keys on the Display Terminal, you first need to set [Ref Freq 1 Config] FR1 to [HMI] LCC.

## Description of the VW3A1111 Graphic Display

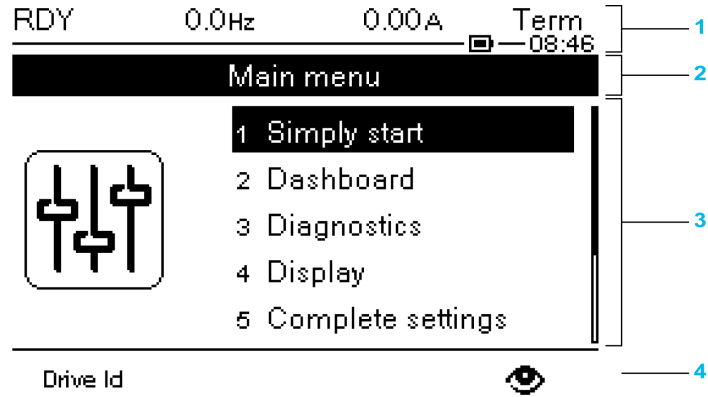

1 Display line: its content can be configured

2 Menu line: indicates the name of the current menu or submenu

3 Menus, submenus, parameters, values, bar charts, and so on, are displayed in drop-down window format on a maximum of five lines. The line or value selected by the navigation button is displayed in reverse video

4 Section displaying tabs (1 to 4 by menu), these tabs can be accessed using F1 to F4 keys

**NOTE:** The numbers in front of the menus and submenus in the Graphic Display Terminal are different from chapters numbers in this programming manual.

Display line details:

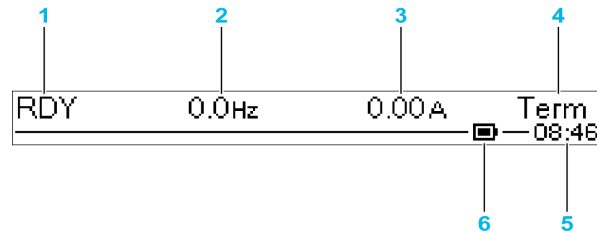

Key	
1	[Device State] HMIS
2	Customer defined parameter value
3	Customer defined parameter value
4	Active control channel <ul style="list-style-type: none"> <li>• TERM: terminals</li> <li>• HMI: Display Terminal</li> <li>• MDB: integrated Modbus serial</li> <li>• CAN: CANopen®</li> <li>• NET: fieldbus module</li> <li>• ETH: integrated Ethernet (for ATV340...N4E)</li> <li>• PWS: DTM-based commissioning software</li> </ul>
5	Present time
6	Battery level

## Graphic Display Terminal Connected to a Computer

### **NOTICE**

#### **INOPERATIVE EQUIPMENT**

Do not connect equipment to the RJ45 port and to the USB port of the Graphic Display Terminal at the same time.

**Failure to follow these instructions can result in equipment damage.**

The Graphic Display Terminal is recognized as a USB storage device named SE\_VW3A1111 while plugged on a computer.

This allows to access the saved drive configurations (*DRVCONF* menu) and the Graphic Display Terminal screenshots (*PRTSCR* menu).

Screenshots can be stored by a simultaneous press on *F1* and *F4* function keys

## How To Update Language Files on the Graphic Display Terminal?



The Graphic Display Terminal (VW3A1111) language files can be updated.

Download the latest version of language files here: [Languages\\_Drives\\_VW3A1111](#)

Unzip the file and follow the instructions of the ReadMe text file.



## How to customize the logo displayed at power on of the Graphic Display Terminal?

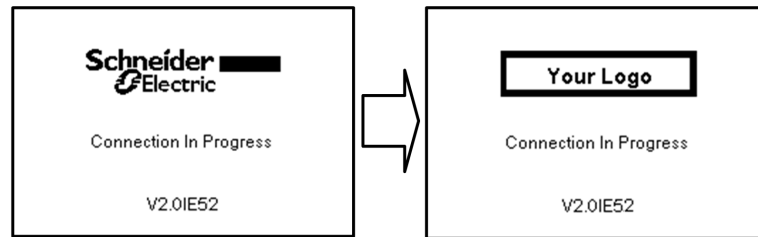

From the firmware version V2.0 of the Graphic Display Terminal, the logo displayed at power on by the Graphic Display Terminal can be customized. By default, the Schneider-Electric logo is displayed.

To modify the displayed logo, you must:

- Create your own logo and save it as a bitmap file (.bmp) with the name logo\_init. The logo must be saved in black & white and the dimensions must be 137x32 pixels.
- Connect the Graphic Display Terminal to a computer via an USB cable.
- Copy your logo (logo\_init.bmp) in the folder KPCONFIG of the Graphic Display Terminal.

At next power on of the Graphic Display Terminal connected to the drive, your own logo should be displayed.

If the logo of Schneider-Electric is still displayed, verify the characteristics of your file and the location where it has been copied.

# Product LEDs

## Introduction

The drive embeds status LEDs that are used to indicate the drive status.

The number of LEDs available varies according to the drive rating.

- For ATV340U07N4• to ATV340D22N4•: 4 LEDs.
- For ATV340D30N4E to ATV340D75N4E: 10 LEDs.

## LEDs Description ATV340U07N4• to ATV340D22N4•

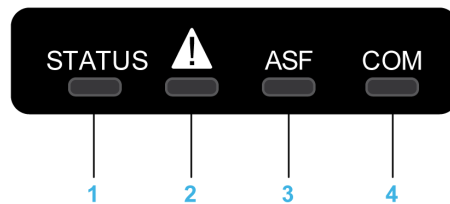

Following table provides the details of the drive status LEDs:

Item	LED	Color & status	Description
1	STATUS	OFF	Indicates that the drive is powered off
		Green flashing	Indicates that the drive is not running, ready to start
		Green blinking	Indicates that the drive is in transitory status (acceleration, deceleration, and so on)
		Green on	Indicates that the drive is running
		Yellow on	Device visual identification when using the DTM based commissioning software
2	Warning/Error	Red flashing	Indicates that the drive has detected a warning
		Red on	Indicates that the drive has detected an error
3	ASF	Yellow on	Indicates that the safety function has been triggered
4	COM	Yellow flashing	Indicates embedded Modbus serial activity

## LEDs Description ATV340D30N4E to ATV340D75N4E

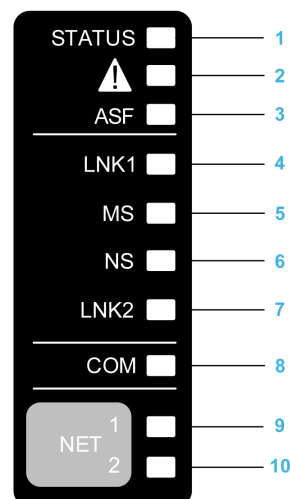

Following table provides the details of the drive status LEDs:

Item	LED	Color & status	Description
1	<b>STATUS</b>	OFF	Indicates that the drive is powered off
		Green flashing	Indicates that the drive is not running, ready to start
		Green blinking	Indicates that the drive is in transitory status (acceleration, deceleration, and so on)
		Green on	Indicates that the drive is running
		Yellow on	Device Visual identification function when using SoMove or the device DTM
2	<b>Warning/Error</b>	Red flashing	Indicates that the drive has detected a warning
		Red on	Indicates that the drive has detected an error
3	<b>ASF</b>	Yellow on	Indicates that the safety function has been triggered

Following table provides the details of the embedded Ethernet LEDs:

Item	LED	Color & status	Description
4	<b>LNK1</b>	OFF	No link.
		Green/Yellow flashing	Power on testing.
		Green on	Link established at 100 Mbit/s.
		Green flashing	Link established at 10 Mbit/s.
		Yellow flashing	Fieldbus activity at 100 Mbit/s.
		Yellow on	Fieldbus activity at 10 Mbit/s.
5	<b>MS</b>	OFF	No power is supplied to the device.
		Green/Red flashing	Power up testing.
		Green on	The device is operating correctly.
		Green flashing	The device has not been configured.
		Red flashing	The device has detected a recoverable minor detected error.
		Red on	The device has detected a non-recoverable major detected error.
6	<b>NS</b>	OFF	The device does not have an IP address or powered off.
		Green/Red flashing	Power on testing.
		Green on	A connection is established to control the command word.
		Green flashing	Device has a valid IP, but no command word connection.
		Red flashing	Duplicated IP.
		Red on	An established connection to control the command word is closes or timed out.
7	<b>LNK2</b>	OFF	No link.
		Green/Yellow flashing	Power on testing.
		Green on	Link established at 100 Mbit/s.
		Green flashing	Link established at 10 Mbit/s.
		Yellow flashing	Fieldbus activity at 100 Mbit/s.
		Yellow on	Fieldbus activity at 10 Mbit/s.

Following table provides the details of the embedded Modbus serial LEDs:

Item	LED	Color & status	Description
8	<b>COM</b>	Yellow flashing	Indicates embedded Modbus serial activity

Following table provides the details of the fieldbus module LEDs:

Item	LED	Color & status	Description
9	NET 1	Green/Red	For details, refer to the fieldbus manual
10	NET 2	Green/Red	For details, refer to the fieldbus manual

## Sercos III LEDs on ATV340.....S

Please refer to the ATV340 Sercos III manual PHA33735 (English).

# Multipoint Screen

## Overview

Generally, a Graphic Display Terminal is connected to only one drive. However, communication is possible between a Graphic Display Terminal and several Altivar drives (ATV320, ATV340, ATV600, and ATV900) connected on the same Modbus serial fieldbus via the RJ45 port (HMI or Modbus serial). In such a case, the multipoint mode is automatically applied on the Graphic Display Terminal.

The multipoint mode allows you to:

- Have an overview of all the drives connected on the fieldbus (drive state and two selected parameters).
- Access to all the menus of each drive connected on the fieldbus.
- Command a stop on all the connected drives with the STOP/RESET key (irrespective of the present screen displayed). The type of stop can be individually configured on each drive with the parameter **[Stop Key Enable] PST** in the menu **[Command and Reference] CRP-**, page 187.

Apart the Stop function linked to the STOP/RESET key, the multipoint mode does not allow to apply a Fault Reset and command the drive via the Graphic Display Terminal: in multipoint mode, the Run key and the Local/Remote key are deactivated.

## Prerequisites

To use the multipoint mode:

- The Graphic Display Terminal software version must be equal to or higher than V2.0.
- For each drive, the command channel and the reference channel must be set in advance to a value different from **[HMI] LCC**, page 187.
- The address of each drive must be configured in advance to different values by setting the parameter **[Modbus Address] ADD** in the **[Modbus Fieldbus] MD1-**.
- If the connection to the drive is done via the HMI RJ45 port, the parameter settings in **[Modbus HMI] MD2-** must be compliant with the Graphic Display Terminal usage.
- If the connection to the drive is done via the Modbus serial RJ45 port, the parameter settings in **[Modbus Fieldbus] MD1-** must be compliant with the Graphic Display Terminal usage.

## Example of Installation Topology

The following figure gives a topology example using four drives, a Modbus “T” tap-off (VW3A8306TF03) and one Graphic Display Terminal (VW3A1111) linked to one Modbus splitter block (LU9GC3):

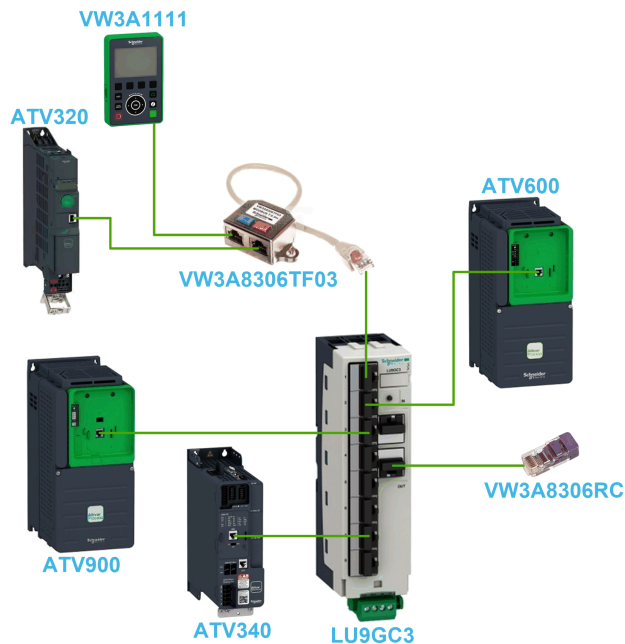

## Screens for Multipoint Mode

The following figure gives the browsing between the different screens linked to the multipoint mode:

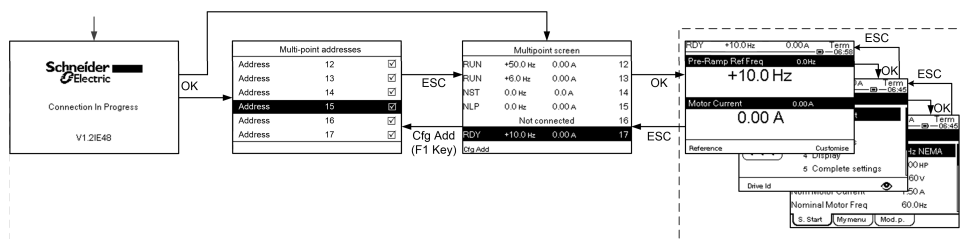

On the fieldbus common with the Graphic Display Terminal, if two or more drives are powered on, you access to the **[connection in progress]** screen. If there is no address selected by the Graphic Display Terminal or no recognized address, the Graphic Display Terminal is locked on this screen. Press OK key to access to the **[Multi-point Addresses]** screen. Otherwise, if there are addresses-selected and one of them have been recognized by the Graphic Display Terminal, the screen switches automatically to **[Multipoint screen]**.

The **[Multi-point Addresses]** screen allows to select, by pressing OK key, the addresses of the drives you want to connect with. Up to 32 addresses can be selected (address setting range: 1...247). When all the addresses have been selected, press ESC key to access to the **[Multipoint screen]**.

**NOTE:** To help to prevent a low refresh rate of the Graphic Display Terminal screen, do not select addresses that are not corresponding to drive addresses.

On the **[Multipoint screen]**, the touch wheel is used to navigate between the drive overviews. Access to the menus of the selected drive by pressing OK key. Return to the **[Multipoint screen]** by pressing ESC key.



**NOTE:** To access the **[Multi-point Addresses]** screen from the **[Multipoint screen]**, press F1 key.

If a drive triggers an error, the Graphic Display Terminal goes automatically to the **[Multipoint screen]** on the overview of the latest drive who has triggered an error.

The two parameters given in the drive overview can be modified individually on each drive in **[Bar Selection]** **PBS-** menu , page 534.

# Structure of the Parameter Table

## General Legend

Pictogram	Description
	These parameters only appear if the corresponding function has been selected in another menu. When the parameters can also be accessed and adjusted from within the configuration menu for the corresponding function, their description is detailed in these menus, on the pages indicated, to aid programming.
	Setting of this parameter can be done during operation or when stopped. <b>NOTE:</b> It is advisable to stop the motor before modifying any of the settings.
	To modify the assignment of the parameter, reinforced validation is required.

## Parameter Presentation

Below is an example of a parameter presentation:

### [Sample Menu] CODE– Menu

#### Access

Parameters described below can be accessed by:

[Path] ➔ [Sub-path]

#### About This Menu

Description of the menu or function

### [Short Label for Parameter 1] CODE1

#### Long Label for parameter 1

Description of the parameter

Example of a table with a setting range:

Setting ( )	Description
0.0... 10,000.0	Setting range <b>Factory setting:</b> 50.0

Example of a table with a value range (For display parameters):

Value range	Description
0.0... 10,000.0	<b>Factory setting:</b> _

### [Short Label for Parameter 2] CODE2

#### Long Label for parameter 2

Description of the parameter

Example of a table with a list of choices:

Setting ( )	Code / Value	Description
[50 Hz IEC]	50	IEC <b>Factory setting</b>
[60 Hz NEMA]	60	NEMA

Example of a table with a list of possible value (For display parameters):

Value range	Code / Value	Description
[50 Hz IEC]	50	IEC
[60 Hz NEMA]	60	NEMA

## Finding a Parameter in This Document

### With the Manual

It is possible to use either the parameter name or the parameter code to search in the manual the page giving details of the selected parameter.

### Difference Between Menu and Parameter

A dash after menu and submenu codes is used to differentiate menu commands from parameter codes.

Example:

Level	Name	Code
Menu	[Ramp]	RAMP-
Parameter	[Acceleration]	ACC



# Cyber Security

## What's in This Chapter

Overview .....	41
Password .....	47
Upgrades Management .....	48

## Overview

The objective of Cybersecurity is to help provide increased levels of protection for information and physical assets from theft, corruption, misuse, or accidents while maintaining access for their intended users.

No single Cybersecurity approach is adequate. Schneider Electric recommends a defense-in-depth approach. Conceived by the National Security Agency (NSA), this approach layers the network with security features, appliances, and processes.

The basic components of this approach are:

- Risk assessment
- A security plan built on the results of the risk assessment
- A multi-phase training campaign
- Physical separation of the industrial networks from enterprise networks using a demilitarized zone (DMZ) and the use of firewalls and routing to establish other security zones
- System access control
- Device hardening
- Network monitoring and maintenance

This chapter defines the elements that help you configure a system that is less susceptible to cyber-attacks.

Network administrators, system integrators and personnel that commission, maintain or dispose of a device should:

- Apply and maintain the device's security capabilities. See Device Security Capabilities sub-chapter for details
- Review assumptions about protected environments. See Protected Environment Assumptions sub-chapter for details
- Address potential risks and mitigation strategies. See Product Defense-in-Depth sub-chapter for details
- Follow recommendations to optimize cybersecurity

For detailed information on the system defense-in-depth approach, refer to the TVDA: How Can I Reduce Vulnerability to Cyber Attacks in the Control Room (STN V2) on [se.com](http://se.com).

To submit a Cybersecurity question, report security issues, or get the latest news from Schneider Electric, visit the [Schneider Electric website](#).

## ⚠ WARNING

### POTENTIAL COMPROMISE OF SYSTEM AVAILABILITY, INTEGRITY, AND CONFIDENTIALITY

- Change default password to help prevent unauthorized access to device settings and information.
- Disable unused ports/services and default accounts, where possible, to minimize pathways for malicious attacks.
- Place networked devices behind multiple layers of cyber defenses (such as firewalls, network segmentation, and network intrusion detection and protection).
- Use cybersecurity best practices (for example: least rights, separation of duties) to help prevent unauthorized exposure, loss or modification of data and logs, interruption of services, or unintended operation.

**Failure to follow these instructions can result in death, serious injury, or equipment damage.**

## Protected Environment Assumptions

Machines, controllers, and related equipment are usually integrated into networks. Unauthorized persons and malware may gain access to the machine as well as to other devices on the network/fieldbus of the machine and connected networks via insufficiently secure access to software and networks.

## ⚠ WARNING

### UNAUTHORIZED ACCESS TO THE MACHINE VIA SOFTWARE AND NETWORKS

- In your hazard and risk analysis, consider all hazards that result from access to and operation on the network/fieldbus and develop an appropriate cyber security concept.
- Verify that the hardware infrastructure and the software infrastructure into which the machine is integrated as well as all organizational measures and rules covering access to this infrastructure consider the results of the hazard and risk analysis and are implemented according to best practices and standards covering IT security and cyber security (such as: ISO/IEC 27000 series, Common Criteria for Information Technology Security Evaluation, ISO/ IEC 15408, IEC 62351, ISA/IEC 62443, NIST Cybersecurity Framework, Information Security Forum - Standard of Good Practice for Information Security, SE recommended Cybersecurity Best Practices\*).
- Verify the effectiveness of your IT security and cyber security systems using appropriate, proven methods.

**Failure to follow these instructions can result in death, serious injury, or equipment damage.**

(\*) : SE Recommended Cybersecurity Best Practices can be downloaded on [SE.com](#).

Before considering cybersecurity practices on the device, please pay attention to following points:

- Cybersecurity governance – available and up-to-date guidance on governing the use of information and technology assets in your company.
- Perimeter security – installed devices, and devices that are not in service, are in an access-controlled or monitored location.

- Emergency power – the control system provides the capability to switch to and from an emergency power supply without affecting the existing security state or a documented degraded mode.
- Firmware upgrades – the ATV340 upgrades are implemented consistently to the current version of firmware available on request from Schneider Electric Customer Care Center.
- Controls against malware – detection, prevention, and recovery controls to help protect against malware are implemented and combined with appropriate user awareness.
- Physical network segmentation – the control system provides the capability to:
  - Physically segment control system networks from non-control system networks.
  - Physically segment critical control system networks from non-critical control system networks.
- Logical isolation of critical networks – the control system provides the capability to logically and physically isolate critical control system networks from non-critical control system networks. For example, using VLANs.
- Independence from non-control system networks – the control system provides network services to control system networks, critical or non-critical, without a connection to non-control system networks.
- Encrypt protocol transmissions over all external connections using an encrypted tunnel, TLS wrapper or a similar solution.
- Zone boundary protection – the control system provides the capability to:
  - Manage connections through managed interfaces consisting of appropriate boundary protection devices, such as: proxies, gateways, routers, firewalls, and encrypted tunnels.
  - Use an effective architecture, for example, firewalls protecting application gateways residing in a DMZ.
  - Control system boundary protections at any designated alternate processing sites should provide the same levels of protection as that of the primary site, for example, data centers.
- No public internet connectivity – access from the control system to the internet is not recommended. If a remote site connection is needed, for example, encrypt protocol transmissions.
- Resource availability and redundancy – ability to break the connections between different network segments or use duplicate devices in response to an incident.
- Manage communication loads – the control system provides the capability to manage communication loads to mitigate the effects of information flooding types of DoS (Denial of Service) events.
- Control system backup – available and up-to-date backups for recovery from a control system failure

## Security Policy

### ⚠ WARNING

#### ACCESSIBILITY LOSS

- Setup a security policy to your device and backup the device image with security administrator user account.
- Define and regularly review the password policy.
- Periodic change of the passwords, Schneider Electric recommends a modification of the password each 90 days.

**Failure to follow these instructions can result in death, serious injury, or equipment damage.**

Cybersecurity helps to provide:

- Confidentiality (to help prevent unauthorized access)
- Integrity (to help prevent unauthorized modification)
- Availability/authentication (preventing the denial of service and assuring authorized access)
- Non-repudiation (preventing the denial of an action that took place)
- Traceability/detection (logging and monitoring)

For an efficient security, the instructions and procedures should structure the roles and responsibilities in terms of security within the organization, in other words, who is authorized to perform what and when? These should be known by the users.

The anti-intrusion and anti-physical access to any sensitive installation should be set up.

All the security rules implemented in the ATV340 are in complement of the points above.

The device does not have the capability to transmit data encrypted using the following protocols: HTTP, Modbus slave over serial, Modbus slave over Ethernet, EtherNet/IP, SNMP, SNTIP. If other users gained access to your network, transmitted information can be disclosed or subject to tampering.

### ⚠ WARNING

#### CYBERSECURITY HAZARD

- For transmitting data over an internal network, physically or logically segment the network, the access to the internal network needs to be restricted by using standard controls such as firewalls.
- For transmitting data over an external network, encrypt protocol transmissions over all external connections using an encrypted tunnel, TLS wrapper or a similar solution.

**Failure to follow these instructions can result in death, serious injury, or equipment damage.**

The access through the digital inputs is not controlled.

Any computer using SoMove, DTM, Webserver or EcoStruxure Control Expert should have an updated anti-virus, anti-malware, anti-ransomware application activated during the use.

The ATV340 have the capability to export its settings and files manually or automatically. It is recommended to archive any settings and files (device backup images, device configuration, device security policies) in a secure area.

## Product Defense-in-Depth

Use a layered network approach with multiple security and defense controls in your IT and control system to minimize data protection gaps, reduce single-points of failure and create a strong cybersecurity posture. The more layers of security in your network, the harder it is to breach defenses, take digital assets or cause disruption.

### Device Security Capabilities

ATV340 offers the following security features:

Threats	Desired security property on Embedded Device	security features
Information disclosure	Confidentiality	Password encrypted in a non-reversible way
		User access control
Denial of Service	Availability	Device backup/restore
		Achilles Level 2
Spoofing/Elevation of privilege	User Authenticity / Authorization	Strong password policy
		Access control commissioning tools Modbus TCP
		Access control commissioning tools Web Server

#### Confidentiality

Information confidentiality capacity prevents unauthorized access to the device and information disclosure.

- The user access control helps on managing users that are authorized to access the device. Protect user credential at usage.
- The user’s passwords are encrypted in non-reversible way at rest

Information affecting the security policy of the device is encrypted in transit.

#### Device Integrity Protection

The device integrity protection prevents unauthorized modification of the device with tampered or spoofed information.

This security capability helps protect the authenticity and integrity of the firmware running on the ATV340 and facilitates protected file transfer: digitally signed firmware is used to help protect the authenticity of the firmware running on the ATV340 and only allows firmware generated and signed by Schneider Electric.

- Cryptographic signature of the firmware package executed at the firmware update

#### Availability

The control system backup is essential for recovery from a control system failure and/or misconfiguration and participate on preventing denial of service. It also helps ensure global availability of the device by reducing operator overhead on security application/deployment.

These security capabilities help manage control system backup with the device:

- Complete device backup/restore available on local HMI, DTM and FDR. Regarding the communication robustness, the ATV340 embedded Ethernet fieldbus successfully passed the certification Achilles L2.

#### User Authenticity and Authorization

The user authentication helps prevent the repudiation issue by managing user identification and prevents information disclosure and device integrity issues by unauthorized users.

These security capabilities help enforce authorizations assigned to users, segregation of duties and least rights:

- User authentication is used to identify and authenticate software processes and devices managing accounts
- Device Password policy and password strength configurable using SoMove, DTM or EcoStruxure Control Expert
- Authorization managed according to channels

In line with user authentication and authorization, the device has access control cryptographic features to check user credential before access is granted to the system.

In the ATV340, the control of accessibility to the settings, parameters, configuration, and logging database is done with a user authentication after "Log in", with a name and password.

The ATV340 controls the access through:

- SoMove DTM (Ethernet connection)
- The webserver
- EcoStruxure Control Expert

## Potential Risks and Compensating Controls

Address potential risks using these compensating controls:

Area	Issue	Risk	Compensating controls
User accounts.	Default account settings are often the source of unauthorized access by malicious users.	If you do not change default password or disable the user access control, unauthorized access can occur.	Ensure User access control is enabled on all the communication ports and change the default passwords to help reduce unauthorized access to your device.
Secure protocols.	Modbus serial, Modbus TCP, EtherNet/IP, SNMP, SNTP, HTTP protocols are insecure.  The device does not have the capability to transmit data encrypted using these protocols.	If a malicious user gained access to your network, they could intercept communication.	For transmitting data over internal network, physically or logically segment your network.  For transmitting data over external network, encrypt protocol transmissions over all external connections using an encrypted tunnel, TLS wrapper or a similar solution.  See Protected Environment Assumptions, page 42.

## Data Flow Restriction

A firewall device is required to secure the access to the device and limit the data flow.

For detailed information, refer to the TVDA: How Can I Reduce Vulnerability to Cyber Attacks in the Control Room (STN V2) on the Schneider Electric website.

# Password

## Changing Password

The user password can be changed from the DTM Admin options screen.

## Reset Password

The password is accessible in the graphic display terminal by default.

The ATV340 stores password in a secure non-reversible format. It is not possible to retrieve a password that has been lost by the user.

For ADMIN user, a special operation is available with the display terminal to reset the ADMIN password to a default value unique to the device.

To reset the ADMIN password:

Step	Action
1	Navigate in the menu <b>[Communication] COM-</b> → <b>[Comm parameters] CMP-</b> → <b>[Embd Eth Config] ETE-</b> → <b>[User authentication] SECE-</b> .
2	Scroll to the parameter <b>[Reset Eth Embd Pwd] RWPE</b> and press <b>OK</b> .
3	The default password is visible on the graphic display terminal until the ADMIN modifies it.

Upon first use, the commissioning tools and webserver requests the user to change the password prior to connecting. The cybersecurity policy does not change when the password is reset.

## Password Policy

By default, the password policy of the ATV340 complies with IEEE 1686–2013 as following:

- 8 characters minimum with ASCII [32 to 122] characters
- At least one digit (0-9)
- At least one special character (for example @, \$)

In addition, for password changes, the password history is saved and help prevent the reuse of a password that has been set at least once in the last 5 times.

The password policy can be customized or totally disabled to match with password policy in place in the system of which the device is part.

The following settings are available:

- Password policy: enabled/disabled. If disabled, a password is requested as authentication factor but there is no specific rule defined regarding the password robustness
- Password history: No restriction, Exclude last 3, Exclude last 5
- Special character required: YES/NO
- Numeric character required: YES/NO
- Alphabetic character required: YES/NO
- Minimum password length: any value between 6 and 20

This password policy customization can only be done with SoMove, DTM or EcoStruxure Control Expert. Please refer to DTM online help for details.

## Upgrades Management

When the ATV340 firmware is upgraded, security configuration remains the same until changed, including usernames and passwords.

It is recommended that security configuration is reviewed after an upgrade to analyze rights for new or changed device features and revoke or apply them according to your company's policies and stand



# Programming

## What's in This Part

<b>[Simply Start]</b> <b>SYS</b> —.....	50
<b>[Dashboard]</b> <b>DSH</b> —.....	54
<b>[Diagnostics]</b> <b>DIA</b> —.....	61
<b>[Display]</b> <b>MON</b> —.....	69
<b>[Complete settings]</b> <b>CST</b> —.....	106
<b>[Communication]</b> .....	521
<b>[File management]</b> <b>FMT</b> —.....	523
<b>[My preferences]</b> <b>MYP</b> —.....	528

# [Simply Start] SYS–

## What's in This Chapter

[Simply start] SIM– Menu .....	51
[My menu] MYMN– Menu .....	53
[Modified parameters] LMD– Menu .....	53

## Introduction



[Simply Start] SYS– menu contains 3 tabs for quick access to mains features:

- Simply Start tab which gives a quick access to basic parameters to set.
- My Menu tab which is a user-defined menu for quick access to specific parameters.
- Modified Parameters tab which gives a quick access to the 10 last modified parameters.

# [Simply start] SIM– Menu

## Access

[Simply Start] SYS– → [Simply start] SIM–

## About This Menu

<b>⚠ WARNING</b>
<p><b>LOSS OF CONTROL</b></p> <ul style="list-style-type: none"> <li>• Fully read and understand the manual of the connected motor.</li> <li>• Verify that all motor parameters are correctly set by referring to the nameplate and the manual of the connected motor.</li> <li>• If you modify the value of one or more motor parameters after having performed autotuning, the value of <b>[Tune selection] STUN</b> and/or <b>[Rotation Tune Select] STUR</b> is reset to <b>[Default] TAB</b> and you must re-perform autotuning.</li> </ul> <p><b>Failure to follow these instructions can result in death, serious injury, or equipment damage.</b></p>

This menu provides a quick access to basic parameters to set in case of a single asynchronous motor in open loop control.

**NOTE:** On Graphic Display Terminal (VW3A1111), **[Simply start] SIM–** is the first tab displayed in the **[Simply Start] SYS–** menu (the tab name is “S. Start”).

For more information on the setting of the parameters present in this menu or to set your drive in another use case (such as synchronous motor and/or with specific functions) refer to **[Complete settings] CST–** menu.

**NOTE:** To help set basic parameters of the drive, a dedicated view exists in SoMove/DTM.

The following table shows a standard procedure for a simply start configuration of the drive used with an asynchronous motor in open loop control. This procedure only uses the basic parameters that can be accessed in this menu:

Step	Parameter	Menu	Description	Factory setting
1 – Motor Standard	<b>[Motor Standard] BFR</b> <sup>(1)</sup>	<b>[data] MTD–</b>	Help to preset the drive parameters and units according to the standard 50 Hz IEC or 60 Hz NEMA. <b>NOTE:</b> First parameter to modify. Otherwise, the drive configuration must be performed again.	<b>[50 Hz] 50Hz</b>
2 – Motor nameplate	<b>[Nominal Motor Power] NPR</b> <sup>(1)</sup>	<b>[data] MTD–</b>	Set these parameters according to the motor nameplate.  By default, <b>[Motor 1 Cosinus Phi] COS</b> does not need to be entered. To enter the motor nameplate using <b>COS</b> , the parameter <b>[Motor param choice] MPC</b> must be set to <b>[Motor 1 Cosinus Phi] COS</b> . In this case, <b>[Nominal Motor Power] NPR</b> does not need to be entered.	- (4)
	<b>[Nom Motor Voltage] UNS</b> <sup>(1)</sup>			- (4)
	<b>[Nom Motor Current] NCR</b> <sup>(1)</sup>			- (4)
	<b>[Nominal Motor Freq] FRS</b> <sup>(1)</sup>			50 Hz <sup>(6)</sup>
	<b>[Nominal Motor Speed] NSP</b> <sup>(1)</sup>			- (4)
	<b>[Motor 1 Cosinus Phi] COS</b> <sup>(1) (2)</sup>			- (4)
	<b>[Motor Th Current] ITH</b>			- (4)
3 — Type of wiring	<b>[2/3-Wire Control] TCC</b>	<b>[Com- mand and</b>	Select between 2-wire and 3-wire control.	<b>[2-Wire Control] 2C</b>

Step	Parameter	Menu	Description	Factory setting
		<b>Reference]</b> CRP-		
4 — Maximum motor frequency	<b>[Max Frequency]</b> TFR	<b>[data]</b> MTD-	Maximum output frequency.	60 Hz <sup>(5)</sup>
5 — Standstill motor tune	<b>[Autotuning]</b> TUN	<b>[Motor tune]</b> MTU-	Use to perform a standstill motor tune (autotuning) to measure internal motor characteristics. Set <b>[Autotuning]</b> TUN to <b>[Apply Autotuning]</b> YES to start the standstill motor tune. TUN and STUN are used to monitor the tune status.  <b>NOTE:</b> If you modify the value of one or more motor parameters after having performed autotuning, you must re-perform autotuning.	<b>[No Action]</b> NO
	<b>[Autotuning Status]</b> TUS			<b>[Not Done]</b> TAB <sup>(3)</sup>
	<b>[Tune selection]</b> STUN			<b>[Default]</b> TAB <sup>(3)</sup>
6 — Dynamics and limits of the reference	<b>[Acceleration]</b> ACC	<b>[Ramp]</b> RAMP-	Time to accelerate from 0 Hz to <b>[Nominal Motor Freq]</b> FRS and time to decelerate from <b>[Nominal Motor Freq]</b> FRS to 0 Hz.  <b>NOTE:</b> To have a repeatability in the ramps, the value of these parameters must be set according to the possibility of the application (for example the inertia must be considered).	3.0 s
	<b>[Deceleration]</b> DEC			3.0 s
	<b>[Low Speed]</b> LSP	<b>[Speed Limits]</b>	Minimum motor frequency reference.	0.0 Hz
	<b>[High Speed]</b> HSP	SLM-	Maximum motor frequency reference.	50.0 Hz <sup>(6)</sup>
<p>(1): This parameter can only be accessed with asynchronous motor control law.</p> <p>(2): The access to this parameter depends on <b>[Motor param choice]</b> MPC. This parameter can be accessed in <b>[data]</b> MTD- menu.</p> <p>(3): Read-only parameter.</p> <p>(4): The factory setting, the unit and/or the increment is impacted by the drive rating and/or <b>[Motor Standard]</b> BFR.</p> <p>(5): The factory setting value is changed to 72 Hz if <b>[Motor Standard]</b> BFR is set to <b>[60 Hz] NEMA 60Hz</b>.</p> <p>(6): The factory setting value is changed to 60 Hz if <b>[Motor Standard]</b> BFR is set to <b>[60 Hz] NEMA 60Hz</b>.</p>				

## [My menu] MYMN– Menu

### Access

[Simply Start] → [My menu]

### About This Menu

This menu contains the parameters selected in the [My menu config.] MYC– Menu, page 533.

**NOTE:** This menu is empty by default.

## [Modified parameters] LMD– Menu

### Access

[Simply Start] → [Modified parameters]

### About This Menu

This menu gives a quick access to the 10 last modified parameters.

## [Dashboard] DSH–

### What's in This Chapter

[System] DST– Menu .....	55
[Dashboard] DSH– Menu.....	57
[kWh Counters] KWC– menu .....	58
[Dashboard] DSH– Menu.....	60

## Introduction



[Dashboard] DSH– menu contains tabs for quick access to system and display features:

- System tab to configure the main system parameters.
- Energy tab which provides a complete access for instantaneous power counters and energy reports by means of graphics on the Display Terminal.

## [System] DST– Menu

### Access

[Dashboard] → [System]

### [Pre-Ramp Ref Freq] FRH

**Reference frequency before ramp** (signed value).

Actual frequency reference linked to the motor regardless of which channel for reference value has been selected. This parameter is in read-only mode.

Setting	Description
-[High Speed] <sup>HSP...</sup> [High Speed] <sup>HSP</sup> Hz	Setting range <b>Factory setting:</b> –

### [Device State] HMIS

#### Device state

Setting	Code / Value	Description
[Autotuning]	TUN	Autotuning
[In DC inject.]	DCB	DC Injection
[Ready]	RDY	Drive ready
[Freewheel]	NST	Freewheel stop control
[Running]	RUN	Motor in steady state or run command present and zero reference
[Accelerating]	ACC	Acceleration
[Decelerating]	DEC	Deceleration
[Current Limitation]	CLI	In current limitation
[Fast stop]	FST	Fast stop
[No Mains Voltage]	NLP	Control is powered on but the DC bus is not loaded
[control.stop]	CTL	Controlled stop
[Dec. adapt.]	OBR	Adapted deceleration
[Output cut]	SOC	Stand by output cut
[Undervoltage Warning]	USA	Undervoltage warning
[Operating State "Fault"]	FLT	Product has detected an error
[DCP Flashing Mode]	DCP	DCP flashing mode
[STO active]	STO	Safe Torque Off active
[Firmware Update]	FWUP	Firmware update
[Angle test]	ASA	Angle setting

## [Motor Current] LCR

### Motor current

Setting	Description
According to drive rating	Setting range Factory setting: –

## [Motor Speed] SPD

This parameter displays the estimated rotor speed without motor slip.

Setting	Description
0...65,535 rpm	Setting range Factory setting: –

## [Motor Therm State] THR

The nominal motor thermal state is 100%, the [Motor Overload] OLF threshold is set to 118%.

Setting	Description
0...200%	Setting range Factory setting: –



## [Dashboard] DSH- Menu

### Access

[Dashboard]

### [Torque vs Speed] CTS

Displays the torque versus speed curve.

## [kWh Counters] KWC- menu

### Access

[Dashboard] → [kWh Counters]

### About This Menu

This menu presents many energy objects available for instantaneous data and kW consumption reports.

It offers the possibility to display logged data with graphics by pressing the F4 function key.

### [Elc Energy Cons] OC4 ★

This parameter can be accessed if [Elc Energy Cons] OC4 is not set to 0.

Setting	Description
0...999 TWh	Setting range Factory setting: Read Only

### [Elc Energy Cons] OC3 ★

*Electrical energy consumed by the motor (GWh)*

Setting	Description
0...999 GWh	Setting range Factory setting: Read Only

### [Elc Energy Cons] OC2 ★

*Electrical energy consumed by the motor (MWh)*

Setting	Description
0...999 MWh	Setting range Factory setting: Read Only

### [Elc Energy Cons] OC1 ★

*Electrical energy consumed by the motor (KWh)*

Setting	Description
0...999 kWh	Setting range Factory setting: Read Only

## [Elc Energy Cons] OC0 ★

### Electrical energy consumed by the motor (Wh)

Setting	Description
0...999 Wh	Setting range <b>Factory setting:</b> Read Only

## [Acv Elc Out Pwr in kW] EPRW

### Active Electrical output power in kW

Setting	Description
-32,767...32,767	Setting range Value in kW or HP according to <b>[Motor Standard] BFR</b> setting <b>Factory setting:</b> Read Only

## [Elc Egy Today] OCT

### Electrical energy consumed TODAY by the motor (KWh)

Setting	Description
0...4,294,967,295 kWh	Setting range in kWh <b>Factory setting:</b> Read Only

## [Elc Egy Yesterday] OCY

### Electrical energy consumed YESTERDAY by the motor (KWh)

Setting	Description
0...4,294,967,295 kWh	Setting range in kWh <b>Factory setting:</b> Read Only

## [Dashboard] DSH– Menu

### Access

[Dashboard]

### About This Menu

Using **F4** function key on the Display Terminal, it is possible to select one of the following view for the **[Energy]** tab.

#### [Instant kW Trend] CV1

Displays the instantaneous electrical energy curve at the drive output.

#### [Daily kWh Report] HSD

Displays the daily energy histogram.

#### [Weekly kWh Report] HSW

Displays the weekly energy histogram.

#### [Monthly kWh Report] HSM

Displays the monthly energy histogram.

#### [Yearly kWh Report] HSY

Displays the yearly energy histogram.

# [Diagnostics] DIA-

## What's in This Chapter

[Diag. data] DDT- .....	62
[Error history] PFH- Menu .....	65
[Warnings] ALR- Menu .....	67

## Introduction



[Diagnostics] DIA- menu presents drive and application data useful when diagnostics is required.

## [Diag. data] DDT-

### [Diag. data] DDT- Menu

#### Access

[Diagnostics] → [Diag. data]

#### About This Menu

This menu presents the last warning and detected error in addition to drive data.

#### [Last Warning] LALR

The list of warning codes is available in the chapter Warning Codes, page 546.

#### [Last Error] LFT

The list of error codes is available in the chapter Error Codes, page 548.

#### [Internal Error 6] INF6 ★

This parameter can be accessed if [Last Error] LFT is [Internal Error 6] INF6 in order to provide more information on the related error.

Setting	Description
0...12 (value in Hex.)	0x00 : No error detected 0x01 : No response of the option module 0x02 : Signature reception timeout 0x03 : ACK reception timeout 0x04 : Signature length 0x05 : CheckSum 0x06 : Unknown state 0x07 : UART receive 0x08 : Unknown protocol version 0x09 : Unknown module type 0x0A : More than 5 unsuccessful tries 0x0B : Unknown module type 0x0C : Option module not supported by the slot 0x0D : Same option module in more than one slot 0x0E : O1SV not received 0x0F : O1SV option module software version not compatible 0x10 : reserved 0x11 : reserved 0x12 : Control terminal module not present or not recognized <b>Factory setting:</b> Read-only parameter

#### [Internal Error 19] INFJ ★

##### *Internal error 19 (Encoder module)*

This parameter can be accessed if [Last Error] LFT is [Internal Error 19] INFJ.

Setting	Description
0...65,535	Setting Range <b>Factory setting:</b> Read-only parameter

## [Encoder Fdbck Error] ENCE ★

Encoder feedback error code.

This parameter can be accessed if [Last Error] LFT is [Encoder Feedback Loss] SPF in order to provide more information on the related error.

Setting	Description
0...65,535	1: Encoder power supply overcurrent 10: AB encoder: A-line disconnected 11: AB encoder: B-line disconnected 12: AB encoder: tracking error 13: AB encoder: spike error 20: Resolver: LOS error 21: Resolver: DOS error 22: Resolver: LOT error 30: SinCos: loss of signal 31: SinCos: loss of signal 32: SinCos: tracking error 33: SinCos: spike error 40: Hiperface: timeout while waiting for response and retry exceeded 41: Hiperface: encoder type is not known and can not be read from encoder EEPROM 42: Hiperface: Hiperface command GetAbsolutePosition error 43: Hiperface: checksum error detected and retry exceeded 50: Endat: communication error 51: Endat: encoder not connected 52...56: Endat: error reading EnDat21 parameter 57: Endat: encoder does not support EnDat22 58: Endat: runtime compensation procedure 59: Endat: runtime compensation procedure 60: Endat: error in cyclic communication <b>Factory setting:</b> Read-only parameter

## [Nb Of Starts] NSM

*Number of motor starts* (resettable).

Setting	Description
0...4,294,967,295	Setting range <b>Factory setting:</b> —

## [Motor Run Time] RTHH

Run elapsed time display (resettable) in 0.1 hours (length of time the motor has been switched on).

Setting	Description
0.0...119,304.5 h	Setting range <b>Factory setting:</b> _

## [Service Message] SER- menu

This menu presents the service message.

This service message is defined using [My preferences] MYP- → [Customization] CUS- → [Service Message] SER- menu.

## [Other State] SST- menu

This menu shows the list of present secondary states.

For more information refer to [Display] MON- → [Other State] SST-.

## [Diagnostics] DAU- menu

This menu allows to make simple test sequences for diagnostics such as Fan(s), HMI LED(s) and IGBT(s) diagnostics.

For more information refer to **[Complete settings] CST- → [Maintenance] CSMA- → [Diagnostics] DAU-**.

## [Identification] OID- menu

This is a read-only menu that cannot be configured. It enables the following information to be displayed:

- Drive reference, power rating, and voltage
- Drive software version
- Drive serial number
- Type of option modules present, with their software version
- Display Terminal type and version.



# [Error history] PFH- Menu

## [Error history] PFH- Menu

### Access

[Diagnostics] → [Error history]

### About This Menu

This menu shows the 15 last detected errors ([Last Error 1] DP1 to [Last Error 15] DPF). [Last Error 1] DP1 is the last stored error.

With the Graphic Display Terminal, the date and time, at which the error has been triggered, is displayed in this menu. The date and time could be set through the [Date/Time Settings] RTC , page 536

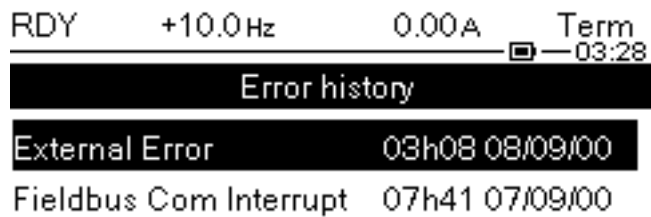

**NOTE:** The list of error codes is available in the chapter "Diagnostics and Troubleshooting" , page 548.

**NOTE:** If [Auto Fault Reset] ATR is active, a triggered error is not stored in the error history until the attempts to perform the Fault Reset end unsuccessful.

Pressing OK key on the selected error code in the error history list displays the drive data recorded when the error has been detected.

**NOTE:** Pressing F1 on the Graphic Display Terminal can give more information about the selected error.

The below table shows the list of drive data recorded for each detected error (these are read-only parameters).

Parameter	Code	Description	Related to the parameter...
[Device State]	HS1...HSF	HMI Status.	[Device State] HMIS
[Last Error x Status]	EP1...EPF	ETA state word: status of last error x.  DRIVECOM status register displayed in hexadecimal	CIA402 [ S E T U S r E G , S E E r ] ETA
[ETI state word]	IP1...IPF	ETI state word (displayed in hexadecimal).  <b>NOTE:</b> [Internal State Reg] ETI can be accessed using fieldbus communication.	[Internal State Reg] ETI
[Cmd word]	CM1...CMPF	Cmd word (displayed in hexadecimal).	[Cmd Register] CMD

[Motor Current]	LCPI...LCPF	Motor current (unit is similar to [Motor Current] LCR)	[Motor Current] LCR
Output frequency	RFP1...RFPF	Output frequency (estimated signed value in 0.1 Hz).	[Motor Frequency] RFR
[Run Elapsed time]	RTP1...RTPF	Elapsed time (value in hours).	[Motor Run Time] RTHH
[DC bus voltage]	ULP1...ULP8	DC bus voltage (value in 0.1 V) <b>NOTE: [No meas.]ULNUNK</b> is displayed if no value is measured.	[DC bus voltage] VBUS
[Motor Therm State]	THP1...THPF	Motor thermal state.	[Motor Therm State] THR
[Command Channel]	DCC1...DCCF	Command channel. <b>NOTE:</b> The command channel can be different from the reference frequency channel in separated mode.n	[Command Channel] CMDC
[Ref Freq Channel]	DRC1...DRCF	Channel for reference frequency.	[Ref Freq Channel] RFCC
[Motor torque]	OTP1...OTPF	Motor torque (estimated value in 0.1 % of [Nom Motor torque] TQN). <b>NOTE:</b> The displayed value is always positive in motor mode and negative in generator mode whatever the direction.	[Motor torque] OTR
[Drive Therm State]	TDP1...TDPF	Drive thermal state (measured).	[Drive Therm State] THD
[IGBT Junction Temp]	TJP1...TJPF	IGBT junction temperature (estimated value in 1 °C).	Not applicable
[Switching frequency]	SFP1...SFPF	Switching Frequency (value in 1 Hz).	[Switching frequency] SFR

## **[Warnings] ALR– Menu**

### **[Actual Warnings] ALRD– Menu**

#### **Access**

**[Diagnostics] → [Warnings] → [Actual Warnings]**

#### **About This Menu**

List of current warnings.

If a warning is active, ✓ and  appears on the Display Terminal.

#### **List of Available Warnings**

The list of warning codes is available in the chapter *Diagnostics and Troubleshooting*, page 545.

## **[Warn grp 1 definition] A1C– to [Warn grp 5 definition] A5C– Menus**

#### **Access**

**[Diagnostics] → [Warnings] → [Warn grp 1 definition] to [Warn grp 5 definition]**

#### **About This Menu**

The following submenus group the warnings into 1 to 5 groups, each of which can be assigned to a relay or a digital output for remote signaling.

When one or a number of warnings selected in a group occurs, this warning group is activated.

#### **List of Warnings**

The list of warning codes is available in the chapter *Diagnostics and Troubleshooting*, page 545.

## **[Warnings] ALR– Menu**

#### **Access**

**[Diagnostics] → [Warnings]**

#### **About This Menu**

This menu presents the warning history (30 past warnings).

## [Warning History] ALH

Identical to [Last Warning] LALR , page 62.

# [Display] MON–

## What's in This Chapter

[Energy parameters].....	70
[Application Parameters].....	78
[M/S Parameters].....	79
[Motor parameters].....	83
[Drive parameters].....	85
[Thermal monitoring].....	89
[PID display].....	90
[Counter Management].....	91
[Other State].....	93
[I/O Map].....	94
[Communication map].....	98
[Data logging].....	103

## Introduction



**[Display] MON–** menu shows monitoring data related to the drive and the application.

This menu is accessible if **[Access Level] LAC** is set to a different value than **[Basic] BAS**.

It offers an application-oriented display in terms of energy, cost, cycle, efficiency, ...

This is available with customized units and graphics view.

## [Energy parameters]

### [Elec Ener Input Counter] **ELI**– Menu

#### Access

[Display] → [Energy parameters] → [Elec Ener Input Counter]

#### About This Menu

This menu presents the input electrical energy data.

#### [Real Input Energy] **IE4** ★

*Real input Energy (TWh).*

This parameter can be accessed if [Real Input Energy] **IE4** is not set to 0.

Value range	Description
-999...999 TWh	Factory setting: _

#### [Real Input Energy] **IE3** ★

*Real input Energy (GWh).*

Value range	Description
-999...999 GWh	Factory setting: _

#### [Real Input Energy] **IE2** ★

*Real input Energy (MWh).*

Value range	Description
-999...999 MWh	Factory setting: _

#### [Real Input Energy] **IE1** ★

*Real input Energy (kWh).*

Value range	Description
-999...999 kWh	Factory setting: _

#### [Real Input Energy] **IE0** ★

*Real input Energy (Wh).*

Value range	Description
-999...999 Wh	Factory setting: _

## [Elec Ener Output Counter] ELO- Menu

### Access

[Display] → [Energy parameters] → [Elec Ener Output Counter]

### About This Menu

This menu presents the output electrical energy data.

### [Acv Elc Out Pwr in kW] EPRW

*Active Electrical output power in kW.*

Value range	Description
According to the drive rating	Unit is in kW if [Motor Standard] BFR is set to [50 Hz]IEC 50Hz or in HP if [Motor Standard] BFR is set to [60 Hz]NEMA 60Hz Factory setting: _

### [Real Consumption] OE4 ★

This parameter can be accessed if [Real Consumption] OE4 is not set to 0.

Value range	Description
-999...999 TWh	Factory setting: _

### [Real Consumption] OE3

*Real energy consumption (GWh).*

Value range	Description
-999...999 GWh	Factory setting: _

### [Real Consumption] OE2

*Real energy consumption (MWh).*

Value range	Description
-999...999 MWh	Factory setting: _

### [Real Consumption] OE1

*Real energy consumption (kWh).*

Value range	Description
-999...999 kWh	Factory setting: _

**[Real Consumption] OE0***Real energy consumption (Wh).*

Value range	Description
-999...999 Wh	Factory setting: _

**[Elc Egy Today] OCT***Electrical energy consumed TODAY by the motor (KWh).*

Value range	Description
0...4,294,967,295 kWh	Factory setting: _

**[Elc Egy Yesterday] OCY***Electrical energy consumed YESTERDAY by the motor (KWh).*

Value range	Description
0...4,294,967,295 kWh	Factory setting: _

**[Over-Consumption Thd] PCAH***Over-consumption threshold.*

Value range	Description
[Under-Consumption Thd] PCAL...200.0%	Factory setting: 0.0%

**[Under-Consumption Thd] PCAL***Under-consumption threshold.*

Maximum value = PCAH if PCAH ≤ 100%.

Value range	Description
0.0...100.0% or [Over-Consumption Thd] PCAH if PCAH ≤ 100%	Factory setting: 0.0%

**[Over/Under-Cons Delay] PCAT***Over/Under-consumption time delay.*

Value range	Description
0...60 min	Factory setting: 1 min

**[Peak Output Power] MOEP***Peak output power.*



---

Value range	Description
According to the drive rating	<b>Factory setting:</b> _

## [Mechanical Energy] MEC– Menu

### Access

[Display] → [Energy parameters] → [Mechanical Energy]

### About This Menu

This menu presents the output mechanical energy data.

### [Power Estim Value] OPRW

*Motor mechanical power estimation.*

Value range	Description
According to the drive rating	Unit is in kW if [Motor Standard] BFR is set to [50 Hz]IEC 50Hz or in HP if [Motor Standard] BFR is set to [60 Hz]NEMA 60Hz Factory setting: _

### [Motor Consumption] ME4 ★

This parameter can be accessed if [Motor Consumption] ME4 is not set to 0.

Value range	Description
0...999 TWh	Factory setting: _

### [Motor Consumption] ME3 ★

*Motor energy consumption (GWh).*

Value range	Description
0...999 GWh	Factory setting: _

### [Motor Consumption] ME2 ★

*Motor energy consumption (MWh).*

Value range	Description
0...999 MWh	Factory setting: _

### [Motor Consumption] ME1 ★

*Motor energy consumption (kWh).*

Value range	Description
0...999 kWh	Factory setting: _

**[Motor Consumption] ME0** ★

**Motor energy consumption (Wh).**

Value range	Description
0...999 Wh	Factory setting: _

## [Energy Saving] ESA- Menu

### Access

[Display] → [Energy parameters] → [Energy Saving]

### About This Menu

This menu presents the comparison in term of cost, energy, CO<sub>2</sub> between solutions with and without drive.

### [Reference Power] PREF

*Reference power without drive.*

Value range	Description
0.00...655.35 kW	Unit is in kW if [Motor Standard] BFR is set to [50 Hz] IEC 50Hz or in HP if [Motor Standard] BFR is set to [60 Hz] NEMA 60Hz. <b>Factory setting:</b> 0.00 kW

### [kWh Cost] ECST

*kWh Cost.*

Value range	Description
0.00...655.35 \$	Unit is in € if [Motor Standard] BFR is set to [50 Hz] IEC 50Hz or in \$ if [Motor Standard] BFR is set to [60 Hz] NEMA 60Hz. <b>Factory setting:</b> _

### [CO2 ratio] ECO2

*CO2 ratio.*

Value range	Description
0.000...65.535 kg/kWh	<b>Factory setting:</b> 0.000 kg/kWh

### [Energy Saved] ESAV

*Energy Saved.*

Value range	Description
0...4,294,967,295 kWh	<b>Factory setting:</b> _

### [Money Saved] CASH

*Money saved.*

Value range	Description
0.00...42,949,672 \$	Unit is in € if [Motor Standard] BFR is set to [50 Hz] IEC 50Hz or in \$ if [Motor Standard] BFR is set to [60 Hz] NEMA 60Hz.  Factory setting: _

## [Co2 Saved] CO2S

### Co2 Saved.

Value range	Description
0.0...429,496,729.5 t	Factory setting: _

## [Application Parameters]

### [Application Parameters] APR- Menu

#### Access

[Display] → [Application Parameters]

#### About This Menu

This menu displays information related to the application.

### [Application state] APPS

This parameter indicates the drive application state.

Value range	Code / Value	Description
[Running]	RUN	No application function in progress; the drive is running
[Stop]	STOP	No application function in progress; the drive is not running
[Local Mode Active]	LOCAL	Forced local mode activated
[Channel 2 Active]	OVER	Override speed control mode activated
[Manual Mode Active]	MANU	Motor running; manual PID mode is active
[PID Active]	AUTO	Motor running; auto PID mode is active
[Boost In progress]	BOOST	The boost is in progress
[Sleep Active]	SLEEP	The sleep is active
[BL In Progress]	BQS	Backlash sequence is in progress

## [M/S Parameters]

### About this Menu

This menu can be accessed if **[M/S Comm Mode]** *MSCM* is not set to **[No]** *NO*.

## [M/S Local Display] MSO– Menu

### Access

[Display] → [M/S Parameters] → [M/S Local Display]

### About This Menu

This menu present the master slave local display related parameters.

This menu can be accessed if **[M/S Comm Mode]** *MSCM* is not set to **[No]** *NO*.

## [M/S Status] MSS

### M/S function status.

Value range	Code / Value	Description
[None]	NONE	Not configured
[M/S Local Control]	NACT	M/S local control
[M/S Not Ready]	NRDY	M/S not ready
[M/S Ready]	READY	M/S ready
[M/S Running]	RUN	M/S running
[M/S Warning]	ALARM	M/S warning

## [M/S Master Speed Ref] MSMS ★

This parameter can be accessed if **[M/S Comm Mode]** *MSCM* is not set to **[No]** *NO*.

Value range	Description
-599.0...599.0 Hz	Factory setting: _

## [M/S Master Torq Ref] FMTR ★

This parameter can be accessed if **[M/S Comm Mode]** *MSCM* is not set to **[No]** *NO*.

Value range	Description
-32,767...32,767 Nm	The value depends on the drive ratings and <b>[Torque Scaling]</b> <i>INRT</i> setting. Factory setting: _

## [M/S Local Speed Ref] MSSR ★

This parameter can be accessed if:

- [M/S Comm Mode] MSCM is not set to [No] NO, and
- [M/S Device Role] MSDT is set to [Slave] SLAVE.

Value range	Description
-599.0...599 Hz	Factory setting: _

## [M/S Local Torq Ref] FTOR ★

This parameter can be accessed if:

- [M/S Comm Mode] MSCM is not set to [No] NO, and
- [M/S Device Role] MSDT is set to [Slave] SLAVE.

Value range	Description
-32,767...32,767 Nm	The value depends on the drive ratings and [Torque Scaling] INRT setting. Factory setting: _

## [Motor Frequency] RFR

This parameter displays the estimated rotor frequency without motor slip.

Value range	Description
-3,276.7...3,276.7 Hz	Factory setting: 0.0 Hz

## [Motor Torque (Nm)] OTQN

Output torque value.

**NOTE:** The displayed value is always positive in motor and negative in generator mode whatever the direction.

Value range	Description
-32,767...32,767 Nm	The value depends on the drive ratings and [Torque Scaling] INRT setting. Factory setting: _

## [M/S System Display] MSR– Menu

### Access

[Display] → [M/S Parameters] → [M/S System Display]

### About This Menu

This menu present the master slave system related parameters.

This menu can be accessed if [M/S Comm Mode] MSCM is set to [MultiDrive Link] MDL.



## [M/S Local Speed Ref] MSSR ★

This parameter can be accessed if:

- [M/S Comm Mode] MSCM is not set to [No] NO, and
- [M/S Device ID] MSID is set to [Slave 1] SLV1.

Value range	Description
-599.0...599 Hz	Factory setting: _

## [M/S Local Torq Ref] FTOR ★

This parameter can be accessed if:

- [M/S Comm Mode] MSCM is not set to [No] NO, and
- [M/S Device ID] MSID is set to [Slave 1] SLV1.

Value range	Description
-32,767...32,767 Nm	Factory setting: _

## [M/S Device Selection] MSDN

This parameter allows to select the device parameters to be displayed.

Setting	Code / Value	Description
[Master]	MSTER	Master Factory setting
[Slave 1]	SLV1	Slave 1
[Slave 2]	SLV2	Slave 2
[Slave 3]	SLV3	Slave 3
[Slave 4]	SLV4	Slave 4
[Slave 5]	SLV5	Slave 5
[Slave 6]	SLV6	Slave 6
[Slave 7]	SLV7	Slave 7
[Slave 8]	SLV8	Slave 8
[Slave 9]	SLV9	Slave 9
[Slave 10]	SLV10	Slave 10

## [M/S Device Status] MSDS

Status of the device selected using [M/S Device Selection] MSDN.

Value	Code / Value	Description
[None]	NONE	Not configured
[M/S Not Ready]	NRDY	M/S not ready
[M/S Ready]	READY	M/S ready
[M/S Running]	RUN	M/S running
[M/S Warning]	ALARM	M/S warning

## [M/S Device Speed Ref] MSXS

Displays the local speed reference value of the device selected using [M/S Device Selection] MSDN.

Value range	Description
-599.0...599 Hz	Factory setting: _

## [M/S Device Torq Ref] FXT

Displays the local torque reference value of the device selected using [M/S Device Selection] MSDN.

Value range	Description
-32,767...32,767 Nm	The value depends on the drive ratings and [Torque Scaling] INRT setting. Factory setting: _

## [Motor parameters]

### [Motor parameters] MMO– Menu

#### Access

[Display] → [Motor parameters]

#### About This Menu

This menu shows the motor-related parameters.

The parameters available in this menu are in read-only mode, they cannot be configured.

### [Motor Speed] SPD

This parameter displays the estimated rotor speed without motor slip.

Value range	Description
0...65,535 rpm	Factory setting:

### [Signed Mech Speed] SPD1

#### *Signed mechanical speed*

Value range	Description
-100,000...100,000 rpm	Factory setting:–

### [Motor voltage] UOP

#### *Motor voltage.*

Value range	Description
0...[Nom Motor Voltage] UNS (step: 1 V)	Factory setting:–

### [Motor Power] OPR

Estimated output power in % (100% = nominal motor mechanical power).

Value range	Description
-300...300 % (step: 1 %)	Factory setting: –

### [Nom Motor torque] TQN

Computed nominal motor torque (+/- 2% tolerance).

In case of synchronous motors, this parameter is impacted by a modification of [Syn. EMF constant] PHS.

In case of asynchronous motors, this parameter is impacted by a modification of **[Magnetizing Current]**  $I_{DA}$  and the magnetic saturation parameters (i.e **[Flux curve coeff A]**  $ALFA$ , **[Flux curve coeff B]**  $BET0$ , **[Tangential Main Inductance]**  $L_{OA}$ ).

According to **[Nom Motor Tq Scaling]**  $TQNC$  setting, **[Nom Motor torque]**  $TQN$  parameter displays the value of the optimized torque **[Expert Motor Tq]**  $TQNO$  or the nameplate torque **[Plate Nom Motor Tq]**  $TQNP$ .

**NOTE:** A tune in rotation modifies the magnetic saturation parameters.

Setting	Description
0.01...65,535 Nm	The value depends on the drive ratings and <b>[Torque Scaling]</b> $INRT$ setting. <b>Factory setting:</b> Read only

## [Motor torque] $OTR$

Output torque value (100% = **[Nom Motor torque]**  $TQN$ ).

**NOTE:** The displayed value is always positive in motor mode and negative in generator mode whatever the direction.

Value range	Description
-300.0... 300.0 % (step: 0.1 %)	<b>Factory setting:</b> Read only

## [Motor Torque (Nm)] $OTQN$

**NOTE:** The displayed value is always positive in motor mode and negative in generator mode whatever the direction.

Value range	Description
-32,767...32,767 Nm	The value depends on the drive ratings and <b>[Torque Scaling]</b> $INRT$ setting. <b>Factory setting:</b> Read only

## [Motor Current] $LCR$

**Motor current** (estimation).

Value range	Description
0...2 $I_N^{(1)}$ (step: 0.01 A $^{(2)}$ )	The value depends on the drive ratings <b>Factory setting:</b> –
<p><sup>(1)</sup>: <math>I_N</math> corresponds to the rated drive current indicated in the Installation Manual and on the drive nameplate.</p> <p><sup>(2)</sup>: For drives with power range <math>\leq 15</math> kW. If the power range is between 18 and 160 kW (limits included), the step is 0.1 A else it is 1 A.</p>	

## [Motor Therm State] $THR$

The normal motor thermal state is 100 %, the **[Motor Overload]**  $OLF$  threshold is set to 118 %.

Value range	Description
0...200 % (step: 1 %)	<b>Factory setting:</b> –

## [Drive parameters]

### [Drive parameters] MPI– Menu

#### Access

[Display] → [Drive parameters]

#### About This Menu

This menu shows the drive-related parameters.

### [AIV1 Image input] AIV1

This parameter is read-only. It enables to display the speed reference applied to the motor via the fieldbus channel.

Setting	Description
-10,000...10,000 <sup>(1)</sup>	<b>Factory setting:</b> –
1): range according to [AIV1 Type] AV1T.	

### [Pre-Ramp Ref Freq] FRH

This parameter is read-only. It enables to display the reference frequency applied to the motor, regardless of which channel for reference value has been selected.

Value range	Description
-599.0...599.0 Hz	<b>Factory setting:</b> 0 Hz

### [Ref Frequency] LFR

This parameter only appears if the function has been enabled. It is used to change the reference frequency from the remote control. OK does not have to be pressed to enable a change of reference.

Setting ( )	Description
-599.0...599.0 Hz	<b>Factory setting:</b> –

### [Torque ref.] LTR ★

This parameter only appears if the function has been enabled. It is used to change the torque reference value from the remote control. OK does not have to be pressed to enable a change of reference value.

This parameter can be accessed if:

- [Trq/spd switching] TSS is not set to [Not Assigned] NO, and
- [M/S Device Role] MSDT is set to [Slave] SLAVE, and

- **[M/S Control Type] MSCT** is set to:
  - **[Torque Direct] TRQD**, or
  - **[Torque Reverse] TRQR**, or
  - **[Torque Custom] TRQC**.

Setting ( )	Description
-300.0...300.0%	Factory setting: –

## [Torque reference] TRR ★

### *Torque reference before ramp.*

This parameter displays the actual value of the torque reference after the **[Torque ratio] TRT** and the **[Torque Ref Offset] TQOP** have been applied.

This parameter can be accessed if:

- **[Trq/spd switching] TSS** is not set to **[Not Assigned] NO**.
- **[M/S Device Role] MSDT** is set to **[Slave] SLAVE**, and
- **[M/S Control Type] MSCT** is set to:
  - **[Torque Direct] TRQD**, or
  - **[Torque Reverse] TRQR**, or
  - **[Torque Custom] TRQC**.

Value range	Description
-3,276.7...3,276.7 %	Factory setting: –

## [Motor Frequency] RFR

This parameter displays the estimated rotor frequency without motor slip.

Value range	Description
-3,276.7...3,276.7 Hz	Factory setting: 0.0 Hz

## [Stator Frequency] SFQ ★

This parameter can be accessed if **[Access Level] LAC** is set to **[Expert] EPR**.

Value range ( )	Description
<b>[No Freq Applied] NO</b> ...599.0 Hz	Factory setting: –

## [Rotor Frequency] RFQ ★

This parameter displays the estimated rotor frequency with motor slip.

This parameter can be accessed if **[Access Level] LAC** is set to **[Expert] EPR**.

Value range ( )	Description
<b>[No Freq Applied] NO</b> ...599.0 Hz	Factory setting: –

**[Measured output fr.] MMF** ★

This parameter can be accessed only if the encoder module has been inserted, and the available selections depend on the type of encoder module used.

Value range ( )	Description
-3,276.7...3,276.7 Hz	<b>Factory setting:</b> –

**[Multiplying coeff.] MFR** ★

This parameter can be accessed if **[Ref Freq 2 Multiply] MA2**, **[Ref Freq 3 Multiply] MA3** has been assigned.

Setting ( )	Description
0...100%	<b>Factory setting:</b> –

**[Measured Freq] FQS** ★

*Pulse input measured frequency.*

This parameter can be accessed if **[Frequency meter] FQF** is not set to **[Not Configured] NO**.

Value range ( )	Description
0...30 KHz	<b>Factory setting:</b> –

**[Mains Voltage] ULN**

Mains voltage based on AC bus measurement, motor running or stopped.

Value range	Description
1.0...6,553.5 Vac	<b>[No meas.] ULNUNK</b> is displayed if no value is measured. <b>Factory setting:</b> –

**[Mains voltage phase 1-2] UL1**

Value range	Description
-3,276.7...3,276.7 Vac	<b>[No meas.] ULNUNK</b> is displayed if no value is measured. <b>Factory setting:</b> –

**[Mains voltage phase 2-3] UL2**

Value range	Description
-3,276.7...3,276.7 Vac	<b>[No meas.] ULNUNK</b> is displayed if no value is measured. <b>Factory setting:</b> –

**[Mains voltage phase 3-1] UL3**

Value range	Description
-3,276.7...3,276.7 Vac	<b>[No meas.]</b> ULNUNK is displayed if no value is measured. <b>Factory setting:</b> –

**[Mains Frequency] FAC**

Value range	Description
0.0...999.9 Hz	<b>Factory setting:</b> –

**[DC bus voltage] VBUS****DC bus voltage.**

Value range	Description
0...6,553.5 Vdc	<b>[No meas.]</b> ULNUNK is displayed if no value is measured. <b>Factory setting:</b> –

**[Drive Therm State] THD**

The normal drive thermal state is 100%, the **[Device Overheating] OHF** threshold is set to 118%

Value range	Description
0...200%	<b>Factory setting:</b> –

**[Used param. set] CFP3 ★**

Configuration parameter status (can be accessed if parameter switching function has been enabled).

Value range	Code / Value	Description
<b>[None]</b>	NO	Not assigned
<b>[Set No.1]</b>	CFP1	Parameter set 1 active
<b>[Set No.2]</b>	CFP2	Parameter set 2 active
<b>[Set No.3]</b>	CFP3	Parameter set 3 active

**[Config. active] CNF3****Active configuration.**

Value range	Code / Value	Description
<b>[In progress]</b>	NO	Transitory state
<b>[Config. No.0]</b>	CNF0	Configuration 0 active
<b>[Config. No.1]</b>	CNF1	Configuration 1 active
<b>[Config. No.2]</b>	CNF2	Configuration 2 active
<b>[Config. No.3]</b>	CNF3	Configuration 3 active



## [Thermal monitoring]

### [Thermal Monitoring] TPM– Menu

#### Access

[Display] → [Thermal Monitoring]

#### About This Menu

The content of this menu can be accessed if [Thermal monitoring] TPP– function has been activated , page 147.

This menu shows the present thermal value measured via analog inputs used.

**NOTE:** An encoder can also be used with the thermal monitoring function.

#### [AI1 Th Value] TH1V, [AI3 Th Value] TH3V, [AI4 Th Value] TH4V, [AI5 Th Value] TH5V ★

AI1 thermal value, AI3 thermal value, AI4 thermal value and AI5 thermal value.

**NOTE:** AI4 and AI5 can only be accessed if the I/O extension option module (VW3A3203) has been inserted.

Value range	Description
-15.0...200.0 °C (step: 0.1 °C)	The unit depends on the setting of [Temperature unit] SUTP).
5.0...392.0 °F (step: 0.1 °F)	<b>Factory setting:</b> Read-only parameter.

#### [Enc Th Value] THEV ★

*Encoder thermal value.*

Value range	Description
-15...200 °C (step: 0.1 °C)	The unit depends on the setting of [Temperature unit] SUTP).
5.0...392.0 °F (step: 0.1 °F)	<b>Factory setting:</b> Read-only parameter.

## [PID display]

### [PID display] PIC- Menu

#### Access

[Display] → [PID display]

#### About This Menu

**NOTE:** This function cannot be used with some other functions.

Following parameters can be accessed if [PID feedback Assign] PIF is not set to [Not Configured] NO.

#### [Internal PID ref] RPI ★

*Internal PID reference.*

Setting ( )	Description
0...32,767	Factory setting: 150

#### [PID reference] RPC ★

*PID reference.*

Value range	Description
0...65,535	Factory setting: 0

#### [PID feedback] RPF ★

*PID feedback.*

Value range	Description
0...65,535	Factory setting: 0

#### [PID Error] RPE ★

*PID error.*

Value range	Description
-32,767...32,767	Factory setting: -

#### [PID Output] RPO ★

*PID output.*

Value range	Description
[PID Min Output] POL...[PID Max Output] POH	Factory setting: _

## [Counter Management]

### [Counter Management] ELT- Menu

#### Access

[Display] → [Counter Management]

#### About This Menu

This menu shows the drive and motor-related counters.

#### [Motor Run Time] RTHH

Run elapsed time display (resettable) in 0.1 hours (length of time the motor has been switched on).

Setting	Description
0.0...119,304.5 h	Factory setting: _

#### [Power-on time] PTHH

Power-on time (resettable) or counter can be set to 0 by using the [Counter Reset] RPR parameter.

Value range	Description
0.0...119,304.5 h	Factory setting: _

#### [Fan Operation Time] FPBT

As soon as [Fan Operation Time] FPBT reach the predefined value of 45,000 hours, a warning [Fan Counter Warning] FCTA is triggered.

[Fan Operation Time] FPBT counter can be set to 0 by using the [Counter Reset] RPR parameter.

Value range	Description
0...500,000 h	Factory setting: Read Only

#### [Nb Of Starts] NSM

Number of motor starts (resettable) or counter can be set to 0 by using the [Counter Reset] RPR parameter.

Value range	Description
0...4,294,967,295	Factory setting: _

#### [Counter Reset] RPR

*Counter reset.*

Setting ( )	Code / Value	Description
[No]	NO	No <b>Factory setting</b>
[Reset Run Time]	RTH	Run time reset
[Reset Power On Time]	PTH	Power ON time reset
[Reset Fan Counter]	FTH	Reset fan counter
[Reset Start Count]	NSM	Clear number of motor starts

## [Other State]

### [Other State] SST- Menu

#### Access

[Display] → [Other State]

#### About This Menu

List of secondary states.

#### List

[Sleep Active] *SLM*  
[Modbus Com Inter.] *SLF1*  
[set 1 active] *CFP1*  
[set 2 active] *CFP2*  
[set 3 active] *CFP3*  
[Internal Error 22] *INFM*  
[Automatic restart] *AUTO*  
[DC charged] *DBL*  
[Fast stop Active] *FST*  
[Fallback Frequency] *FRF*  
[Speed Maintained] *RLS*  
[Type of stop] *STT*  
[Encoder Config] *ICC*  
[In braking] *BRS*  
[DC Bus Ripple Warn] *DCRW*  
[Pwr Backup Warn] *RFTA*  
[Ref Freq Warning] *SRA*  
[Forward] *MFRD*  
[Reverse] *MRRS*  
[In motor fluxing] *FLX*  
[Autotuning] *TUN*

## [I/O Map]

### [I/O Map] IOM- Menu

#### Access

[Display] → [I/O Map]

#### About this Menu

This menu shows information about the inputs and the outputs of the drive such as: the function assigned, the configuration and the present value or state.

The information is separated in different categories/menus:

- **[Digital Input Map] LIA-**: The mapping of the digital inputs,
- **[Analog inputs image] AIA-**: The image of the analog inputs,
- **[Digital Output Map] LOA-**: The mapping of the digital outputs and relays,
- **[Analog outputs image] AOA-**: The image of the analog outputs and the Pulse Train Output (PTO),
- **[Freq. signal image] FSI-**: The image of the pulse inputs,

The parameters available in this menu are in read-only mode, they cannot be configured.

For more information on the inputs/outputs configuration, refer to the submenus in **[Complete settings] → [Input/Output]**.

### [Digital Input Map] LIA-

This menu is used to display the state of digital inputs. Use the touch wheel to scroll through the digital inputs:

- STO\_A and STO\_B: inputs of the safety STO function. For more information, refer to the embedded safety function manual of the drive.
- Digital inputs DI1 to DI8 of the drive. On drives with a power equal to or lower than 22 kW, DI6 and DI7 are respectfully DQ1 and DQ2 used as Digital Input. DI8 input can only be accessed on drives with a power greater than 22kW.
- Optional digital inputs DI11 to DI16 if VW3A3203 Extended I/O module has been inserted.

On the Display Terminal, click the digital input to see all the functions that are assigned to the digital input in order to verify the compatibility with the multiple assignments (low level assignment and high level assignment). If no functions have been assigned, **[No] NO** is displayed.

For more information on the digital inputs refer to **[Complete settings] → [Input/Output] → [DI/DQ]**.

### [Analog inputs image] AIA-

This menu is used to display the value of analog inputs. Use the touch wheel to scroll through the analog inputs:

- **[AI1] AI1C** to **[AI3] AI3C**: Analog inputs AI1 to AI3 of the drive. AI3 can only be accessed on drives with a power greater than 22kW.
- **[AI4] AI4C** and **[AI5] AI5C**: Optional analog inputs AI4 and AI5 if VW3A3203 Extended I/O module has been inserted,

- **[Enc Resistor Value]** **THER**: The resistor value (in Ohm) linked to the thermal monitoring function estimated via the encoder. This parameter is visible if an encoder is present and if **[Enc Therm Sensor Type]** **THER** is set to a value different from **[None]** **NONE**.

The physical value of the analog input AIx shown in this menu corresponds to the parameter **[AIx]** **AIxC**. The range and the unit depend on the customer configuration.

On the Display Terminal, click the analog input AIx (with 'x' from 1 to 5) to display:

- **[AIx assignment]** **AIxA**: all the functions associated with the analog input in order to verify, for example, compatibility problems with the multiple assignments,
- The minimum and maximum values according to the configured type **[AIx Type]** **AIxT**:
  - **[AIx Min. Value]** **UIIx** and **[AIx Max Value]** **UIHx** with **[Voltage]** **10U** type,
  - **[AIx Min. Value]** **CRLx** and **[AIx Max Value]** **CRHx** with **[Current]** **0A** type.
- The configured value of the interference filtering: **[AIx filter]** **AIxF**.

For more information on the analog inputs refer to **[Complete settings]** → **[Input/Output]** → **[AI/AQ]**.

## [Digital Output Map] LOA–

This menu is used to display the state of relays and digital outputs. Use the touch wheel to scroll through them:

- R1 to R3: the relays of the drive. R3 can only be accessed on drives with a power greater than 22kW.
- R4 to R6: the optional relays if VW3A3204 Extended relay module has been inserted.
- DQ1: the digital output DQ for drives with a power greater than 22kW.
- DQ1 and DQ2: the two digital outputs (DO1 and DO2) for drives with a power lower than 30kW,
- DQ11 and DQ12: the optional digital output if VW3A3203 Extended I/O module has been inserted.

### NOTE:

- On drive with power equal to or lower than 22 kW, depending on the wiring, DO1 and DO2 can also be used as digital input (DI6 and DI7),
- On drive with power greater than 22 kW, DQ can also be used as a Pulse Train Output depending on the configuration of PTO - DQ Switch (SW2). Refer to the installation manual.

On the Display Terminal, click the relay or the digital output to display:

- The function assigned to the digital output or the relay. If no functions have been assigned, **[No]** **NO** is displayed,
- The delay time,
- The active level (high or low),
- The holding time.

For more information on the configuration of the digital outputs and the relays refer to **[Complete settings]** → **[Input/Output]**.

## [Analog outputs image] AOA–

This menu is used to visualize the value of analog outputs and the value of the Pulse Train Output (PTO). Use the touch wheel to scroll through the outputs **[AQ1]** **AO1C**, **[AQ2]** **AO2C** and **[PTO Frequency]** **PTOC**.

The physical value of the analog output AQx displayed in this menu corresponds to the parameter **[AQx] AOxC**. The range and the unit depend on the customer configuration.

On the Display Terminal , click the analog outputs to display:

- **[AQx assignment] AOx**: the function associated with the analog output in order to verify, for example, compatibility problems with the multiple assignments,
- The minimum and maximum values according to the configured type **[AQx Type] AOxT**:
  - **[AQx min Output] UOLx** and **[AQx max Output] UOHx** with **[Voltage] 10U** type,
  - **[AQx min output] AOLx** and **[AQx max output] AOHx** with **[Current] 0A** type.
- **[Scaling AQx min] ASLx** (respectively **[Scaling AQx max] ASHx**): The scaling of the lower limit (respectively upper limit) of the assigned parameter, as a percentage of the minimum (respectively maximum) possible variation.
- The configured value of the interference filtering: **[AQx Filter] AOxF**.

The PTO physical value (parameter **[PTO Frequency] PTOC**) depends on the customer configuration. The range is 0.00...655.35 kHz.

On the Display Terminal , click the PTO to display:

- **[PTO Assign] PTO**: the function associated with the Pulse Train Output (PTO). If no functions have been assigned, **[No] NO** is displayed.
- **[PTO Max Output Freq] PTOH**: the maximum output frequency of the PTO. The value is between 1.00 and 30.00 kHz. By default, the value is 4.00 kHz. This information is accessible if the PTO is assigned (**[PTO Assign] PTO** is set to a value different from **[No] NO** and **[DQ1] DO1**).

**NOTE:** **[PTO Frequency] PTOC** is accessible only for drives with power greater than 22 kW. Refer to the installation manual to configure DQ (DQ+ and DQ-) as pulse train output PTO.

For more information (such as the configuration), refer to **[Complete settings] → [Input/Output] → [AI/AQ]**.

## [Freq. signal image] FSI–

This menu is used to visualize the frequency of configured pulse inputs. Use the touch wheel to scroll through the pulse inputs:

- **[DI7 Frequency measured] PFC7** and **[DI8 Frequency measured] PFC8** (accessible on drives with power greater than 22 kW). The displayed value corresponds to the parameter **[Dix Frequency measured] PFCx**. The unit is in 0.01 Hz and the range is 0...42,949,672.95 Hz.
- **[PTI Freq Measured] PTIF** (accessible on drives with power lower than 30 kW). The displayed value in this menu corresponds to the parameter **[PTI Freq Measured] PTIF**. The unit is in 0.01 Hz and the range is -21,474,836.47...21,474,836.47 Hz.
- **[Encoder Pulse Freq] ECFR**: Encoder pulse frequency if the encoder (or the embedded encoder) is used as a pulse input speed reference (**[Encoder usage] ENU** or **[Emb Enc Usage] EENU** is set to **[Speed Reference] PGR**) and a pulse train generator is connected to the encoder inputs (**[Reference Type] PGA** is set to **[Frequency Generator] PTG**). The unit is 0.01 kHz and the range is -21,474,836.47...21,474,836.47 kHz.
- **[Encoder Frequency] EIFC**: Encoder frequency if the encoder (or the embedded encoder) is used as a speed reference (**[Encoder usage] ENU** or **[Emb Enc Usage] EENU** is set to **[Speed Reference] PGR**) and a standard encoder is used (**[Reference Type] PGA** is set to **[Encoder] ENC**). The unit is 0.01 Hz and the range is -21,474,836.47...21,474,836.47 Hz.

On the Display Terminal , click a pulse input to display information such as the function assigned to the pulse input, the low and high configured frequency and the interference filtering pulse input cut-off time of the low-filter.



**NOTE:** There is no such information for the encoder frequency and the encoder pulse frequency.

For more information (such as the configuration), refer to **[Complete settings] → [Input/Output]**.

## [Communication map]

### [Communication map] CMM– Menu

#### Access

[Display] → [Communication map]

#### About This Menu

This menu gives access to monitoring parameters linked to:

- The sources of command and references,
- The command and state registers,
- Fieldbus communication.

For more information about the command and reference refer to **[Command and Reference]** CRP– Menu , page 187 .

Topic	Description	Related manual
<b>[Command Channel]</b> CMDC parameter	This monitoring parameter shows the current active command channel. For more information , page 99.	-
<b>[Cmd Register]</b> CMD parameter	This parameter shows the current value of the command register in hexadecimal. For more information see below , page 99.	-
<b>[Ref Freq Channel]</b> RFCC parameter	This monitoring parameter shows the current active reference channel. For more information see below , page 100.	-
<b>[Pre-Ramp Ref Freq]</b> FRH parameter	This monitoring parameter shows the current value of the Frequency reference before ramp. For more information see below , page 101.	-
<b>CIA402 [Status Register]</b> ETA parameter	This monitoring parameter shows the current value of the CIA402 state register in hexadecimal. For more information , page 101.	-
<b>[Modbus network diag]</b> MND– Menu	This menu is related to the Modbus serial communication port on the bottom of the control block.	NVE61654
<b>[Modbus HMI Diag]</b> MDH– Menu	This menu is related to the Modbus serial communication port on the front of the control block. It is used by default for the Display Terminal .	–
<b>[Ethernet Emb Diag]</b> MPE– Menu	This menu is related to the Ethernet Embedded communication.	NVE61653
<b>[DEVICENET DIAG]</b> DVN– Menu	This menu is related to the DeviceNet fieldbus module (VW3A3609).	NVE61683
<b>[PROFIBUS DIAG]</b> PRB– Menu	This menu is related to the Profibus DP fieldbus module (VW3A3607)	NVE61656
<b>[PROFINET DIAG]</b> PRN– Menu	This menu is related to the Profinet fieldbus module (VW3A3627).	NVE61678
<b>[EtherCAT Module]</b> ETC– Menu	This menu is related to the EtherCAT fieldbus module (VW3A3601).	NVE61686
<b>[POWERLINK DIAG]</b> PWL– Menu	This menu is related to the POWERLINK fieldbus module (VW3A3619).	NVE61681

Topic	Description	Related manual
[Command word image] CWI-- Menu	<p>This menu contains command word images according to the communication sources. The description is similar to [Cmd Register] CMD.</p> <ul style="list-style-type: none"> <li>[Modbus Cmd] CMD1</li> <li>[CANopen Cmd] CMD2</li> <li>[COM. Module cmd.] CMD3 (for other fieldbus such as Profibus, etc.)</li> <li>[Ethernet Emdb cmd.] CMD5</li> </ul>	-
[Freq. ref. word map] RWI-- Menu	<p>This menu contains frequency reference images according to the communication sources. The description is similar to [Ref Frequency] LFR.</p> <ul style="list-style-type: none"> <li>[Modbus Ref Freq] LFR1</li> <li>[CAN Ref Freq] LFR2</li> <li>[Com Module Ref Freq] LFR3 (for other fieldbus such as Profibus, etc.)</li> <li>[Ethernet Emdb Ref Freq] LFR5</li> </ul> <p><b>NOTE:</b> the unit depends on the bit 9 of CMI: the internal command register. Refer to the communication parameters for more information.</p>	-
[CANopen map] CNM-- Menu	<p>This menu is related to the CANopen module (VW3A3608, VW3A3618, VW3A3628).</p>	NVE61655

## [Command Channel] CMDC

Read only parameter. This monitoring parameter shows the current active command channel.

Value range	Code / Value	Description
[Terminal]	TER	Command via terminal block <b>Factory Setting</b>
[HMI]	LCC	Command via Display Terminal
[Ref. Freq-Modbus]	MDB	Command via Modbus
[Ref. Freq-CANopen]	CAN	Command via CANopen if a CANopen module has been inserted
[Ref. Freq-Com. Module]	NET	Command via fieldbus module if a fieldbus module has been inserted
[Embedded Ethernet]	ETH	Command via Embedded Ethernet <b>NOTE:</b> This selection can be accessed on ATV340***N4E drives.
[PC tool]	PWS	Command via commissioning software.

## [Cmd Register] CMD

Command register (depending on the selected profile using [Control Mode] CHCF and depending on the type of wire control using [2/3-Wire Control] TCC).

This parameter shows the current value of the command register in hexadecimal.

Bit	Description, Value		
	CiA402 profile (CHCF = SIM or SEP)	2-wire I/O profile (CHCF = IO and TCC=2C)	3-wire transition I/O profile (CHCF=IO, TCC=3C)
0	Set to 1: "Switch on" /Contactor command	Forward (on state) command: 0: No forward command 1: Forward command  <b>NOTE:</b> The assignment of bit 0 cannot be modified. It corresponds to the assignment of the terminals. It can be switched. Bit 0 Cd00 is only active if the channel of this control word is active.	Stop (run authorization): 0: Stop 1: Run is authorized on a forward or reverse command  <b>NOTE:</b> The assignment of bits 0 and 1 cannot be modified. It corresponds to the assignment of the terminals. It can be switched. Bits 0 Cd00 and 1 Cd01 are only active if the channel of this control word is active.
1	Set to 0: "Disable voltage" /Authorization to supply AC power	Can be assigned to commands	Forward (on 0 to 1 rising edge) command
2	Set to 0: "Quick stop"		Can be assigned to commands
3	Set to 1: "Enable operation" /Run command		
4 to 6	Reserved (=0)		
7	"Fault reset" acknowledgment active on 0 to 1 rising edge		
8	Set to 1: Halt stop according to the [Type of stop] STT parameter without leaving the operation enabled state		
9 and 10	Reserved (=0)		
11 to 15	Can be assigned to commands		

## [Ref Freq Channel] RFCC

Read-only parameter.

This monitoring parameter shows the current active reference channel.

Value range	Code / Value	Description
[Terminal]	TER	Reference via terminal block  <b>Factory Setting</b>
[HMI]	LCC	Reference via Display Terminal
[Ref. Freq-Modbus]	MDB	Reference via Modbus
[Ref. Freq-CANopen]	CAN	Reference via CANopen if a CANopen module has been inserted
[Ref. Freq-Com. Module]	NET	Reference via fieldbus module if a fieldbus module has been inserted
[Embedded Ethernet]	ETH	Reference via Embedded Ethernet  <b>NOTE:</b> This selection can be accessed on ATV340•••N4E drives.
[PC tool]	PWS	Reference via commissioning software.

## [Pre-Ramp Ref Freq] FRH

Read-only parameter.

It enables to display the reference frequency (before ramp) applied to the motor, regardless of which channel for reference value has been selected (see [Command and Reference] CRP– Menu, page 187)

Value range	Description
-599.0...599.0 Hz	The value cannot go higher than [High Speed] HSP and lower than $-1 \times$ [High Speed] HSP.

## CIA402 [Status Register] ETA

With CIA402 profile, the combination of bits 0, 1, 2, 4, 5 and 6 defines the state in the DSP 402 state chart (see the annex).

The value is identical in the CiA402 profile and the I/O profile. In the I/O profile, the description of the values is simplified and does not refer to the CiA402 (Drivecom) state chart.

Bit	Description	
	CiA402 profile (CHCF = SIM or SEP)	I/O profile (CHCF = IO)
0	"Ready to switch on", 1 = awaiting power section line supply	Reserved (= 0 or 1)
1	"Switched on", ready	0: Not ready / 1: Ready
2	"Operation enabled", running	Running: 0: The drive does not start if a reference other than zero is applied 1: Running, if a reference other than zero is applied, the drive can start
3	Operating detected error state: 0: Inactive / 1: Active	Operating detected error state: 0: Inactive / 1: Active
4	"Voltage enabled", 1=power stage supply present  NOTE: When the drive is powered by the power stage only, this bit is always at 1.	Power stage supply (1=present / 0=unavailable)  NOTE: When the drive is powered by the power stage only, this bit is always at 1.
5	Quick stop (0 = active)	Reserved (= 1)
6	"Switched on disabled", power stage supply locked	Reserved (= 0 or 1)
7	1: Warning	1: Warning
8	Reserved (= 0)	Reserved (= 0)
9	Remote: 0: Command or reference via the Graphic Display Terminal 1: Command or reference via the network	
10	1: The targeted reference has been reached  NOTE: When the drive is in speed mode, this is the speed reference.	1: The reference has been reached
11	"Internal limit active": 0: The reference is within the limits 1: The reference is not within the limits  NOTE: When the drive is in speed mode, the limits are defined by LSP and HSP parameters.	Reference outside limits: 0: The reference is within the limits 1: The reference is not within the limits  NOTE: When the drive is in speed mode, the limits are defined by LSP and HSP parameters.

Bit	Description	
	CiA402 profile (CHCF = SIM or SEP)	I/O profile (CHCF = IO)
12	Reserved (=0)	Reserved (= 0)
13	Reserved (=0)	Reserved (= 0)
14	"Stop key", STOP via stop key: 0: STOP key not pressed 1: Stop triggered by the STOP key	
15	"Direction", direction of rotation: 0: Forward rotation at output 1: Reverse rotation at output	

## [Data logging]

### [Distributed logging] DLO- Menu

#### Access

[Display] → [Data logging] → [Distributed logging]

#### About This Menu

This menu is used to store data following specific parameters.

The distributed logging function allows to log up to four parameter distributions at the same time. Each parameter storage is synchronized with the same sample time.

The result of this function gives the possibility to extract a bar graph with 10 bars (every 10% of the defined maximum value) to visualize the distribution for each of the four selected parameters.

**NOTE:** Any modification of the data logging function configuration clears the data previously stored.

This function aims at extracting samples of data to store them. When available, these samples can be uploaded by other tools (SoMove and/or Webserver). Data logging meets the need to record and store data over time.

The drive can store the following data:

Type of [Data logging]	Description	[Data logging] storage: Automatic/Manual	Access
Drive identification	Drive identification data	Automatic, in [Dashboard] DSH- menu	SoMove Webserver
Even warning logging	Warning logging	Automatic, in [Dashboard] DSH- menu	SoMove Webserver
Even error logging	Error logging	Automatic, in [Dashboard] DSH- menu	SoMove Webserver
Distribution logging	4 Distribution data	Manual	Webserver
Energy logging	1 Energy logging data	Automatic, in [Dashboard] DSH- menu	SoMove Webserver

#### Activation

To activate [Distributed logging] DLO-:

- Select 1 to 4 data to store with [Log dstrb prm select] LDP-
- Set [Log Distrib State] LDEN to [Start] START

The logging starts as soon as the motor is running.

To stop logging, set [Log Distrib State] LDEN to [Stop] STOP.

#### [Log Distrib State] LDEN

*Logging Distribution State.*

Setting ( )	Code / Value	Description
[Stop]	STOP	Distribution logging disabled <b>Factory setting</b>
[Start]	START	Distribution logs only when the motor is started
[Always]	ALWAYS	Distribution logs all the time
[Reset]	RESET	Distribution logging reset (configuration, data)
[Clear]	CLEAR	Clear distribution data
[Error]	ERROR	An error has been detected during distribution logging

## [Log dstrb prm select] LDP- Menu

### Access

[Display] → [Data logging] → [Distributed logging] → [Log dstrb prm select]

### About This Menu

This menu allows you to select up to 4 parameters for data logging. The peak value for each parameter is also stored.

## [Log Distrib. Data 1] LDD1 to [Log Distrib. Data 4] LDD4

*Log Distribution Data 1 to Log Distribution Data 4.*

Setting ( )	Code / Value	Description
[Distrib. Log. DISABLE]	NO	Distribution logging disable <b>Factory setting</b>
[Motor Frequency]	RFR	Motor frequency
[Motor Current]	LCR	Motor current
[Motor Speed]	SPD	Motor speed
[Motor Voltage]	UOP	Motor voltage
[Motor Mech. Power]	OPRW	Motor mechanical power
[Input Elec. Power]	IPRW	Input electrical power
[Output Elec. Power]	EPRW	Output electrical power
[Motor Torque]	OTR	Motor torque
[Mains Voltage]	ULN	Mains voltage
[DC BUS Voltage]	VBUS	DC BUS voltage
[AI1 Th Value]	TH1V	Thermal sensor AI1
[AI3 Th Value]	TH3V	Thermal sensor AI3
[AI4 Th Value]	TH4V	Thermal sensor AI4



Setting (↻)	Code / Value	Description
[AI5 Th Value]	TH5V	Thermal sensor AI5
[Drive Thermal State]	THD	Drive thermal state
[Motor Thermal State]	THR	Motor thermal state
[DBR Thermal State]	THB	Braking thermal state

## [Distributed logging] DLO- Menu

### Access

[Display] → [Data logging] → [Distributed logging]

### About This Menu

**NOTE:** If a log data exceeds the user defined maximum values for log distribution data, this value is not stored in the log distribution.

## [Log Distrib Spl Time] LDST

*Logging Distribution Sample time.*

Setting (↻)	Code / Value	Description
[200 ms]	200MS	200 ms
[1 second]	1S	1 s <b>Factory setting</b>
[2 seconds]	2S	2 s
[5 seconds]	5S	5 s

## [Dist Max Val 1] LDM1 to [Dist Max Val 4] LDM4

*Distribution data max value 1 to Distribution data max value 4.*

The defined maximum value corresponds to 100 % of the stored data. Adjust the maximum value to adapt the full range of the logging distribution data.

Setting (↻)	Description
10...65,535	<b>Factory setting:</b> 65,535 (the setting can be adapted when modifying [Log Distrib. Data 1] LDD1...[Log Distrib. Data 4] LDD4.

# [Complete settings] CST–

## What's in This Chapter

[Motor parameters] MPA– Menu .....	107
[Define system units] .....	185
[Command and Reference] CRP– Menu .....	187
[Master/Slave] .....	204
[Hoisting Functions] .....	232
[Hoisting monitoring] .....	264
[Machine Functions] .....	266
[Generic functions] - [Speed Limits] .....	279
[Generic functions] - [Ramp] .....	282
[Generic functions] - [Ramp switching] .....	286
[Generic functions] - [Stop configuration] .....	288
[Generic functions] - [Auto DC injection] .....	295
[Generic functions] - [Ref. operations] .....	299
[Generic functions] - [Preset speeds] .....	301
[Generic functions] - [+/- speed] .....	304
[Generic functions] - [+/- speed around ref] .....	307
[Generic functions] - [Jump frequency] .....	310
[Generic functions] - [PID controller] .....	312
[Generic functions] - [Threshold reached] .....	333
[Generic functions] - [Mains contactor command] .....	336
[Generic functions] - [Output contactor cmd] .....	339
[Generic functions] - [Reverse disable] .....	343
[Generic functions] - [Torque limitation] .....	344
[Generic functions] - [2nd current limit.] .....	349
[Generic functions] - [Jog] .....	351
[Generic functions] - [High Speed Switching] .....	353
[Generic functions] - [Memo reference frequency] .....	355
[Generic functions] - [Brake logic control] .....	356
[Generic functions] - [Limit switches] .....	357
[Generic functions] - [Positioning by sensors] .....	359
[Generic functions] - [Torque control] .....	368
[Generic functions] - [Parameters switching] .....	376
[Generic functions] - [Stop after speed timeout] .....	381
[Generic functions] - [DC bus supply] .....	383
[Generic functions] - [Multimotors config] .....	385
[Generic functions] - [24V Supply Output] .....	389
[Generic functions] - [External weight meas.] .....	390
[Generic functions] - [Power Backup] .....	393
[Generic monitoring] .....	396
[Input/Output] - [I/O assignment] .....	407
[Input/Output] - [DI/DQ] .....	413
[Input/Output] - [AI/AQ] .....	432
[Input/Output] - [Relay] .....	450
[Encoder configuration] .....	459
[Embedded Encoder] .....	467
[Error/Warning handling] .....	471
[Maintenance] .....	515

## Introduction



[Complete settings] CST– menu presents all the settings related to drive functions for:

- Motor and drive configuration
- Application functions
- Monitoring functions

# [Motor parameters] MPA- Menu

## [Motor parameters] MPA- Menu

### Access

[Complete settings] → [Motor parameters]

### About This Menu

High rating or Normal rating depend of the machine cycle.

If high rating is selected, drive current limitation is extended to 1.8 x In and maximum values of motor parameters linked to current and/or power are reduced. When switching from one to another selection, all the related parameters are set to their factory setting values.

In any case, the maximum current of the drive does not change. Setting the drive to high rating mode decreases the nominal values for the motor parameters. It means that for the same motor, an oversized drive is required in high rating mode.

### ATV340 Motor Control Types

ATV340 drive embeds 8 motor control types which covers all the use cases depending of the application.

The following table shows the Motor Control types selection depending of the application needs:

Control	Motor Type	[Motor control type] CTT selection (2)	Description
Open-Loop	Asynchronous motor	[SVC V] VVC	Voltage vector control law with slip compensation
		[U/F VC 5pts] UF5	5 points U/F vector control law
		[Energy Sav.] NLD	Energy saving control law
	Synchronous motor	[Sync. mot.] SYN	Permanent magnet control law
		[SYN_U VC] SYNU	Permanent magnet control law for variable torque applications
Reluctance motor	[Reluctance Motor] SRVC	Reluctance motor control law	
Closed-Loop (1)	Asynchronous motor	[FVC] FVC	Current vector control law
	Synchronous motor	[Sync.CL] FSY	Permanent magnet control law

(1) For these applications, an encoder must be present and configured.  
 (2) **NOTE:** Modifying this parameter resets the parameter [Motor fluxing] FLU.

### Parameters List for Asynchronous Motors

The following table shows the minimum parameters list that needs to be configured for asynchronous motors depending of [Motor control type] CTT selection:

**NOTE:** After setting these parameters, it is recommended to perform an **[Autotuning]** TUN to optimize the performances. If one of these parameters is modified, autotuning must be re-performed.

Parameters	[SVC V] VVC	[FVC] FVC	[U/F VC 5pts] UF5	[Energy Sav.] NLD
[Motor Standard] BFR	✓	✓	✓	✓
[Nominal Motor Power] NPR or [Motor 1 Cosinus Phi] COS (1)	✓	✓	✓	✓
[Nom Motor Voltage] UNS	✓	✓	✓	✓
[Nom Motor Current] NCR	✓	✓	✓	✓
[Nominal Motor Freq] FRS	✓	✓	✓	✓
[Nominal Motor Speed] NSP	✓	✓	✓	✓
[Encoder Type] UECP or [Emb Enc Type] EECP	–	✓ (2)	–	–
[Encoder supply volt.] UECV or [Emb Enc Supply Volt] EECV	–	✓ (2)	–	–
(1) Depending on [Motor param choice] MPC.				
(2) Encoder settings depend of the encoder used on the application (see [Encoder configuration] IEN– and [Embedded Encoder] IEE–).				

## Parameters List for Synchronous or Reluctance Motors

The following table shows the minimum parameters list that needs to be configured for synchronous or reluctance motors depending of [Motor control type] CTT selection:

**NOTE:** After setting these parameters, it is recommended to perform an **[Autotuning]** TUN to optimize the performances. If one of these parameters is modified, autotuning must be re-performed.

Parameters	[Sync. mot.] SYN	[Sync.CL] FSY	[SYN_U VC] SYNU	[Reluctance Motor] SRVC
[Sync Nominal I] NCRS	✓	✓	✓	✓
[Nom SyncMotor Speed] NSPS	✓	✓	✓	✓
[Nom Motor torque] TQS	✓	✓	✓	✓
[Pole pairs] PPNS	✓	✓	✓	✓
[Angle setting type] AST	✓	✓	✓	✓
[Encoder Type] UECP or [Emb Enc Type] EECP	–	✓ (1)	–	–
[Encoder supply volt.] UECV or [Emb	–	✓ (1)	–	–

Parameters	[Sync. mot.] SYN	[Sync.CL] FSY	[SYN_U VC] SYNU	[Reluctance Motor] SRVC
Enc Supply Volt] EECV				
[Autotuning Type] TUNT	-	-	-	✓ (2)
(1) Encoder settings depend of the encoder used on the application (see [Encoder configuration] IEN- and [Embedded Encoder] IEE- ).				
(2) [Autotuning Type] TUNT can be changed to optimize the performances with Reluctance motors.				

### [Dual rating] DRT

Select the normal/heady duty depending on the overload required on the application.

**NOTE:** Modifying this parameter resets the motor tune parameters and, [Tune selection] STUN and/or [Rotation Tune Select] STUR are reset to [Default] TAB. You need to re-perform autotuning.

Value range	Code / Value	Description
[Normal Duty]	NORMAL	Normal rating, drive current limitation is 1.5 x In
[Heavy Duty]	HIGH	High rating, drive current limitation is 1.8 x In <b>Factory setting</b>

### [Motor control type] CTT

Set this parameter according to the application and the type of motor. The selection must be done before entering motor parameter values.

**NOTE:** Modifying this parameter resets the motor tune parameters and, [Tune selection] STUN and/or [Rotation Tune Select] STUR are reset to [Default] TAB. You need to re-perform autotuning.

Value range	Code / Value	Description
[SVC V]	VVC	Voltage vector control (Sensorless flux vector V): Open-loop voltage flux vector control with automatic slip compensation according to the load. It supports operation with a number of motors connected in parallel on the same drive (if motors are identical). <b>Factory setting</b>
[FVC]	FVC	Current vector control closed loop (Full flux vector): Closed-loop current flux vector control for motors with encoder sensor; this option can be selected if an encoder module has been inserted or if the embedded encoder is used.. <b>NOTE:</b> Verify the embedded encoder or the encoder option before selecting [FVC] FVC.
[U/F VC 5pts]	UF5	U/F VC 5 point voltage/frequency:

Value range	Code / Value	Description
		<p>The profile is defined by the values of parameters <b>UNS</b>, <b>FRS</b>, <b>U1</b> to <b>U5</b> and <b>F1</b> to <b>F5</b>. The result is the blue curve.</p> <p>By default, if <b>U1</b> to <b>U5</b> and <b>F1</b> to <b>F5</b> are not modified (factory settings), the used profile is defined by 2 points (see the green curve).</p> <p><b>NOTE:</b> <b>U0</b> is the result of an internal calculation based on motor parameters and multiplied by <b>UFR</b> (%). <b>U0</b> can be adjusted by modifying <b>UFR</b> value.</p>
[Sync. mot.]	SYN	Open-loop synchronous motors: Motor control type specific for permanent magnet synchronous motors.
[Energy Sav.]	NLD	Specific motor control type optimized for energy saving.  This motor control type automatically reduces the drive output current according to the motor load. This automatic current level adaptation allows energy saving for periods when load is kept to a minimum and preserves the drive performance up to full load.
[Sync.CL]	FSY	Closed-loop synchronous motor: For permanent magnet synchronous motors, with encoder. This selection is only possible if an encoder module has been inserted or if the embedded encoder is used..  <b>NOTE:</b> Verify the embedded encoder or the encoder option before selecting [Sync.CL] <b>FSY</b> .
[SYN_U VC]	SYNU	Open-loop synchronous motor: Motor control type specific for permanent magnet synchronous motors. This motor control type is used for variable torque applications.
[Reluctance Motor]	SRVC	Synchronous reluctance Motor: Motor control type for reluctance motors. This motor control type is used for variable torque applications. If the maximum output current of the drive is not equal or greater than the motor current, this leads to a lack of torque performances. [Stall Monitoring] <b>STPC</b> function helps to prevent a motor overload by monitoring the motor current and the speed rise time.

## [Adv. Motor Control] AEMC

### Advanced motor control.

## ▲ WARNING

### LOSS OF CONTROL

If you modify the value of this parameter, you must go through the same steps as if the drive has been reset to the factory settings for the motor parameters.

**Failure to follow these instructions can result in death, serious injury, or equipment damage.**

Even if some parameters are unchanged, some others parameters, not accessible, are computed again. These settings include, but not limited to, selection of motor control type, settings of the motor parameters according to the motor nameplate, Autotuning of the motor.

This parameter enhances the standard motor control. It improves the dynamic and static performances (such as, in torque control or speed control with torque limit) especially at low frequency and at frequency greater than the motor nominal frequency.

Disable this feature to retrieve the same motor control behavior available on software version older than V3.1 (excluded).

In case of configuration transfer, if the configuration is coming from a software version older than V3.1 (excluded), this parameter is set to **[No]** NO automatically.

If this parameter is set to **[Yes]** YES, it is not possible to transfer the configuration to a drive with a software version older than V3.1 (excluded).

This parameter can be accessed if **[Motor control type]** CTT is set to **[SVC V]** VVC, **[FVC]** FVC or **[Energy Sav.]** NLD.

Modifying **[Motor control type]** CTT resets **[Adv. Motor Control]** AEMC to factory settings. However, this parameter is forced to **[No]** NO if **[Motor control type]** CTT is set to a value different from **[SVC V]** VVC, **[FVC]** FVC or **[Energy Sav.]** NLD.

Enabling advanced motor control makes **[Rotation Tune]** TRAM- function accessible .

Value range	Code / Value	Description
<b>[No]</b>	NO	Disabled.
<b>[Yes]</b>	YES	Enabled. <b>Factory setting</b>

## [data] MTD– Menu

### Access

[Complete settings] → [Motor parameters] → [Motor data] → [data]

### About This Menu

<b>⚠ WARNING</b>
<p><b>LOSS OF CONTROL</b></p> <ul style="list-style-type: none"> <li>Fully read and understand the manual of the connected motor.</li> <li>Verify that all motor parameters are correctly set by referring to the nameplate and the manual of the connected motor.</li> <li>If you modify the value of one or more motor parameters after having performed autotuning, the value of [Tune selection] <i>STUN</i> and/or [Rotation Tune Select] <i>STUR</i> is reset to [Default] <i>TAB</i> and you must re-perform autotuning.</li> </ul> <p><b>Failure to follow these instructions can result in death, serious injury, or equipment damage.</b></p>

This menu contains motor-related data such as, but not limited to, motor nameplate parameters and parameters resulting from motor tuning. The parameters displayed in the menu mainly depend on [Motor control type] *CTT* selection:

- Asynchronous motor control types, i.e. if [Motor control type] *CTT* is set to:
  - [SVC V] *VVC*,
  - [Energy Sav.] *NLD*,
  - [FVC] *FVC*,
  - [U/F VC 5pts] *UF5*.

This table presents the steps to follow to set and optimize the motor data for asynchronous motor:

Step	Action
1	Enter the motor nameplate
2	Perform the [Autotuning] <i>TUN</i> operation.
3	Adjust [Magnetizing Current] <i>IDA</i> to optimize the behavior. This adjustment can be done if [Motor control type] <i>CTT</i> is set to [SVC V] <i>VVC</i> or [U/F VC 5pts] <i>UF5</i> : <ul style="list-style-type: none"> <li>Start the motor at half nominal speed, at minimum load and without boost.</li> <li>Check and note the [Relative d-axis error] <i>RDAE</i> value:                             <ul style="list-style-type: none"> <li>If the [Relative d-axis error] <i>RDAE</i> value is lower than 0%, then [Magnetizing Current] <i>IDA</i> may be reduced..</li> <li>If the [Relative d-axis error] <i>RDAE</i> value is upper than 0%, then [Magnetizing Current] <i>IDA</i> may be increased..</li> </ul> </li> <li>Stop the motor for modify [Magnetizing Current] <i>IDA</i> in accordance with the value of the [Relative d-axis error] <i>RDAE</i> (previously noted).</li> </ul>

- Synchronous or reluctance motor control types, i.e. if [Motor control type] *CTT* is set to:
  - [Sync. mot.] *SYN*,
  - [Sync.CL] *FSY*,
  - [Reluctance Motor] *SRVC*,
  - [SYN\_U VC] *SYNU*.

This table presents the steps to follow to set and optimize the motor data for synchronous or reluctance motor:



Step	Action
1	Enter the motor nameplate
2	Perform the [Autotuning] TUN operation
3	Adjust [Syn. EMF constant] PHS to optimize the behavior. This adjustment can be done if [Motor control type] CTT is set to [SYN_U VC] SYNU: <ul style="list-style-type: none"> <li>• Start the motor at minimal stable frequency available on the machine (at minimum load and without boost).</li> <li>• Check and note the [Relative d-axis error] RDAE value:                             <ul style="list-style-type: none"> <li>◦ If the [Relative d-axis error] RDAE value is lower than 0%, then [Syn. EMF constant] PHS may be increased.</li> <li>◦ If the [Relative d-axis error] RDAE value is upper than 0%, then [Syn. EMF constant] PHS may be reduced.</li> </ul>                             [Relative d-axis error] RDAE value should be closed to 0%.                         </li> <li>• Stop the motor for modify [Syn. EMF constant] PHS in accordance with the value of the [Relative d-axis error] RDAE (previously noted).</li> </ul>

### [Motor Standard] BFR ★

This parameter is used to modify the presets and/or the units of several parameters, such as:

- [High Speed] HSP
- [Motor Freq Thd] FTD
- [Nom Motor Voltage] UNS
- [Nominal Motor Freq] FRS
- [Max Frequency] TFR

This parameter can only be accessed with asynchronous motor control types.

**NOTE:** Modifying this parameter resets the motor tune parameters and, [Tune selection] STUN and/or [Rotation Tune Select] STUR are reset to [Default] TAB. Autotuning is needed to be performed again.

Value range	Code / Value	Description
[50 Hz]	50Hz	50Hz motor frequency — IEC <b>Factory setting</b>
[60 Hz]	60Hz	60Hz motor frequency — NEMA

### [Max Frequency] TFR

To help prevent [Motor Overspeed] SOF error, it is recommended to have [Max Frequency] TFR equal to or higher than 110% of [High Speed] HSP.

Value range	Description
10.0...599.0 Hz <sup>(1)</sup> (step: 0.1 Hz)	<b>Factory setting:</b> 60 Hz, or preset to 72 Hz if [Motor Standard] BFR is set to [60 Hz] 60Hz.
<sup>(1)</sup> The maximum of the range is 10 * [Nominal Motor Freq] FRS for an asynchronous law or 10 * [Sync Nominal Freq] FRSS for a synchronous law.	

### [Nominal Motor Power] NPR ★

This parameter can only be accessed with asynchronous motor control types and if [Motor param choice] MPC is set to [Nominal Motor Power] NPR.

**NOTE:** Modifying this parameter resets the motor tune parameters and, [Tune selection] STUN and/or [Rotation Tune Select] STUR are reset to [Default] TAB. Autotuning need to be performed again.

Value range	Description
According to drive rating <sup>(1)</sup>	Unit is in kW if <b>[Motor Standard] BFR</b> is set to <b>[50 Hz] 50Hz</b> , in HP if <b>[Motor Standard] BFR</b> is set to <b>[60 Hz] 60Hz</b>  <b>Factory setting:</b> according to the drive rating
<sup>(1)</sup> : If <b>[Motor Standard] BFR</b> is set to <b>[50 Hz] 50Hz</b> , the step is 0.01 kW for drives with power range ≤ 15 kW else it is 0.1 kW. If <b>[Motor Standard] BFR</b> is set to <b>[60 Hz] 60Hz</b> , the step is 0.01 HP for drives with power range ≤ 20 HP else it is 0.1 HP.	

## [Nom Motor Voltage] UNS ★

This parameter can only be accessed with asynchronous motor control types.

**NOTE:** Modifying this parameter resets the motor tune parameters and, **[Tune selection] STUN** and/or **[Rotation Tune Select] STUR** are reset to **[Default] TAB**. Autotuning need to be performed again.

Value range	Description
100...690 Vac (step: 1 Vac)	<b>Factory setting:</b> according to drive rating and <b>[Motor Standard] BFR</b>

## [Nom Motor Current] NCR ★

This parameter can only be accessed with asynchronous motor control types.

**NOTE:** Modifying this parameter resets the motor tune parameters and, **[Tune selection] STUN** and/or **[Rotation Tune Select] STUR** are reset to **[Default] TAB**. Autotuning need to be performed again.

Value range	Description
0.25...1.8 In <sup>(1)</sup> (step: 0.01 A <sup>(2)</sup> )	<b>Factory setting:</b> according to drive rating and <b>[Motor Standard] BFR</b>
<sup>(1)</sup> : Corresponding to the rated drive current indicated in the installation manual and on the drive nameplate. <sup>(2)</sup> : For drives with power range ≤ 15 kW else it is 0.1 A.	

## [Nominal Motor Freq] FRS ★

This parameter can only be accessed with asynchronous motor control types.

**NOTE:** Modifying this parameter resets the motor tune parameters and, **[Tune selection] STUN** and/or **[Rotation Tune Select] STUR** are reset to **[Default] TAB**. Autotuning need to be performed again.

Value range	Description
10.0...599.0 Hz (step: 0.1 Hz)	<b>Factory setting:</b> 50 Hz, or preset to 60 Hz if <b>[Motor Standard] BFR</b> is set to <b>[60 Hz] 60Hz</b> .

## [Nominal Motor Speed] NSP ★

This parameter can only be accessed with asynchronous motor control types.

**NOTE:** Modifying this parameter resets the motor tune parameters and, **[Tune selection] STUN** and/or **[Rotation Tune Select] STUR** are reset to **[Default] TAB**. Autotuning need to be performed again.

If the nameplate indicates the synchronous speed and the slip in Hz or as a %, use one of the formulas to calculate the rated speed:

- Nominal speed = Synchronous speed x  $\frac{100 - \text{slip as a \%}}{100}$
- Nominal speed = Synchronous speed x  $\frac{60 - \text{slip in Hz}}{60}$  (60 Hz motors)
- Nominal speed = Synchronous speed x  $\frac{50 - \text{slip in Hz}}{50}$  (50 Hz motors).

Value range	Description
0...65,535 rpm (step: 1 rpm)	<b>Factory setting:</b> according to drive rating and <b>[Motor Standard]</b> BFR

### [Motor param choice] MPC ★

This parameter selects which motor nameplate parameter is used between **[Motor 1 Cosinus Phi]** COS and **[Nominal Motor Power]** NPR. Set the selected parameter, depending on this parameter setting.

This parameter can only be accessed with asynchronous motor control types.

**NOTE:** Modifying this parameter resets the motor tune parameters and, **[Tune selection]** STUN and/or **[Rotation Tune Select]** STUR are reset to **[Default]** TAB. Autotuning need to be performed again.

Value range	Code / Value	Description
<b>[Nominal Motor Power]</b>	NPR	Motor power: <b>[Nominal Motor Power]</b> NPR is used. <b>Factory setting</b>
<b>[Motor 1 Cosinus Phi]</b>	COS	Motor cosinus: <b>[Motor 1 Cosinus Phi]</b> COS is used.

### [Motor 1 Cosinus Phi] COS ★

This parameter can only be accessed with asynchronous motor control type and if **[Motor param choice]** MPC is set to **[Motor 1 Cosinus Phi]** COS.

**NOTE:** Modifying this parameter resets the motor tune parameters and, **[Tune selection]** STUN and/or **[Rotation Tune Select]** STUR are reset to **[Default]** TAB. Autotuning needs to be performed again.

Value range	Description
0.50...1.00 (step: 0.01)	<b>Factory setting:</b> according to the drive rating

### [Nominal motor slip] NSL ★

To modify the nominal motor slip, modify **[Nominal Motor Speed]** NSP, page 114.

This parameter can only be accessed with asynchronous motor control types and if **[Access Level]** LAC is set to **[Expert]** EPR.

Value range	Description
0...6553.5 Hz (step: 0.1 Hz)	<b>Factory setting:</b> Read-only parameter.

## [AsyncMotor R Stator] RSA ★

The factory setting is replaced by a measure resulting from a standstill motor tune (autotuning) if it has been performed. Only enter manually a value if you are copying a drive configuration that has been tuned via autotuning.

This parameter can only be accessed with asynchronous motor control types and if **[Access Level]** LAC is set to **[Expert]** EPR.

Value range	Description
0...65,535 mOhm (step: 1 mOhm) <sup>(1)</sup>	<b>Factory setting:</b> 0 mOhm
<sup>(1)</sup> : For drives with power range ≤ 15 kW. If the power range is between 18 and 75 kW (limits included), the range is 0.0...6,553.5 mOhm (step: 0.1 mOhm). If the power range is between 90 and 500 kW (limits included), the range is 0.00...655.35 mOhm (step: 0.01 mOhm) else the range is 0.000...65.535 mOhm (step: 0.001 mOhm).	

## [Magnetizing Current] IDA ★

The factory setting is replaced by the result of an internal calculation based on standstill motor tune results (autotuning). The parameter is measured if a tune in rotation is performed.

This parameter can only be accessed with asynchronous motor control types and if **[Access Level]** LAC is set to **[Expert]** EPR.

This parameter impacts the setting of **[Nom Motor torque]** TQN.

Value range	Description
0.00...655.35 A (step: 0.01 A) <sup>(1)</sup>	<b>Factory setting:</b> 0.00 A
<sup>(1)</sup> : For drives with power range ≤ 15 kW. If the power range is between 18 and 160 kW (limits included), the range is 0.0...6,553.5 A (step: 0.1 A) else the range is 0...65,535 A (step: 1 A).	

## [AsyncMotor Lf Induct] LFA ★

The factory setting is replaced by an measure resulting from a standstill motor tune (autotuning) if it has been performed. Only enter manually a value if you are copying a drive configuration that has been tuned via autotuning.

This parameter can only be accessed with asynchronous motor control types and if **[Access Level]** LAC is set to **[Expert]** EPR.

Value range	Description
0.00...655.35 mH (step: 0.01 mH) <sup>(1)</sup>	<b>Factory setting:</b> 0.00 mH
<sup>(1)</sup> : For drives with power range ≤ 15 kW. If the power range is greater than 160 kW, the range is 0.0...6,553.5 μH (step: 0.1 μH) else the range is 0.00...65,535 μH (step: 1 μH).	

## [Rotor Time Const] TRA ★

This parameter is the result of an internal calculation using motor nameplate parameters and motor autotuning results.

### NOTE:

- If a value is manually entered, this parameter is not updated after a tune in rotation has been performed.
- A value manually entered is reset to the tabulated value if **[Adv. Motor Control]** AEMC is modified from **[Yes]** YES to **[No]** NO.

This parameter can only be accessed with asynchronous motor control types and if [Access Level] LAC is set to [Expert] EPR.

Value range	Description
0.0...6,553.5 ms (step: 0.1 ms) <sup>(1)</sup>	<b>Factory setting:</b> 0.0 ms
<sup>(1)</sup> : For drives with power range ≤ 15 kW else the range is 0...65,535 ms (step: 1 ms).	

### [Sync Nominal I] NCRS ★

This parameter can only be accessed with synchronous or reluctance motor control types.

**NOTE:** Modifying this parameter resets the motor tune parameters and, [Tune selection] STUN is reset to [Default] TAB. Autotuning need to be performed again.

Value range	Description
0.25...1.8 In <sup>(1)</sup> (step: 0.01 A <sup>(2)</sup> )	<b>Factory setting:</b> according to the drive rating.
<sup>(1)</sup> : Corresponding to the rated drive current indicated in the installation manual and on the drive nameplate. <sup>(2)</sup> : For drives with power range ≤ 15 kW else it is 0.1 A.	

### [Nom SyncMotor Speed] NSPS ★

This parameter can only be accessed with synchronous or reluctance motor control types.

**NOTE:** Modifying this parameter resets the motor tune parameters and, [Tune selection] STUN is reset to [Default] TAB. Autotuning need to be performed again.

Value range	Description
0...48,000 rpm (step: 1 rpm)	<b>Factory setting:</b> according to the drive rating.

### [Torque Scaling] INRT

This parameter shows the scaling of [Motor Torque (Nm)] OTQN, [Nom Motor torque] TQN, [Nom Motor torque] TQS, [Nom Motor Tq Scaling] TQNC, [Expert Motor Tq] TQNO, [Plate Nom Motor Tq] TQNP, [M/S Master Torq Ref] FMTR, [M/S Device Torq Ref] FXT and [M/S Local Torq Ref] FTOR.

According to your needs, you can adjust the torque scaling multiplying by 10 the default torque unit.

Value range	Code / Value	Description
[0.001]	0001	Unit: 0.001 Nm Absolute setting range: 0.001...65.535 Nm Setting range: -32.767...+32.767 Nm
[0.01]	001	Unit: 0.01 Nm Absolute setting range: 0.01...655.35 Nm Setting range: -327.67...+327.67 Nm
[0.1]	01	Unit: 0.1 Nm Absolute setting range: 0.1...6,553.5 Nm Setting range: -3,276.7...+3,276.7 Nm
[1]	1	Unit: 1 Nm

Value range	Code / Value	Description
		Absolute setting range: 1...65,535 Nm Setting range: -32,767...+32,767 Nm
[10]	10	Unit: 10 Nm Absolute setting range: 10...655,350 Nm Setting range: -327,670...+327,670 Nm
<b>NOTE: Factory setting:</b> according to the drive rating		

## [Nom Motor torque] TQS ★

This parameter can only be accessed with synchronous or reluctance motor control types.

**NOTE:** Modifying this parameter resets the motor tune parameters and, [Tune selection] STUN is reset to [Default] TAB. Autotuning need to be performed again.

Value range	Description
0.1...6,553.5 Nm	The value is according to drive ratings and [Torque Scaling] INRT setting. <b>Factory setting:</b> according to the drive rating.

## [Pole pairs] PPNS ★

This parameter is used to calculated [Sync Nominal Freq] FRSS.

This parameter can only be accessed with synchronous or reluctance motor control types.

**NOTE:** Modifying this parameter resets the motor tune parameters and, [Tune selection] STUN is reset to [Default] TAB. Autotuning need to be performed again.

Value range	Description
1...240 (step: 1)	<b>Factory setting:</b> according to the drive rating.

## [Angle setting type] AST ★

This parameter can only be accessed with synchronous or reluctance motor control types.

[PSI align.] PSI and [PSIO align.] PSIO are working for all types of synchronous motors. [SPM align.] SPMA and [IPM align.] IPMA increase performances depending on the type of synchronous motor. [Rotational Current Injection] RCI may be used where [PSI align.] PSI and [PSIO align.] PSIO do not give expected performances.

Value	Code / Value	Description
[IPM align.]	IPMA	Alignment for IPM motor. Alignment mode for Interior-buried Permanent Magnet motor (usually, this kind of motor has a high saliency level). It uses high frequency injection, which is less noisy than standard alignment mode.
[SPM align.]	SPMA	Alignment for SPM motor. Mode for Surface-mounted Permanent Magnet motor (usually, this kind of motor has a medium or low saliency level). It uses high frequency injection, which is less noisy than standard alignment mode.

Value	Code / Value	Description
[PSI align.]	PSI	Pulse signal injection. Standard alignment mode, without rotor motion.  The angle measurement is realized by monitoring the stator current response to a pulse signal injection over a wide range of frequencies.
[PSIO align.]	PSIO	Pulse signal injection - optimized. Optimized alignment mode, without rotor motion.  Same operation as [PSI align.] PSI is performed over an optimized range of frequencies  The measurement time is reduced after the first run order or tune operation, even if the drive has been turned off.  <b>Factory setting</b>
[Rotational Current Injection]	RCI	Rotational current injection. Alignment mode with rotor motion.  This alignment mode realizes the mechanical alignment of the rotor and the stator; it requires up to 4 s.  The motor needs to be stopped and without resistive torque.  <b>NOTE:</b> This setting is recommended when a sinus filter is used on the application.  <b>NOTE:</b> For synchronous reluctance motor, it is recommended to use this setting.
[No align.]	NO	No alignment

### [Syn. EMF constant] PHS ★

PHS adjustment allows you to reduce the current in operation without load (or with minimum of load). To optimize the synchronous motor settings, follow the steps.

This parameter can only be accessed with synchronous motor control types.

Value range	Description
0...6,553.5 mV/rpm (step: 0.1 mV/rpm)	<b>Factory setting:</b> 0 mV/rpm

### [SyncMotor Stator R] RSAS ★

The factory setting is replaced by an estimation resulting from a standstill motor tune (autotuning) if it has been performed. Only enter manually a value if you are copying a drive configuration that has been tuned via autotuning.

This parameter can only be accessed with synchronous or reluctance motor control types and if [Access Level] LAC is set to [Expert] EPR.

Value range	Description
0...65,535 mOhm (step: 1 mOhm) <sup>(1)</sup>	<b>Factory setting:</b> 0 mOhm
<sup>(1)</sup> : For drives with power range ≤ 15 kW. If the power range is between 18 and 75 kW (limits included), the range is 0.0...6,553.5 mOhm (step: 0.1 mOhm). If the power range is between 90 and 500 kW (limits included), the range is 0.00...655.35 mOhm (step: 0.01 mOhm) else the range is 0.000...65.535 mOhm (step: 0.001 mOhm).	

### [Autotune L d-axis] LDS ★

The factory setting is replaced by an estimation resulting from a standstill motor tune (autotuning) if it has been performed. Only enter manually a value if you are copying a drive configuration that has been tuned via autotuning.

**NOTE:** On motors with smooth poles, **[Autotune L d-axis] LDS** = **[Autotune L q-axis] LQS** = Stator inductance L.

This parameter can only be accessed with synchronous or reluctance motor control types and if **[Access Level] LAC** is set to **[Expert] EPR**.

Value range	Description
0.00...655.35 mH (step: 0.01 mH) <sup>(1)</sup>	<b>Factory setting:</b> 0.00 mH
<sup>(1)</sup> : For drives with power range ≤ 15 kW. If the power range is greater than 160 kW, the range is 0.0...6,553.5 μH (step: 0.1 μH) else the range is 0.00...65,535 μH (step: 1 μH).	

## [Autotune L q-axis] LQS ★

The factory setting is replaced by an estimation resulting from a standstill motor tune (autotuning) if it has been performed. Only enter manually a value if you are copying a drive configuration that has been tuned via autotuning.

**NOTE:** On motors with smooth poles, **[Autotune L d-axis] LDS** = **[Autotune L q-axis] LQS** = Stator inductance L.

This parameter can only be accessed with synchronous or reluctance motor control types and if **[Access Level] LAC** is set to **[Expert] EPR**.

Value range	Description
0.00...655.35 mH (step: 0.01 mH) <sup>(1)</sup>	<b>Factory setting:</b> 0.00 mH
<sup>(1)</sup> : For drives with power range ≤ 15 kW. If the power range is greater than 160 kW, the range is 0.0...6,553.5 μH (step: 0.1 μH) else the range is 0.00...65,535 μH (step: 1 μH).	

## [Sync Nominal Freq] FRSS ★

This parameter can only be accessed with synchronous or reluctance motor control types and if **[Access Level] LAC** is set to **[Expert] EPR**.

**NOTE:** Modifying this parameter resets the motor tune parameters and, **[Tune selection] STUN** is reset to **[Default] TAB**. Autotuning need to be performed again.

Value range	Description
10.0...599.0 Hz (step: 0.1 Hz)	<b>Factory setting:</b> $NSPS \times PPNS / 60$ (the value is automatically updated and cannot be modified)

## [PSI Align Curr Max] MCR ★

Current level in % of **[Sync Nominal I] NCRS** for **[PSI align.] PSI** and **[PSIO align.] PSIO** angle shift measurement modes. This parameter has an impact on the inductor measurement.

This parameter can only be accessed with synchronous or reluctance motor control types and if **[Access Level] LAC** is set to **[Expert] EPR**.

This current must be equal to or higher than the maximum current level of the application; otherwise an instability may occur.

**NOTE:** In case of instability, **[PSI Align Curr Max] MCR** should be increased by steps up to obtain the requested performances.



Value	Code / Value	Description
[Auto]	AUTO	[PSI Align Curr Max] MCR is adapted by the drive according to the motor data settings. <b>Factory setting</b>
1...300 % (step: 1 %)		setting range

### [Current Filter Time] CRTF ★

This parameter is defined the filter time of the feedback currents data internally used by the drive.

This parameter can be accessed if [Access Level] LAC is set to [Expert] EPR.

Value	Code / Value	Description
[Auto]	AUTO	Currents filter time applied is defined by [Currents Filter] CRFA. <b>Factory setting</b>
1...100.0 ms (step: 0.1 ms)		setting range

### [Currents Filter] CRFA ★

Default currents filter time used if [Current Filter Time] CRTF is set to [Auto] AUTO.

This parameter can be accessed if [Access Level] LAC is set to [Expert] EPR.

Value range	Description
0.0...100.0 ms (step: 0.1 ms)	<b>Factory setting:</b> Read-only parameter.

### [Relative d-axis error] RDAE ★

This parameter can only be accessed with synchronous motor control types and asynchronous motor control types.

This parameter is used to perform adjustments on [Syn. EMF constant] PHS for synchronous motors and [Magnetizing Current] IDA for asynchronous motors :

This parameter should be close to 0 %. If [Relative d-axis error] RDAE is:

- Lower than 0%:
  - [Syn. EMF constant] PHS may be increased for synchronous motors.
  - [Magnetizing Current] IDA may be reduced for asynchronous motors.
- Greater than 0%:
  - [Syn. EMF constant] PHS may be reduced for synchronous motors.
  - [Magnetizing Current] IDA may be increased for asynchronous motors.

For asynchronous motors, the value [Relative d-axis error] RDAE may change according to the motor operating point. A value of [Relative d-axis error] RDAE between -10% and 10% ensures good motor performance.

For the all steps to follow to optimize the synchronous motor settings.

For the all steps to follow to optimize the asynchronous motor settings.

Value range	Description
0.0...6,553.5 % (step: 0.1 %)	<b>Factory setting:</b> Read-only parameter

## [Nom Motor Tq Scaling] TQNC

This parameter allows to select the reference nominal torque.

This parameter can be accessed if [Access Level] LAC is set to [Expert] EPR.

**NOTE:** In a Master/Slave configuration, page 204, the setting of [Nom Motor Tq Scaling] TQNC must be the same for both the Master and the Slaves.

Value	Code / Value	Description
[Expert]	OPTI	Optimized torque is the nominal electromagnetic torque computed based on the electrical parameters of the motor. <b>Note:</b> Selecting this setting allows a precise use of the load. <b>Factory setting</b>
[Nameplate]	NAMP	Nameplate torque is the nominal mechanical torque calculated based on the nameplate data of the motor.

## [Nom Motor torque] TQN ★

**Computed nominal motor torque** (+/- 2% tolerance).

In case of synchronous motors, this parameter is impacted by a modification of [Syn. EMF constant] PHS.

In case of asynchronous motors, this parameter is impacted by a modification of [Magnetizing Current] IDA and the magnetic saturation parameters (i.e [Flux curve coeff A] ALFA, [Flux curve coeff B] BETO, [Tangential Main Inductance] LOA).

**NOTE:** A tune in rotation modifies the magnetic saturation parameters.

According to [Nom Motor Tq Scaling] TQNC setting, [Nom Motor torque] TQN parameter displays the value of the optimized torque [Expert Motor Tq] TQNO or the nameplate torque [Plate Nom Motor Tq] TQNP.

Value range	Description
0...65,535	The value is according to drive ratings and [Torque Scaling] INRT setting. <b>Factory setting:</b> Read only

## [Expert Motor Tq] TQNO ★

This parameter can be accessed if [Access Level] LAC is set to [Expert] EPR.

Value range	Description
0...65,535	The value is according to drive ratings and [Torque Scaling] INRT setting. <b>Factory setting:</b> Read only

## [Plate Nom Motor Tq] TQNP ★

This parameter can be accessed if [Access Level] LAC is set to [Expert] EPR.

Value range	Description
0...65,535	The value is according to drive ratings and [Torque Scaling] INRT setting. <b>Factory setting:</b> Read only

## [Tangential Main Inductance] L0A ★

This parameter is estimated via the tune in rotation and is used by the magnetic saturation curve. Only enter manually a value if you are copying a drive configuration that has been tuned via the tune in rotation, page 137.

This parameter can be accessed if:

- **[Access Level]** LAC is set to **[Expert]** EPR, and
- **[Rotation Tune Type]** EFAP is set to **[Saturation]** SATF.

Value range	Description
0...6,553.5 mH (step: 0.1 mH) <sup>(1)</sup>	<b>Factory setting:</b> 0
<small>(1): For drives with power range ≤ 15 kW. If the power range is greater than 160 kW, the range is 0...65,535 μH (step: 1 μH) else the range is 0.00...655.35 mH (step: 0.01 mH).</small>	

## [Flux curve coeff A] ALFA ★

This parameter is estimated via the tune in rotation and is used by the magnetic saturation curve. Only enter manually a value if you are copying a drive configuration that has been tuned via the tune in rotation, page 137.

This parameter can be accessed if:

- **[Access Level]** LAC is set to **[Expert]** EPR, and
- **[Rotation Tune Type]** EFAP is set to **[Saturation]** SATF.

Value	Description
-327.67 %...327.67 % (step: 0.01 %)	<b>Factory setting:</b> 0.00 %

## [Flux curve coeff B] BET0 ★

This parameter is estimated via the tune in rotation and is used by the magnetic saturation curve. Only enter manually a value if you are copying a drive configuration that has been tuned via the tune in rotation, page 137.

This parameter can be accessed if:

- **[Access Level]** LAC is set to **[Expert]** EPR, and
- **[Rotation Tune Type]** EFAP is set to **[Saturation]** SATF.

Value range	Description
-327.67 %...327.67 % (step: 0.01 %)	Setting range <b>Factory setting:</b> 0.00 %

## [Nameplate Nominal Flux] PHIO ★

This parameter is calculated from the motor nameplate and it is used for internal calculation. This parameter is used for Schneider Electric services purpose

This parameter can be accessed if **[Access Level]** LAC is set to **[Expert]** EPR.

Value range	Description
0.00...655.35 Wb (step: 0.01 Wb)	<b>Factory setting:</b> Read-only parameter.

**[Rotor Nominal Flux] PHIA** ★

This parameter is the flux corresponding to **[Magnetizing Current] IDA** and used in the Flux/Current model for motor control.

This parameter can be accessed if **[Access Level] LAC** is set to **[Expert] EPR**.

Value range	Description
0.00...655.35 Wb (step: 0.01 Wb)	<b>Factory setting:</b> Read-only parameter.

**[Main Inductance] LA** ★

This parameter is the result of an internal calculation using **[Rotor Nominal Flux] PHIA** and **[Magnetizing Current] IDA**.

This parameter can be accessed if **[Access Level] LAC** is set to **[Expert] EPR**.

Value range	Description
0...6,553.5 mH (step: 0.1 mH) <sup>(1)</sup>	<b>Factory setting:</b> Read-only parameter.
<sup>(1)</sup> : For drives with power range $\leq 15$ kW. If the power range is greater than 160 kW, the range is 0...65,535 $\mu$ H (step: 1 $\mu$ H) else the range is 0.00...655.35 mH (step: 0.01 mH).	

## [Angle test setting] ASA- Menu

### Access

[Complete settings] → [Motor parameters] → [Motor data] → [Angle test setting]

### About This Menu

For synchronous motor parameters.

This menu can be accessed if [Motor control type] CTT is set to:

- [Sync.CL] FSY.

And if an encoder module has been inserted or embedded encoder is used.

### [Angle setting type] AST ★

[PSI align.] PSI and [PSIO align.] PSIO are working for all types of synchronous motors. [SPM align.] SPMA and [IPM align.] IPMA increase performances depending on the type of synchronous motor. [Rotational Current Injection] RCI may be used where [PSI align.] PSI and [PSIO align.] PSIO do not give expected performances.

Setting	Code / Value	Description
[IPM align.]	IPMA	Alignment for IPM motor. Alignment mode for Interior-buried Permanent Magnet motor (usually, this kind of motor has a high saliency level). It uses high frequency injection, which is less noisy than standard alignment mode.
[SPM align.]	SPMA	Alignment for SPM motor. Mode for Surface-mounted Permanent Magnet motor (usually, this kind of motor has a medium or low saliency level). It uses high frequency injection, which is less noisy than standard alignment mode.
[PSI align.]	PSI	Pulse signal injection. Standard alignment mode, without rotor motion  The angle measurement is realized by monitoring the stator current response to a pulse signal injection over a wide range of frequencies
[PSIO align.]	PSIO	Pulse signal injection - optimized. Optimized alignment mode, without rotor motion  Same operation as [PSI align.] PSI is performed over an optimized range of frequencies  The measurement time is reduced after the first run order or tune operation, even if the drive has been turned off  <b>Factory setting</b>
[Rotational Current Injection]	RCI	Rotational current injection. Alignment mode with rotor motion.  This alignment mode realizes the mechanical alignment of the rotor and the stator; it requires up to 4 s.  The motor needs to be stopped and without resistive torque.  <b>NOTE:</b> This setting is recommended when a sinus filter is used on the application.  <b>NOTE:</b> For synchronous reluctance motor, it is recommended to use this setting.
[No align.]	NO	No alignment

### [Angle auto-test] ASA

*Angle auto-test.*

Setting	Code / Value	Description
[No]	NO	Auto angle setting is not done <b>Factory setting</b>
[Yes]	YES	Auto angle setting is requested.
[Done]	DONE	Auto angle setting is done.

## [Angle Test Assign] ASL

### Angle Test assignment.

Value range	Code / Value	Description
[Not Assigned]	NO	Not assigned <b>Factory setting</b>
[DI1]...[DI8]	LI1...LI8	Digital input DI1...DI8 <b>NOTE:</b> DI8 selection can be accessed on drives with a power greater than 22kW.
[DI11]...[DI16]	LI11...LI16	Digital input DI11...DI16 if VW3A3203 I/O extension module has been inserted
[CD00]... [CD10]	CD00...CD10	Virtual digital input CMD.0...CMD.10 in [I/O profile] IO configuration
[CD11]... [CD15]	CD11...CD15	Virtual digital input CMD.11...CMD.15 regardless of configuration
[C101]... [C110]	C101...C110	Virtual digital input CMD1.01...CMD1.10 with integrated Modbus Serial in [I/O profile] IO configuration
[C111]... [C115]	C111...C115	Virtual digital input CMD1.11...CMD1.15 with integrated Modbus Serial regardless of configuration
[C201]... [C210]	C201...C210	Virtual digital input CMD2.01...CMD2.10 with CANopen® fieldbus module in [I/O profile] IO configuration
[C211]... [C215]	C211...C215	Virtual digital input CMD2.11...CMD2.15 with CANopen® fieldbus module regardless of configuration
[C301]... [C310]	C301...C310	Virtual digital input CMD3.01...CMD3.10 with a fieldbus module in [I/O profile] IO configuration
[C311]... [C315]	C311...C315	Virtual digital input CMD3.11...CMD3.15 with a fieldbus module regardless of configuration
[C501]... [C510]	C501...C510	Virtual digital input CMD5.01...CMD5.10 with integrated Ethernet in [I/O profile] IO configuration <b>NOTE:</b> This selection can be accessed on ATV340***N4E drives.
[C511]... [C515]	C511...C515	Virtual digital input CMD5.11...CMD5.15 with integrated Ethernet regardless of configuration <b>NOTE:</b> This selection can be accessed on ATV340***N4E drives.

**NOTE:** If a **line contactor** function has been configured, the contactor closes during measurement.

## [Angle setting Mode] ATA

### Angle setting activation mode.

Setting	Code / Value	Description
[No]	NO	Automatic auto angle setting is not activated
[Run Command]	AUTO	Auto angle setting launched at run command if the drive is not aligned state. <b>Factory setting</b>

## [Angle offset value] ASV

Phase-shift angle between the motor and the encoder. 8192 corresponds to 360°.

Setting	Description
[No]...8192	Automatic auto angle setting value <b>Factory setting: [No] NO</b>

## [Angle setting status] ASTS

*Auto angle setting status.*

Setting	Code / Value	Description
[Not Done]	TAB	Angle setting value is not defined <b>Factory setting</b>
[Pending]	PEND	Angle setting is in waiting state
[In Progress]	PROG	Angle setting function is in progress
[Error]	FAIL	Angle Setting function failed
[Done]	DONE	Angle function is OK
[Custom Value]	CUS	The phase-shift angle value has been entered by the user via the display terminal or serial Link

## [Motor tune] MTU– Menu

### Access

[Complete settings] → [Motor parameters] → [Motor data] → [Motor tune]

### About This Menu

This menu is used to perform motor autotuning (or standstill motor tuning).

The tune operation optimizes:

- The motor performances at low speed.
- The estimation of the motor torque.
- The accuracy of the estimation of the process values in sensorless operation and monitoring.

#### Before performing a motor autotuning

- The motor parameters must be set first. If a motor parameter is modified (or a parameter impacting a motor parameter setting), autotuning must be re-performed.
- The motor has to be stopped. Verify that the application does not make the motor turn during the tune operation.
- The motor must be at cold state: the motor thermal state has a significant influence on the tuning result.

Autotuning can be performed:

- manually on request by setting [Autotuning] TUN to [Apply Autotuning] YES,
- manually using the digital input or bit assigned to [Autotuning Assign] TUL,
- automatically at drive power-up if [Automatic autotune] AUT is set to [Yes] YES.



**[Autotuning] TUN****▲ WARNING****UNEXPECTED MOVEMENT**

Autotuning moves the motor in order to tune the control loops.

- Only start the system if there are no persons or obstructions in the zone of operation.

**Failure to follow these instructions can result in death, serious injury, or equipment damage.**

During autotuning, noise development and oscillations of the system are normal.

If **[Autotuning Type] TUNT** is set to **[Standard] STD**, during autotuning, the motor makes small movements.

If **[Autotuning Type] TUNT** is set to **[Rotation] ROT**, during autotuning, the motor runs at half of its nominal frequency.

**▲ WARNING****LOSS OF CONTROL**

- If you modify the value of one or more motor parameters after having performed autotuning, the value of **[Tune selection] STUN** is reset to **[Default] TAB** and you must re-perform autotuning.

**Failure to follow these instructions can result in death, serious injury, or equipment damage.**

If **[Motor control type] CTT** is set to **[Reluctance Motor] SRVC**, the drive operates the mechanical alignment of the motor (**[Angle setting type] AST** set to **[Rotational Current Injection] RCI**) prior to start the autotuning.

Autotuning is only performed if no stop command has been activated. If a "freewheel stop" or "fast stop" function has been assigned to a digital input, this input must be set to 1 (active at 0).

Autotuning takes priority over any run or prefluxing commands, which is taken into account after the autotuning sequence.

If autotuning has detected an error, this parameter automatically switches back to **[No Action] NO** and, the error response depends on the configuration of **[Tuning Error Resp] TNL**.

Autotuning may last for several seconds. Do not interrupt the process. Wait for the Display Terminal to change to **[No Action] NO**.

To redo a motor tuning, wait that it is stopped and cold. Set first **[Autotuning] TUN** to **[Erase Autotuning] CLR**, then redo the motor tuning.

The use of the motor autotuning without doing a **[Erase Autotuning] CLR** first is used to get the thermal state estimation of the motor.

The cable length has an influence on the tune result. If the wiring is modified, it is necessary to redo the tune operation.

Value ( )	Code / Value	Description
[No Action]	NO	Autotuning not in progress. <b>Factory setting</b>
[Apply Autotuning]	YES	Autotuning is performed immediately if possible, then the parameter automatically changes to [No Action] NO. If the drive state does not allow the tune operation immediately, the parameter changes to [No] NO and the operation must be done again. <b>NOTE:</b> The motor parameters must be set before performing autotuning.
[Erase Autotuning]	CLR	The motor parameters measured by the autotuning function are reset. The default motor parameter values are used to control the motor. [Autotuning Status] TUS is set to [Not Done] TAB.

## [Autotuning Status] TUS

Read-only parameter. This parameter is not saved at drive power-off. It shows the autotuning status since the last power-on.

**NOTE:** To know about which are the values used by the drive to control the motor (e.g. if the values used are the results of an autotuning) refer to [Tune selection] STUN , page 133.

Value	Code / Value	Description
[Not Done]	TAB	The autotuning is not done <b>Factory setting</b>
[Pending]	PEND	The autotuning has been requested but not yet performed
[In Progress]	PROG	The autotuning is in progress
[Error]	FAIL	The autotuning has detected an error
[Autotuning Done]	DONE	The motor parameters measured by the autotuning function are used to control the motor

## [Autotuning Usage] TUNU ★

On some application, such as hoisting application, that requires high torque at low speed, the temperature of the motor has a significant influence on the behavior and the capability to maintain the optimization of the performance resulting from the autotuning. In such case, setting the parameter [Autotuning Usage] TUNU to [Therm mot] TM helps to compensate the stator resistance according to the thermal state of the motor.

### ⚠ WARNING

#### LOSS OF CONTROL

- Set this parameter to [Therm mot] TM on hoisting application.
- For any setting of this parameter, perform a comprehensive commissioning test to verify correct operation of the application under maximum load and motor temperature conditions.

**Failure to follow these instructions can result in death, serious injury, or equipment damage.**

This parameter shows the way used to modify the motor parameters according to its estimated thermal state.

This parameter can be accessed if [Access Level] LAC is set to [Expert] EPR.

From firmware version V3.3, this parameter is preset to **[Therm mot] TM** if **[Brake logic control] BLC–** function is activated (e.g. **[Brake assignment] BLC** is assigned to an output).

Value ( )	Code / Value	Description
[No]	NO	No thermal state estimation.
[Therm mot]	TM	Statoric thermal state estimation based on nominal current and current consumed by the motor. It helps to take into account the thermal deviation of the statoric resistor impacting the application response (especially with open loop application).  <b>Factory setting</b>

### [Tuning Error Resp] TNL ★

Response to autotune error (**[Autotuning Error] TNF**).

This parameter can be accessed if **[Access Level] LAC** is set to **[Expert] EPR**.

Value	Code / Value	Description
[Ignore]	NO	Detected error ignored.
[Freewheel Stop]	YES	A freewheel stop is requested and the error is triggered.  <b>Factory setting</b>

### [Autotuning Assign] TUL ★

The autotuning is performed when the assigned input or bit changes to 1.

This parameter can be accessed if **[Access Level] LAC** is set to **[Expert] EPR**.

**NOTE:** The autotuning causes the motor to start up.

Value range	Code / Value	Description
[Not Assigned]	NO	Not assigned  <b>Factory setting</b>
[DI1]...[DI8]	LI1...LI8	Digital input DI1...DI8  <b>NOTE:</b> DI8 selection can be accessed on drives with a power greater than 22kW.
[DI11]...[DI16]	LI11...LI16	Digital input DI11...DI16 if VW3A3203 I/O extension module has been inserted
[CD00]... [CD10]	CD00...CD10	Virtual digital input CMD.0...CMD.10 in <b>[I/O profile] IO</b> configuration
[CD11]... [CD15]	CD11...CD15	Virtual digital input CMD.11...CMD.15 regardless of configuration
[C101]... [C110]	C101...C110	Virtual digital input CMD1.01...CMD1.10 with integrated Modbus Serial in <b>[I/O profile] IO</b> configuration
[C111]... [C115]	C111...C115	Virtual digital input CMD1.11...CMD1.15 with integrated Modbus Serial regardless of configuration
[C201]... [C210]	C201...C210	Virtual digital input CMD2.01...CMD2.10 with CANopen® fieldbus module in <b>[I/O profile] IO</b> configuration
[C211]... [C215]	C211...C215	Virtual digital input CMD2.11...CMD2.15 with CANopen® fieldbus module regardless of configuration
[C301]... [C310]	C301...C310	Virtual digital input CMD3.01...CMD3.10 with a fieldbus module in <b>[I/O profile] IO</b> configuration
[C311]... [C315]	C311...C315	Virtual digital input CMD3.11...CMD3.15 with a fieldbus module regardless of configuration

Value range	Code / Value	Description
[C501]... [C510]	C501...C510	Virtual digital input CMD5.01...CMD5.10 with integrated Ethernet in <b>[I/O profile]</b> IO configuration <b>NOTE:</b> This selection can be accessed on ATV340...N4E drives.
[C511]... [C515]	C511...C515	Virtual digital input CMD5.11...CMD5.15 with integrated Ethernet regardless of configuration <b>NOTE:</b> This selection can be accessed on ATV340...N4E drives.

## [Autotuning Type] TUNT ★

This parameter can be accessed:

- if **[Access Level]** LAC is set to **[Expert]** EPR, and
- with reluctance motor control type (**[Motor control type]** CTT set to **[Reluctance Motor]** SRVC).

Value ( )	Code / Value	Description
[Standard]	STD	Standard autotune <b>Factory setting</b>
[Rotation]	ROT	Autotune in rotation. This selection can be used for: <ul style="list-style-type: none"> <li>• Optimization of energy saving</li> <li>• Application with low inertia</li> <li>• Application that requires high motor control performances.</li> </ul> With this selection, less than 30% of resistive load must be present on the application to optimize the autotuning result. During the autotune sequence, the motor is started to half of its nominal frequency during maximum 45 seconds.

## [Automatic autotune] AUT ★

### ⚠ WARNING

#### UNEXPECTED MOVEMENT

If this function is activated, autotuning is performed each time the drive is switched on.

- Verify that activating this function does not result in unsafe conditions.

**Failure to follow these instructions can result in death, serious injury, or equipment damage.**

The motor must be stopped when switching on the drive.

This parameter can be accessed if **[Access Level]** LAC is set to **[Expert]** EPR.

Value ( )	Code / Value	Description
[No]	NO	Function deactivated <b>Factory setting</b>
[Yes]	YES	A tuning is automatically done at each power-up

## [Tune selection] STUN ★

Read-only parameter.

Value	Code / Value	Description
[Default]	TAB	The default motor parameter values are used to control the motor. Return to default value if a motor parameter is modified after autotuning has been performed. <b>Factory setting</b>
[Measure]	MEAS	The values measured by the autotuning function are used to control the motor. This parameter switches automatically to this value after an autotuning is successfully performed.
[Custom]	CUS	The values manually set are used to control the motor

## [Saliency mot. state] SMOT ★

Read-only parameter (internally calculated).

This parameter can be accessed:

- if [Access Level] LAC is set to [Expert] EPR, and
- if [Tune selection] STUN is set to [Measure] MEAS, and
- with synchronous or reluctance motor control type.

This parameter helps the optimization of motor control performances for synchronous motors.

Value	Code / Value	Description
[No info.]	NO	Tune not done
[Low salient]	LLS	Low saliency level.  Recommended configuration: [Angle setting type] AST = [PSI align.] PSI or [PSIO align.] PSIO and [HF inj. activation] HFI = [No] NO.
[Med salient]	MLS	Medium saliency level.  Recommended configuration: [Angle setting type] AST = [SPM align.] SPMA.  Additionally, [HF inj. activation] HFI = [Yes] YES can be used. First, tests without high frequency injection must be performed. If the results meet the requirements, [HF inj. activation] HFI must be let to [No] NO.
[High salient]	HLS	High saliency level.  Recommended configuration: [Angle setting type] AST = [IPM align.] IPMA.  Additionally, [HF inj. activation] HFI = [Yes] YES can be used. First, tests without high frequency injection must be performed. If the results meet the requirements, [HF inj. activation] HFI must be let to [No] NO.

## [Autotuning Lvl Of Current] TCR ★

**Level of current for autotuning.**

This parameter can be accessed if [Access Level] LAC is set to [Expert] EPR.

This parameter shows the level of current applied to the motor during auto tuning, in percent of the drive nominal current.

This parameter has an impact on the inductor measurement.

**NOTE:** In case of instability, [PSI Align Curr Max] MCR should be increased by steps up to obtain the requested performances.

Value	Code / Value	Description
[Auto]	AUTO	Factory setting
1...300 % (step: 1 %)		setting range

## [Angle setting type] AST★

This parameter can be accessed with synchronous or reluctance motor control type.

[PSI align.] **PSI** and [PSIO align.] **PSIO** are working for all types of synchronous motors. [SPM align.] **SPMA** and [IPM align.] **IPMA** increase performances depending on the type of synchronous motor. [Rotational Current Injection] **RCI** may be used where [PSI align.] **PSI** and [PSIO align.] **PSIO** do not give expected performances.

Value	Code / Value	Description
[IPM align.]	IPMA	Alignment for IPM motor. Alignment mode for Interior-buried Permanent Magnet motor (usually, this kind of motor has a high saliency level). It uses high frequency injection, which is less noisy than standard alignment mode.
[SPM align.]	SPMA	Alignment for SPM motor. Mode for Surface-mounted Permanent Magnet motor (usually, this kind of motor has a medium or low saliency level). It uses high frequency injection, which is less noisy than standard alignment mode.
[PSI align.]	PSI	Pulse signal injection. Standard alignment mode, without rotor motion  The angle measurement is realized by monitoring the stator current response to a pulse signal injection over a wide range of frequencies
[PSIO align.]	PSIO	Pulse signal injection - optimized. Optimized alignment mode, without rotor motion  Same operation as [PSI align.] <b>PSI</b> is performed over an optimized range of frequencies.  The measurement time is reduced after the first run order or tune operation, even if the drive has been turned off.  <b>Factory setting</b>
[Rotational Current Injection]	RCI	Rotational current injection. Alignment mode with rotor motion.  This alignment mode realizes the mechanical alignment of the rotor and the stator; it requires up to 4 s.  The motor needs to be stopped and without resistive torque. <b>NOTE:</b> This setting is recommended when a sinus filter is used on the application. <b>NOTE:</b> For synchronous reluctance motor, it is recommended to use this setting.
[No align.]	NO	No alignment

## [PSI Align Curr Max] MCR★

Current level in % of [Sync Nominal I] **NCRS** for [PSI align.] **PSI** and [PSIO align.] **PSIO** angle shift measurement modes. This parameter has an impact on the inductor measurement.

This parameter can only be accessed with synchronous or reluctance motor control types and if [Access Level] **LAC** is set to [Expert] **EPR**.

This current must be equal to or higher than the maximum current level of the application; otherwise an instability may occur.

**NOTE:** In case of instability, [PSI Align Curr Max] **MCR** should be increased by steps up to obtain the requested performances.

Value	Code / Value	Description
[Auto]	AUTO	[PSI Align Curr Max] MCR is adapted by the drive according to the motor data settings. <b>Factory setting</b>
1...300 % (step: 1 %)		setting range

## [Rotational Current Level] RCL★

This parameter can be accessed if [Angle setting type] AST is set to [Rotational Current Injection] RCI.

The current level should be set according to the torque required during the alignment operation.

Value range	Description
10...300% (step: 1 %)	The value is displayed as percentage of the nominal motor current <b>Factory setting: 75%</b>

## [Rotational Torque Current] RTC★

This parameter can be accessed:

- if [Access Level] LAC is set to [Expert] EPR, and
- if [Angle setting type] AST is set to [Rotational Current Injection] RCI, and
- with synchronous or reluctance motor control type.

Value range	Description
0...300% (step: 1 %)	The value is displayed as a percentage of the nominal motor current <b>Factory setting: 0%</b>

## [RCI Max Freq] RCSP★

This parameter can be accessed:

- if [Access Level] LAC is set to [Expert] EPR, and
- if [Angle setting type] AST is set to [Rotational Current Injection] RCI, and
- with synchronous or reluctance motor control type.

Value	Code / Value	Description
[Auto]	AUTO	<b>Factory setting</b>
0.0...599.0 Hz (step: 0.1 Hz)		setting range

## [RCI Round Nb] RCRP★

This parameter can be accessed:

- if [Access Level] LAC is set to [Expert] EPR, and
- if [Angle setting type] AST is set to [Rotational Current Injection] RCI, and
- with synchronous or reluctance motor control type.

Value	Code / Value	Description
[Auto]	AUTO	Factory setting
0...32,767 (step: 1)		setting range

## [RCI With Transformer] RCIR ★

This parameter can be accessed:

- if [Access Level] LAC is set to [Expert] EPR, and
- if [Angle setting type] AST is set to [Rotational Current Injection] RCI, and
- with synchronous or reluctance motor control type.

Value	Code / Value	Description
[No]	NO	Function inactive Factory setting
[Yes]	YES	Function active



## [Motor tune] MTU– –[Rotation Tune] TRAM– Menu

### Access

[Complete settings] → [Motor parameters] → [Motor data] → [Motor tune] → [Rotation Tune]

### Overview

This menu can be accessed if [Adv. Motor Control] AEMC is set to [Yes] YES.

The tune in rotation is used to estimate the nominal magnetizing current ([Magnetizing Current] IDA), to identify and take into account the magnetic saturation by tracking the electrical operating range of the motor. This function completes [Adv. Motor Control] AEMC feature.

The tune in rotation helps to improve the performances especially at low frequency, at frequency greater than the motor nominal frequency and for closed loop control.

#### Example of application

Application requiring torque control accuracy, torque dynamics and motor frequency greater than [Nominal Motor Freq] FRS.

#### Incompatibility

- The tune in rotation does not manage [Brake logic control] BLC– function: [Brake assignment] BLC must be set to [No] NO. If a brake is used, the brake must be handled manually to perform the tune in rotation.
- The tune in rotation is not compatible with the use of Sinus filter.
- The tune in rotation is only compatible with drive controlling a single asynchronous motor.

#### Prerequisites to perform a tune in rotation

- Expert access: [Access Level] LAC = [Expert] EPR,
- Asynchronous motor: [Motor control type] CTT = [SVC V] VVC, [FVC] FVC or [Energy Sav.] NLD.
- Advanced Motor Control activated: [Adv. Motor Control] AEMC = [Yes] YES,
- Motor nameplate is entered,
- The motor must be at cold state to perform a tune in rotation,
- It is advisable to perform the tune in rotation with minimum of load or without load,
- The motor must be free to operate all along the execution of tune in rotation. During the tune in rotation, the motor should operate in stable and normal conditions. For example, no current limitation must be triggered.

#### Standard procedure for performing a tune in rotation

**⚠ WARNING****UNEXPECTED MOVEMENT**

Autotuning moves the motor in order to tune the control loops.

- Only start the system if there are no persons or obstructions in the zone of operation.

**Failure to follow these instructions can result in death, serious injury, or equipment damage.**

**⚠ WARNING****LOSS OF CONTROL**

- If you modify the value of one or more motor parameters after having performed autotuning, the value of **[Rotation Tune Select] STUR** is reset to **[Default] TAB** and you must re-perform autotuning.

**Failure to follow these instructions can result in death, serious injury, or equipment damage.**

Even if some parameters are unchanged, some others parameters, not accessible, are computed again.

These settings include, but not limited to, selection of motor control type, settings of the motor parameters according to the motor nameplate, autotuning of the motor.

Step	Action
1	Set <b>[Rotation Tune Type] EFAP</b> to <b>[Saturation] SATF</b> .
2	Set <b>[Rotation Tune Enable] TUNR</b> to <b>[Apply Autotuning] YES</b> .
3	<p>At next run order, the tune in rotation is performed.</p> <p>During the tune in rotation, the motor operates at a frequency defined by the parameter <b>[Rotation Tune Freq] TLFR</b> and <b>[Device State] HMIS</b> shows <b>[Autotuning] TUN</b>.</p> <p><b>Note:</b></p> <ul style="list-style-type: none"> <li>• The run order must remain active during the tune in rotation.</li> <li>• At the beginning of the tune in rotation, a standstill motor tuning is performed in order to measure the motor stator resistance (<b>[AsyncMotor R Stator] RSA</b>) and the leakage inductance (<b>[AsyncMotor Lf Induct] LFA</b>).</li> <li>• <b>[Rotor Time Const] TRA</b>, <b>[Magnetizing Current] IDA</b> and <b>[Nominal motor slip] NSL</b> are not measured via standstill motor tuning. It is the result of an internal calculation.</li> <li>• After the standstill motor tuning, several current cycles are repeated (number depending on <b>[Nb Of Repetitions] TNBR</b>). The motor operates all through this phase without stopping.</li> <li>• The tune in rotation can last more than a minute depending on the motor, the drive setting and the configuration of the tune in rotation.</li> </ul>
4	<p>At the end of the tune in rotation, <b>[Rotation Tune Status] TURS</b> switches to <b>[Autotuning Done] DONE</b>. The motor is stopped and the run order can be removed.</p> <p><b>[Rotor Time Const] TRA</b>, <b>[Magnetizing Current] IDA</b>, <b>[Tangential Main Inductance] LOA</b>, <b>[Flux curve coeff A] ALFA</b> and <b>[Flux curve coeff B] BET0</b> are updated.</p> <p>Also, at the end of the tune in rotation:</p> <ul style="list-style-type: none"> <li>• <b>[Rotation Tune Enable] TUNR</b> switches back to <b>[No Action] NO</b>,</li> <li>• <b>[Rotation Tune Select] STUR</b> switches to <b>[Measure] MEAS</b>,</li> <li>• <b>[Autotuning Status] TUS</b> switches to <b>[Autotuning Done] DONE</b>.</li> </ul>

**Error detected during tune in rotation**

Refer to **[Autotuning Error] TNF** description , page 613.

## [Rotation Tune Type] EFAP

This parameter modifies the used Flux/Current model.

This parameter can be accessed if [Access Level] LAC is set to [Expert] EPR.

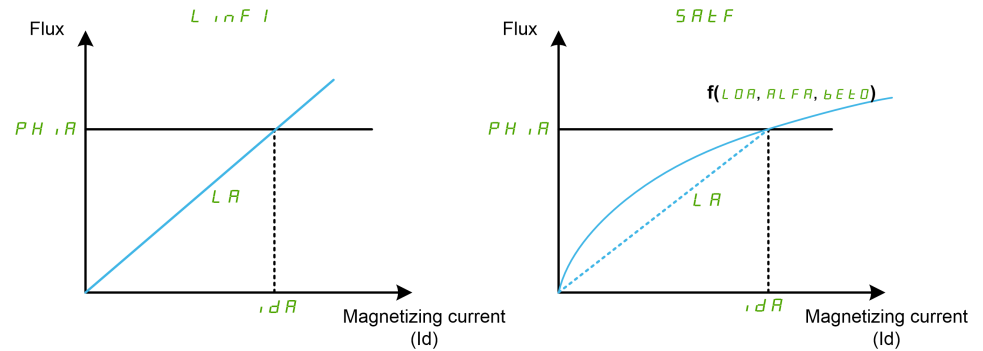

Setting	Code / Value	Description
[Standard]	LINF1	Standard. Linear approach of the magnetic curve calculated from motor nameplate parameters. <b>Factory setting</b>
[Saturation]	SATF	Saturation. Non-linear approach of the magnetic saturation curve. This setting requires to perform a tune in rotation to estimate IDA, LOA, ALFA and BET0.

## [Rotation Tune Enable] TUNR

### ⚠ WARNING

#### UNEXPECTED MOVEMENT

Autotuning moves the motor in order to tune the control loops.

- Only start the system if there are no persons or obstructions in the zone of operation.

**Failure to follow these instructions can result in death, serious injury, or equipment damage.**

### ⚠ WARNING

#### LOSS OF CONTROL

- If you modify the value of one or more motor parameters after having performed autotuning, the value of [Rotation Tune Select] STUR is reset to [Default] TAB and you must re-perform autotuning.

**Failure to follow these instructions can result in death, serious injury, or equipment damage.**

Even if some parameters are unchanged, some others parameters, not accessible, are computed again.

These settings include, but not limited to, selection of motor control type, settings of the motor parameters according to the motor nameplate, autotuning of the motor.

This parameter can be accessed if [Rotation Tune Type] EFAP is set to [Saturation] SATF.

Setting	Code / Value	Description
[No Action]	NO	The tune in rotation is not in progress and not requested. <b>Factory setting</b>
[Apply Autotuning]	YES	The tune in rotation is performed at next run order, then the parameter automatically changes to [No Action] NO.  To help repeatability of the results, it is advisable to erase the tune in rotation before performing a new one.  NOTE: The tune in rotation cannot be requested if [Brake logic control] BLC- is configured or if [Sinus Filter Activation] OFI is set to [Yes] YES.
[Erase Autotuning]	CLR	L0A, IDA, ALFA and BET0 are reset. The default values are used to control the motor. [Rotation Tune Status] TURS switches to [Not Done] TAB.  NOTE: It does not affect standstill motor tuning parameters (RSA and LFA are not reset).

## [Rotation Tune Status] TURS

Read-only parameter.

This parameter can be accessed if [Rotation Tune Type] EFAP is set to [Saturation] SATF.

This parameter is not saved at drive power-off. It shows the status of the tune in rotation since the last power-on.

Setting	Code / Value	Description
[Not Done]	TAB	The tune in rotation is not done since the last power-on. <b>Factory setting</b>
[Pending]	PEND	The tune in rotation has been requested but not yet performed.
[In Progress]	PROG	The tune in rotation is in progress.
[Error]	FAIL	The tune in rotation has detected an error.
[Autotuning Done]	DONE	The tune in rotation is done.  The motor parameters measured by the tune in rotation are used to control the motor.

## [Rotation Tune Select] STUR

Read-only parameter.

This parameter can be accessed if [Rotation Tune Type] EFAP is set to [Saturation] SATF.

Setting	Code / Value	Description
[Default]	TAB	The default motor parameter values are used to control the motor. Return to default value if a motor parameter is modified after rotation tune has been performed. <b>Factory setting</b>
[Measure]	MEAS	The values measured by the tune in rotation are used to control the motor.
[Custom]	CUS	The values manually set are used to control the motor.  NOTE: At least one of the following parameters has been entered manually: L0A, ALFA or BET0.

## [Autotuning Status] TUS

Read-only parameter.

This parameter is not saved at drive power-off. It shows the standstill motor tuning status since the last power-on (for information only, cannot be modified).

Setting	Code / Value	Description
[Not Done]	TAB	Standstill motor tuning is not done since the last power-on. <b>Factory setting</b>
[Pending]	PEND	Standstill motor tuning has been requested but not yet performed
[In Progress]	PROG	Standstill motor tuning is in progress
[Error]	FAIL	Standstill motor tuning has detected an error
[Autotuning Done]	DONE	Standstill motor tuning is done. The motor parameters measured by the autotuning function are used to control the motor

## [Rotation Tune Freq] TLFR

During the tune in rotation, the motor operates at this frequency. If [High Speed] HSP is lower than [Rotation Tune Freq] TLFR, the motor operates at [High Speed] HSP.

This parameter can be accessed if [Rotation Tune Type] EFAP is set to [Saturation] SATF.

This parameter is reset to factory settings if [Motor Standard] BFR or [Nominal Motor Freq] FRS is modified.

For robustness, it is advisable to let this parameter set to its factory setting.

Setting	Code/Value	Description
[Auto]	AUTO	it corresponds to [Nominal Motor Freq] FRS/2 <b>Factory setting</b>
0.1...599.0 Hz		Setting range

## [Nb Of Repetitions] TNBR

During the tune in rotation, one or several current cycles are repeated. The motor operates all through this phase without stopping. This parameter modifies the number of cycles.

This parameter can be accessed if [Rotation Tune Type] EFAP is set to [Saturation] SATF.

Increasing the number of cycles helps to improve the accuracy of the tune in rotation. The duration of tune in rotation is also increased.

Setting	Description
1...3	Setting range <b>Factory setting: 1</b>

## [Main Inductance] LA

Read-only parameter.

This parameter is the result of an internal calculation using **[Rotor Nominal Flux]**  $\Phi_{HIA}$  and **[Magnetizing Current]**  $I_{DA}$ .

This parameter can be accessed if **[Access Level]**  $LAC$  is set to **[Expert]**  $EPR$ .

Setting	Description
0...65535 mH (1)	Setting range <b>Factory setting:</b> -
(1): For drives with power range $\leq 15$ kW. If the power range is greater than 160 kW, the range is 0...65,535 $\mu$ H else the range is 0.00...655.35 mH.	

## [Tangential Main Inductance] $L_{0A}$

This parameter is estimated via the tune in rotation and is used by the magnetic saturation curve. Only enter manually a value if you are copying a drive configuration that has been tuned via the tune in rotation.

This parameter can be accessed if:

- **[Access Level]**  $LAC$  is set to **[Expert]**  $EPR$ , and
- **[Rotation Tune Type]**  $EFAP$  is set to **[Saturation]**  $SATF$ .

Setting	Description
0...65535 mH	Setting range <b>Factory setting:</b> 0
(1): For drives with power range $\leq 15$ kW. If the power range is greater than 160 kW, the range is 0...65,535 $\mu$ H else the range is 0.00...655.35 mH.	

## [Nameplate Nominal Flux] $\Phi_{HIO}$

Read-only parameter.

This parameter is calculated from the motor nameplate and it is used for internal calculation. This parameter is used for Schneider Electric services purpose

This parameter can be accessed if **[Access Level]**  $LAC$  is set to **[Expert]**  $EPR$ .

Setting	Description
0.00...655.35 Wb	Setting range <b>Factory setting:</b> -

## [Rotor Nominal Flux] $\Phi_{HIA}$

Read-only parameter.

This parameter is the flux corresponding to **[Magnetizing Current]**  $I_{DA}$  and used in the Flux/Current model for motor control.

This parameter can be accessed if **[Access Level]**  $LAC$  is set to **[Expert]**  $EPR$ .

Setting	Description
0.0...655.35 Wb	Setting range <b>Factory setting:</b> -

## [Flux curve coeff A] ALFA

This parameter is estimated via the tune in rotation and it is used by the magnetic saturation curve. Only enter manually a value if you are copying a drive configuration that has been tuned via the tune in rotation.

This parameter can be accessed if:

- [Access Level] LAC is set to [Expert] EPR, and
- [Rotation Tune Type] EFAP is set to [Saturation] SATF.

Setting	Description
-327.67 %...327.67 %	Setting range <b>Factory setting:</b> 0.00 %

## [Flux curve coeff B] BETO

This parameter is estimated via the tune in rotation and it is used by the magnetic saturation curve. Only enter manually a value if you are copying a drive configuration that has been tuned via the tune in rotation.

This parameter can be accessed if:

- [Access Level] LAC is set to [Expert] EPR, and
- [Rotation Tune Type] EFAP is set to [Saturation] SATF.

Setting	Description
-327.67 %...327.67 %	Setting range <b>Factory setting:</b> 0.00 %

## [1st Id min current] IDL1

This parameter determines the min level of magnetizing current (Id) reached during the first current cycle of the tune in rotation. It is expressed in % of nominal magnetizing current ([Magnetizing Current] IDA).

This parameter is reset to factory setting if [Magnetizing Current] IDA is modified.

This parameter can be accessed if:

- [Access Level] LAC is set to [Expert] EPR, and
- [Rotation Tune Type] EFAP is set to [Saturation] SATF.

Setting	Description
0%...[1st Id max current] IDH1	Setting range <b>Factory setting:</b> 50 %

## [1st Id max current] IDH1

This parameter determines the max level of magnetizing current (Id) reached during the first current cycle of the tune in rotation. It is expressed in % of nominal magnetizing current ([Magnetizing Current] IDA).

This parameter is reset to factory setting if [Magnetizing Current] IDA is modified.

This parameter can be accessed if:

- [Access Level] LAC is set to [Expert] EPR, and

- **[Rotation Tune Type]** EFAP is set to **[Saturation]** SATF.

Setting	Description
<b>[1st Id min current]</b> IDL1... 300 %	Setting range <b>Factory setting:</b> 100%

## [2nd Id min current] IDL2

This parameter determines the min level of magnetizing current (Id) reached during all current cycles of the tune in rotation after the first one. It is expressed in % of nominal magnetizing current (**[Magnetizing Current]** IDA).

This parameter is reset to factory setting if **[Magnetizing Current]** IDA is modified.

This parameter can be accessed if:

- **[Access Level]** LAC is set to **[Expert]** EPR, and
- **[Nb Of Repetitions]** TNBR is greater than 1.

Setting	Description
0 %... <b>[2nd Id max current]</b> IDH2	Setting range <b>Factory setting:</b> 20 %

## [2nd Id max current] IDH2

This parameter determines the mac level of magnetizing current (Id) reached during all current cycles of the tune in rotation after the first one. It is expressed in % of nominal magnetizing current (**[Magnetizing Current]** IDA).

This parameter is reset to factory setting if **[Magnetizing Current]** IDA is modified.

This parameter can be accessed if:

- **[Access Level]** LAC is set to **[Expert]** EPR, and
- **[Nb Of Repetitions]** TNBR is greater than 1.

Setting	Description
<b>[2nd Id min current]</b> IDL2... 300 %	Setting range <b>Factory setting:</b> 120 %

## [Autotuning flux verif] TUNV

Read-only parameter.

This parameter can be accessed if:

- **[Access Level]** LAC is set to **[Expert]** EPR, and
- **[Rotation Tune Type]** EFAP is set to **[Saturation]** SATF.

This parameter is used for Schneider Electric services purpose.



Setting	Code/Value	Description
[No]	NO	Value not available. The tune in rotation has not yet been performed since the last power-on or [Nb Of Repetitions] <i>TNBR</i> is set to 1. <b>Factory setting</b>
1...65,535 %		A numerical value is displayed after a successful tune in rotation if [Nb Of Repetitions] <i>TNBR</i> is set to 2 or 3.

## [Motor monitoring] MOP– Menu

### Access

[Complete settings] → [Motor parameters] → [Motor monitoring]

### [Motor Th Current] ITH

Motor thermal monitoring current to be set to the rated current indicated on the nameplate.

Setting ( )	Description
0.2...1.8 In <sup>(1)</sup>	Setting range <b>Factory setting:</b> According to drive rating
(1) Corresponding to the rated drive current indicated in the installation manual and on the drive nameplate.	

### [Motor Thermal Mode] THT

**NOTE:** An error is detected when the thermal state reaches 118% of the rated state and reactivation occurs when the state falls back below 100%.

Setting	Code / Value	Description
[No]	NO	No thermal monitoring
[Self cooled]	ACL	Self ventilated motor <b>Factory setting</b>
[Force-cool]	FCL	Fan-cooled motor

### [MotorTemp ErrorResp] OLL

*Motor overtemp error response.*

Setting	Code / Value	Description
[Ignore]	NO	Detected error ignored
[Freewheel Stop]	YES	Free wheel <b>Factory setting</b>

## [Thermal monitoring] TPP- Menu

### Access

[Complete settings] → [Motor parameters] → [Motor monitoring] → [Thermal monitoring]

### About This Menu

The thermal monitoring function helps to prevent against high temperature by monitoring the real temperature by the drive.

PTC, PT100, PT1000, and KTY84 thermal probes are supported by this function.

The function gives the possibility to manage 2 levels of monitoring:

- A Warning level: the drive triggers an event without stopping the application.
- An Error level: the drive triggers an event and stops the application.

The thermal probe is monitored for the following detected error:

- Overheating
- Probe break (loss of signal)
- Probe short-circuit

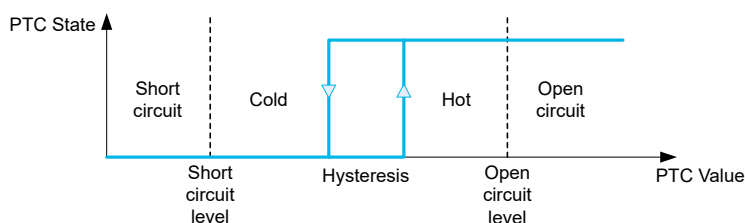

### Activation

[Alx Th Monitoring] THxS allows you to activate the thermal monitoring on the related analog input:

- [No] NO: the function is disabled
- [Yes] YES: the thermal monitoring is enabled on the related Alx.

### Type of Thermal Probe Selection

[Alx Type] AIxT allows you to select the type of thermal sensor(s) connected on the related analog input:

- [No] NO: no sensor
- [PTC] PTC: one to six PTC (in serial) is used
- [KTY] KTY: 1 KTY84 is used
- [PT100] 1PT2: 1 PT100 connected with two wires is used
- [PT1000] 1PT3: 1 PT1000 connected with two wires is used
- [PT100 in 3 wires] 1PT23: 1 PT100 connected with three wires is used (AI4 & AI5 only)
- [PT1000 in 3 wires] 1PT33: 1 PT1000 connected with three wires is used (AI4 & AI5 only)
- [3 PT100 in 3 wires] 3PT23: 3 PT100 connected with three wires is used (AI4 & AI5 only)
- [3 PT1000 in 3 wires] 3PT33: 3 PT1000 connected with three wires is used (AI4 & AI5 only)

2-wire thermal probes are supported on analog input 2 to analog input 5.

## Wiring for PT100 and PT1000 Probes

For 2-wire probes, the following wirings are possible:

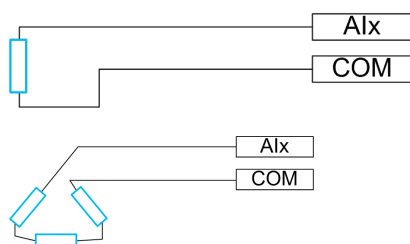

### [AI1 Th Monitoring] TH1S

**Activation of the thermal monitoring on AI1.**

Setting	Code / Value	Description
[No]	NO	No <b>Factory setting</b>
[Yes]	YES	Yes

### [AI1 Type] AI1T ★

**Configuration of AI1.**

This parameter can be accessed if [AI1 Th Monitoring] TH1S is not set to [No] NO.

Setting	Code / Value	Description
[Voltage]	10U	0-10 Vdc <b>Factory setting</b>
[Current]	0A	0-20 mA

### [AI1 Th Error Resp] TH1B ★

Thermal monitoring response to a detected error for AI1.

This parameter can be accessed if [AI1 Type] AI1T is not set to

- [Voltage] 10U, or
- [Current] 0A.

Setting	Code / Value	Description
[Ignore]	NO	Detected error ignored
[Freewheel Stop]	YES	Freewheel stop
[Per STT]	STT	Stop according to [Type of stop] STT parameter but without an error triggered after stop
[Fallback Speed]	LFF	Change to fallback speed, maintained as long as the detected error persists and the command has not been removed <sup>(1)</sup>

Setting	Code / Value	Description
[Ramp stop]	RMP	Stop on ramp <b>Factory setting</b>
1 Because, in this case, the detected error does not trigger a stop, it is recommended to assign a relay or logic output to its indication.		

### [AI1 Th Error Level] TH1F ★

This parameter can be accessed if [AI1 Type] AI1T is not set to:

- [Voltage] 10U, or
- [Current] 0A, or
- [PTC] PTC.

Setting (°C)	Description
-15.0...200.0°C	Setting range <b>Factory setting:</b> 110.0°C

### [AI1 Th Warn Level] TH1A ★

This parameter can be accessed if [AI1 Type] AI1T is not set to:

- [Voltage] 10U, or
- [Current] 0A, or
- [PTC] PTC.

Setting (°C)	Description
-15.0...200.0°C	Setting range <b>Factory setting:</b> 90.0°C

### [AI1 Th Value] TH1V ★

This parameter can be accessed if [AI1 Type] AI1T is not set to:

- [Voltage] 10U, or
- [Current] 0A, or
- [PTC] PTC.

Setting	Description
-15.0...200.0°C	Setting range <b>Factory setting:</b> _

### [AI3 Th Monitoring] TH3S

*Activation of the thermal monitoring on AI3.*

Setting	Code / Value	Description
[No]	NO	No <b>Factory setting</b>
[Yes]	YES	Yes

**[AI3 Type] AI3T** ★

This parameter can be accessed if **[AI3 Th Monitoring] TH3S** is not set to **[No] NO**.

Identical to **[AI1 Type] AI1T**, page 148 with factory setting: **[Current] 0A**.

**[AI3 Th Error Resp] TH3B** ★

Thermal monitoring response to a detected error for AI3.

This parameter can be accessed if **[AI3 Type] AI3T** is not set to:

- **[Voltage] 10U**, or
- **[Current] 0A**, or

Setting	Code / Value	Description
<b>[Ignore]</b>	NO	Detected error ignored
<b>[Freewheel Stop]</b>	YES	Freewheel stop
<b>[Per STT]</b>	STT	Stop according to <b>[Type of stop] STT</b> parameter but without an error triggered after stop
<b>[Fallback Speed]</b>	LFF	Change to fallback speed, maintained as long as the detected error persists and the command has not been removed <sup>(1)</sup>
<b>[Ramp stop]</b>	RMP	Stop on ramp <b>Factory setting</b>

<sup>1</sup> Because, in this case, the detected error does not trigger a stop, it is recommended to assign a relay or logic output to its indication.

**[AI3 Th Error Level] TH3F** ★

This parameter can be accessed if **[AI3 Type] AI3T** is not set to:

- **[Voltage] 10U**, or
- **[Current] 0A**, or
- **[PTC] PTC**.

Setting (°C)	Description
-15.0...200.0°C	Setting range <b>Factory setting:</b> 110.0°C

**[AI3 Th Warn Level] TH3A** ★

This parameter can be accessed if **[AI3 Type] AI3T** is not set to:

- **[Voltage] 10U**, or
- **[Current] 0A**, or
- **[PTC] PTC**.

Setting (°C)	Description
-15.0...200.0°C	Setting range <b>Factory setting:</b> 90.0°C

### [AI3 Th Value] TH3V ★

This parameter can be accessed if [AI3 Type] AI3T is not set to:

- [Voltage] 10U, or
- [Current] 0A, or
- [PTC] PTC.

Setting	Description
-15.0...200.0°C	Setting range <b>Factory setting:</b> _

### [AI4 Th Monitoring] TH4S ★

This parameter can be accessed if VW3A3203 I/O extension module has been inserted.

Setting	Code / Value	Description
[No]	NO	No <b>Factory setting</b>
[Yes]	YES	Yes

### [AI4 Type] AI4T ★

This parameter can be accessed if [AI4 Th Monitoring] TH4S is not set to [No] NO.

Setting	Code / Value	Description
[Voltage]	10U	0-10 Vdc
[Current]	0A	0-20 mA <b>Factory setting</b>
[Voltage +/-]	N10U	-10/+10 Vdc

### [AI4 Th Error Resp] TH4B ★

Thermal monitoring response to a detected error for AI4.

This parameter can be accessed if [AI4 Type] AI4T is not set to

- [Voltage] 10U, or
- [Current] 0A.

Setting	Code / Value	Description
[Ignore]	NO	Detected error ignored
[Freewheel Stop]	YES	Freewheel stop
[Per STT]	STT	Stop according to [Type of stop] STT parameter but without an error triggered after stop
[Fallback Speed]	LFF	Change to fallback speed, maintained as long as the detected error persists and the command has not been removed <sup>(1)</sup>

Setting	Code / Value	Description
[Ramp stop]	RMP	Stop on ramp <b>Factory setting</b>
1 Because, in this case, the detected error does not trigger a stop, it is recommended to assign a relay or logic output to its indication.		

### [AI4 Th Error Level] TH4F ★

This parameter can be accessed if [AI4 Type] AI4T is not set to:

- [Voltage] 10U, or
- [Current] 0A, or
- [PTC] PTC.

Setting (°)	Description
-15.0...200.0°C	Setting range <b>Factory setting:</b> 110.0°C

### [AI4 Th Warn Level] TH4A ★

This parameter can be accessed if [AI4 Type] AI4T is not set to:

- [Voltage] 10U, or
- [Current] 0A, or
- [PTC] PTC.

Setting (°)	Description
-15.0...200.0°C	Setting range <b>Factory setting:</b> 90.0°C

### [AI4 Th Value] TH4V ★

This parameter can be accessed if [AI4 Type] AI4T is not set to:

- [Voltage] 10U, or
- [Current] 0A, or
- [PTC] PTC.

Setting	Description
-15.0...200.0°C	Setting range <b>Factory setting:</b> _

### [AI5 Th Monitoring] TH5S ★

This parameter can be accessed if VW3A3203 I/O extension module has been inserted.

Setting	Code / Value	Description
[No]	NO	No <b>Factory setting</b>
[Yes]	YES	Yes



## [AI5 Type] AI5T ★

This parameter can be accessed if [AI5 Th Monitoring] TH5S is not set to [No] NO.

Identical to [AI4 Type] AI4T, page 151.

## [AI5 Th Error Resp] TH5B ★

Thermal monitoring response to a detected error for AI5.

This parameter can be accessed if [AI5 Type] AI5T is not set to

- [Voltage] 10U, or
- [Current] 0A.

Setting	Code / Value	Description
[Ignore]	NO	Detected error ignored
[Freewheel Stop]	YES	Freewheel stop
[Per STT]	STT	Stop according to [Type of stop] STT parameter but without an error triggered after stop
[Fallback Speed]	LFF	Change to fallback speed, maintained as long as the detected error persists and the command has not been removed <sup>(1)</sup>
[Ramp stop]	RMP	Stop on ramp <b>Factory setting</b>
<p><sup>1</sup> Because, in this case, the detected error does not trigger a stop, it is recommended to assign a relay or logic output to its indication.</p>		

## [AI5 Th Error Level] TH5F ★

This parameter can be accessed if [AI5 Type] AI5T is not set to:

- [Voltage] 10U, or
- [Current] 0A, or
- [PTC] PTC.

Setting (°C)	Description
-15.0...200.0°C	Setting range <b>Factory setting:</b> 110.0°C

## [AI5 Th Warn Level] TH5A ★

This parameter can be accessed if [AI5 Type] AI5T is not set to:

- [Voltage] 10U, or
- [Current] 0A, or
- [PTC] PTC.

Setting (°C)	Description
-15.0...200.0°C	Setting range <b>Factory setting:</b> 90.0°C

**[AI5 Th Value] TH5V ★**

This parameter can be accessed if **[AI5 Type] AI5T** is not set to:

- **[Voltage] 10U**, or
- **[Current] 0A**, or
- **[PTC] PTC**.

Setting	Description
-15.0...200.0°C	Setting range <b>Factory setting:</b> _

**[Enc Therm Sensor Type] THET ★**

*Encoder thermal sensor type.*

This parameter can be accessed if an encoder module different from a HTL encoder has been inserted.

Settings	Code/Value	Description
<b>[None]</b>	NONE	None <b>Factory settings</b>
<b>[PTC]</b>	PTC	PTC
<b>[PT100]</b>	1PT2	PT100
<b>[PT1000]</b>	1PT3	PT1000
<b>[KTY]</b>	KTY	KTY
<b>[Klixon]</b>	KLIX	Klixon

**[Enc Th ErrorResp] THEB ★**

Thermal monitoring response to a detected error for the encoder module input.

This parameter can be accessed if:

- An encoder module has been inserted, and
- **[Enc Therm Sensor Type] THET** is not set to **[None] NONE**.

Setting	Code / Value	Description
<b>[Ignore]</b>	NO	External detected error ignored
<b>[Freewheel Stop]</b>	YES	Freewheel stop
<b>[Per STT]</b>	STT	Stop according to configuration of <b>[Type of stop] STT</b> , without tripping. In this case, the detected error relay does not open and the drive is ready to restart as soon as the detected error disappears, according to the restart conditions of the active command channel (for example, according to <b>[2/3-Wire Control] TCC</b> and <b>[2-wire type] TCT</b> if control is via the terminals). Configuring a warning for this detected error is recommended (assigned to a digital output, for example) in order to indicate the cause of the stop.
<b>[Fallback Speed]</b>	LFF	Change to fallback speed, maintained as long as the detected error persists and the run command has not been removed <sup>(1)</sup>
<b>[Speed maintained]</b>	RLS	The drive maintains the speed being applied when the detected error occurred, as long as the detected error is active and the run command has not been removed <sup>(1)</sup> .
<b>[Ramp stop]</b>	RMP	Stop on ramp <b>Factory setting</b>

Setting	Code / Value	Description
[Fast stop]	FST	Fast stop
[DC injection]	DCI	DC injection stop. This type of stop cannot be used with some other functions
(1) Because, in this case, the detected error does not trigger a stop, it is advisable to assign a relay or digital output to its indication.		

### [Enc Th Error Level] THEF ★

**Thermal error level for encoder.**

This parameter can be accessed if:

- An encoder module has been inserted, and
- [Enc Therm Sensor Type] THET is not set to:
  - [None] NONE, or
  - [PTC] PTC.

Setting	Description
-15.0...200.0°C	Setting range Factory setting: 110.0°C

### [Enc Th Warn Level] THEA ★

**Thermal warning level for encoder.**

This parameter can be accessed if:

- An encoder module has been inserted, and
- [Enc Therm Sensor Type] THET is not set to:
  - [None] NONE, or
  - [PTC] PTC.

Setting	Description
-15.0...200.0°C	Setting range Factory setting: 90.0°C

### [Enc Th Value] THEV ★

**Encoder thermal value.**

This parameter can be accessed if:

- An encoder module has been inserted, and
- [Enc Therm Sensor Type] THET is not set to:
  - [None] NONE, or
  - [PTC] PTC.

Setting	Description
-15.0...200.0°C	Setting range Factory setting: _

## [FallbackSpeed] LFF

### *Fall back speed.*

Setting	Description
0.0...599.0 Hz	Setting range <b>Factory setting:</b> 0.0 Hz

## [Motor monitoring] MOP- Menu

### Access

[Complete settings] → [Motor parameters] → [Motor monitoring]

### About This Menu

The thermal monitoring function helps to prevent the motor from overheating by an estimation of the thermal state of the motor.

### [Current Limitation] CLI ★

<b>NOTICE</b>	
<b>OVERHEATING</b>	
<ul style="list-style-type: none"> <li>• Verify that the motor is properly rated for the maximum current to be applied to the motor.</li> <li>• Consider the duty cycle of the motor and all factors of your application including derating requirements in determining the current limit.</li> </ul>	
<b>Failure to follow these instructions can result in equipment damage.</b>	

**NOTE:** If the setting is less than 0.25. In, the drive may lock in [OutPhaseLoss Assign] OPL if this has been enabled. If it is less than the no-load motor current, the motor cannot run.

Setting ( )	Description
0...1.5 In	Setting range
0...1.8 In <sup>(1)</sup>	<b>Factory setting:</b> 1.8 In <sup>(1)</sup>
<b>(1)</b> Corresponding to the rated drive current indicated in the installation manual and on the drive nameplate.	

### [Attenuation Time] SOP ★

This parameter can be accessed if [Motor surge limit.] SVL is not set to [No] NO.

The value of the [Attenuation Time] parameter corresponds to the attenuation time of the cable used. It is defined to help to prevent the superimposition of voltage wave reflections resulting from long cable lengths. It limits over-voltages to twice the DC bus rated voltage.

As surge voltage depends on many parameters such as types of cable, different motor powers in parallel, different cable lengths in parallel, and so on, it is recommend the use of an oscilloscope to check the over-voltage values obtained at the motor terminals.

For long cable lengths, an output of the filter or a dV/dt filter must be used.

To retain the overall drive performance, do not increase the SOP value unnecessarily.

Setting	Code / Value	Description
[6 μs]	6	6 μs
[8 μs]	8	8 μs <b>Factory setting</b>
[10 μs]	10	10 μs

## [Sinus Filter Activation] OFI ★

This parameter can be accessed if [Motor control type] CTT is not set to:

- [Sync. mot.] SYN, or
- [Sync.CL] FSY, or
- [SYN\_U VC] SYNU, or
- [Reluctance Motor] SRVC.

### NOTICE

#### DAMAGE TO THE SINUS FILTER

Do not set the maximum output frequency [Max Frequency] TFR to a value greater than 100 Hz on systems with a sinus filter.

**Failure to follow these instructions can result in equipment damage.**

Setting	Code / Value	Description
[No]	NO	No sinus filter <b>Factory setting</b>
[Yes]	YES	Use of a sinus filter to limit over-voltages on the motor and reduce the ground detected error leakage current or in case of applications with Step-Up transformer.

## [Output Short Circuit Test] STRT

The drive outputs are tested at every power-up irrespective of the configuration of this parameter. If this parameter is set to [Yes] YES, the test is also done every time a run command is applied. These tests cause a slight delay (a few ms). In the event of an error, the drive locks.

The *drive output short-circuit (terminals U-V-W)*: SCF error can be detected.

The factory setting value is changed to [Yes] YES depending on the catalog numbers.

Setting	Code / Value	Description
[No]	NO	Not test at run command <b>Factory setting</b>
[Yes]	YES	Output short circuit test at each run command

## [Motor Therm Thd] TTD

Motor thermal threshold for [Motor Therm Thd reached] TSA warning activation.

Setting (°)	Description
0...118%	Setting range <b>Factory setting:</b> 100%

## [Motor2 Therm Thd] TTD2

Motor 2 thermal level for [Mot2 Therm Thd reached] TS2 warning activation.

Setting ( )	Description
0...118%	Setting range <b>Factory setting:</b> 100%

### [Motor3 Therm Thd] TTD3

Motor 3 thermal level for [Mot3 Therm Thd reached] TS3 warning activation.

Setting ( )	Description
0...118%	Setting range <b>Factory setting:</b> 100%

### [Motor4 Therm Thd] TTD4

Motor 4 thermal level for [Mot4 Therm Thd reached] TS4 warning activation.

Setting ( )	Description
0...118%	Setting range <b>Factory setting:</b> 100%

### [Torque Filter Time] TPFV

This parameter defines the filter time of the non-filtered output torque [Motor torque (% of Cn motor in Q12) without filter] SOTR and power [OPR Without Filter] SOPR parameters (SOTR and SOPR can only be accessed through the communication or SoMove).

The parameter can be accessed if [Access Level] LAC is set to [Expert] EPR.

Setting	Description
0...10,000 ms	Setting range <b>Factory setting:</b> 0 ms

## [Motor control] DRC– Menu

### Access

[Complete settings] → [Motor parameters] → [Motor control]

### About This Menu

This menu shows the motor control related parameters.

### [IR compensation] UFR

This parameter is used to optimize torque at low speed, or to adapt to special cases (for example: for motors connected in parallel, decrease **[IR compensation] UFR**). If there is insufficient torque at low speed, increase **[IR compensation] UFR**. A too high value can avoid the motor to start (locking) or change the current limiting mode.

Setting ( )	Description
0...200%	Setting range <b>Factory setting:</b> 100%

### [Slip compensation] SLP ★

This parameter can be accessed if **[Motor control type] CTT** is set to:

- **[SVC V] VVC**, or
- **[U/F VC 5pts] UF5**, or
- **[Energy Sav.] NLD**.

The speeds given on motor nameplates are not necessarily exact.

If the slip setting is lower than the actual slip, the motor is not rotating at the correct speed in steady state, but at a lower speed than the reference.

If the slip setting is higher than the actual slip, the motor is overcompensated and the speed is unstable.

Setting ( )	Description
0...300%	Setting range <b>Factory setting:</b> 100%

### [U1] U1 ★ to [U5] U5 ★

**Volt point 1 on 5pt V/F to Volt point 5 on 5pt V/F.**

These parameters can be accessed if **[Motor control type] CTT** is set to **[U/F VC 5pts] UF5**.

Setting ( )	Description
0...800 Vac	Setting range according to rating <b>Factory setting:</b> 0 Vac



## [F1] F1 ★ to [F5] F5 ★

*Freq point 1 on 5pt V/F to Freq point 5 on 5pt V/F.*

V/F profile setting.

This parameter can be accessed if [Motor control type] CTT is set to [U/F VC 5pts] UF5.

Setting ( )	Description
0.0...599.0 Hz	Setting range <b>Factory setting:</b> 0.0 Hz

## [Output Ph Rotation] PHR

Modifying this parameter operates as an inversion of 2 of the three motor phases. This results in changing the direction of rotation of the motor.

Setting	Code / Value	Description
[ABC]	ABC	Standard rotation <b>Factory setting</b>
[ACB]	ACB	Opposite rotation

## [Inertia Factor] SPGU ★

This parameter can be accessed if:

- [Access Level] LAC is set to [Expert] EPR, and
- [Motor control type] CTT is set to:
  - [U/F VC 5pts] UF5, or
  - [SYN\_U VC] SYNU.

Setting ( )	Description
1...1,000%	Setting range <b>Factory setting:</b> 40%

## [Boost activation] BOA ★

This parameter can be accessed if [Access Level] LAC is set to [Expert] EPR.

The factory setting of this parameter is modified to:

- [Inactive] NO if [Motor control type] CTT is set to [Reluctance Motor] SRVC.
- [Constant] CSTE if [Motor control type] CTT is set to [Sync. mot.] SYN, [SYN\_U VC] SYNU or [Sync.CL] FSU.

Setting	Code / Value	Description
[Inactive]	NO	No boost
[Dynamic]	DYNA	Dynamic boost, the magnetizing current value is modified according to the motor load. <b>Factory setting</b> <b>NOTE:</b> Drive manages itself the value [Magnetizing Current] IDA to optimize the performances.

Setting	Code / Value	Description
		<b>NOTE:</b> This selection can't be accessed if [Motor control type] CTT is set to [Sync. mot.] SYN, [Sync.CL] FSY, [Reluctance Motor] SRVC or [SYN_U VC] SYNU.
[Static]	STAT	Static boost, the magnetizing current value follows the profile whatever the motor load <b>NOTE:</b> With this selection the [Boost] BOO and [Freq Boost] FAB are taken into account. <b>NOTE:</b> This selection can be used for conical motor with [Boost] BOO sets to a negative value.
[Constant]	CSTE	Constant boost, the magnetizing current is maintained in case of change of direction of the motor. An additional parameter is available to handle the deceleration and stop phase. CSTE can be accessed if [Motor control type] CTT is set to [Sync. mot.] SYN, [Sync.CL] FSY, [Reluctance Motor] SRVC or [SYN_U VC] SYNU. <b>NOTE:</b> With this selection only [Boost] BOO is taken into account.
[Conical Motor]	CMOT	Conical boost, can be accessed if [Motor control type] CTT is not set to SYN, [Sync.CL] FSY, [Reluctance Motor] SRVC and [SYN_U VC] SYNU. <b>NOTE:</b> With this selection, it is possible to adjust the [Boost] BOO for acceleration and [Boost On Deceleration] BOO2 for deceleration.

### [Boost] BOO★

Value at 0 Hz: % of nominal magnetizing current (taken into account if different from 0).

A too high value of [Boost] BOO can result in a magnetic saturation of the motor, which leads to a torque reduction.

This parameter can be accessed if:

- [Access Level] LAC is set to [Expert] EPR, and
- [Boost activation] BOA is not set to [Inactive] NO.

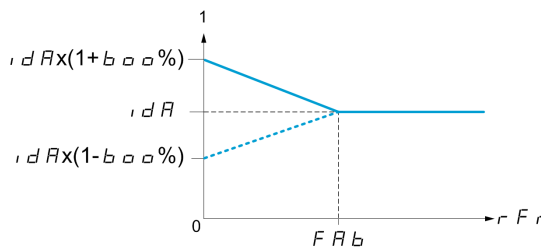

**NOTE:** For synchronous motors, it is recommended to set this value to optimize control at low speed.

Setting	Description
-100...100%	Setting range  If [Boost activation] BOA is set to [Dynamic] DYNA, [Boost] BOO is set to 25%. <b>Factory setting:</b> 0%

### [Boost On Deceleration] BOO2 ★

Value in % of nominal magnetizing current (taken into account if different from 0).

This parameter is used during deceleration phase to quickly reduce the magnetizing current at stop phase.

This parameter can be accessed if:

- [Access Level] LAC is set to [Expert] EPR, and
- [Boost activation] BOA is set to [Conical Motor] CMOT.

Setting	Description
-100...0%	Setting range <b>Factory setting:</b> -25%

## [Freq Boost] FAB ★

Value at 0 Hz: speed threshold to reach nominal magnetizing current.

This parameter can be accessed if:

- [Access Level] LAC is set to [Expert] EPR, and
- [Boost activation] BOA is not set to [Inactive] NO, and
- [Boost activation] BOA is not set to [Constant] CSTE.

Setting	Description
0.0...599.0 Hz	Setting range  If [Boost activation] BOA is set to [Dynamic] DYNA, [Freq Boost] FAB is set to 30.0 Hz. <b>Factory setting:</b> 0.0 Hz

**NOTE:** For synchronous motors, it is recommended to set this value to optimize control at low speed.

## [Braking level] VBR

**Braking level.**

Setting ( )	Description
335...1130 V	Setting range <b>Factory setting:</b> According to drive rating voltage

## [Fluxing by DI] FLI- Menu

### Access

[Complete settings] → [Motor parameters] → [Motor control] → [Fluxing by DI]

### About This Menu

Configure the fluxing by digital input.

### [Motor fluxing] FLU ★

**⚡⚠ DANGER**

**HAZARD OF ELECTRIC SHOCK, EXPLOSION, OR ARC FLASH**

If the parameter **[Motor fluxing] FLU** is set to **[Continuous] FCT**, fluxing is always active, even if the motor does not run.

- Verify that using this setting does not result in unsafe conditions.

**Failure to follow these instructions will result in death or serious injury.**

**NOTICE**

**OVERHEATING**

Verify that the connected motor is properly rated for the flux current to be applied.

**Failure to follow these instructions can result in equipment damage.**

In order to obtain rapid high torque on startup, magnetic flux needs to already have been established in the motor.

In **[Continuous] FCT** mode, the drive automatically builds up flux when it is powered up.

in **[Not continuous] FNC** mode, fluxing occurs when the motor starts up.

The flux current is greater than **[Nom Motor Current] NCR** (configured rated motor current) when the flux is established and is the adjusted to the motor magnetizing current.

If **[Motor control type] CTT** is set to **[Sync. mot.] SYN**, the **[Motor fluxing] FLU** parameter causes the alignment of the motor and not the fluxing.

If **[Brake assignment] BLC** is not **[No] NO**, the **[Motor fluxing] FLU** parameter has no effect.

Setting ( )	Code / Value	Description
<b>[Not continuous]</b>	FNC	Non-continuous mode
<b>[Continuous]</b>	FCT	Continuous mode  This option is not possible if <b>[Auto DC Injection] ADC</b> , page 295 is <b>[Yes] YES</b> or if <b>[Type of stop] STT</b> , page 288 is <b>[Freewheel Stop] NST</b> .
<b>[No]</b>	FNO	Function inactive  This setting is not possible if <b>[Motor control type] CTT</b> is set to <b>[FVC] FVC</b> .  <b>Factory setting</b>

[Fluxing assignment] FLI ★

<b>NOTICE</b>
<p><b>OVERHEATING</b></p> <p>Verify that the connected motor is properly rated for the flux current to be applied.</p> <p><b>Failure to follow these instructions can result in equipment damage.</b></p>

Assignment is only possible if [Motor fluxing] FLU is set to [Not continuous] FNC.

If a DI or a bit is assigned to the motor fluxing command, flux is built up when the assigned input or bit is at 1.

If a DI or a bit has not been assigned, or if the assigned DI or bit is at 0 when a run command is sent, fluxing occurs when the motor starts.

Value range	Code / Value	Description
[Not Assigned]	NO	Not assigned <b>Factory setting</b>
[DI1]...[DI8]	LI1...LI8	Digital input DI1...DI8 <b>NOTE:</b> DI8 selection can be accessed on drives with a power greater than 22kW.
[DI11]...[DI16]	LI11...LI16	Digital input DI11...DI16 if VW3A3203 I/O extension module has been inserted
[CD00]... [CD10]	CD00...CD10	Virtual digital input CMD.0...CMD.10 in [I/O profile] IO configuration
[CD11]... [CD15]	CD11...CD15	Virtual digital input CMD.11...CMD.15 regardless of configuration
[C101]... [C110]	C101...C110	Virtual digital input CMD1.01...CMD1.10 with integrated Modbus Serial in [I/O profile] IO configuration
[C111]... [C115]	C111...C115	Virtual digital input CMD1.11...CMD1.15 with integrated Modbus Serial regardless of configuration
[C201]... [C210]	C201...C210	Virtual digital input CMD2.01...CMD2.10 with CANopen® fieldbus module in [I/O profile] IO configuration
[C211]... [C215]	C211...C215	Virtual digital input CMD2.11...CMD2.15 with CANopen® fieldbus module regardless of configuration
[C301]... [C310]	C301...C310	Virtual digital input CMD3.01...CMD3.10 with a fieldbus module in [I/O profile] IO configuration
[C311]... [C315]	C311...C315	Virtual digital input CMD3.11...CMD3.15 with a fieldbus module regardless of configuration
[C501]... [C510]	C501...C510	Virtual digital input CMD5.01...CMD5.10 with integrated Ethernet in [I/O profile] IO configuration <b>NOTE:</b> This selection can be accessed on ATV340...N4E drives.
[C511]... [C515]	C511...C515	Virtual digital input CMD5.11...CMD5.15 with integrated Ethernet regardless of configuration <b>NOTE:</b> This selection can be accessed on ATV340...N4E drives.

[Angle setting type] AST ★

This parameter can be accessed if [Motor control type] CTT is set to:

- [Sync. mot.] SYN, or
- [Sync.CL] FSY, or
- [SYN\_U VC] SYNU, or

- **[Reluctance Motor]** [SRVC](#).

**[PSI align.]** [PSI](#) and **[PSIO align.]** [PSIO](#) are working for all types of synchronous motors. **[SPM align.]** [SPMA](#) and **[IPM align.]** [IPMA](#) increase performances depending on the type of synchronous motor. **[Rotational Current Injection]** [RCI](#) may be used where **[PSI align.]** [PSI](#) and **[PSIO align.]** [PSIO](#) do not give expected performances.

Setting	Code / Value	Description
<b>[IPM align.]</b>	<a href="#">IPMA</a>	Alignment for IPM motor. Alignment mode for Interior-buried Permanent Magnet motor (usually, this kind of motor has a high saliency level). It uses high frequency injection, which is less noisy than standard alignment mode.
<b>[SPM align.]</b>	<a href="#">SPMA</a>	Alignment for SPM motor. Mode for Surface-mounted Permanent Magnet motor (usually, this kind of motor has a medium or low saliency level). It uses high frequency injection, which is less noisy than standard alignment mode.
<b>[PSI align.]</b>	<a href="#">PSI</a>	Pulse signal injection. Standard alignment mode, without rotor motion  The angle measurement is realized by monitoring the stator current response to a pulse signal injection over a wide range of frequencies
<b>[PSIO align.]</b>	<a href="#">PSIO</a>	Pulse signal injection - optimized. Optimized alignment mode, without rotor motion  Same operation as <b>[PSI align.]</b> <a href="#">PSI</a> is performed over an optimized range of frequencies  The measurement time is reduced after the first run order or tune operation, even if the drive has been turned off  <b>Factory setting</b>
<b>[Rotational Current Injection]</b>	<a href="#">RCI</a>	Rotational current injection. Alignment mode with rotor motion.  This alignment mode realizes the mechanical alignment of the rotor and the stator; it requires up to 4 s.  The motor needs to be stopped and without resistive torque.  <b>NOTE:</b> This setting is recommended when a sinus filter is used on the application.  <b>NOTE:</b> For synchronous reluctance motor, it is recommended to use this setting.
<b>[No align.]</b>	NO	No alignment

## [Spd Loop Optimization] MCL- Menu

### Access

[Complete settings] → [Motor parameters] → [Motor control] → [Spd Loop Optimization]

### About This Menu

This procedure can be done if [Motor control type] CTT is not set to [U/F VC 5pts] UF5 or [SYN\_U VC] SYNU.

## Recommended Procedure for Setting the High-Performance Speed Loop

Step	Action
1	Enter the motor parameters. If you subsequently modify one of these, you have to perform this whole procedure again.
2	The value of the inertia being driven must be entered in the [Application Inertia] JAPL parameter. , page 173  <b>NOTE:</b> If a motor parameter is modified, the estimated inertia is recalculated and updated (parameters [Estim. app. inertia] JEST and [Inertia Mult. Coef.] JMUL. [Application Inertia] JAPL returns to its default value according to the new value of [Estim. app. inertia] JEST.
3	Check the speed loop response time by first setting [Feed forward] FFP to 0 (see graphs on next page).
4	If necessary, adjust the bandwidth and stability using parameters [FreqLoop Stab] STA and [FreqLoopGain] FLG , page 170.
5	To optimize ramp following, increase the feedforward parameter [Feed forward] FFP as indicated on the next page until the best result is obtained.
6	The feedforward term bandwidth can be adjusted if necessary (as shown on the next page) to further improve the ramp following or to filter the noise on the speed reference.

## High-Performance speed Loop - Setting the [Feed forward] FFP Parameter

This is used to adjust the level of dynamic torque feedforward required for accelerating and decelerating the inertia. The effect of this parameter on ramp following is illustrated below. Increasing the value of FFP allows the ramp to be followed more closely. However, if the value is too high, overspeed occurs. The optimum setting is obtained when the speed follows the ramp precisely; this depends on the accuracy of the [Application Inertia] JAPL parameter, , page 173 and the [Encoder filter value] FFR parameter setting , page 174

**FFP settings**

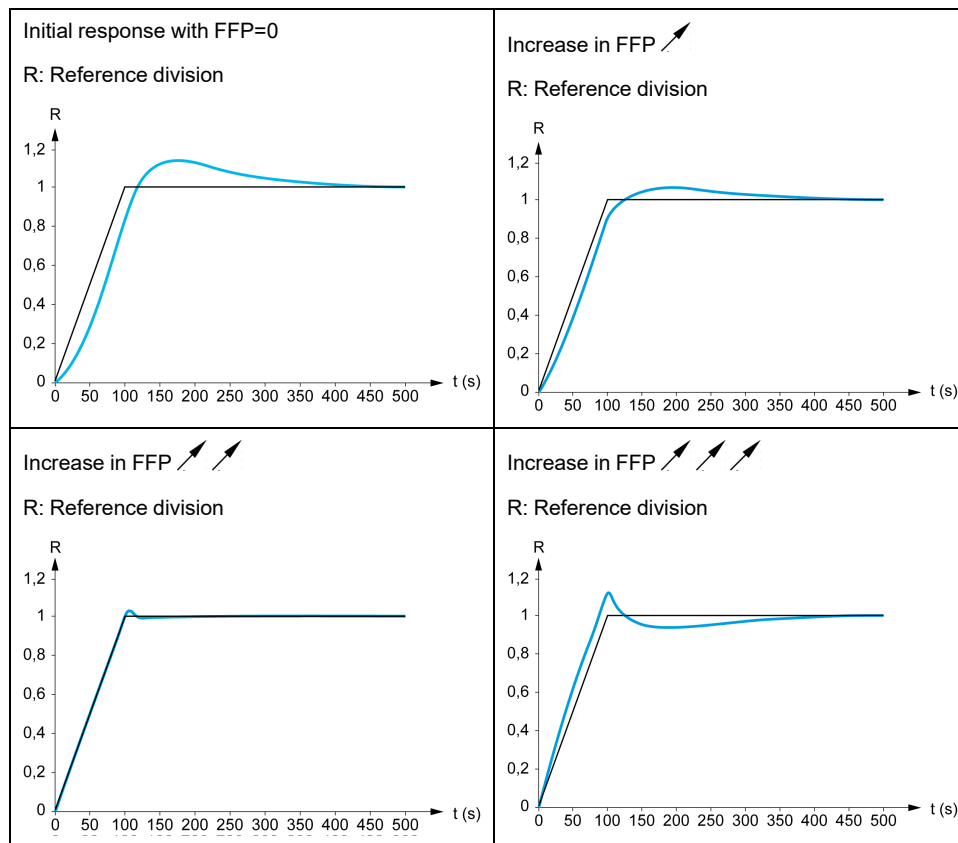

## High-Performance Speed Loop - Setting the [FeedFwd Bandwidth] $FFV$ Parameter

This is used to adjust the bandwidth of the dynamic torque feedforward term. The effect of this parameter on ramp following is illustrated below. Decreasing the value of  $FFV$  reduces the effect of noise on the speed reference (torque ripple). However, too great a decrease in relation to the ramp settings (on short ramps) causes a delay, and ramp following is adversely affected. Increasing the value of  $FFV$  allows the ramp to be followed more closely, but also heightens noise sensitivity. The optimum setting is obtained by reaching the best compromise between ramp following and the existing noise sensitivity.

### $FFV$ settings



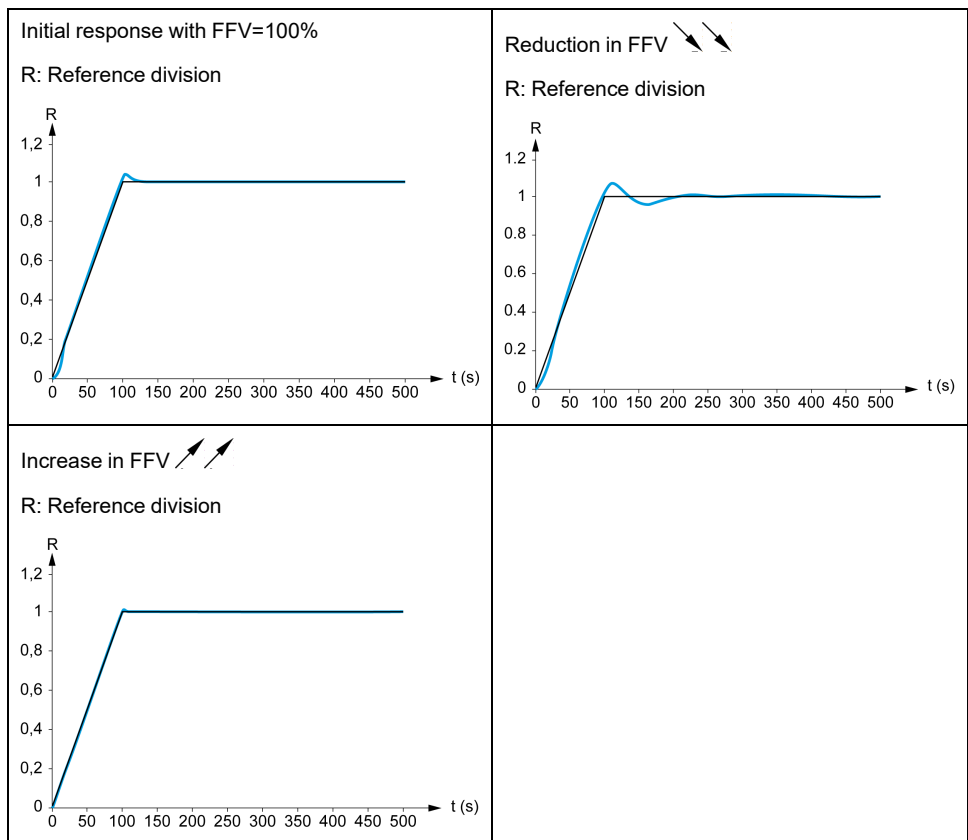

[Speed loop type] SSL ★

This parameter can be accessed if [Motor control type] CTT is not set to:

- [U/F VC 5pts] UF5, or
- [SYN\_U VC] SYNU.

Setting	Code / Value	Description
[Standard]	STD	Standard speed loop <b>Factory setting</b>
[High Perf]	HPF	High-performance speed loop. It is advised to deactivate [Dec. Ramp Adapt] BRA = [No] NO

[Speed prop. gain] SPG ★

This parameter can be accessed if:

- [Speed loop type] SSL is set to [Standard] STD, and
- [Motor control type] CTT is not set to:
  - [U/F VC 5pts] UF5, or
  - [SYN\_U VC] SYNU.

Setting (°)	Description
0...1,000%	Setting range <b>Factory setting: 40%</b>

**[SLS Type] SLT ★**

Speed loop integral time constant.

This parameter can be accessed if:

- **[Speed loop type] SSL** is set to **[Standard] STD**, and
- **[Motor control type] CTT** is not set to:
  - **[U/F VC 5pts] UF5**, or
  - **[SYN\_U VC] SYNU**.

Setting ( )	Description
1...65,535 ms	Setting range <b>Factory setting:</b> According to the drive rating.

**[K speed loop filter] SFC**

*K speed loop filter* (0(IP) to 1(PI)).

Setting ( )	Description
0...100	Setting range <b>Factory setting:</b> 65

**[Spd est. filter time] FFH ★**

Filter time of the estimated speed.

This parameter can be accessed if **[Access Level] LAC** is set to **[Expert] EPR**.

Setting ( )	Description
0.0...100.0 ms	Setting range <b>Factory setting:</b> According to the drive rating

**[FreqLoop Stab] STA ★**

*Frequency loop stability* (Speed loop damping factor).

This parameter can be accessed if:

- **[Speed loop type] SSL** is set to **[High Perf] HPF**, and
- **[Motor control type] CTT** is not set to:
  - **[U/F VC 5pts] UF5**, or
  - **[SYN\_U VC] SYNU**.

**Stability:** Used to adapt the return to steady state after a speed transient, according to the dynamics of the machine. Gradually increase the stability to increase control loop attenuation and thus reduce any overspeed.

Setting ( )	Description
0...100%	Setting range <b>Factory setting:</b> 20%

## [FreqLoopGain] FLG ★

**Frequency loop gain** (Speed loop bandwidth).

This parameter can be accessed if:

- [Speed loop type] SSL is set to [High Perf] HPF, and
- [Motor control type] CTT is not set to:
  - [U/F VC 5pts] UF5, or
  - [SYN\_U VC] SYNU.

Used to adapt the response of the machine speed transients according to the dynamics. For machines with high resistive torque, high inertia or fast cycles, increase the gain gradually.

Setting ( )	Description
0...100%	Setting range Factory setting: 20%

## [Feed forward] FFP ★

This parameter can be accessed if:

- [Speed loop type] SSL is set to [High Perf] HPF, and
- [Motor control type] CTT is not set to:
  - [U/F VC 5pts] UF5, or
  - [SYN\_U VC] SYNU.

Percentages of the high-performance regulator feedforward term. 100% corresponds to the term calculated using the value of [Application Inertia] JAPL.

Setting ( )	Description
0...200%	Setting range Factory setting: 0%

## [FeedFwd Bandwidth] FFV ★

Bandwidth of the filter of feed-forward term.

This parameter can be accessed if:

- [Speed loop type] SSL is set to [High Perf] HPF, and
- [Motor control type] CTT is not set to:
  - [U/F VC 5pts] UF5, or
  - [SYN\_U VC] SYNU.

Bandwidths of the high-performance speed loop feedforward term, as a percentage of the predefined value.

Setting ( )	Description
20...500%	Setting range Factory setting: 100%

## [External FeedFwd Assign] TEFF ★

**External feed forward assignment.**

Setting	Code / Value	Description
[Not Configured]	NO	Analog input is not assigned <b>Factory setting</b>
[AI1]...[AI3]	AI1...AI3	Analog input AI1...AI3 <b>NOTE:</b> AI3 selection can be accessed on drives with a power greater than 22kW.
[AI4]...[AI5]	AI4...AI5	Analog input AI4...AI5 if VW3A3203 I/O extension module has been inserted
[HMI]	LCC	Reference Frequency via remote terminal
[Ref. Freq-Modbus]	MDB	Reference frequency via Modbus
[Ref. Freq-CANopen]	CAN	Reference frequency via CANopen if a CANopen module has been inserted
[Ref. Freq-Com. Module]	NET	Reference frequency via fieldbus module if a fieldbus module has been inserted
[Embedded Ethernet]	ETH	Embedded Ethernet <b>NOTE:</b> This selection can be accessed on ATV340••N4E drives.
[DI7 PulseInput]... [DI8 PulseInput]	PI7...PI8	Digital input DI7...DI8 used as pulse input <b>NOTE:</b> This selection can be accessed on drives with a power greater than 22 kW.
[RP]	PI	Pulse input <b>NOTE:</b> This selection can be accessed on drives with a power below than 30 kW.
[Encoder]	PG	Encoder reference if an encoder module has been inserted or embedded encoder is used. <b>NOTE:</b> Embedded encoder is only available on drives with power up to 22kW.

## [Inertia Mult. Coef.] JMUL ★

### *Inertia Multiplying Coefficient.*

This parameter can be accessed if:

- [Speed loop type] SSL is set to [High Perf] HPF, and
- [Motor control type] CTT is not set to:
  - [U/F VC 5pts] UF5, or
  - [SYN\_U VC] SYNU.

Increment for [Application Inertia] JAPL and [Estim. app. inertia] JEST parameters, calculated by the drive, in read-only mode: 0.1 gm<sup>2</sup>, 1 gm<sup>2</sup>, 10 gm<sup>2</sup>, 100 gm<sup>2</sup>, 1000 gm<sup>2</sup>.

Setting	Description
0.0...6553.5 gm <sup>2</sup>	Setting range <b>Factory setting:</b> 0.0 gm <sup>2</sup>

## [Estim. app. inertia] JEST ★

This parameter can be accessed if:

- [Speed loop type] SSL is set to [High Perf] HPF, and
- [Motor control type] CTT is not set to:
  - [U/F VC 5pts] UF5, or
  - [SYN\_U VC] SYNU.

The inertia being driven is estimated by the drive according to the motor parameters, in read-only mode. Speed loop default settings are determined by the drive from this inertia.

Increment given by [Inertia Mult. Coef.] JMUL: - 0.1 gm<sup>2</sup>, 1 gm<sup>2</sup>, 10 gm<sup>2</sup>, 100 gm<sup>2</sup> or 1000 gm<sup>2</sup>.

Setting	Description
1...9,999 kg.m <sup>2</sup>	Setting range Factory setting: -

### [App. Inertia Coef.] JACO ★

This parameter can be accessed if:

- [Speed loop type] SSL is set to [High Perf] HPF, and
- [Motor control type] CTT is not set to:
  - [U/F VC 5pts] UF5, or
  - [SYN\_U VC] SYNU.

Coefficient which fixes the ratio between [Estim. app. inertia] JEST and [Application Inertia] JAPL parameters.

[Application Inertia] JAPL = [Estim. app. inertia] JEST x [App. Inertia Coef.] JACO.

Setting	Description
0.10...100.00	Setting range Factory setting: 1

### [Application Inertia] JAPL ★

This parameter can be accessed if:

- [Speed loop type] SSL is set to [High Perf] HPF, and
- [Motor control type] CTT is not set to:
  - [U/F VC 5pts] UF5, or
  - [SYN\_U VC] SYNU.

Adjustable application inertia used by the drive to optimize speed loop settings).

Increment given by [Inertia Mult. Coef.] JMUL: 0.1 gm<sup>2</sup>, 1 gm<sup>2</sup>, 10 gm<sup>2</sup>, 100 gm<sup>2</sup> or 1000 gm<sup>2</sup>.

**NOTE:** If a motor parameter is modified, the estimated inertia is recalculated and updated (parameters [Estim. app. inertia] JEST and [Inertia Mult. Coef.] JMUL). [Application Inertia] JAPL is also returned to its default value according to the new value of [Estim. app. inertia] JEST.

Setting	Description
0.00...655.35 kgm <sup>2</sup>	Setting range Factory setting: -

### [Encoder filter activ.] FFA ★

This parameter can be accessed if an encoder module has been inserted or embedded encoder is used.

This parameter can be accessed if:

- **[Encoder usage]** **ENU** is not set to **[No]** **NO**, or
- **[Emb Enc Usage]** **EENU** is not set to **[No]** **NO**.

Setting	Code / Value	Description
<b>[No]</b>	<b>NO</b>	Filter deactivated <b>Factory setting</b>
<b>[Yes]</b>	<b>YES</b>	Filter activated

## [Encoder filter value] **FFR** ★

This parameter can be accessed if:

- **[Access Level]** **LAC** is set to **[Expert]** **EPR**, and
- **[Encoder filter activ.]** **FFA** is set to **[Yes]** **YES**.

Setting	Description
0.0...40.0 ms	Setting range <b>Factory setting:</b> according to encoder rating

## [Notch Filter Activation] **NFA** ★

This parameter activates the notch filter function. Two independent notch filters can be configured.

The notch filter central frequency should be set at or slightly higher than the mechanical resonance frequency. The main task is to identify as precise as possible the resonance frequency.

**NOTE:** Vibrations may occurs at frequencies higher than the mechanical resonance frequency, depending on the settings of the speed loop and motor parameters. It is important to identify the real mechanical resonance frequency.

Perform the following actions for the commissioning:

1. Set the motor data
2. Set the application data
3. Set the speed loop settings
4. In case of vibrations, set the Notch filter settings as described bellow
5. If the performances are not OK, restart from step 3

This parameter can be accessed if:

- An encoder module has been inserted or embedded encoder is used.
- **[Access Level]** **LAC** is set to **[Expert]** **EPR**, and
- **[Speed loop type]** **SSL** is set to **[High Perf]** **HPF**.

Setting ( )	Code / Value	Description
<b>[First]</b>	<b>1ST</b>	Notch filter 1 enabled
<b>[Second]</b>	<b>2ND</b>	Notch filter 2 enabled
<b>[All]</b>	<b>ALL</b>	Notch filters 1 and 2 enabled
<b>[No]</b>	<b>NO</b>	No notch filter enabled <b>Factory setting</b>

Notch filter settings

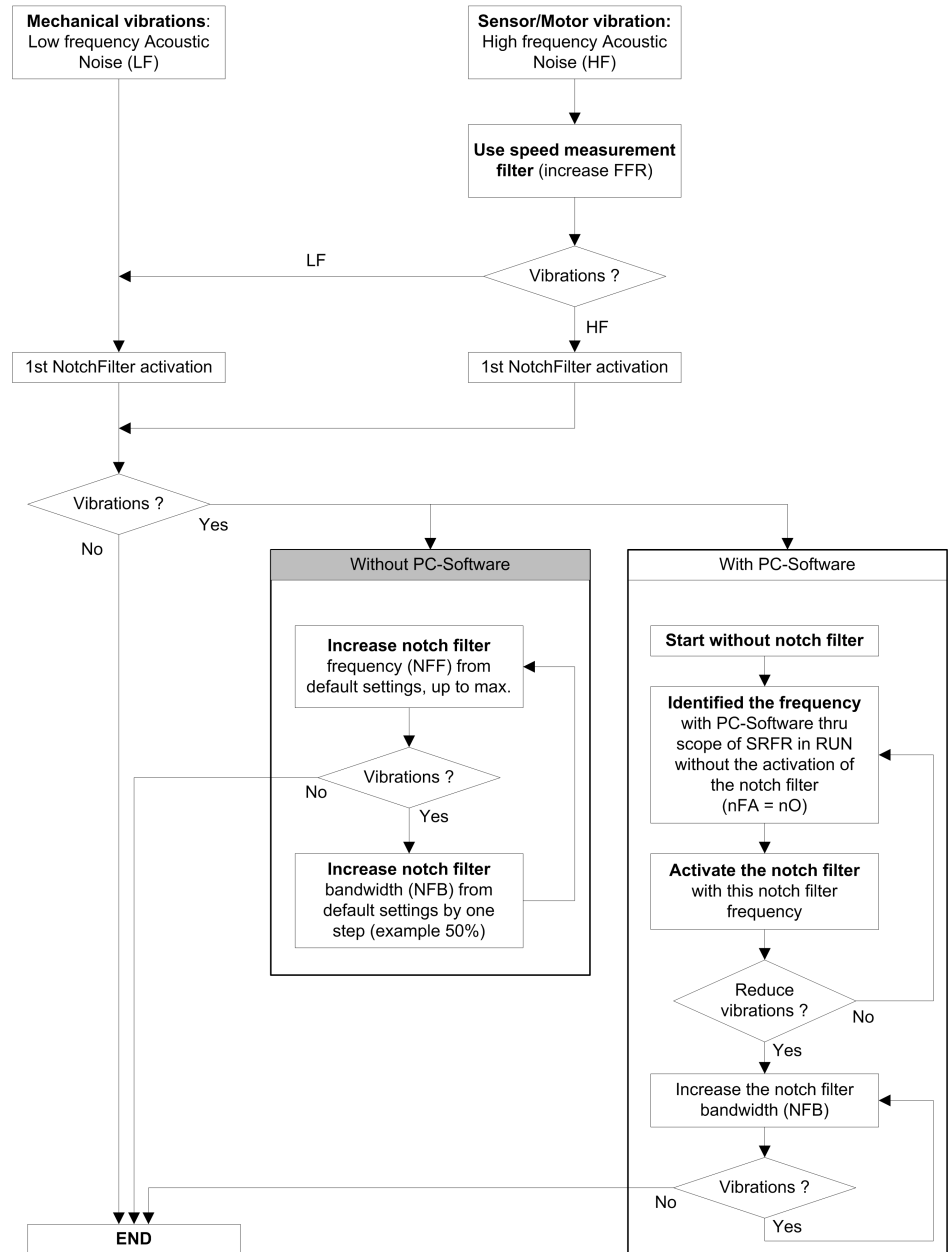

[Notch Filter Freq 1] NFF1 ★

This parameter can be accessed if:

- [Access Level] LAC is set to [Expert] EPR, and
- [Speed loop type] SSL is set to [High Perf] HPF, and
- [Notch Filter Activation] NFA is set to:
  - [First] 1ST, or
  - [All] ALL.

Setting	Description
10.0...150.0 Hz	Setting range <b>Factory setting:</b> 15.0 Hz

## [Notch Filter Bdw 1] NFB1 ★

This parameter can be accessed if:

- [Access Level] LAC is set to [Expert] EPR, and
- [Speed loop type] SSL is set to [High Perf] HPF, and
- [Notch Filter Activation] NFA is set to:
  - [First] 1ST, or
  - [All] ALL.

This parameter defines the bandwidth of the notch filter 1. Filter with higher bandwidth provides better stability margin when the load resonant frequency changes (with trolley position or load).

**NOTE:** Raising the bandwidth can interfere with the expect drive dynamic (reducing the dynamic of the speed loop).

Setting	Description
10...400%	Setting range <b>Factory setting:</b> 100%

## [Notch Filter Depth 1] NFD1 ★

This parameter can be accessed if:

- [Access Level] LAC is set to [Expert] EPR, and
- [Speed loop type] SSL is set to [High Perf] HPF, and
- [Notch Filter Activation] NFA is set to:
  - [First] 1ST, or
  - [All] ALL.

This parameter defines the gain of the notch filter 1 at the central frequency. When NFD1=100%, no filter is applied.

Setting	Description
0...99%	Setting range <b>Factory setting:</b> 10%

## [Notch Filter Freq 2] NFF2 ★

This parameter can be accessed if:

- [Access Level] LAC is set to [Expert] EPR, and
- [Speed loop type] SSL is set to [High Perf] HPF, and
- [Notch Filter Activation] NFA is set to:
  - [Second] 2ND, or
  - [All] ALL.

Setting	Description
10.0...150.0 Hz	Setting range <b>Factory setting:</b> 85.0 Hz

## [Notch Filter Bdw 2] NFB2 ★

This parameter can be accessed if:



- [Access Level] LAC is set to [Expert] EPR, and
- [Speed loop type] SSL is set to [High Perf] HPF, and
- [Notch Filter Activation] NFA is set to:
  - [Second] 2ND, or
  - [All] ALL.

This parameter defines the bandwidth of the notch filter 2. Filter with higher bandwidth provides better stability margin when the load resonant frequency changes (with trolley position or load).

**NOTE:** Rising the bandwidth can interfere with the expect drive dynamic (reducing the dynamic of the speed loop).

Setting	Description
10...400%	Setting range <b>Factory setting:</b> 100%

### [Notch Filter Depth 2] NFD2 ★

This parameter can be accessed if:

- [Access Level] LAC is set to [Expert] EPR, and
- [Speed loop type] SSL is set to [High Perf] HPF, and
- [Notch Filter Activation] NFA is set to:
  - [Second] 2ND, or
  - [All] ALL.

This parameter defines the gain of the notch filter 2 at the central frequency. When NFD2 =100%, no filter is applied.

Setting	Description
0...99%	Setting range <b>Factory setting:</b> 25%

## [Motor control] DRC– Menu

### Access

[Complete settings] → [Motor parameters] → [Motor control]

### About This Menu

This menu shows the motor control related parameters.

### [HF inj. activation] HFI

This parameter can be accessed if:

- [Access Level] LAC is set to [Expert] EPR, and
- [Motor control type] CTT is not set to:
  - [Sync. mot.] SYN, or
  - [Sync.CL] FSY, or
  - [SYN\_U VC] SYNU, or
  - [Reluctance Motor] SRVC.

Setting	Code / Value	Description
[No]	NO	HF injection inactive <b>Factory setting</b>
[Yes]	YES	HF injection active

### [HF injection freq.] FRI

This parameter can be accessed if:

- [Access Level] LAC is set to [Expert] EPR, and
- [HF inj. activation] HFI is set to [Yes] YES.

Setting	Description
250...1000 Hz	Setting range <b>Factory setting:</b> 500 Hz

### [HF pll bandwidth] SPB

#### *Bandwidth of the HF PLL.*

This parameter can be accessed if:

- [Access Level] LAC is set to [Expert] EPR, and
- [HF inj. activation] HFI is set to [Yes] YES.

Setting	Description
0...400%	Setting range <b>Factory setting:</b> 100%

## [Current Level Align] ILR

### *Current level of the HF alignment.*

This parameter can be accessed if:

- **[Access Level]** LAC is set to **[Expert]** EPR, and
- **[HF inj. activation]** HFI is set to **[Yes]** YES.

Setting	Description
0...200%	Setting range Factory setting: 50%

## [Boost level align.] SIR

### *Boost level for IPMA alignment.*

This parameter can be accessed if **[Access Level]** LAC is set to **[Expert]** EPR.

Setting	Description
0...200%	Setting range Factory setting: 100%

## [Angle error Comp.] PEC

This parameter can be accessed if:

- **[Access Level]** LAC is set to **[Expert]** EPR, and
- **[HF inj. activation]** HFI is set to **[Yes]** YES.

Setting	Description
0...500%	Setting range Factory setting: 0%

## About Output Voltage Management and Overmodulation

### [Overmodul. Activation] OVMA

This parameter can be accessed if **[Access Level]** LAC is set to **[Expert]** EPR.

The purpose of the overmodulation is to:

- compensate the voltage loss in DC bus when the drive is loaded.
- increase the maximum possible voltage to reduce current consumption at high motor voltage and limit thermal effect on the motor.

In factory settings, the motor supplied by the intermediate of the drive has:

- a common output voltage mode not null depending on the DC bus supply.
- No overmodulation (**[Overmodul. Activation]** OVMA is set to **[No over modulation]** NO): sinusoidal phase to phase voltage.
- output voltage limited to the maximum possible value depending on DC bus supply which depends on the main power supply.

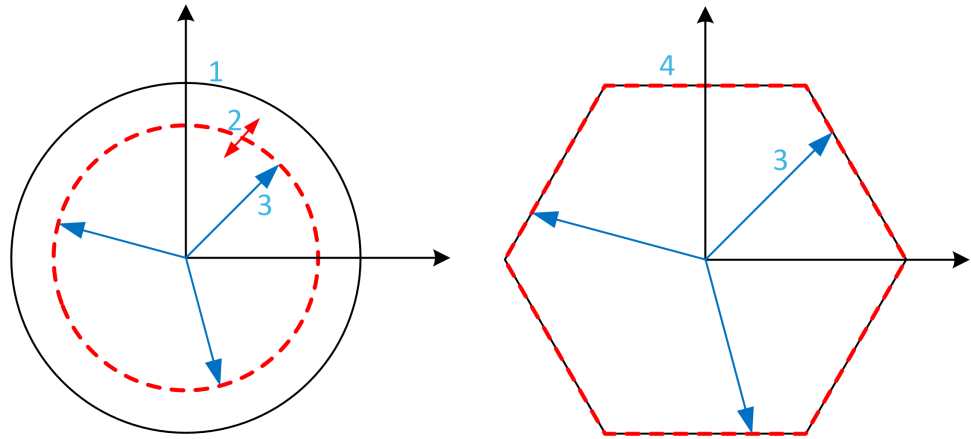

- 1 Maximum possible value of Output voltage limitation (default value)
- 2 VLim with numeric value under the maximum limitation
- 3 Output voltage
- 4 Output voltage limitation with full overmodulation (hexagon form)

Setting	Code / Value	Description
[Default]	DEFAULT	Overmodulation is not configured By default, the Output voltage limitation describes a circle with at maximum radius depending of DC bus voltage. The radius can be reduced to a lower value by setting a numerical value to [Output Voltage Limit] VLIM. <b>Factory setting</b>
[Full]	FULL	Overmodulation is active and full. The output voltage limitation describes a regular hexagon depending of DC bus voltage. The phase to phase voltages are not sinusoidal.

## [Output Voltage Limit] VLIM

This parameter can be accessed if [Access Level] LAC is set to [Expert] EPR.

The purpose of this parameter is to modify the output voltage limitation to a lower value than the maximum default value.

The unit of the numerical value of this parameter is in phase to phase rms voltage.

This parameter cannot be set to a numerical value if [Overmodul. Activation] OVMA is set to [Full] FULL.

Setting	Code / Value	Description
[Default]	DEFAULT	Default value of Output Voltage limitation. The Output Voltage limitation is at the maximum capability of the DC bus voltage depending on [Overmodul. Activation] OVMA setting. <b>Factory setting</b>
0...9999 V		Setting range of the output limitation voltage. Set a value lower than the corresponding [Default] DEFAULT value to reduce the maximum output voltage limitation. If the numerical value is higher than the corresponding [Default] DEFAULT value, this corresponding value is considered.

## [Switching frequency] SWF- Menu

### Access

[Complete settings] → [Motor parameters] → [Switching frequency]

### [Switching frequency] SFR

Adjustment range: The maximum value is limited to 4 kHz if [Motor surge limit.] SVL parameter is configured.

If [Sinus Filter Activation] OFI is set to [Yes] YES, the minimum value is 2 kHz and the maximum value is limited to 6 kHz or 8 kHz according to drive rating.

**NOTE:** In the event of excessive temperature rise, the drive automatically reduces the switching frequency and reset it once the temperature returns to normal.

In case of high-speed motor, it is advised to increase the PWM frequency [Switching frequency] SFR at 8, 12 kHz or 16 kHz

Setting ( )	Description
2...8 or 16 kHz according to drive rating	Setting range <b>Factory setting:</b> 4.0 kHz or 2.5 kHz according to the drive rating

### [Noise Reduction] NRD

Random frequency modulation helps to prevent any resonance, which may occur at a fixed frequency.

Setting	Code / Value	Description
[No]	NO	Fixed PWM frequency <b>Factory setting</b>
[Yes]	YES	PWM Frequency with random modulation

### [Switch Freq Type] SFT ★

This parameter can be accessed if [Access Level] LAC is set to [Expert] EPR.

The motor switching frequency is modified (reduced) when the internal temperature of the drive is too high.

Setting ( )	Code / Value	Description
[SFR type 1]	HF1	Heating loss optimization  Allows the system to adapt the switching frequency according to the motor frequency. This setting optimizes the heating loss of the drive in order to improve the drive efficiency.  <b>Factory setting</b>
[SFR type 2]	HF2	Allows the system to keep a constant chosen switching frequency [Switching frequency] SFR whatever the motor frequency [Motor Frequency] RFR.  With this setting, the motor noise is kept as low as possible by a high switching frequency.  In the event of overheating, the drive automatically decreases the switching frequency.  It is restored to its original value when the temperature returns to normal.

## [Motor surge limit.] SVL

This parameter is forced to [No] NO if [Sinus Filter Activation] OFI is set to [Yes] YES.

This function limits motor over-voltages and is useful in the following applications:

- NEMA motors
- Old or poor quality motors
- Spindle motors
- Rewound motors

This parameter can remain set to [No] NO for 230/400 Vac motors used at 230 Vac, or if the length of cable between the drive and the motor does not exceed:

- 4 m with unshielded cables
- 10 m with shielded cables

Setting	Code / Value	Description
[No]	NO	Function inactive  <b>Factory setting</b>
[Yes]	YES	Function active  <b>NOTE:</b> With this setting, the maximum of [Switching frequency] SFR is modified.

## [Attenuation Time] SOP ★

This parameter can be accessed if [Motor surge limit.] SVL is set to [Yes] YES.

The value of the [Attenuation Time] SOP parameter corresponds to the attenuation time of the cable used. It is defined to help to prevent the superimposition of voltage wave reflections resulting from long cable lengths. It limits over-voltages to twice the DC bus rated voltage. As surge voltage depends on many parameters such as types of cable, different motor powers in parallel, different cable lengths in parallel, and so on. It is recommended to use an oscilloscope to check the over-voltage values obtained at the motor terminals. If the higher value of [Attenuation Time] SOP is not enough according to the cable lengths, an output filter or a dV/dt filter must be used.

To retain the overall drive performance, do not increase the SOP value unnecessarily.

Setting	Code / Value	Description
[6 µs]	6	6 µs
[8 µs]	8	8 µs <b>Factory setting</b>
[10 µs]	10	10 µs

## [Input Filter] DCR– Menu

### Access

[Complete settings] → [Motor parameters] → [Input Filter]

### About This Menu

This function monitors the ripple on the DC bus by detecting instabilities. It is not used to detect input phase loss.

On the DC bus, if the oscillation frequencies are inconsistent with those observed on the mains supply, and if the amplitude is inconsistent with the drive capability (such as the DC bus capacitors), the drive triggers **[DC Bus Ripple Warn]** DCRW warning.

Depending on the setting of **[DC Bus Ripple Config]** DCRC, if **[DC Bus Ripple Warn]** DCRW warning is persistent during an amount of time set by an internal fixed value, **[DC Bus Ripple Error]** DCRE error is triggered.

### [Input Filter] IFI

This parameter is forced to **[No]** NO if:

- **[Motor control type]** CTT is set to a value different from **[U/F VC 5pts]** UF5, or
- **[Motor control type]** CTT is set to **[U/F VC 5pts]** UF5, and
  - **[U1]** U1 or ... or **[U5]** U5 is configured, or
  - **[F1]** F1 or ... or **[F5]** F5 is configured.

Setting	Code / Value	Description
<b>[No]</b>	NO	No input filter used.  <b>Factory setting</b>
<b>[Yes]</b>	YES	Motor control performance is adjusted to consider the use of an input filter in order to help to prevent ripple on the DC bus.

### [DC Bus Ripple Config] DCRC

This parameter is preset to **[Error]** FLT, if **[Input Filter]** IFI is set to **[Yes]** YES.

Setting	Code / Value	Description
<b>[Ignore]</b>	NO	DC bus ripple monitoring function is inactive.  This selection can't be accessed if <b>[Input Filter]</b> IFI is set to <b>[Yes]</b> YES.  <b>Factory setting</b>
<b>[Warning]</b>	WARN	DC bus ripple monitoring function is enabled.  In case of DC bus ripple, the drive triggers <b>[DC Bus Ripple Warn]</b> DCRW warning.
<b>[Error]</b>	FLT	The DC bus ripple monitoring function is fully enabled. The drive triggers <b>[DC Bus Ripple Error]</b> DCRE error if <b>[DC Bus Ripple Warn]</b> DCRW warning is persistent.



## [Define system units]

### [Define system units] SUC- Menu

#### Access

[Complete settings] → [Define system units]

#### About This Menu

In order to be easy to configure, commission, operate, and maintain, the drive uses the application units.

The physicals that are concerned by application units are:

- Temperature values
- Currency values

**NOTE:** Some other default system units are automatically deduced from configurable system units or from other parameters.

System unit applies by default to all communication parameters and HMI (Display Terminal, Web server, DTM-based software).

When a system unit is changed, there is no rescaling of values. Numerical values are kept, but the meaning of these values is not the same:

- After a change, the behavior of the product does not change (the system stays numerically the same).
- If new values are written through communication or through HMI in new unit, then the behavior is impacted. In that case, all parameters should be reconfigured according to the new selected unit.
- In order to avoid issues due to a modification of system unit parameters, system units should be modified only during the installation of the product and before the commissioning of the functions.

The precision of the physical values is selected at the same time as the unit.

By default, values are signed.

Default range of values are:

16 bits values	32 bits values
-32,768...32,767	-2,147,483,648...2,147,483,648

### [Temperature unit] SUTP

Available temperature units:

Unit	Symbol	Conversion
Celsius Degree	°C	-
Fahrenheit Degree	°F	$TF = 9/5 * Tc + 32$

Setting	Code / Value	Description
[0.1°C]	01C	0.1 °C <b>Factory setting</b>
[0.1°F]	01F	0.1 °F

## [Currency unit list] SUCU

Default system application unit used for currency.

Setting	Code / Value	Description
[Euro]	EURO	Euro <b>Factory setting</b>
[\$]	DOLLAR	Dollar
[£]	POUND	Pound
[Krone]	KR	Krone
[Renminbi]	RMB	Renminbi
[Other]	OTHER	Other

## [Command and Reference] CRP– Menu

### [Command and Reference] CRP– Menu

#### Access

[Complete settings] → [Command and Reference]

### Command and Reference Channels Parameter Can Be Accessed

Run commands (forward, reverse, stop, and so on) and references can be sent using the following channels:

Command	Reference
Terminals: Digital inputs DI	Terminals: Analog inputs AI, pulse input
Display Terminal	Display Terminal
Integrated Modbus	Integrated Modbus
CANopen®	CANopen
Fieldbus module	Fieldbus module
–	+/- speed via the Display Terminal
Integrated Ethernet	Integrated Ethernet <b>NOTE:</b> This selection can be accessed on ATV340•••N4E drives.

**NOTE:** The stop keys on the Display Terminal can be programmed as non-priority keys. A stop key can only have priority if the **[Stop Key Enable]** PST parameter menu is set to **[Stop Key Priority]** YES or **[Stop Key Priority All]** ALL.

The behavior of the drive can be adapted according to requirements:

- **[Not separ.]** SIM: Command and reference are sent via the same channel.
- **[Separate]** SEP: Command and reference may be sent via different channels. In these configurations, control via the communication bus is performed in accordance with the DRIVECOM standard with only 5 freely assignable bits (see communication parameter manual). The application functions cannot be accessed via the communication interface.
- **[I/O profile]** IO: The command and the reference can come from different channels. This configuration both simplify and extends use via the communication interface. Commands may be sent via the digital inputs on the terminals or via the communication bus. When commands are sent via a bus, they are available on a word, which acts as virtual terminals containing only digital inputs. Application functions can be assigned to the bits in this word. More than one function can be assigned to the same bit.

**NOTE:** Stop commands from the Display Terminal remain active even if the terminals are not the active command channel.

## Reference Channel for [Not separ.] SIM, [Separate] SEP and [I/O profile] IO Configurations, PID Not Configured

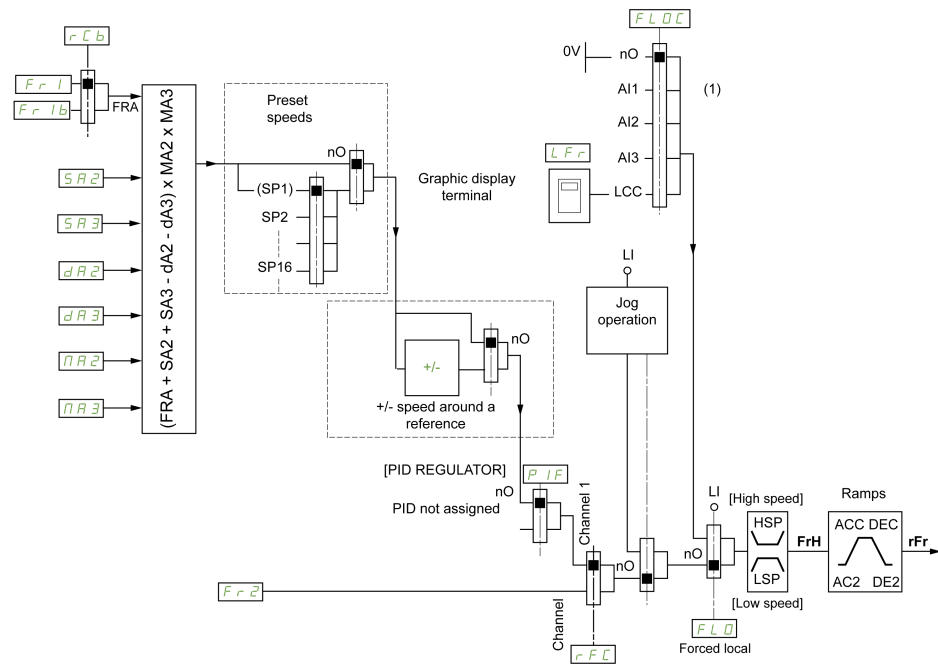

**(1) Note:** Forced local is not active in IO.

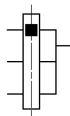

The black square represents the factory setting assignment.

**FR1:** terminals (including I/O extension module), Display Terminal, integrated Modbus, CANopen®, embedded Ethernet, DI7 PulseInput, DI8 PulseInput.

**FR1B,** for SEP and IO: terminals (including I/O extension module), Display Terminal, integrated Modbus, CANopen®, embedded Ethernet, DI7 PulseInput, DI8 PulseInput.

**FR1B,** for SIM: terminals (including I/O extension module), DI7 PulseInput, DI8 PulseInput.

**SA2, SA3, DA2, DA3, MA2, MA3:** terminals (including I/O extension module), Display Terminal, integrated Modbus, CANopen®, embedded Ethernet, DI7 PulseInput, DI8 PulseInput, and AI Virtual 1.

**FR2:** terminals (including I/O extension module), Display Terminal, integrated Modbus, CANopen®, embedded Ethernet, and Ref Freq via DI..

## Reference Channel for [Not separ.] SIM, [Separate] SEP and [I/O profile] IO Configurations, PID Configured with PID References at the Terminals

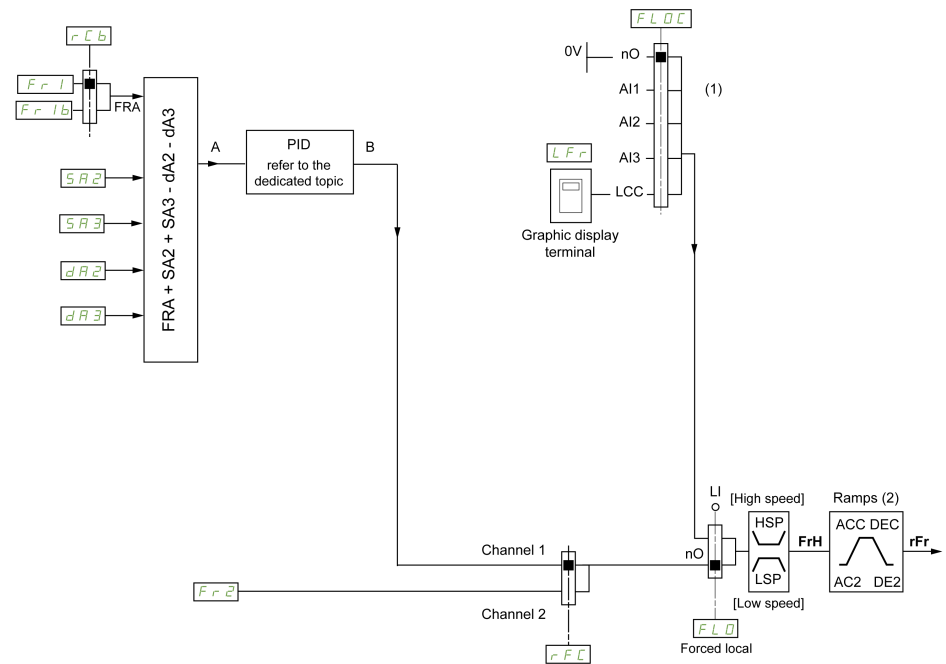

(1) **Note:** Forced local is not active in [I/O profile].

(2) Ramps not active if the PID function is active in automatic mode.

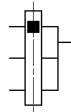

The black square represents the factory setting assignment.

**FR1:** terminals (including I/O extension module), Display Terminal, integrated Modbus, CANopen®, embedded Ethernet, DI7 PulseInput, DI8 PulseInput.

**FR1B,** for **SEP** and **IO:** terminals (including I/O extension module), Display Terminal, integrated Modbus, CANopen®, embedded Ethernet, DI7 PulseInput, DI8 PulseInput.

**FR1B,** for **SIM:** terminals (including I/O extension module), DI7 PulseInput, DI8 PulseInput.

**SA2, SA3, DA2, DA3:** terminals (including I/O extension module), Display Terminal, integrated Modbus, CANopen®, embedded Ethernet, DI7 PulseInput, DI8 PulseInput.

**FR2:** terminals (including I/O extension module), Display Terminal, integrated Modbus, CANopen®, embedded Ethernet, and Ref Freq via DI..

## Command Channel for [Not separ.] SIM configuration

Reference and command, not separate.

The command channel is determined by the reference channel. The parameters **FR1, FR2, RFC, FLO** and **FLOC** are common to reference and command.

Example: If the reference is **FR1 = AI1** (analog input at the terminals), control is via DI (digital input at the terminals).

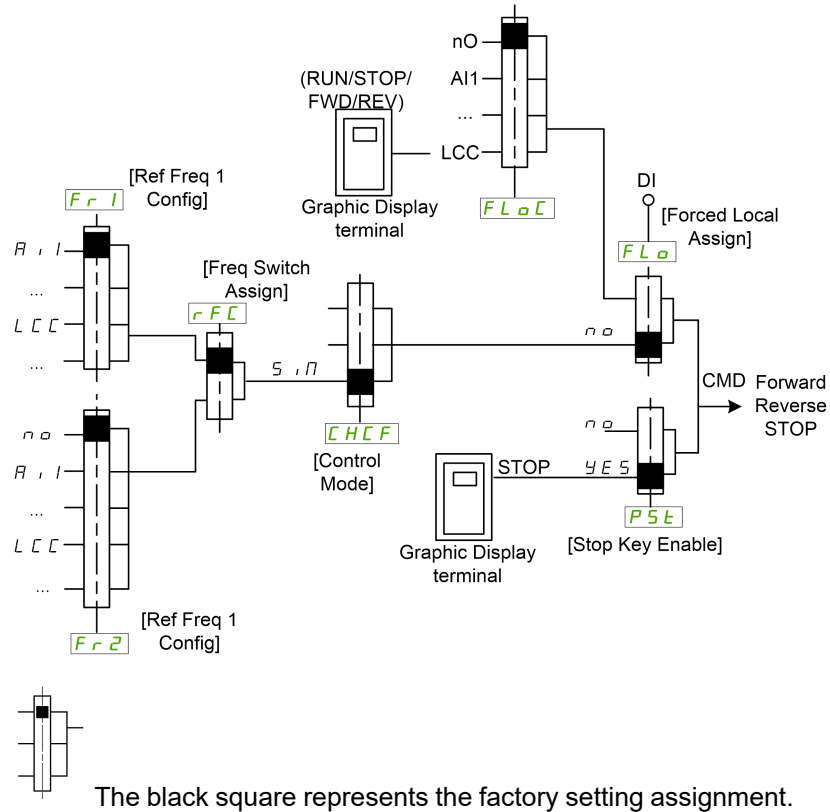

## Command Channel for [Separate] SEP configuration

Separated Reference and command.

The parameters FLO and FLOC are common to reference and command.

Example: If the reference is in forced local mode via AI1 (analog input at the terminals), command in forced local mode is via DI (digital input at the terminals).

The command channels CD1 and CD2 are independent of the reference channels FR1, FR1B and FR2.

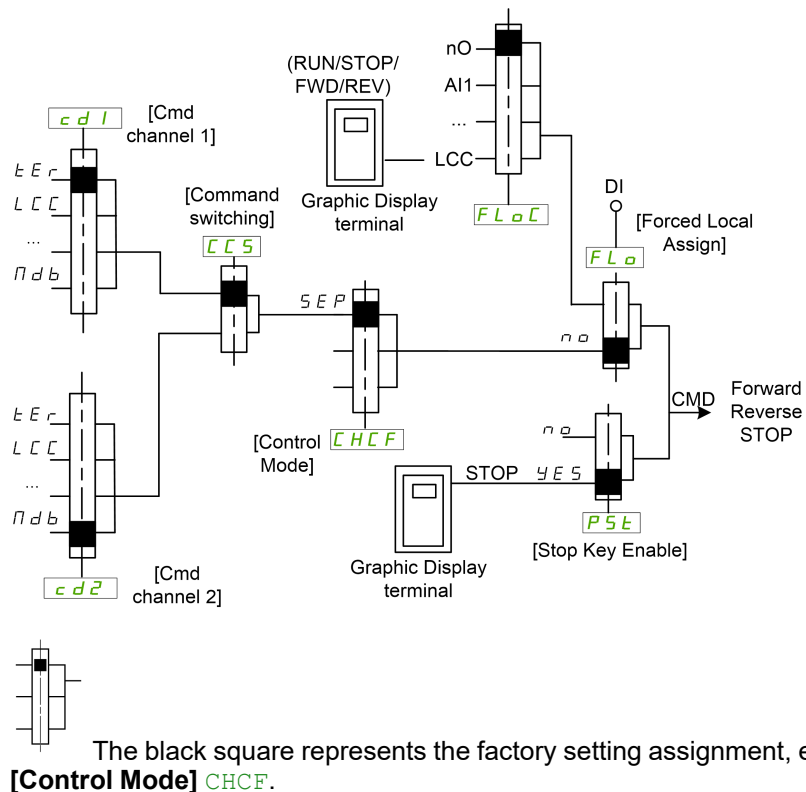

[Cmd channel 1] CD1 and [Cmd channel 2] CD2: Terminals, Display Terminal, integrated Modbus, integrated CANopen®, communication card

## Command Channel for [I/O profile] IO configuration

Separated Reference and command, as in [Separate] SEP configuration.

The command channels CD1 and CD2 are independent of the reference channels FR1, FR1B and FR2.

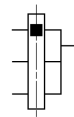
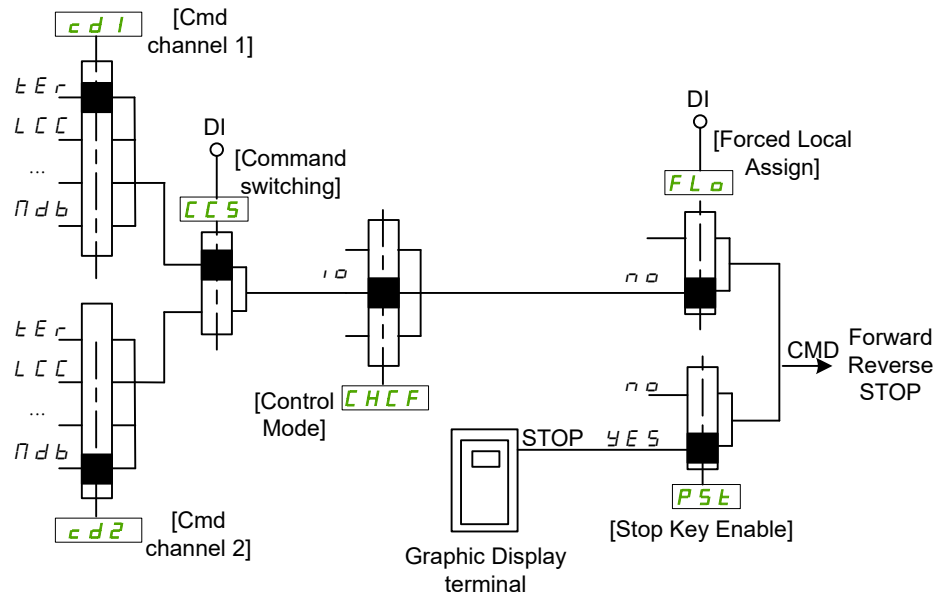

The black square represents the factory setting assignment, except for [Control Mode] CHCF.

[Cmd channel 1] CD1 and [Cmd channel 2] CD2: Terminals, Display Terminal, integrated Modbus, integrated CANopen®, communication card

A command or an action can be assigned:

- To a fixed channel by selecting a Digital input (Dix) or a Cxxx bit:
  - By selecting, for example, LI3, this action is triggered by the digital input D13 regardless of which command channel is switched.
  - By selecting, for example, C114, this action is triggered by integrated Modbus with bit 14 regardless of which command channel is switched.
- To a switchable channel by selecting a CDxx bit:
  - By selecting, for example, Cd11, this action is triggered by: LI12 if the terminals channel is active, C111 if the integrated Modbus channel is active, C211 if the integrated CANopen® channel is active, C311 if the communication card channel is active, C511 if the Ethernet channel is active.

If the active channel is the graphic display terminal, the functions and commands assigned to CDxx switchable internal bits are inactive.

**NOTE:** Several CDxx does not have equivalent digital inputs and can only be used for switching between 2 networks.

## [Ref Freq 1 Config] FR1

**Configuration reference frequency 1.**

Setting	Code / Value	Description
[Not Configured]	NO	Not assigned
[AI1]	AI1	Analog input AI1 <b>Factory Setting</b>
[AI2]...[AI3]	AI2...AI3	Analog input AI2...AI3 <b>NOTE:</b> AI3 selection can be accessed on drives with a power greater than 22 kW.
[AI Virtual 1]	AIV1	Virtual analogic input 1
[AI4]...[AI5]	AI4...AI5	Analog input AI4...AI5 if VW3A3203 I/O extension module has been inserted
[HMI]	LCC	Reference Frequency via remote terminal
[Ref. Freq-Modbus]	MDB	Reference frequency via Modbus
[Ref. Freq-CANopen]	CAN	Reference frequency via CANopen if a CANopen module has been inserted
[Ref. Freq-Com. Module]	NET	Reference frequency via fieldbus module if a fieldbus module has been inserted
[Embedded Ethernet]	ETH	Embedded Ethernet <b>NOTE:</b> This selection can be accessed on ATV340...N4E drives.
[RP]	PI	Pulse input <b>NOTE:</b> This selection can be accessed on drives with a power below than 30 kW.
[Encoder]	PG	Encoder reference if an encoder module has been inserted or embedded encoder is used. <b>NOTE:</b> Embedded encoder is only available on drives with power up to 22kW.

## [Ref.1B channel] FR1B

### Configuration ref. 1B.

Identical to [Ref Freq 1 Config] FR1 (see above) with factory setting: [Not Configured] NO.

## [Ref 1B switching] RCB

### ⚠ WARNING

#### UNANTICIPATED EQUIPMENT OPERATION

This parameter can cause unintended movements, for example, inversion of the direction of rotation of the motor, sudden acceleration or stops.

- Verify that the setting of this parameter does not cause unintended movements.
- Verify that the setting of this parameter does not result in unsafe conditions.

**Failure to follow these instructions can result in death, serious injury, or equipment damage.**

Select switching (1 to 1B).

- If the assigned input or bit is at 0, [Ref Freq 1 Config] FR1 is active.
- If the assigned input or bit is at 1, [Ref.1B channel] FR1B is active.



[Ref 1B switching] RCB is forced to [Ref Freq 1 Config] FR1 if [Control Mode] CHCF is set to [Not separ.] SIM with [Ref Freq 1 Config] FR1 assigned via the terminals (analog inputs, pulse input).

**NOTE:** Activating this function from an other active command channel also activates the monitoring of this new channel.

Setting	Code / Value	Description
[Ref Freq 1 Config]	FR1	Reference channel = channel 1 (for RCB)
[Ref.1B channel]	FR1B	Reference channel = channel 1b (for RCB)
[DI1]...[DI8]	LI1...LI8	Digital input DI1...DI8 <b>NOTE:</b> DI8 selection can be accessed on drives with a power greater than 22kW.
[DI11]...[DI16]	LI11...LI16	Digital input DI11...DI16 if VW3A3203 I/O extension module has been inserted
[CD00]... [CD10]	CD00...CD10	Virtual digital input CMD.0...CMD.10 in [I/O profile] IO configuration
[CD11]... [CD15]	CD11...CD15	Virtual digital input CMD.11...CMD.15 regardless of configuration
[C101]... [C110]	C101...C110	Virtual digital input CMD1.01...CMD1.10 with integrated Modbus Serial in [I/O profile] IO configuration
[C111]... [C115]	C111...C115	Virtual digital input CMD1.11...CMD1.15 with integrated Modbus Serial regardless of configuration
[C201]... [C210]	C201...C210	Virtual digital input CMD2.01...CMD2.10 with CANopen® fieldbus module in [I/O profile] IO configuration
[C211]... [C215]	C211...C215	Virtual digital input CMD2.11...CMD2.15 with CANopen® fieldbus module regardless of configuration
[C301]... [C310]	C301...C310	Virtual digital input CMD3.01...CMD3.10 with a fieldbus module in [I/O profile] IO configuration
[C311]... [C315]	C311...C315	Virtual digital input CMD3.11...CMD3.15 with a fieldbus module regardless of configuration
[C501]... [C510]	C501...C510	Virtual digital input CMD5.01...CMD5.10 with integrated Ethernet in [I/O profile] IO configuration <b>NOTE:</b> This selection can be accessed on ATV340...N4E drives.
[C511]... [C515]	C511...C515	Virtual digital input CMD5.11...CMD5.15 with integrated Ethernet regardless of configuration <b>NOTE:</b> This selection can be accessed on ATV340...N4E drives.

## [Reverse Disable] RIN

Lock of movement in reverse direction does not apply to direction requests sent by digital inputs.

Reverse direction requests sent by digital inputs are taken into account.

Reverse direction requests sent by the Display Terminal or sent by the line are not taken into account.

Any reverse speed reference originating from the PID, summing input, and so on, is interpreted as a zero reference (0 Hz).

Setting	Code / Value	Description
[No]	NO	Motor rotation direction is defined by the run command <b>[Forward] FRD</b> or <b>[Reverse Assign] RRS</b> and the sign of the reference frequency.  When the reference frequency is positive and a: <ul style="list-style-type: none"> <li><b>[Forward] FRD</b> run command is given: the motor starts in forward direction</li> <li><b>[Reverse Assign] RRS</b> run command is given: the motor starts in reverse direction</li> </ul> When the reference frequency is negative and a: <ul style="list-style-type: none"> <li><b>[Forward] FRD</b> run command is given: the motor starts in reverse direction</li> <li><b>[Reverse Assign] RRS</b> run command is given: the motor starts in forward direction</li> </ul>
[Yes]	YES	Any reverse speed reference originating from the PID, summing input, and so on, is interpreted as a zero reference (0 Hz).
[Absolute]	ABS	Motor rotation direction is defined by the run command <b>[Forward] FRD</b> or <b>[Reverse Assign] RRS</b> regardless of the sign of the reference frequency (i.e. only the absolute value of the reference frequency is considered).

## [Control Mode] CHCF

### WARNING

#### UNANTICIPATED EQUIPMENT OPERATION

Disabling **[I/O profile] IO** resets the drive to the factory settings.

- Verify that restoring the factory settings is compatible with the type of wiring used.

**Failure to follow these instructions can result in death, serious injury, or equipment damage.**

Setting	Code / Value	Description
[Not separ.]	SIM	Reference and command, not separate  <b>Factory Setting</b>
[Separate]	SEP	Separate reference and command. This assignment cannot be accessed in <b>[I/O profile] IO</b>
[I/O profile]	IO	I/O profile

## [Command Switching] CCS

### WARNING

#### UNANTICIPATED EQUIPMENT OPERATION

This parameter can cause unintended movements, for example, inversion of the direction of rotation of the motor, sudden acceleration or stops.

- Verify that the setting of this parameter does not cause unintended movements.
- Verify that the setting of this parameter does not result in unsafe conditions.

**Failure to follow these instructions can result in death, serious injury, or equipment damage.**

Control channel switch.

This parameter can be accessed if [Control Mode] **CHCF** is set to [Separate] **SEP** or to [I/O profile] **IO**.

If the assigned input or bit is at 0, channel [Cmd channel 1] **CD1** is active. If the assigned input or bit is at 1, channel [Cmd channel 2] **CD2** is active.

**NOTE:** Activating this function from an other active command channel also activates the monitoring of this new channel.

Setting	Code / Value	Description
[Cmd channel 1]	CD1	Command channel = channel 1 (for CCS) <b>Factory setting</b>
[Cmd channel 2]	CD2	Command channel = channel 2 (for CCS)
[DI1]...[DI8]	LI1...LI8	Digital input DI1...DI8 <b>NOTE:</b> DI8 selection can be accessed on drives with a power greater than 22kW.
[DI11]...[DI16]	LI11...LI16	Digital input DI11...DI16 if VW3A3203 I/O extension module has been inserted
[C101]... [C110]	C101...C110	Virtual digital input CMD1.01...CMD1.10 with integrated Modbus Serial in [I/O profile] <b>IO</b> configuration
[C111]... [C115]	C111...C115	Virtual digital input CMD1.11...CMD1.15 with integrated Modbus Serial regardless of configuration
[C201]... [C210]	C201...C210	Virtual digital input CMD2.01...CMD2.10 with CANopen® fieldbus module in [I/O profile] <b>IO</b> configuration
[C211]... [C215]	C211...C215	Virtual digital input CMD2.11...CMD2.15 with CANopen® fieldbus module regardless of configuration
[C301]... [C310]	C301...C310	Virtual digital input CMD3.01...CMD3.10 with a fieldbus module in [I/O profile] <b>IO</b> configuration
[C311]... [C315]	C311...C315	Virtual digital input CMD3.11...CMD3.15 with a fieldbus module regardless of configuration
[C501]... [C510]	C501...C510	Virtual digital input CMD5.01...CMD5.10 with integrated Ethernet in [I/O profile] <b>IO</b> configuration <b>NOTE:</b> This selection can be accessed on ATV340...N4E drives.
[C511]... [C515]	C511...C515	Virtual digital input CMD5.11...CMD5.15 with integrated Ethernet regardless of configuration <b>NOTE:</b> This selection can be accessed on ATV340...N4E drives.

## [Cmd channel 1] **CD1** ★

This parameter can be accessed if [Control Mode] **CHCF** is set to [Separate] **SEP** or [I/O profile] **IO**.

Setting	Code / Value	Description
[Terminal]	TER	Terminal block source <b>Factory Setting</b>
[HMI]	LCC	Command via Display Terminal
[Ref. Freq-Modbus]	MDB	Command via Modbus
[Ref. Freq-CANopen]	CAN	Command via CANopen if a CANopen module has been inserted
[Ref. Freq-Com. Module]	NET	Command via fieldbus module if a fieldbus module has been inserted
[Embedded Ethernet]	ETH	Command via Embedded Ethernet <b>NOTE:</b> This selection can be accessed on ATV340...N4E drives.

**[Cmd channel 2] CD2** ★

This parameter can be accessed if **[Control Mode] CHCF** is set to **[Separate] SEP** or **[I/O profile] IO**.

Identical to **[Cmd channel 1] CD1** with factory setting **[Ref. Freq-Modbus] MDB**.

**[Freq Switch Assign] RFC****⚠ WARNING****UNANTICIPATED EQUIPMENT OPERATION**

This parameter can cause unintended movements, for example, inversion of the direction of rotation of the motor, sudden acceleration or stops.

- Verify that the setting of this parameter does not cause unintended movements.
- Verify that the setting of this parameter does not result in unsafe conditions.

**Failure to follow these instructions can result in death, serious injury, or equipment damage.**

frequency switching assignment.

If the assigned input or bit is at 0, channel **[Ref Freq 1 Config] FR1** is active.

If the assigned input or bit is at 1, channel **[Ref Freq 2 Config] FR2** is active.

**NOTE:** Activating this function from an other active command channel also activates the monitoring of this new channel.

Setting	Code / Value	Description
<b>[Ref Freq 1 Config]</b>	FR1	Reference channel = channel 1 (for RFC)
<b>[Ref Freq 2 Config]</b>	FR2	Reference channel = channel 2 (for RFC)
<b>[DI1]...[DI8]</b>	LI1...LI8	Digital input DI1...DI8 <b>NOTE:</b> DI8 selection can be accessed on drives with a power greater than 22kW.
<b>[DI11]...[DI16]</b>	LI11...LI16	Digital input DI11...DI16 if VW3A3203 I/O extension module has been inserted
<b>[CD00]... [CD10]</b>	CD00...CD10	Virtual digital input CMD.0...CMD.10 in <b>[I/O profile] IO</b> configuration
<b>[CD11]... [CD15]</b>	CD11...CD15	Virtual digital input CMD.11...CMD.15 regardless of configuration
<b>[C101]... [C110]</b>	C101...C110	Virtual digital input CMD1.01...CMD1.10 with integrated Modbus Serial in <b>[I/O profile] IO</b> configuration
<b>[C111]... [C115]</b>	C111...C115	Virtual digital input CMD1.11...CMD1.15 with integrated Modbus Serial regardless of configuration
<b>[C201]... [C210]</b>	C201...C210	Virtual digital input CMD2.01...CMD2.10 with CANopen® fieldbus module in <b>[I/O profile] IO</b> configuration
<b>[C211]... [C215]</b>	C211...C215	Virtual digital input CMD2.11...CMD2.15 with CANopen® fieldbus module regardless of configuration
<b>[C301]... [C310]</b>	C301...C310	Virtual digital input CMD3.01...CMD3.10 with a fieldbus module in <b>[I/O profile] IO</b> configuration
<b>[C311]... [C315]</b>	C311...C315	Virtual digital input CMD3.11...CMD3.15 with a fieldbus module regardless of configuration

Setting	Code / Value	Description
[C501]... [C510]	C501...C510	Virtual digital input CMD5.01...CMD5.10 with integrated Ethernet in [I/O profile] IO configuration <b>NOTE:</b> This selection can be accessed on ATV340...N4E drives.
[C511]... [C515]	C511...C515	Virtual digital input CMD5.11...CMD5.15 with integrated Ethernet regardless of configuration <b>NOTE:</b> This selection can be accessed on ATV340...N4E drives.

## [Ref Freq 2 Config] FR2

### Configuration reference frequency 2.

Setting	Code / Value	Description
[Not Configured]	NO	Not assigned. If [Control Mode] CHCF is set to [Not separ.] SIM, the command is at the terminals with a zero reference. If [Control Mode] CHCF is set to [Separate] SEP or [I/O profile] IO, the reference is zero. <b>Factory Setting</b>
[AI1]...[AI3]	AI1...AI3	Analog input AI1...AI3 <b>NOTE:</b> AI3 selection can be accessed on drives with a power greater than 22kW.
[AI4]...[AI5]	AI4...AI5	Analog input AI4...AI5 if VW3A3203 I/O extension module has been inserted
[AI Virtual 1]	AIV1	Virtual analogic input 1
[Ref Frequency via DI]	UPDT	+/- speed command assigned to DIx
[HMI]	LCC	Reference frequency via Graphic Display Terminal
[Ref. Freq-Modbus]	MDB	Reference frequency via Modbus
[Ref. Freq-CANopen]	CAN	Reference frequency via CANopen if a CANopen module has been inserted
[Ref. Freq-Com. Module]	NET	Reference frequency via fieldbus module if a fieldbus module has been inserted
[Embedded Ethernet]	ETH	Integrated Ethernet <b>NOTE:</b> This selection can be accessed on ATV340...N4E drives.
[DI7 PulseInput]... [DI8 PulseInput]	PI7...PI8	Digital input DI7...DI8 used as pulse input <b>NOTE:</b> This selection can be accessed on drives with a power greater than 22 kW.
[RP]	PI	Pulse input <b>NOTE:</b> This selection can be accessed on drives with a power below than 30 kW.
[Encoder]	PG	Encoder reference if an encoder module has been inserted or embedded encoder is used. <b>NOTE:</b> Embedded encoder is only available on drives with power up to 22kW.

## [Copy Ch1-Ch2] COP

Copy channel 1 reference frequency to channel 2.

**⚠ WARNING****UNANTICIPATED EQUIPMENT OPERATION**

This parameter can cause unintended movements, for example, inversion of the direction of rotation of the motor, sudden acceleration or stops.

- Verify that the setting of this parameter does not cause unintended movements.
- Verify that the setting of this parameter does not result in unsafe conditions.

**Failure to follow these instructions can result in death, serious injury, or equipment damage.**

Can be used to copy the current reference and/or the command with switching in order to avoid speed surges, for example.

If **[Control Mode] CHCF**, page 194 is set to **[Not separ.] SIM** or **[Separate] SEP**, copying is possible only from channel 1 to channel 2. If **[Control Mode] CHCF** is set to **[I/O profile] IO**, copying is possible in both directions.

A reference or a command cannot be copied to a channel on the terminals. The reference copied is **[Pre-Ramp Ref Freq] FRH** (before ramp) unless the destination channel reference is set via +/- speed. In this case, the reference copied is **[Motor Frequency] RFR** (after ramp). When **[Reverse Disable] RIN** is set to **[Absolute] ABS** and **[HMI L/R cmd] BMP** is set to **[Bumpless] BMP**, the copied reference to the destination channel (**[HMI] LCC**) is **[Ref Frequency] LFR**.

Setting	Code / Value	Description
<b>[No]</b>	NO	No copy <b>Factory Setting</b>
<b>[Reference Frequency]</b>	SP	Copy reference
<b>[Command]</b>	CD	Copy command  In I/O profile, when switching back to normal operation using fieldbus after a communication interruption with the fallback channel set to <b>[HMI] LCC</b> (activated by pressing the Local/ Remote key on the graphic display terminal), the command cannot be copied from the graphic display terminal.
<b>[Cmd + Ref Frequency]</b>	ALL	Copy reference and command  In I/O profile, when switching back to normal operation using fieldbus after a communication interruption with the fallback channel set to <b>[HMI] LCC</b> (activated by pressing the Local/ Remote key on the graphic display terminal), the command cannot be copied from the graphic display terminal.

As the Display Terminal may be selected as the command and/or reference channel, its action modes can be configured.

Comments:

- The Display Terminal command/reference is only active if the command and/or reference channels from the terminal are active except for *BMP* with Local/ Remote key (command via the Display Terminal), which takes priority over these channels. Press Local/ Remote key again to revert control to the selected channel.
- Command and reference via the Display Terminal are impossible if the latter is connected to more than one drive.
- The preset PID reference functions can only be accessed if **[Control Mode] CHCF** is set to **[Not separ.] SIM** or **[Separate] SEP**.
- The command via the Display Terminal can be accessed regardless of the **[Control Mode] CHCF**.

## [Forced Local Chan] FLOC

### Forced Local channel assignment.

Setting	Code / Value	Description
[Not Configured]	NO	Not assigned (control via the terminals with zero reference) <b>Factory Setting</b>
[AI1]...[AI3]	AI1...AI3	Analog input AI1...AI3 <b>NOTE:</b> AI3 selection can be accessed on drives with a power greater than 22kW.
[AI4]...[AI5]	AI4...AI5	Analog input AI4...AI5 if VW3A3203 I/O extension module has been inserted
[HMI]	LCC	Graphic Display Terminal
[DI7 PulseInput]... [DI8 PulseInput]	PI7...PI8	Digital input DI7...DI8 used as pulse input <b>NOTE:</b> This selection can be accessed on drives with a power greater than 22 kW.
[RP]	PI	Pulse input <b>NOTE:</b> This selection can be accessed on drives with a power below than 30 kW.
[Encoder]	PG	Encoder reference if an encoder module has been inserted or embedded encoder is used. <b>NOTE:</b> Embedded encoder is only available on drives with power up to 22kW.

## [Time-out forc. local] FLOT★

Time for channel confirmation after forced local.

This parameter can be accessed if [Forced Local Assign] FLO is not set to [Not Assigned] NO.

Setting ( )	Description
0.1...30.0 s	Setting range <b>Factory setting:</b> 10.0 s

## [Forced Local Assign] FLO

Forced local mode is active when the input is at state 1. In this state, new values of parameters cannot be written remotely via communication channels.

[Forced Local Assign] FLO is forced to [Not Assigned] NO if [Control Mode] CHCF is set to [I/O profile] IO.

Setting	Code / Value	Description
[Not Assigned]	NO	Not assigned <b>Factory setting</b>
[DI1]...[DI8]	LI1...LI8	Digital input DI1...DI8 <b>NOTE:</b> DI8 selection can be accessed on drives with a power greater than 22kW.
[DI11]...[DI16]	LI11...LI16	Digital input DI11...DI16 if VW3A3203 I/O extension module has been inserted

**[Reverse Assign] RRS****Reverse assignment.**

Value range	Code / Value	Description
[Not Assigned]	NO	Not assigned <b>Factory setting</b>
[DI1]...[DI8]	LI1...LI8	Digital input DI1...DI8 <b>NOTE:</b> DI8 selection can be accessed on drives with a power greater than 22kW.
[DI11]...[DI16]	LI11...LI16	Digital input DI11...DI16 if VW3A3203 I/O extension module has been inserted
[CD00]... [CD10]	CD00...CD10	Virtual digital input CMD.0...CMD.10 in <b>[I/O profile]</b> IO configuration
[CD11]... [CD15]	CD11...CD15	Virtual digital input CMD.11...CMD.15 regardless of configuration
[C101]... [C110]	C101...C110	Virtual digital input CMD1.01...CMD1.10 with integrated Modbus Serial in <b>[I/O profile]</b> IO configuration
[C111]... [C115]	C111...C115	Virtual digital input CMD1.11...CMD1.15 with integrated Modbus Serial regardless of configuration
[C201]... [C210]	C201...C210	Virtual digital input CMD2.01...CMD2.10 with CANopen® fieldbus module in <b>[I/O profile]</b> IO configuration
[C211]... [C215]	C211...C215	Virtual digital input CMD2.11...CMD2.15 with CANopen® fieldbus module regardless of configuration
[C301]... [C310]	C301...C310	Virtual digital input CMD3.01...CMD3.10 with a fieldbus module in <b>[I/O profile]</b> IO configuration
[C311]... [C315]	C311...C315	Virtual digital input CMD3.11...CMD3.15 with a fieldbus module regardless of configuration
[C501]... [C510]	C501...C510	Virtual digital input CMD5.01...CMD5.10 with integrated Ethernet in <b>[I/O profile]</b> IO configuration <b>NOTE:</b> This selection can be accessed on ATV340***N4E drives.
[C511]... [C515]	C511...C515	Virtual digital input CMD5.11...CMD5.15 with integrated Ethernet regardless of configuration <b>NOTE:</b> This selection can be accessed on ATV340***N4E drives.

**[2/3-Wire Control] TCC** **⚠ WARNING****UNANTICIPATED EQUIPMENT OPERATION**

If this parameter is changed, the parameters **[Reverse Assign] RRS** and **[2/3-Wire Control] TCC** and the assignments of the digital inputs are reset to the factory setting.

- Verify that this change is compatible with the type of wiring used.

**Failure to follow these instructions can result in death, serious injury, or equipment damage.**

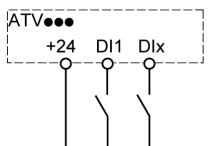
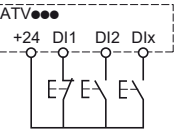

Setting	Code / Value	Description
[2-Wire Control]	2C	<p><b>2-wire control (level commands):</b> This is the input state (0 or 1) or edge (0 to 1 or 1 to 0), which controls running or stopping.</p> <p>Example of <b>source</b> wiring:</p>  <p><b>DI1</b> Forward <b>DIx</b> Reverse <b>Factory setting</b></p>
[3-Wire Control]	3C	<p><b>3-wire control (pulse commands) [3 wire]:</b> A Stop level command is used to allow enabling a run command through DI2 or DIX or stopping. A <b>[Forward]</b> or <b>[Reverse Assign]</b> pulse is sufficient to command starting.</p> <p>Example of <b>source</b> wiring:</p>  <p><b>DI1</b> Stop <b>DI2</b> Forward <b>DIx</b> Reverse</p>

[2-wire type] TCT★🕒

This parameter can be accessed if [2/3-Wire Control] TCC is set to [2-Wire Control] 2C.

## ⚠ WARNING

**UNANTICIPATED EQUIPMENT OPERATION**

Verify that the parameter setting is compatible with the type of wiring used.

**Failure to follow these instructions can result in death, serious injury, or equipment damage.**

Setting	Code / Value	Description
[Level]	LEL	State 0 or 1 is taken into account for run (1) or stop (0)
[Transition]	TRN	<p>A change of state (transition or edge) is necessary to initiate operation in order to avoid accidental restarts after a break in the supply mains</p> <p><b>Factory setting</b></p>
[Level With Fwd Priority]	PFO	State 0 or 1 is taken into account for run or stop, but the "forward" input takes priority over the "reverse" input

## [Stop Key Enable] PST

Setting this function to No disables the Stop keys of the Display Terminals if the setting of the parameter [Command Channel] CMDC is not [HMI] LCC.

### ⚠ WARNING

#### LOSS OF CONTROL

Only set this parameter to [Stop Key No Priority] NO if you have implemented appropriate alternative stop functions.

**Failure to follow these instructions can result in death, serious injury, or equipment damage.**

If 2-wire control by level is active (parameter [2/3-Wire Control] TCC set to 2C and parameter [2-wire type] TCT set to LEL or PFO) and the parameter [Stop Key Enable] PST is set to ALL, the motor starts if the STOP/RESET key of the Graphic Display Terminal is pressed while a run command is active.

### ⚠ WARNING

#### UNANTICIPATED EQUIPMENT OPERATION

Only set the parameter [Stop Key Enable] PST to [ALL] in 2-wire control by level after having verified that this setting cannot result in unsafe conditions.

**Failure to follow these instructions can result in death, serious injury, or equipment damage.**

Irrespective of the configuration of [Stop Key Enable] PST, if the active command channel is the Graphic Display Terminal, the STOP/RESET key performs:

- in run, a stop according to the [Type of stop] STT,
- in "Operating State Fault", a fault reset command.

The following table gives the behavior of the function when the Graphic Display Terminal is not the active command channel:

Setting	Code / Value	Description
[Stop Key No Priority]	NO	Disables the STOP/RESET key on the Display Terminal.
[Stop Key Priority]	YES	Gives priority to the STOP/RESET key on the Display Terminal.  Only the stop function is enabled. The stop is performed in freewheel.  <b>Factory Setting</b>
[Stop Key Priority All]	ALL	Gives priority to the STOP/RESET key on the Graphic Display Terminal.  The fault reset function and the stop function are enabled. The stop is performed depending on [Type of stop] STT setting value.
<b>NOTE:</b> The Fault Reset function is disabled in Multipoint mode , page 37.		

## [HMI L/R cmd] BMP

*HMI local/remote command.*

Setting	Code / Value	Description
[Stop On Switching]	STOP	Stops the drive (although the controlled direction of operation and reference of the previous channel are copied (to be taken into account on the next RUN command))
[Bumpless]	BUMP	Does not stop the drive (the controlled direction of operation and the reference of the previous channel are copied)  <b>Note:</b> In I/O profile, the drive stops if the communication is interrupted and: <ul style="list-style-type: none"> <li>• The command channel has been switched to the fallback channel set to <b>[HMI] ICC</b>(by pressing the Local/Remote key on the graphic display terminal) and,</li> <li>• The reference frequency sign of the fallback channel is different from the previous channel reference, or</li> <li>• The digital input DIx assigned to a run command is low.</li> </ul>
[Disabled]	DIS	Disabled  <b>Factory Setting</b>

# [Master/Slave]

## MultiDrive Link Mechanism

### Introduction

MultiDrive Link function allows direct communication between a drives group. This communication is done through an Ethernet link between each drives. Some drive functions can be configured with the MultiDrive Link.

### Topology

MultiDrive Link function is an Ethernet based protocol.

It can be used in following topologies:

- Daisy chain
- Star
- Redundant ring with RSTP

More information about topologies is available in ATV340 Embedded Ethernet Manual.

## MultiDrive Link Properties

### MultiDrive Link Group:

A MultiDrive Link group can be composed of:

- Master, which is mandatory.
- Up to 10 Slaves.

Only 1 master must be present in a MultiDrive Link group.

Each drive, acting as slave, must have its own slave identification.

### Data Exchange Principle:

Each drive of the MultiDrive Link group sends data to all the drives of its group.

These data are sorted in data groups which are specific for each application used in combination.

These data are sent using UDP frames with multicast IP addressing.

## Network Configuration

The MultiDrive Link function uses the following network resources:

- IP address: 239.192.152.143
- UDP ports: 6700 and 6732
- Non routed networks

If the MultiDrive Link function is used over an Ethernet network, it is mandatory to take into account these resources for its configuration.

Only one MultiDrive Link group can be used on a same Ethernet network.

## Drive Configuration

Each drive used on a MultiDrive Link group must have an IP address.

This IP address can be set manually or assigned by a DHCP server.

## MultiDrive Link Communication Monitoring

A permanent monitoring of the communication is performed by each drive of the MultiDrive Link Group to avoid:

- Execution of the same command
- Corruption of data on the MultiDrive Link group

### Duplicate Slave ID:

The following table shows how the function reacts in case of duplicate slave ID detection:

If a Duplicate Slave ID is...	Then...
Detected at the same time in the MultiDrive Link group	It is not possible to identify the valid drive.  In this case, both drives: <ul style="list-style-type: none"> <li>• are considered invalid</li> <li>• are unavailable on the MultiDrive Link group</li> <li>• don't send data on the MultiDrive Link group</li> </ul>
Detected and already one drive with this Slave ID is running	The existing drive is considered valid.  The duplicate drive: <ul style="list-style-type: none"> <li>• is considered invalid</li> <li>• is not available on the MultiDrive Link group</li> <li>• don't send data on the MultiDrive Link group</li> </ul> <p><b>NOTE:</b> There is no effect on the application in this case.</p>

### Intruder:

A drive is considered as intruder of a MultiDrive Link group if its Slave ID is not consistent with the number of slaves declared on Master configuration.

If the drive Slave ID is not consistent with the configuration then it:

- Considers itself as invalid
- Don't send data on the MultiDrive Link group
- Don't accept data from the MultiDrive Link group

## [M/S System Architecture] MSA- Menu

### Access

[Complete settings] → [Master/Slave] → [M/S System Architecture]

### About This Menu

This menu allows the user to configure its Master/Slave architecture.

**Master/Slave architecture configuration:** allows configuring the communication mode between the Master and Slaves. Which drive is the Master and which ones are the Slaves. It also allows to assign speed and torque reference values.

**Master/Slave error response:** allows configuring how the Master or Slaves react if an error is detected (Master not present, Slave not ready or communication link error).

The following diagram shows the Master/Slave related parameters depending on their configuration:

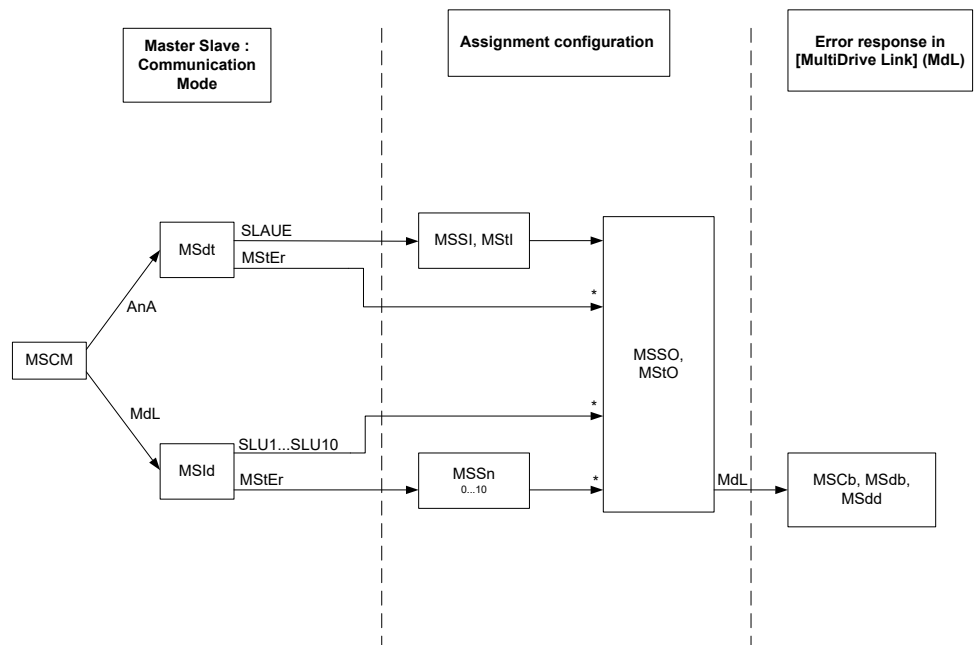

\* [Access Level] LAC is set to [Expert] EPR

The following table shows the visibility of the parameters in [Analog] ANA or in [MultiDrive Link] MDL mode:

[M/S Comm Mode] MSCM M/S communication mode	Analog		MultiDrive Link	
[M/S Device ID] MSID: Master or Slave ID selection	-	-	Master	Slave 1 to Slave 10
[M/S Device Role] MSDT: Master or Slave selection	Master	Slave	-	-
[M/S Number of Slaves] MSSN: M/S number of slaves	-	-	0 to 10	-
[M/S Speed Ref In Assign] MSSSI: M/S Master speed reference input assignment	-	Analog Input	-	-
[M/S Trq Ref In Assign] MSTTI: M/S Master torque reference input assignment	-	Analog Input	-	-
[M/S Speed Ref Out Assign] MSSSO: M/S speed reference output assignment	Analog Output	Analog Output*	Analog Output*	Analog Output*
[M/S Trq Ref Out Assign] MSTTO: M/S torque reference output assignment	Analog Output	Analog Output*	Analog Output*	Analog Output*
[M/S Local Mode Assign] MSDDI: M/S local mode input assignment	-	-	Digital Input	Digital Input
[M/S Comm ErrorResp] MSCB: M/S Response to communication error	-	-	Error Response	Error Response
[M/S Device ErrorResp] MSDB: M/S Response to device error	-	-	Error Response	Error Response
[M/S Device Error Delay] MSDD: M/S device error delay	-	-	Error Delay	Error Delay
* Parameters that can be accessed if [Access Level] LAC is set to [Expert] EPR				

**NOTE:** Master/Slave function can be configured only if:

- [Motor control type] CTT is set to [SVC V] VVC or [FVC] FVC or [Sync. mot.] SYN or [Sync.CL] FSY.
- [BRH b0] BRH0 is set to [No] NO.

**NOTE:** When a drive acts as a slave, [Low Speed] LSP and [High Speed] HSP must be configured same as master.

**NOTE:** The drive must be restart to apply the Master/Slave configuration.

**NOTE:** Drives with a power equal to or lower than 22 kW cannot be used as master in analog mode if there is no extension module of Digital and Analog I/O (VW3A3203).

**NOTE:** Master/Slave function in MultiDrive Link mode can only be used with ATV340•••N4E drives.

**[M/S Comm Mode] MSCM** ★

Activate Master Slave and select communication mode to exchange data between drives involved in the Master Slave architecture.

Setting	Code / Value	Description
[No]	NO	Master/Slave is not configured. <b>Factory setting</b>
[MultiDrive Link]	MDL	Master/Slave is configured using MultiDrive Link
[Analog]	ANA	Master/Slave is configured using Analog I/Os.  It is recommended to wire a digital output of the slave assigned to [Operating State Fault] FLT to a digital input of the master set to [Ext Error assign] ETF, with this setting, an error on the slave drive generates a stop to the master.  <b>NOTE:</b> If it is required, a digital output of the slaves assigned to [Operating State Fault] FLT can be wired to a digital input of the master sets to [Ext Error assign] ETF in order to stop the master if an error is detected on a slave drive.

**[M/S Device ID] MSID** ★

This parameter selects the Drive identification number for the Master Slave application.

This parameter can be accessed if [M/S Comm Mode] MSCM is set to [MultiDrive Link] MDL

Setting	Code / Value	Description
[Master]	MSTER	Master <b>Factory setting</b> <b>NOTE:</b> Be sure that autotune has been done before selecting a drive as master. Otherwise, use the [M/S Local Mode Assign] MSDI input to disable temporary the Master/Slave function and perform autotune.
[Slave 1]... [Slave 10]	SLV1...SLV10	Slave ID

**[M/S Device Role] MSDT** ★

Select if the drive is the master or a slave.

This parameter can be accessed if [M/S Comm Mode] MSCM is set to [Analog] ANA.

Setting	Code / Value	Description
[Master]	MSTER	The Drive is configured as the Master Drive. (it provides the speed and torque reference value to Slaves). <b>Factory setting</b>
[Slave]	SLAVE	The Drive is configured as a Slave Drive. (it uses the speed and torque reference value from the Master).



## [M/S Number of Slaves] MSSN ★

Total number of slaves in the Master Slave architecture. The maximum number of slaves is 10 in multi-drive link architecture. In Analog architecture the maximum number of slaves depends on Analog I/O capabilities.

This parameter can be accessed if:

- [M/S Comm Mode] MSCM is set to [MultiDrive Link] MDL, and
- [M/S Device ID] MSID is set to [Master] MSTER.

Setting	Description
0...10	Setting range <b>Factory setting:</b> 0

## [M/S Speed Ref In Assign] MSSI ★

This parameter can be accessed if:

- [M/S Comm Mode] MSCM is set to [Analog] ANA, and
- [M/S Device Role] MSDT is set to [Slave] SLAVE.

Depending on the selected analog input, [Speed Ref AI1 Config.] MSR1– or ... or [Speed Ref AI5 Config.] MSR5– menu is displayed. Access to the corresponding menu to configure the analog input according to your needs.

Setting	Code / Value	Description
[Not Configured]	NO	Analog input is not configured <b>Factory setting</b>
[AI1]...[AI3]	AI1...AI3	Analog input AI1...AI3
[AI4]...[AI5]	AI4...AI5	Analog input AI4...AI5 if VW3A3203 I/O extension module has been inserted

## [Speed Ref AI1 Config.] MSR1– to [Speed Ref AI5 Config.] MSR5– Menus★

Theses menus allow to configure the analog input selected via [M/S Speed Ref In Assign] MSSI.

Example: If [M/S Speed Ref In Assign] MSSI is set to [AI3] AI3, [Speed Ref AI3 Config.] MSR3– menu can be accessed.

For more information on the configuration of the analog input refer to [Input/Output]-[AI/AQ].

## [M/S Trq Ref In Assign] MSTI ★

This parameter can be accessed if:

- [M/S Comm Mode] MSCM is set to [Analog] ANA
- [M/S Device Role] MSDT is set to [Slave] SLAVE.

Depending on the selected analog input, [Torque Ref AI1 Config.] MTR1– or ... or [Torque Ref AI1 Config.] MTR5– menu is displayed. Access to the corresponding menu to configure the analog input according to your needs.

Setting	Code / Value	Description
[Not Configured]	NO	Analog input is not configured <b>Factory setting</b>
[AI1]...[AI3]	AI1...AI3	Analog input AI1...AI3
[AI4]...[AI5]	AI4...AI5	Analog input AI4...AI5 if VW3A3203 I/O extension module has been inserted

## [Torque Ref AI1 Config.] MTR1– to [Torque Ref AI1 Config.] MTR5– Menus★

Theses menus allow to configure the analog input selected via [M/S Trq Ref In Assign] MSTI.

Example: If [M/S Trq Ref In Assign] MSTI is set to [AI3] AI3, [Torque Ref AI3 Config.] MTR3– menu can be accessed.

For more information on the configuration of the analog input refer to [Input/Output]-[AI/AQ].

## [M/S Speed Ref Out Assign] MSSO ★

Analog output selected for speed reference for the Master Drive.

This parameter can be accessed if:

- [M/S Comm Mode] MSCM is set to [Analog] ANA, and
- [M/S Device Role] MSDT is set to [Master] MSTER.

**NOTE:** For monitoring purpose, this parameter can also be accessed if [M/S Comm Mode] MSCM is configured and [Access Level] LAC is set to [Expert] EPR.

Depending on the selected analog output, [Speed Ref AQ1 Config.] MSM1– or [Speed Ref AQ2 Config.] MSM2– menu is displayed. Access to the corresponding menu to configure the analog output according to your needs.

Setting	Code / Value	Description
[No]	NO	Analog output for speed reference is not configured. <b>Factory setting</b>
[AQ1]	AO1	Analog Output for speed reference is configured to AO1.
[AQ2]	AO2	Analog Output for speed reference is configured to AO2.
In order to monitor the loss of signal, it is recommended to use a 4-20mA link between the master and the slave and to configure the monitoring function in the [4-20 mA loss] LFL– menu.		

**NOTE:** To allow configuration, outputs default configuration must be unconfigured.

## [Speed Ref AQ1 Config.] MSM1- to [Speed Ref AQ2 Config.] MSM2- Menus★

These menus allow to configure the analog input selected via [M/S Speed Ref Out Assign] MSSO.

Example: If [M/S Speed Ref Out Assign] MSSO is set to [AQ1] AO1, [Speed Ref AQ1 Config.] MSM1- menu can be accessed.

For more information on the configuration of the analog input refer to [Input/Output]-[AI/AQ].

## [M/S Trq Ref Out Assign] MSTO ★

Analog output selected for torque reference for the Master Drive.

This parameter can be accessed if:

- [M/S Comm Mode] MSCM is set to [Analog] ANA, and
- [M/S Device Role] MSDT is set to [Master] MSTER.

**NOTE:** For monitoring purpose, this parameter can also be accessed if [M/S Comm Mode] MSCM is configured and [Access Level] LAC is set to [Expert] EPR.

Depending on the selected analog output, [Torque Ref AQ1 Config.] MTM1- or [Torque Ref AQ2 Config.] MTM2- menu is displayed. Access to the corresponding menu to configure the analog output according to your needs.

Setting	Code / Value	Description
[No]	NO	Analog output for torque reference is not configured. <b>Factory setting</b>
[AQ1]	AO1	Analog Output for speed reference is configured to AO1.
[AQ2]	AO2	Analog Output for speed reference is configured to AO2.
In order to monitor the loss of signal, it is recommended to use a 4-20mA link between the master and the slave and to configure the monitoring function in the [4-20 mA loss] LFL- menu.		

**NOTE:** To allow configuration, outputs default configuration must be unconfigured.

## [Torque Ref AQ1 Config.] MTM1- to [Torque Ref AQ2 Config.] MTM2- Menus★

These menus allow to configure the analog input selected via [M/S Trq Ref Out Assign] MSTO.

Example: If [M/S Trq Ref Out Assign] MSTO is set to [AQ1] AO1, [Torque Ref AQ1 Config.] MTM1 menu can be accessed.

For more information on the configuration of the analog input refer to [Input/Output]-[AI/AQ].

**[M/S Local Mode Assign] MSDI ★**

Digital input used to switch between Master/Slave automatic operation and local control mode (for example in maintenance mode).

This parameter can be accessed if **[M/S Comm Mode] MSCM** is set to **[MultiDrive Link] MDL**.

**NOTE:** It is recommended to use this mode when system is stopped and, if possible, motor mechanically disconnected.

Possible settings: Digital inputs (high level)

Factory setting: **[Not Assigned] NO**

**[MDL Comm Timeout] MLTO★**

This parameter can be accessed if **[M/S Comm Mode] MSCM** is set to **[MultiDrive Link] MDL**.

Setting	Description
0.01...10.00 s	Setting range <b>Factory setting:</b> 0.05 s

**[M/S Comm ErrorResp] MSCB ★**

Define how the drive reacts when a multi-drive link communication error is detected.

This parameter can be accessed if **[M/S Comm Mode] MSCM** is set to **[MultiDrive Link] MDL**.

Setting	Code / Value	Description
<b>[Freewheel Stop]</b>	YES	Freewheel stop <b>Factory setting</b>
<b>[Per STT]</b>	STT	Stop according to <b>[Type of stop] STT</b> parameter but without an error triggered after stop
<b>[Ramp stop]</b>	RMP	Stop on ramp
<b>[Fast stop]</b>	FST	Fast stop

**NOTE:** If the master is in **[Ramp stop] RMP** the slave has to be set to **[Freewheel Stop] YES**.

## [M/S Device ErrorResp] MSDB ★

Define how the Drive react when a device is lost

This parameter can be accessed if [M/S Comm Mode] MSCM is set to [MultiDrive Link] MDL.

Setting	Code / Value	Description
[Freewheel Stop]	YES	Freewheel stop <b>Factory setting</b>
[Per STT]	STT	Stop according to [Type of stop] STT parameter but without an error triggered after stop
[Speed maintained]	RLS	Speed maintained as long as the detected error persists and the run command has not been removed <sup>(1)</sup>
[Fallback Speed]	LFF	Change to fallback speed, maintained as long as the detected error persists and the run command has not been removed <sup>(1)</sup>
[Ramp stop]	RMP	Stop on ramp
[Fast stop]	FST	Fast stop
<p>(1) Because, in this case, the detected error does not trigger a stop, it is recommended to assign a relay or logic output to its indication. This setting is only accessible if [M/S Device Role] MSDT is set to [Master] MSTER.</p>		

**NOTE:** If the master is in [Ramp stop] RMP the slave has to be set to [Freewheel Stop] YES, [Speed maintained] RLS and [Fallback Speed] LFF are not available for slave drives.

## [M/S Device Error Delay] MSDD ★

Monitoring delay before the system is ready. If one of the drives in the system is not ready after this delay, a [M/S Device Error] MSDF is triggered.

This parameter can be accessed if [M/S Comm Mode] MSCM is set to [MultiDrive Link] MDL.

Setting	Code / Value	Description
[No]	NO	Wait infinite time. <b>Factory setting</b>
0...60 s		Setting range

## [FallbackSpeed] LFF ★

This parameter can be accessed if the error response parameter is set to [Fallback Speed] LFF.

Setting	Description
0.0...599.0 Hz	Setting range <b>Factory setting:</b> 0.0 Hz

## [M/S Control] MST– Menu

### Access

[Complete settings] → [Master/Slave] → [M/S Control]

### About This Menu

This menu is used to configure the type of control used in Master/Slave.

This function can be accessed if [M/S Comm Mode] MSCM is not set to [No] NO.

### Master/Slave Mechanical Coupling

The Master / Slave mechanical coupling type allow selecting two types of coupling:

- **[Rigid] RIGID** coupling means that the rotor speed of each motor is forced to be the same by the application. This choice is typically used for coupling such as gearbox, toothed belt and when the elasticity is closed to '0'.
- In the **[Elastic] ELAST** coupling, the motors rotors are not the same, due to elasticity or slip in the coupling. This type of coupling is use for example for overhead conveyor (using a tension system), long belt.

Selecting the **[Elastic] ELAST** coupling give access to same parameters a **[Rigid] RIGID** coupling plus:

- **[M/S Filters] MSF–**
- **[Load Sharing M/S] MSB–**
- **[M/S Out Torque Ref Select] MSOT**

Configuring parameters in the **[Elastic] ELAST** coupling and then selecting **[Rigid] RIGID** coupling disables the **[Elastic] ELAST** configured parameters. Conversely, switching from **[Rigid] RIGID** coupling to **[Elastic] ELAST** coupling has not effect on the **[Rigid] RIGID** coupling parameters.

### Master/Slave Control Type

The Master / Slave control type allow selecting which type of control is applied on slave and direction of slave related to direction of Master:

- **[Speed Direct] SPDD**: Slave follows speed reference of Master in same direction.
- **[Speed Reverse] SPDR**: Slave follows speed reference of Master in reverse direction. Typically for face to face motors.
- **[Torque Direct] TRQD**: Slave follows torque reference of Master in same direction.
- **[Torque Reverse] TRQR**: Slave follows torque reference of Master in reverse direction. Typically for face to face motors.
- **[Torque Custom] TRQC**: Slave follows torque reference of Master around speed reference. Direction of speed can be adjusted with **[Speed Ref Direction] SSD** and direction of torque with **[Torque ref. sign] TSD**.

Allows to apply a torque ratio or a torque ramp in case of application needs.

The following table shows the possible cases between **[Speed Ref Direction] SSD** and **[Torque ref. sign] TSD** when **[M/S Control Type] MSCT** is set to **[Torque Custom] TRQC**:

[Speed Ref Direction] SSD	[Torque ref. sign] TSD	[M/S Control Type] MSCT
Inactive	Inactive	Slave runs in same direction as Master (speed and torque)
Inactive	Active	Slave runs in same direction as Master but apply opposite torque
Active	Inactive	Slave runs in reverse direction of Master and applies opposite torque
Active	Active	Slave runs in reverse direction of Master for speed and torque.

## Stop Configuration

The slaves have different stop behavior depending of their configuration and master stop type.

When the master stops in freewheel:

- If [M/S Control Type] MSCT is set to [Speed Direct] SPDD or [Speed Reverse] SPDR, the slaves stop following its [Type of stop] STT configuration.
- If [M/S Control Type] MSCT is set to [Torque Direct] TRQD or [Torque Reverse] TRQR or [Torque Custom] TRQC, the slaves stop following [Torque control stop] TST or [Type of stop] STT, depending of the priority between them.

**Example:** If [Torque control stop] TST is set to [Freewheel Stop] NST and [Type of stop] STT is set to [On Ramp] RMP, the slaves stops in freewheel.

When the master stops on ramp:

- If [M/S Control Type] MSCT is set to [Speed Direct] SPDD or [Speed Reverse] SPDR, the slaves stop following the master ramp in speed control.
- If [M/S Control Type] MSCT is set to [Torque Direct] TRQD or [Torque Reverse] TRQR or [Torque Custom] TRQC, the slaves stop following the master ramp in torque control.

## Brake management

**Brake sequence is managed only by the Master.**

The Master manages its brake according to its brake sequence, in [MultiDrive Link] MDL or [Analog] ANA. Optionally, the Master can manage the brakes of the slaves by the same brake command. The release and engage times of brakes in the application have to be the same.

**Brake sequence is managed by the Master and Slaves.**

In [MultiDrive Link] MDL brakes can be managed on each Drive. The synchronization of the release and engage times are managed by the Master through the [MultiDrive Link] MDL.

## [M/S Coupling Type] MSMC

*M/S mechanical coupling type.*

Setting	Code / Value	Description
[Rigid]	RIGID	Rigid coupling <b>Factory setting</b>
[Elastic]	ELAST	Elastic coupling

**[M/S Control Type] MSCT** ★

This parameter can be accessed if **[M/S Device Role] MSDT** is set to **[Slave] SLAVE** or **[M/S Device ID] MSID** is set to **[Slave 1] to [Slave 10]** .

Setting	Code / Value	Description
<b>[Torque Direct]</b>	TRQD	Torque direct control <b>Factory setting</b>
<b>[Torque Reverse]</b>	TRQR	Torque reverse control
<b>[Torque Custom]</b>	TRQC	Torque custom control Allow to apply a torque ratio a torque ramp in case of different motors
<b>[Speed Direct]</b>	SPDD	Speed direct control Is not a available if <b>[M/S Coupling Type] MSMC</b> is set to <b>[Rigid] RIGID</b>
<b>[Speed Reverse]</b>	SPDR	Speed reverse control Is not a available if <b>[M/S Coupling Type] MSMC</b> is set to <b>[Rigid] RIGID</b>



## [M/S Torque Control] MSQ- Menu

### Access

[Complete settings] → [Master/Slave] → [M/S Control] → [M/S Torque Control]

### About This Menu

This menu can be accessed if:

- [M/S Device Role] MSDT is set to [Slave] SLAVE or [M/S Device ID] MSID is set to [Slave 1] to [Slave 10], and
- [M/S Control Type] MSCT is set to:
  - [Torque Direct] TRQD, or
  - [Torque Reverse] TRQR, or
  - [Torque Custom] TRQC.

### [Speed Ref Direction] SSD ★

Assignment for sign inversion of reference speed value coming from the master.

This parameter can be accessed if:

- [M/S Comm Mode] MSCM is not set to [No] NO, and
- [M/S Control Type] MSCT is set to [Torque Custom] TRQC.

Setting	Code / Value	Description
[Not Assigned]	NO	Not assigned <b>Factory setting</b>
[Yes]	YES	Yes
[DI1]...[DI8]	LI1...LI8	Digital input DI1...DI8 <b>NOTE:</b> DI8 selection can be accessed on drives with a power greater than 22kW.
[DI11]...[DI16]	LI11...LI16	Digital input DI11...DI16 if VW3A3203 I/O extension module has been inserted
[CD00]... [CD10]	CD00...CD10	Virtual digital input CMD.0...CMD.10 in [I/O profile] IO configuration
[CD11]... [CD15]	CD11...CD15	Virtual digital input CMD.11...CMD.15 regardless of configuration
[C101]... [C110]	C101...C110	Virtual digital input CMD1.01...CMD1.10 with integrated Modbus Serial in [I/O profile] IO configuration
[C111]... [C115]	C111...C115	Virtual digital input CMD1.11...CMD1.15 with integrated Modbus Serial regardless of configuration
[C201]... [C210]	C201...C210	Virtual digital input CMD2.01...CMD2.10 with CANopen® fieldbus module in [I/O profile] IO configuration
[C211]... [C215]	C211...C215	Virtual digital input CMD2.11...CMD2.15 with CANopen® fieldbus module regardless of configuration
[C301]... [C310]	C301...C310	Virtual digital input CMD3.01...CMD3.10 with a fieldbus module in [I/O profile] IO configuration
[C311]... [C315]	C311...C315	Virtual digital input CMD3.11...CMD3.15 with a fieldbus module regardless of configuration

Setting	Code / Value	Description
[C501]... [C510]	C501...C510	Virtual digital input CMD5.01...CMD5.10 with integrated Ethernet in <b>[I/O profile]</b> IO configuration <b>NOTE:</b> This selection can be accessed on ATV340...N4E drives.
[C511]... [C515]	C511...C515	Virtual digital input CMD5.11...CMD5.15 with integrated Ethernet regardless of configuration <b>NOTE:</b> This selection can be accessed on ATV340...N4E drives.

## [Torque ref. sign] TSD ★

Assignment for the inversion of the sign of the reference for the torque regulation function.

This parameter can be accessed if:

- **[M/S Comm Mode]** MSCM is not set to **[No]** NO, and
- **[M/S Control Type]** MSCT is set to **[Torque Custom]** TRQC.

Identical to **[Speed Ref Direction]** SSD.

## [Torque ratio] TRT ★

This parameter is used in case of using a slave motor with a different nominal torque than the master motor, or to unbalance torque between master and slave.

This parameter applies a factor in % on the torque reference received from the master.

This parameter can be accessed if:

- **[M/S Comm Mode]** MSCM is not set to **[No]** NO, and
- **[M/S Control Type]** MSCT is set to **[Torque Custom]** TRQC.

Setting ( )	Description
0.0...1000.0%	Coefficient applied to <b>[Torque ref. channel]</b> TR1 or <b>[Torque Ref 2 Channel]</b> TR2 <b>Factory setting:</b> 100.0%

## [Torque Ref Offset] TQOP ★

This parameter is used to scale the torque reference value.

This parameter applies an offset in % on the torque reference.

This parameter can be accessed if:

- **[M/S Comm Mode]** MSCM is not set to **[No]** NO, and
- **[M/S Control Type]** MSCT is set to **[Torque Custom]** TRQC.

Setting ( )	Description
-1000.0...1000.0%	Setting range <b>Factory setting:</b> 0.0%

## [Torque ramp time] TRP ★

This parameter can be accessed if:

- [M/S Comm Mode] MSCM is not set to [No] NO, and
- [M/S Control Type] MSCT is set to [Torque Custom] TRQC.

Setting ( )	Description
0.0...99.99 s	Rise and fall time for a variation of 100% of the rated torque <b>Factory setting:</b> 3.00 s

## [Torque control stop] TST

*Torque control stop type.*

Setting	Code / Value	Description
[Speed]	SPD	Speed regulation stop, in accordance with the [Type of stop] STT configuration  The parameter is forced to [Speed] SPD if [Brake assignment] BLC is configured
[Freewheel]	NST	<b>Factory setting:</b> Freewheel stop
[Spin]	SPN	Zero torque stop, but maintaining the flux in the motor  <b>Note:</b> This setting can only be accessed in closed loop control ([Motor control type] CTT is set to [Sync.CL] FSY or [FVC] FVC)

## [Spin time] SPT ★

Spin time following stop in order to remain ready to restart quickly.

This parameter specifies the time the motor is maintained fluxed after the zero speed is attained.

This parameter can be accessed if [Torque control stop] TST is set to [Spin] SPN.

Setting ( )	Description
0.0...3600.0 s	Setting range <b>Factory setting:</b> 1.0 s

## [Positive deadband] DBP

Torque regulation positive dead band.

The torque control is effective in an area defined by [Positive deadband] DBP and [Negative deadband] DBN around the speed reference value.

Outside of this area, the drive switch automatically in speed control to make speed returns inside the torque control area.

Value added algebraically to the speed reference.

Example for [Positive deadband] DBP = 10:

- If reference = + 50 Hz: + 50 + 10 = 60 Hz
- If reference = - 50 Hz: - 50 + 10 = - 40 Hz

Setting ( )	Description
0.0...2 x [Max Frequency] TFR	Setting range <b>Factory setting:</b> 10.0 Hz

## [Negative deadband] DBN

Torque regulation negative dead band.

The torque control is effective in an area defined by **[Positive deadband] DBP** and **[Negative deadband] DBN** around the speed reference value.

Outside of this area, the drive switches automatically in speed control to make speed returns inside the torque control area.

Value subtracted algebraically from the speed reference.

Example for **[Negative deadband] DBN** = 10:

- If reference = + 50 Hz: + 50 - 10 = 40 Hz
- If reference = - 50 Hz: - 50 - 10 = - 60 Hz

Setting ( )	Description
0.0...2 x <b>[Max Frequency] TFR</b>	Setting range <b>Factory setting:</b> 10.0 Hz

## [Torque ctrl time out] RTO

Time following automatic exit of torque control mode in the event of an error or a warning has been triggered.

Setting	Description
0.0...999.9 s	Setting range <b>Factory setting:</b> 60 s

## [Torque Ctrl ErrorResp] TOB

Response to torque control error.

Response of drive once time **[Torque ctrl time out] RTO** has elapsed.

Setting	Code / Value	Description
<b>[Warning]</b>	ALRM	Warning is triggered on timeout <b>Factory setting</b>
<b>[Error]</b>	FLT	An error is triggered with freewheel stop

## [Low Torque] LTQ

Low torque threshold limit.

Torque applied on slave is limited between **[Low Torque] LTQ** and **[High Torque] HTQ** (expressed in % of nominal torque).

This parameter cannot be higher than **[High Torque] HTQ**.

Setting ( )	Description
-300.0... <b>[High Torque] HTQ</b>	Setting range <b>Factory setting:</b> -300.0%

## [High Torque] HTQ

High torque threshold limit.

This parameter cannot be lower than [Low Torque] LTQ.

Setting ( )	Description
[Low Torque] LTQ...300.0%	Setting range <b>Factory setting:</b> 300.0%

## [M/S Control] MST– Menu

### Access

[Complete settings] → [Master/Slave] → [M/S Control]

### About This Menu

This menu can be accessed if [M/S Comm Mode] MSCM is not set to [No] NO.

## [Torque Filter] TRF ★

This function provides a filter on the torque reference for Slaves Drives to deal with dynamic control constraints (such as a communication delays). Select if the filtering on the input torque reference is present or not.

This parameter can be accessed if:

- [M/S Device Role] MSDT is set to [Slave] SLAVE or [M/S Device ID] MSID is set to [Slave 1] to [Slave 10], and
- [M/S Control Type] MSCT is set to:
  - [Torque Direct] TRQD, or
  - [Torque Reverse] TRQR, or
  - [Torque Custom] TRQC.

Setting	Code / Value	Description
[No]	NO	Input torque reference filtering is disabled <b>Factory setting</b>
[Yes]	YES	Input torque reference filtering is enabled

## [Torque Filter Bandwidth] TRW ★

Defines the bandwidth of the filter in Hertz.

This parameter can be accessed if:

- [Torque Filter] TRF is set to [Yes] YES, and
- [M/S Control Type] MSCT is set to:
  - [Torque Direct] TRQD, or
  - [Torque Reverse] TRQR, or
  - [Torque Custom] TRQC.

Setting	Description
1...1000 Hz	Setting range <b>Factory setting:</b> 20 Hz.

## [M/S Filters] MSF- Menu

### Access

[Complete settings] → [Master/Slave] → [M/S Control] → [M/S Filters]

### About This Menu

This menu can be accessed if [M/S Coupling Type] MSMC is set to [Elastic] ELAST and [Access Level] LAC is set to [Expert] EPR.

Master control speed and Slave is torque controlled. This feature allows configuring the transfer function between Master and Slave according to the dynamic of the coupling (elastic).

The advanced filter can be set independently on Master or/and Slaves to compensate the elasticity of the coupling:

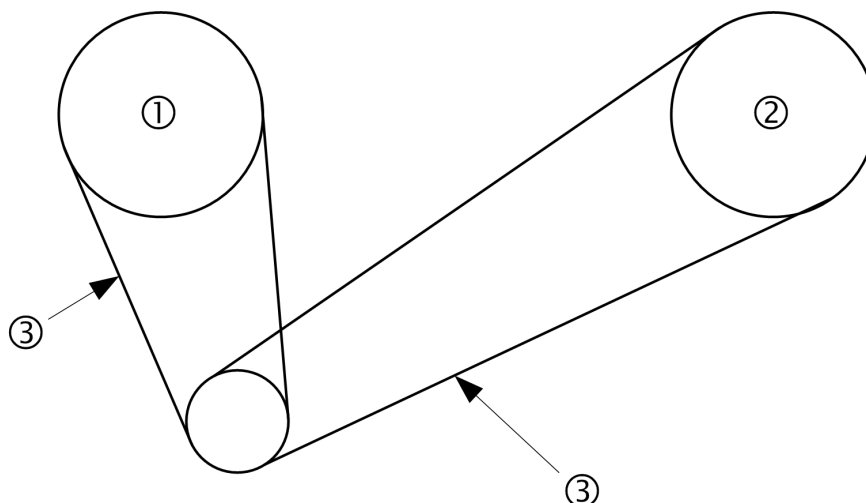

1 Master

2 Slave

3 Advanced filter can be set for this elastic coupling

## [M/S Advanced Filter] MSFE

### M/S advanced filter activation.

Setting	Code / Value	Description
[No]	NO	Advanced filtering disable <b>Factory setting</b>
[Yes]	YES	Advanced filtering enable

### [M/S Advanced Filter Freq] MSFF ★

Defines the frequency of the filter in Hz.

Influence of the [M/S Advanced Filter Freq] MSFF Parameter

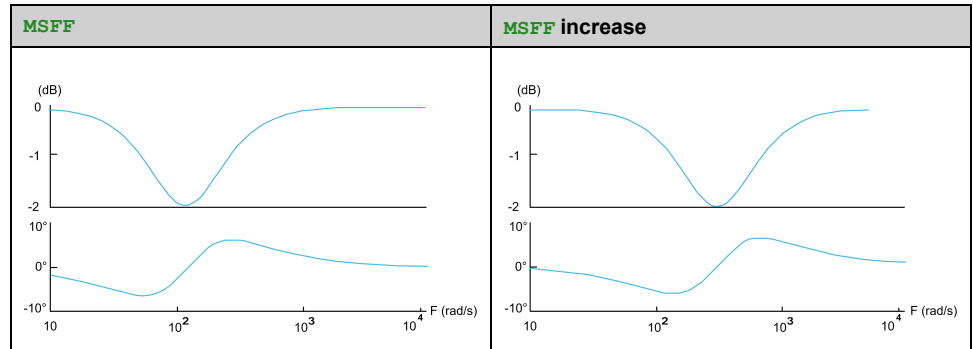

This parameter can be accessed if [M/S Advanced Filter] MSFE is not set to [No] NO.

Setting	Description
10.0...150 Hz	Setting range Factory setting: 15.0 Hz

### [M/S Advanced Filter Bdw] MSFB ★

Defines the bandwidth. Means the width of the stop-band of the filter in % of the filter frequency.

Influence of the [M/S Advanced Filter Bdw] MSFB Parameter

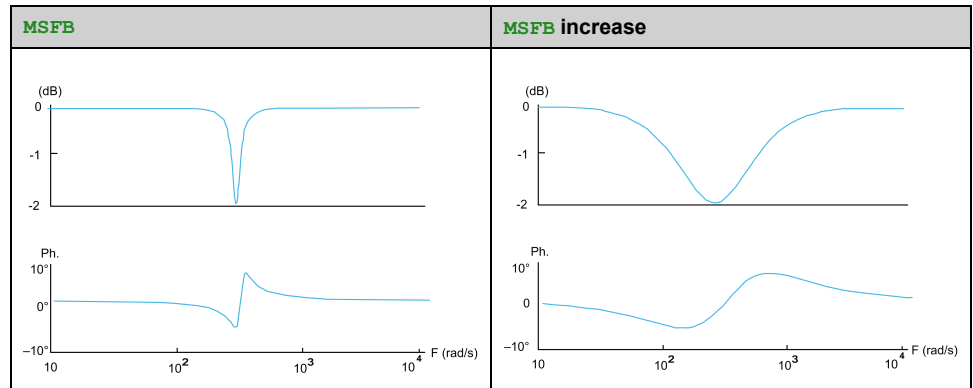

This parameter can be accessed if [M/S Advanced Filter] MSFE is not set to [No] NO.

Setting	Description
10...400%	Setting range Factory setting: 100%

### [M/S Advanced Filter Depth] MSFD ★

Defines the attenuation level at the filter frequency.

Influence of the [M/S Advanced Filter Depth] MSFD Parameter

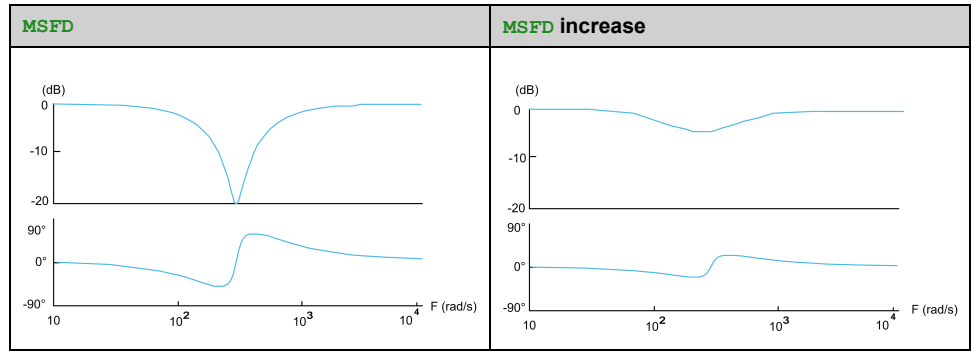

This parameter can be accessed if [M/S Advanced Filter] MSFE is not set to [No] NO.

Setting	Description
0...99%	Setting range <b>Factory setting:</b> 10%

### [M/S Advanced Filter Gain] MSFG ★

Defines the gain of the filter. 100% means a unitary gain.

Influence of the [M/S Advanced Filter Gain] MSFG Parameter

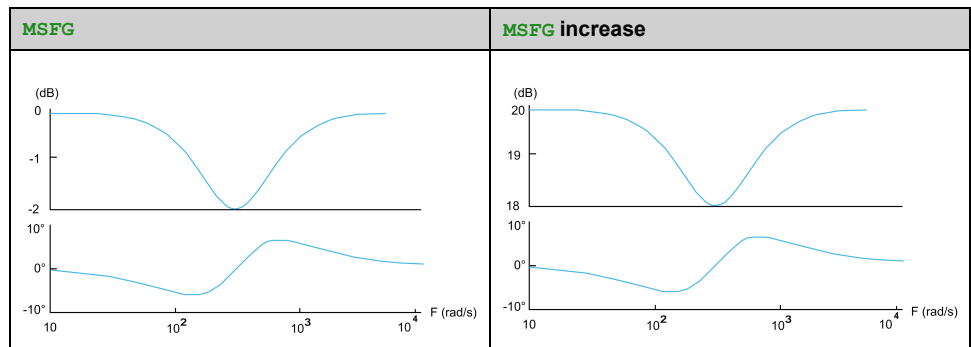

This parameter can be accessed if [M/S Advanced Filter] MSFE is not set to [No] NO.

Setting	Description
0...1000%	Setting range <b>Factory setting:</b> 100%

### [M/S Advanced Filter Coeff] MSFC ★

Master / Slave advanced filter coefficient.

Influence of the [M/S Advanced Filter Coeff] MSFC Parameter



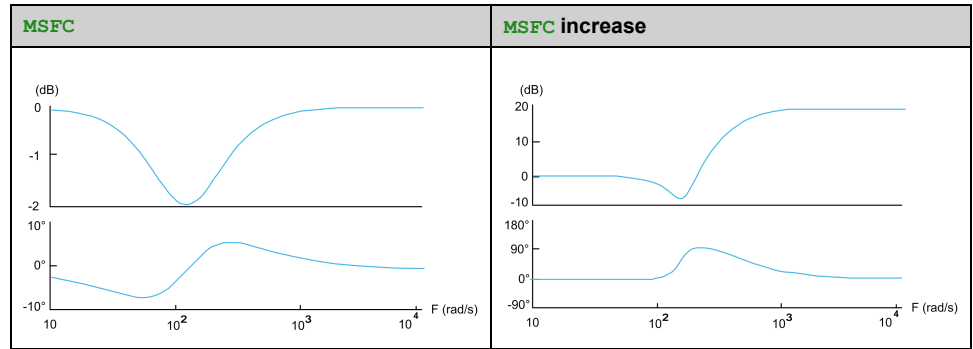

This parameter can be accessed if [M/S Advanced Filter] MSFE is not set to [No] NO.

Setting	Description
0...1000%	Setting range <b>Factory setting:</b> 100%

## [Load Sharing M/S] MSB– Menu

### Access

[Complete settings] → [Master/Slave] → [M/S Control] → [Load Sharing M/S]

### About This Menu

This menu can be accessed if:

- [M/S Coupling Type] MSMC is set to [Elastic] ELAST, and
- [M/S Device Role] MSDT or [M/S Device ID] MSID is set to [Master] MSTER.

Or if:

- [M/S Device Role] MSDT is set to [Slave] SLAVE or [M/S Device ID] MSID is set to [Slave 1] to [Slave 10], and
- [M/S Control Type] MSCT is set to:
  - [Speed Direct] SPDD, or
  - [Speed Reverse] SPDR.

### Load sharing, Parameters That can be Accessed at Expert Level

Principle:

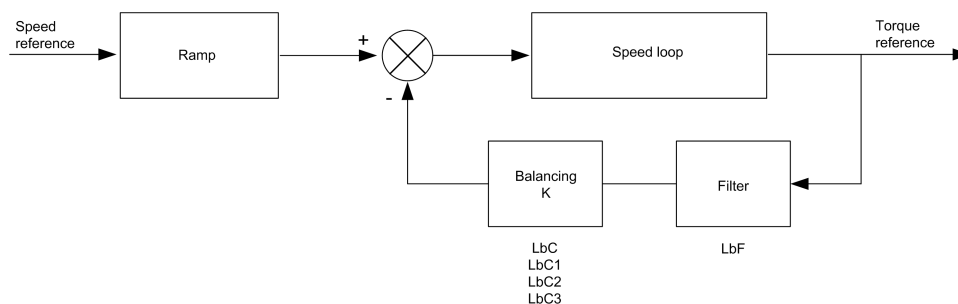

The load sharing factor K is determined by the torque and speed, with two factors K1 and K2 ( $K = K1 \times K2$ ).

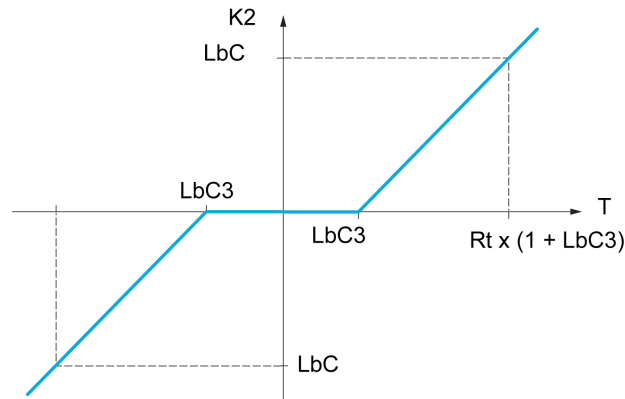
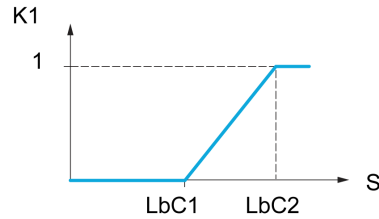

**S** Speed

**T** Torque

**Rt** Rated torque

## [Load sharing] LBA

Load balancing configuration

When 2 motors are connected mechanically and therefore at the same speed, and each is controlled by a drive, this function can be used to improve torque distribution between the two motors. To do this, it varies the speed based on the torque.

**Note:** This function is only compatible with [Motor control type] CTT set to [SVC V] VVC.

This parameter is forced to [No] NO if:

- [PID feedback Assign] PIF is assigned, or
- [Trq/spd switching] TSS is set to [Yes] YES, or
- [Application Selection] APPT is set to [All Applications] ALL or [Hoisting] HOST or [Conveyor] CONV, or
- [M/S Coupling Type] MSMC is set to [Elastic] ELAST and [M/S Device Role] MSDT is set to [Master] MSTER, or
- [M/S Device Role] MSDT is set to [Slave] SLAVE and [M/S Control Type] MSCT is set to [Speed Direct] SPDD or [Speed Reverse] SPDR.

Setting	Code / Value	Description
[No]	NO	Function inactive <b>Factory setting</b>
[Yes]	YES	Function active

## [Load correction] LbC ★

Nominal speed load balance correction.

This parameter can be accessed if [Load sharing] LbA is not set to [No] NO.

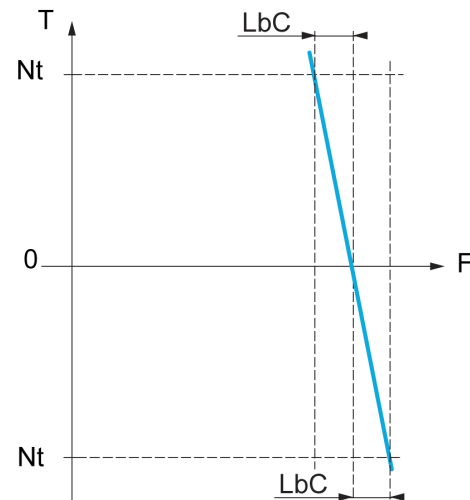

T Torque

Nt Nominal torque

F Frequency

Setting	Description
0.0...1000.0 Hz	Setting range Factory setting: 0.0 Hz

## [Correction min spd] LbC1 ★

Low Speed for torque decreasing function speed reference.

Minimum speed for load correction in Hz. Below this threshold, no corrections are made. Used to prevent correction at very low speed if this would hamper rotation of the motor.

This parameter can be accessed if:

- [Access Level] LAC is set to [Expert] EPR, and
- [Load sharing] LbA is not set to [No] NO.

Setting	Description
0.0...999.9 Hz	Setting range Factory setting: 0.0 Hz

## [Correction max spd] LbC2 ★

High speed for torque decreasing function speed reference.

Speed threshold in Hz above which maximum load correction is applied.

This parameter can be accessed if:

- [Access Level] LAC is set to [Expert] EPR, and
- [Load sharing] LbA is not set to [No] NO.

Setting	Description
L b C 1...1000.0 Hz	Setting range <b>Factory setting:</b> 0.0 Hz

## [Torque offset] LBC3 ★

Torque offset for torque correction.

Minimum torque for load correction as a % of the rated torque. Below this threshold, no corrections are made. Used to avoid torque instabilities when the torque direction is not constant.

This parameter can be accessed if:

- **[Access Level]** LAC is set to **[Expert]** EPR, and
- **[Load sharing]** LBA is not set to **[No]** NO.

Setting	Description
0...300%	Setting range <b>Factory setting:</b> 0%

## [Sharing filter] LBF ★

This parameter can be accessed if:

- **[Access Level]** LAC is set to **[Expert]** EPR, and
- **[Load sharing]** LBA is not set to **[No]** NO.

Setting	Description
100...20,000 ms	Setting range <b>Factory setting:</b> 100 ms

## [M/S Balance Trq Ref Sel] MSIB ★

Master / Slave load balancing torque reference selection.

This parameter can be accessed if **[Load sharing]** LBA is not set to **[No]** NO.

If **[M/S Advanced Filter]** MSFE is set to **[No]** NO, this parameter have no effect.

Setting	Code / Value	Description
<b>[Not Applied]</b>	NO	Not applied
<b>[Before Advanced Filter]</b>	BFILT	Before advanced filter <b>Factory setting</b>
<b>[After Advanced Filter]</b>	AFILT	After filter

## [M/S Control] MST– Menu

### Access

[Complete settings] → [Master/Slave] → [M/S Control]

### About This Menu

This function can be accessed if [M/S Comm Mode] MSCM is not set to [No] NO.

The following diagram shows the influence of reference entries and selections in the Master/Slave structure:

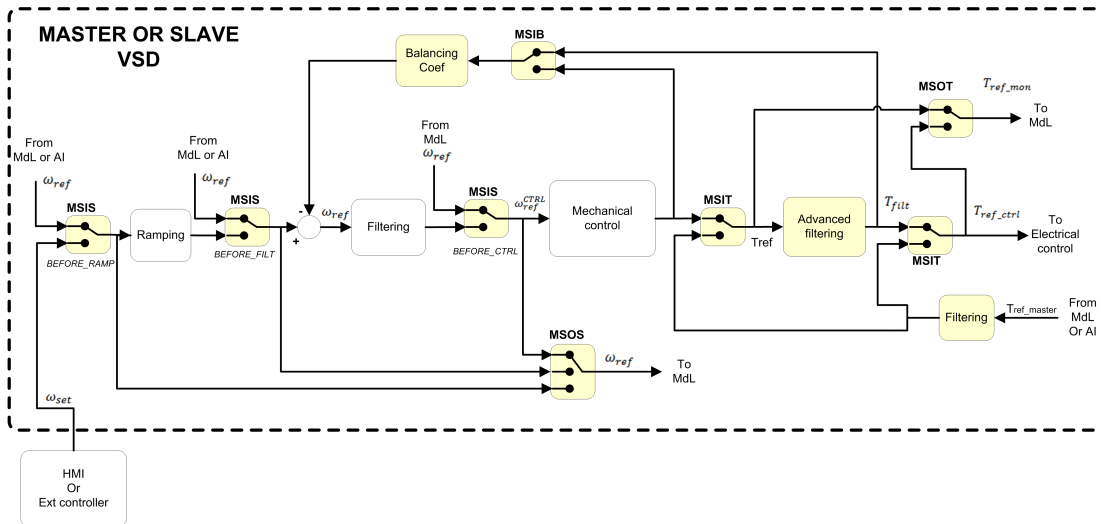

### [M/S Torque Ref Entry] MSIT ★

Master / Slave torque reference entry in control chain.

This parameter can be accessed if:

- [M/S Advanced Filter] MSFE is not set to [No] NO.
- [M/S Coupling Type] MSMC is set to [Elastic] ELAST, and
- [M/S Device Role] MSDT is set to [Slave] SLAVE or [M/S Device ID] MSID is set to [Slave 1] to [Slave 10].

Setting	Code / Value	Description
[Not Applied]	NO	Not applied
[Before Advanced Filter]	BFILT	Before advanced filter <b>Factory setting</b>
[After Advanced Filter]	AFILT	After advanced filter

### [M/S Out Torque Ref Select] MSOT ★

Master / Slave output torque reference selection.

Select the input routing of balancing feature.

This parameter can be accessed if:

- [M/S Coupling Type] MSMC is set to [Elastic] ELAST, and
- [M/S Advanced Filter] MSFE is not set to [No] NO.

Identical to **[M/S Torque Ref Entry]** MSIT.

## [M/S Speed Ref Entry] MSIS ★

Master / Slave speed reference entry in control chain.

Select the routing of the new speed reference input.

This parameter can be accessed if **[M/S Device Role]** MSDT is set to **[Slave]** SLAVE or **[M/S Device ID]** MSID is set to **[Slave 1]** to **[Slave 10]**.

Setting	Code / Value	Description
<b>[Not Applied]</b>	NO	Not applied
<b>[Before Ramp]</b>	BRMP	The input speed reference is before the ramp input in the control scheme <b>Factory setting</b>
<b>[After Ramp]</b>	ARMP	The input speed reference is after the ramp input in the control scheme
<b>[Before Control Loop]</b>	BCTRL	The input speed reference is before the control input in the control scheme

## [M/S Out Speed Ref Select] MSOS

Master / Slave output speed reference selection.

Identical to **[M/S Speed Ref Entry]** MSIS.

## [Hoisting Functions]

### [Brake logic control] BLC– Menu

#### Access

[Complete settings] → [Hoisting Functions] → [Brake logic control]

#### About This Menu

Used to control one or several electromagnetic brake(s) via a single output of the drive, for horizontal and vertical hoisting applications, and for unbalanced machines.

For vertical movements, the objective is to maintain motor torque in the lifting direction during the release and the application of the brake, in order to hold the load. Start smoothly when the brake is released and stop smoothly when the brake is applied.

For horizontal movements, the objective is to synchronize during the beginning of the movement the release of the brake with the built-up of torque and during stopping the application of the brake with the zero speed, in order to help prevent jerking.

**NOTE:** This function cannot be used with some other functions.

### Instructions for Brake Logic Control for a Vertical Hoisting Application

Your application consists of a whole range of different interrelated mechanical, electrical, and electronic components, the drive being just one part of the application. The drive by itself is neither intended to nor capable of providing the entire functionality to meet all safety-related requirements that apply to your application. Depending on the application and the corresponding risk assessment to be conducted by you, a whole variety of additional equipment is required such as, but not limited to, external encoders, external brakes, external monitoring devices, guards, etc.

As a designer/manufacturer of machines, you must be familiar with and observe all standards that apply to your machine. You must conduct a risk assessment and determine the appropriate Performance Level (PL) and/or Safety Integrity Level (SIL) and design and build your machine in compliance with all applicable standards. In doing so, you must consider the interrelation of all components of the machine. In addition, you must provide instructions for use that enable the user of your machine to perform any type of work on and with the machine such as operation and maintenance in a safe manner.

The present document assumes that you are fully aware of all normative standards and requirements that apply to your application. Since the drive cannot provide all safety-related functionality for your entire application, you must ensure that the required Performance Level and/or Safety Integrity Level is reached by installing all necessary additional equipment.



**⚠ WARNING**

**INSUFFICIENT PERFORMANCE LEVEL/SAFETY INTEGRITY LEVEL AND/OR UNINTENDED EQUIPMENT OPERATION**

- Conduct a risk assessment according to EN ISO 12100 and all other standards that apply to your application.
- Use redundant components and/or control paths for all critical control functions identified in your risk assessment.
- Implement all monitoring functions required to avoid any type of hazard identified in your risk assessment, for example, slipping or falling loads, in particular, if you do not operate the drive in closed loop mode which provides certain internal monitoring functions such as BRH3 [BRH b3], BRH4 [BRH b4] and BRH5 [BRH b5].
- Verify that the service life of all individual components used in your application is sufficient for the intended service life of your overall application.
- Perform extensive commissioning tests for all potential error situations to verify the effectiveness of the safety-related functions and monitoring functions implemented, for example, but not limited to, speed monitoring by means of encoders, short circuit monitoring for all connected equipment, correct operation of brakes and guards.
- Perform extensive commissioning tests for all potential error situations to verify that the load can be brought to a safe stop under all conditions.

**Failure to follow these instructions can result in death, serious injury, or equipment damage.**

A specific application note NHA80973 is available on hoisting machines and can be downloaded on [se.com](http://se.com).

When the drive transitions to operating state Fault, the mains contactor and the brake contactor must be deenergized.

**⚠ WARNING**

**UNANTICIPATED EQUIPMENT OPERATION**

- Assign [Operating State Fault] FLT to output relay R1.
- Connect the coil of the mains contactor to output relay R1.
- Connect the contact of the brake contactor downstream of the mains contactor.

**Failure to follow these instructions can result in death, serious injury, or equipment damage.**

Step	Action
1	Enter the motor nameplate parameters.
2	Set [Motor Thermal Mode] THT according to the cooling mode.
3	Verify [Autotuning Usage] TUNU is set to [Therm mot] TM or set it, then perform a motor autotuning ([Autotuning] TUN to [Apply Autotuning] YES). <b>NOTE:</b> The autotuning must be performed with a cold motor.
4	Assign [Brake assignment] BLC. It activates the function and the assigned output controls the command to release/apply the brake.
5	Verify [Movement type] BST is set to [Hoisting] VER.
6	Set [Brake Release Pulse] BIP to [Yes] YES. Ensure that the direction of rotation forward (i.e. forward digital input with positive reference frequency) corresponds to the lift of the load.  For applications in which the load being lowered is very different from the load being lifted, set [Brake Release Pulse] BIP = [2 IBR] 2IBR (i.e., ascent always with a load and descent always without a load).

Step	Action
7	Assign <b>[Brake Contact]</b> <b>BCI</b> to handle the brake contact feedback and/or <b>[Brake Relay Fdbk]</b> <b>BRI</b> to handle the brake contactor feedback. If necessary, adjust <b>[Brake Fdbk Filter]</b> <b>FBCI</b> and/or <b>[Brake Rly Fdbk Filter]</b> <b>FBRI</b> .
8	Brake release current <b>[Brk Release Current]</b> <b>IBR</b> and <b>[Brake release I Rev]</b> <b>IRD</b> if <b>[Brake Release Pulse]</b> <b>BIP = [2 IBR]</b> <b>2IBR</b> : adjust the brake release current to the rated current indicated on the motor. During testing, adjust the brake release current in order to hold the load smoothly.
9	Acceleration time: for hoisting applications it is advisable to set the acceleration ramps to more than 0.5 seconds. Ensure that the drive does not exceed the current limit.  The same recommendation applies for deceleration.  Reminder: for a hoisting movement, a braking resistor should be used.
10	<b>[Brake Release time]</b> <b>BRT</b> : set according to the type of brake. It is the time required for the mechanical brake to release.  This parameter must consider the maximum value of <b>[Brake Fdbk Filter]</b> <b>FBCI</b> and <b>[Brake Rly Fdbk Filter]</b> <b>FBRI</b> .
11	<b>[Brake release freq]</b> <b>BIR</b> , in open-loop mode only: Leave in <b>[Auto]</b> <b>AUTO</b> , adjust if necessary.
12	<b>[Brake engage freq]</b> <b>BEN</b> : leave in <b>[Auto]</b> , adjust if necessary.
13	<b>[Brake engage time]</b> <b>BET</b> : set according to the type of brake. It is the time required for the mechanical brake to engage.  This parameter must consider the maximum value of <b>[Brake Fdbk Filter]</b> <b>FBCI</b> and <b>[Brake Rly Fdbk Filter]</b> <b>FBRI</b> .

## Instructions for Brake Logic Control for an Horizontal Hoisting Application

Your application consists of a whole range of different interrelated mechanical, electrical, and electronic components, the drive being just one part of the application. The drive by itself is neither intended to nor capable of providing the entire functionality to meet all safety-related requirements that apply to your application. Depending on the application and the corresponding risk assessment to be conducted by you, a whole variety of additional equipment is required such as, but not limited to, external encoders, external brakes, external monitoring devices, guards, etc.

As a designer/manufacturer of machines, you must be familiar with and observe all standards that apply to your machine. You must conduct a risk assessment and determine the appropriate Performance Level (PL) and/or Safety Integrity Level (SIL) and design and build your machine in compliance with all applicable standards. In doing so, you must consider the interrelation of all components of the machine. In addition, you must provide instructions for use that enable the user of your machine to perform any type of work on and with the machine such as operation and maintenance in a safe manner.

The present document assumes that you are fully aware of all normative standards and requirements that apply to your application. Since the drive cannot provide all safety-related functionality for your entire application, you must ensure that the required Performance Level and/or Safety Integrity Level is reached by installing all necessary additional equipment.

**⚠ WARNING**

**INSUFFICIENT PERFORMANCE LEVEL/SAFETY INTEGRITY LEVEL AND/OR UNINTENDED EQUIPMENT OPERATION**

- Conduct a risk assessment according to EN ISO 12100 and all other standards that apply to your application.
- Use redundant components and/or control paths for all critical control functions identified in your risk assessment.
- Implement all monitoring functions required to avoid any type of hazard identified in your risk assessment, for example, slipping or falling loads, in particular, if you do not operate the drive in closed loop mode which provides certain internal monitoring functions such as BRH3 [BRH b3], BRH4 [BRH b4] and BRH5 [BRH b5].
- Verify that the service life of all individual components used in your application is sufficient for the intended service life of your overall application.
- Perform extensive commissioning tests for all potential error situations to verify the effectiveness of the safety-related functions and monitoring functions implemented, for example, but not limited to, speed monitoring by means of encoders, short circuit monitoring for all connected equipment, correct operation of brakes and guards.
- Perform extensive commissioning tests for all potential error situations to verify that the load can be brought to a safe stop under all conditions.

**Failure to follow these instructions can result in death, serious injury, or equipment damage.**

A specific application note NHA80973 is available on hoisting machines and can be downloaded on [se.com](http://se.com).

When the drive transitions to operating state Fault, the mains contactor and the brake contactor must be deenergized.

**⚠ WARNING**

**UNANTICIPATED EQUIPMENT OPERATION**

- Assign [Operating State Fault] FLT to output relay R1.
- Connect the coil of the mains contactor to output relay R1.
- Connect the contact of the brake contactor downstream of the mains contactor.

**Failure to follow these instructions can result in death, serious injury, or equipment damage.**

Step	Action
1	Enter the motor nameplate parameters.
2	Set [Motor Thermal Mode] THT according to the cooling mode.
3	Verify [Autotuning Usage] TUNU is set to [Therm mot] TM or set it, then perform a motor autotuning ([Autotuning] TUN to [Apply Autotuning] YES). <b>NOTE:</b> The autotuning must be performed with a cold motor.
4	Assign [Brake assignment] BLC. It activates the function and the assigned output controls the command to release/apply the brake.
5	Set [Movement type] BST to [Traveling] HOR.
6	Set [Brake Release Pulse] BIP to [No] NO.
7	Assign [Brake Contact] BCI to handle the brake contact feedback and/or [Brake Relay Fdbk] BRI to handle the brake contactor feedback. If necessary, adjust [Brake Fdbk Filter] FBFI and/or [Brake Rly Fdbk Filter] FBRI.
8	[Brk Release Current] IBR: set to [No] NO.

Step	Action
9	<b>[Brake Release time] BRT</b> : set according to the type of brake. It is the time required for the mechanical brake to release.  This parameter must consider the maximum value of <b>[Brake Fdbk Filter] FBCL</b> and <b>[Brake Rly Fdbk Filter] FBRL</b> .
10	<b>[Brake engage freq] BEN</b> , in open-loop mode only: leave in <b>[Auto] AUTO</b> , adjust if necessary.
11	<b>[Brake engage time] BET</b> : set according to the type of brake. It is the time required for the mechanical brake to engage.  This parameter must consider the maximum value of <b>[Brake Fdbk Filter] FBCL</b> and <b>[Brake Rly Fdbk Filter] FBRL</b> .

## Horizontal Movement in Open-Loop Mode

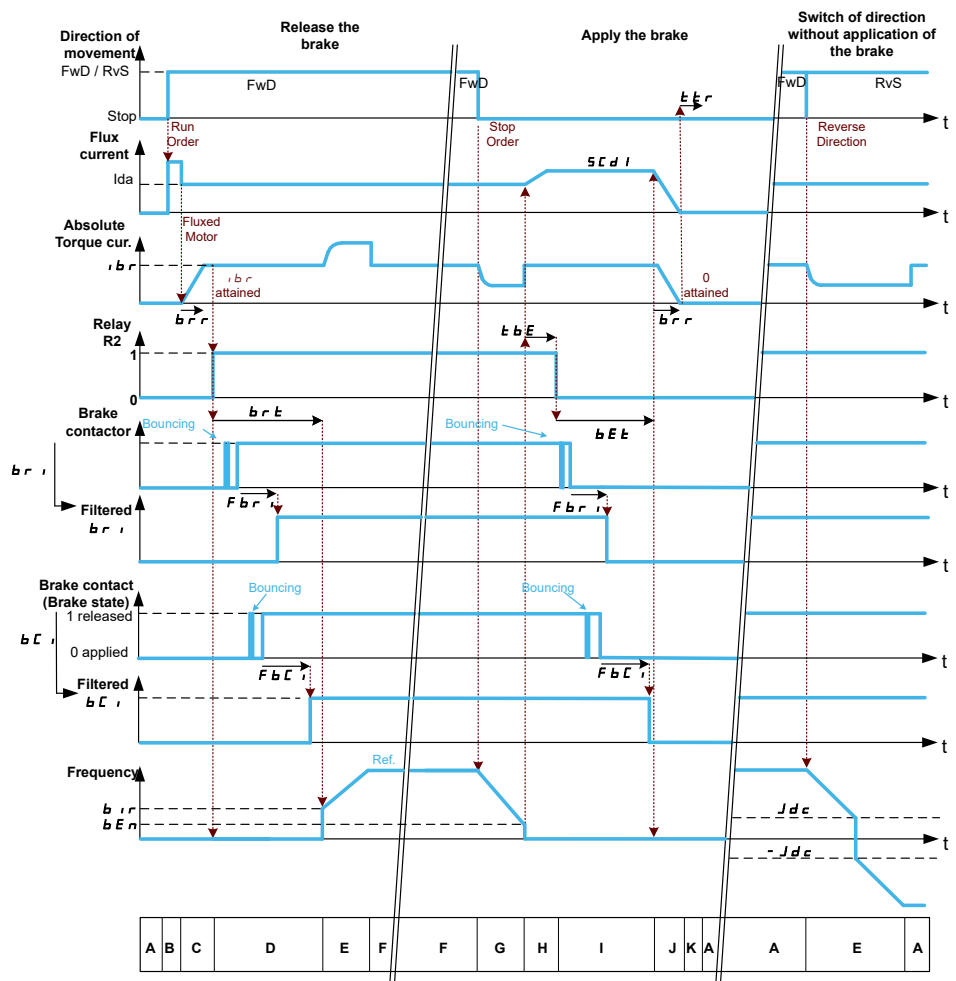

- A: Waiting for run command
- B: Motor fluxing
- C: Injection of the torque-generating current
- D: Release of the brake
- E: Acceleration/deceleration
- F: Reference value attained
- G: Deceleration due to stop command
- H: Delay before command to apply the brake
- I: Application of the brake
- J: Removal of current
- K: Restart delay

## Vertical Movement in Open-Loop Mode

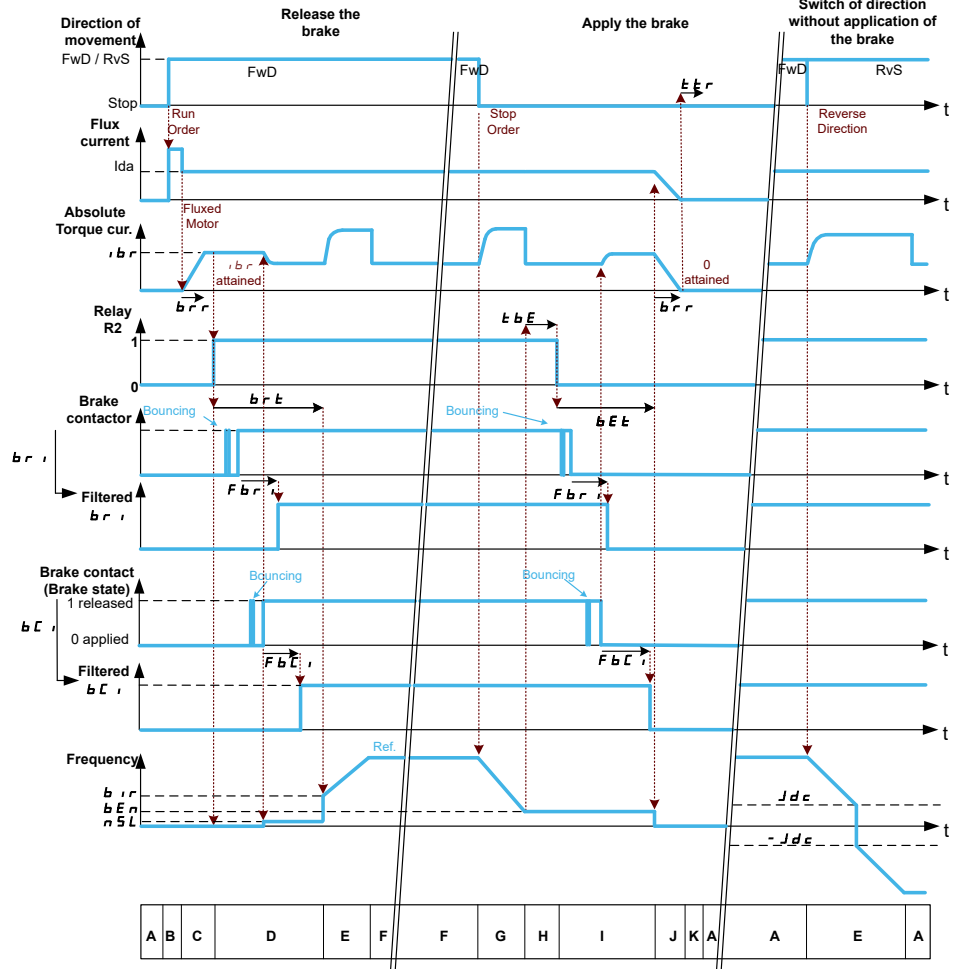

- |                                                      |                                                   |
|------------------------------------------------------|---------------------------------------------------|
| <b>A:</b> Waiting for run command                    | <b>G:</b> Deceleration due to stop command        |
| <b>B:</b> Motor fluxing                              | <b>H:</b> Delay before command to apply the brake |
| <b>C:</b> Injection of the torque-generating current | <b>I:</b> Application of the brake                |
| <b>D:</b> Release of the brake                       | <b>J:</b> Removal of current                      |
| <b>E:</b> Acceleration/deceleration                  | <b>K:</b> Restart delay                           |
| <b>F:</b> Reference value attained                   |                                                   |

## Vertical or Horizontal Movement in Closed-Loop Mode

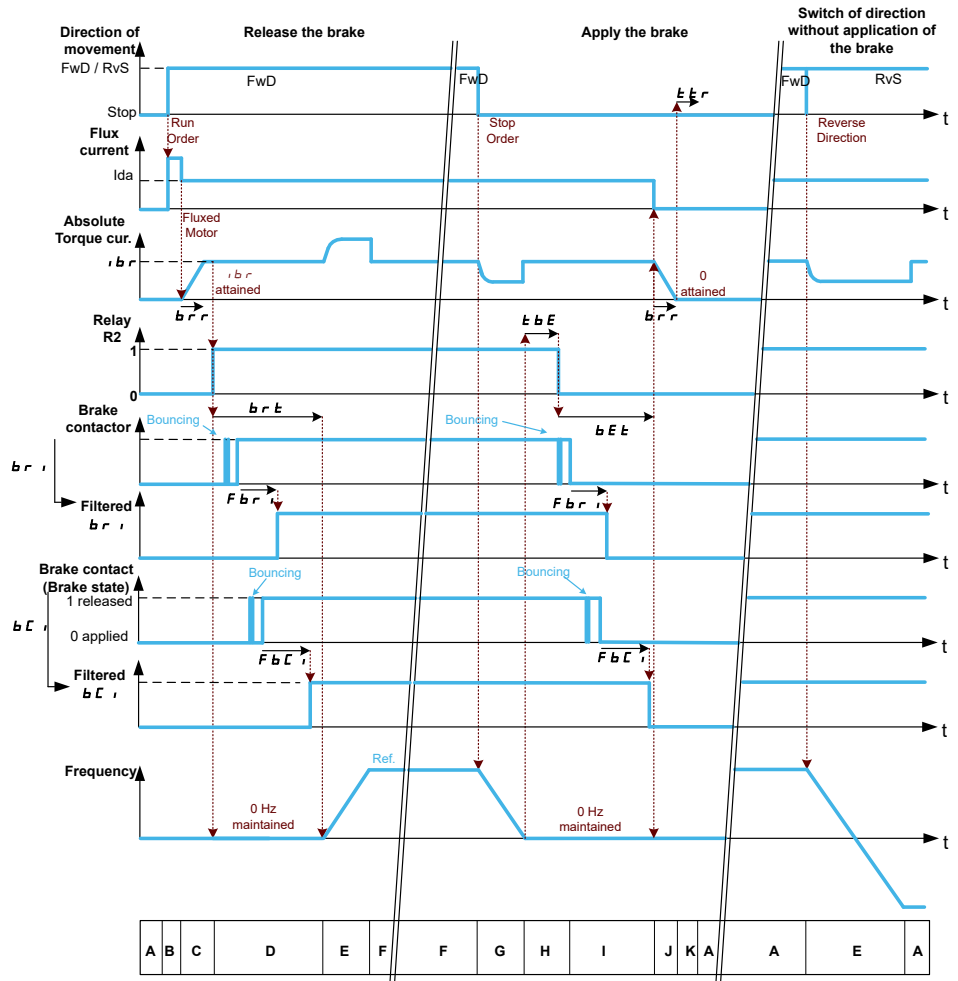

- A: Waiting for run command
- B: Motor fluxing
- C: Injection of the torque-generating current
- D: Release of the brake
- E: Acceleration/deceleration
- F: Reference value attained
- G: Deceleration due to stop command
- H: Delay before command to apply the brake
- I: Application of the brake
- J: Removal of current
- K: Restart delay

## Behavior at run command

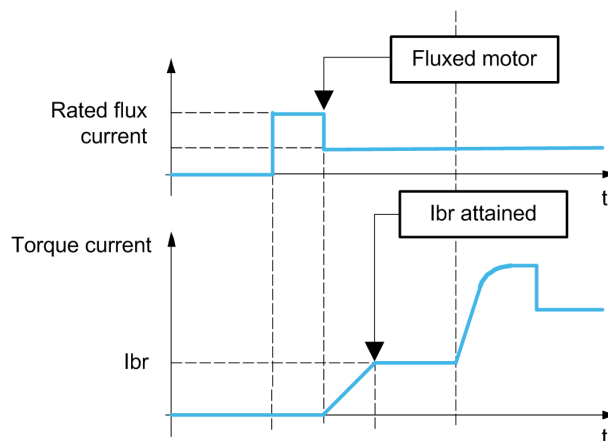

When run command is given, the drive over-fluxes the motor during a short time in order to generate a sufficient motor torque. The level of the torque is set with the parameter **[Brk Release Current] I<sub>BR</sub>**. This torque is required to maintain the load during the release of the brake and before starting speed control.

The parameter **[Rotor Time Const] T<sub>RA</sub>** is the time needed by the motor to be fluxed. This parameter is computed by the drive using the values of the parameters [Nom Motor Current] **[Nom Motor Current] N<sub>CR</sub>**, **[Motor 1 Cosinus Phi] C<sub>OS</sub>**, **[Nom Motor Voltage] U<sub>NS</sub>** and **[Nominal Motor Speed] N<sub>SP</sub>** which have to be set properly according to the motor specification.

Before releasing the brake, by the means of the relay output R2 set with the parameter **[Brake assignment] B<sub>LC</sub>**, the drive verifies the two following conditions:

- The fluxing current is stable.
- The torque set point is reached.

If one of the both conditions is not fulfilled, the drive does not release the brake and triggers the error **[Brake Control] B<sub>LF</sub>**.

This error can be triggered, for example, if one phase of the motor is not properly connected to the motor output of the drive.

## [Brake assignment] B<sub>LC</sub>

**[Brake assignment] B<sub>LC</sub>** is forced to **[No] NO** if :

- **CTT** is set to **[U/F VC 5pts] U<sub>F5</sub>**, **[SYN\_U VC] S<sub>YNU</sub>**, **[Sync. mot.] S<sub>YN</sub>**, **[Reluctance Motor] S<sub>RV</sub>C**.
- **[DC Injection Assign] D<sub>CI</sub>** is assigned.
- **[Catch On Fly] F<sub>LR</sub>** is configured.
- **[Jog Assign] J<sub>OG</sub>** is assigned.
- **[PID feedback Assign] P<sub>IF</sub>** is configured.
- **[OutPhaseLoss Assign] O<sub>PL</sub>** is set to **[No Error Triggered] O<sub>AC</sub>**
- **[BL Mode] B<sub>QM</sub>** is configured.

**NOTE:** From firmware version V3.3, enabling **[Brake logic control] B<sub>LC</sub>**-function (i.e. assigning this parameter to an output) presets **[Autotuning Usage] T<sub>UNU</sub>** to **[Therm mot] T<sub>M</sub>**.

Value range	Code / Value	Description
<b>[No]</b>	NO	Not assigned <b>Factory setting</b>
<b>[R2]...[R3]</b>	R2...R3	Relay output R2...R3 <b>NOTE:</b> R3 selection can be accessed on drives with a power greater than 22 kW.
<b>[R4]...[R6]</b>	R4...R6	Relay output R4...R6 if VW3A3204 relay output option module has been inserted
<b>[DQ1 Digital Output]</b>	DO1	Digital output DQ1...DQ2 <b>NOTE:</b> DQ2 selection can be accessed on drives with a power below than 30 kW.
<b>[DQ11 Digital Output]... [DQ12 Digital Output]</b>	DO11...DO12	Digital output DQ11...DQ12 if VW3A3203 I/O extension module has been inserted

## [Movement type] B<sub>ST</sub> ★

Brake sequence type.

This parameter can be accessed if **[Brake assignment]** **BLC** is assigned (i.e. different from **[No]** **NO**).

This parameter is forced to **[Hoisting]** **VER** if **[Weight Sensor Assign]** **PES** is assigned.

Value	Code / Value	Description
<b>[Traveling]</b>	<b>HOR</b>	Resistive-load movement (translational motion of overhead crane, for example).
<b>[Hoisting]</b>	<b>VER</b>	Driving-load movement (hoisting winch, for example). <b>Factory setting</b>

## [Brake Contact] **BCI** ★

This parameter can be accessed if **[Brake assignment]** **BLC** is assigned (i.e. different from **[No]** **NO**).

If the brake has a monitoring contact (closed for released brake).

Value range	Code / Value	Description
<b>[Not Assigned]</b>	<b>NO</b>	Not assigned <b>Factory setting</b>
<b>[DI1]...[DI8]</b>	<b>LI1...LI8</b>	Digital input DI1...DI8 <b>NOTE:</b> DI8 selection can be accessed on drives with a power greater than 22kW.
<b>[DI11]...[DI16]</b>	<b>LI11...LI16</b>	Digital input DI11...DI16 if VW3A3203 I/O extension module has been inserted
<b>[CD00]... [CD10]</b>	<b>CD00...CD10</b>	Virtual digital input CMD.0...CMD.10 in <b>[I/O profile]</b> <b>IO</b> configuration
<b>[CD11]... [CD15]</b>	<b>CD11...CD15</b>	Virtual digital input CMD.11...CMD.15 regardless of configuration
<b>[C101]... [C110]</b>	<b>C101...C110</b>	Virtual digital input CMD1.01...CMD1.10 with integrated Modbus Serial in <b>[I/O profile]</b> <b>IO</b> configuration
<b>[C111]... [C115]</b>	<b>C111...C115</b>	Virtual digital input CMD1.11...CMD1.15 with integrated Modbus Serial regardless of configuration
<b>[C201]... [C210]</b>	<b>C201...C210</b>	Virtual digital input CMD2.01...CMD2.10 with CANopen® fieldbus module in <b>[I/O profile]</b> <b>IO</b> configuration
<b>[C211]... [C215]</b>	<b>C211...C215</b>	Virtual digital input CMD2.11...CMD2.15 with CANopen® fieldbus module regardless of configuration
<b>[C301]... [C310]</b>	<b>C301...C310</b>	Virtual digital input CMD3.01...CMD3.10 with a fieldbus module in <b>[I/O profile]</b> <b>IO</b> configuration
<b>[C311]... [C315]</b>	<b>C311...C315</b>	Virtual digital input CMD3.11...CMD3.15 with a fieldbus module regardless of configuration
<b>[C501]... [C510]</b>	<b>C501...C510</b>	Virtual digital input CMD5.01...CMD5.10 with integrated Ethernet in <b>[I/O profile]</b> <b>IO</b> configuration <b>NOTE:</b> This selection can be accessed on ATV340***N4E drives.
<b>[C511]... [C515]</b>	<b>C511...C515</b>	Virtual digital input CMD5.11...CMD5.15 with integrated Ethernet regardless of configuration <b>NOTE:</b> This selection can be accessed on ATV340***N4E drives.

## [Brake Fdbk Filter] **FBCI** ★

The parameter can be accessed if **[Brake Contact]** **BCI** is assigned (i.e. different from **[Not Assigned]** **NO**).



Value range ( )	Description
0...5000 ms (step: 1 ms)	<b>Factory setting:</b> 100 ms

### [Brake Relay Fdbk] BRI

Brake relay feedback input. (also known as brake contactor feedback input)

The parameter can be accessed if [Brake assignment] BLC is assigned (i.e. different from [No] NO).

Possible settings: Identical to [Brake Contact] BCI.

### [Brake Rly Fdbk Filter] FBRI

Brake relay feedback filter. (also known as brake contactor feedback filter)

The parameter can be accessed if [Brake Relay Fdbk] BRI is assigned (i.e. different from [Not Assigned] NO).

Value range ( )	Description
0...1000 ms (step: 1 ms)	<b>Factory setting:</b> 100 ms

### [Brake Release Pulse] BIP ★

This parameter can be accessed if:

- [Brake assignment] BLC is assigned (i.e. different from [No] NO), and
- [Weight Sensor Assign] PES is set to [Not Configured] NO.

Value ( )	Code / Value	Description
[No]	NO	The motor torque is given in the required operating direction, at current [Brk Release Current] IBR. <b>Factory setting:</b> if [Movement type] BST = [Traveling] HOR
[Yes]	YES	The motor torque is always Forward (check that this direction corresponds to ascending), at current [Brk Release Current] IBR. <b>Factory setting:</b> if [Movement type] BST = [Hoisting] VER
[2 IBR]	2IBR	The torque is in required direction, at current [Brk Release Current] IBR Forward and [Brake release I Rev] IRD for Reverse, for certain specific applications.

### [Brk Release Current] IBR ★

Brake release current level.

This parameter can be accessed if:

- [Brake assignment] BLC is assigned (i.e. different from [No] NO), and
- [Weight Sensor Assign] PES is set to [Not Configured] NO.

Value range (°)	Description
0...1.1 <b>IN</b> <sup>(1)</sup> (step: 0.01 A) <sup>(2)</sup>	<b>Factory setting:</b> [Nom Motor Current] <b>NCR</b>
<p>(1): <b>IN</b> corresponds to the rated drive current indicated in the Installation Manual and on the drive nameplate.</p> <p>(2): For drives with power range ≤ 15 kW. If the power range is between 18 and 160 kW the step is 0.1 A else the step is 1 A.</p>	

## [Brake release I Rev] **IRD**

Brake release current level for going down.

This parameter can be accessed if:

- **[Brake assignment]** **BLC** is assigned (i.e. different from **[No]** **NO**), and
- **[Brake Release Pulse]** **BIP** is set to **[2 IBR]** **2IBR**, and
- **[Weight Sensor Assign]** **PES** is set to **[Not Configured]** **NO**.

Value range (°)	Description
0...1.1 <b>IN</b> <sup>(1)</sup> (step: 0.01 A) <sup>(2)</sup>	<b>Factory setting:</b> 0
<p>(1): <b>IN</b> corresponds to the rated drive current indicated in the Installation Manual and on the drive nameplate.</p> <p>(2): For drives with power range ≤ 15 kW. If the power range is between 18 and 160 kW the step is 0.1 A else the step is 1 A.</p>	

## [Brake Release time] **BRT** ★

The parameter can be accessed if **[Brake assignment]** **BLC** is assigned (i.e. different from **[No]** **NO**).

Value range (°)	Description
0.0...5.00 s (step: 0.01 s)	<b>Factory setting:</b> 0.50 s
<p><b>NOTE:</b> The minimum value considered internally by the drive is the maximum of <b>[Brake Fdbk Filter]</b> <b>FBCI</b> and <b>[Brake Rly Fdbk Filter]</b> <b>FBRI</b>.</p>	

## [Brake release freq] **BIR** ★

The parameter can be accessed if **[Motor control type]** **CTT** is not **[FVC]** **FVC** or **[Sync.CL]** **FSY** and if **[Movement type]** **BST** is set to **[Hoisting]** **VER**.

Value range (°)	Code / Value	Description
<b>[Auto]</b>	<b>AUTO</b>	The drive takes a value based on the rated slip of the motor, calculated using the drive parameters
0.0...10.0 Hz (step: 0.1 Hz)		<p>Manual control</p> <p><b>Factory setting:</b></p> <ul style="list-style-type: none"> <li>• 0 if <b>[Movement type]</b> <b>BST</b> is set to <b>[Traveling]</b> <b>HOR</b> or <b>[Hoisting]</b> <b>VER</b> and in closed loop.</li> <li>• <b>[Auto]</b> <b>AUTO</b> if <b>[Movement type]</b> <b>BST</b> is set to <b>[Hoisting]</b> <b>VER</b> and in open loop</li> </ul>

## [Brake engage freq] BEN ★

Brake engage frequency threshold.

The parameter can be accessed if [Motor control type] CTT is not set to [FVC] FVC or [Sync.CL] FSY and if [Brake assignment] BLC is not set to [No] NO.

Value range ( )	Code / Value	Description
[Auto]	AUTO	The drive takes a value based on the rated slip of the motor, calculated using the drive parameters
0.0...10.0 Hz (step: 0.1 Hz)		Manual control <b>Factory setting:</b> <ul style="list-style-type: none"> <li>0 in closed loop.</li> <li>[Auto] AUTO in open loop</li> </ul>

## [Brake engage at 0] BECD ★

Brake engage delay when 0 speed is attained with a reference frequency = 0 Hz.

This parameter can be accessed if [Motor control type] CTT is set to:

- [FVC] FVC, or
- [Sync.CL] FSY.

This parameter can be used to adjust the brake engage delay once zero speed has been reached.

Value range	Code / Value	Description
[No]	NO	Brake does not engage while zero speed is maintained. <b>Factory setting</b>
0.0...30.0 s (step: 0.1 s)		Brake engage delay once zero speed is reached. <b>NOTE:</b> The brake engagement type depends on [BRH b6] BRH6 setting value.

## [Brake engage delay] TBE ★

Temporization at brake engage frequency.

The parameter can be accessed if [Brake assignment] BLC is assigned (i.e. different from [No] NO).

Time delay before request to engage brake. To delay brake engagement, if you wish the brake to be engaged when the drive comes to a complete stop.

Value range ( )	Description
0.00...5.00 s (step: 0.01 s)	<b>Factory setting:</b> 0.00 s

## [Brake engage time] BET ★

The parameter can be accessed if [Brake assignment] BLC is assigned (i.e. different from [No] NO).

Value range (°)	Description
0.00...5.00 s (step: 0.01 s)	<b>Factory setting:</b> 0.50 s
<b>NOTE:</b> The minimum value considered internally by the drive is the maximum of <b>[Brake Fdbk Filter] FBCI</b> and <b>[Brake Rly Fdbk Filter] FBRI</b> .	

## [Auto DC inj Level 1] SDC1 ★

### NOTICE

#### OVERHEATING

Verify that the connected motor is properly rated for the DC injection current to be applied in terms of amount and time.

**Failure to follow these instructions can result in equipment damage.**

This parameter can be accessed if:

- **[Movement type] BST** is set to **[Traveling] HOR**, and
- **[Motor control type] CTT** is not set to **[FVC] FVC** or **[Sync.CL] FSY**.

Value range (°)	Description
0...1.1 <b>IN</b> (1) (step: 0.01 A)(2)	<b>Factory setting:</b> 0.7 In (1)
(1): <b>IN</b> corresponds to the rated drive current indicated in the Installation Manual and on the drive nameplate.	
(2): For drives with power range ≤ 15 kW. If the power range is between 18 and 160 kW the step is 0.1 A else the step is 1 A.	

## [Engage at reversal] BED ★

Brake engage at speed inversion.

Can be used to select whether or not the brake engages on transition to zero speed when the operating direction is reversed.

The parameter can be accessed if **[Brake assignment] BLC** is assigned (i.e. different from **[No] NO**).

Value (°)	Code / Value	Description
<b>[No]</b>	<b>NO</b>	The brake does not engage <b>Factory setting</b>
<b>[Yes]</b>	<b>YES</b>	The brake engages

## [Jump at reversal] JDC ★

Brake: Jump frequency at direction change.

This parameter can be accessed if

- **[Motor control type] CTT** is not set to:
  - **[FVC] FVC**, or
  - **[Sync.CL] FSY**, and
- **[Movement type] BST** is set to **[Hoisting] VER**.

When the reference direction is reversed, this parameter can be used to avoid loss of torque (and consequential release of load) on transition to zero speed. Parameter is not applicable if [Engage at reversal] BED is set to [Yes] YES.

Value range ( )	Code / Value	Description
[Auto]	AUTO	The drive takes a value based on the rated slip of the motor, calculated using the drive parameters
0.0...10.0Hz (step: 0.1 Hz)		Manual control <b>Factory setting:</b> <ul style="list-style-type: none"> <li>0 If [Movement type] BST is set to [Traveling] HOR or [Hoisting] VER and in closed loop.</li> <li>[Auto] AUTO if [Movement type] BST is set to [Hoisting] VER and in open loop</li> </ul>

### [Time to restart] TTR ★

Brake time to restart.

Time between the end of a brake sequence and the start of the next brake release sequence.

The parameter can be accessed if [Brake assignment] BLC is assigned (i.e. different from [No] NO).

Value range ( )	Description
0.00...15.00 s (step: 0.01 s)	<b>Factory setting:</b> 0.00 s

### [BRH b0] BRH0 ★

Selection of the brake restart sequence if a run command is repeated while the brake is engaging.

This parameter can be accessed if:

- [Access Level] LAC is set to [Expert] EPR,
- [Brake assignment] BLC is assigned (i.e. different from [No] NO),
- [M/S Comm Mode] MSCM is set to [No] NO.

Use in open-loop and closed-loop mode

**NOTE:** [BRH b0] BRH0 is forced to [No] NO if Master/Slave function is enabled ([M/S Comm Mode] MSCM is set to a value different from [No] NO).

A run command may be requested during the brake engagement phase. Whether or not the brake release sequence is executed depends on the value selected for [BRH b0] BRH0.

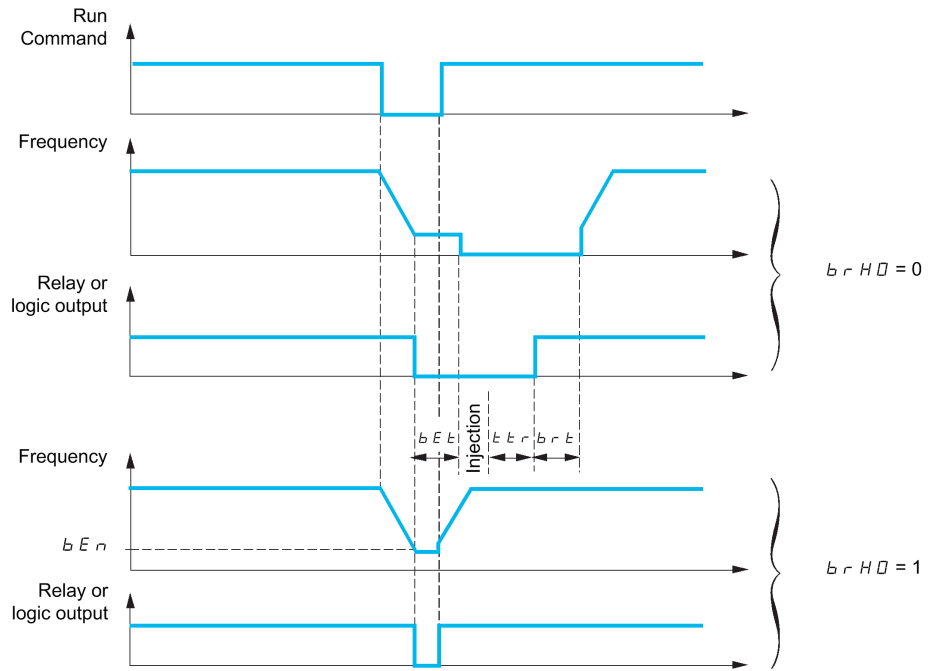

**NOTE:**

- if a run command is requested during the [Time to restart]  $TTR$  phase, the complete brake control sequence is initialized.
- If a run command is requested with [Engage at reversal]  $BED$  active, the complete brake control sequence is initialized.

Value	Code / Value	Description
[No]	NO	The engage/release sequence is executed in full. <b>Factory setting</b>
[Yes]	YES	During the brake engagement phase, if the run command is request: <ul style="list-style-type: none"> <li>• Before the end of [Brake engage delay] <math>TBE</math>, the run command is considered immediately,</li> <li>• During [Brake engage time] <math>BET</math> phase, the run command is considered with the handling of [Brake Release time] <math>BRT</math> time before the restart;</li> <li>• After [Brake engage time] <math>BET</math> phase, the brake logic sequence is completed in full.</li> </ul>

[BRH b1] BRH1 ★

Deactivation of the brake contact in steady state error.

This parameter can be accessed if [Brake assignment]  $BLC$  is assigned (i.e. different from [No] NO) and if [Access Level]  $LAC$  is set to [Expert]  $EPR$ .

Value	Code / Value	Description
[No]	NO	The brake contact in steady state error is active (error is triggered if the contact is open during operation). [Brake Feedback] $BRF$ is monitored in all operating phases <b>Factory setting</b>
[Yes]	YES	The brake contact in steady state error is inactive. [Brake Feedback] $BRF$ is only monitored during the brake release and engage phases.

[BRH b2] BRH2 ★

Taking the brake contact into account for the brake control sequence.

This parameter can be accessed if [Brake assignment] BLC is assigned (i.e. different from [No] NO) and if [Access Level] LAC is set to [Expert] EPR.

If a digit input is assigned to the brake contact.

- [BRH b2] BRH2 = [No] NO: During the brake release sequence, the reference is enabled at the end of the time [Brake Release time] BRT. During the brake engage sequence, the current changes to [No] NO according to the ramp [Current ramp time] BRR at the end of the [Brake engage time] BET.
- [BRH b2] BRH2 = [Yes] YES: When the brake is released, the reference is enabled when the [Brake Contact] BCI digit input changes to YES. When the brake is engaged, the current changes to NO according to the ramp [Current ramp time] BRR when the [Brake Contact] BCI digit input changes to NO.

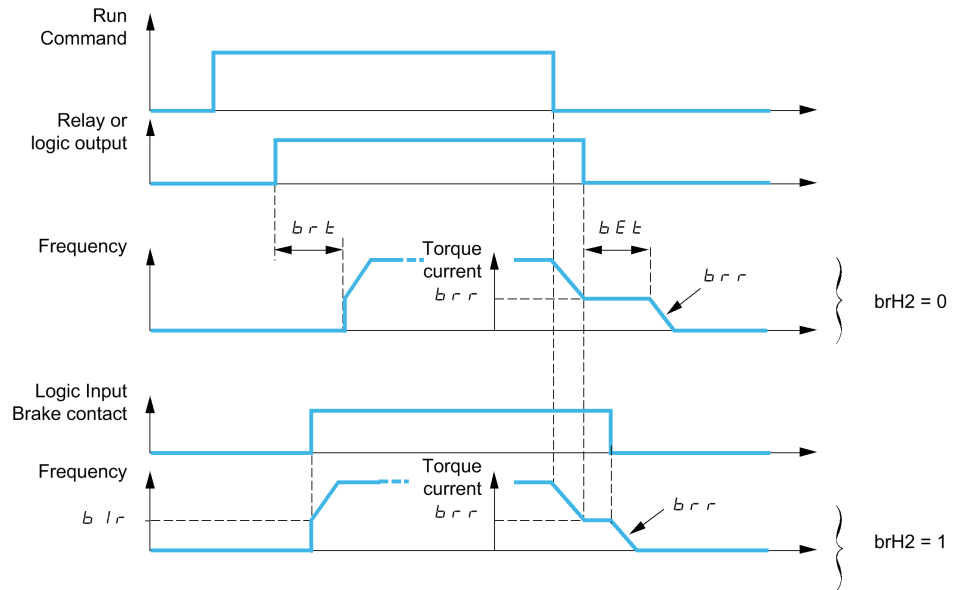

Value	Code / Value	Description
[No]	NO	The engage/release sequence is executed in full. <b>Factory setting</b>
[Yes]	YES	The brake is released immediately.

[BRH b3] BRH3 ★

In closed-loop mode only. Management of the absence of [Brake Contact] BCI and/or [Brake Relay Fdbk] BRI response, if it is assigned.

**⚠ WARNING****FALLING LOAD**

- Only set **[BRH b3] BRH3** to **[1] 1** if your application monitors the associated warning **[Brake Cont Warn] BCA**, for example, by assigning the warning **[Brake Cont Warn] BCA** to an output.
- If the warning **[Brake Cont Warn] BCA** is triggered, the following action must be taken by the user.
  - 1) Move the load to a safe position.
  - 2) Power off the drive.
  - 3) Identify and remove the cause of the warning.
  - 4) Verify correct operation of all electrical and mechanical components of the brake before resuming regular operation.

**Failure to follow these instructions can result in death, serious injury, or equipment damage.**

**⚠ WARNING****LOSS OF CONTROL**

Depending on some conditions such as power rating of the drive, load, etc. the activation of the catch on fly function used prior to maintain zero speed may not be achieved and may trigger an error.

- When setting this function to **[1] 1**, perform extensive commissioning tests to verify that no error is triggered and that the load can be brought to a safe stop under all conditions.

**Failure to follow these instructions can result in death, serious injury, or equipment damage.**

This parameter can be accessed if **[Brake assignment] BLC** is assigned (i.e. different from **[No] NO**) and if **[Access Level] LAC** is set to **[Expert] EPR**.

Value	Code / Value	Description
[No]	NO	During the brake engage sequence, the brake contact and brake contactor (relay) feedback must be open before the end of <b>[Brake engage time] BET</b> , otherwise the drive locks in a <b>[Brake Feedback] BRF</b> brake contact error.  <b>Factory setting</b>
[Yes]	YES	During the engage sequence, the brake contact and brake contactor (relay) feedback must be open before the end of <b>[Brake engage time] BET</b> , otherwise a <b>[Brake Contact Warn] BCA</b> is triggered and zero speed is maintained.  If this setting is used, behavior of the drive depends on the setting of <b>[BRH b5] BRH5</b> . Refer to the description of <b>[BRH b5] BRH5</b> for appropriate settings depending on your needs.



[BRH b4] BRH4 ★

**⚠ WARNING**

**FALLING LOAD**

- Only set the parameter [BRH b4] BRH4 to [1] if your application monitors the associated warning [Load Mvt Warn] BSA, for example, by assigning the warning [Load Mvt Warn] BSA to an output.
- If the warning [Load Mvt Warn] BSA is triggered, the following action must be taken by the user.
  - 1) Move the load to a safe position.
  - 2) Power off the drive.
  - 3) Identify and remove the cause of the warning.
  - 4) Verify correct operation of all electrical and mechanical components of the brake before resuming regular operation.

**Failure to follow these instructions can result in death, serious injury, or equipment damage.**

**⚠ WARNING**

**LOSS OF CONTROL**

Depending on some conditions such as power rating of the drive, load, etc. the activation of the catch on fly function used prior to maintain zero speed may not be achieved and may trigger an error.

- When setting this function to [1] 1, perform extensive commissioning tests to verify that no error is triggered and that the load can be brought to a safe stop under all conditions.

**Failure to follow these instructions can result in death, serious injury, or equipment damage.**

In closed-loop mode only. Out of the brake sequence (after [Time to restart] TTR time) and depending [BRH b4] BRH4 setting, triggering of an error or activation of the speed loop at zero if a movement, for which no command has been given, occurs (measurement of a speed greater than a fixed minimum threshold determined by [BRH\_b4\_freq] BFTD).

This parameter can be accessed if [Access Level] LAC is set to [Expert] EPR.

Value	Code / Value	Description
[No]	NO	If a movement occurs for which no command has been given, [Load Mvt Error] MDCF error is triggered.  <b>Factory setting</b>  <b>Note:</b> <ul style="list-style-type: none"> <li>• If this setting is used, behavior of the drive depends on the setting of [BRH_b4_freq] BFTD. Refer to the description of [BRH_b4_freq] BFTD for appropriate settings depending on your needs.</li> <li>• This behavior is irrespective of the command profile and available in all drive operating state except 2- Switch on disabled, 7- Fault Reaction Active and 8 - Fault states.</li> </ul>
[Yes]	YES	If a movement occurs for which no command has been given, the drive switches to zero speed regulation, with no brake release command, and a [Load Mvt Warn] BSA warning is triggered.  <b>NOTE:</b> If this setting is used, behavior of the drive depends on the setting of [BRH_b4_freq] BFTD and [BRH b5] BRH5. Refer to the description of these parameters for appropriate settings depending on your needs.

**[BRH b5] BRH5** ★

This parameter can be accessed if **[Brake assignment] BLC** is assigned (i.e. different from **[No] NO**) and if **[Access Level] LAC** is set to **[Expert] EPR**.

The setting of this parameter impacts the operating states of the drive within load movement is monitored, and the priority of the zero speed maintain compared to some events. It is linked to the parameters **[BRH b3] BRH3** and **[BRH b4] BRH4**.

Irrespective of the setting, the zero speed maintain has no priority compared to:

- A new run command in order to control the drive and move the load,
- An active STO,
- A lock of the drive with the function linked to the parameter **[Device Lock] LES**.
- A stop command coming from a channel other than the active command channel if **[BRH b5] BRH5** is set to **[No] NO** (see the table below).
- A triggered error if **[BRH b5] BRH5** is set to **[No] NO** (see the table below).

If one of this event occurs, the zero speed maintain is interrupted.

Value	Code / Value	Description
<b>[No]</b>	NO	<p>Load movement is monitored only in the following drive operating states:</p> <ul style="list-style-type: none"> <li>• CIA402 command profile: 5-Operation Enabled, 6-Quick Stop Active.</li> <li>• Other command profiles (Graphic Display Terminal, I/O, etc): 3-Ready to switch on, 4-Switched-on, 5-Operation enabled.</li> </ul> <p>For example, when the product is controlled under Cia402 profile:</p> <ul style="list-style-type: none"> <li>• In Freewheel stop (NST) or in Operating State Fault (FLT), the load movement detection is not monitored.</li> <li>• If the drive is stopped by a halt command (bit 8 of the command word CMD), the drive remains in operation enabled then, the load movement detection is monitored.</li> </ul> <p>The zero speed maintain has no priority compared to a triggered error and a stop command coming from a channel other than the active command channel.</p> <p><b>Factory setting</b></p>
<b>[Yes]</b>	YES	<p>Irrespective of the command profile, in all drive operating state except 7- Fault Reaction Active and 8 - Fault states, the load movement monitoring function is active.</p> <p>The zero speed maintain has priority compared to an error that can be disabled (see <b>[Disable Error Detect] INH</b>).</p>

**[BRH b6] BRH6** ★

This parameter can be accessed if **[Access Level] LAC** is set to **[Expert] EPR**.

Selection of the brake engage type if **[Brake engage at 0] BECD** is set to a numeric value.

Value	Code / Value	Description
[No]	NO	<p>The brake is closed (including the handling of <b>[Brake engage time] BET</b>) and the zero speed is still maintained. Then:</p> <ul style="list-style-type: none"> <li>If a reference frequency other than zero is requested, the command to release the brake is sent following torque application with the handling of <b>[Brake Release time] BRT</b>.</li> <li>If a stop command (external to the drive) is requested, the brake engage sequence is completed.</li> </ul> <p><b>Factory setting</b></p> <p><b>NOTE:</b> the stop command is only considered after <b>[Brake engage time] BET</b>.</p>
[Yes]	YES	<p>After the delay set by <b>[Brake engage at 0] BECD</b>, A stop command is executed by the drive, the brake engage sequence is fully executed.</p>

### [Current ramp time] BRR ★

This parameter can be accessed if **[Brake assignment] BLC** is assigned (i.e. different from **[No] NO**).

Torque current ramp time (increase and decrease) for a current variation equal to **[Brk Release Current] IBR**.

Value range ( )	Description
0.00...5.00 s (step: 0.01 s)	<b>Factory setting:</b> 0.00 s

### [BRH\_b4\_freq] BFTD ★

BRH\_b4 frequency threshold detection.

This parameter represents the detection threshold for **[BRH b4] BRH4**. The required value depends on the response of the mechanical installation.

If the value of the parameter **[BRH\_b4\_freq] BFTD** is too low, this may lead to unwanted triggering of load movement monitoring.

If the value of the parameter **[BRH\_b4\_freq] BFTD** is too high, load movement monitoring may not trigger when required.

<b>⚠ WARNING</b>
<p><b>LOSS OF CONTROL</b></p> <p>Verify that the setting of this parameter is suitable for the application by performing comprehensive commissioning tests for all load conditions and all potential error conditions.</p> <p><b>Failure to follow these instructions can result in death, serious injury, or equipment damage.</b></p>

Setting **[BRH\_b4\_freq] BFTD** to **[No] NO** disables load movement monitoring. Unintended movements and falling of the load are not detected with this setting.

<b>⚠ WARNING</b>
<p><b>FALLING LOAD</b></p> <p>Verify that the setting of this parameter does not result in unsafe conditions.</p> <p><b>Failure to follow these instructions can result in death, serious injury, or equipment damage.</b></p>

This parameter can be accessed if

- **[Brake assignment]** *BLC* is assigned (i.e. different from **[No]** *NO*), and,
- **[Motor control type]** *CTT* is set to **[FVC]** *FVC* or **[Sync.CL]** *FSY*.

This parameter cannot be set to **[No]** *NO* if **[BRH b4]** *BRH4* is set **[Yes]** *YES*. Setting back **[BRH b4]** *BRH4* to **[No]** *NO* does not set **[BRH\_b4\_freq]** *BFTD* to **[No]** *NO*.

Value range (°)	Code / Value	Description
<b>[No]</b>	<i>NO</i>	The load movement monitoring function is disabled.
0.1...10 Hz (step: 0.1 Hz)		Setting range  <b>Factory setting:</b> 10% of <b>[Nominal Motor Freq]</b> <i>FRS</i> or <b>[Sync Nominal Freq]</b> <i>FRS</i> depending on <b>[Motor control type]</b> <i>CTT</i> .

## [Load Maintain Time] *MDFT*

Load maintain time before error.

When zero speed maintain is activated, **[Load Mvt Error]** *MDCF* error is triggered at the end of this duration.

If zero speed maintain is active, the remaining time before triggering the error is displayed with the parameter **[Load Maintain Delay]** *MTBF*. If a new run command is applied, the load movement monitoring function is temporary inactive and the remaining time **[Load Maintain Delay]** *MTBF* is frozen.

Reset of **[Load Maintain Delay]** *MTBF* requires a power cycle or a product restart.

This parameter can be accessed if:

- **[BRH b5]** *BRH5* is set to **[Yes]** *YES* and,
- **[Motor control type]** *CTT* is set to **[FVC]** *FVC* or **[Sync.CL]** *FSY*.

Value range (°)	Code / Value	Description
<b>[No]</b>	<i>NO</i>	Time before error is deactivated.  <b>Factory setting</b>
1...60 min (step: 1 min)		Setting range

## [Load Maintain Delay] *MTBF*

Load maintain remaining time before error.

Read-only parameter.

This parameter can be accessed if **[Load Maintain Time]** *MDFT* is configured (i.e. different from **[No]** *NO*).

Value range	Description
0...3,600 s (step: 1 s)	<b>Factory setting:</b> -

## [High speed hoisting] HSH- Menu

### Access

[Complete settings] → [Hoisting Functions] → [High speed hoisting]

### About This Menu

**NOTE:** This function cannot be used with some other functions.

This function can be used to optimize the cycle times for hoisting movements for zero or lightweight loads. It authorizes operation at "constant power" in order to reach a speed greater than the rated speed without exceeding the rated motor current.

The speed remains limited by the [High Speed] HSP.

The function acts on the speed reference pedestal and not on the reference itself.

### Principle

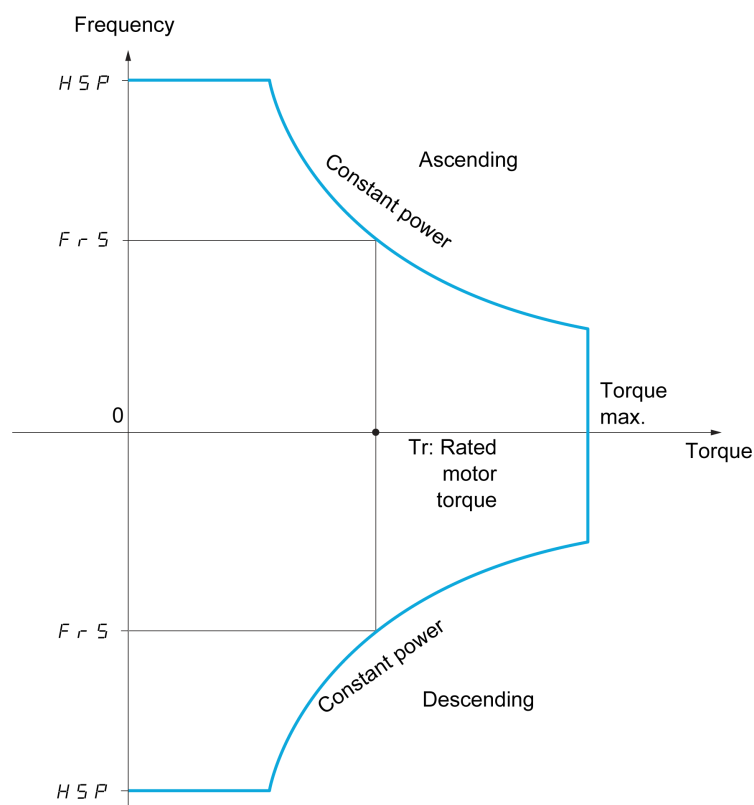

There are two possible operating modes:

- Speed reference mode: the maximum permissible speed is calculated by the drive during a speed step that is set so that the drive can measure the load.
- Current limitation mode: the maximum permissible speed is the speed that supports current limitation in motor mode, in the "ascending" direction only. For the "descending" direction, operation is in Speed reference mode.

## Speed Reference Mode

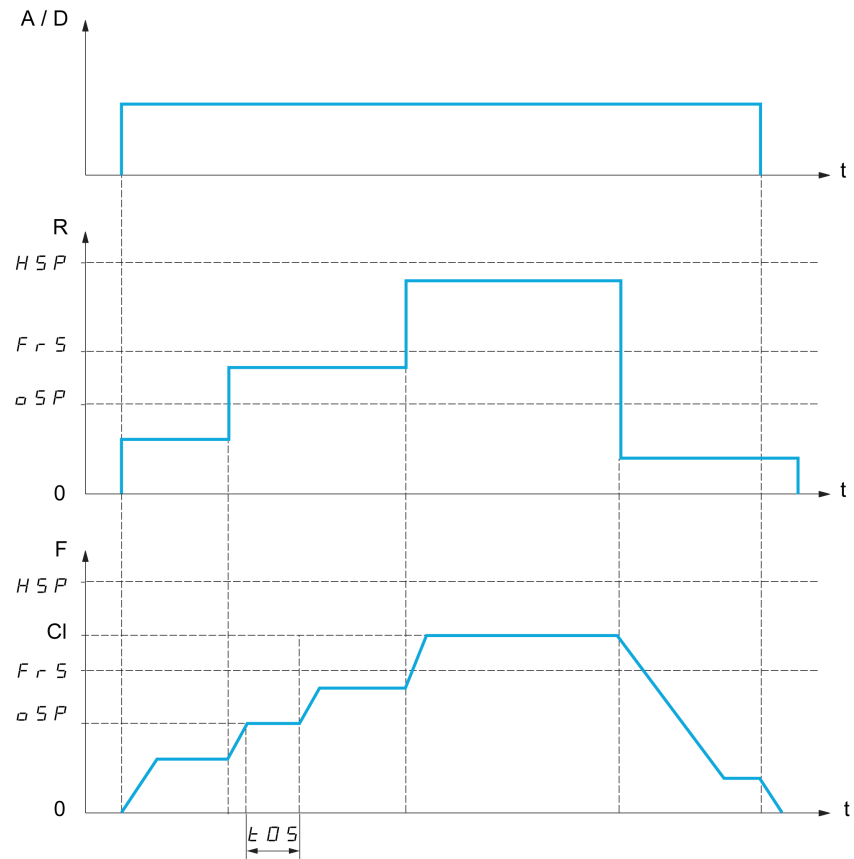

**A / D** Ascend or descend command

**R** Reference

**F** Frequency

**CI** Calculated limit

**aSP** Adjustable speed step for load measurement

**tOS** Load measuring time

2 parameters are used to reduce the speed calculated by the drive, for ascending and descending.

## Current Limiting Mode

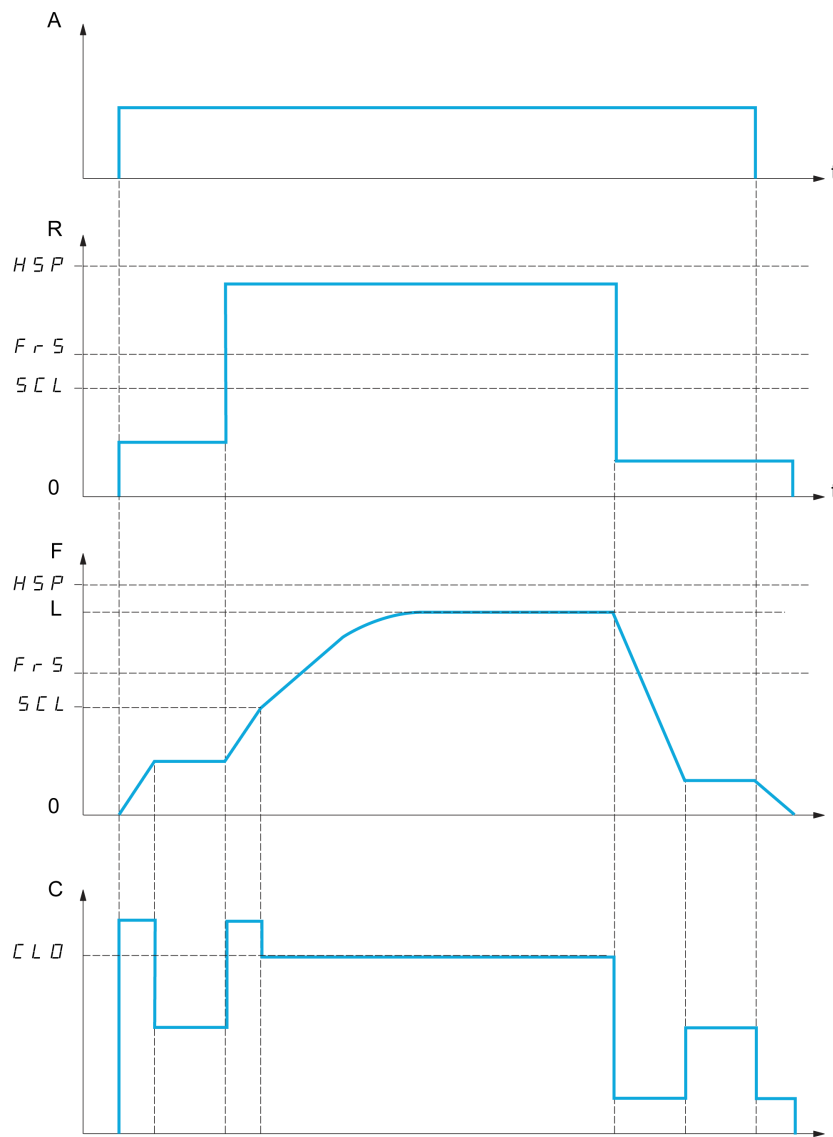

**A** Ascend command

**R** Reference

**F** Frequency

**L** Limit imposed by current limitation

**C** Current

**SCL** Adjustable speed threshold, above which current limitation is active

**CLO** Current limitation for high-speed function

**NOTE:** The speed reached for a specific current is lower in case of network undervoltage in comparison with nominal network voltage.

## Working at Constant Torque up to 87Hz

Depending of the motor isolation class, it is possible to supply motor with a voltage greater than one specified for its coupling.

For example, a 230/400 Vac motor wired and coupled (in delta) to work at 230 Vac / 50 Hz can be supplied at 400 V to work with constant torque up to 87 Hz.

Some motors have information on nameplate to work at 400 Vac / 87 Hz

To allow the high speed hoisting function working at 87 Hz, the following parameters must be configured as follows:

Step	Action
1	Configure <b>[Max Frequency]</b> TFR to 87 Hz.
2	Configure <b>[High Speed]</b> HSP to 87 Hz.
3	Configure <b>[Nom Motor Current]</b> NCR with the nominal current for delta coupling written on motor nameplate.
4	Configure <b>[Nominal Motor Freq]</b> FRS to 87 Hz.
5	Configure <b>[Nom Motor Voltage]</b> UNS with the result of following formula: $UNS_{87Hz} = UNS_{50Hz} \times \frac{FRS_{87Hz}}{FRS_{50Hz}}$
6	Configure <b>[Nominal Motor Speed]</b> NSP with the result of following formula: $NSP_{87Hz} = \frac{60}{n_p} \times 87 - \left( \frac{60}{n_p} \times 50 - NSP_{50Hz} \right)$ <b>NOTE:</b> With Np: $n_p = \frac{FRS_{50Hz} \times 60}{NSP_{50Hz}}$ with $n_p \in \mathbb{N}$
7	Configure <b>[Nominal Motor Power]</b> NPR with the result of following formula: $NPR_{87Hz} = NPR_{50Hz} \times \frac{n_p NSP_{87Hz} + 30FRS_{87Hz}}{n_p NSP_{50Hz} + 30FRS_{50Hz}}$ <b>NOTE:</b> With Np: $n_p = \frac{FRS_{50Hz} \times 60}{NSP_{50Hz}}$ with $n_p \in \mathbb{N}$
8	Perform an autotuning of the motor by setting <b>[Autotuning]</b> TUN to value <b>[Apply Autotuning]</b> YES.

## Rope Slack

The Rope slack function can be used to help to prevent starting up at high speed when a load has been set down ready for lifting but the rope is still slack (as illustrated below).

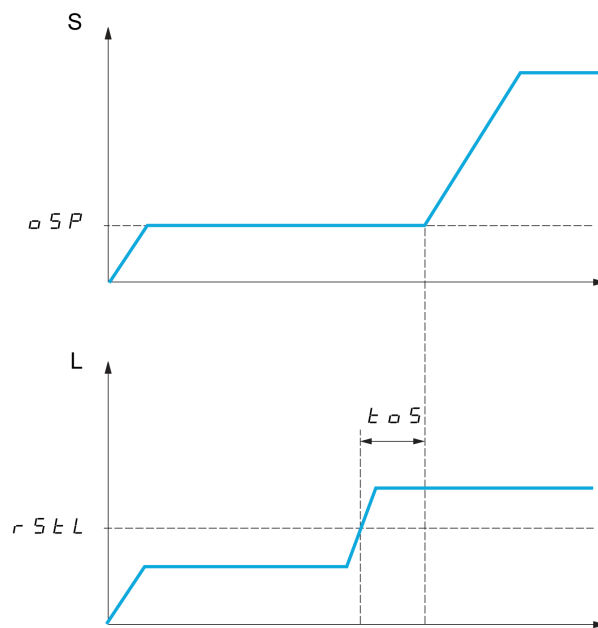
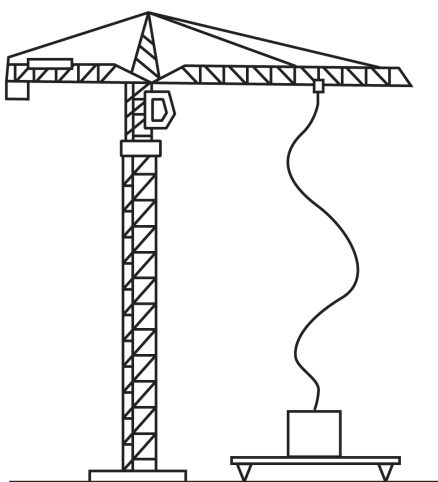

S Speed

L Load



The speed step (OSP parameters) is used to measure the load. The effective measurement cycle is not triggered until the load reaches the adjustable threshold **[Rope slack trq level]** *RSTL*, which corresponds to the weight of the hook.

A digital output or a relay can be assigned to the indication of the Rope slack state in the **[Input/Output]** *IO* – menu.

**NOTE:** The speed reached for a specific current is lower in case of network undervoltage in comparison with nominal network voltage.

## [High speed hoisting] HSO

### High speed hoisting.

Setting	Code / Value	Description
[No]	NO	Function inactive <b>Factory setting</b>
[Reference Frequency]	SSO	Speed reference mode
[Current Limit]	CSO	Current limitation mode

## [Motor speed coeff.] COF ★

Coefficient Optimize Forward (motor quadrant).

This parameter can be accessed if **[High speed hoisting]** *HSO* is set to **[Reference Frequency]** *SSO*.

Setting ( )	Description
0...100%	Setting range <b>Factory setting:</b> 100%

## [Gen. speed coeff] COR ★

Coefficient Optimize Reverse (generator quadrant).

This parameter can be accessed if **[High speed hoisting]** *HSO* is not set to **[No]** *NO*.

Setting ( )	Description
0...100%	Setting range <b>Factory setting:</b> 50%

## [Load measuring tm.] TOS ★

Torque measuring time.

This parameter can be accessed if **[High speed hoisting]** *HSO* is not set to **[No]** *NO*.

Setting ( )	Description
0.10...65.00 s	Setting range <b>Factory setting:</b> 0.50 s

**[Measurement spd] OSP** ★

Optimize Speed.

This parameter can be accessed if **[High speed hoisting]** HSO is not set to **[No]** NO.

Setting (°)	Description
0.0...599.0 Hz	Setting range <b>Factory setting:</b> 40 Hz

**[High speed I Limit] CLO** ★

Current Limitation Optimize.

This parameter can be accessed if **[High speed hoisting]** HSO is set to **[Current Limit]** CSO.

**NOTE:** If the setting is less than 0.25 I<sub>n</sub>, the drive may lock in **[OutPhaseLoss Assign]** OPL error if this has been enabled.

Setting (°)	Description
0...1.1 I <sub>n</sub> <sup>(1)</sup>	Setting range <b>Factory setting:</b> I <sub>n</sub> <sup>(1)</sup>
<b>(1)</b> I <sub>n</sub> corresponds to the rated drive current indicated in the Installation Manual and on the drive nameplate.	

**[I Limit. frequency] SCL** ★

Frequency threshold, above which the high-speed limitation current is active.

This parameter can be accessed if **[High speed hoisting]** HSO is set to **[Current Limit]** CSO.

Setting (°)	Description
0.0...599.0 Hz	Setting range <b>Factory setting:</b> 40.0 Hz

**[Rope slack config.] RSD** ★

Load measurement feedback.

This parameter can be accessed if **[High speed hoisting]** HSO is not set to **[No]** NO.

Setting	Code / Value	Description
<b>[No]</b>	NO	Function inactive <b>Factory setting</b>
<b>[Weight Estimation]</b>	DRI	Measurement of the load by estimating the torque generated by the drive
<b>[Ext Weight Sensor]</b>	PES	Measurement of the load using a weight sensor. It can only be assigned if <b>[Ext Weight Sensor]</b> PES is not set to <b>[Not Configured]</b> NO.

## [Rope slack trq level] RSTL ★

Adjustment threshold corresponding to a load weighing slightly less than the hook when off-load, as a % of the rated load.

This parameter can be accessed if **[Rope slack config.]** RSD has been assigned.

Setting ( )	Description
0...100%	Setting range <b>Factory setting:</b> 0%

## [Load Sharing] LDS- Menu

### Access

[Complete settings] → [Hoisting Functions] → [Load Sharing]

### About This Menu

Principle:

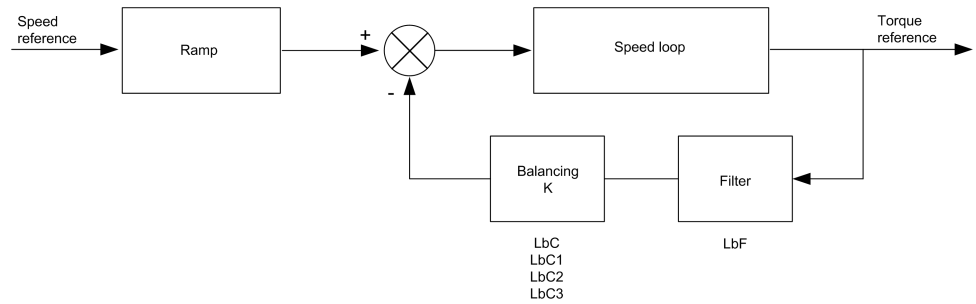

The load sharing factor  $K$  is determined by the torque and speed, with two factors  $K1$  and  $K2$  ( $K = K1 \times K2$ ).

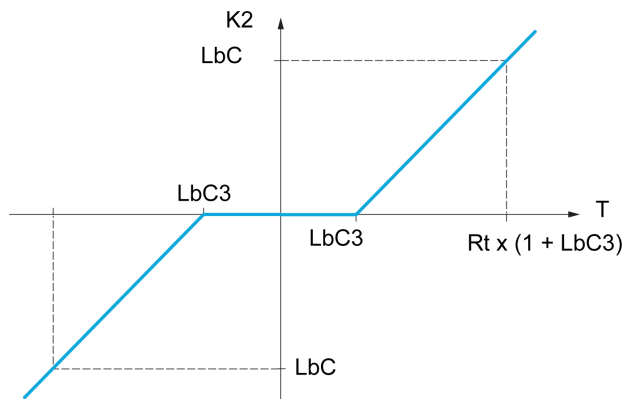
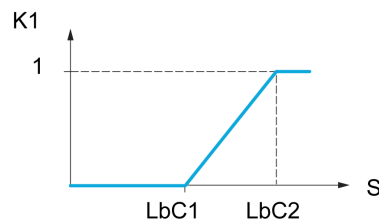

**S** Speed

**T** Torque

**Rt** Rated torque

## [Load sharing] LBA

Load balancing configuration

When 2 motors are connected mechanically and therefore at the same speed, and each is controlled by a drive, this function can be used to improve torque distribution between the two motors. To do this, it varies the speed based on the torque.

**Note:** This function is only compatible with [Motor control type] CTT set to [SVC V] VVC.

This parameter is forced to [No] NO if:

- [PID feedback Assign] PIF is assigned, or
- [Trq/spd switching] TSS is set to [Yes] YES, or
- [Application Selection] APPT is set to [All Applications] ALL or [Hoisting] HOST or [Conveyor] CONV, or
- [M/S Coupling Type] MSMC is set to [Elastic] ELAST and [M/S Device Role] MSDT is set to [Master] MSTER, or
- [M/S Device Role] MSDT is set to [Slave] SLAVE and [M/S Control Type] MSCT is set to [Speed Direct] SPDD or [Speed Reverse] SPDR.

Setting	Code / Value	Description
[No]	NO	Function inactive <b>Factory setting</b>
[Yes]	YES	Function active

### [Load correction] LbC

Nominal speed load balance correction.

This parameter can be accessed if [Load sharing] LBA is set to [Yes] YES.

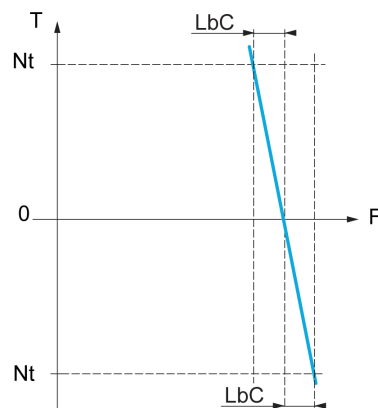

**T** Torque

**t** Nominal torque

**F** Frequency

Setting	Description
0...1000.0 Hz	Setting range <b>Factory setting:</b> 0.0 Hz

### [Correction min spd] LbC1

Low Speed for torque decreasing function speed reference

Minimum speed for load correction in Hz. Below this threshold, no corrections are made. Used to prevent correction at very low speed if this would hamper rotation of the motor.

This parameter can be accessed if [Access Level] LAC is set to [Expert] EPR and if [Load sharing] LBA = [Yes] YES

Setting	Description
0...999.9 Hz	Setting range <b>Factory setting:</b> 0.0 Hz

## [Correction max spd] LBC2

High speed for torque decreasing function speed reference.

Speed threshold in Hz above which maximum load correction is applied.

This parameter can be accessed if **[Access Level]** LAC is set to **[Expert]** EPR and if **[Load sharing]** LBA = **[Yes]** YES

Setting	Description
LBC1 Hz at 1000.0 Hz	Setting range <b>Factory setting:</b> 0 Hz

## [Torque offset] LBC3

Torque offset for torque correction.

Minimum torque for load correction as a % of the rated torque. Below this threshold, no corrections are made. Used to avoid torque instabilities when the torque direction is not constant.

This parameter can be accessed if **[Access Level]** LAC is set to **[Expert]** EPR and if **[Load sharing]** LBA = **[Yes]** YES

Setting	Description
0...300%	Setting range <b>Factory setting:</b> 0%

## [Sharing filter] LBF

Time constant filter.

This parameter can be accessed if **[Load sharing]** LBA = **[Yes]** YES and if **[Access Level]** LAC is set to **[Expert]** EPR. Used in the event of flexible mechanical coupling in order to avoid instabilities.

Setting	Description
100...20000 ms	Setting range <b>Factory setting:</b> 100 ms

## [Rope Slack Handling] SDR- Menu

### Access

[Complete settings] → [Hoisting Functions] → [Rope Slack Handling]

### About This Menu

This menu can be accessed if [High speed hoisting] HSO is not set to [No] NO.

### [Rope slack config.] RSD★

*Rope slack configuration.*

Setting	Code / Value	Description
[No]	NO	Function not active <b>Factory setting</b>
[Weight Estimation]	DRI	Drive motor torque estimation
[Ext Weight Sensor]	PES	Measurement of the load using a weight sensor. It can only be assigned if [Ext Weight Sensor] PES is not set to [Not Configured] NO.

### [Rope slack trq level] RSTL★

Torque level for rope slack detection.

This parameter can be accessed if [Rope slack config.] RSD is not set to [No] NO.

Setting	Description
0...100%	Setting range <b>Factory setting:</b> 0%

## [Hoisting monitoring]

### [Dynamic load detect.] DLD– Menu

#### Access

[Complete settings] → [Hoisting monitoring] → [Dynamic load detect.]

#### About This Menu

This detection is only possible with the high-speed hoisting function. It can be used to detect if an obstacle has been reached, triggering a sudden (upward) increase or (downward) decrease in the load.

Load variation detection triggers a **[Dynamic Load Error] DLF**. The **[Dyn. load Mgt.] DLB** parameter can be used to configure the response of the drive in the event of this detected error.

Load variation detection can also be assigned to a relay or a digital output.

There are two possible detection modes, depending on the configuration of high-speed hoisting:

- Speed reference mode

**[High speed hoisting] HSO** is set to **[Reference Frequency] SSO**.

Torque variation detection.

During high-speed operation, the load is compared to that measured during the speed step. The permissible load variation and its duration can be configured. If exceeded, an error is triggered.

- Current limitation mode

**[High speed hoisting] HSO** is set to **[Current Limit] CSO**. On ascend, during high-speed operation, an increase in load results in a drop in speed. Even if high-speed operation has been activated, if the motor frequency drops below the **[I Limit. frequency] SCL** threshold, an error is triggered. The detection is realized only for a positive variation of the load and only in the high-speed area (area upper to **[I Limit. frequency] SCL**). On descend, operation takes the form of speed reference mode.

### [Dynamic load time] TLD

Activation of load variation detection and adjustment of time delay for taking load variation detected an error **[Dynamic Load Error] DLF** into account.

Setting	Code / Value	Description
[No]	NO	No load variation detection <b>Factory setting</b>
0.00...10.00 s		Adjustment of the time delay for taking detected an error into account.

### [Dyn. load threshold] DLD

Adjustment of the trip threshold for load variation detection, as a % of the load measured during the speed step.



Setting ( )	Description
1...100%	Setting range <b>Factory setting:</b> 100%

## [Dyn. load Mgt.] DLB

Drive response in the event of a load variation detected error.

Setting	Code / Value	Description
[Ignore]	NO	Detected error ignored
[Freewheel Stop]	YES	Freewheel stop <b>Factory setting</b>
[Per STT]	STT	Stop according to [Type of stop] STT parameter but without an error triggered after stop
[Fallback Speed]	LFF	Change to fallback speed, maintained as long as the detected error persists and the run command has not been removed <sup>(1)</sup>
[Speed maintained]	RLS	Speed maintained as long as the detected error persists and the run command has not been removed <sup>(1)</sup>
[Ramp stop]	RMP	Stop on ramp
[Fast stop]	FST	Fast stop
<sup>1</sup> Because, in this case, the detected error does not trigger a stop, it is recommended to assign a relay or logic output to its indication.		

## [Machine Functions]

### [Load Sharing] LDS– Menu

#### Access

[Complete settings] → [Machine Functions] → [Conveyor Functions] →  
[Load Sharing]

#### About This Menu

Identical to [Load Sharing] LDS– menu , page 260

## [Backlash compensation] BSQM- Menu

### Access

[Complete settings] → [Machine Functions] → [Backlash compensation]

### About This Menu

This menu presents:

- The backlash compensation sequence.
- The backlash compensation sequence dedicated to the Master/Slave on rigid coupling.

The purpose of this menu is to provide a dedicated sequence to compensate backlashes in order to reduce the wear gears by limiting the torque at the moment of the impact:

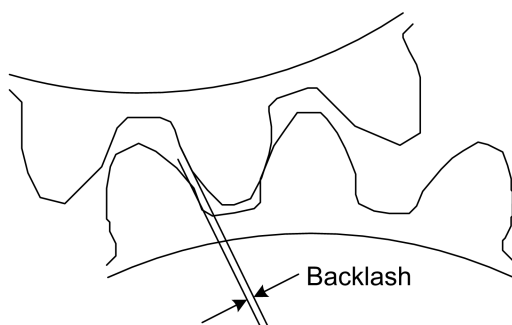

This menu is dedicated to non driving loads (horizontal movement) without brakes. It is available either in torque control or speed control.

### Backlash Sequence

The purpose of the backlash sequence is to regulate speed startup under a torque limitation allowing motion until the backlash is fully compensated. The load torque becomes greater than the torque limitation and stop the movement. Then the run can proceed starting from applied limitation torque.

There are three different use cases:

- Backlash sequence at startup only (UC-1)
- Stop at direction change (UC-2)
- Regulate 0Hz speed at direction change (UC-3)

Those use cases depends on the control mode:

	Torque control	Speed control
Open loop	(UC-1) (UC-2)	(UC-1) (UC-2)
Closed loop	(UC-1) (UC-3)	(UC-1) (UC-3)

#### Backlash sequence at startup only (UC-1)

The backlash sequence is configured only during starts of the drive and become transparent once it is in run:

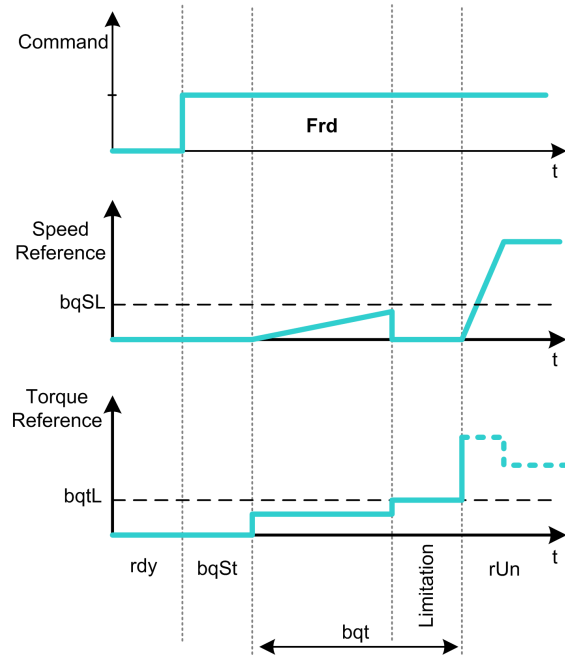

**Stop at direction change (UC-2)**

The drive stops when the direction of the movement changes and the drive starts if the run order is still present. Then do a backlash sequence according to its new direction:

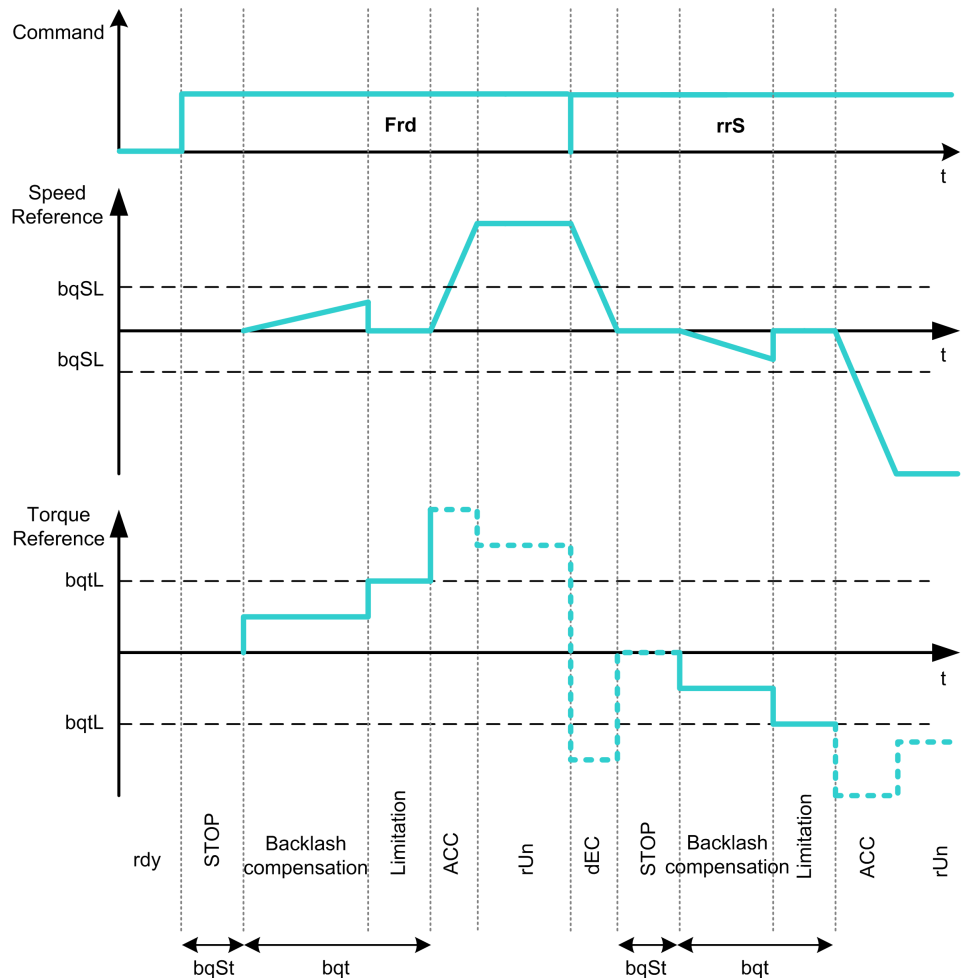

**Regulate 0Hz speed at direction change (UC-3)**

On a changing direction the drive regulates the 0Hz speed and proceed to the backlash sequence according to the new direction of movement to come back in run at the end of the sequence:

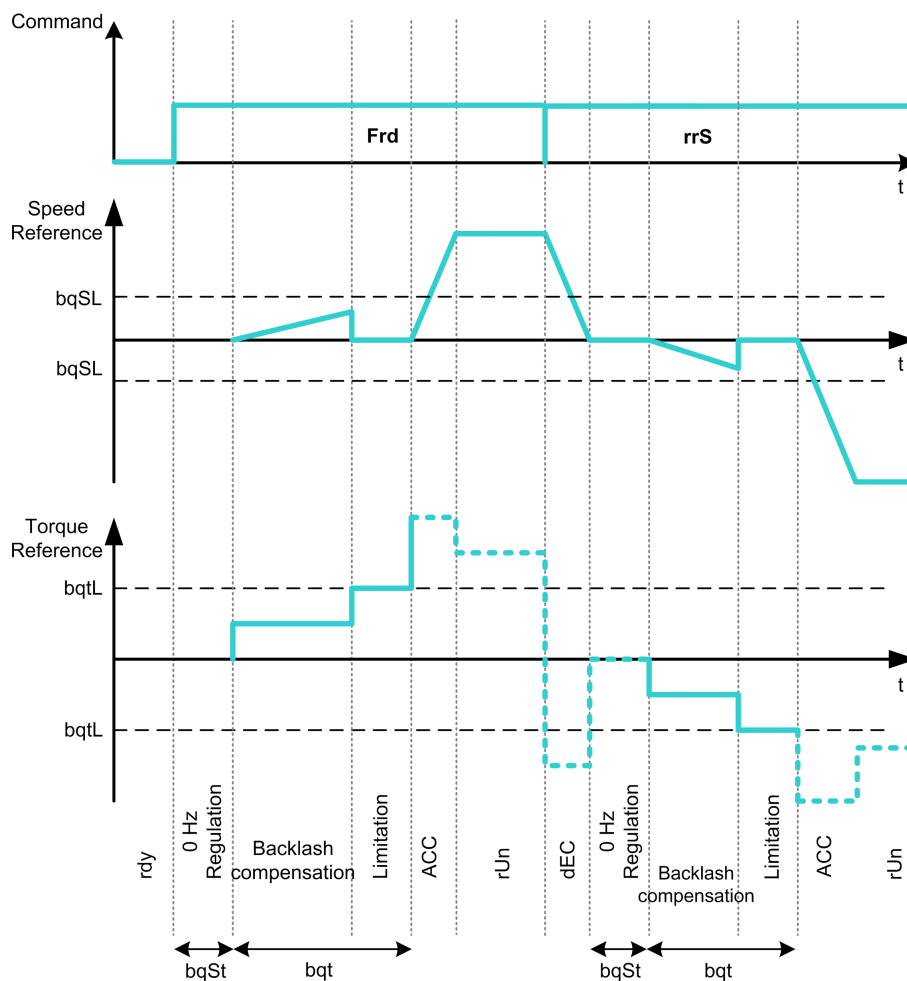

### Backlash Sequence Dedicated to the Master/Slave on Rigid Coupling

The purpose of this menu is to provide backlash compensation dedicated to Master/Slave architectures in a rigid coupling context. The goal is to limit the impact torque on toothed wheels in order to reduce the wear.

There are four different Multiple Drive backlash compensation sequences strategies:

- Direct sequential slave backlash compensation (1)
- Direct simultaneous slave backlash compensation (2)
- Controlled sequential slave backlash compensation (3)
- Controlled simultaneous slave backlash compensation (4)

The following diagram shows how to configure the different compensation sequences strategies:

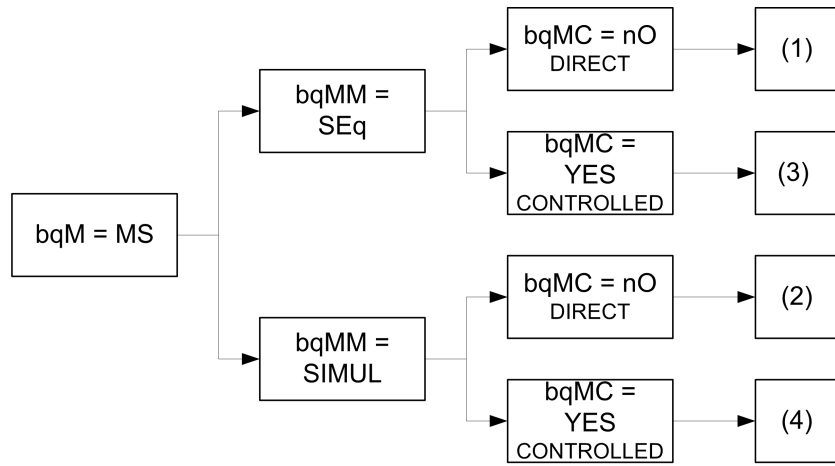

**Direct sequential slave backlash compensation (1)**

Each Slave compensates its backlash by switching in speed control. Doing its sequence one at the time assuming that the settings allow compensating the backlash angle in the configured time. At the end, the master launches its own backlash sequence, meanwhile the Master stays in stop (open loop) or regulating 0Hz speed (closed loop):

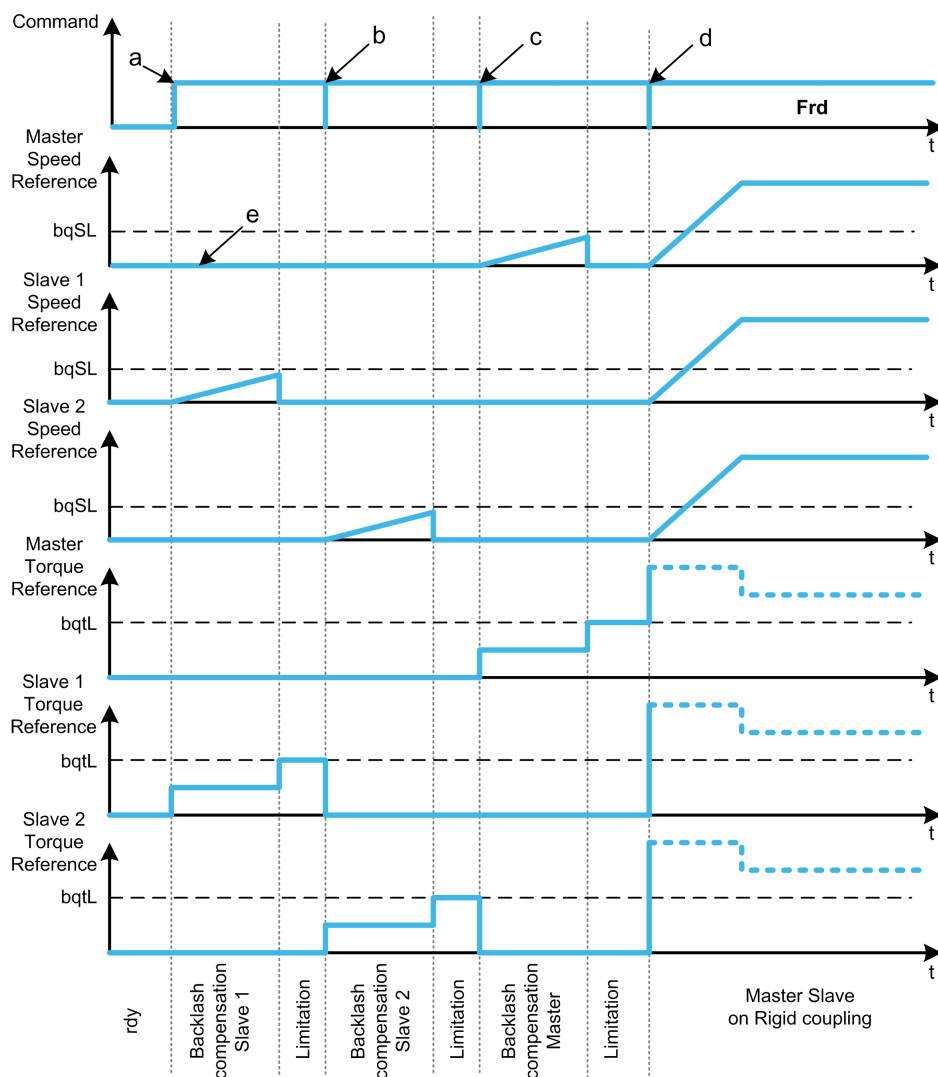

- a** Slave 1 starts
- b** Slave 2 starts, Slave 1 stops
- c** Slave 2 stops
- d** All slaves run start
- e** 0Hz regulation or stop

**Direct simultaneous slave backlash compensation (2)**

All slaves compensates their backlashes angle simultaneously assuming that the tuning allows compensating the backlash angle in the configured time. Meanwhile the Master stays in stop (open loop) or regulating 0Hz speed (closed loop):

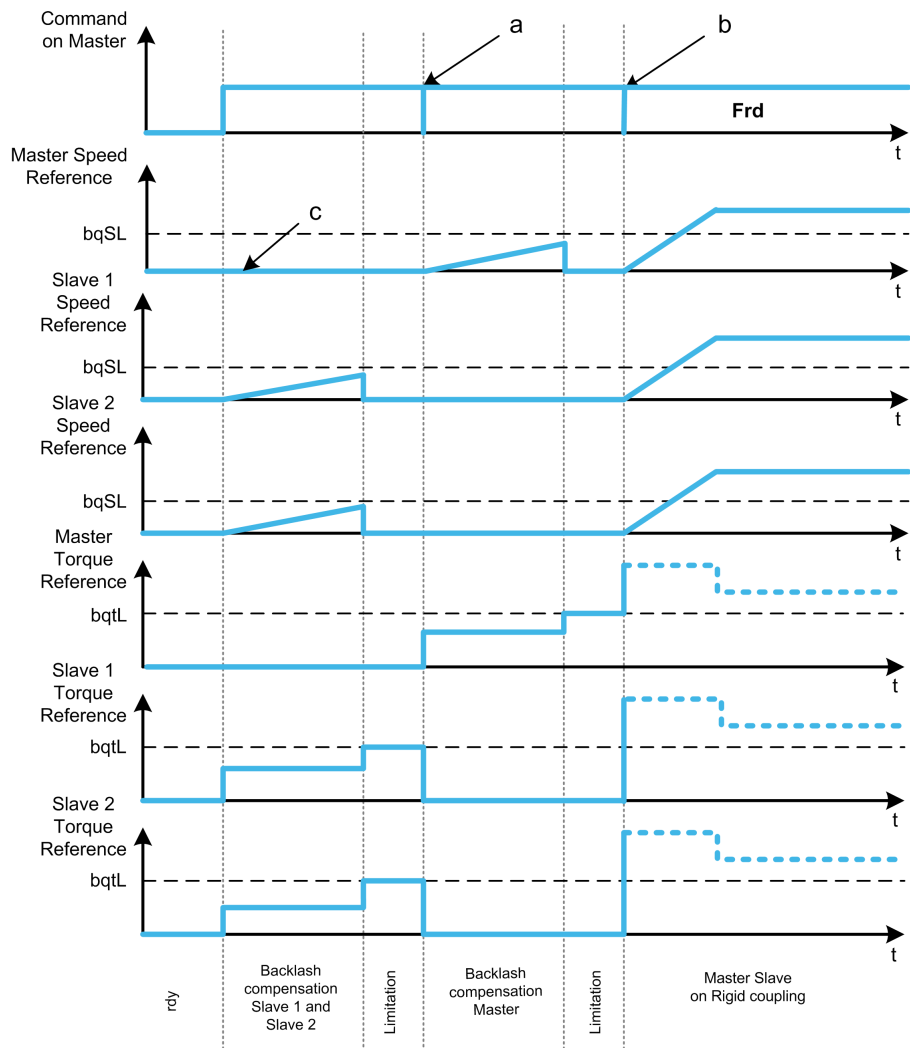

**a** All slaves stop

**b** All slaves start

**c** 0Hz regulation or stop

**Controlled sequential slave backlash compensation (3)**



All Slaves compensates their backlashes angle one at the time. When it is done they notify to the Master. Meanwhile the Master stays in stop (open loop) or regulating 0Hz speed (closed loop). Then starts compensating its backlash and go in run as soon as the last Slave has compensated its backlash:

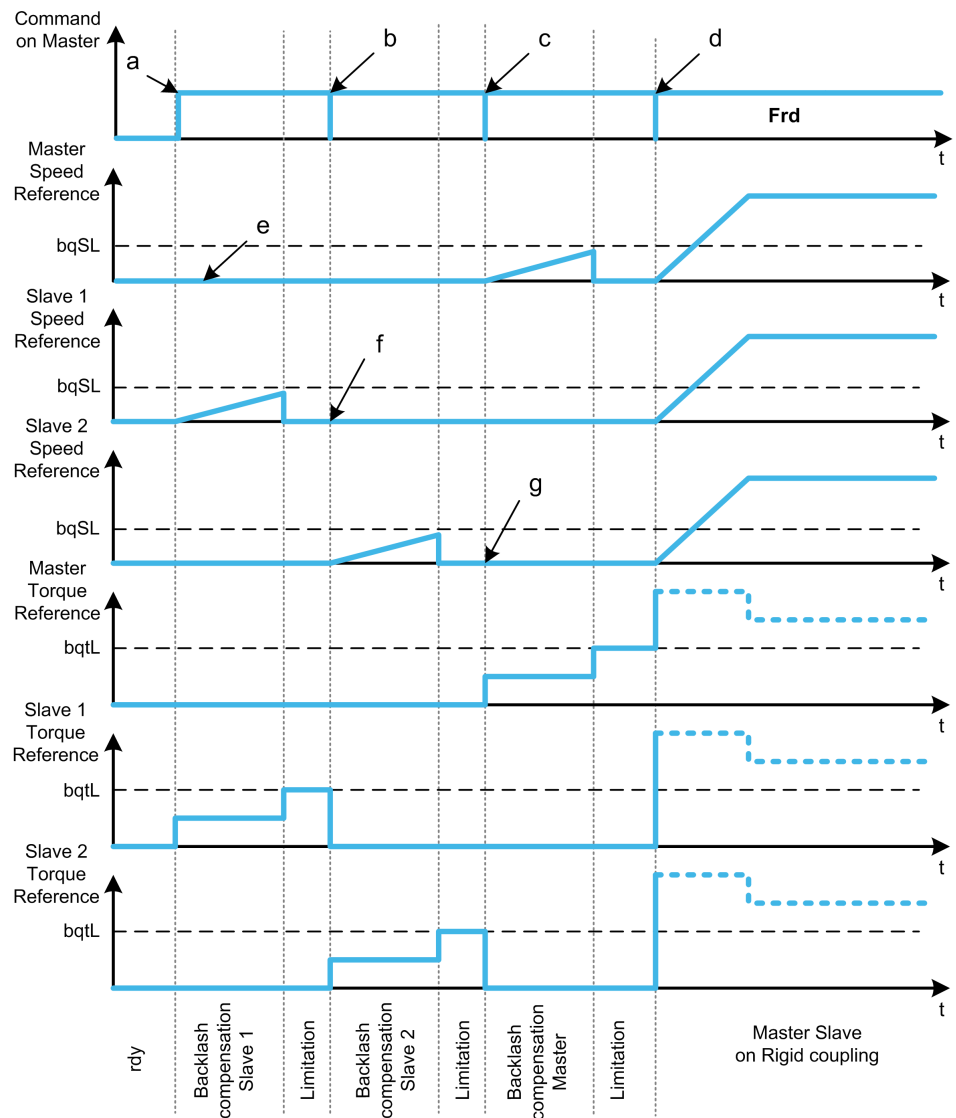

- a** Slave 1 starts
- b** Slave 2 starts, Slave 1 stops
- c** Slave 2 stops
- d** All slaves start
- e** 0Hz regulation or stop
- f** Slave 1 feedback
- g** Slave 2 feedback

**Controlled simultaneous slave backlash compensation (4)**

All Slaves compensates their backlashes angle simultaneously broadcasting to the Master when it is done. Meanwhile the Master drive stays in stop (open loop) or regulating 0Hz speed (closed loop).

Then starts compensating its backlash and go in run as soon as the last Slave has compensated its backlash:

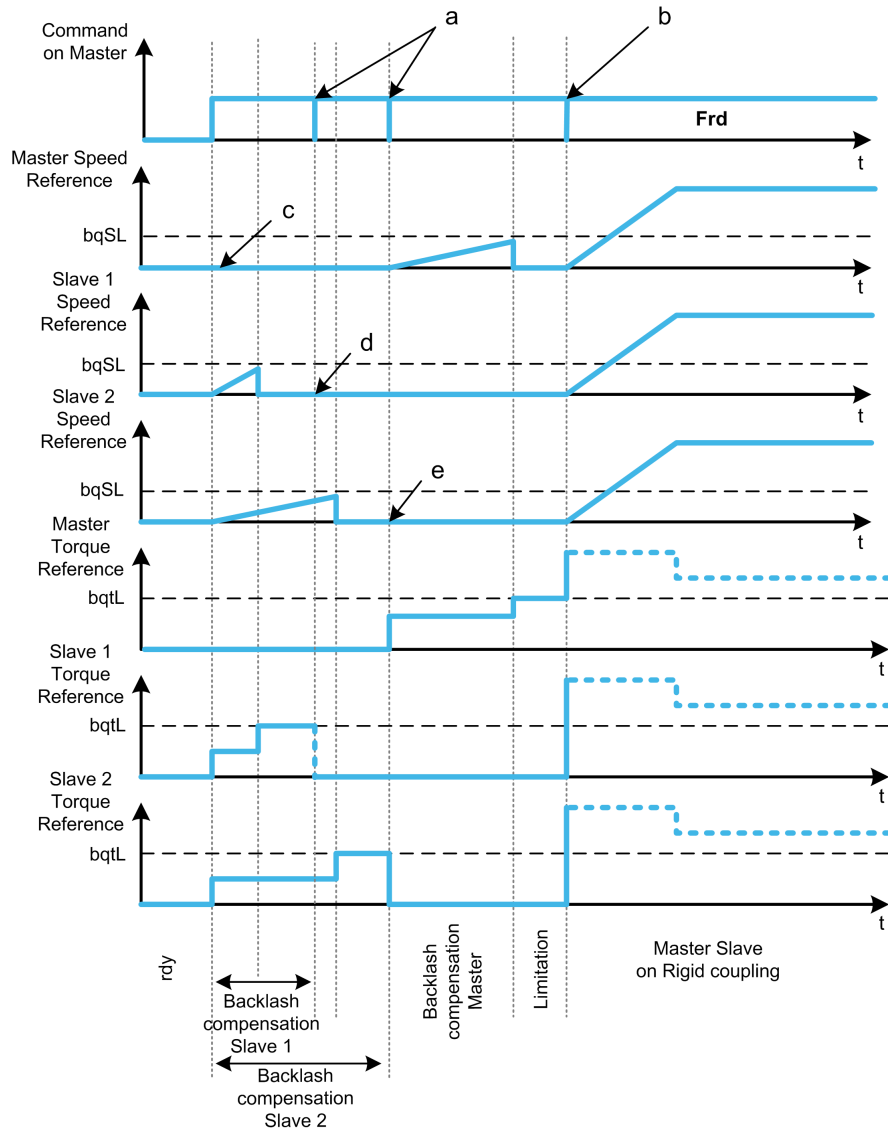

- a Stop orders when feedback is done
- b All slaves start
- c 0Hz regulation or stop
- d Slave 1 feedback
- e Slave 2 feedback

## [BL Mode] BQM

### Backlash mode

Setting	Code / Value	Description
[Not Configured]	NO	Backlash compensation not configured <b>Factory setting</b>
[On Start]	START	Backlash compensation is performed on each Drive start (run order appears or halt disappear)
[On Start + Dir Change]	CHGDIR	Backlash compensation is performed on each Drive start (run order appears or halt disappear) and on each direction change
[On Master Request]	MS	Backlash compensation managed through Master/Slave function.

## [BL Type] BQMM ★

Backlash type.

This parameter can be accessed if:

- **[BL Mode]** BQM is not set to **[Not Configured]** NO, and
- **[M/S Comm Mode]** MSCM is set to **[MultiDrive Link]** MDL, and
- **[M/S Device Role]** MSDT is set to **[Master]** MSTER.

Setting	Code / Value	Description
<b>[Sequential]</b>	SEQ	Each slave does its sequence one by one <b>Factory setting</b>
<b>[Simultaneous]</b>	SIMUL	Backlash compensation is performed on each Drive start (run order appears or halt disappear)

## [BL Slave Fdbck] BQMC ★

Backlash on slave(s) feedback.

This parameter can be accessed if:

- **[BL Mode]** BQM is not set to **[Not Configured]** NO, and
- **[M/S Comm Mode]** MSCM is set to **[MultiDrive Link]** MDL, and
- **[M/S Device Role]** MSDT is set to **[Master]** MSTER, and
- **[Access Level]** LAC is set to **[Expert]** EPR.

Setting	Code / Value	Description
<b>[No]</b>	NO	Master does not take into account the slaves feedback
<b>[Yes]</b>	YES	Master takes into account the slaves feedback <b>Factory setting</b>

## [BL Time] BQMT ★

Backlash time.

This parameter can be accessed if:

- **[BL Mode]** BQM is not set to **[Not Configured]** NO, and
- **[M/S Comm Mode]** MSCM is set to **[MultiDrive Link]** MDL, and
- **[M/S Device Role]** MSDT is set to **[Master]** MSTER, and
- **[Access Level]** LAC is set to **[Expert]** EPR.
- **[BL Slave Fdbck]** BQMC is set to **[No]** NO.

Setting 	Description
0.1...100.0 s	Setting range <b>Factory setting:</b> 0.5 s

## [BL Ref Freq] BQSL ★

Backlash reference frequency.

This parameter can be accessed if **[BL Mode]** BQM is not set to **[Not Configured]** NO.

Setting 	Description
0.0...599.0 Hz	Setting range <b>Factory setting:</b> 1% of [Nominal Motor Freq] <i>FRS</i> or [Sync Nominal Freq] <i>FRSS</i> depending on [Motor control type] <i>CTT</i> .

## [BL Acceleration] *BQA* ★

Backlash Acceleration ramp value.

This parameter can be accessed if [BL Mode] *BQM* is not set to [Not Configured] *NO*.

Setting 	Description
0.01...999.90 s <sup>(1)</sup>	Setting range <b>Factory setting:</b> 10.00 s
<b>(1)</b> Range 0.01 to 99.99 s or 0.1 to 999.9 s or 1 to 9,999 according to [Ramp increment] <i>INR</i>	

## [BL Trq Lim Value] *BQTL* ★

Backlash torque limitation value.

This parameter can be accessed if [BL Mode] *BQM* is not set to [Not Configured] *NO*.

Setting 	Description
0.0...100.0%	Setting range <b>Factory setting:</b> 5.0%

## [BL Monit Delay] *BQT* ★

Backlash torque limitation monitoring delay.

Delay from beginning of backlash speed ramp and check of torque limitation.

This parameter can be accessed if [BL Mode] *BQM* is not set to [Not Configured] *NO*.

Setting 	Description
0.1...100.0 s	Setting range <b>Factory setting:</b> 0.5 s

**NOTE:** To adjust this parameter, the time needed by Angle test function must be considered.

## [BL Start Delay] *BQST* ★

Backlash start delay.

Time spent in stop or standstill before backlash sequence.

This parameter can be accessed if [BL Mode] *BQM* is not set to [Not Configured] *NO*.

Setting 	Description
0.0...100.0 s	Setting range <b>Factory setting:</b> 0.0 s

**[BL Timeout] BQFD ★**

Backlash timeout.

This parameter can be accessed if **[BL Mode] BQM** is not set to **[Not Configured] NO**.

Setting 	Description
0.0...100.0 s	Setting range <b>Factory setting:</b> 5.0 s ( <b>[BL Monit Delay] BQT</b> x10)

**[BL ErrorResp] BQFB ★**

Backlash compensation error response.

This parameter can be accessed if **[BL Mode] BQM** is not set to **[Not Configured] NO**.

Setting	Code / Value	Description
<b>[Ignore]</b>	NO	Detected error ignored
<b>[Freewheel Stop]</b>	YES	Freewheel stop <b>Factory setting</b>

## [Positioning by sensors] LPO– Menu

### Access

[Complete settings] → [Machine Functions] → [Positioning by sensors]

### About This Menu

Identical to [Positioning by sensors] LPO– menu , page 359

## [Brake logic control] BLC– Menu

### Access

[Complete settings] → [Machine Functions] → [Brake logic control]

### About This Menu

Identical to [Brake logic control] BLC– menu

## [Torque control] TOR– Menu

### Access

[Complete settings] → [Machine Functions] → [Torque control]

### About This Menu

Identical to [Torque control] TOR– menu , page 368

## [Generic functions] - [Speed Limits]

### [Speed Limits] SLM- Menu

#### Access

[Complete settings] → [Generic functions] → [Speed Limits]

#### [Low Speed] LSP

Motor frequency at low speed.

Setting ( )	Description
0.0...599.0 Hz	Setting range <b>Factory setting:</b> 0 Hz

#### [High Speed] HSP

Motor frequency at high speed.

To help prevent **[Motor Overspeed] SOF** error, it is recommended to have **[Max Frequency] TFR** equal to or higher than 110% of **[High Speed] HSP**.

Setting ( )	Description
0.0...599.0 Hz	Setting range <b>Factory setting:</b> 50.0 Hz

#### [Ref Freq template] BSP

Low speed management (template).

This parameter defines how the speed reference is taken into account, for analog inputs and pulse input only. In the case of the PID controller, this is the PID output reference.

The limits are set by the **[Low Speed] LSP** and **[High Speed] HSP** parameters.

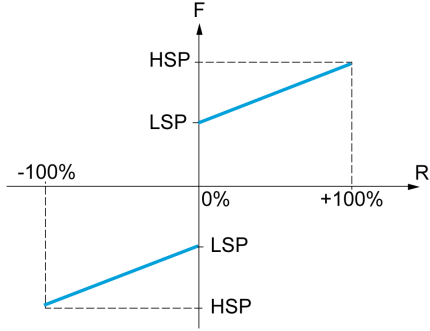
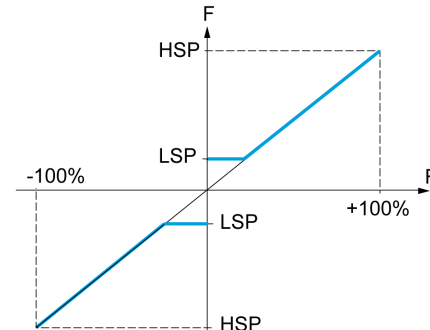
Setting ( )	Code / Value	Description
[Standard]	BSD	 <p>F Frequency</p> <p>R Reference</p> <p>At reference = 0, the frequency = [Low Speed] LSP</p> <p><b>Factory setting</b></p>
[Pedestal]	BLS	 <p>F Frequency</p> <p>R Reference</p> <p>At reference = 0 to [Low Speed] LSP, the frequency = [Low Speed] LSP</p>

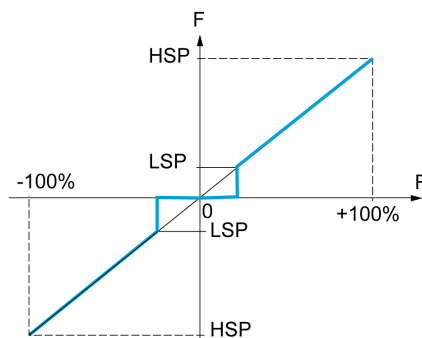
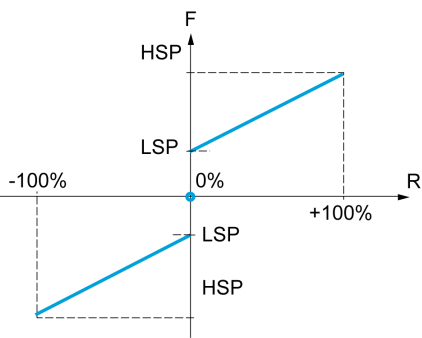

Setting ( )	Code / Value	Description
<b>[Deadband]</b>	BNS	 <p><b>F</b> Frequency</p> <p><b>R</b> Reference At reference = 0 to <b>LSP</b> the frequency = 0</p>
<b>[Deadband at 0%]</b>	BNS0	 <p><b>F</b> Frequency</p> <p><b>R</b> Reference This operation is the same as <b>[Standard] BSD</b>, except that in the following cases at zero reference, the frequency = 0: The signal is less than <b>[Min value]</b>, which is greater than 0 (example: 1 Vdc on a 2-10 Vdc input). The signal is greater than <b>[Min value]</b>, which is greater than <b>[Max value]</b> (example: 11 Vdc on a 10-0 Vdc input).</p> <p>If the input range is configured as "bidirectional", the operation remains identical to <b>[Standard] BSD</b>.</p>

## [Generic functions] - [Ramp]

### [Ramp] RAMP– Menu

#### Access

[Complete settings] → [Generic functions] → [Ramp]

#### [Ramp Type] RPT

*Type of ramp.*

Setting	Code / Value	Description
[Linear]	LIN	Linear ramp <b>Factory setting</b>
[S-Ramp]	S	S ramp
[U-Ramp]	U	U ramp
[Customized]	CUS	Customer ramp

#### [Ramp increment] INR

This parameter is valid for [Acceleration] ACC, [Deceleration] DEC, [Acceleration 2] AC2 and [Deceleration 2] DE2.

Setting (°)	Code / Value	Description
[0.01]	001	Ramp up to 99.99 seconds
[0.1]	01	Ramp up to 999.9 seconds <b>Factory setting</b>
[1]	1	Ramp up to 6,000 seconds

#### [Acceleration] ACC

Time to accelerate from 0 to the [Nominal Motor Freq] FRS.

To have repeatability in ramps, the value of this parameter must be set according to the possibility of the application (for example, the inertia must be considered).

Setting (°)	Description
0.00...6,000.00 s <sup>(1)</sup>	Setting range <b>Factory setting:</b> 3.00 s
<sup>(1)</sup> Range 0.01 to 99.99 s or 0.1 to 999.9 s or 1 to 6,000 according to [Ramp increment] INR	

#### [Deceleration] DEC

Time to decelerate from the [Nominal Motor Freq] FRS to 0.

To have repeatability in ramps, the value of this parameter must be set according to the possibility of the application (for example, the inertia must be considered).

Setting ( )	Description
0.00...6,000.00 s <sup>(1)</sup>	Setting range Factory setting: 3.00 s
(1) Range 0.01 to 99.99 s or 0.1 to 999.9 s or 1 to 6,000 according to [Ramp increment] INR	

### [Begin Acc round] TA1 ★

Rounding of start of acceleration ramp as a percentage of the [Acceleration] ACC or [Acceleration 2] AC2 ramp time.

This parameter can be accessed if the [Ramp Type] RPT is set to [Customized] CUS.

Setting ( )	Description
0...100%	Setting range Factory setting: 10%

### [End Acc round] TA2 ★

Rounding of end of acceleration ramp as a percentage of the [Acceleration] ACC or [Acceleration 2] AC2 ramp time.

This parameter can be accessed if the [Ramp Type] RPT is set to [Customized] CUS.

Setting ( )	Description
0...(100 - [Begin Acc round] TA1) %	Setting range Factory setting: 10%

### [Begin Dec round] TA3 ★

Rounding of start of deceleration ramp as a percentage of the [Deceleration] DEC or [Deceleration 2] DE2 ramp time.

This parameter can be accessed if the [Ramp Type] RPT is set to [Customized] CUS.

Setting ( )	Description
0...100%	Setting range Factory setting: 10%

### [End Dec round] TA4 ★

Rounding of end of deceleration ramp as a percentage of the [Deceleration] DEC or [Deceleration 2] DE2 ramp time.

Can be set between 0 and (100% - [Begin Dec round] TA3).

This parameter can be accessed if the [Ramp Type] RPT is set to [Customized] CUS.

Setting ( )	Description
0...(100 - [Begin Dec round] TA3) %	Setting range Factory setting: 10%

## [Dec.Ramp Adapt] BRA

Deceleration ramp adaptation.

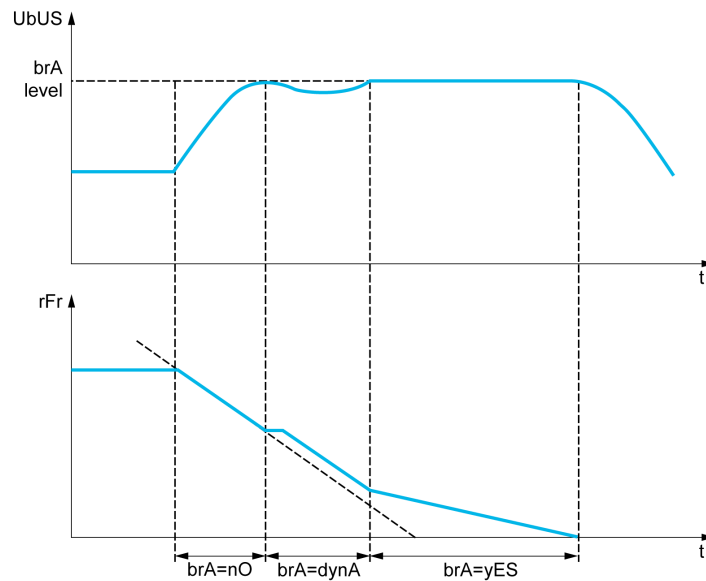

Activating this function automatically adapts the deceleration ramp, if this has been set at a too low value according to the inertia of the load, which can cause an overvoltage detected error.

The function is incompatible with applications requiring:

- Positioning on a ramp

Setting	Code / Value	Description
[No]	NO	Function inactive. <b>NOTE:</b> [Dec.Ramp Adapt] BRA if forced to [No] NO if: <ul style="list-style-type: none"> <li>• [Brake assignment] BLC is configured, or</li> <li>• [Braking balance] BBA is set to [Yes] YES, or</li> <li>• [Motor control type] CTT is set to [Reluctance Motor] SRVC and [Dec.Ramp Adapt] BRA was set to [High Torque] DYNA.</li> </ul>
[Yes]	YES	Function active, for applications that do not require strong deceleration <b>Factory setting</b>
[High Torque]	DYNA	Addition of a constant current flow component.  The [High Torque] DYNA selection appears depending on the rating of the drive and [Motor control type] CTT. It enables stronger deceleration to be obtained than with [Yes] YES. Use comparative testing to determine your selection.  When [Dec.Ramp Adapt] BRA is configured on [High Torque] DYNA, the dynamic performances for braking are improved by the addition of a current flow component. The aim is to increase the iron loss and magnetic energy stored in the motor.

## [Braking balance] BBA

This parameter is used to balance the braking power between drives linked through the DC bus.

This parameter is forced to [No] NO if [Dec.Ramp Adapt] BRA is set to a value different from [No] NO.

Setting 	Code / Value	Description
[No]	NO	Function inactive. <b>Factory setting</b>
[Yes]	YES	Function active.

## [Braking Resistor] BRC

Braking resistor connected.

This parameter allows to enable the management of the braking resistor.

**NOTE:** The factory setting value of the parameter is changed to [Yes] YES if [Brake assignment] BLC is configured.

Setting	Code / Value	Description
[No]	NO	Function inactive <b>Factory setting</b> <b>NOTE:</b> With this selection [DB unit op. circuit] BUFO error can't be triggered.
[Yes]	YES	Function active

## [Braking Current Level] BDCI

Maximum braking current level.

This parameter modifies the maximum current level that can be reached during the adaptation of the braking deceleration. Increasing the maximum value increases the motor current loss via iron loss and magnetic energy stored in the motor.

It is expressed in % of nominal magnetizing current ([Magnetizing Current] IDA).

This parameter can be accessed if:

- [Access Level] LAC is set to [Expert] EPR, and
- [Dec.Ramp Adapt] BRA is set to [High Torque] DYNA.

Setting	Code / Value	Description
[Auto]	AUTO	Automatic: it corresponds to 125 %. <b>Factory setting.</b>
0.1...500.0%		Settings range.

## [Generic functions] - [Ramp switching]

### [Ramp switching] RPT– Menu

#### Access

[Complete settings] → [Generic functions] → [Ramp switching]

#### [Ramp 2 Thd] FRT

Ramp 2 frequency threshold

The second ramp is switched if the value of [Ramp 2 Thd] FRT is not 0 (0 deactivates the function) and the output frequency is greater than [Ramp 2 Thd] FRT.

Threshold ramp switching can be combined with [Ramp Switch Assign] RPS switching as follows:

DI or Bit	Frequency	Ramp
0	< FRT	ACC, DEC
0	> FRT	AC2, DE2
1	< FRT	AC2, DE2
1	> FRT	AC2, DE2

Setting ( )	Description
0.0...599.0 Hz	Setting range <b>Factory setting:</b> 0.0 Hz

#### [Ramp Switch Assign] RPS

*Ramp switching assignment .*

Value range	Code / Value	Description
[Not Assigned]	NO	Not assigned <b>Factory setting</b>
[DI1]...[DI8]	LI1...LI8	Digital input DI1...DI8 <b>NOTE:</b> DI8 selection can be accessed on drives with a power greater than 22kW.
[DI11]...[DI16]	LI11...LI16	Digital input DI11...DI16 if VW3A3203 I/O extension module has been inserted
[CD00]... [CD10]	CD00...CD10	Virtual digital input CMD.0...CMD.10 in [I/O profile] IO configuration
[CD11]... [CD15]	CD11...CD15	Virtual digital input CMD.11...CMD.15 regardless of configuration
[C101]... [C110]	C101...C110	Virtual digital input CMD1.01...CMD1.10 with integrated Modbus Serial in [I/O profile] IO configuration
[C111]... [C115]	C111...C115	Virtual digital input CMD1.11...CMD1.15 with integrated Modbus Serial regardless of configuration
[C201]... [C210]	C201...C210	Virtual digital input CMD2.01...CMD2.10 with CANopen® fieldbus module in [I/O profile] IO configuration
[C211]... [C215]	C211...C215	Virtual digital input CMD2.11...CMD2.15 with CANopen® fieldbus module regardless of configuration

Value range	Code / Value	Description
[C301]... [C310]	C301...C310	Virtual digital input CMD3.01...CMD3.10 with a fieldbus module in <b>[I/O profile]</b> IO configuration
[C311]... [C315]	C311...C315	Virtual digital input CMD3.11...CMD3.15 with a fieldbus module regardless of configuration
[C501]... [C510]	C501...C510	Virtual digital input CMD5.01...CMD5.10 with integrated Ethernet in <b>[I/O profile]</b> IO configuration <b>NOTE:</b> This selection can be accessed on ATV340...N4E drives.
[C511]... [C515]	C511...C515	Virtual digital input CMD5.11...CMD5.15 with integrated Ethernet regardless of configuration <b>NOTE:</b> This selection can be accessed on ATV340...N4E drives.

## [Acceleration 2] AC2 ★

Acceleration 2 ramp time.

Time to accelerate from 0 to the **[Nominal Motor Freq]** FRS. To have repeatability in ramps, the value of this parameter must be set according to the possibility of the application.

This parameter can be accessed if **[Ramp 2 Thd]** FRT is greater than 0 or if **[Ramp Switch Assign]** RPS is assigned.

Setting ( )	Description
0.0...6,000 s <sup>(1)</sup>	Setting range <b>Factory setting:</b> 5.0 s
(1) Range 0.01 to 99.99 s or 0.1 to 999.9 s or 1...6,000 s according to <b>[Ramp increment]</b> INR.	

## [Deceleration 2] DE2 ★

Time to decelerate from the **[Nominal Motor Freq]** FRS to 0. To have repeatability in ramps, the value of this parameter must be set according to the possibility of the application.

This parameter can be accessed if:

- **[Ramp 2 Thd]** FRT is greater than 0, or
- **[Ramp Switch Assign]** RPS is assigned.

Setting ( )	Description
0.0...6,000 s <sup>(1)</sup>	Setting range <b>Factory setting:</b> 5.0 s
(1) Range 0.01 to 99.99 s or 0.1 to 999.9 s or 1...6,000 s according to <b>[Ramp increment]</b> INR.	

## [Generic functions] - [Stop configuration]

### [Stop configuration] STT– Menu

#### Access

[Complete settings] → [Generic functions] → [Stop configuration]

#### About This Menu

**NOTE:** This function cannot be used with some other functions.

#### [Type of stop] STT

Normal stop mode.

Stop mode on disappearance of the run command or appearance of a stop command.

The setting of this parameter is not taken into account when the active command channel is set to a communication channel and **[Control Mode] CHCF** is not set to **[I/O profile] IO**. In this case, the stop mode is defined by the parameter **[SwitchOnDisable Stp] DOTD**, page 293.

Setting	Code / Value	Description
[On Ramp]	RMP	Stop on ramp, if <b>[Brake assignment] BLC</b> or <b>[Low Speed Timeout] TLS</b> are configured, or if <b>[Motor fluxing] FLU</b> is set to <b>[Continuous] FCT</b> only a <b>[On Ramp] RMP</b> is possible. <b>Factory setting</b>
[Fast stop]	FST	Fast stop
[Freewheel Stop]	NST	Freewheel stop
[DC injection]	DCI	DC injection stop. Available if <b>[Motor control type] CTT</b> is not set to: <ul style="list-style-type: none"> <li>• <b>[Sync. mot.] SYN</b>, or</li> <li>• <b>[Sync.CL] FSY</b>, or</li> <li>• <b>[SYN_U VC] SYNU</b>, or</li> <li>• <b>[Reluctance Motor] SRVC</b></li> </ul>

#### [Freewheel Stop] NST

The stop is activated when the input or the bit changes to 0. If the input returns to state 1 and the run command is still active, the motor only restarts if **[2/3-Wire Control] TCC** is set to **[2-Wire Control] 2C** and if **[2-wire type] TCT** is set to **[Level] LEL** or **[Level With Fwd Priority] PFO**. If not, a new run command must be sent.

Setting	Code / Value	Description
[Not Assigned]	NO	Not assigned <b>Factory setting</b>
[CD00]... [CD10]	CD00...CD10	Virtual digital input CMD.0...CMD.10 in <b>[I/O profile] IO</b> configuration
[CD11]... [CD15]	CD11...CD15	Virtual digital input CMD.11...CMD.15 regardless of configuration



Setting	Code / Value	Description
[C101]... [C110]	C101...C110	Virtual digital input CMD1.01...CMD1.10 with integrated Modbus Serial in [I/O profile] IO configuration
[C111]... [C115]	C111...C115	Virtual digital input CMD1.11...CMD1.15 with integrated Modbus Serial regardless of configuration
[C201]... [C210]	C201...C210	Virtual digital input CMD2.01...CMD2.10 with CANopen® fieldbus module in [I/O profile] IO configuration
[C211]... [C215]	C211...C215	Virtual digital input CMD2.11...CMD2.15 with CANopen® fieldbus module regardless of configuration
[C301]... [C310]	C301...C310	Virtual digital input CMD3.01...CMD3.10 with a fieldbus module in [I/O profile] IO configuration
[C311]... [C315]	C311...C315	Virtual digital input CMD3.11...CMD3.15 with a fieldbus module regardless of configuration
[C501]... [C510]	C501...C510	Virtual digital input CMD5.01...CMD5.10 with integrated Ethernet in [I/O profile] IO configuration  <b>NOTE:</b> This selection can be accessed on ATV340...N4E drives.
[C511]... [C515]	C511...C515	Virtual digital input CMD5.11...CMD5.15 with integrated Ethernet regardless of configuration  <b>NOTE:</b> This selection can be accessed on ATV340...N4E drives.
[DI1 (Low level)]...[DI8 (Low level)]	L1L...L8L	Digital input DI1...DI8 used at low level  <b>NOTE:</b> DI8 low level selection can be accessed on drives with a power greater than 22kW.
[DI11 (Low level)]...[DI16 (Low level)]	L11L...L16L	Digital input DI11...DI16 used at low level if VW3A3203 I/O extension module has been inserted

### [Freewheel stop Thd] FFT ★

Freewheel stop threshold.

Speed threshold below which the motor switches to freewheel stop.

This parameter supports switching from a ramp stop or a fast stop to a freewheel stop below a low speed threshold.

This parameter can be accessed if:

- [Type of stop] STT is set to [Fast stop] FST or [On Ramp] RMP, and
- [Auto DC Injection] ADC is configured, and.
- [Brake assignment] BLC is not configured.

Setting ( )	Description
0.2...599.0 Hz	Setting range  <b>Factory setting:</b> 0.2 Hz

### [Fast Stop Assign] FST

The stop is activated when the input changes to 0 or the bit changes to 1 (bit in [I/O profile] IO at 0).

If the input returns to state 1 and the run command is still active, the motor only restarts if [2/3-Wire Control] TCC is set to [2-Wire Control] 2C and if [2-wire type] TCT is set to [Level] LEL or [Level With Fwd Priority] PFO.

If not, a new run command must be sent.

**NOTE:** This function cannot be used with some other functions.

Setting	Code / Value	Description
[Not Assigned]	NO	Not assigned <b>Factory setting</b>
[CD00]... [CD10]	CD00...CD10	Virtual digital input CMD.0...CMD.10 in [I/O profile] IO configuration
[CD11]... [CD15]	CD11...CD15	Virtual digital input CMD.11...CMD.15 regardless of configuration
[C101]... [C110]	C101...C110	Virtual digital input CMD1.01...CMD1.10 with integrated Modbus Serial in [I/O profile] IO configuration
[C111]... [C115]	C111...C115	Virtual digital input CMD1.11...CMD1.15 with integrated Modbus Serial regardless of configuration
[C201]... [C210]	C201...C210	Virtual digital input CMD2.01...CMD2.10 with CANopen® fieldbus module in [I/O profile] IO configuration
[C211]... [C215]	C211...C215	Virtual digital input CMD2.11...CMD2.15 with CANopen® fieldbus module regardless of configuration
[C301]... [C310]	C301...C310	Virtual digital input CMD3.01...CMD3.10 with a fieldbus module in [I/O profile] IO configuration
[C311]... [C315]	C311...C315	Virtual digital input CMD3.11...CMD3.15 with a fieldbus module regardless of configuration
[C501]... [C510]	C501...C510	Virtual digital input CMD5.01...CMD5.10 with integrated Ethernet in [I/O profile] IO configuration <b>NOTE:</b> This selection can be accessed on ATV340***N4E drives.
[C511]... [C515]	C511...C515	Virtual digital input CMD5.11...CMD5.15 with integrated Ethernet regardless of configuration <b>NOTE:</b> This selection can be accessed on ATV340***N4E drives.
[DI1 (Low level)]... [DI8 (Low level)]	L1L...L8L	Digital input DI1...DI8 used at low level <b>NOTE:</b> DI8 low level selection can be accessed on drives with a power greater than 22kW.
[DI11 (Low level)]... [DI16 (Low level)]	L11L...L16L	Digital input DI11...DI16 used at low level if VW3A3203 I/O extension module has been inserted

## [Ramp Divider] DCF ★

Fast Stop deceleration ramp reduction coefficient.

The ramp that is enabled ([Deceleration] DEC or [Deceleration 2] DE2) is then divided by this coefficient when stop requests are sent.

Value 0 corresponds to a minimum ramp time.

Setting ( )	Description
0...10	Setting range <b>Factory setting:</b> 4

## [DC Injection Assign] DCI

*DC injection assignment.*

**▲ WARNING**

**UNINTENDED MOVEMENT**

- Do not use DC injection to generate holding torque when the motor is at a standstill.
- Use a holding brake to keep the motor in the standstill position.

**Failure to follow these instructions can result in death, serious injury, or equipment damage.**

This parameter can be accessed if:

- [Brake assignment] **BLC** is set to [No] **NO**, or
- [Motor control type] **CTT** is not set to [Sync. mot.] **SYN** or [Sync.CL] **FSY** or [Reluctance Motor] **SRVC** or [SYN\_U VC] **SYNU**.

DC injection braking is initiated when the assigned input or bit changes to state 1.

If the input returns to state 0 and the run command is still active, the motor only restarts if [2/3-Wire Control] **TCC** is set to [2-Wire Control] **2C** and if [2-wire type] **TCT** is set to [Level] **LEL** or [Level With Fwd Priority] **PFO**. If not, a new run command must be sent.

**NOTE:** This function cannot be used with some other functions.

Value range	Code / Value	Description
[Not Assigned]	NO	Not assigned <b>Factory setting</b>
[DI1]...[DI8]	LI1...LI8	Digital input DI1...DI8 <b>NOTE:</b> DI8 selection can be accessed on drives with a power greater than 22kW.
[DI11]...[DI16]	LI11...LI16	Digital input DI11...DI16 if VW3A3203 I/O extension module has been inserted
[CD00]... [CD10]	CD00...CD10	Virtual digital input CMD.0...CMD.10 in [I/O profile] <b>IO</b> configuration
[CD11]... [CD15]	CD11...CD15	Virtual digital input CMD.11...CMD.15 regardless of configuration
[C101]... [C110]	C101...C110	Virtual digital input CMD1.01...CMD1.10 with integrated Modbus Serial in [I/O profile] <b>IO</b> configuration
[C111]... [C115]	C111...C115	Virtual digital input CMD1.11...CMD1.15 with integrated Modbus Serial regardless of configuration
[C201]... [C210]	C201...C210	Virtual digital input CMD2.01...CMD2.10 with CANopen® fieldbus module in [I/O profile] <b>IO</b> configuration
[C211]... [C215]	C211...C215	Virtual digital input CMD2.11...CMD2.15 with CANopen® fieldbus module regardless of configuration
[C301]... [C310]	C301...C310	Virtual digital input CMD3.01...CMD3.10 with a fieldbus module in [I/O profile] <b>IO</b> configuration
[C311]... [C315]	C311...C315	Virtual digital input CMD3.11...CMD3.15 with a fieldbus module regardless of configuration
[C501]... [C510]	C501...C510	Virtual digital input CMD5.01...CMD5.10 with integrated Ethernet in [I/O profile] <b>IO</b> configuration <b>NOTE:</b> This selection can be accessed on ATV340...N4E drives.
[C511]... [C515]	C511...C515	Virtual digital input CMD5.11...CMD5.15 with integrated Ethernet regardless of configuration <b>NOTE:</b> This selection can be accessed on ATV340...N4E drives.

[DC Inj Level 1] IDC ★

**DC injection level 1.**

**NOTICE****OVERHEATING**

Verify that the connected motor is properly rated for the DC injection current to be applied in terms of amount and time.

**Failure to follow these instructions can result in equipment damage.**

Level of DC injection braking current activated via digital input or selected as stop mode.

This parameter can be accessed if:

- [Type of stop] **STT** is set to [DC Injection Assign] **DCI**, or
- [DC Injection Assign] **DCI** is not set to [Not Assigned] **NO**.

Setting ( )	Description
0.1...1.41 In <sup>(1)</sup>	Setting range This setting is independent of the [Auto DC injection] <b>ADC-</b> function. <b>Factory setting:</b> 0.7 In <sup>(1)</sup>
<b>(1)</b> In corresponds to the rated drive current indicated in the Installation Manual and on the drive nameplate.	

**[DC Inj Time 1] TDI ★****DC injection time 1.****NOTICE****OVERHEATING**

Verify that the connected motor is properly rated for the DC injection current to be applied in terms of amount and time.

**Failure to follow these instructions can result in equipment damage.**

Maximum current injection time [DC Inj Level 1] **IDC**. After this time, the injection current becomes [DC Inj Level 2] **IDC2**.

This parameter can be accessed if:

- [Type of stop] **STT** is set to [DC Injection Assign] **DCI**, or
- [DC Injection Assign] **DCI** is not set to [Not Assigned] **NO**.

Setting ( )	Description
0.1...30 s	Setting range This setting is independent of the [Auto DC injection] <b>ADC-</b> function. <b>Factory setting:</b> 0.5 s

**[DC Inj Level 2] IDC2 ★****DC injection level 2.**

<b>NOTICE</b>
<p><b>OVERHEATING</b></p> <p>Verify that the connected motor is properly rated for the DC injection current to be applied in terms of amount and time.</p> <p><b>Failure to follow these instructions can result in equipment damage.</b></p>

Injection current activated by digital input or selected as stop mode once period [DC Inj Time 1] TDI has elapsed.

This parameter can be accessed if:

- [Type of stop] STT is set to [DC Injection Assign] DCI, or
- [DC Injection Assign] DCI is not set to [Not Assigned] NO.

Setting ( )	Description
0.1 In <sup>(1)</sup> ...[DC Inj Level 1] IDC	Setting range  This setting is independent of the [Auto DC injection] ADC- function.  <b>Factory setting:</b> 0.5 In <sup>(1)</sup>
(1) In corresponds to the rated drive current indicated in the Installation Manual and on the drive nameplate.	

### [DC Inj Time 2] TDC ★

2nd DC injection time.

<b>NOTICE</b>
<p><b>OVERHEATING</b></p> <p>Verify that the connected motor is properly rated for the DC injection current to be applied in terms of amount and time.</p> <p><b>Failure to follow these instructions can result in equipment damage.</b></p>

Maximum injection time [DC Inj Level 2] IDC2 for injection, selected as stop mode only.

This parameter can be accessed if [Type of stop] STT is set to [DC Injection Assign] DCI.

Setting ( )	Description
0.1...30 s	Setting range  This setting is independent of the [Auto DC injection] ADC- function.  <b>Factory setting:</b> 0.5 s

### [SwitchOnDisable Stp] DOTD

*Type of switchOn Disable Stop.*

Setting	Code / Value	Description
[Freewheel Stop]	NST	The drive stops in freewheel when switching from the operating state Operation enabled to the operating state Switched on.
[Ramp Stop]	RMP	The drive stops on ramp when switching from the operating state Operation enabled to the operating state Switched on. <b>Factory setting</b>

# [Generic functions] - [Auto DC injection]

## [Auto DC injection] ADC- Menu

### Access

[Complete settings] → [Generic functions] → [Auto DC injection]

### About This Menu

This menu presents the automatic injection of motor current function. This is used to hold the rotor of the motor at the end of the deceleration ramp.

**NOTE:** This function cannot be used with some other functions. This function is disabled if [Brake assignment] BLC or [Trq/spd switching] TSS are configured, or [Torque control stop] TST is set to [Spin] SPN.

The following table presents an overview of the [Auto DC injection] ADC function:

ADC	SDC1	SDC2	Description	Operation
YES	x	x	The [Auto DC inj Level 1] SDC1 is injected during [Auto DC Inj Time 1] TDC1 and [Auto DC inj Level 2] SDC2 during [Auto DC Inj Time 2] TDC2 .	
CT	x	≠ 0	The [Auto DC inj Level 1] SDC1 is injected during TDC1 and then [Auto DC inj Level 2] SDC2 is injected.	
CT	x	= 0	Injection of [Auto DC inj Level 1] SDC1	
Run command				
Speed				

## [Auto DC Injection] ADC

*Automatic DC injection.*

**⚠ ⚠ DANGER**

**HAZARD OF ELECTRIC SHOCK, EXPLOSION, OR ARC FLASH**

If the parameter [Auto DC Injection] ADC is set to [Continuous] CT, DC injection is always active, even if the motor does not run.

- Verify that using this setting does not result in unsafe conditions.

**Failure to follow these instructions will result in death or serious injury.**

**⚠ WARNING****UNINTENDED MOVEMENT**

- Do not use DC injection to generate holding torque when the motor is at a standstill.
- Use a holding brake to keep the motor in the standstill position.

**Failure to follow these instructions can result in death, serious injury, or equipment damage.**

Automatic current injection on stopping (at the end of the ramp).

**NOTE:** There is an interlock between this function and **[Motor fluxing] FLU**. If **[Motor fluxing] FLU** is set to **[Continuous] FCT**, **[Auto DC Injection] ADC** must be **[No] NO**.

**[Auto DC Injection] ADC** is forced to **[No] NO** when **[Brake assignment] BLC** is not set to **[No] NO**.

Setting ( )	Code / Value	Description
<b>[No]</b>	NO	No injection <b>Factory setting</b>
<b>[Yes]</b>	YES	Adjustable injection time
<b>[Continuous]</b>	CT	Continuous standstill injection

**[Auto DC inj Level 1] SDC1 ★****Auto DC injection level 1.****NOTICE****OVERHEATING**

Verify that the connected motor is properly rated for the DC injection current to be applied in terms of amount and time.

**Failure to follow these instructions can result in equipment damage.**

Level of standstill DC injection current.

This parameter can be accessed if:

- **[Auto DC Injection] ADC** is not set to **[No] NO**, and
- **[Motor control type] CTT** is not set to **[FVC] FVC** or **[Sync.CL] FSY**.

Setting ( )	Description
0...1.1 In <sup>(1)</sup>	Setting range <b>Factory setting:</b> 0.7 In <sup>(1)</sup>
<sup>(1)</sup> In corresponds to the rated drive current indicated in the Installation Manual and on the drive nameplate.	

**[Auto DC Inj Time 1] TDC1 ★****Auto DC injection time 1.**



<b>NOTICE</b>
<p><b>OVERHEATING</b></p> <p>Verify that the connected motor is properly rated for the DC injection current to be applied in terms of amount and time.</p> <p><b>Failure to follow these instructions can result in equipment damage.</b></p>

This parameter can be accessed if

- [Auto DC Injection] ADC is not set to [No] NO, and
- [Motor control type] CTT is not set to [FVC] FVC or [Sync.CL] FSY.

This time corresponds to the zero speed maintenance time, if [Motor control type] CTT is set to [SYN\_U VC] SYNU or [Reluctance Motor] SRVC.

Setting ( )	Description
0.1...30.0 s	Setting range <b>Factory setting:</b> 0.5 s

This parameter is not applicable when the [Auto DC Injection] ADC is set to [Continuous] CT and [Auto DC inj Level 2] SDC2 value is 0.

## [Auto DC inj Level 2] SDC2 ★

*Auto DC injection level 2.*

<b>NOTICE</b>
<p><b>OVERHEATING</b></p> <p>Verify that the connected motor is properly rated for the DC injection current to be applied in terms of amount and time.</p> <p><b>Failure to follow these instructions can result in equipment damage.</b></p>

Second level of standstill DC injection current.

This parameter can be accessed if:

- [Auto DC Injection] ADC is not set to [No] NO, and
- [Motor control type] CTT is not set to [FVC] FVC or [Sync.CL] FSY

Setting ( )	Description
0...1.1 In <sup>(1)</sup>	Setting range <b>Factory setting:</b> 0.5 In <sup>(1)</sup>
(1) In corresponds to the rated drive current indicated in the Installation Manual and on the drive nameplate.	

## [Auto DC Inj Time 2] TDC2 ★

*Auto DC injection time 2.*

## NOTICE

### OVERHEATING

Verify that the connected motor is properly rated for the DC injection current to be applied in terms of amount and time.

**Failure to follow these instructions can result in equipment damage.**

Second standstill injection time.

This parameter can be accessed if:

- **[Auto DC Injection]** *ADC* is set to **[Yes]** *YES*, and
- **[Motor control type]** *CTT* is not set to **[FVC]** *FVC* or **[Sync.CL]** *FSY*.

Setting ( )	Description
0.0...30.0 s	Setting range <b>Factory setting:</b> 0.0 s

# [Generic functions] - [Ref. operations]

## [Ref. operations] OAI- Menu

### Access

[Complete settings] → [Generic functions] → [Ref. operations]

### About This Menu

Summing input / subtraction input / multiplier

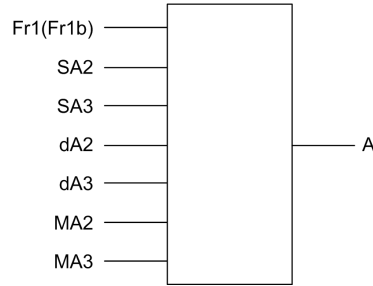

$$A = (FR1 \text{ or } FR1B + SA2 + SA3 - DA2 - DA3) \times MA2 \times MA3$$

**NOTE:**

- If SA2, SA3, DA2, DA3 are not assigned, they are set to 0.
- If MA2, MA3 are not assigned, they are set to 1.
- A is limited by the minimum LSP and maximum HSP parameters.
- For a multiplication, the signal on MA2, or MA3 is interpreted as a %. 100% corresponds to the maximum value of the corresponding input. If MA2, or MA3 is sent via the communication bus or Display Terminal, an MFR multiplication variable must be sent via the bus or Display Terminal.
- Reversal of the direction of operation in the event of a negative result can be blocked (see [Reverse Disable] RIN).

## [Summing Input 2] SA2

Summing input 2.

Selection of a reference to be added to [Ref Freq 1 Config] FR1 or [Ref.1B channel] FR1B.

Setting	Code / Value	Description
[Not Configured]	NO	Not assigned <b>Factory Setting</b>
[AI1]	AI1	Analog input AI1
[AI2]...[AI3]	AI2...AI3	Analog input AI2...AI3
[AI4]...[AI5]	AI4...AI5	Analog input AI4...AI5 if VW3A3203 I/O extension module has been inserted
[HMI]	LCC	Reference Frequency via remote terminal
[Ref. Freq-Modbus]	MDB	Reference frequency via Modbus
[Ref. Freq-CANopen]	CAN	Reference frequency via CANopen if a CANopen module has been inserted

Setting	Code / Value	Description
[Ref. Freq-Com. Module]	NET	Reference frequency via fieldbus module if a fieldbus module has been inserted
[Embedded Ethernet]	ETH	Embedded Ethernet <b>NOTE:</b> This selection can be accessed on ATV340•••N4E drives.
[AI Virtual 1]	AIV1	Virtual analogic input 1
[DI7 PulseInput]...[DI8 PulseInput]	PI7...PI8	Digital input DI7...DI8 used as pulse input <b>NOTE:</b> This selection can be accessed on drives with a power greater than 22kW.
[RP]	PI	Pulse input <b>NOTE:</b> This selection can be accessed on drives with a power below than 30 kW.
[Encoder]	PG	Encoder reference if an encoder module has been inserted or embedded encoder is used. <b>NOTE:</b> Embedded encoder is only available on drives with power up to 22kW.

### [Summing Input 3] SA3

Selection of a reference to be added to [Ref Freq 1 Config] FR1 or [Ref.1B channel] FR1B.

Identical to [Summing Input 2] SA2

### [Subtract Ref Freq 2] DA2

Selection of a reference to be subtracted from [Ref Freq 1 Config] FR1 or [Ref.1B channel] FR1B.

Identical to [Summing Input 2] SA2

### [Subtract Ref Freq 3] DA3

Selection of a multiplier reference [Ref Freq 1 Config] FR1 or [Ref.1B channel] FR1B.

Identical to [Summing Input 2] SA2.

### [Ref Freq 2 Multiply] MA2

Reference frequency 2 multiply (in % of the source range).

Selection of a multiplier reference [Ref Freq 1 Config] FR1 or [Ref.1B channel] FR1B.

Identical to [Summing Input 2] SA2.

### [Ref Freq 3 Multiply] MA3

Reference frequency 3 multiply (in % of the source range).

Selection of a multiplier reference [Ref Freq 1 Config] FR1 or [Ref.1B channel] FR1B.

Identical to [Summing Input 2] SA2.

## [Generic functions] - [Preset speeds]

### [Preset speeds] PSS- Menu

#### Access

[Complete settings] → [Generic functions] → [Preset speeds]

#### About This Menu

**NOTE:** This function cannot be used with some other functions.

### Combination Table for Preset Speed Inputs

2, 4, 8 or 16 speeds can be preset, requiring 1, 2, 3 or 4 digital inputs respectively.

It is necessary to configure:

- 2 and 4 speeds in order to obtain 4 speeds.
- 2, 4 and 8 speeds in order to obtain 8 speeds.
- 2, 4, 8 and 16 speeds in order to obtain 16 speeds.

16 Preset Freq (PS16)	8 Preset Freq (PS8)	4 Preset Freq (PS4)	2 Preset Freq (PS2)	Speed Reference
0	0	0	0	Reference 1 <sup>(1)</sup>
0	0	0	1	SP2
0	0	1	0	SP3
0	0	1	1	SP4
0	1	0	0	SP5
0	1	0	1	SP6
0	1	1	0	SP7
0	1	1	1	SP8
1	0	0	0	SP9
1	0	0	1	SP10
1	0	1	0	SP11
1	0	1	1	SP12
1	1	0	0	SP13
1	1	0	1	SP14
1	1	1	0	SP15
1	1	1	1	SP16

(1) Reference 1 = 5 P I, refer to diagram , page 187

### [2 Preset Freq] PS2

#### 2 Preset Freq assignment.

Value range	Code / Value	Description
[Not Assigned]	NO	Not assigned <b>Factory setting</b>
[DI1]...[DI8]	LI1...LI8	Digital input DI1...DI8

Value range	Code / Value	Description
		<b>NOTE:</b> DI8 selection can be accessed on drives with a power greater than 22kW.
[DI11]...[DI16]	LI11...LI16	Digital input DI11...DI16 if VW3A3203 I/O extension module has been inserted
[CD00]... [CD10]	CD00...CD10	Virtual digital input CMD.0...CMD.10 in [I/O profile] IO configuration
[CD11]... [CD15]	CD11...CD15	Virtual digital input CMD.11...CMD.15 regardless of configuration
[C101]... [C110]	C101...C110	Virtual digital input CMD1.01...CMD1.10 with integrated Modbus Serial in [I/O profile] IO configuration
[C111]... [C115]	C111...C115	Virtual digital input CMD1.11...CMD1.15 with integrated Modbus Serial regardless of configuration
[C201]... [C210]	C201...C210	Virtual digital input CMD2.01...CMD2.10 with CANopen® fieldbus module in [I/O profile] IO configuration
[C211]... [C215]	C211...C215	Virtual digital input CMD2.11...CMD2.15 with CANopen® fieldbus module regardless of configuration
[C301]... [C310]	C301...C310	Virtual digital input CMD3.01...CMD3.10 with a fieldbus module in [I/O profile] IO configuration
[C311]... [C315]	C311...C315	Virtual digital input CMD3.11...CMD3.15 with a fieldbus module regardless of configuration
[C501]... [C510]	C501...C510	Virtual digital input CMD5.01...CMD5.10 with integrated Ethernet in [I/O profile] IO configuration <b>NOTE:</b> This selection can be accessed on ATV340...N4E drives.
[C511]... [C515]	C511...C515	Virtual digital input CMD5.11...CMD5.15 with integrated Ethernet regardless of configuration <b>NOTE:</b> This selection can be accessed on ATV340...N4E drives.

## [4 Preset Freq] PS4

Identical to [2 Preset Freq] PS2

To obtain 4 speeds, you must also configure 2 speeds.

## [8 Preset Freq] PS8

Identical to [2 Preset Freq] PS2

To obtain 8 speeds, you must also configure 2 and 4 speeds.

## [16 Preset Freq] PS16

Identical to [2 Preset Freq] PS2

To obtain 16 speeds, you must also configure 2, 4 and 8 speeds.

## [Preset speed 2] SP2 to [Preset speed 16] SP16★

Preset speed 2 to preset speed 16. See the combination table for preset speed inputs, page 301.

Setting ( )	Description
0.0...599.0 Hz	Setting range  <b>Factory setting:</b> <ul style="list-style-type: none"><li>• [Preset speed 2] SP2: 10.0 Hz</li><li>• [Preset speed 3] SP3: 15.0 Hz</li><li>• [Preset speed 4] SP4: 20.0 Hz</li><li>• [Preset speed 5] SP5: 25.0 Hz</li><li>• [Preset speed 6] SP6: 30.0 Hz</li><li>• [Preset speed 7] SP7: 35.0 Hz</li><li>• [Preset speed 8] SP8: 40.0 Hz</li><li>• [Preset speed 9] SP9: 45.0 Hz</li><li>• [Preset speed 10] SP10: 50.0 Hz</li><li>• [Preset speed 11] SP11: 55.0 Hz</li><li>• [Preset speed 12] SP12: 60.0 Hz</li><li>• [Preset speed 13] SP13: 70.0 Hz</li><li>• [Preset speed 14] SP14: 80.0 Hz</li><li>• [Preset speed 15] SP15: 90.0 Hz</li><li>• [Preset speed 16] SP16: 100.0 Hz</li></ul>

## [Generic functions] - [+/- speed]

### [+/- speed] UPD– Menu

#### Access

[Complete settings] → [Generic functions] → [+/- speed]

#### About This Menu

This function can be accessed if reference channel [Ref Freq 2 Config] FR2 is set to [Ref Frequency via DI] UPDT

**NOTE:** This function cannot be used with some other functions.

2 types of operations are available:

- **Use of single press buttons:** 2 digital inputs are required in addition to the operating directions.  
The input assigned to the “+ speed” command increases the speed, the input assigned to the “– speed” command decreases the speed.
- **Use of double press buttons:** Only one digital input assigned to “+ speed” is required.

+/- speed with double-press buttons:

Description: 1 button pressed twice (2 steps) for each direction of rotation. A contact closes each time the button is pressed.

Setting	Released (– Speed)	First Press (Speed Maintained)	Second Press (Faster)
Forward button	–	a	a and b
Reverse button	–	c	c and d

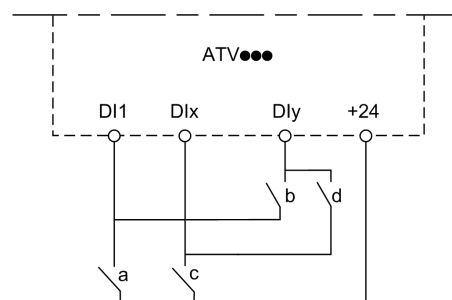

**DI1** Forward

**DIx** Reverse

**DIy** + speed



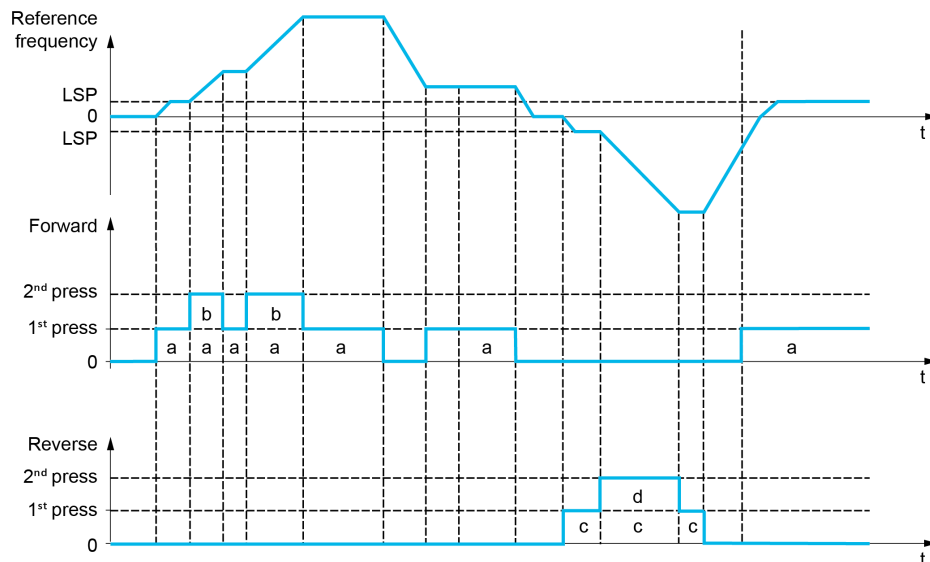

Do not use this +/- speed with double-press buttons with a 3-wire control.

Whichever type of operation is selected, the max. speed is set by **[High Speed] HSP**.

**NOTE:** If the reference is switched via **[Freq Switch Assign] RFC** from any reference channel to another reference channel with "+/- speed", the value of reference **[Motor Frequency] RFR** (after ramp) may be copied at the same time in accordance with the **[Copy Ch1-Ch2] COP** parameter.

This helps to prevent the speed from being incorrectly reset to zero when switching takes place.

## [+ Speed Assign] USP

Increase speed input assignment.

Function active if the assigned input or bit is at 1.

Value range	Code / Value	Description
<b>[Not Assigned]</b>	NO	Not assigned <b>Factory setting</b>
<b>[DI1]...[DI8]</b>	LI1...LI8	Digital input DI1...DI8 <b>NOTE:</b> DI8 selection can be accessed on drives with a power greater than 22kW.
<b>[DI11]...[DI16]</b>	LI11...LI16	Digital input DI11...DI16 if VW3A3203 I/O extension module has been inserted
<b>[CD00]... [CD10]</b>	CD00...CD10	Virtual digital input CMD.0...CMD.10 in <b>[I/O profile] IO</b> configuration
<b>[CD11]... [CD15]</b>	CD11...CD15	Virtual digital input CMD.11...CMD.15 regardless of configuration
<b>[C101]... [C110]</b>	C101...C110	Virtual digital input CMD1.01...CMD1.10 with integrated Modbus Serial in <b>[I/O profile] IO</b> configuration
<b>[C111]... [C115]</b>	C111...C115	Virtual digital input CMD1.11...CMD1.15 with integrated Modbus Serial regardless of configuration
<b>[C201]... [C210]</b>	C201...C210	Virtual digital input CMD2.01...CMD2.10 with CANopen® fieldbus module in <b>[I/O profile] IO</b> configuration
<b>[C211]... [C215]</b>	C211...C215	Virtual digital input CMD2.11...CMD2.15 with CANopen® fieldbus module regardless of configuration
<b>[C301]... [C310]</b>	C301...C310	Virtual digital input CMD3.01...CMD3.10 with a fieldbus module in <b>[I/O profile] IO</b> configuration

Value range	Code / Value	Description
[C311]... [C315]	C311...C315	Virtual digital input CMD3.11...CMD3.15 with a fieldbus module regardless of configuration
[C501]... [C510]	C501...C510	Virtual digital input CMD5.01...CMD5.10 with integrated Ethernet in <b>[I/O profile]</b> IO configuration <b>NOTE:</b> This selection can be accessed on ATV340...N4E drives.
[C511]... [C515]	C511...C515	Virtual digital input CMD5.11...CMD5.15 with integrated Ethernet regardless of configuration <b>NOTE:</b> This selection can be accessed on ATV340...N4E drives.

## [- Speed Assign] DSP

Down speed input assignment. See the assignment conditions.

Parameter settings identical to **[+ Speed Assign]** USP.

Function active if the assigned input or bit is at 1.

## [Ref Frequency Save] STR ★

Reference frequency saves. This parameter can be accessed if **[+ Speed Assign]** USP is not set to **[Not Assigned]** NO or **[- Speed Assign]** DSP is not set to **[Not Assigned]** NO.

Associated with the "+/- speed" function, this parameter can be used to save the reference:

- When the run commands disappear (saved to RAM).
- When the supply mains or the run commands disappear (saved to EEPROM).

Therefore, next time the drive starts up, the speed reference is the last reference frequency saved.

Setting	Code / Value	Description
[No Save]	NO	Not saved <b>Factory setting</b>
[Save to RAM]	RAM	+/- speed with saving of the reference frequency in RAM
[Save to EEPROM]	EEP	+/- speed with saving of the reference frequency in EEPROM

# [Generic functions] - [+/- speed around ref]

## [+/- speed around ref] SRE- Menu

### Access

[Complete settings] → [Generic functions] → [+/- speed around ref]

### About This Menu

The function can be accessed for reference channel [Ref Freq 1 Config] FR1.

**NOTE:** This function cannot be used with some other functions.

The reference is given by [Ref Freq 1 Config] FR1 or [Ref.1B channel] FR1B with summing/subtraction/multiplication functions and preset speeds if relevant (see the diagram below).

For improved clarity, it calls this reference A. The action of the +speed and -speed keys can be set as a % of this reference A. On stopping, the reference (A +/- speed) is not saved, so the drive restarts with reference A+ only.

The maximum total reference is limited by [High Speed] HSP and the minimum reference by [Low Speed] LSP.

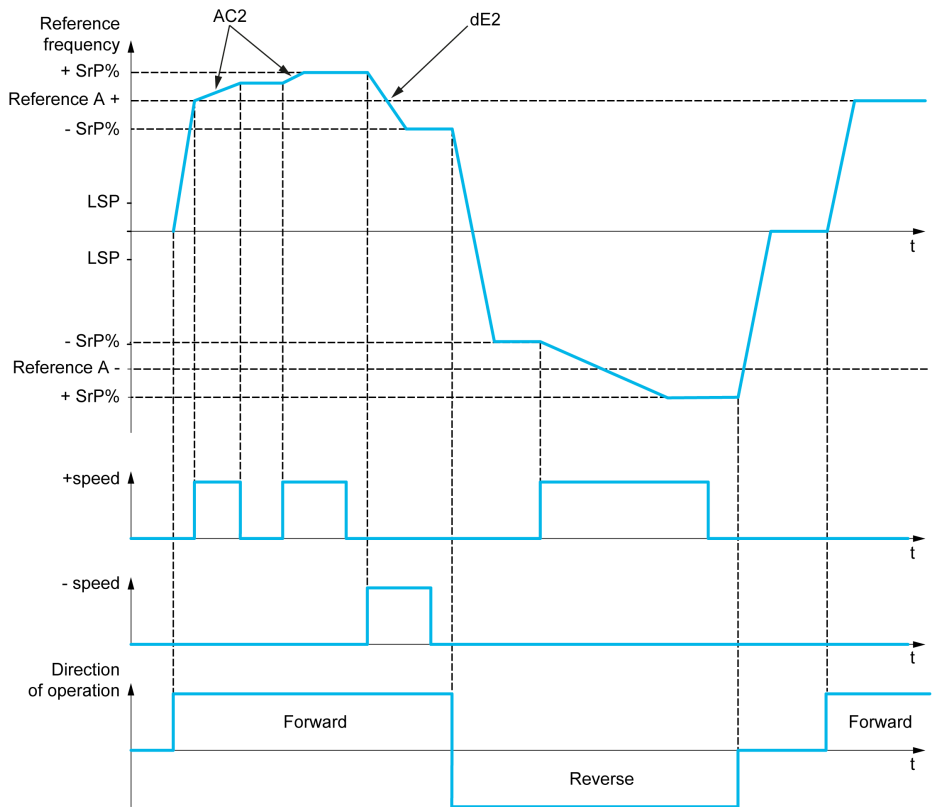

## [+ Speed Assign] US1

**+ speed assignment.**

Value range	Code / Value	Description
[Not Assigned]	NO	Not assigned <b>Factory setting</b>
[DI1]...[DI8]	LI1...LI8	Digital input DI1...DI8

Value range	Code / Value	Description
		<b>NOTE:</b> DI8 selection can be accessed on drives with a power greater than 22kW.
[DI11]...[DI16]	LI11...LI16	Digital input DI11...DI16 if VW3A3203 I/O extension module has been inserted
[CD00]... [CD10]	CD00...CD10	Virtual digital input CMD.0...CMD.10 in [I/O profile] IO configuration
[CD11]... [CD15]	CD11...CD15	Virtual digital input CMD.11...CMD.15 regardless of configuration
[C101]... [C110]	C101...C110	Virtual digital input CMD1.01...CMD1.10 with integrated Modbus Serial in [I/O profile] IO configuration
[C111]... [C115]	C111...C115	Virtual digital input CMD1.11...CMD1.15 with integrated Modbus Serial regardless of configuration
[C201]... [C210]	C201...C210	Virtual digital input CMD2.01...CMD2.10 with CANopen® fieldbus module in [I/O profile] IO configuration
[C211]... [C215]	C211...C215	Virtual digital input CMD2.11...CMD2.15 with CANopen® fieldbus module regardless of configuration
[C301]... [C310]	C301...C310	Virtual digital input CMD3.01...CMD3.10 with a fieldbus module in [I/O profile] IO configuration
[C311]... [C315]	C311...C315	Virtual digital input CMD3.11...CMD3.15 with a fieldbus module regardless of configuration
[C501]... [C510]	C501...C510	Virtual digital input CMD5.01...CMD5.10 with integrated Ethernet in [I/O profile] IO configuration <b>NOTE:</b> This selection can be accessed on ATV340...N4E drives.
[C511]... [C515]	C511...C515	Virtual digital input CMD5.11...CMD5.15 with integrated Ethernet regardless of configuration <b>NOTE:</b> This selection can be accessed on ATV340...N4E drives.

## [- Speed Assign] DSI

Down speed assignment. See the assignment conditions.

Function active if the assigned input or bit is at 1.

Possible assignments: Identical to [+ Speed Assign] USI (see above).

## [+/- Speed limitation] SRP ★

Up/Down speed limit.

This parameter limits the variation range with +/- speed as a % of the reference. The ramps used in this function are [Acceleration 2] AC2 and [Deceleration 2] DE2.

This parameter can be accessed if [+ Speed Assign] USI or [- Speed Assign] DSI is not set to [Not Assigned] NO.

Setting ( )	Description
0...50%	Setting range <b>Factory setting:</b> 10%

## [Acceleration 2] AC2 ★

Time to accelerate from 0 to the **[Nominal Motor Freq]** FRS. To have repeatability in ramps, the value of this parameter must be set according to the possibility of the application.

This parameter can be accessed if **[+ Speed Assign]** USI or **[- Speed Assign]** DSI is not set to **[Not Assigned]** NO.

Setting ( )	Description
0.00...6,000 s <sup>(1)</sup>	Setting range <b>Factory setting:</b> 5.00 s
<b>(1)</b> Range 0.01 to 99.99 s or 0.1 to 999.9 s or 1...6,000 s according to <b>[Ramp increment]</b> INR.	

## [Deceleration 2] DE2 ★

Time to decelerate from the **[Nominal Motor Freq]** FRS to 0. To have repeatability in ramps, the value of this parameter must be set according to the possibility of the application.

This parameter can be accessed if **[+ Speed Assign]** USI or **[- Speed Assign]** DSI is not set to **[Not Assigned]** NO.

Setting ( )	Description
0.00...6,000 s <sup>(1)</sup>	Setting range <b>Factory setting:</b> 5.00 s
<b>(1)</b> Range 0.01 to 99.99 s or 0.1 to 999.9 s or 1...6,000 s according to <b>[Ramp increment]</b> INR.	

# [Generic functions] - [Jump frequency]

## [Jump frequency] JUF- Menu

### Access

[Complete settings] → [Generic functions] → [Jump frequency]

### About This Menu

This function helps to prevent prolonged operation within an adjustable range around the regulated frequency.

This function can be used to help prevent reaching a frequency, which could cause resonance. Setting the parameter to 0 disables the function.

The following figure is an example of the jump frequency function with one skip frequency defined by [Skip Frequency] JPF:

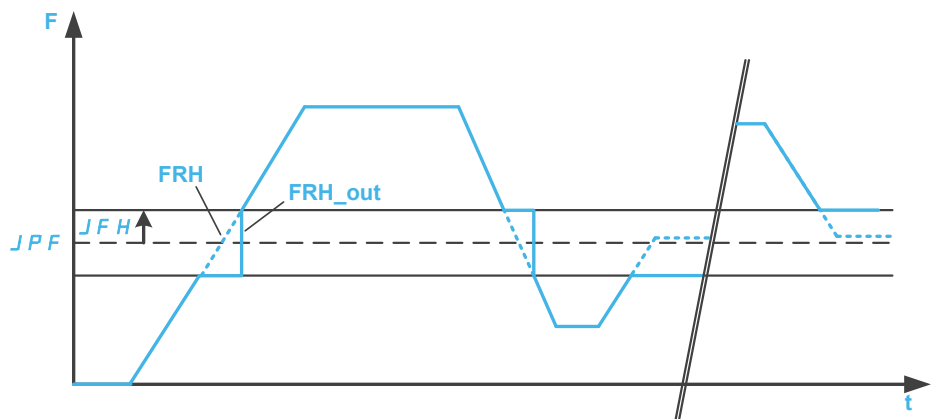

F Frequency

t time

JPF [Skip Frequency]

JFH [Skip Freq.Hysteresis]

FRH [Pre-Ramp Ref Freq]

FRH\_out [Pre-Ramp Ref Freq] after the jump frequency function

### [Skip Frequency] JPF

*Skip frequency.*

Setting ( )	Description
0.0...599.0 Hz	Setting range Factory setting: 0.0 Hz

### [Skip Frequency 2] JF2

*Skip frequency 2.*

Setting ( )	Description
0.0...599.0 Hz	Setting range <b>Factory setting:</b> 0.0 Hz

### [3rd Skip Frequency] JF3

*3rd Skip frequency.*

Setting ( )	Description
0.0...599.0 Hz	Setting range <b>Factory setting:</b> 0.0 Hz

### [Skip Freq.Hysteresis] JFH ★

Jump frequency bandwidth.

This parameter can be accessed if at least one skip frequency *JPF*, *JF2*, or *JF3* is different from 0.

Skip frequency range: between  $JPF - JFH$  and  $JPF + JFH$  for example.

This adjustment is common to the 3 frequencies *JPF*, *JF2*, *JF3*.

Setting ( )	Description
0.1...10.0 Hz	Setting range <b>Factory setting:</b> 1.0 Hz

# [Generic functions] - [PID controller]

## [PID controller] PID- Overview

### About This Menu

**NOTE:** This function cannot be used with some other functions.

### Block Diagram

The function is activated by assigning an analog input to the PID feedback (measurement).

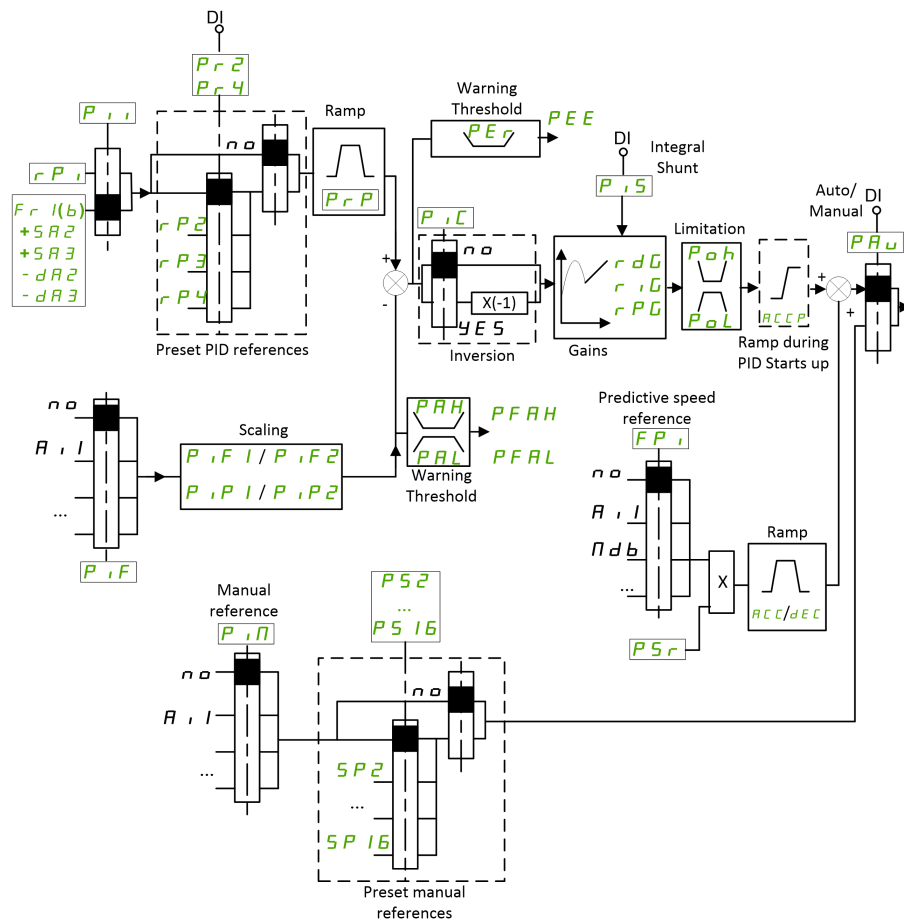

The PID feedback needs to be assigned to one of the analog inputs AI1 to AI5 or a pulse input, according to whether any I/O extension module has been inserted.

The PID reference needs to be assigned to the following parameters:

- Preset references via digital inputs ([Ref PID Preset 2] RP2, [Ref PID Preset 3] RP3, [Ref PID Preset 4] RP4).
- In accordance with the configuration of [Intern PID Ref] PII:
  - [Internal PID ref] RPI, or
  - Reference A [Ref Freq 1 Config] FR1 or [Ref.1B channel] FR1B.



## Combination Table for Preset PID References:

DI (Pr 4)	DI (Pr 2)	Pr 2 = no	Reference
			RPI or FR1B
0	0		RPI or FR1B
0	1		RP2
1	0		RP3
1	1		RP4

A predictive speed reference can be used to initialize the speed on restarting the process.

Scaling of feedback and references:

- **[Min PID feedback] PIF1, [Max PID feedback] PIF2** parameters can be used to scale the PID feedback (sensor range). **This scale MUST be maintained for all other parameters.**
- **[Min PID Process] PIP1, [Max PID Process] PIP2** parameters can be used to scale the adjustment range, for example the reference. **Check that the adjustment range remains within the sensor range.**

The maximum value of the scaling parameters is 32,767. To facilitate the installation, it is recommended to use values as close as possible to this maximum level, while retaining powers of 10 in relation to the actual values. The scaling is without unit if **[Type of control] TOCT** is set to **[Not Available] NA**, in % if set to **[OTHER] OTHER**.

## Example

Adjustment of the volume in a tank, 6...15 m<sup>3</sup>.

- Probe used 4-20 mA, 4.5 m<sup>3</sup> for 4 mA and 20 m<sup>3</sup> for 20 mA, with the result that **PIF1** = 4,500 and **PIF2** = 20,000.
- Adjustment range 6 to 15 m<sup>3</sup>, with the result that **PIP1** = 6,000 (min. reference) and **PIP2** = 15,000 (max. reference).
- Example references:
  - **RPI** (internal reference) = 9,500
  - **RP2** (preset reference) = 6,500
  - **RP3** (preset reference) = 8,000
  - **RP4** (preset reference) = 11,200

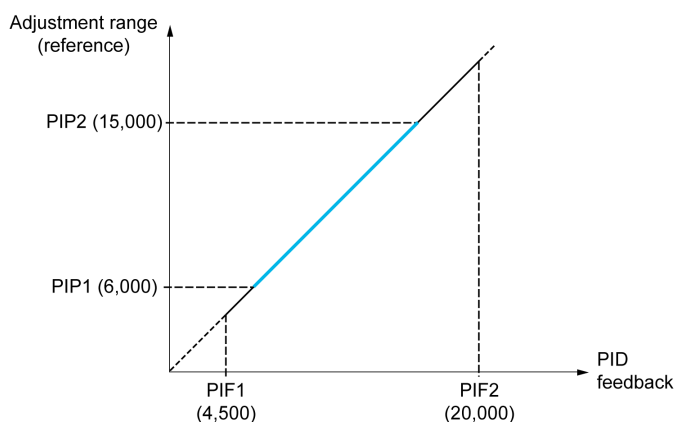

Other parameters:

- Reversal of the direction of correction **[PID Inversion]** *PIC*. If **[PID Inversion]** *PIC* is set to **[No]** NO, the speed of the motor increases when the detected error is positive (for example pressure control with a compressor). If **[PID Inversion]** *PIC* is set to **[Yes]** YES, the speed of the motor decreases when the detected error is positive (for example temperature control using a cooling fan).
- The integral gain may be short-circuited by a digital input.
- A warning on the **[PID feedback Assign]** *PIF* may be configured.
- A warning on the **[PID Error]** *RPE* may be configured.

## "Manual - Automatic" Operation with PID

This function combines the PID controller, the preset speeds, and a manual reference. Depending on the state of the digital input, the speed reference is given by the preset speeds or by a manual reference input via the PID function.

Manual PID reference **[Manual PID reference]** *PIM*:

- Analog inputs AI1 to AI5
- Pulse inputs

Predictive speed reference **[Predictive Speed Ref]** *FPI*:

- **[AI1]** *AI1*: analog input
- **[AI2]** *AI2*: analog input
- **[AI3]** *AI3*: analog input
- **[AI4]** *AI4*: analog input if VW3A3203 I/O extension module has been inserted
- **[AI5]** *AI5*: analog input if VW3A3203 I/O extension module has been inserted
- **[HMI]** *LCC*: Display Terminal
- **[Ref. Freq-Modbus]** *MDB*: integrated Modbus
- **[Ref. Freq-CANopen]** *CAN*: CANopen® (if inserted)
- **[Ref. Freq-CANopen]** *NET*: fieldbus option module (if inserted)
- **[Embedded Ethernet]** *ETH*: embedded Ethernet (on ATV340•••N4E drives).

## Setting Up the PID Controller

### 1. Configuration in PID mode.

Refer to the Block Diagram, page 312.

### 2. Perform a test in factory settings mode.

To optimize the drive, adjust **[PID Prop.Gain]** *RPG* or **[PID Intgl.Gain]** *RIG* gradually and independently, and observe the effect on the PID feedback in relation to the reference.

### 3. If the factory settings are unstable or the reference is incorrect.

Step	Action
1	Perform a test with a speed reference in manual mode (without PID controller) and with the drive on load for the speed range of the system: <ul style="list-style-type: none"> <li>• In steady state, the speed must be stable and comply with the reference, and the PID feedback signal must be stable.</li> <li>• In transient state, the speed must follow the ramp and stabilize quickly, and the PID feedback must follow the speed. If not, see the settings for the drive and/or sensor signal and wiring.</li> </ul>
2	Switch to PID mode.
3	Set <b>[PID ramp]</b> <i>PRP</i> to the minimum permitted by the mechanism without triggering an <b>[DC Bus Overvoltage]</b> <i>OBV</i> .
4	Set the integral gain <b>[PID Intgl.Gain]</b> <i>RIG</i> to minimum.

Step	Action
5	Leave the derivative gain [PID derivative gain] <b>RDG</b> at 0.
6	Observe the PID feedback and the reference.
7	Switch the drive ON/OFF a number of times or vary the load or reference rapidly a number of times.
8	Set the proportional gain [PID Prop.Gain] <b>RPG</b> in order to ascertain the compromise between response time and stability in transient phases (slight overshoot and 1 to 2 oscillations before stabilizing).
9	If the reference varies from the preset value in steady state, gradually increase the integral gain [PID Intgl.Gain] <b>RIG</b> , reduce the proportional gain [PID Prop.Gain] <b>RPG</b> in the event of instability (pump applications), find a compromise between response time and static precision (see diagram).
10	Lastly, the derivative gain may permit the overshoot to be reduced and the response time to be improved, although this is more difficult to obtain a compromise in terms of stability, as it depends on 3 gains.
11	Perform in-production tests over the whole reference range.

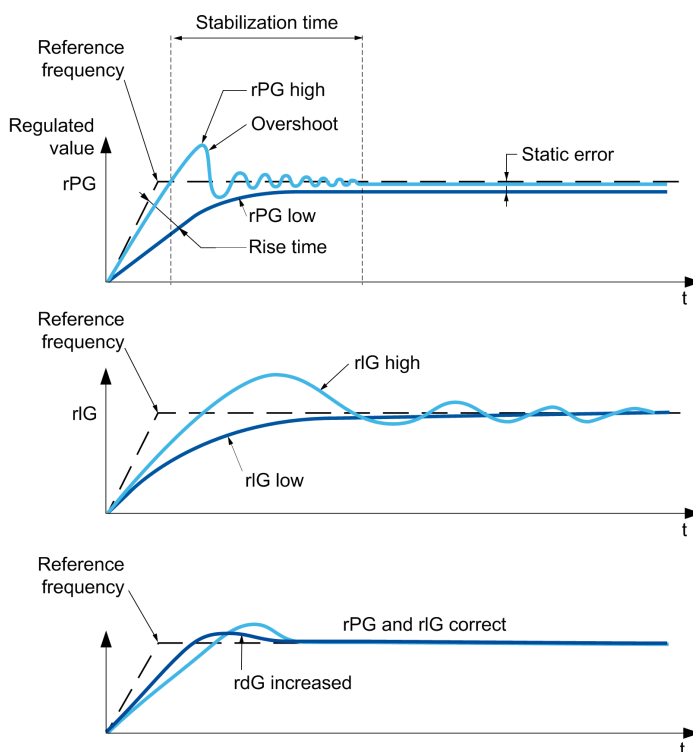

The oscillation frequency depends on the system kinematics:

Parameter	Rise time	Overshoot	Stabilization time	Static error
rPG +	--	+	=	-
rIG +	-	++	+	--
rdG +	=	-	-	=

## [PID Feedback] FDB- Menu

### Access

[Complete settings] → [Generic functions] → [PID controller] → [PID Feedback]

### About This Menu

**NOTE:** This function cannot be used with some other functions.

### [Type of control] TOCT

Type of control for the PID = unit choice.

Setting	Code / Value	Description
[Not Available]	NA	No units <b>Factory setting</b>
[OTHER]	OTHER	Other control and unit (%)

### [PID feedback Assign] PIF

#### *PID controller feedback.*

Setting	Code / Value	Description
[Not Configured]	NO	Not assigned <b>Factory setting</b>
[AI1]...[AI3]	AI1...AI3	Analog input AI1...AI3
[AI4]...[AI5]	AI4...AI5	Analog input AI4...AI5 if VW3A3203 I/O extension module has been inserted
[AI Virtual 1]	AIV1	Virtual analogic input 1
[Encoder]	PI	Pulse input <b>NOTE:</b> This selection can be accessed on drives with a power below than 30 kW.
[Encoder]	PG	Encoder reference if an encoder module has been inserted or embedded encoder is used. <b>NOTE:</b> Embedded encoder is only available on drives with power up to 22kW.

### [AI1 Type] AI1T ★

#### *Configuration of AI1.*

This parameter can be accessed if [PID feedback Assign] PIF is set to [AI1] AI1.

Setting	Code / Value	Description
[Voltage]	10U	0-10 Vdc <b>Factory setting</b>
[Current]	0A	0-20 mA

**[AI1 Min. Value] UII1** ★

**AI1 voltage scaling parameter of 0%.**

This parameter can be accessed if:

- **[PID feedback Assign] PIF** is set to **[AI1] AI1**, and
- **[AI1 Type] AI1T** is set to **[Voltage] 10U**.

Setting	Description
0.0...10.0 Vdc	Setting range Factory setting: 0.0 Vdc

**[AI1 Max Value] UIH1** ★

**AI1 voltage scaling parameter of 100%.**

This parameter can be accessed if:

- **[PID feedback Assign] PIF** is set to **[AI1] AI1**, and
- **[AI1 Type] AI1T** is set to **[Voltage] 10U**.

Setting	Description
0.0...10.0 Vdc	Setting range Factory setting: 10.0 Vdc

**[AI1 Min. Value] CRL1** ★

**AI1 current scaling parameter of 0%.**

This parameter can be accessed if:

- **[PID feedback Assign] PIF** is set to **[AI1] AI1**, and
- **[AI1 Type] AI1T** is set to **[Current] 0A**.

Setting	Description
0.0...20.0 mA	Setting range Factory setting: 0.0 mA

**[AI1 Max Value] CRH1** ★

**AI1 current scaling parameter of 100%.**

This parameter can be accessed if:

- **[PID feedback Assign] PIF** is set to **[AI1] AI1**, and
- **[AI1 Type] AI1T** is set to **[Current] 0A**.

Setting	Description
0.0...20.0 mA	Setting range Factory setting: 20.0 mA

**[AI1 range] AI1L** ★

This parameter can be accessed if:

- **[PID feedback Assign]** PIF is set to **[AI1]** AI1, and
- **[AI1 Type]** AI1T is set to **[Current]** 0A.

This parameter is forced to **[0 - 100%]** POS if:

- **[AI1 Type]** AI1T is set to **[Current]** 0A, or
- **[AI1 Min. Value]** CRL1 is lower than 3.0 mA.

Setting	Code / Value	Description
<b>[0 - 100%]</b>	POS	Unidirectional: AI1 current scaling is 0% up to 100%. <b>Factory setting</b>
<b>[+/- 100%]</b>	POSNEG	Bidirectional: AI1 current scaling is -100% up to 100%. <b>[AI1 Min. Value]</b> CRL1 corresponds to -100%. <b>[AI1 Max Value]</b> CRH1 corresponds to 100%.

## [AI2 Type] AI2T ★

### Configuration of AI2.

This parameter can be accessed if **[PID feedback Assign]** PIF is set to **[AI2]** AI2

Setting	Code / Value	Description
<b>[Voltage]</b>	10U	0-10 Vdc
<b>[Voltage +/-]</b>	N10U	-10/+10 Vdc <b>Factory setting</b>

## [AI2 Min. Value] UIL2 ★

### AI2 voltage scaling parameter of 0%.

This parameter can be accessed if:

- **[PID feedback Assign]** PIF is set to **[AI2]** AI2, and
- **[AI2 Type]** AI2T is set to **[Voltage]** 10U.

Identical to **[AI1 Min. Value]** UIL1, page 317.

## [AI2 Max value] UIH2 ★

### AI2 voltage scaling parameter of 100%.

This parameter can be accessed if:

- **[PID feedback Assign]** PIF is set to **[AI2]** AI2, and
- **[AI2 Type]** AI2T is set to **[Voltage]** 10U.

Identical to **[AI1 Max Value]** UIH1, page 317.

## [AI3 Type] AI3T ★

### Configuration of AI3.

This parameter can be accessed if **[PID feedback Assign]** PIF is set to **[AI3]** AI3.

Identical to **[AI2 Type]** AI2T, page 317.

## [AI3 Min. Value] UIL3 ★

*AI3 voltage scaling parameter of 0%.*

This parameter can be accessed if:

- [PID feedback Assign] PIF is set to [AI3] AI3, and
- [AI3 Type] AI3T is set to [Voltage] 10U.

Identical to [AI1 Min. Value] UIL1 , page 317.

## [AI3 Max Value] UIH3 ★

*AI3 voltage scaling parameter of 100%.*

This parameter can be accessed if:

- [PID feedback Assign] PIF is set to [AI3] AI3, and
- [AI3 Type] AI3T is set to [Voltage] 10U.

Identical to [AI1 Max Value] UIH1 , page 317.

## [AI3 Min. Value] CRL3 ★

*AI3 current scaling parameter of 0%.*

This parameter can be accessed if:

- [PID feedback Assign] PIF is set to [AI3] AI3, and
- [AI3 Type] AI3T is set to [Current] 0A.

Identical to [AI1 Min. Value] CRL1 , page 317.

## [AI3 Max Value] CRH3 ★

*AI3 current scaling parameter of 100%.*

This parameter can be accessed if:

- [PID feedback Assign] PIF is set to [AI3] AI3, and
- [AI3 Type] AI3T is set to [Current] 0A.

Identical to [AI1 Max Value] CRH1 , page 317.

## [AI3 range] AI3L ★

*Analog input 3 range.*

This parameter can be accessed if:

- [PID feedback Assign] PIF is set to [AI3] AI3, and
- [AI3 Type] AI3T is set to [Current] 0A

Identical to [AI1 range] AI1L , page 317.

## [AI4 Type] AI4T ★

*Configuration of AI4.*

This parameter can be accessed if:

- VW3A3203 I/O extension module has been inserted, and
- [PID feedback Assign] PIF is set to [AI4] AI4.

Setting	Code / Value	Description
[Voltage]	10U	0-10 Vdc
[Current]	0A	0-20 mA Factory setting
[Voltage +/-]	N10U	-10/+10 Vdc

### [AI4 Min. Value] U1L4 ★

**AI4 voltage scaling parameter of 0%.**

This parameter can be accessed if:

- [PID feedback Assign] PIF is set to [AI4] AI4, and
- [AI4 Type] AI4T is set to [Voltage] 10U.

Identical to [AI1 Min. Value] U1L1, page 317.

### [AI4 Max Value] U1H4 ★

**AI4 voltage scaling parameter of 100%.**

This parameter can be accessed if:

- [PID feedback Assign] PIF is set to [AI4] AI4, and
- [AI4 Type] AI4T is set to [Voltage] 10U.

Identical to [AI1 Max Value] U1H1, page 317.

### [AI4 Min. Value] C1L4 ★

**AI4 current scaling parameter of 0%.**

This parameter can be accessed if:

- [PID feedback Assign] PIF is set to [AI4] AI4, and
- [AI4 Type] AI4T is set to [Current] 0A.

Identical to [AI1 Min. Value] C1L1, page 317.

### [AI4 Max Value] C1H4 ★

**AI4 current scaling parameter of 100%.**

This parameter can be accessed if:

- [PID feedback Assign] PIF is set to [AI4] AI4, and
- [AI4 Type] AI4T is set to [Current] 0A.

Identical to [AI1 Max Value] C1H1, page 317.

### [AI4 range] AI4L ★

This parameter can be accessed if:

- [PID feedback Assign] PIF is set to [AI4] AI4, and
- [AI4 Type] AI4T is set to [Current] 0A

Identical to [AI1 range] AI1L, page 317.



## [AI5 Type] AI5T ★

### **Configuration of AI5.**

This parameter can be accessed if:

- VW3A3203 I/O extension module has been inserted, and
- **[PID feedback Assign]** PIF is set to **[AI5]** AI5.

Identical to **[AI4 Type]** AI4T.

## [AI5 Min. Value] UIL5 ★

### **AI5 voltage scaling parameter of 0%.**

This parameter can be accessed if:

- **[PID feedback Assign]** PIF is set to **[AI5]** AI5, and
- **[AI5 Type]** AI5T is set to **[Voltage]** 10U.

Identical to **[AI1 Min. Value]** UIL1 , page 317.

## [AI5 Max Value] UIH5 ★

### **AI5 voltage scaling parameter of 100%.**

This parameter can be accessed if:

- **[PID feedback Assign]** PIF is set to **[AI5]** AI5, and
- **[AI5 Type]** AI5T is set to **[Voltage]** 10U.

Identical to **[AI1 Max Value]** UIH1 , page 317.

## [AI5 Min. Value] CRL5 ★

### **AI5 current scaling parameter of 0%.**

This parameter can be accessed if:

- **[PID feedback Assign]** PIF is set to **[AI5]** AI5, and
- **[AI5 Type]** AI5T is set to **[Current]** 0A.

Identical to **[AI1 Min. Value]** CRL1 , page 317.

## [AI5 Max Value] CRH5 ★

### **AI5 current scaling parameter of 100%.**

This parameter can be accessed if:

- **[PID feedback Assign]** PIF is set to **[AI5]** AI5, and
- **[AI5 Type]** AI5T is set to **[Current]** 0A.

Identical to **[AI1 Max Value]** CRH1 , page 317.

## [AI5 range] AI5L ★

This parameter can be accessed if:

- **[PID feedback Assign]** PIF is set to **[AI5]** AI5, and
- **[AI5 Type]** AI5T is set to **[Current]** 0A.

Identical to **[AI1 range]** AI1L , page 317.

**[Min PID feedback] PIF1** ★

This parameter can be accessed if **[PID feedback Assign] PIF** is not set to **[Not Configured] NO**.

Setting ( )	Description
0... <b>[Max PID feedback] PIF2</b>	Setting range <b>Factory setting:</b> 100

**[Max PID feedback] PIF2** ★

This parameter can be accessed if **[PID feedback Assign] PIF** is not set to **[Not Configured] NO**.

Setting ( )	Description
<b>[PID feedback Assign] PIF</b> is not set to <b>[Not Configured] NO</b> ...32,767	Setting range <b>Factory setting:</b> 1,000

**[PID feedback] RPF** ★

Value for PID feedback, display only.

This parameter can be accessed if **[PID feedback Assign] PIF** is not set to **[Not Configured] NO**.

Setting	Description
0...65,535	Setting range <b>Factory setting:</b> 0

**[Min fbk Warning] PAL** ★

Minimum feedback level warning (for **[PID Low Fdbck Warn] PFAL** warning).

This parameter can be accessed if **[PID feedback Assign] PIF** is not set to **[Not Configured] NO**.

Setting ( )	Description
0...65,535	Setting range <b>Factory setting:</b> 100

**[Max fbk Warning] PAH** ★

Maximum feedback level warning (for **[PID High Fdbck Warn] PFAH** warning).

This parameter can be accessed if **[PID feedback Assign] PIF** is not set to **[Not Configured] NO**.

Setting ( )	Description
0...65,535	Setting range <b>Factory setting:</b> 1,000

## [PID Reference] RF – Menu

### Access

[Complete settings] → [Generic functions] → [PID controller] → [PID Reference]

### About This Menu

**NOTE:** This function cannot be used with some other functions.

### [Intern PID Ref] PII ★

This parameter can be accessed if [PID feedback Assign] PIF is not set to [Not Configured] NO.

Setting	Code / Value	Description
[No]	NO	The PID controller reference is given by [Ref Freq 1 Config] FR1 or [Ref.1B channel] FR1B with summing/subtraction/multiplication functions. Refer to the block diagram. <b>Factory setting</b>
[Yes]	YES	The PID controller reference is internal via [Internal PID ref] RPI.

### [Ref Freq 1 Config] FR1 ★

#### Configuration reference frequency 1.

This parameter can be accessed if:

- [PID feedback Assign] PIF is not set to [Not Configured] NO, and
- [Intern PID Ref] PII is set to [No] NO.

Setting	Code / Value	Description
[Not Configured]	NO	Not assigned
[AI1]	AI1	Analog input AI1 <b>Factory Setting</b>
[AI2]...[AI3]	AI2...AI3	Analog input AI2...AI3 <b>NOTE:</b> AI3 selection can be accessed on drives with a power greater than 22 kW.
[AI Virtual 1]	AIV1	Virtual analogic input 1
[AI4]...[AI5]	AI4...AI5	Analog input AI4...AI5 if VW3A3203 I/O extension module has been inserted
[HMI]	LCC	Reference Frequency via remote terminal
[Ref. Freq-Modbus]	MDB	Reference frequency via Modbus
[Ref. Freq-CANopen]	CAN	Reference frequency via CANopen if a CANopen module has been inserted
[Ref. Freq-Com. Module]	NET	Reference frequency via fieldbus module if a fieldbus module has been inserted
[Embedded Ethernet]	ETH	Embedded Ethernet <b>NOTE:</b> This selection can be accessed on ATV340...N4E drives.

Setting	Code / Value	Description
[RP]	PI	Pulse input <b>NOTE:</b> This selection can be accessed on drives with a power below than 30 kW.
[Encoder]	PG	Encoder reference if an encoder module has been inserted or embedded encoder is used. <b>NOTE:</b> Embedded encoder is only available on drives with power up to 22kW.

### [Min PID Process] PIP1 ★

This parameter can be accessed if [PID feedback Assign] PIF is not set to [Not Configured] NO.

Setting ( )	Description
[Min PID feedback] PIP1...[Max PID Process] PIP2	Setting range <b>Factory setting:</b> 150

### [Max PID Process] PIP2 ★

This parameter can be accessed if [PID feedback Assign] PIF is not set to [Not Configured] NO.

Setting ( )	Description
[Min PID Process] PIP1...[Max PID feedback] PIF2	Setting range <b>Factory setting:</b> 900

### [Internal PID ref] RPI ★

This parameter can be accessed if:

- [PID feedback Assign] PIF is not set to [Not Configured] NO, and
- [Intern PID Ref] PII is set to [Yes] YES.

Setting ( )	Description
[Min PID Process] PIP1...[Max PID Process] PIP2	Setting range <b>Factory setting:</b> 150

### [Auto/Manual assign.] PAU ★

*Auto/Manual select input.*

This parameter can be accessed if [PID feedback Assign] PIF is not set to [Not Configured] NO.

Value range	Code / Value	Description
[Not Assigned]	NO	Not assigned <b>Factory setting</b>
[DI1]...[DI8]	LI1...LI8	Digital input DI1...DI8 <b>NOTE:</b> DI8 selection can be accessed on drives with a power greater than 22kW.

Value range	Code / Value	Description
[DI11]...[DI16]	LI11...LI16	Digital input DI11...DI16 if VW3A3203 I/O extension module has been inserted
[CD00]... [CD10]	CD00...CD10	Virtual digital input CMD.0...CMD.10 in [I/O profile] IO configuration
[CD11]... [CD15]	CD11...CD15	Virtual digital input CMD.11...CMD.15 regardless of configuration
[C101]... [C110]	C101...C110	Virtual digital input CMD1.01...CMD1.10 with integrated Modbus Serial in [I/O profile] IO configuration
[C111]... [C115]	C111...C115	Virtual digital input CMD1.11...CMD1.15 with integrated Modbus Serial regardless of configuration
[C201]... [C210]	C201...C210	Virtual digital input CMD2.01...CMD2.10 with CANopen® fieldbus module in [I/O profile] IO configuration
[C211]... [C215]	C211...C215	Virtual digital input CMD2.11...CMD2.15 with CANopen® fieldbus module regardless of configuration
[C301]... [C310]	C301...C310	Virtual digital input CMD3.01...CMD3.10 with a fieldbus module in [I/O profile] IO configuration
[C311]... [C315]	C311...C315	Virtual digital input CMD3.11...CMD3.15 with a fieldbus module regardless of configuration
[C501]... [C510]	C501...C510	Virtual digital input CMD5.01...CMD5.10 with integrated Ethernet in [I/O profile] IO configuration <b>NOTE:</b> This selection can be accessed on ATV340...N4E drives.
[C511]... [C515]	C511...C515	Virtual digital input CMD5.11...CMD5.15 with integrated Ethernet regardless of configuration <b>NOTE:</b> This selection can be accessed on ATV340...N4E drives.

## [Manual PID reference] PIM ★

Reference input in manual mode.

This parameter can be accessed if:

- [PID feedback Assign] PIF is not set to [Not Configured] NO, and
- [Auto/Manual assign.] PAU is not set to [Not Assigned] NO.

The preset speeds are active on the manual reference if they have been configured.

Setting	Code / Value	Description
[Not Configured]	NO	Not assigned <b>Factory setting</b>
[AI1]...[AI3]	AI1...AI3	Analog input AI1...AI3
[AI4]...[AI5]	AI4...AI5	Analog input AI4...AI5 if VW3A3203 I/O extension module has been inserted
[RP]	PI	Pulse input <b>NOTE:</b> This selection can be accessed on drives with a power below than 30 kW.
[Encoder]	PG	Encoder reference if an encoder module has been inserted or embedded encoder is used. <b>NOTE:</b> Embedded encoder is only available on drives with power up to 22kW.

## [PID preset references] PRI– Menu

### Access

[Complete settings] → [Generic functions] → [PID controller] → [PID Reference] → [PID preset references]

### About This Menu

The function can be accessed if [PID feedback Assign] PIF is assigned.

### [2 PID Preset Assign] PR2

If the assigned input or bit is at 0, the function is inactive.

If the assigned input or bit is at 1, the function is active.

Value range	Code / Value	Description
[Not Assigned]	NO	Not assigned <b>Factory setting</b>
[DI1]...[DI8]	LI1...LI8	Digital input DI1...DI8 <b>NOTE:</b> DI8 selection can be accessed on drives with a power greater than 22KW.
[DI11]...[DI16]	LI11...LI16	Digital input DI11...DI16 if VW3A3203 I/O extension module has been inserted
[CD00]... [CD10]	CD00...CD10	Virtual digital input CMD.0...CMD.10 in [I/O profile] IO configuration
[CD11]... [CD15]	CD11...CD15	Virtual digital input CMD.11...CMD.15 regardless of configuration
[C101]... [C110]	C101...C110	Virtual digital input CMD1.01...CMD1.10 with integrated Modbus Serial in [I/O profile] IO configuration
[C111]... [C115]	C111...C115	Virtual digital input CMD1.11...CMD1.15 with integrated Modbus Serial regardless of configuration
[C201]... [C210]	C201...C210	Virtual digital input CMD2.01...CMD2.10 with CANopen® fieldbus module in [I/O profile] IO configuration
[C211]... [C215]	C211...C215	Virtual digital input CMD2.11...CMD2.15 with CANopen® fieldbus module regardless of configuration
[C301]... [C310]	C301...C310	Virtual digital input CMD3.01...CMD3.10 with a fieldbus module in [I/O profile] IO configuration
[C311]... [C315]	C311...C315	Virtual digital input CMD3.11...CMD3.15 with a fieldbus module regardless of configuration
[C501]... [C510]	C501...C510	Virtual digital input CMD5.01...CMD5.10 with integrated Ethernet in [I/O profile] IO configuration <b>NOTE:</b> This selection can be accessed on ATV340••N4E drives.
[C511]... [C515]	C511...C515	Virtual digital input CMD5.11...CMD5.15 with integrated Ethernet regardless of configuration <b>NOTE:</b> This selection can be accessed on ATV340••N4E drives.

### [4 PID Preset Assign] PR4

Identical to [2 PID Preset Assign] PR2 , page 326.

Verify that [2 PID Preset Assign] PR2 has been assigned before assigning this function.

**[Ref PID Preset 2] RP2 ★**

Second PID preset reference.

This parameter can be accessed only if **[2 PID Preset Assign] PR2** is assigned.

Setting ( )	Description
<b>[Min PID Process] PIP1...[Max PID Process] PIP2</b>	Setting range <b>Factory setting: 300</b>

**[Ref PID Preset 3] RP3 ★**

Third PID preset reference.

This parameter can be accessed only if **[4 PID Preset Assign] PR4** is assigned.

Setting ( )	Description
<b>[Min PID Process] PIP1...[Max PID Process] PIP2</b>	Setting range <b>Factory setting: 600</b>

**[Ref PID Preset 4] RP4 ★**

Fourth PID preset reference.

This parameter can be accessed only if **[4 PID Preset Assign] PR4** and **[2 PID Preset Assign] PR2** are assigned.

Setting ( )	Description
<b>[Min PID Process] PIP1...[Max PID Process] PIP2</b>	Setting range <b>Factory setting: 900</b>

## [PID Reference] RF – Menu

### Access

[Complete settings] → [Generic functions] → [PID controller] → [PID Reference]

### [Predictive Speed Ref] FPI ★

This parameter can be accessed if [Access Level] LAC is set to [Expert] EPR.

Setting	Code / Value	Description
[Not Configured]	NO	Not assigned <b>Factory setting</b>
[AI1]...[AI3]	AI1...AI3	Analog input AI1...AI3
[AI4]...[AI5]	AI4...AI5	Analog input AI4...AI5 if VW3A3203 I/O extension module has been inserted
[HMI]	LCC	Reference frequency via remote terminal
[Ref. Freq-Modbus]	MDB	Reference frequency via Modbus
[Ref. Freq-CANopen]	CAN	Reference frequency via CANopen
[Ref. Freq-Com. Module]	NET	Reference frequency via communication module
[RP]	PI	Pulse input <b>NOTE:</b> This selection can be accessed on drives with a power below than 30 kW.
[Embedded Ethernet]	ETH	Embedded Ethernet <b>NOTE:</b> This selection can be accessed on ATV340...N4E drives.
[Encoder]	PG	Encoder reference if an encoder module has been inserted or embedded encoder is used. <b>NOTE:</b> Embedded encoder is only available on drives with power up to 22kW.

### [Speed input %] PSR ★

#### *PID speed input % ref.*

This parameter can be accessed if [Access Level] LAC is set to [Expert] EPR.

Setting ( )	Description
1...100%	Setting range <b>Factory setting:</b> 100%



## [Settings] ST – Menu

### Access

[Complete settings] → [Generic functions] → [PID controller] → [Settings]

### About This Menu

Following parameters can be accessed if [PID feedback Assign] PIF is not set to [Not Configured] NO.

**NOTE:** This function cannot be used with some other functions.

### [PID Prop.Gain] RPG ★

*PID Proportional gain.*

Setting ( )	Description
0.01...100.00	Setting range <b>Factory setting:</b> 1.00

### [PID Intgl.Gain] RIG ★

*PID controller integral gain.*

Setting ( )	Description
0.01...100.00	Setting range <b>Factory setting:</b> 1.00

### [PID derivative gain] RDG ★

*PID derivative gain.*

Setting ( )	Description
0.00...100.00	Setting range <b>Factory setting:</b> 0.00

### [PID ramp] PRP ★

PID acceleration/deceleration ramp, defined to go from [Min PID Process] PIP1 to [Max PID Process] PIP2 and conversely.

Setting ( )	Description
0.0...99.9 s	Setting range <b>Factory setting:</b> 0.0 s

### [PID Inversion] PIC ★

*PID inversion.*

Setting	Code / Value	Description
[No]	NO	No <b>Factory setting</b>
[Yes]	YES	Yes

### [PID Min Output] POL ★

*PID controller min. output* in Hz.

Setting ( )	Description
-599.0...599.0 Hz	Setting range <b>Factory setting:</b> 0.0 Hz

### [PID Max Output] POH ★

*PID controller max. output* in Hz.

Setting ( )	Description
	Setting range <b>Factory setting:</b> 60.0 Hz

### [PID error Warning] PER ★

*PID error warning.*

Setting ( )	Description
0...65,535	Setting range <b>Factory setting:</b> 100

### [PID Integral OFF] PIS ★

If the assigned input or bit is at 0, the function is inactive (the PID integral is enabled).

If the assigned input or bit is at 1, the function is active (the PID integral is disabled).

Value range	Code / Value	Description
[Not Assigned]	NO	Not assigned <b>Factory setting</b>
[DI1]...[DI8]	LI1...LI8	Digital input DI1...DI8 <b>NOTE:</b> DI8 selection can be accessed on drives with a power greater than 22kW.
[DI11]...[DI16]	LI11...LI16	Digital input DI11...DI16 if VW3A3203 I/O extension module has been inserted
[CD00]... [CD10]	CD00...CD10	Virtual digital input CMD.0...CMD.10 in [I/O profile] IO configuration
[CD11]... [CD15]	CD11...CD15	Virtual digital input CMD.11...CMD.15 regardless of configuration

Value range	Code / Value	Description
[C101]... [C110]	C101...C110	Virtual digital input CMD1.01...CMD1.10 with integrated Modbus Serial in [I/O profile] IO configuration
[C111]... [C115]	C111...C115	Virtual digital input CMD1.11...CMD1.15 with integrated Modbus Serial regardless of configuration
[C201]... [C210]	C201...C210	Virtual digital input CMD2.01...CMD2.10 with CANopen® fieldbus module in [I/O profile] IO configuration
[C211]... [C215]	C211...C215	Virtual digital input CMD2.11...CMD2.15 with CANopen® fieldbus module regardless of configuration
[C301]... [C310]	C301...C310	Virtual digital input CMD3.01...CMD3.10 with a fieldbus module in [I/O profile] IO configuration
[C311]... [C315]	C311...C315	Virtual digital input CMD3.11...CMD3.15 with a fieldbus module regardless of configuration
[C501]... [C510]	C501...C510	Virtual digital input CMD5.01...CMD5.10 with integrated Ethernet in [I/O profile] IO configuration <b>NOTE:</b> This selection can be accessed on ATV340...N4E drives.
[C511]... [C515]	C511...C515	Virtual digital input CMD5.11...CMD5.15 with integrated Ethernet regardless of configuration <b>NOTE:</b> This selection can be accessed on ATV340...N4E drives.

### [PID acceleration time] ACCP ★

PID start ramp can be applied before starting the PID controller to allow reaching quickly the PID reference without increasing PID gains.

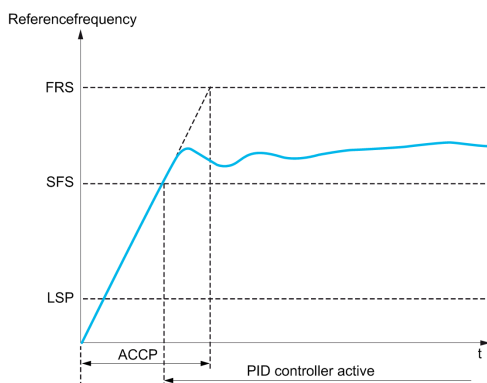

Setting ( )	Description
0.01...99.99 s	Setting range <b>Factory setting:</b> 5.00 s
(1) Range 0.01 to 99.99 s or 0.1 to 999.9 s or 1 to 6,000 according to [Ramp increment] INR	

### [PID Start Ref Freq] SFS ★

**PID start ref frequency.**

Setting ( )	Description
0.0...599.0 Hz	Setting range If [PID Start Ref Freq] SFS is lower than [Low Speed] LSP, this function has no effect. <b>Factory setting:</b> 0.0 Hz



## [Generic functions] - [Threshold reached]

### [Threshold reached] THRE- Menu

#### Access

[Complete settings] → [Generic functions] → [Threshold reached]

#### [Low I Threshold] CTDL

Current low threshold value (for [Low Current Reached] CTAL warning).

Setting ( )	Description
0...65,535 A	Setting range Factory setting: 0 A

#### [High Current Thd] CTD

Current high threshold value (for [Current Thd Reached] CTA warning).

Setting ( )	Description
0...65,535 A	Setting range Factory setting: Drive nominal current

#### [Low Freq.Threshold] FTDL

Motor low frequency threshold (for [Mot Freq Low Thd] FTAL warning).

Setting ( )	Description
0.0...599.0 Hz	Setting range Factory setting: 0.0 Hz

#### [Motor Freq Thd] FTD

Motor frequency threshold (for [Mot Freq High Thd] FTA warning).

Setting ( )	Description
0.0...599.0 Hz	Setting range Factory setting: 50.0 Hz

#### [2 Freq. Threshold] F2DL

Motor low frequency second threshold (for [Mot Freq Low Thd 2] F2AL warning).

Setting ( )	Description
0.0...599.0 Hz	Setting range Factory setting: 0.0 Hz

**[Freq. threshold 2] F2D**

Motor frequency threshold 2 (for **[Mot Freq High Thd 2] F2A** warning).

Setting ( )	Description
0.0...599.0 Hz	Setting range <b>Factory setting:</b> 50.0 Hz

**[Motor Therm Thd] TTD**

Motor thermal state threshold (for **[Motor Therm Thd reached] TSA** warning).

Setting ( )	Description
0...118%	Setting range <b>Factory setting:</b> 100%

**[Motor2 Therm Thd] TTD2**

Motor 2 thermal state threshold (for **[Mot2 Therm Thd reached] TS2** warning).

Setting ( )	Description
0...118%	Setting range <b>Factory setting:</b> 100%

**[Motor3 Therm Thd] TTD3**

Motor 3 thermal state threshold (for **[Mot3 Therm Thd reached] TS3** warning).

Setting ( )	Description
0...118%	Setting range <b>Factory setting:</b> 100%

**[Motor4 Therm Thd] TTD4**

Motor 4 thermal state threshold (for **[Mot4 Therm Thd reached] TS4** warning).

Setting ( )	Description
0...118%	Setting range <b>Factory setting:</b> 100%

**[Reference high Thd] RTD**

Reference frequency high threshold (for **[Ref Freq High Thd reached] RTAH** warning).

Setting ( )	Description
0.0...599.0 Hz	Setting range <b>Factory setting:</b> 0.0 Hz

### [Reference low Thd] RTDL

Reference frequency low threshold (for [Ref Freq Low Thd reached] RTAL warning).

Setting ( )	Description
0.0...599.0 Hz	Setting range <b>Factory setting:</b> 0.0 Hz

### [High torque thd.] TTH

High torque threshold (for [High Torque Warning] TTHA warning).

Setting ( )	Description
-300...300%	Setting range <b>Factory setting:</b> 100%

### [Low torque thd.] TTL

Low torque threshold (for [Low Torque Warning] TTLA warning).

Setting ( )	Description
-300...300%	Setting range <b>Factory setting:</b> 50%

# [Generic functions] - [Mains contactor command]

## [Mains contactor command] LLC- Menu

### Access

[Complete settings] → [Generic functions] → [Mains contactor command]

### About This Menu

The line contactor closes every time a run command (forward or reverse) is sent and opens after every stop, as soon as the drive is locked. For example, if the stop mode is stop on ramp, the contactor opens when the motor reaches zero speed.

**NOTE:** The drive control power supply must be provided via an external 24 Vdc source.

<b>NOTICE</b>
<b>RISK OF DAMAGE TO THE DRIVE</b>
Do not switch on the drive at intervals of less than 60 s.
<b>Failure to follow these instructions can result in equipment damage.</b>

Example circuit (24 Vdc power supply):

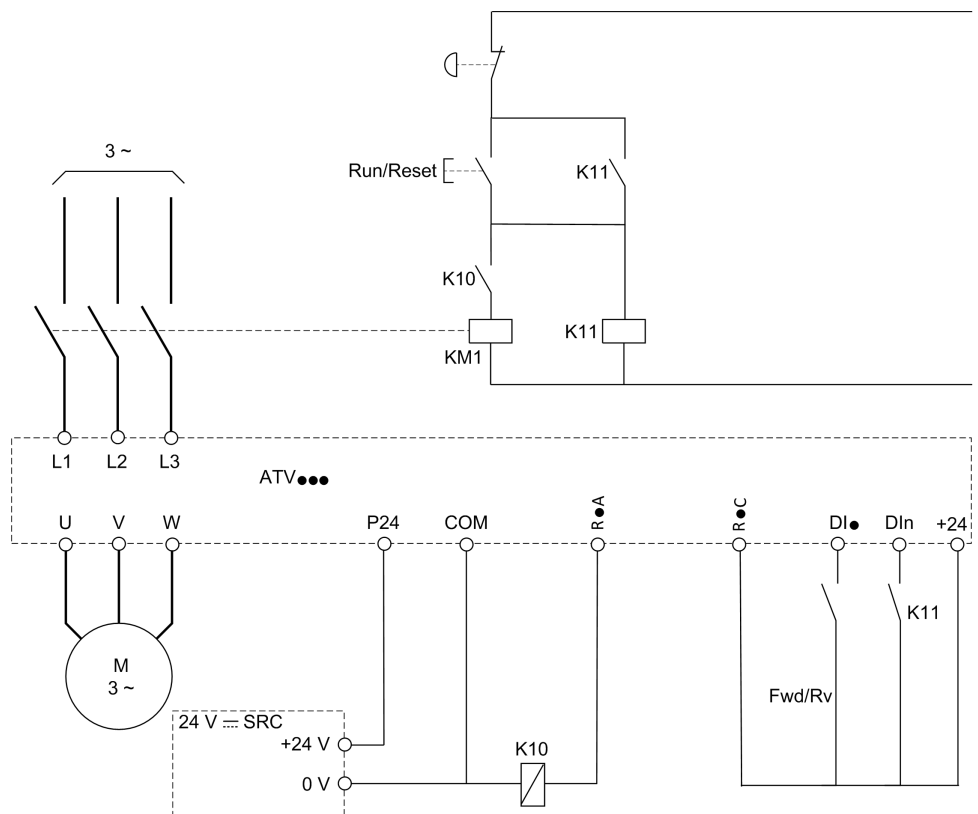

DI• = Run command [Forward] FRD or [Reverse Assign] RRS

R•A/R•C = [Mains Contactor] LLC

DIIn = [Device Lock] LES

**NOTE:** The Run/Reset key must be pressed once the emergency stop key has been released.



## [Mains Contactor] LLC

### Mains contactor control.

Setting	Code / Value	Description
[No]	NO	Not assigned <b>Factory setting</b>
[R2]...[R3]	R2...R3	Relay output R2...R3 <b>NOTE:</b> R3 selection can be accessed on drives with a power greater than 22 kW.
[R4]...[R6]	R4...R6	Relay output R4...R6 if VW3A3204 relay output option module has been inserted
[DQ11 Digital Output]... [DQ12 Digital Output]	DO11...DO12	Digital output DQ11...DQ12 if VW3A3203 I/O extension module has been inserted
[DQ1 Digital Output]... [DQ2 Digital Output]	DO1...DO2	Digital output DQ1...DQ2 <b>NOTE:</b> DQ2 selection can be accessed on drives with a power below than 30 kW.

## [Device Lock] LES ★

This parameter can be accessed if [Mains Contactor] LLC is not set to [No] NO.

The drive locks when the assigned input or bit changes to 0.

Setting	Code / Value	Description
[Not Assigned]	NO	Not assigned <b>Factory setting</b>
[CD00]... [CD10]	CD00...CD10	Virtual digital input CMD.0...CMD.10 in [I/O profile] IO configuration
[CD11]... [CD15]	CD11...CD15	Virtual digital input CMD.11...CMD.15 regardless of configuration
[C101]... [C110]	C101...C110	Virtual digital input CMD1.01...CMD1.10 with integrated Modbus Serial in [I/O profile] IO configuration
[C111]... [C115]	C111...C115	Virtual digital input CMD1.11...CMD1.15 with integrated Modbus Serial regardless of configuration
[C201]... [C210]	C201...C210	Virtual digital input CMD2.01...CMD2.10 with CANopen® fieldbus module in [I/O profile] IO configuration
[C211]... [C215]	C211...C215	Virtual digital input CMD2.11...CMD2.15 with CANopen® fieldbus module regardless of configuration
[C301]... [C310]	C301...C310	Virtual digital input CMD3.01...CMD3.10 with a fieldbus module in [I/O profile] IO configuration
[C311]... [C315]	C311...C315	Virtual digital input CMD3.11...CMD3.15 with a fieldbus module regardless of configuration
[C501]... [C510]	C501...C510	Virtual digital input CMD5.01...CMD5.10 with integrated Ethernet in [I/O profile] IO configuration <b>NOTE:</b> This selection can be accessed on ATV340...N4E drives.
[C511]... [C515]	C511...C515	Virtual digital input CMD5.11...CMD5.15 with integrated Ethernet regardless of configuration <b>NOTE:</b> This selection can be accessed on ATV340...N4E drives.

Setting	Code / Value	Description
[DI1 (Low level)]...[DI8 (Low level)]	L1L...L8L	Digital input DI1...DI8 used at low level <b>NOTE:</b> DI8 low level selection can be accessed on drives with a power greater than 22kW.
[DI11 (Low level)]...[DI16 (Low level)]	L11L...L16L	Digital input DI11...DI16 used at low level if VW3A3203 I/O extension module has been inserted

## [Mains V. time out] LCT

### *Time-out after cont. activ..*

Setting	Description
1...999 s	Setting range <b>Factory setting:</b> 5 s

# [Generic functions] - [Output contactor cmd]

## [Output contactor cmd] OCC– Menu

### Access

[Complete settings] → [Generic functions] → [Output contactor cmd]

### About This Menu

This function allows the drive to control and/or monitor a contactor installed between the drive and the motor.

The control of the output contactor by the drive is activated by assigning **[Out. Contactor Assign] OCC**. A request to close the contactor is done when a run command is activated. A request to open the contactor is done when no current is applied to the motor.

The monitoring of the output contactor by the drive is activated by assigning the feedback to **[Output contact fdbk] RCA**. In the event of an inconsistency, the drive triggers:

- **[Out Contact Opened Error] FCF2** error, if the **[Output contact fdbk] RCA** is not closed before the end of **[Delay to motor run] DBS** or if the **[Output contact fdbk] RCA** opens if the motor is running.
- **[Out Contact Closed Error] FCF1** error, if **[Output contact fdbk] RCA** is not opened before the end of **[Delay to open cont.] DAS** or if the **[Output contact fdbk] RCA** closes if the motor is stopped.

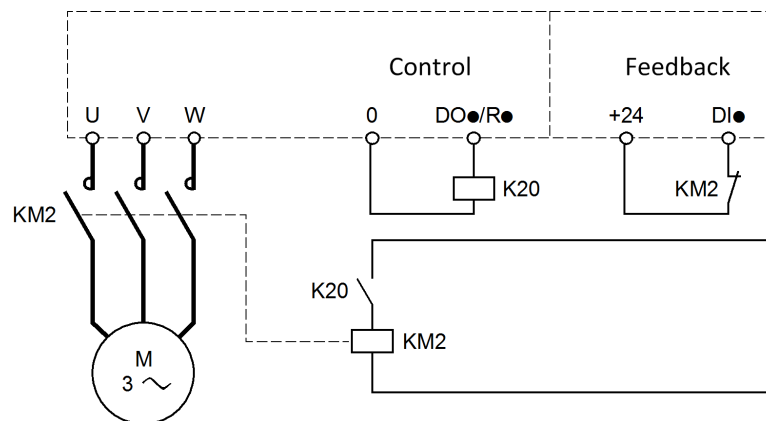

#### NOTE:

- **[Out Contact Opened Error] FCF2** error can be cleared by a transition from 1 to 0 of the run command.
- **[Out. Contactor Assign] OCC** and **[Output contact fdbk] RCA** can be used individually.
- If the DC injection braking function is used, the output contactor does not close as long as DC injection braking is active

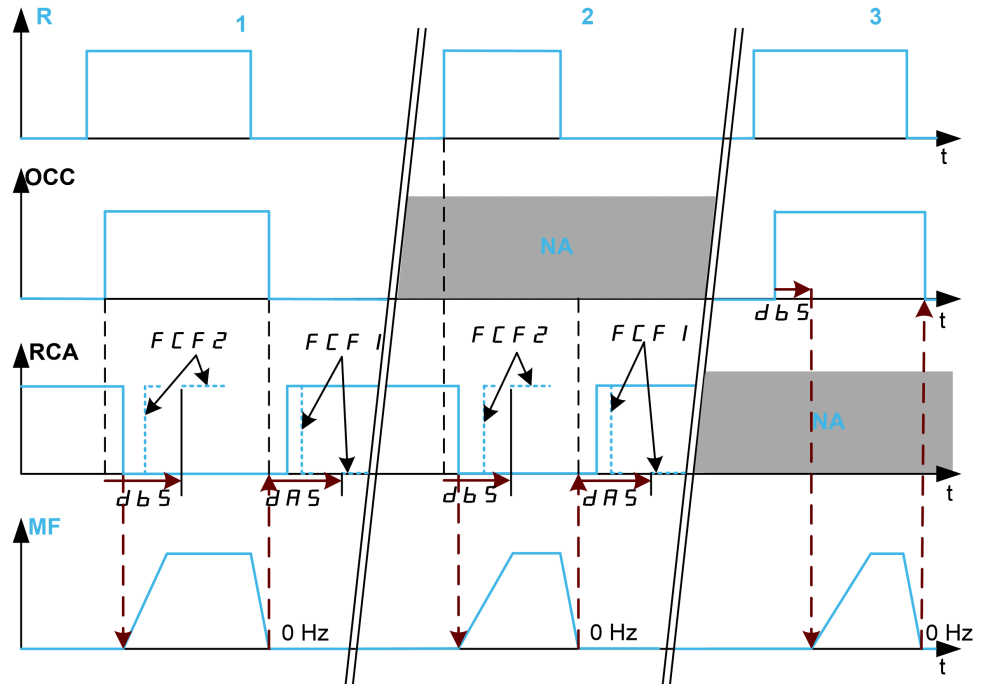

- 1 OCC and RCA assigned
- 2 RCA assigned
- 3 OCC assigned
- t Time
- R Run command
- OCC Output contactor
- RCA Output contactor feedback
- NA Not Assigned
- MF Motor frequency

## [Out. Contactor Assign] OCC

### Output contactor control assignment.

Setting	Code / Value	Description
[No]	NO	Function not assigned. <b>Factory setting</b>
[R2]...[R3]	R2...R3	Relay output R2...R3 <b>NOTE:</b> R3 selection can be accessed on drives with a power higher than 22 kW.
[R4]...[R6]	R4...R6	Relay output R4...R6 if VW3A3204 relay output option module has been inserted.
[DQ1 Digital Output]... [DQ2 Digital Output]	DO1...DO2	Digital output DQ1...DQ2 <b>NOTE:</b> DQ2 selection can be accessed on drives with a power below than 30 kW.
[DQ11 Digital Output]... [DQ12 Digital Output]	DO11...DO12	Digital output DQ11...DQ12 if VW3A3203 I/O extension module has been inserted.

## [Output contact fdbk] RCA

The motor starts to run when the assigned digital input or bit switches to 0.

Setting	Code / Value	Description
[Not Assigned]	NO	Not assigned <b>Factory setting</b>
[DI1 (Low level)]...[DI8 (Low level)]	L1L...L8L	Digital input DI1...DI8 used at low level <b>NOTE:</b> <ul style="list-style-type: none"> <li>DI8 low level selection can be accessed on drives with a power higher than 22kW</li> <li>On drives with a power lower than 30 kW, DI6 and DI7 respectively correspond to DQ1 and DQ2 used as digital inputs through the wiring.</li> </ul>
[DI11 (Low level)]...[DI16 (Low level)]	L11L...L16L	Digital input DI11...DI16 used at low level if VW3A3203 I/O extension module has been inserted
[C101]...[C110]	C101...C110	Virtual digital input CMD1.01...CMD1.10 with integrated Modbus Serial in [I/O profile] IO configuration
[C111]...[C115]	C111...C115	Virtual digital input CMD1.11...CMD1.15 with integrated Modbus Serial regardless of configuration
[C201]...[C210]	C201...C210	Virtual digital input CMD2.01...CMD2.10 with CANopen® fieldbus module in [I/O profile] IO configuration
[C211]...[C215]	C211...C215	Virtual digital input CMD2.11...CMD2.15 with CANopen® fieldbus module regardless of configuration
[C301]...[C310]	C301...C310	Virtual digital input CMD3.01...CMD3.10 with a fieldbus module in [I/O profile] IO configuration
[C311]...[C315]	C311...C315	Virtual digital input CMD3.11...CMD3.15 with a fieldbus module regardless of configuration
[C501]...[C510]	C501...C510	Virtual digital input CMD5.01...CMD5.10 with integrated Ethernet in [I/O profile] IO configuration <b>NOTE:</b> This selection can be accessed on ATV340...N4E drives.
[C511]...[C515]	C511...C515	Virtual digital input CMD5.11...CMD5.15 with integrated Ethernet regardless of configuration <b>NOTE:</b> This selection can be accessed on ATV340...N4E drives.

## [Delay to motor run] DBS

### Delay to close o/p cont..

This parameter delays:

- Motor control following the sending of a run command when the drive only monitors the output contactor.
- The [Out Contact Opened Error] FCF2 error monitoring if the [Output contact fdbk] RCA is assigned.

The time delay must be greater than the closing time of the output contactor.

This parameter can be accessed if [Out. Contactor Assign] OCC or [Output contact fdbk] RCA is assigned.

Setting	Description
0.05...60.00 s	Setting range <b>Factory setting:</b> 0.15 s

## [Delay to open cont.] DAS

This delay must be greater than the opening time of the output contactor.

If the value of digital input assigned to the **[Output contact fdbk]** [RCA](#) is not 0 at the end of this delay, **[Out Contact Closed Error]** [FCF1](#) error is triggered. If this parameter is set to 0, the **[Out Contact Closed Error]** [FCF1](#) error is not monitored.

This parameter can be accessed if **[Output contact fdbk]** [RCA](#) is assigned.

Setting	Description
0.00...5.00 s	Setting range <b>Factory setting:</b> 0.10 s

## [Generic functions] - [Reverse disable]

### [Reverse disable] REIN- Menu

#### Access

[Complete settings] → [Generic functions] → [Reverse disable]

#### [Reverse Disable] RIN

Reverse direction requests sent by digital inputs are taken into account.

Reverse direction requests sent by the Display Terminal or sent by the line are not taken into account.

Any reverse speed reference originating from the PID, summing input, and so on, is interpreted as a zero reference (0 Hz).

Setting	Code / Value	Description
[No]	NO	<p>Motor rotation direction is defined by the run command <b>[Forward] FRD</b> or <b>[Reverse Assign] RRS</b> and the sign of the reference frequency.</p> <p>When the reference frequency is positive and a:</p> <ul style="list-style-type: none"> <li>• <b>[Forward] FRD</b> run command is given: the motor starts in forward direction</li> <li>• <b>[Reverse Assign] RRS</b> run command is given: the motor starts in reverse direction</li> </ul> <p>When the reference frequency is negative and a:</p> <ul style="list-style-type: none"> <li>• <b>[Forward] FRD</b> run command is given: the motor starts in reverse direction</li> <li>• <b>[Reverse Assign] RRS</b> run command is given: the motor starts in forward direction</li> </ul>
[Yes]	YES	Any reverse speed reference originating from the PID, summing input, and so on, is interpreted as a zero reference (0 Hz).
[Absolute]	ABS	Motor rotation direction is defined by the run command <b>[Forward] FRD</b> or <b>[Reverse Assign] RRS</b> regardless of the sign of the reference frequency (i.e only the absolute value of the reference frequency is considered).

# [Generic functions] - [Torque limitation]

## [Torque limitation] TOL- Menu

### Access

[Complete settings] → [Generic functions] → [Torque limitation]

### About This Menu

There are 2 types of torque limitation:

- With a value that is fixed by a parameter (torque or power)
- With a value that is set by an analog input (AI or pulse)

If both types are enabled, the lowest value is taken into account.

These 2 types can be configured or switched remotely using a digital input or via the communication bus.

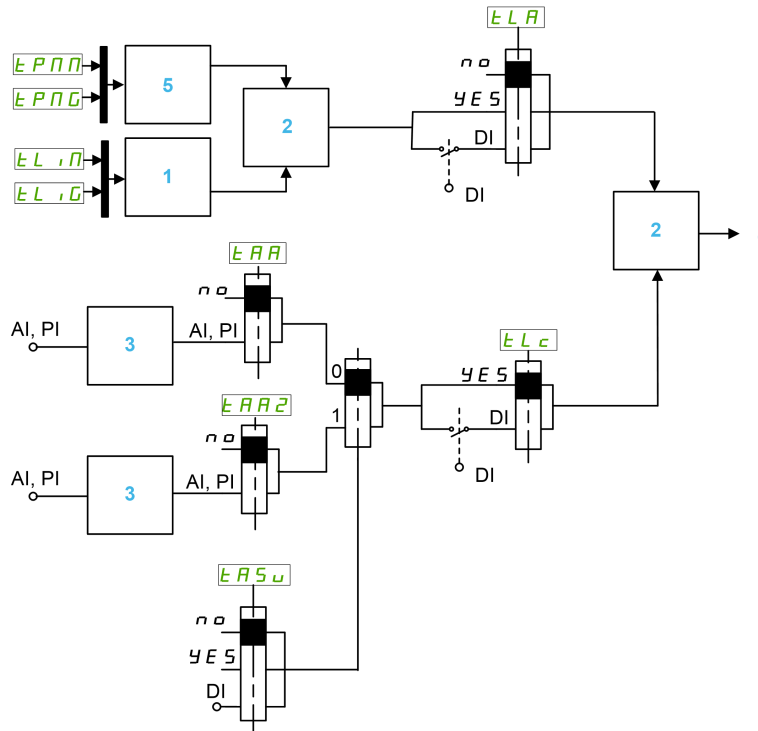

- 1 Torque limitation via parameter
- 2 Lowest value taken into account
- 3 Torque limitation via analog input, RP
- 4 Limitation value
- 5 Torque limitation via parameter in power

### [Torque limit activ.] TLA

Activation of the permanent torque limitation.

If the assigned input or bit is at 0, the function is inactive.

If the assigned input or bit is at 1, the function is active.



Setting	Code / Value	Description
[Not Assigned]	NO	Not assigned <b>Factory setting</b>
[Yes]	YES	Yes
[DI1]...[DI8]	LI1...LI8	Digital input DI1...DI8 <b>NOTE:</b> DI8 selection can be accessed on drives with a power greater than 22kW.
[DI11]...[DI16]	LI11...LI16	Digital input DI11...DI16 if VW3A3203 I/O extension module has been inserted
[CD00]... [CD10]	CD00...CD10	Virtual digital input CMD.0...CMD.10 in [I/O profile] IO configuration
[CD11]... [CD15]	CD11...CD15	Virtual digital input CMD.11...CMD.15 regardless of configuration
[C101]... [C110]	C101...C110	Virtual digital input CMD1.01...CMD1.10 with integrated Modbus Serial in [I/O profile] IO configuration
[C111]... [C115]	C111...C115	Virtual digital input CMD1.11...CMD1.15 with integrated Modbus Serial regardless of configuration
[C201]... [C210]	C201...C210	Virtual digital input CMD2.01...CMD2.10 with CANopen® fieldbus module in [I/O profile] IO configuration
[C211]... [C215]	C211...C215	Virtual digital input CMD2.11...CMD2.15 with CANopen® fieldbus module regardless of configuration
[C301]... [C310]	C301...C310	Virtual digital input CMD3.01...CMD3.10 with a fieldbus module in [I/O profile] IO configuration
[C311]... [C315]	C311...C315	Virtual digital input CMD3.11...CMD3.15 with a fieldbus module regardless of configuration
[C501]... [C510]	C501...C510	Virtual digital input CMD5.01...CMD5.10 with integrated Ethernet in [I/O profile] IO configuration <b>NOTE:</b> This selection can be accessed on ATV340...N4E drives.
[C511]... [C515]	C511...C515	Virtual digital input CMD5.11...CMD5.15 with integrated Ethernet regardless of configuration <b>NOTE:</b> This selection can be accessed on ATV340...N4E drives.

[Pmax Motor] TPMM ★

**Maximum power in motor mode.**

This parameter can be accessed if [Torque limit activ.] TLA is not set to [Not Assigned] NO.

Setting ( )	Description
10...300%	Setting range <b>Factory setting:</b> 300%

[Pmax Generator] TPMG ★

**Maximum power in generator mode.**

This parameter can be accessed if [Torque limit activ.] TLA is not set to [Not Assigned] NO.

Setting ( )	Description
10...300%	Setting range <b>Factory setting:</b> 300%

**[Torque increment] INTP** ★

This parameter can be accessed if **[Torque limit activ.] TLA** is not set to **[Not Assigned] NO**.

Selection of units for the **[Gen. torque limit] TLIG** and **[Motor torque limit] TLIM** parameters.

Setting	Code / Value	Description
[0.1%]	01	Unit 0.1%
[1%]	1	Unit 1% <b>Factory setting</b>

**[Motor torque limit] TLIM** ★

This parameter can be accessed if **[Torque limit activ.] TLA** is not set to **[Not Assigned] NO**.

Torque limitation in motor mode, as a % or in 0.1% increments of the rated torque in accordance with the **[Torque increment] INTP** parameter.

Setting ( )	Description
0...300%	Setting range <b>Factory setting: 100%</b>

**[Gen. torque limit] TLIG** ★

This parameter can be accessed if **[Torque limit activ.] TLA** is not set to **[Not Assigned] NO**.

Torque limitation in generator mode, as a % or in 0.1% increments of the rated torque in accordance with the **[Torque increment] INTP** parameter.

Setting ( )	Description
0...300%	Setting range <b>Factory setting: 100%</b>

**[Analog limit activ.] TLC** ★

Activation (analog input) by a digital input.

This parameter can be accessed if **[Ref Torque Assign] TAA** or **[Ref Torque 2 Assign] TAA2** is configured.

Identical to **[Torque limit activ.] TLA**.

If the assigned input or bit is at 0:

- The limitation is specified by the **[Motor torque limit] TLIM** and **[Gen. torque limit] TLIG** parameters if **[Torque limit activ.] TLA** is not set to **[Not Assigned] NO**.
- No limitation if **[Torque limit activ.] TLA** is not set to **[Not Assigned] NO**.

If the assigned input or bit is at 1: the limitation depends on the input assigned by **[Ref Torque Assign] TAA** or **[Ref Torque 2 Assign] TAA2**.

**NOTE:** If both limitation (by input assigned and parameter) are enabled at the same time, the lowest value is taken into account.

## [Ref Torque Assign] TAA

Activation by an analog value.

If the function is assigned, the limitation varies between 0% and 300% of the rated torque based on the 0% to 100% signal applied to the assigned input.

Examples: 12 mA on a 4-20 mA input results in a limitation to 150% of the rated torque  
2.5 Vdc on a 10 Vdc input results in 75% of the rated torque.

Setting	Code / Value	Description
[Not Configured]	NO	Analog input is not assigned <b>Factory setting</b>
[AI1]...[AI3]	AI1...AI3	Analog input AI1...AI3
[AI4]...[AI5]	AI4...AI5	Analog input AI4...AI5 if VW3A3203 I/O extension module has been inserted
[AI Virtual 1]	AIV1	Virtual analogic input 1
[DI7 PulseInput]... [DI8 PulseInput]	PI7...PI8	Digital input DI7...DI8 used as pulse input <b>NOTE:</b> This selection can be accessed on drives with a power greater than 22kW.
[RP]	PI	Pulse input <b>NOTE:</b> This selection can be accessed on drives with a power below than 30 kW.
[Encoder]	PG	Encoder reference if an encoder module has been inserted or embedded encoder is used. <b>NOTE:</b> Embedded encoder is only available on drives with power up to 22kW.

## [Ref Torque Switch Assign] TASU

Reference torque switch assignment.

This parameter can be accessed if [Ref Torque Assign] TAA or [Ref Torque 2 Assign] TAA2 are not set to [Not Configured] NO.

Identical to [Torque limit activ.] TLA.

## [Ref Torque 2 Assign] TAA2

Activation by another analog value.

Identical to [Ref Torque Assign] TAA.

## [Trq/I limit. stop] SSB

*Stop type - torque/I limit.*

Setting	Code / Value	Description
[Ignore]	NO	Detected error ignored <b>Factory setting</b>
[Freewheel Stop]	YES	Freewheel stop
[Per STT]	STT	Stop according to [Type of stop] STT parameter but without an error triggered after stop
[Fallback Speed]	LFF	Change to fallback speed, maintained as long as the detected error persists and the run command has not been removed <sup>(1)</sup>

Setting	Code / Value	Description
[Speed maintained]	RLS	The drive maintains the speed being applied when the detected error occurred, as long as the detected error is active and the run command has not been removed <sup>(1)</sup> .
[Ramp stop]	RMP	Stop on ramp
[Fast stop]	FST	Fast stop
[DC injection]	DCI	DC injection
<sup>1</sup> Because, in this case, the detected error does not trigger a stop, it is recommended to assign a relay or logic output to its indication.		

## [Trq/I Limit Timeout] STO

Torque current limitation: [Torque Limitation Error] SSF error delay and [Torque Limit Reached] SSA warning delay.

Setting 	Description
0...9,999 ms	Setting range <b>Factory setting:</b> 1,000 ms

## [Generic functions] - [2nd current limit.]

### [2nd current limit.] CLI- Menu

#### Access

[Complete settings] → [Generic functions] → [2nd current limit.]

### [Current Limitation2] LC2

If the assigned input or bit is at 0, the first current limitation is active.

If the assigned input or bit is at 1, the second current limitation is active.

Value range	Code / Value	Description
[Not Assigned]	NO	Not assigned <b>Factory setting</b>
[DI1]...[DI8]	LI1...LI8	Digital input DI1...DI8 <b>NOTE:</b> DI8 selection can be accessed on drives with a power greater than 22kW.
[DI11]...[DI16]	LI11...LI16	Digital input DI11...DI16 if VW3A3203 I/O extension module has been inserted
[CD00]... [CD10]	CD00...CD10	Virtual digital input CMD.0...CMD.10 in <b>[I/O profile]</b> IO configuration
[CD11]... [CD15]	CD11...CD15	Virtual digital input CMD.11...CMD.15 regardless of configuration
[C101]... [C110]	C101...C110	Virtual digital input CMD1.01...CMD1.10 with integrated Modbus Serial in <b>[I/O profile]</b> IO configuration
[C111]... [C115]	C111...C115	Virtual digital input CMD1.11...CMD1.15 with integrated Modbus Serial regardless of configuration
[C201]... [C210]	C201...C210	Virtual digital input CMD2.01...CMD2.10 with CANopen® fieldbus module in <b>[I/O profile]</b> IO configuration
[C211]... [C215]	C211...C215	Virtual digital input CMD2.11...CMD2.15 with CANopen® fieldbus module regardless of configuration
[C301]... [C310]	C301...C310	Virtual digital input CMD3.01...CMD3.10 with a fieldbus module in <b>[I/O profile]</b> IO configuration
[C311]... [C315]	C311...C315	Virtual digital input CMD3.11...CMD3.15 with a fieldbus module regardless of configuration
[C501]... [C510]	C501...C510	Virtual digital input CMD5.01...CMD5.10 with integrated Ethernet in <b>[I/O profile]</b> IO configuration <b>NOTE:</b> This selection can be accessed on ATV340...N4E drives.
[C511]... [C515]	C511...C515	Virtual digital input CMD5.11...CMD5.15 with integrated Ethernet regardless of configuration <b>NOTE:</b> This selection can be accessed on ATV340...N4E drives.

### [Current Limit2 Value] CL2 ★

This parameter can be accessed if **[Current Limitation2] LC2** is not set to **[Not Assigned] NO**.

## NOTICE

### OVERHEATING

- Verify that the motor is properly rated for the maximum current to be applied to the motor.
- Consider the duty cycle of the motor and all factors of your application including derating requirements in determining the current limit.

**Failure to follow these instructions can result in equipment damage.**

The adjustment range is limited to 1.8 In.

**NOTE:** If the setting is less than 0.25 In, the drive may lock in **[OutPhaseLoss Assign]** OPL if this has been enabled. If it is less than the no-load motor current, the motor cannot run.

Setting ( )	Description
0...1.8 In <sup>(1)</sup>	Setting range <b>Factory setting:</b> 1.8 In <sup>(1)</sup>
<b>(1)</b> IN corresponds to the rated drive current indicated in the Installation Manual and on the drive nameplate.	

## [Current Limitation] CLI ★

### Current limitation.

## NOTICE

### OVERHEATING

- Verify that the motor is properly rated for the maximum current to be applied to the motor.
- Consider the duty cycle of the motor and all factors of your application including derating requirements in determining the current limit.

**Failure to follow these instructions can result in equipment damage.**

The adjustment range is limited to 1.8 In.

**NOTE:** If the setting is less than 0.25 In, the drive may lock in **[OutPhaseLoss Assign]** OPL if this has been enabled. If it is less than the no-load motor current, the motor cannot run.

Setting ( )	Description
0...1.8 In <sup>(1)</sup>	Setting range <b>Factory setting:</b> 1.8 In <sup>(1)</sup>
<b>(1)</b> IN corresponds to the rated drive current indicated in the Installation Manual and on the drive nameplate.	

## [Generic functions] - [Jog]

### [Jog] JOG- Menu

#### Access

[Complete settings] → [Generic functions] → [Jog]

### [Jog Assign] JOG

The JOG function is only active if the command channel and the reference channels are on the terminals.

This function can be used if:

- **[PID feedback Assign]** PIF is set to **[Not Configured]** NO, and
- **[Brake assignment]** BLC is set to **[No]** NO, and
- **[High speed hoisting]** HSO is set to **[No]** NO, and
- **[+ Speed Assign]** USI and **[- Speed Assign]** DSI are set to **[Not Assigned]** NO, and
- **[Ref Freq 2 Config]** FR2 is set to **[Ref Frequency via DI]** UPDT.

The function is active when the assigned input or bit is at 1.

Example: 2-wire control operation (**[2/3-Wire Control]** TCC = **[2-Wire Control]** 2C).

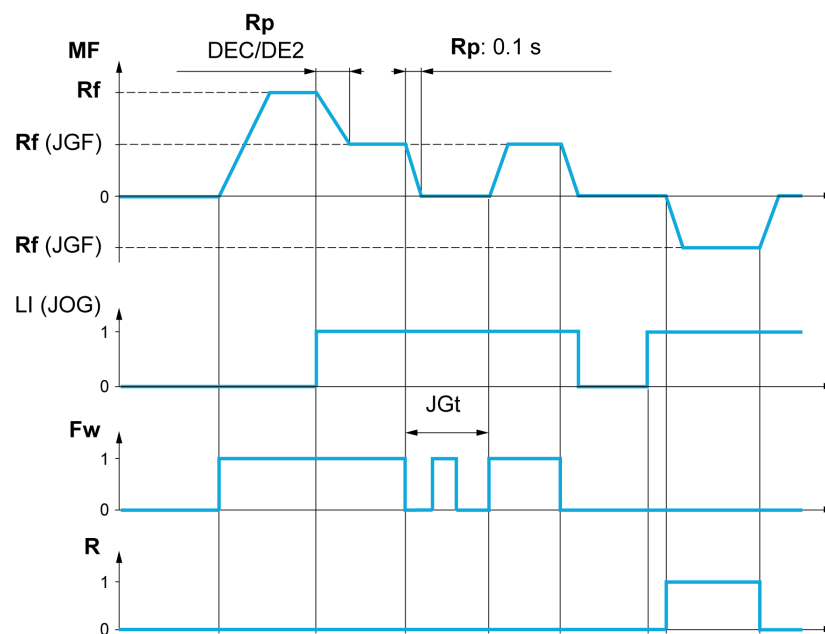

**MF** Motor frequency

**Rf** Reference

**Rp** Ramp

**Rp: 0.1 s** Ramp forced to 0.1 S

**Fw** Forward

**R** Reverse

Value range	Code / Value	Description
[Not Assigned]	NO	Not assigned <b>Factory setting</b>
[DI1]...[DI8]	LI1...LI8	Digital input DI1...DI8 <b>NOTE:</b> DI8 selection can be accessed on drives with a power greater than 22kW.
[DI11]...[DI16]	LI11...LI16	Digital input DI11...DI16 if VW3A3203 I/O extension module has been inserted
[CD00]... [CD10]	CD00...CD10	Virtual digital input CMD.0...CMD.10 in [I/O profile] IO configuration
[CD11]... [CD15]	CD11...CD15	Virtual digital input CMD.11...CMD.15 regardless of configuration
[C101]... [C110]	C101...C110	Virtual digital input CMD1.01...CMD1.10 with integrated Modbus Serial in [I/O profile] IO configuration
[C111]... [C115]	C111...C115	Virtual digital input CMD1.11...CMD1.15 with integrated Modbus Serial regardless of configuration
[C201]... [C210]	C201...C210	Virtual digital input CMD2.01...CMD2.10 with CANopen® fieldbus module in [I/O profile] IO configuration
[C211]... [C215]	C211...C215	Virtual digital input CMD2.11...CMD2.15 with CANopen® fieldbus module regardless of configuration
[C301]... [C310]	C301...C310	Virtual digital input CMD3.01...CMD3.10 with a fieldbus module in [I/O profile] IO configuration
[C311]... [C315]	C311...C315	Virtual digital input CMD3.11...CMD3.15 with a fieldbus module regardless of configuration
[C501]... [C510]	C501...C510	Virtual digital input CMD5.01...CMD5.10 with integrated Ethernet in [I/O profile] IO configuration <b>NOTE:</b> This selection can be accessed on ATV340••N4E drives.
[C511]... [C515]	C511...C515	Virtual digital input CMD5.11...CMD5.15 with integrated Ethernet regardless of configuration <b>NOTE:</b> This selection can be accessed on ATV340••N4E drives.

## [Jog Frequency] JGF ★

This parameter can be accessed if [Jog Assign] JOG is not set to [Not Assigned] NO.

Setting ( )	Description
0.0...10.0 Hz	Setting range <b>Factory setting:</b> 10.0 Hz

## [Jog Delay] JGT ★

This parameter can be accessed if [Jog Assign] JOG is not set to [Not Assigned] NO).

Setting ( )	Description
0.0...2.0 s	Setting range <b>Factory setting:</b> 0.5 s



## [Generic functions] - [High Speed Switching]

### [High Speed Switching] CHS– Menu

#### Access

[Complete settings] → [Generic functions] → [High Speed Switching]

#### [2 High speed] SH2

##### 2 high speed assign..

Setting	Code / Value	Description
[Not Assigned]	NO	Not assigned <b>Factory setting</b>
[Mot Freq High Thd]	F <sub>TA</sub>	Motor frequency high threshold reached
[Mot Freq High Thd 2]	F <sub>2A</sub>	Second frequency threshold reached
[DI1]...[DI8]	LI1...LI8	Digital input DI1...DI8 <b>NOTE:</b> DI8 selection can be accessed on drives with a power greater than 22kW.
[DI11]...[DI16]	LI11...LI16	Digital input DI11...DI16 if VW3A3203 I/O extension module has been inserted
[CD00]... [CD10]	CD00...CD10	Virtual digital input CMD.0...CMD.10 in <b>[I/O profile]</b> I/O configuration
[CD11]... [CD15]	CD11...CD15	Virtual digital input CMD.11...CMD.15 regardless of configuration
[C101]... [C110]	C101...C110	Virtual digital input CMD1.01...CMD1.10 with integrated Modbus Serial in <b>[I/O profile]</b> I/O configuration
[C111]... [C115]	C111...C115	Virtual digital input CMD1.11...CMD1.15 with integrated Modbus Serial regardless of configuration
[C201]... [C210]	C201...C210	Virtual digital input CMD2.01...CMD2.10 with CANopen® fieldbus module in <b>[I/O profile]</b> I/O configuration
[C211]... [C215]	C211...C215	Virtual digital input CMD2.11...CMD2.15 with CANopen® fieldbus module regardless of configuration
[C301]... [C310]	C301...C310	Virtual digital input CMD3.01...CMD3.10 with a fieldbus module in <b>[I/O profile]</b> I/O configuration
[C311]... [C315]	C311...C315	Virtual digital input CMD3.11...CMD3.15 with a fieldbus module regardless of configuration
[C501]... [C510]	C501...C510	Virtual digital input CMD5.01...CMD5.10 with integrated Ethernet in <b>[I/O profile]</b> I/O configuration <b>NOTE:</b> This selection can be accessed on ATV340...N4E drives.
[C511]... [C515]	C511...C515	Virtual digital input CMD5.11...CMD5.15 with integrated Ethernet regardless of configuration <b>NOTE:</b> This selection can be accessed on ATV340...N4E drives.

#### [4 High speed] SH4

4 High speed assign.

**NOTE:** In order to obtain 4 High speed, [2 High speed] SH2 must also be configured.

Identical to **[2 High speed]** SH2.

## [High Speed] HSP

Motor frequency at maximum reference, can be set between **[Low Speed]** LSP and **[Max Frequency]** TFR.

The factory setting changes to 60 Hz if **[Motor Standard]** BFR is set to **[60 Hz]** NEMA 60Hz.

To help prevent **[Motor Overspeed]** SOF error, it is recommended to have **[Max Frequency]** TFR equal to or higher than 110% of **[High Speed]** HSP.

Setting ( )	Description
0...599 Hz	Setting range Factory setting: 50 Hz

## [High speed 2] HSP2 ★

Visible if **[2 High speed]** SH2 is not set to **[Not Assigned]** NO.

Identical to **[High Speed]** HSP.

## [High speed 3] HSP3 ★

Visible if **[4 High speed]** SH4 is not set to **[Not Assigned]** NO.

Identical to **[High Speed]** HSP.

## [High speed 4] HSP4 ★

Visible if **[4 High speed]** SH4 is not set to **[Not Assigned]** NO.

Identical to **[High Speed]** HSP.

# [Generic functions] - [Memo reference frequency]

## [Memo reference frequency] SPM- Menu

### Access

[Complete settings] → [Generic functions] → [Memo reference frequency]

### About This Menu

Saving a speed reference value using a digital input command lasting longer than 0.1 s.

- This function is used to control the speed of several drives alternately via a single analog reference and one digital input for each drive.
- It is also used to confirm a line reference (communication bus or network) on several drives via a digital input. This allows movements to be synchronized by getting rid of variations when the reference is set.
- The reference is acquired 100 ms after the rising edge of the request. A new reference is not then acquired until a new request is made.

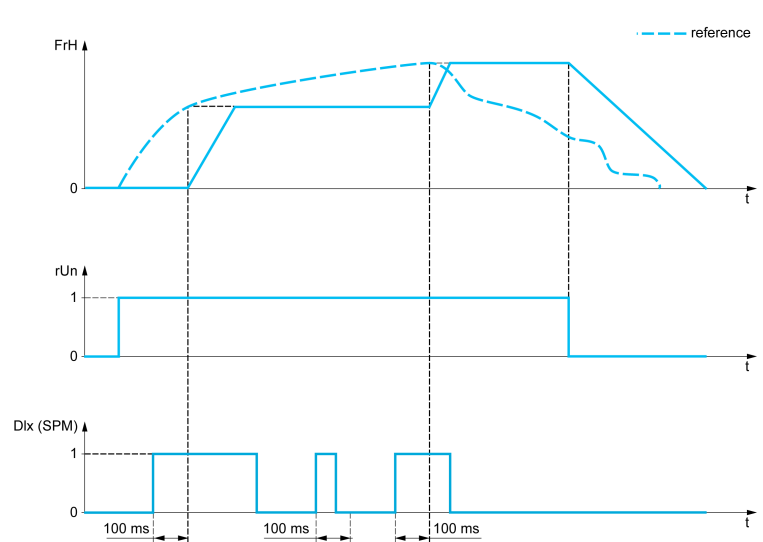

**FrH** Reference frequency before ramp

**rUn** Run command

**DIx (SPM)** [Ref Freq Memo assign] SPM

## [Ref Freq Memo assign] SPM

### Reference frequency memory assignment.

Function active if the assigned input is at active state.

Setting	Code / Value	Description
[Not Assigned]	NO	Not assigned <b>Factory setting</b>
[DI1]...[DI8]	LI1...LI8	Digital input DI1...DI8 <b>NOTE:</b> DI8 selection can be accessed on drives with a power greater than 22kW.
[DI11]...[DI16]	LI11...LI16	Digital input DI11...DI16 if VW3A3203 I/O extension module has been inserted

## [Generic functions] - [Brake logic control]

### [Brake logic control] BLC- Menu

#### Access

[Complete settings] → [Generic functions] → [Brake logic control]

#### About This Menu

Identical to [Brake logic control] BLC- menu .

# [Generic functions] - [Limit switches]

## [Limit switches] LST- Menu

### Access

[Complete settings] → [Generic functions] → [Limit switches]

### About This Menu

This function can be used to manage trajectory limits using limit switches

The stop mode is configurable. When the stop contact is activated, startup in the other direction is authorized.

Example:

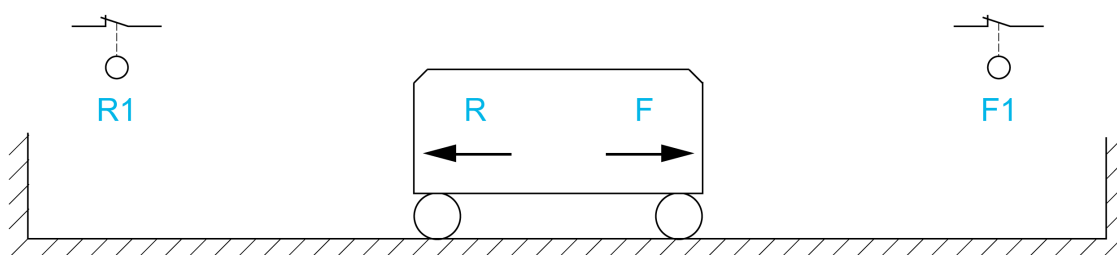

R Reverse

R1 Reverse stop

F Forward

F1 Forward stop

The stop is activated when the input is at 0 (contact open).

## [Stop FW assign] LAF

### Stop forward limit assignment.

Setting	Code / Value	Description
[Not Assigned]	NO	Not assigned <b>Factory setting</b>
[CD00]... [CD10]	CD00...CD10	Virtual digital input CMD.0...CMD.10 in [I/O profile] IO configuration
[CD11]... [CD15]	CD11...CD15	Virtual digital input CMD.11...CMD.15 regardless of configuration
[C101]... [C110]	C101...C110	Virtual digital input CMD1.01...CMD1.10 with integrated Modbus Serial in [I/O profile] IO configuration
[C111]... [C115]	C111...C115	Virtual digital input CMD1.11...CMD1.15 with integrated Modbus Serial regardless of configuration
[C201]... [C210]	C201...C210	Virtual digital input CMD2.01...CMD2.10 with CANopen® fieldbus module in [I/O profile] IO configuration
[C211]... [C215]	C211...C215	Virtual digital input CMD2.11...CMD2.15 with CANopen® fieldbus module regardless of configuration
[C301]... [C310]	C301...C310	Virtual digital input CMD3.01...CMD3.10 with a fieldbus module in [I/O profile] IO configuration
[C311]... [C315]	C311...C315	Virtual digital input CMD3.11...CMD3.15 with a fieldbus module regardless of configuration

Setting	Code / Value	Description
[C501]... [C510]	C501...C510	Virtual digital input CMD5.01...CMD5.10 with integrated Ethernet in [I/O profile] IO configuration <b>NOTE:</b> This selection can be accessed on ATV340...N4E drives.
[C511]... [C515]	C511...C515	Virtual digital input CMD5.11...CMD5.15 with integrated Ethernet regardless of configuration <b>NOTE:</b> This selection can be accessed on ATV340...N4E drives.
[DI1 (Low level)]...[DI8 (Low level)]	L1L...L8L	Digital input DI1...DI8 used at low level <b>NOTE:</b> DI8 low level selection can be accessed on drives with a power greater than 22kW.
[DI11 (Low level)]...[DI16 (Low level)]	L11L...L16L	Digital input DI11...DI16 used at low level if VW3A3203 I/O extension module has been inserted

## [Stop RV assign] LAR

Stop reverse limit assignment.

Identical to [Stop FW assign] LAF.

## [Stop type] LAS

Stop type on limit switch.

This parameter can be accessed if [Stop FW assign] LAF or [Stop RV assign] LAR is assigned.

When the assigned input changes to 0, the stop is controlled in accordance with the selected type. Restarting is only authorized for the other operating direction once the motor has stopped. If the two inputs [Stop FW assign] LAF and [Stop RV assign] LAR are assigned and at state 0, restarting is not possible.

Setting	Code / Value	Description
[On Ramp]	RMP	Stop on ramp
[Fast stop]	FST	Fast stop
[Freewheel Stop]	NST	Freewheel stop <b>Factory setting</b>

## [Generic functions] - [Positioning by sensors]

### [Positioning by sensors] LPO- Menu

#### Access

[Complete settings] → [Generic functions] → [Positioning by sensors]

#### About This Menu

This function is used for managing positioning using position sensors or limit switches linked to digital inputs or using control word bits:

- Slowing down
- Stopping

The activation level for the inputs and bits can be configured on a rising edge (change from 0 to 1) or a falling edge (change from 1 to 0). The example below has been configured on a falling edge:

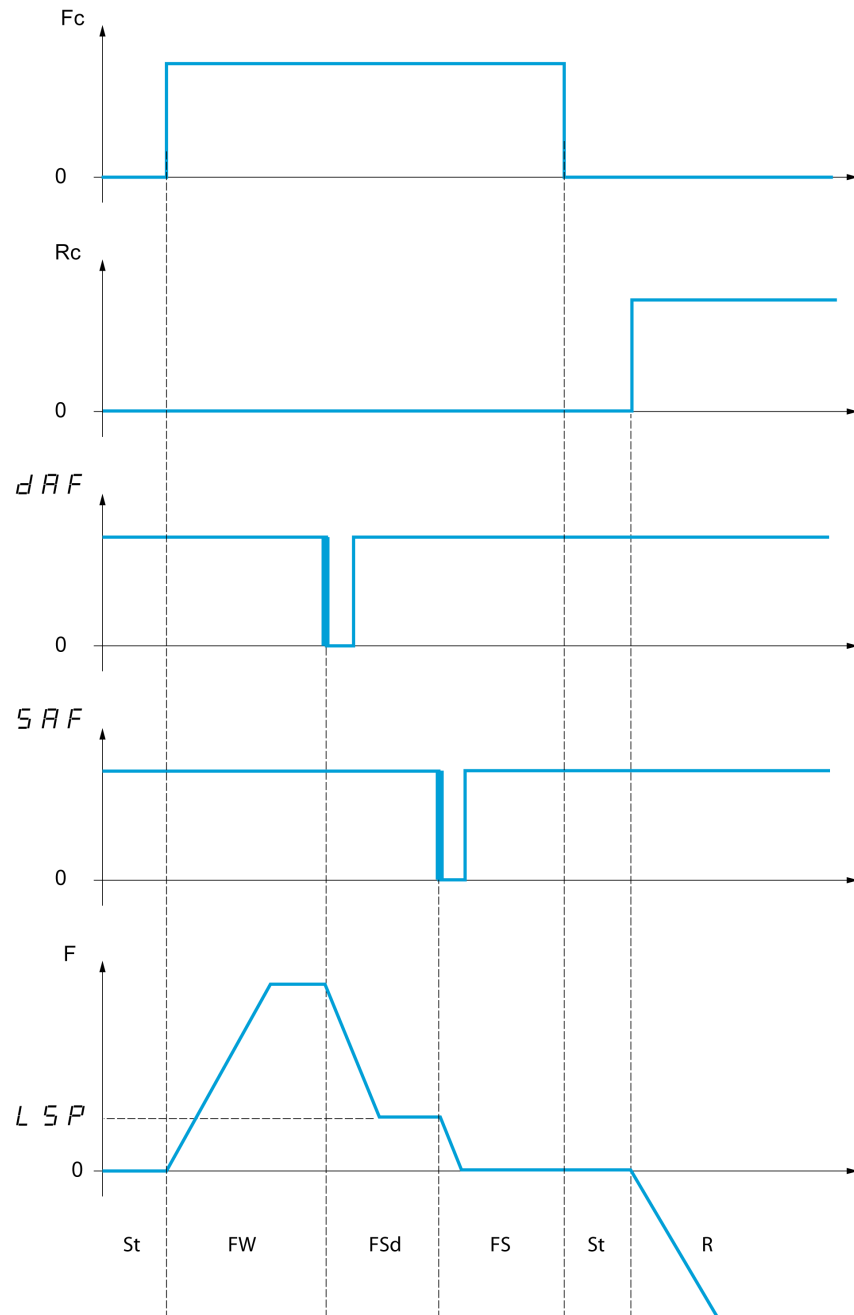

**Fc** Forward run command

**Rc** Reverse run command

**F** Frequency

**FW** Forward

**FSd** Forward Slowdown

**FS** Forward Stopping

**St** Stop

**R** Reverse

The slowdown mode and stop mode can be configured.

The operation is identical for both directions of operation. Slowdown and stopping operate according to the same logic, described below.

**Example: Forward slowdown, on falling edge**



- The forward slowdown takes place on a falling edge (switch from 1 to 0) of the input assigned to forward slowdown if it occurs in forward direction. The reference frequency value is limited to **[Low Speed]** *LSP*.
- In the forward slowdown area, the movement in the opposite direction is authorized at high speed.
- The slowdown command is deleted on a rising edge (switch from 0 to 1) of the input assigned to forward slowdown if it occurs in reverse direction.
- A forward slowdown is stored, even in the event of a power outage.
- A bit or a digital input can be assigned to disable this function.
- Although forward slowdown is disabled while the disable input or bit is at 1, sensor changes continue to be monitored and saved.

**Example: Positioning on a limit switch, on falling edge**

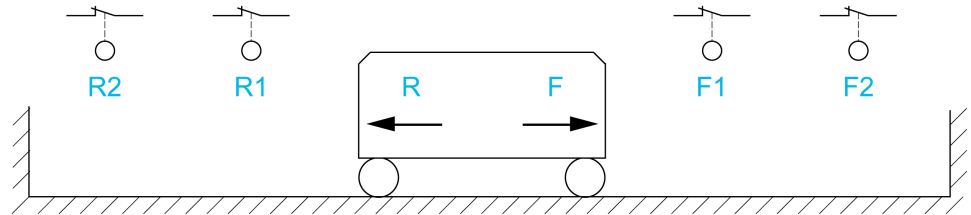

**R** Reverse

**R1** Reverse slowdown

**R2** Reverse stop

**F** Forward

**F1** Forward slowdown

**F2** Forward stop

## ⚠ WARNING

### LOSS OF CONTROL

- Verify correct connection of the limit switches.
- Verify the correct installation of the limit switches. The limit switches must be mounted in a position far enough away from the mechanical stop to allow for an adequate stopping distance.
- You must release the limit switches before you can use them.
- Verify the correct function of the limit switches.

**Failure to follow these instructions can result in death, serious injury, or equipment damage.**

**Operation with short cams:**

After the switches have been configured, the drive does not yet have a valid position.

## ⚠ WARNING

### LOSS OF CONTROL

- Verify that the drive is between the reverse deceleration switch and the forward deceleration switch before you enable the drive for the first time if you have configured deceleration switches and stop switches.
- Verify that the drive is between the reverse stop switch and the forward stop switch before you enable the drive for the first time if you have configured stop switches, but no deceleration switches.
- If you have configured switches, verify that the drive is within the permissible movement range before you use the function for the first time.

**Failure to follow these instructions can result in death, serious injury, or equipment damage.**

## ⚠ WARNING

### LOSS OF CONTROL

When the drive is switched off, it stores the range which it is currently in.

- If the system is moved manually while the drive is off, you must restore the original position before switching it on again.

**Failure to follow these instructions can result in death, serious injury, or equipment damage.**

In this instance, when operating for the first time or after restoring the factory settings, the drive must initially be started outside the slowdown and stop zones in order to initialize the function.

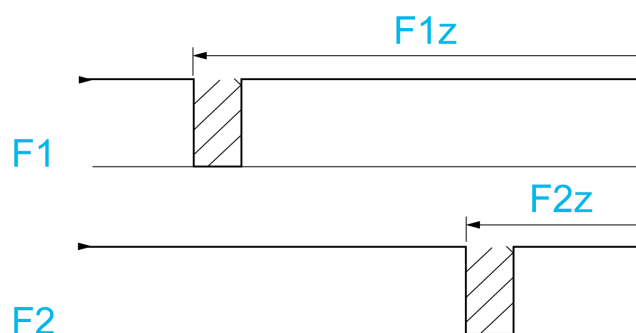

**F1** Forward slowdown

**F1z** Forward slowdown zone

**F2** Forward stop

**F2z** Forward stop zone

### Operation with long cams:

In this instance, there is no restriction, which means that the function is initialized across the whole trajectory.

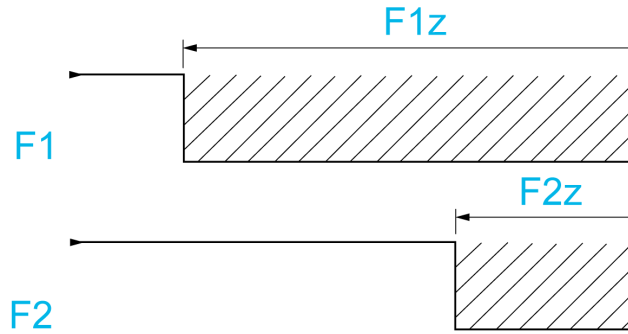

**F1** Forward slowdown

**F1z** Forward slowdown zone

**F2** Forward stop

**F2z** Forward stop zone

**Stop at distance calculated after deceleration limit switch**

This function can be used to control the stopping of the moving part automatically once a preset distance has been traveled after the slowdown limit switch. On the basis of the rated linear speed and the speed estimated by the drive when the slowdown limit switch is tripped, the drive induces the stop at the configured distance. This function is useful in applications where one manual-reset overtravel limit switch is common to both directions. It then only respond to help management if the distance is exceeded. The stop limit switch retains priority in respect of the function.

The **[Deceleration type]**  $DSF$  parameter can be configured to obtain either of the functions described below:

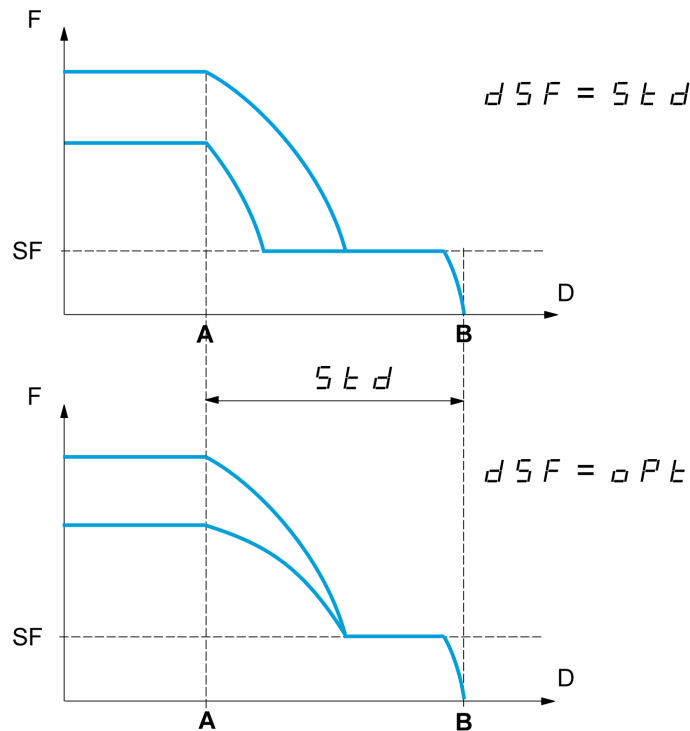

**A** Slowdown limit switch reached

**B** Automatic stop at a distance

**D** Distance

**F** Frequency

**SF** Slowdown frequency

**Note:**

- If the deceleration ramp is modified while stopping at a distance is in progress, this distance is not observed.
- If the direction is modified while stopping at a distance is in progress, this distance is not observed.

## ⚠ WARNING

### LOSS OF CONTROL

This function does not replace the limit switch.

- Verify that the configured distance is actually possible.

**Failure to follow these instructions can result in death, serious injury, or equipment damage.**

## [Stop FW limit sw.] SAF

If the parameters [Stop FW limit sw.] SAF, [Stop RV limit sw.] SAR, [Forward Slowdown] DAF and [Reverse Slowdown] DAR are set in such a way that the signal is triggered with a rising edge, no command is triggered in the case of an interruption of the signal cable to the switch or if the switch becomes inoperative.

## ⚠ WARNING

### LOSS OF CONTROL

In your risk assessment, take into account all potential consequences of triggering a signal with a rising edge.

**Failure to follow these instructions can result in death, serious injury, or equipment damage.**

If this parameter is assigned to a virtual digital, the function is active if the assigned input or bit is at 0.

Setting	Code / Value	Description
[Not Assigned]	NO	Not assigned <b>Factory setting.</b>
[DI1]...[DI8]	LI1...LI8	Digital input DI1...DI8 <b>NOTE:</b> DI8 selection can be accessed on drives with a power greater than 22kW.
[DI11]...[DI16]	LI11...LI16	Digital input DI11...DI16 if VW3A3203 I/O extension module has been inserted
[DI1 (Low level)]...[DI8 (Low level)]	L11L...L8L	Digital input DI1...DI8 used at low level <b>NOTE:</b> DI8 low level selection can be accessed on drives with a power greater than 22kW.
[DI11 (Low level)]...[DI16 (Low level)]	L11L...L16L	Digital input DI11...DI16 used at low level if VW3A3203 I/O extension module has been inserted
[CD00]...[CD15]	CD00...CD15	Virtual digital input CMD.0...CMD.15 in [I/O profile] IO configuration
[C101]...[C115]	C101...C115	Virtual digital input CMD1.01...CMD1.15 with integrated Modbus Serial in [I/O profile] IO configuration
[C201]...[C215]	C201...C215	Virtual digital input CMD2.01...CMD2.15 with CANopen® fieldbus module [I/O profile] IO configuration
[C301]...[C315]	C301...C315	Virtual digital input CMD3.01...CMD3.15 with a fieldbus module in [I/O profile] IO configuration
[C501]...[C515]	C501...C515	Virtual digital input CMD5.01...CMD5.15 with integrated Ethernet in [I/O profile] IO configuration

## [Stop RV limit sw.] SAR

Stop switch reverse.

Identical to [Stop FW limit sw.] SAF.

## [Forward Slowdown] DAF

Slowdown attained forward.

Identical to [Stop FW limit sw.] SAF.

## [Reverse Slowdown] DAR

Slowdown attained reverse.

Identical to [Stop FW limit sw.] SAF.

## [Disable limit sw.] CLS ★

Limits switches clearing.

<b>▲ WARNING</b>
<p><b>LOSS OF CONTROL</b></p> <p>If [Disable limit sw.] CLS is set to an input and activated, the limit switch management will be disabled.</p> <ul style="list-style-type: none"> <li>Verify that activating this function does not result in unsafe conditions.</li> </ul> <p><b>Failure to follow these instructions can result in death, serious injury, or equipment damage.</b></p>

The action of the limit switches is disabled when the assigned bit or input is at 1. If, at this time, the drive is stopped or being slowed down by limit switches, it restarts up to its speed reference.

This parameter can be accessed if at least one limit switch or one sensor has been assigned.

Setting	Code / Value	Description
[Not Assigned]	NO	Not assigned <b>Factory setting</b>
[DI1]...[DI8]	LI1...LI8	Digital input DI1...DI8 <b>NOTE:</b> DI8 selection can be accessed on drives with a power greater than 22kW.
[DI11]...[DI16]	LI11...LI16	Digital input DI11...DI16 if VW3A3203 I/O extension module has been inserted
[CD00]... [CD10]	CD00...CD10	Virtual digital input CMD.0...CMD.10 in [I/O profile] IO configuration
[CD11]... [CD15]	CD11...CD15	Virtual digital input CMD.11...CMD.15 regardless of configuration
[C101]... [C110]	C101...C110	Virtual digital input CMD1.01...CMD1.10 with integrated Modbus Serial in [I/O profile] IO configuration
[C111]... [C115]	C111...C115	Virtual digital input CMD1.11...CMD1.15 with integrated Modbus Serial regardless of configuration
[C201]... [C210]	C201...C210	Virtual digital input CMD2.01...CMD2.10 with CANopen® fieldbus module in [I/O profile] IO configuration

Setting	Code / Value	Description
[C211]... [C215]	C211...C215	Virtual digital input CMD2.11...CMD2.15 with CANopen® fieldbus module regardless of configuration
[C301]... [C310]	C301...C310	Virtual digital input CMD3.01...CMD3.10 with a fieldbus module in [I/O profile] IO configuration
[C311]... [C315]	C311...C315	Virtual digital input CMD3.11...CMD3.15 with a fieldbus module regardless of configuration
[C501]... [C510]	C501...C510	Virtual digital input CMD5.01...CMD5.10 with integrated Ethernet in [I/O profile] IO configuration <b>NOTE:</b> This selection can be accessed on ATV340••N4E drives.
[C511]... [C515]	C511...C515	Virtual digital input CMD5.11...CMD5.15 with integrated Ethernet regardless of configuration <b>NOTE:</b> This selection can be accessed on ATV340••N4E drives.

## [Stop type] PAS ★

Stop type on limit switch activation.

This parameter can be accessed if at least one limit switch or one sensor has been assigned.

Setting	Code / Value	Description
[On Ramp]	RMP	Follow ramp <b>Factory setting</b>
[Fast stop]	FST	Fast stop (ramp time reduced by [Ramp Divider] DCF)
[Freewheel Stop]	NST	Freewheel stop

## [Deceleration type] DSF ★

This parameter can be accessed if at least one limit switch or one sensor has been assigned.

Setting	Code / Value	Description
[Standard]	STD	Uses the [Deceleration] DEC or [Deceleration 2] DE2 ramp (depending on which has been enabled) <b>Factory setting</b>
[Optimized]	OPT	The ramp time is calculated on the basis of the actual speed when the slowdown contact switches, in order to limit the operating time at low speed (optimization of the cycle time: the slowdown time is constant regardless of the initial speed)

## [Stop distance] STD ★

This parameter can be accessed if at least one limit switch or one sensor has been assigned. Activation and adjustment of the "Stop at distance calculated after the slowdown limit switch" function.

Setting	Code / Value	Description
[No]	NO	Function inactive <b>Factory setting</b>
[0.01...10.00]		Stop distance range in meters

### [Nominal motor slip] NSL ★

Rated linear speed.

This parameter can be accessed if at least one limit switch or one sensor has been assigned and [Stop distance] STD is not set to [No] NO.

Setting	Description
0.20...5.00 m/s	<b>Factory setting:</b> 1.00 m/s

### [Stop corrector] SFD ★

Scaling factor applied to the stop distance to compensate, for example, a non-linear ramp.

This parameter can be accessed if at least one limit switch or one sensor has been assigned and [Stop distance] STD is not set to [No] NO.

Setting	Description
50...200%	<b>Factory setting:</b> 100%

### [Memo Stop] MSTP ★

This parameter can be accessed if at least one limit switch or one sensor has been assigned.

Setting	Code / Value	Description
[No]	NO	No memorization of limit switch
[Yes]	YES	Memorization of limit switch <b>Factory setting</b>

### [Priority restart] PRST ★

Priority given to the starting even if stop switch is activated.

This parameter can be accessed if at least one limit switch or one sensor has been assigned.

Setting	Code / Value	Description
[No]	NO	No restart priority if stop switch is activated <b>Factory setting</b>
[Yes]	YES	Priority to restart even if stop switch is activated

### [Memo Slowdown] MSLO ★

This parameter can be accessed if at least one limit switch or one sensor has been assigned.

Setting	Code / Value	Description
[No]	NO	No memorization of the slowdown switch.
[Yes]	YES	Memorization of the slowdown switch. <b>Factory setting</b>

## [Generic functions] - [Torque control]

### [Torque control] TOR– Menu

#### Access

[Complete settings] → [Generic functions] → [Torque control]

#### About This Menu

This function can be used if [Motor control type] CTT is set to [FVC] FVC or [FVC] FVC or [Sync. mot.] SYN or [Sync.CL] FSY.

**NOTE:** This function cannot be used with some other functions.

**NOTE:** This function is not compatible with the handling of the [Load slipping] ANF error.

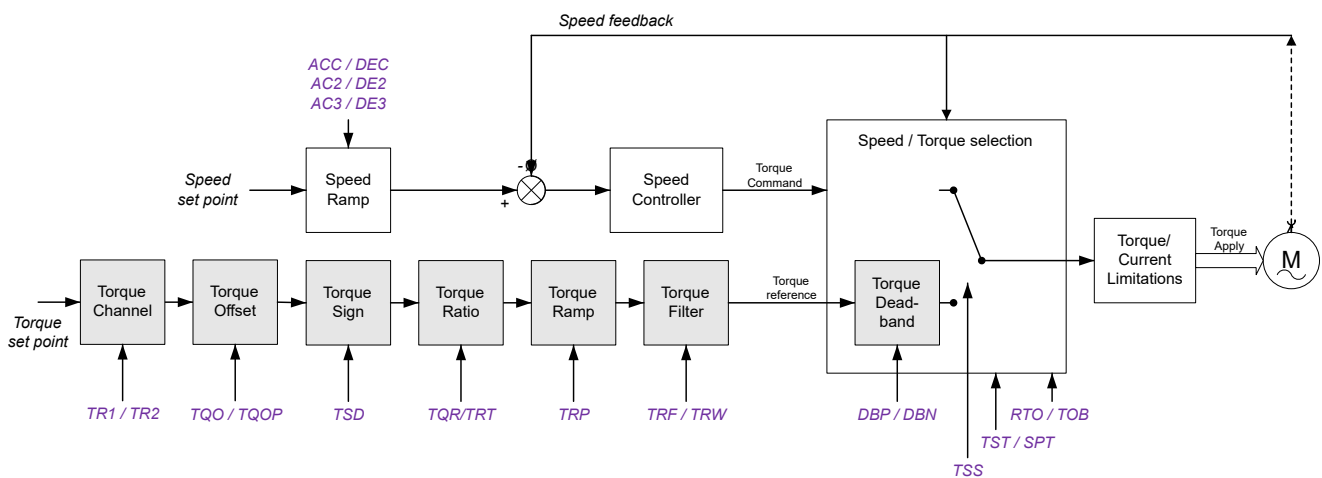

The function can be used to switch between operation in speed regulation mode and operation in torque control mode.

In torque control mode, the speed may vary within a configurable "deadband". When it reaches a lower or upper limit, the drive automatically reverts to speed regulation mode and remains at this limit speed. The regulated torque is therefore no longer maintained and two scenarios may occur.

- If the torque returns to the required value, the drive returns to torque control mode.
- If the torque does not return to the required value at the end of a configurable period, the drive switches to [Trq ctrl Warning] RTA or [Torque timeout] SRF.

### ⚠ WARNING

#### UNANTICIPATED EQUIPMENT OPERATION

Verify that activating this function does not result in unsafe conditions.

**Failure to follow these instructions can result in death, serious injury, or equipment damage.**



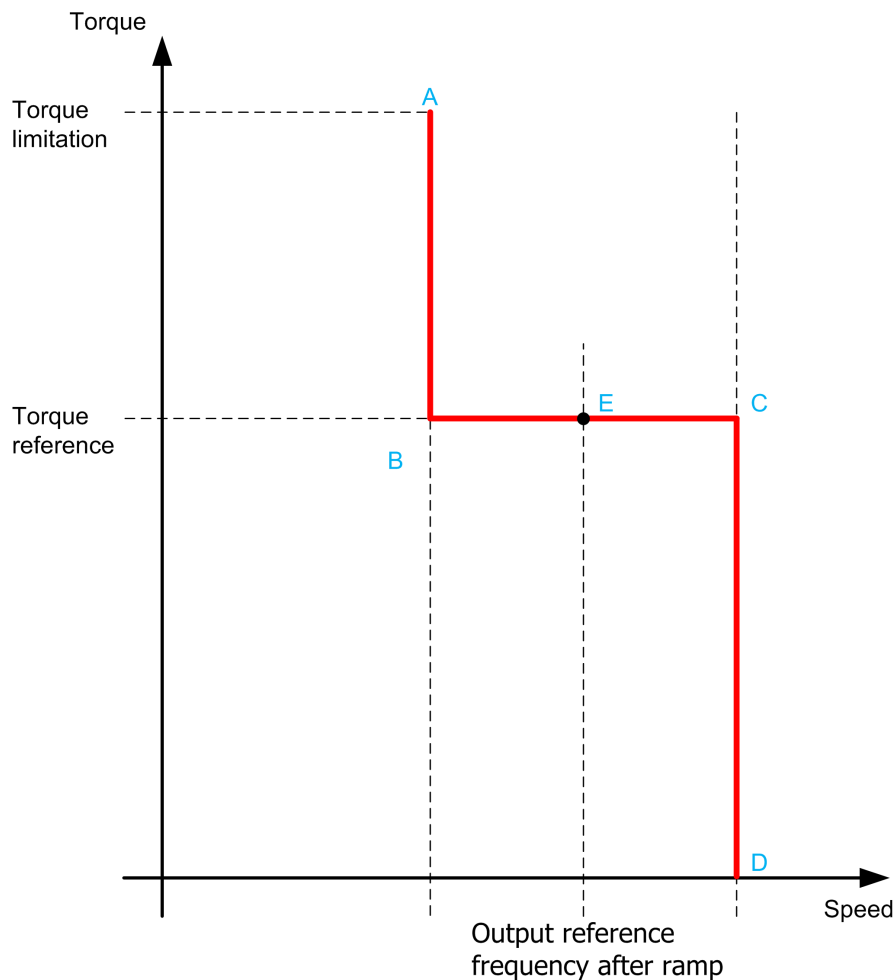

**AB, CD** Fallback" to speed regulation

**BC** Torque control zone

**E** Ideal operating point

The torque sign and value can be transmitted via a logic output and an analog output.

### [Trq/spd switching] TSS

Torque / speed regulation switching by a logic input.

This parameter is set to **[Not Assigned]** NO if:

- **[Brake assignment]** BLC is assigned.
- **[High speed hoisting]** HSO is configured.
- **[Load sharing]** LBA is configured.
- **[Forced Run]** INHS is configured.

Setting	Code / Value	Description
<b>[Not Assigned]</b>	NO	Not assigned <b>Factory setting</b>
<b>[Yes]</b>	YES	Yes
<b>[DI1]...[DI8]</b>	LI1...LI8	Digital input DI1...DI8 <b>NOTE:</b> DI8 selection can be accessed on drives with a power greater than 22kW.
<b>[DI11]...[DI16]</b>	LI11...LI16	Digital input DI11...DI16 if VW3A3203 I/O extension module has been inserted

Setting	Code / Value	Description
[CD00]... [CD10]	CD00...CD10	Virtual digital input CMD0.0...CMD.10 in [I/O profile] IO configuration
[CD11]... [CD15]	CD11...CD15	Virtual digital input CMD.11...CMD.15 regardless of configuration
[C101]... [C110]	C101...C110	Virtual digital input CMD1.01...CMD1.10 with integrated Modbus Serial in [I/O profile] IO configuration
[C111]... [C115]	C111...C115	Virtual digital input CMD1.11...CMD1.15 with integrated Modbus Serial regardless of configuration
[C201]... [C210]	C201...C210	Virtual digital input CMD2.01...CMD2.10 with CANopen® fieldbus module in [I/O profile] IO configuration
[C211]... [C215]	C211...C215	Virtual digital input CMD2.11...CMD2.15 with CANopen® fieldbus module regardless of configuration
[C301]... [C310]	C301...C310	Virtual digital input CMD3.01...CMD3.10 with a fieldbus module in [I/O profile] IO configuration
[C311]... [C315]	C311...C315	Virtual digital input CMD3.11...CMD3.15 with a fieldbus module regardless of configuration
[C501]... [C510]	C501...C510	Virtual digital input CMD5.01...CMD5.10 with integrated Ethernet in [I/O profile] IO configuration <b>NOTE:</b> This selection can be accessed on ATV340...N4E drives.
[C511]... [C515]	C511...C515	Virtual digital input CMD5.11...CMD5.15 with integrated Ethernet regardless of configuration <b>NOTE:</b> This selection can be accessed on ATV340...N4E drives.

## [Torque ref. channel] TR1 ★

Channel for torque reference.

This parameter can be accessed if [Trq/spd switching] TSS is not set to [Not Assigned] NO.

**NOTE:** [Torque ref.] LTR can be accessed in [Display] MON– menu, [Drive parameters] MPI– submenu.

Setting	Code / Value	Description
[Not Configured]	NO	Not assigned <b>Factory setting</b>
[AI1]...[AI3]	AI1...AI3	Analog input AI1...AI3
[AI4]...[AI5]	AI4...AI5	Analog input AI4...AI5 if VW3A3203 I/O extension module has been inserted
[HMI]	LCC	Reference frequency via remote terminal
[Ref. Freq-Modbus]	MDB	Reference frequency via Modbus
[Ref. Freq-CANopen]	CAN	Reference frequency via CANopen
[Ref. Freq-Com. Module]	NET	Reference frequency via communication module
[Embedded Ethernet]	ETH	Embedded Ethernet <b>NOTE:</b> This selection can be accessed on ATV340...N4E drives.
[DI7 PulseInput]... [DI8 PulseInput]	PI7...PI8	Digital input DI7...DI8 used as pulse input <b>NOTE:</b> This selection can be accessed on drives with a power greater than 22kW.

Setting	Code / Value	Description
[RP]	PI	Pulse input <b>NOTE:</b> This selection can be accessed on drives with a power below than 30 kW.
[Encoder]	PG	Encoder reference if an encoder module has been inserted or embedded encoder is used. <b>NOTE:</b> Note: Embedded encoder is only available on drives with power up to 22kW.

## [Torque Ref Assign] TRI ★

Torque reference channel assignment.

This parameter can be accessed if [Trq/spd switching] TSS is not set to [Not Assigned] NO.

Setting	Code / Value	Description
[DI1]...[DI8]	LI1...LI8	Digital input DI1...DI8 <b>NOTE:</b> DI8 selection can be accessed on drives with a power greater than 22kW.
[DI11]...[DI16]	LI11...LI16	Digital input DI11...DI16 if VW3A3203 I/O extension module has been inserted
[C101]... [C110]	C101...C110	Virtual digital input CMD1.01...CMD1.10 with integrated Modbus Serial in [I/O profile] IO configuration
[C111]... [C115]	C111...C115	Virtual digital input CMD1.11...CMD1.15 with integrated Modbus Serial regardless of configuration
[C201]... [C210]	C201...C210	Virtual digital input CMD2.01...CMD2.10 with CANopen® fieldbus module in [I/O profile] IO configuration
[C211]... [C215]	C211...C215	Virtual digital input CMD2.11...CMD2.15 with CANopen® fieldbus module regardless of configuration
[C301]... [C310]	C301...C310	Virtual digital input CMD3.01...CMD3.10 with a fieldbus module in [I/O profile] IO configuration
[C311]... [C315]	C311...C315	Virtual digital input CMD3.11...CMD3.15 with a fieldbus module regardless of configuration
[C501]... [C510]	C501...C510	Virtual digital input CMD5.01...CMD5.10 with integrated Ethernet in [I/O profile] IO configuration
[C511]... [C515]	C511...C515	Virtual digital input CMD5.11...CMD5.15 with integrated Ethernet Modbus TCP regardless of configuration <b>NOTE:</b> This selection can be accessed on ATV340...N4E drives.
[Torque ref. channel]	TR1	Torque reference channel 1
[Torque ref. 2 channel]	TR2	Torque reference channel 2

## [Torque ref. 2 channel] TR2 ★

Torque reference channel 2.

This parameter can be accessed if [Trq/spd switching] TSS is not set to [Not Assigned] NO.

Identical to [Torque ref. channel] TR1 , page 370.

## [Torque ref. sign] TSD ★

Assignment for the inversion of the sign of the reference for the torque regulation function.

This parameter can be accessed if [Trq/spd switching] TSS is not set to [Not Assigned] NO.

Identical to [Trq/spd switching] TSS , page 369.

## [Torque ratio] TRT ★

Torque regulation: torque ratio.

This parameter can be accessed if [Trq/spd switching] TSS is not set to [Not Assigned] NO.

Setting ( )	Description
0.0...1000.0%	Coefficient applied to [Torque ref. channel] TR1 or [Torque ref. 2 channel] TR2  Factory setting: 100.0%

## [Torque Ratio Assign] TQR ★

Torque regulation: torque ratio value selection.

This parameter can be accessed if [Trq/spd switching] TSS is not set to [Not Assigned] NO.

Setting	Code / Value	Description
[Not Configured]	NO	Analog input is not assigned  Factory setting
[AI1]...[AI3]	AI1...AI3	Analog input AI1...AI3
[AI4]...[AI5]	AI4...AI5	Analog input AI4...AI5 if VW3A3203 I/O extension module has been inserted
[AI Virtual 1]	AIV1	Virtual analogic input 1
[DI7 PulseInput]... [DI8 PulseInput]	PI7...PI8	Digital input DI7...DI8 used as pulse input  <b>NOTE:</b> This selection can be accessed on drives with a power greater than 22kW.
[RP]	PI	Pulse input  <b>NOTE:</b> This selection can be accessed on drives with a power below than 30 kW.
[Encoder]	PG	Encoder reference if an encoder module has been inserted or embedded encoder is used.  <b>NOTE:</b> Embedded encoder is only available on drives with power up to 22kW.

## [Torque Ref Offset] TQOP ★

This parameter can be accessed if [Trq/spd switching] TSS is not set to [Not Assigned] NO.

Setting ( )	Description
-1000.0...1000.0%	Setting range  Factory setting: 0.0%

## [Torque Offset Assign] TQO ★

Torque regulation: Torque offset value selection

This parameter can be accessed if [Trq/spd switching] TSS is not set to [Not Assigned] NO.

Identical to [Torque Ratio Assign] TQR , page 372.

## [Low Torque] LTQ ★

This parameter can be accessed if [Trq/spd switching] TSS is not set to [Not Assigned] NO.

This parameter cannot be higher than [High Torque] HTQ .

Setting ( )	Description
-300.0...[High Torque] HTQ	Setting range <b>Factory setting:</b> -300.0%

## [High Torque] HTQ ★

This parameter can be accessed if [Trq/spd switching] TSS is not set to [Not Assigned] NO.

This parameter cannot be lower than [Low Torque] LTQ.

Setting ( )	Description
[Low Torque] LTQ...300.0%	Setting range <b>Factory setting:</b> 300.0%

## [Torque ramp time] TRP ★

This parameter can be accessed if [Trq/spd switching] TSS is not set to [Not Assigned] NO.

Setting ( )	Description
0.00...99.99 s	Rise and fall time for a variation of 100% of the rated torque <b>Factory setting:</b> 3.00 s

## [Torque Filter] TRF ★

This parameter can be accessed if [Trq/spd switching] TSS is not set to [Not Assigned] NO.

Setting	Code / Value	Description
[No]	NO	Not activated. <b>Factory setting</b>
[Yes]	YES	Activated

## [Torque Filter Bandwidth] TRW ★

This parameter can be accessed if [Torque Filter] TRF is set to [Yes] YES.

Setting ( )	Description
1...1000 Hz	Setting range <b>Factory setting:</b> 20 Hz

## [Torque control stop] TST ★

*Torque control stop type.*

Setting	Code / Value	Description
[Speed]	SPD	Speed regulation stop, in accordance with the [Type of stop] STT configuration  The parameter is forced to [Speed] SPD if [Brake assignment] BLC is configured
[Freewheel]	NST	Freewheel stop <b>Factory setting</b>
[Spin]	SPN	Zero torque stop, but maintaining the flux in the motor  <b>Note:</b> This setting can only be accessed in closed loop control ([Motor control type] CTT is set to [Sync.CL] FSY or [FVC] FVC)

## [Spin time] SPT ★

Torque regulation: spin time.

Spin time following stop, in order to remain ready to restart quickly.

This parameter can be accessed if:

- [Trq/spd switching] TSS is not set to [Not Assigned] NO, and
- [Torque control stop] TST is set to [Spin] SPN.

Setting ( )	Description
0.0...3600.0 s	Setting range <b>Factory setting:</b> 1.0 s

## [Positive deadband] DBP ★

Torque regulation positive deadband.

This parameter can be accessed if [Trq/spd switching] TSS is not set to [Not Assigned] NO.

Value added algebraically to the speed reference.

Example for DBP = 10:

- If reference = +50 Hz : +50 + 10 = 60 Hz
- If reference = -50 Hz : -50 + 10 = -40 Hz

Setting ( )	Description
0...2 x [Max Frequency] TFR	Setting range <b>Factory setting:</b> 10 Hz

### [Negative deadband] DBN ★

Torque regulation negative deadband.

This parameter can be accessed if [Trq/spd switching] TSS is not set to [Not Assigned] NO.

Value subtracted algebraically from the speed reference.

Example for DBN = 10:

- If reference = +50 Hz: + 50 - 10 = 40 Hz
- If reference = -50 Hz: -50 - 10 = -60 Hz

Setting ( )	Description
0...2 x [Max Frequency] TFR	Setting range <b>Factory setting:</b> 10 Hz

### [Torque ctrl time out] RTO ★

Torque control time-out.

This parameter can be accessed if [Trq/spd switching] TSS is not set to [Not Assigned] NO.

Time following automatic exit of torque control mode in the event of an error or a warning has been triggered.

Setting	Description
0.0...999.9 s	Setting range <b>Factory setting:</b> 60 s

### [Torque Ctrl ErrorResp] TOB ★

Response to torque control error.

This parameter can be accessed if [Trq/spd switching] TSS is not set to [Not Assigned] NO.

Response of drive once time [Torque ctrl time out] RTO has elapsed.

Setting	Code / Value	Description
[Warning]	ALRM	Warning is triggered on time-out <b>Factory setting</b>
[Error]	FLT	An error is triggered with freewheel stop

## [Generic functions] - [Parameters switching]

### [Parameters switching] MLP– Menu

#### Access

[Complete settings] → [Generic functions] → [Parameters switching]

#### About This Menu

A set of 1 to 15 parameters from the **[Parameter Selection]** SPS list, page 377 can be selected and 2 or 3 different values assigned. These 2 or 3 sets of values can then be switched using 1 or 2 digital inputs or control word bits. This switching can be performed during operation (motor running). It can also be controlled based on 1 or 2 frequency thresholds, whereby each threshold acts as a digital input (0 = threshold not reached, 1 = threshold reached).

	Values 1	Values 2	Values 3
Parameter 1	Parameter 1	Parameter 1	Parameter 1
...	...	...	...
Parameter 15	Parameter 15	Parameter 15	Parameter 15
Input DI or bit or frequency threshold 2 values	0	1	0 or 1
Input DI or bit or frequency threshold 3 values	0	0	1

**NOTE:** Do not modify the parameters in **[Parameter Selection]** SPS, page 377, because any modifications made in this menu are lost on the next power-up. The parameters can be adjusted during operation in the **[Parameters switching]** MLP– menu, on the active configuration.

### [2 Parameter sets] CHA1

Switching 2 parameter sets.

Setting	Code / Value	Description
[Not Assigned]	NO	Not assigned <b>Factory setting</b>
[Mot Freq High Thd]	FTA	Motor frequency high threshold reached
[Mot Freq High Thd 2]	F2A	Second frequency threshold reached
[DI1]...[DI8]	LI1...LI8	Digital input DI1...DI8 <b>NOTE:</b> DI8 selection can be accessed on drives with a power greater than 22kW.
[DI11]...[DI16]	LI11...LI16	Digital input DI11...DI16 if VW3A3203 I/O extension module has been inserted
[CD00]...[CD10]	CD00...CD10	Virtual digital input CMD.0...CMD.10 in <b>[I/O profile]</b> IO configuration
[CD11]...[CD15]	CD11...CD15	Virtual digital input CMD.11...CMD.15 regardless of configuration
[C101]...[C110]	C101...C110	Virtual digital input CMD1.01...CMD1.10 with integrated Modbus Serial in <b>[I/O profile]</b> IO configuration



Setting	Code / Value	Description
[C111]... [C115]	C111...C115	Virtual digital input CMD1.11...CMD1.15 with integrated Modbus Serial regardless of configuration
[C201]... [C210]	C201...C210	Virtual digital input CMD2.01...CMD2.10 with CANopen® fieldbus module in [I/O profile] IO configuration
[C211]... [C215]	C211...C215	Virtual digital input CMD2.11...CMD2.15 with CANopen® fieldbus module regardless of configuration
[C301]... [C310]	C301...C310	Virtual digital input CMD3.01...CMD3.10 with a fieldbus module in [I/O profile] IO configuration
[C311]... [C315]	C311...C315	Virtual digital input CMD3.11...CMD3.15 with a fieldbus module regardless of configuration
[C501]... [C510]	C501...C510	Virtual digital input CMD5.01...CMD5.10 with integrated Ethernet in [I/O profile] IO configuration <b>NOTE:</b> This selection can be accessed on ATV340...N4E drives.
[C511]... [C515]	C511...C515	Virtual digital input CMD5.11...CMD5.15 with integrated Ethernet regardless of configuration <b>NOTE:</b> This selection can be accessed on ATV340...N4E drives.

### [3 Parameter sets] CHA2

Parameter switching assignment 2.

Identical to [2 Parameter sets] CHA1.

Switching 3 parameter sets.

**NOTE:** In order to obtain 3 parameter sets, it is necessary to configure first [2 Parameter sets] CHA1.

### [Parameter Selection] SPS

This parameter can be accessed if [2 Parameter sets] CHA1 is not set to [Not Assigned] NO.

Making an entry in this parameter opens a window containing all the adjustment parameters that can be accessed. Select 1 to 15 parameters using **OK** key. Parameter(s) can also be deselected using **OK** key.

Available parameters for parameters switching function are:

Parameter	Code
[Ramp increment]	INR
[Acceleration]	ACC
[Deceleration]	DEC
[Acceleration 2]	AC2
[Deceleration 2]	DE2
[Begin Acc round]	TA1
[End Acc round]	TA2
[Begin Dec round]	TA3
[End Dec round]	TA4
[Low Speed]	LSP
[High Speed]	HSP
[High speed 2]	HSP2
[High speed 3]	HSP3

Parameter	Code
[High speed 4]	HSP4
[Motor Th Current]	ITH
[IR compensation]	UFR
[Slip compensation]	SLP
[K speed loop filter]	SFC
[Speed time integral]	SIT
[Speed prop. gain]	SPG
[Inertia Factor]	SPGU
[Ramp Divider]	DCF
[DC Inj Level 1]	IDC
[DC Inj Time 1]	TDI
[DC Inj Level 2]	IDC2
[DC Inj Time 2]	TDC
[Auto DC inj Level 1]	SDC1
[Auto DC Inj Time 1]	TDC1
[Auto DC inj Level 2]	SDC2
[Auto DC Inj Time 2]	TDC2
[Switching frequency]	SFR
[Current Limitation]	CLI
[Current Limit2 Value]	CL2
[Motor fluxing]	FLU
[Low Speed Timeout]	TLS
[Sleep Offset Thres.]	SLE
[Jog Frequency]	JGF
[Jog Delay]	JGT
[Preset speed 2]...[Preset speed 16]	SP2...SP16
[+/- Speed limitation]	SRP
[Multiplying coeff.]	MFR
[Brk Release Current]	IBR
[Brake release I Rev]	IRD
[Brake Release time]	BRT
[Brake release freq]	BIR
[Brake engage freq]	BEN
[Brake engage delay]	TBE
[Brake engage time]	BET
[Jump at reversal]	JDC
[Time to restart]	TTR
[BRH_b4_freq]	BFTD
[Motor torque limit]	TLIM
[Gen. torque limit]	TLIG
[Torque ratio]	TRT
[Low Torque]	LTQ

Parameter	Code
[High Torque]	HTQ
[PID Prop.Gain]	RPG
[PID Intgl.Gain]	RIG
[PID derivative gain]	RDG
[PID ramp]	PRP
[PID Min Output]	POL
[PID Max Output]	POH
[PID Start Ref Freq]	SFS
[PID acceleration time]	ACCP
[Min fbk Warning]	PAL
[Max fbk Warning]	PAH
[PID error Warning]	PER
[Speed input %]	PSR
[Ref PID Preset 2]	RP2
[Ref PID Preset 3]	RP3
[Ref PID Preset 4]	RP4
[PID Fdbk Range]	PFMR
[PID Fdbk Error Delay]	PFMD
[High Current Thd]	CTD
[Low I Threshold]	CTDL
[High torque thd.]	TTH
[Low torque thd.]	TTL
[Motor Freq Thd]	FTD
[Low Freq.Threshold]	FTDL
[Freq. threshold 2]	F2D
[2 Freq. Threshold]	F2DL
[Freewheel stop Thd]	FFT
[Motor Therm Thd]	TTD
[Reference high Thd]	RTD
[Reference low Thd]	RTDL
[Skip Frequency]	JPF
[Skip Frequency 2]	JF2
[3rd Skip Frequency]	JF3
[Skip Freq.Hysteresis]	JFH
[Unld.Thr.Nom.Speed]	LUN
[Unld.Thr.0.Speed]	LUL
[Unld. FreqThr. Det.]	RMUD
[Hysteresis Freq]	SRB
[Underload T.B.Rest.]	FTU
[Overload Threshold]	LOC
[Overload T.B.Rest.]	FTO
[Fan mode]	FFM

Parameter	Code
[Pmax Motor]	TPMM
[Pmax Generator]	TPMG
[Stall Max Time]	STP1
[Stall Current]	STP2
[Stall Frequency]	STP3
[AI1 Th Warn Level]	TH1A
[AI3 Th Warn Level]	TH3A
[AI4 Th Warn Level]	TH4A
[AI5 Th Warn Level]	TH5A
[AI1 Th Error Level]	TH1F
[AI3 Th Error Level]	TH3F
[AI4 Th Error Level]	TH4F
[AI5 Th Error Level]	TH5F
[Load correction]	LBC

### [Set 1] PS1– to [Set 3] PS3–

3 possible sets of values.

Making an entry in this menu opens a settings window containing the selected parameters in the order in which they were selected.

Access to each menu in order to configure their own set of values.

# [Generic functions] - [Stop after speed timeout]

## [Stop after speed timeout] PRSP- Menu

### Access

[Complete settings] → [Generic functions] → [Stop after speed timeout]

### Sleep/Wake-Up in Speed Control Mode

The drive is in Speed control mode, when PID is not active, typically when:

- PID is not configured (the motor speed setpoint is controlled by an external PLC, for example).
- PID is in manual mode (manual application mode, for example).
- PID is not active because Channel 1 is not selected (forced local mode enabled, for example).

When the drive is used in Speed Control (PID not used or not active), a speed condition is used to switch the application to the sleep state. When the drive is in sleep state, the motor is restarted if the sleep condition disappears.

This function avoids prolonged operation at low speeds when neither useful nor compliant with the system constraints. It stops the motor after a period of operation at reduced speed. This time and speed can be adjusted.

In Speed control mode, Sleep/Wake-up is managed according to the following rules:

- The motor is stopped when [Pre-Ramp Ref Freq] FRH and [Motor Frequency] RFR become and stay lower than [Low Speed] LSP + [Sleep Offset Thres.] SLE during [Low Speed Timeout] TLS.
- The motor is restarted when [Pre-Ramp Ref Freq] FRH > [Low Speed] LSP + [Sleep Offset Thres.] SLE.

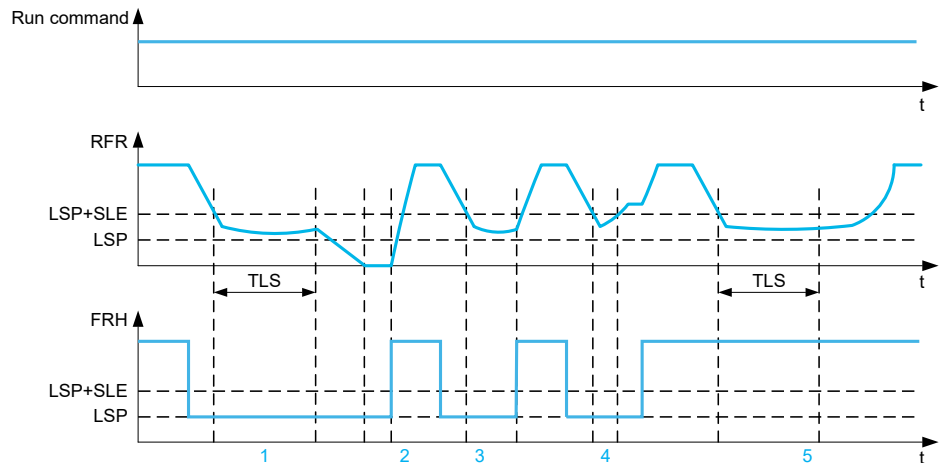

- 1 Nominal **[Low Speed Timeout] TLS** function action: after **[Low Speed Timeout] TLS** time, the motor is stopped according to the current deceleration ramp
- 2 **[Pre-Ramp Ref Freq] FRH** becomes greater than **[Low Speed] LSP + [Sleep Offset Thres.] SLE** and run order still present **[Low Speed Timeout] TLS** function is deactivated
- 3 **[Low Speed Timeout] TLS** function is not activated because **[Pre-Ramp Ref Freq] FRH** becomes greater than **[Low Speed] LSP + [Sleep Offset Thres.] SLE** before **[Low Speed Timeout] TLS** has expired
- 4 **[Low Speed Timeout] TLS** function is not activated because **[Motor Frequency] RFR** becomes greater than **[Low Speed] LSP + [Sleep Offset Thres.] SLE** before **[Low Speed Timeout] TLS** has expired
- 5 **[Low Speed Timeout] TLS** function is not activated because **[Pre-Ramp Ref Freq] FRH** stays greater than **[Low Speed] LSP + [Sleep Offset Thres.] SLE**

## [Low Speed Timeout] TLS

*Low speed timeout.*

Setting ( )	Description
0.0...999.9 s	Setting range Factory setting: 0.0 s

## [Sleep Offset Thres.] SLE ★

This parameter can be accessed if **[Low Speed Timeout] TLS** is not set to 0.

Adjustable restart threshold (offset) following a stop after prolonged operation at **[Low Speed] LSP + [Sleep Offset Thres.] SLE**, in Hz. The motor restarts if the reference rises above (LSP + SLE) and if a run command is still present.

Setting ( )	Description
1.0... <b>[Max Frequency] TFR</b>	Setting range Factory setting: 1.0 Hz

# [Generic functions] - [DC bus supply]

## [DC bus supply] DCO- Menu

### Access

[Complete settings] → [Generic functions] → [DC bus supply]

### About This Menu

This menu can be accessed on 480V Drives with power **greater than 22kW**.

It gives the possibility to switch off/on drives supplied by a common DC bus without stopping the supply unit. Direct power supply via the DC bus requires a protected direct current source with adequate power and voltage as well as a suitably dimensioned resistor and capacitor precharging contactor. Consult Schneider Electric for information about specifying these components.

The **Direct Power Supply via Dc Bus** function can be used to control the precharging contactor via a relay or a logic input on the drive.

Example circuit using R2 relay:

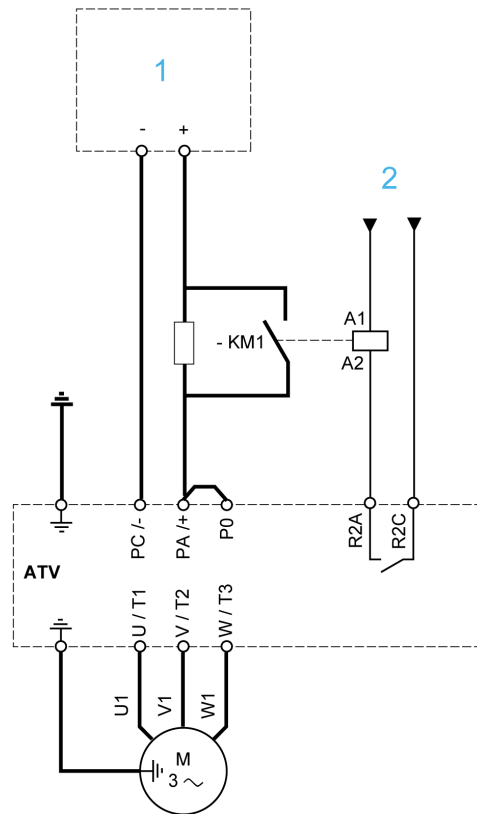

1 DC power supply

2 +24 Vdc

## [DC Charging Assign] DCO ★

*DC Bus charge assignment.*

Setting	Code / Value	Description
[No]	NO	Not assigned <b>Factory setting</b>
[R2]...[R3]	R2...R3	Relay output R2...R3 <b>NOTE:</b> R3 selection can be accessed on drives with a power greater than 22 kW.
[R4]...[R6]	R4...R6	Relay output R4...R6 if VW3A3204 relay output option module has been inserted
[DQ11 Digital Output]... [DQ12 Digital Output]	DO11...DO12	Digital output DQ11...DQ12 if VW3A3203 I/O extension module has been inserted
[DQ1 Digital Output]... [DQ2 Digital Output]	DO1...DO2	Digital output DQ1...DQ2 <b>NOTE:</b> DQ2 selection can be accessed on drives with a power below than 30 kW.

## [DC Bus Charge Time] DCT ★

This parameter can be accessed if [DC Charging Assign] DCO is not set to [No] NO.

Setting	Description
0.00...10.00 s	<b>Factory setting:</b> 0.00 s



## [Generic functions] - [Multimotors config]

### [Multimotors config] MMC– Menu

#### Access

[Complete settings] → [Generic functions] → [Multimotors config]

#### About This Menu

This function is used to switch between up to 4 configurations using digital inputs or bits.

2 Different modes exist:

- **Multi-Configuration** mode ([Multimotors] CHM set to [No] NO): Up to 4 different configurations for a single motor. The drive parameters linked to the motor are shared between the configurations.
- **Multi-Motor** mode ([Multimotors] CHM set to [Yes] YES): Up to 4 different motor configuration. The drive parameters linked to the motor depends on the configuration; they must be defined for each configuration.

**NOTE:** The two modes cannot be combined.

Observe the following conditions:

- Switching may take place when stopped (drive locked). If a switching request is sent during operation, it is executed at next stop.
- When switching between motors, the concerned power and control terminals must be switched as appropriate.
- All configurations must share the same hardware configuration, i.e. the option modules cannot be removed or replaced by another when switching between configuration; otherwise the drive locks in [Incorrect Config] CFF.
- Switching to a configuration that does not exist causes the drive to lock in [Empty Configuration] CFI4. Use [Save Configuration] SCSI to save the current drive configuration.

**NOTE:** To help set the multi-configurations or the multi-motor configurations, a dedicated view exists in SoMove/DTM. Access **Device > Configuration management > Multi-Configuration**.

### Menus and Parameters Switched in Multi-Motor Mode

In multi-configurations mode, communication parameters are not switched.

- [Motor parameters] MPA– menu.
- [Input/Output] IO – menu.
- [Generic functions] CSGF– menu except for the [Multimotors config] MMC– function (to be configured once only).
- [Generic monitoring] GPR– menu.
- [My menu] MYMN– menu.

### Define/Enter a drive configuration

Irrespective of the mode (multi-motor or multi-configuration), each one of the configurations must be entered in the drive; otherwise, the error [Empty Configuration] CFI4 is triggered.

The followings can be used to define/enter a drive configuration:

- Use **[Save Configuration]** **SCSI** to save the current drive configuration in the corresponding memory slot.
- Use **[Copy To The Device]** **OPF** to copy a configuration from the Graphic Display Terminal into the drive. It replaced the current drive configuration selected according to the level of the inputs assigned to **[2 Configurations]** **CNF1** and **[3 Configurations]** **CNF2**.
- Use the toolbar or the dedicated view in SoMove/DTM (refer to the DTM online help for more information).

## Switching Command

Depending on the number of motors or selected configurations (Up to 4), the switching command is sent using one or two digital inputs (or bits). The table below lists the possible combinations.

DI or bit assigned to <b>[2 Configurations]</b> <b>CNF1</b>	DI or bit assigned to <b>[3 Configurations]</b> <b>CNF2</b>	Selected configuration or motor
0	0	Config 0
1	0	Config 1
0	1	Config 2
1	1	Config 3

## Schematic Diagram for Multi-Motor Mode

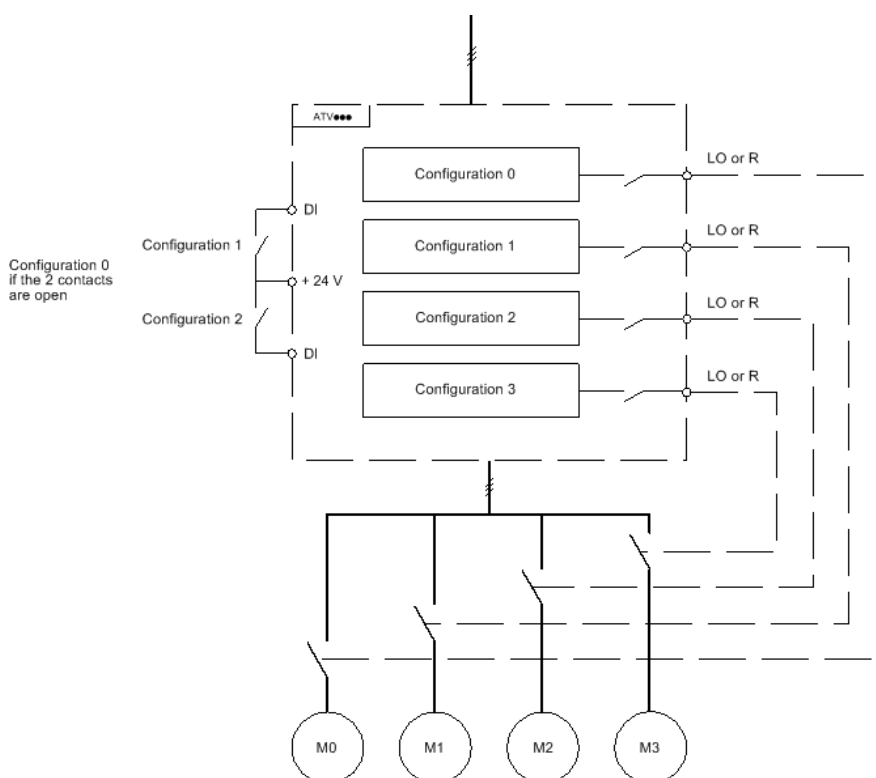

## Auto-Tuning in Multi-Motor Mode

On Multi-Motor mode, autotuning parameters for each motor are handled and stored. However, it is necessary to firstly perform autotuning on each motor.

This auto-tuning can be performed:

- Manually using a Digital input when the motor changes.

- Automatically on the selected motor at drive power-up if the [Automatic autotune] AUT is set to [Yes] YES.

**Motor thermal states in multi-motor mode:**

The drive helps to protect the four motors individually. Each thermal state takes into account all stop times if the drive power is not switched off.

<b>NOTICE</b>
<p><b>MOTOR OVERHEATING</b></p> <p>When the drive is switched off, the thermal states of the connected motors are not saved. When the drive is switched on again, the drive is not aware of the thermal states of the connected motors.</p> <ul style="list-style-type: none"> <li>• Use separate temperature sensors for each connected motor for thermal monitoring.</li> </ul> <p><b>Failure to follow these instructions can result in equipment damage.</b></p>

## Configuration Information Output

In the [Input/Output] IO – menu, a digital output can be assigned to each configuration or motor (2 to 4) for remote information transmission.

**NOTE:** As the [Input/Output] IO – menu is switched, these outputs must be assigned in all configurations in which information is required.

## [Multimotors] CHM

**Multimotors selection.**

Value	Code / Value	Description
[No]	NO	Multi-configuration possible <b>Factory setting</b>
[Yes]	YES	Multi-motor possible

## [2 Configurations] CNF1 and [3 Configurations] CNF2

To switch between configurations (multi-configuration or multi-motor).

**NOTE:** In order to obtain 4 motors or 4 configurations, [2 Configurations] CNF1 and [3 Configurations] CNF2 must be configured.

Value range	Code / Value	Description
[Not Assigned]	NO	Not assigned <b>Factory setting</b>
[DI1]...[DI8]	LI1...LI8	Digital input DI1...DI8 <b>NOTE:</b> DI8 selection can be accessed on drives with a power greater than 22kW.
[DI11]...[DI16]	LI11...LI16	Digital input DI11...DI16 if VW3A3203 I/O extension module has been inserted
[C101]... [C110]	C101...C110	Virtual digital input CMD1.01...CMD1.10 with integrated Modbus Serial in [I/O profile] IO configuration
[C111]... [C115]	C111...C115	Virtual digital input CMD1.11...CMD1.15 with integrated Modbus Serial regardless of configuration
[C201]... [C210]	C201...C210	Virtual digital input CMD2.01...CMD2.10 with CANopen® fieldbus module in [I/O profile] IO configuration

Value range	Code / Value	Description
[C211]... [C215]	C211...C215	Virtual digital input CMD2.11...CMD2.15 with CANopen® fieldbus module regardless of configuration
[C301]... [C310]	C301...C310	Virtual digital input CMD3.01...CMD3.10 with a fieldbus module in [I/O profile] IO configuration
[C311]... [C315]	C311...C315	Virtual digital input CMD3.11...CMD3.15 with a fieldbus module regardless of configuration
[C501]... [C510]	C501...C510	Virtual digital input CMD5.01...CMD5.10 with integrated Ethernet in [I/O profile] IO configuration <b>NOTE:</b> This selection can be accessed on ATV340••N4E drives.
[C511]... [C515]	C511...C515	Virtual digital input CMD5.11...CMD5.15 with integrated Ethernet regardless of configuration <b>NOTE:</b> This selection can be accessed on ATV340••N4E drives.

## [Generic functions] - [24V Supply Output]

### [24V Supply Output] s24v- Menu

#### Access

[Complete settings] → [Generic functions] → [24V Supply Output]

This menu can be accessed on drives with a power **lower than 30 kW**.

### [24V Supply Output] s24v

#### *24V Supply output.*

Setting	Code / Value	Description
[No]	NO	24V pin is used as input supply.
[Yes]	YES	24V pin is used as output supply. <b>Factory setting</b>

## [Generic functions] – [External weight meas.]

### [External weight meas.] ELM– Menu

#### Access

[Complete settings] → [Generic functions] → [External weight meas.]

#### About This Menu

### ⚠ WARNING

#### WARNING LOSS OF CONTROL

Perform a comprehensive commissioning test to verify correct operation of the weight sensor under all operating and error conditions.

**Failure to follow these instructions can result in death, serious injury, or equipment damage.**

This function uses the information supplied by a weight sensor to adapt the **[Brk Release Current] IBR** (the torque current) of the **[Brake logic control] BLC–** function. Depending on the settings, the brake release current can be positive or negative. The signal from the weight sensor can be assigned to an analog input (usually a 4 - 20 mA signal), to the pulse-in input or to the encoder input, according to the type of weight sensor.

For example, but not limited to, the weight sensor can measure the total weight of a hoisting winch and its load.

The brake release current is adapted in accordance with the curve below.

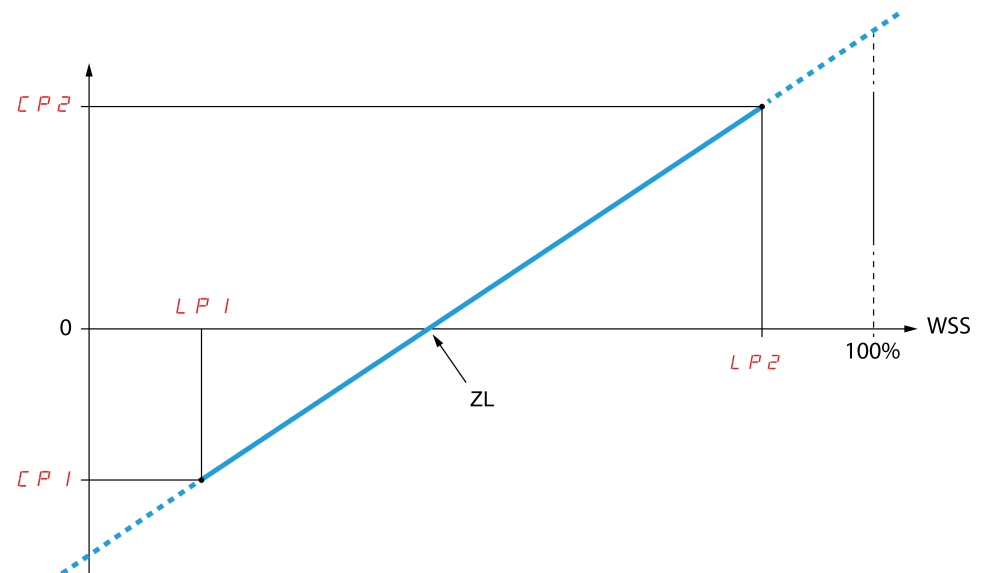

**CP1** Point 1 Y

**CP2** Point 2 Y

**LP1** Point 1 X

**LP2** Point 2 X

**ZL** Zero Load

**WSS** Weight Sensor Signal

This curve can represent a weight sensor on an application, where zero load on the motor is different from zero load on the application.

## [Weight Sensor Assign] PES

If [Brake assignment] BLC is not configured, this parameter is forced to [Not Configured] NO.

Setting	Code / Value	Description
[Not Configured]	NO	Not configured. <b>Factory setting</b>
[AI1]...[AI3]	AI1...AI3	Analog input AI1...AI3. <b>NOTE:</b> AI3 selection can be accessed on drives with a power greater than 22kW.
[AI4]...[AI5]	AI4...AI5	Analog input AI4...AI5 if VW3A3203 I/O extension module has been inserted.
[AI Virtual 1]	AIV1	Virtual analogic input 1.
[DI7 PulseInput]... [DI8 PulseInput]	PI7...PI8	Digital input DI7...DI8 used as pulse input. <b>NOTE:</b> This selection can be accessed on drives with a power greater than 22 kW.
[RP]	PI	Pulse input. <b>NOTE:</b> This selection can be accessed on drives with a power below than 30 kW.
[Encoder]	PG	Encoder reference if an encoder module has been inserted.

### [Point 1 X] LP1

This parameter can be accessed if [Weight Sensor Assign] PES is assigned.

Setting	Description
0.0...99.99 %	Setting range This parameter can't be equal or higher than [Point 2 X] LP2. <b>Factory setting:</b> 0.00 %

### [Point 1Y] CP1

This parameter can be accessed if [Weight Sensor Assign] PES is assigned.

Setting	Description
-1.1...1.1 In <sup>(1)</sup>	Setting range in A <b>Factory setting:</b> 0.7 * [Nom Motor Current] NCR
(1) In corresponds to the rated drive current indicated in the Installation Manual and on the drive nameplate.	

### [Point 2 X] LP2

This parameter can be accessed if [Weight Sensor Assign] PES is assigned.

Setting	Description
0.01...100.00 %	Setting range This parameter can't be equal or higher than [Point 1 X] LP1. <b>Factory setting:</b> 50.00 %

**[Point 2Y] CP2**

This parameter can be accessed if **[Weight Sensor Assign]** PES is assigned.

Setting	Description
-1.1...1.1 In <sup>(1)</sup>	Setting range in A <b>Factory setting:</b> <b>[Nom Motor Current]</b> NCR
(1) In corresponds to the rated drive current indicated in the Installation Manual and on the drive nameplate.	

**[lbr 4-20 mA loss] IBRA**

Brake release current in the event of the loss of the weight sensor information.

This parameter can be accessed if the weight sensor is assigned to an analog current input (PES = Alx) and the 4-20 mA loss monitoring function is deactivated (LFLx = No).

**[Alx Min. Value]** CRLx must be equal or greater than 4 mA and **[lbr 4-20 mA loss]** IBRA must be set to a value consistent with your application.

For a hoisting application, the advisable setting is **[Nom Motor Current]** NCR.

Setting	Description
0...1.1 In <sup>(1)</sup>	Setting range in A. <b>Factory setting:</b> 0 A
(1) In corresponds to the rated drive current indicated in the Installation Manual and on the drive nameplate.	



# [Generic functions] – [Power Backup]

## [Power Backup] RFT- Menu

### Access

[Complete settings] → [Generic functions] → [Power Backup]

### About This Menu

This function can only be used on drives with power up to 18.5 kW.

This function is used to supply the drive, in case of power outage, with a backup power supply connected to the drive in order to operate temporary the drive. This backup power supply is at a reduced voltage, and only allows a derated operating mode, at reduced speed, up to a given torque linked to the capability of the backup power supply.

To operate the drive within this derated operating mode, a digital input of the drive is assigned to this function. This assigned digital input must not be activated when the drive is powered with the mains supply.

When this function is enabled, the [Input phase loss] IPL- monitoring function is disabled.

Switching between the mains supply and the backup power supply must only be done with changeover contactors.

**⚠ DANGER**

**HAZARD OF FIRE OR EXPLOSION**

You must refer to the application note "Power Backup" to implement this function.

**Failure to follow these instructions will result in death or serious injury.**

The synoptic below shows an example of implementation.

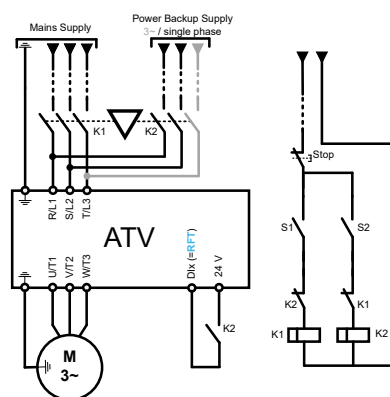

## [Power Backup Assign] RFT

The assigned input is used to activate the power backup mode of the drive (state at 1). This input must not be activated when the drive is powered with the mains supply.

Setting	Code / Value	Description
[Not Assigned]	NO	Not assigned <b>Factory setting</b>
[DI1]... [DI8]	LI1...LI8	Digital input DI1...DI8 <b>NOTE:</b> DI8 selection can be accessed on drives with a power greater than 22KW.
[DI11]... [DI16]	LI11... LI16	Digital input DI11...DI16 if VW3A3203 I/O extension module has been inserted

## [Pwr Backup Voltage] RSU

Minimum permissible AC voltage value of the backup power supply.

This parameter can be accessed if the power backup has been enabled (i.e [Power Backup Assign] RFT is assigned).

Setting	Description
220...320 V (step: 1 V)	Setting range <b>Factory setting:</b> 220 V

## [Pwr Backup Ref Freq] RSP

Value of the frequency reference in power backup mode: the value must be adapted according to the application requirements, especially the required torque within the derated operating mode.

Find below the power backup reference frequency setting range according to the power backup voltage:

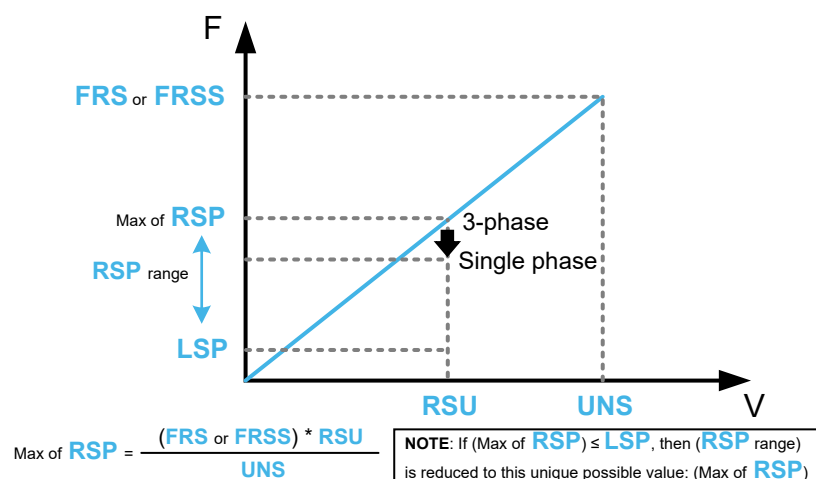

**NOTE:** Compared to a 3-phase power backup supply, the [Pwr Backup Ref Freq] RSP value may need to be reduced in order to provide the nominal torque with a single phase power backup supply. For more information, you must refer to the application note "Power Backup".

This parameter can be accessed if the power backup has been enabled (i.e [Power Backup Assign] RFT is assigned).

Setting ( )	Description
0.0...6,553.5 Hz (step: 0.1 Hz)	<p>Setting range: <b>[Low Speed] LSP</b> up to a maximum calculated according to <b>[Pwr Backup Voltage] RSU</b>, <b>[Nom Motor Voltage] UNS</b> and <b>[Nominal Motor Freq] FRS</b> (for an asynchronous law) or <b>[Sync Nominal Freq] FRSS</b> (for a synchronous law). The setting range can be reduced to a single value. See the figure above.</p> <p><b>Factory setting:</b> 5.0 Hz</p>

## [Generic monitoring]

### [Process underload] ULD– Menu

#### Access

[Complete settings] → [Generic monitoring] → [Process underload]

#### Process Underload Detected Error

A process underload is detected when the next event occurs and remains pending for a minimum time **[Unld Detect Delay] ULT**, which is configurable:

- The motor is in steady state and the torque is below the set underload limit (**[Unld.Thr.0.Speed] LUL**, **[Unld.Thr.Nom.Speed] LUN**, **[Unld. FreqThr. Det.] RMUD** parameters).
- The motor is in steady state when the offset between the frequency reference and motor frequency falls below the configurable threshold **[Hysteresis Freq] SRB**.

Between zero frequency and the rated frequency, the curve reflects the following equation:  $\text{torque} = LUL + (LUN - LUL) \times (\text{frequency})^2 / (\text{rated frequency})^2$  The underload function is not active for frequencies below **RMUD**.

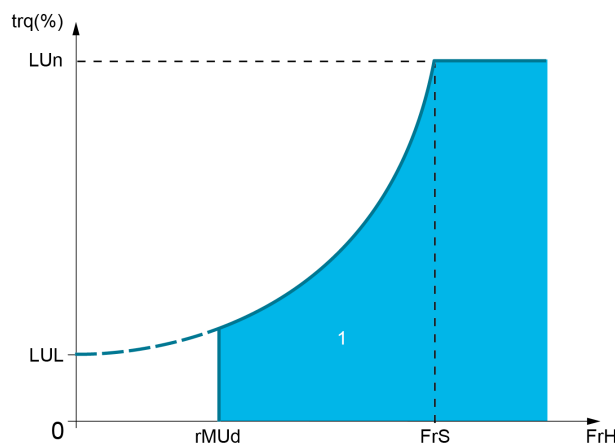

1 Underload zone.

A relay or a digital output can be assigned to the signaling of this detected error in the **[Input/Output] IO–**, **[I/O assignment] IOAS–** menus.

#### [Unld Detect Delay] ULT

It is reset to zero if the torque rises above the value of **[Unld.Thr.0.Speed] LUL** + 10% (hysteresis).

A value of 0 deactivates the function and makes the other parameters inaccessible.

Setting	Description
0...100 s	Setting range <b>Factory setting:</b> 0 s

### [Unld.Thr.Nom.Speed] LUN ★

Underload threshold at nominal motor speed [Nominal Motor Freq] FRS, as a % of the rated motor torque.

This parameter can be accessed if [Unld Detect Delay] ULT is not set to 0.

Setting ( )	Description
20...100%	Setting range <b>Factory setting:</b> 60%

### [Unld.Thr.0.Speed] LUL ★

Underload threshold at zero frequency as a % of the rated motor torque.

This parameter can be accessed if [Unld Detect Delay] ULT is not set to 0.

Setting ( )	Description
0...[Unld.Thr.Nom.Speed] LUN	Setting range <b>Factory setting:</b> 0%

### [Unld. FreqThr. Det.] RMUD ★

Minimum frequency underload detection threshold.

This parameter can be accessed if [Unld Detect Delay] ULT is not set to 0.

Setting ( )	Description
0.0...599.0 Hz	Setting range <b>Factory setting:</b> 0.0 Hz

### [Hysteresis Freq] SRB ★

Maximum deviation between the frequency reference and the motor frequency, which defines a steady state operation.

This parameter can be accessed if [Unld Detect Delay] ULT or [Ovld Detection Delay] TOL is not set to 0.

Setting ( )	Description
0.3...599.0 Hz	Setting range <b>Factory setting:</b> 0.3 Hz

### [Underload ErrorResp] UDL ★

Behavior on switching to underload detection.

This parameter can be accessed if [Unld Detect Delay] ULT is not set to 0.

Setting	Code / Value	Description
[Ignore]	NO	Detected error ignored
[Freewheel Stop]	YES	Freewheel stop

Setting	Code / Value	Description
		<b>Factory setting</b>
<b>[Ramp stop]</b>	RMP	Stop on ramp
<b>[Fast stop]</b>	FST	Fast stop

## **[Underload T.B.Rest.] FTU** ★

Minimum time permitted between an underload being detected and any automatic restart.

To allow an automatic restart, the value of **[Fault Reset Time]** TAR must exceed this parameter by at least 1 minute.

This parameter can be accessed if **[Underload ErrorResp]** UDL is not set to **[Ignore]** NO.

Setting ( )	Description
0...6 min	Setting range <b>Factory setting:</b> 0 min

## [Process overload] OLD- Menu

### Access

[Complete settings] → [Generic monitoring] → [Process overload]

### About This Menu

A process overload error is detected when the next event occurs and remains pending for a minimum time [Ovld Detection Delay] TOL, which is configurable:

- The drive is in [Current Limitation] CLI mode during acceleration, deceleration, or,
- The motor is in steady state and the [Motor Current] LCR is above the set overload threshold [Overload Threshold] LOC.

The motor is in steady state when the offset difference between [Pre-Ramp Ref Freq] FRH and [Motor Frequency] RFR is less than the configurable threshold [Hysteresis Freq] SRB.

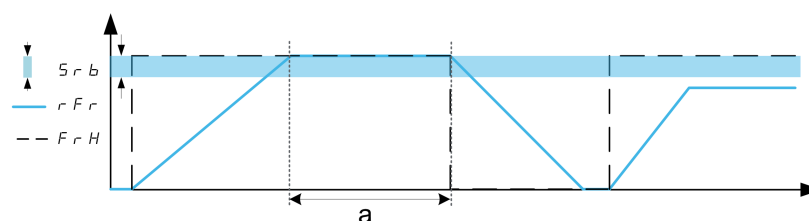

**NOTE:** Process overload monitoring is always active in [Current Limitation] CLI state.

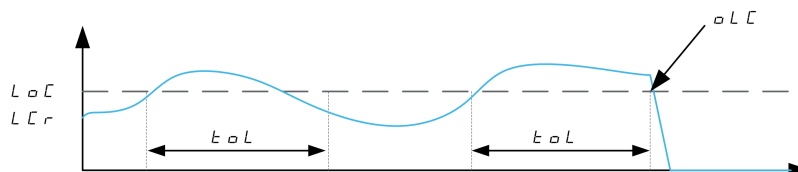

### [Ovld Detection Delay] TOL

A value of 0 deactivates the function and makes the other parameters inaccessible.

Setting	Description
0...100 s	Setting range Factory setting: 0 s

### [Overload Threshold] LOC ★

Overload detection threshold, as a % of the rated motor current [Nom Motor Current] NCR. This value must be less than the limit current in order for the function to work.

This parameter can be accessed if [Ovld Detection Delay] TOL is not set to 0.

Setting (°)	Description
70...150%	Setting range Factory setting: 110%

**[Hysteresis Freq] SRB** ★

Hysteresis for steady state.

Maximum deviation between the frequency reference and the motor frequency, which defines a steady state operation.

This parameter can be accessed if **[Ovld Detection Delay]** TOL or **[Unld Detect Delay]** ULT is not set to 0.

Setting ( )	Description
0.3...599.0 Hz	Setting range <b>Factory setting:</b> 0.3 Hz

**[Overload ErrorResp] ODL** ★

Behavior on switching to overload detection.

This parameter can be accessed if **[Ovld Detection Delay]** TOL is not set to 0.

Setting	Code / Value	Description
<b>[Ignore]</b>	NO	Detected error ignored
<b>[Freewheel Stop]</b>	YES	Freewheel stop <b>Factory setting</b>
<b>[Ramp stop]</b>	RMP	Stop on ramp
<b>[Fast stop]</b>	FST	Fast stop

**[Overload T.B.Rest.] FTO** ★

Minimum time permitted between an overload being detected and any automatic restart.

In order to allow an automatic restart, the value of **[Fault Reset Time]** TAR must exceed this parameter by at least 1 minute.

This parameter can be accessed if **[Ovld Detection Delay]** TOL or **[Overload ErrorResp]** ODL is not set to 0.

Setting ( )	Description
0...6 min	Setting range <b>Factory setting:</b> 0 min



## [Stall monitoring] STPR- Menu

### Access

[Complete settings] → [Generic monitoring] → [Stall monitoring]

### About This Menu

This function helps to prevent a motor overload by monitoring the motor current and the speed rise time.

A stalling condition is when:

- An output frequency is smaller than the stalling frequency **[Stall Frequency]** STP3
- And an output current is higher than the stalling current **[Stall Current]** STP2
- During a time longer than the stalling time **[Stall Max Time]** STP1

When a stalling condition occurs, a **[Motor Stall Error]** STF error is triggered.

### [Stall Monitoring] STPC

*Stall monitoring activation.*

Setting	Code / Value	Description
[No]	NO	Function disabled <b>Factory setting</b>
[Yes]	YES	Function enabled

### [Stall Max Time] STP1 ★

This parameter can be accessed if **[Stall Monitoring]** STPC is not set to **[No]** NO.

Setting ( )	Description
0.0...200 s	Setting range <b>Factory setting:</b> 60.0 s

### [Stall Current] STP2 ★

Stall monitoring current level, as a % of the rated motor current. (**[Nom Motor Current]** NCR or **[Sync Nominal I]** NCRS, depending on the motor control type.)

This parameter can be accessed if **[Stall Monitoring]** STPC is not set to **[No]** NO.

The factory setting changes to 150.0 % if **[Dual rating]** DRT is set to **[Heavy Duty]** HIGH.

Setting ( )	Description
0.0...120.0%	Setting range <b>Factory setting:</b> 150.0%

## [Stall Frequency] STP3 ★

This parameter can be accessed if **[Stall Monitoring]** STPC is not set to **[No]** NO.

Setting ( )	Description
0.0... <b>[Max Frequency]</b> TFR	Setting range <b>Factory setting:</b> 2.0 Hz

## [Thermal monitoring] TPP- Menu

### Access

[Complete settings] → [Generic monitoring] → [Thermal monitoring]

### About This Menu

Identical to [Thermal monitoring] TPP- Menu , page 147.

## [Frequency meter] FQF- Menu

### Access

[Complete settings] → [Generic monitoring] → [Frequency meter]

### About This Menu

This function uses the "Pulse input" input and can only be used if the "Pulse input" input is not being used for another function.

### Example of Use

An indexed disk driven by the motor and connected to a proximity sensor can be used to generate a frequency signal that is proportional to the speed of rotation of the motor.

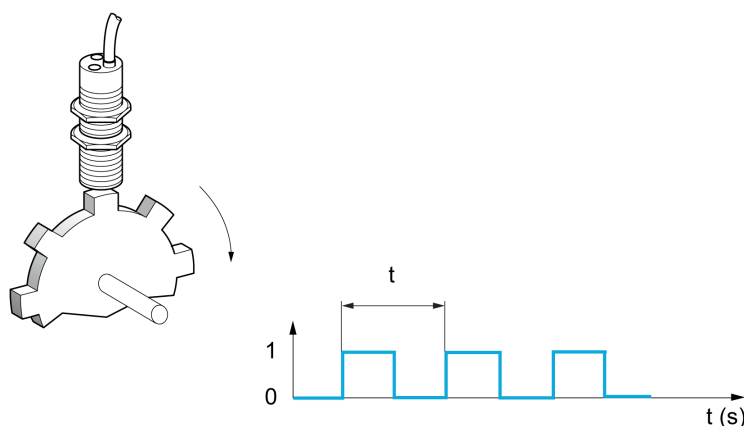

When applied to the "Pulse input" input, this signal supports:

- Measurement and display of the motor speed: signal frequency =  $1/T$ . This frequency is displayed with the **[Measured Freq] FQS**.
- Overspeed detection (if the measured speed exceeds a preset threshold, the drive triggers an error).
- Brake failure detection if brake logic control has been configured: If the speed does not drop sufficiently quickly following a command to engage the brake, the drive triggers an error. This function can be used to detect worn brake linings.
- Detection of a speed threshold that can be adjusted using **[Pulse warning thd.] FQL**, page 406 and is assignable to a relay or digital output.

## [Frequency meter] FQF

### Frequency meter.

Setting	Code / Value	Description
[Not Configured]	NO	Not assigned <b>Factory Setting</b>
[DI7 PulseInput]...[DI8 PulseInput]	PI7...PI8	Digital input DI7...DI8 used as pulse input <b>NOTE:</b> This selection can be accessed on drives with a power greater than 22kW.
[RP]	PI	Pulse input <b>NOTE:</b> This selection can be accessed on drives with a power below than 30 kW.

### [Pulse scal. divider] FQC

Coefficient for measure.

The frequency measured is displayed with the [Measured Freq] FQS parameter.

Setting ( )	Description
1.0...100.0	Setting range <b>Factory setting:</b> 1.0

### [Overspd. pulse thd.] FQA

Maximum frequency authorized.

Activation and adjustment of overspeed monitoring: [Motor Overspeed] SOF.

Setting	Code / Value	Description
[No]	NO	No motor overspeed monitoring <b>Factory setting</b>
0...30 kHz		Adjustment of the frequency tripping threshold on the "Pulse input" input divided by [Pulse scal. divider] FQC.

### [Pulse overspd delay] TDS

*Pulse Overspeed delay.*

Setting	Description
0.0...10.0 s	Setting range <b>Factory setting:</b> 0.0 s

### [Level fr. pulse ctrl] FDT

Feedback detection threshold.

Activation and adjustment of monitoring for the pulse input (speed feedback): [Encoder Feedback Loss] SPF.

Setting	Code / Value	Description
[No]	NO	No monitoring of speed feedback <b>Factory setting</b>
0.0...599 Hz		Adjustment of the motor frequency threshold for tripping a speed feedback detection. (difference between the estimated frequency and the measured speed).

### [Pulse thd. wo Run] FQT

Frequency threshold wear brake.

Activation and adjustment of brake feedback monitoring: [Brake Feedback] BRF.  
If brake logic control [Brake assignment] BLC is not configured, this parameter is forced to [No] NO.

Setting	Code / Value	Description
[No]	NO	No brake monitoring <b>Factory setting</b>
1...1,000 Hz		Adjustment of the motor frequency threshold to trigger a <b>[Brake Feedback] BRF</b> error (detection of speeds other than 0).

### [Pulse wo Run delay] TQB

Time before triggering in wear brake.

Setting	Description
0.0...10.0 s	Setting range <b>Factory setting:</b> 0.0 s

### [Pulse warning thd.] FQL

Frequency level.

This parameter can be accessed if **[Frequency meter] FQF** is not set to **[Not Configured] NO**.

Setting	Description
0...30,000 Hz	Setting range <b>Factory setting:</b> 0 Hz

## [Input/Output] - [I/O assignment]

### [DI1 Assignment] L1A– to [DI8 Assignment] L8A– Menus

#### Access

[Complete settings] → [Input/Output] → [I/O assignment] → [DI8 Assignment]

#### About These Menus

On drives with a power equal to or lower than 22 kW, DI6 and DI7 are respectfully DO1 and DO2 used as Digital Input.

DI8 is only accessible on drive with power greater than 22 kW.

### [DI1 Low Assignment] L1L to [DI8 Low Assignment] L8L

Read-only parameter, cannot be configured. It displays all the functions associated with digital input in order to verify, for example, for compatibility problems.

If no functions have been assigned, **[No]** NO is displayed.

### [DI1 High Assignment] L1H to [DI8 High Assignment] L8H

Read-only parameter, cannot be configured. It displays all the functions associated with digital input in order to verify, for example, for compatibility problems.

If no functions have been assigned, **[No]** NO is displayed.

## [DI11 Assignment] L11A– to [DI16 Assignment] L16A– Menus

### Access

[Complete settings] → [Input/Output] → [I/O assignment] → [DI11 Assignment] to [DI16 Assignment]

### About These Menus

Identical to [DI1 Assignment] L1A– menu , page 407.

These menus can be accessed if VW3A3203 I/O extension module has been inserted.

### [DI11 Low Assignment] L11L to [DI16 Low Assignment] L16L ★

Read-only parameters, cannot be configured. It displays all the functions associated with the digital input in order to verify, for example, for compatibility problems.

If no functions have been assigned, [No] NO is displayed.

### [DI11 High Assignment] L11H to [DI16 High Assignment] L16H ★

Read-only parameters, cannot be configured. It displays all the functions associated with the digital input in order to verify, for example, for compatibility problems. If no functions have been assigned, [No] NO is displayed.



## [DI7 Pulse Input Assign] PI7A- Menu

### Access

[Complete settings] → [Input/Output] → [I/O assignment] → [DI7 Pulse Input Assign]

### About This Menu

Following parameters can be accessed on the Display Terminal by pressing the OK key on the [DI7 Frequency measured] PFC7 parameter.

This menu can be accessed on drives with a power **greater than 22 kW**.

### [DI7 Pulse Input Assign] PI7A

It displays all the functions associated with the pulse input in order to verify, for example, for compatibility problems.

If no functions have been assigned, [No] NO is displayed.

Setting	Code / Value	Description
[No]	NO	Not assigned
[Torque Ref Offset]	AITQO	Torque offset source
[Torque Ref Ratio]	AITQR	Torque ratio source
[Ref Frequency 1]	AIFR1	Reference frequency 1
[Ref Frequency 2]	AIFR2	Reference frequency 2
[Ref Frequency 2 Summing]	AISA2	Reference frequency 2 summing
[Torque limitation]	AITAA	Torque limitation: activation by an analog value
[Torque limitation 2]	AITAA2	Torque limitation: activation by an analog value
[Subtract Ref Freq 2]	AIDA2	Subtract reference frequency 2
[Forced local]	AIFLOC	Forced local reference source1
[Ref Frequency 2 multiplier]	AIMA2	Reference frequency 2 multiplier
[Ref Frequency 3 multiplier]	AIMA3	Reference frequency 3 multiplier
[Torque reference]	AITR1	Torque regulation: torque set point 1
[Torque reference 2]	AITR2	Torque regulation: torque set point 2
[Frequency Meter]	FQF	Frequency meter function activation
[External Feed Forward]	AITEFF	External feed-forward

## [DI8 Pulse Input Assign] PI8A– Menu

### Access

[Complete settings] → [Input/Output] → [I/O assignment] → [DI8 Pulse Input Assign]

### About This Menu

Identical to [DI7 Pulse Input Assign] PI7A– , page 409.

Following parameters can be accessed on the Display Terminal by pressing the OK key on the [DI8 Frequency measured] PFC8 parameter.

This menu can be accessed on drives with a power greater than 22kW.

## [DI8 Pulse Input Assign] PI8A

Identical to [DI7 Pulse Input Assign] PI7A , page 409

## [Encoder Pulse Assign] PTGA– Menu

### Access

[Complete settings] → [Input/Output] → [I/O assignment] → [Encoder Pulse Assign]

### About This Menu

Following parameters can be accessed on the Graphic Display Terminal by pressing the OK key on the [Encoder Config] PG parameter.

This parameter can be accessed if an encoder module has been plugged.

## [Encoder Pulse Assign] PTGA

It displays all the functions associated with the pulse input in order to verify, for example, compatibility problems.

If no functions have been assigned, [No] NO is displayed.

Identical to [DI7 Pulse Input Assign] PI7A , page 409.

## [RP assignment] PIA– Menu

### Access

[Complete settings] → [Input/Output] → [I/O assignment] → [RP assignment]

### About This Menu

This menu can be accessed on drives with a power **lower than 30kW**.

## [RP assignment] PIA ★

Identical to [DI7 Pulse Input Assign] PI7A , page 409

## [AI1 assignment] AI1A– to [AI5 assignment] AI5A– Menus

### Access

[Complete settings] → [Input/Output] → [I/O assignment] → [AI1 assignment] to [AI5 assignment]

### About These Menus

AI3 can be accessed on drives with a power greater than 22kW.

AI4 and AI5 can be accessed if VW3A3203 I/O extension module has been inserted.

## [AI1 assignment] AI1A to [AI5 assignment] AI5A

Analog input AI1 functions assignment to Analog input AI5 functions assignment.

Read-only parameter, cannot be configured. It displays all the functions associated the related analog input in order to verify, for example, for compatibility problems.

If no functions have been assigned, [No] NO is displayed.

## [AIV1 assignment] AV1A– Menu

### Access

[Complete settings] → [Input/Output] → [I/O assignment] → [AIV1 assignment]

### [AIV1 assignment] AV1A

Virtual analog input function assignment.

Read-only parameter, cannot be configured. It displays all the functions associated with the related virtual analog input in order to verify, for example, for compatibility problems. If no functions have been assigned, **[No]** NO is displayed.

## [Input/Output] - [DI/DQ]

### [DI1 Configuration] DI1- to [DI8 Configuration] DI8- Menus

#### Access

[Complete settings] → [Input/Output] → [DI/DQ] → [DI1 Configuration] to [DI8 Configuration]

#### About These Menus

On drives with a power equal to or lower than 22 kW, DI6 and DI7 are respectfully DO1 and DO2 used as Digital Input.

DI8 is only accessible on drive with power greater than 22 kW.

### [DI1 Low Assignment] L1L to [DI8 Low Assignment] L8L

Read-only parameter, cannot be configured. It displays all the functions associated with the related digital input in order to verify, for example, for compatibility problems.

If no functions have been assigned, [No] NO is displayed.

### [DI1 High Assignment] L1H to [DI8 High Assignment] L8H

Read-only parameter, cannot be configured. It displays all the functions associated with the related digital input in order to verify, for example, for compatibility problems.

If no functions have been assigned, [No] NO is displayed.

The digital input DI1 is assigned to:

- [Forward] FRD in 2-wire control
- [Drive Running] RUN in 3-wire control.

[Drive Running] RUN and [Forward] FRD settings cannot be modified manually.

**NOTE:** In IO profile, the assignment of [Drive Running] RUN (respectively [Forward] FRD) switches to [CD00] CD00 in 2-wire control (respectively 3-wire control).

The digital input DI2 is assigned to [Forward] FRD in 3-wire control. [Forward] FRD setting cannot be modified manually.

**NOTE:** In IO profile, the assignment of [Forward] FRD switches to [CD01] CD01 in 3-wire control.

### [DI1 Delay] L1D to [DI8 Delay] L8D

**NOTE:** Commands received via this digital input are processed once the delay time set via this parameter has elapsed.

Setting	Description
0...200 ms	Setting range <b>Factory setting:</b> 2 ms

## [DI11 Configuration] DI11- to [DI16 Configuration] DI16- Menus

### Access

[Complete settings] → [Input/Output] → [DI/DQ] → [DI11 Configuration] to [DI16 Configuration]

### About These Menus

Identical to [DI1 Configuration] DI1- menu , page 413.

These menus can be accessed if VW3A3203 I/O extension module has been inserted.

### [DI11 Low Assignment] L11L to [DI16 Low Assignment] L16L ★

*DI11 low assignment to DI16 low assignment.*

### [DI11 High Assignment] L11H to [DI16 High Assignment] L16H ★

*DI11 high assignment to DI16 high assignment.*

### [DI11 Delay] L11D to [DI16 Delay] L16D ★

*DI11 delay to DI16 delay.*

## [DI7 Pulse Config] PAI7– Menu

### Access

[Complete settings] → [Input/Output] → [DI/DQ] → [DI7 Pulse Config]

### About This Menu

Following parameters can be accessed on the Display Terminal by pressing the **OK** key on the [DI7 Frequency measured] PFC7 parameter.

This menu can be accessed on drives with a power **greater than 22 kW**.

### [DI7 Pulse Input Assign] PI7A

It displays all the functions associated with the pulse input in order to verify, for example, for compatibility problems.

If no functions have been assigned, [No] NO is displayed.

Setting	Code / Value	Description
[No]	NO	Not assigned
[Torque Ref Offset]	AITQO	Torque offset source
[Torque Ref Ratio]	AITQR	Torque ratio source
[Ref Frequency 1]	AIFR1	Reference frequency 1
[Ref Frequency 2]	AIFR2	Reference frequency 2
[Ref Frequency 2 Summing]	AISA2	Reference frequency 2 summing
[PID feedback]	AIPIF	PI controller feedback
[Torque limitation]	AITAA	Torque limitation: activation by an analog value
[Torque limitation 2]	AITAA2	Torque limitation: activation by an analog value
[Subtract Ref Freq 2]	AIDA2	Subtract reference frequency 2
[Manual PID ref.]	AIPIM	Manual speed reference of the PID controller (auto-man)
[PID Ref Frequency]	AIFPI	PID reference frequency
[Ref Frequency 3 Summing]	AISA3	Reference frequency 3 summing
[Ref Frequency 1B]	AIFR1B	Reference frequency 1B
[Subtract Ref Freq 3]	AIDA3	Subtract reference frequency 3
[Forced local]	AIFLOC	Forced local reference source1
[Ref Frequency 2 multiplier]	AIMA2	Reference frequency 2 multiplier

Setting	Code / Value	Description
[Ref Frequency 3 multiplier]	AIMA3	Reference frequency 3 multiplier
[Torque reference]	AITR1	Torque regulation: torque set point 1
[Torque reference 2]	AITR2	Torque regulation: torque set point 2
[Frequency Meter]	FQF	Frequency meter function activation
[External Feed Forward]	AITEFF	External feed-forward

### [DI7 PulseInput Low Freq] PII7

Pulse input scaling parameter of 0% in Hz x 10 unit.

Setting	Description
0.00...30,000.00 Hz	Setting range <b>Factory setting:</b> 0.00 Hz

### [DI7 PulseInput High Freq] PIH7

Pulse input scaling parameter of 100% in Hz x 10 unit.

Setting	Description
0.00...30.00 kHz	Setting range <b>Factory setting:</b> 30.00 kHz

### [DI7 Frequency Filter] PFI7

Interference filtering pulse input cut-off time of the low-filter.

Setting	Description
0...1,000 ms	Setting range <b>Factory setting:</b> 0 ms



## [DI8 Pulse Config] PAI8– Menu

### Access

[Complete settings] → [Input/Output] → [DI/DQ] → [DI8 Pulse Config]

### About This Menu

Following parameters can be accessed on the Display Terminal by pressing the **OK** key on the [DI8 Frequency measured] PFC8 parameter.

This menu can be accessed on drives with a power **greater than 22 kW**.

### [DI8 Pulse Input Assign] PI8A

Identical to [DI7 Pulse Input Assign] PI7A , page 415.

### [DI8 PulseInput Low Freq] PIL8

Identical to [DI7 PulseInput Low Freq] PIL7 , page 416.

### [DI8 PulseInput High Freq] PIH8

Identical to [DI7 PulseInput High Freq] PIH7 , page 416.

### [DI8 Frequency Filter] PFI8

Interference filtering pulse input cut-off time of the low-filter.

Identical to [DI7 Frequency Filter] PFI7 , page 416.

## [Pulse Input] PTI– Menu

### Access

[Complete settings] → [Input/Output] → [DI/DQ] → [Pulse Input]

### About This Menu

This menu can be accessed on drives with a power **lower than 30kW**.

### [RP assignment] PIA ★

#### *Pulse input assignment*

Setting	Code / Value	Description
[No]	NO	Not assigned
[Torque Ref Offset]	AITQO	Torque offset source
[Torque Ref Ratio]	AITQR	Torque ratio source
[Ref Frequency 1]	AIFR1	Reference frequency 1
[Ref Frequency 2]	AIFR2	Reference frequency 2
[Ref Frequency 2 Summing]	AISA2	Reference frequency 2 summing
[PID feedback]	AIPIF	PI controller feedback
[Torque limitation]	AITAA	Torque limitation: activation by an analog value
[Torque limitation 2]	AITAA2	Torque limitation: activation by an analog value
[Subtract Ref Freq 2]	AIDA2	Subtract reference frequency 2
[Manual PID ref.]	AIPIM	Manual speed reference of the PID controller (auto-man)
[PID Ref Frequency]	AIFPI	PID reference frequency
[Ref Frequency 3 Summing]	AISA3	Reference frequency 3 summing
[Ref Frequency 1B]	AIFR1B	Reference frequency 1B
[Subtract Ref Freq 3]	AIDA3	Subtract reference frequency 3
[Forced local]	AIFLOC	Forced local reference source1
[Ref Frequency 2 multiplier]	AIMA2	Reference frequency 2 multiplier
[Ref Frequency 3 multiplier]	AIMA3	Reference frequency 3 multiplier
[Torque reference]	AITR1	Torque regulation: torque set point 1

Setting	Code / Value	Description
[Torque reference 2]	AITR2	Torque regulation: torque set point 2
[Frequency Meter]	FQF	Frequency meter function activation
[External Feed Forward]	AITEFF	External feed-forward

[PTI Low Freq] PTIL ★

*PTI low Freq.*

Setting	Description
-1000000.00...1000000.00 Hz	Setting range <b>Factory setting:</b> 0 Hz

[PTI High Freq] PTIH ★

*PTI high frequency.*

Setting	Description
-1000000.00...1000000.00 Hz	Setting range <b>Factory setting:</b> 0 Hz

[PTI Filter Time Analog] PTIT ★

*PTI filter time analog*

Setting	Description
0...1000 ms	Setting range <b>Factory setting:</b> 0 ms

[PTI Mode] PTIM ★

*PTI mode*

Setting	Code / Value	Description
[A/B]	AB	A/B input signals <b>Factory Setting</b>
[Pulse/Dir]	PD	Pulse direction input signals
[CW/CCW]	CWCCW	Clockwise/Counterclockwise input signals

[PTI Filter Time Inp] PTIS ★

*PTI filter time inp*

Setting	Description
0.00...13.00 μs	Setting range <b>Factory setting:</b> 0.25 μs

[PTI Counting Dir Inv] PTII ★

*PTI direction inversion*

Setting	Code / Value	Description
[OFF]	OFF	No inversion of counting direction <b>Factory Setting</b>
[ON]	ON	Inversion of counting direction

## [Encoder Config] PG – Menu

### Access

[Complete settings] → [Input/Output] → [DI/DQ] → [Encoder Config]

### About This Menu

Following parameters can be accessed on the Graphic Display Terminal by pressing the OK key on the [Encoder Config] PG parameter.

This parameter can be accessed only if an encoder module has been inserted or embedded encoder is used.

### [Encoder Pulse Assign] PTGA

It displays all the functions associated with the pulse input in order to verify, for example, compatibility problems.

If no functions have been assigned, [No] NO is displayed.

### [Reference Type] PGA

*Reference type.*

Setting	Code / Value	Description
[Encoder]	ENC	Encoder <b>Factory Setting</b>
[Frequency Generator]	PTG	Pulse train generator is connected to the encoder board.

### [Freq Min Value] PEIL

Pulse input scaling parameter of 0% in kHz x 10 unit.

Setting	Description
-300.00..300.00 kHz	Setting range <b>Factory setting:</b> 0.00 kHz

### [Freq Max Value] PEFR

Pulse input scaling parameter of 100% in kHz x 10 unit.

Setting	Description
-300.00..300.00 kHz	Setting range <b>Factory setting:</b> 300 kHz

### [Freq Signal Filter] EFI

*Frequency signal filter.*

---

Setting	Description
0...1000 ms	Setting range <b>Factory setting:</b> 0 ms

## [PTO configuration] PTO– Menu

### Access

[Complete settings] → [Input/Output] → [DI/DQ] → [PTO configuration]

### About This Menu

This menu can be accessed on drives with a power **greater than 22 kW**.

### [PTO Assign] PTO

#### *PTO assignment.*

Setting	Code / Value	Description
[Not Configured]	NO	Not assigned
[Motor Current]	OCR	Current in the motor, from 0 to 2 In (In = rated drive current indicated in the Installation manual and on the drive nameplate) <b>Factory Setting</b>
[Motor Frequency]	OFR	Output frequency, from 0 to [Max Frequency] TFR
[Ramp Out.]	ORP	From 0 to [Max Frequency] TFR
[Motor Torq.]	TRQ	Motor torque, from 0 to 3 times the rated motor torque
[Sign. Torque]	STQ	Signed motor torque, between –3 and +3 times the rated motor torque. The + sign corresponds to the motor mode and the – sign to the generator mode (braking).
[sign Ramp]	ORS	Signed ramp output, between – [Max Frequency] TFR and + [Max Frequency] TFR
[PID Ref.]	OPS	PID controller reference between [Min PID Process] PIP1 and [Max PID Process] PIP2
[PID Feedbk]	OPF	PID controller feedback between [Min PID feedback] PIF1 and [Max PID feedback] PIF2
[PID Error]	OPE	PID controller detected error between –5% and +5% of [Max PID feedback] PIF2 – [Min PID feedback] PIF1
[PID Output]	OPI	PID controller output between [Low Speed] LSP and [High Speed] HSP
[Motor Power]	OPR	Motor power, between 0 and 2.5 times [Nominal Motor Power] NPR
[Mot Thermal]	THR	Motor thermal state, from 0 to 200% of the rated thermal state
[Drv Thermal]	THD	Drive thermal state, from 0 to 200% of the rated thermal state
[Measured Motor Freq]	OFRR	Measured motor frequency
[Sig. O/P Frq.]	OFS	Signed output frequency, between – [Max Frequency] TFR and + [Max Frequency] TFR
[Mot Therm2]	THR2	Motor thermal 2 state
[Mot Therm3]	THR3	Motor thermal 3 state
[Mot therm4]	THR4	Motor thermal 4 state
[Unsigned Trq Ref]	UTR	Unsigned torque reference
[Signed Trq Ref]	STR	Signed torque reference
[Torque Lim.]	TQL	Torque limit

Setting	Code / Value	Description
[Motor volt.]	UOP	Voltage applied to the motor, between 0 and [Nom Motor Voltage] UNS
[DC Bus voltage]	VBUS	DC bus voltage
[Copy PI8]	COPY	Copy Pulse

### [PTO Max Output Freq] PTOH ★

This parameter can be accessed if [PTO Assign] PTO is not set to [Not Configured] NO.

Setting	Description
1.00...30.00 kHz	Setting range Factory setting: 4.00 kHz

### [PTO Min Output Freq] PTOL ★

This parameter can be accessed if [PTO Assign] PTO is not set to [Not Configured] NO.

Setting	Description
1.00...30.00 kHz	Setting range Factory setting: 1.00 kHz



## [PTO configuration] PTOO– Menu

### Access

[Complete settings] → [Input/Output] → [DI/DQ] → [PTO configuration]

### About This Menu

This menu is used to configure the Pulse Train Output (PTO) of the drive.

This menu can only be accessed on drives with a power **equal to or lower than 22 kW**.

### [PTO Mode Selection] PTOM

*PTO mode selection.*

Setting	Code / Value	Description
[Not Configured]	OFF	Not assigned <b>Factory Setting</b>
[PTI Signal]	PTI	PTI signal: Pulse Train Input signal is repeated on the Pulse Train Output.
[PTO Assigned Param]	CONS	PTO assigned parameter: the Pulse Train Output signal depends on its assignment ([PTO Assign] PTOE) but also on its configuration ([PTO High Freq] PTOU, [PTO Low Freq] PTOB, [PTO Freq Value] PTOF).

### [PTO Assign] PTOE ★

This parameter can be accessed if [PTO Mode Selection] PTOM is set to [PTO Assigned Param] CONS.

Setting	Code / Value	Description
[Not Configured]	NO	Not assigned <b>Factory Setting</b>
[Motor Current]	OCR	Current in the motor, from 0 to 2 In (In = rated drive current indicated in the Installation manual and on the drive nameplate)
[Motor Frequency]	OFR	Output frequency, from 0 to [Max Frequency] TFR
[Measured Motor Freq]	OFRR	Measured motor frequency
[Sig. O/P Frq.]	OFS	Signed output frequency, between – [Max Frequency] TFR and + [Max Frequency] TFR
[PID Error]	OPE	PID controller detected error between –5% and +5% of [Max PID feedback] PIF2 – [Min PID feedback] PIF1
[PID Feedbk]	OPF	PID controller feedback between [Min PID feedback] PIF1 and [Max PID feedback] PIF2
[PID Output]	OPI	PID controller output between [Low Speed] LSP and [High Speed] HSP
[Motor Power]	OPR	Motor power, between 0 and 2.5 times [Nominal Motor Power] NPR
[PID Ref.]	OPS	PID controller reference between [Min PID Process] PIP1 and [Max PID Process] PIP2
[Ramp Out.]	ORP	From 0 to [Max Frequency] TFR

Setting	Code / Value	Description
[sign Ramp]	ORS	Signed ramp output, between – [Max Frequency] TFR and + [Max Frequency] TFR
[Signed Trq Ref]	STR	Signed torque reference
[Sign. Torque]	STQ	Signed motor torque, between –3 and +3 times the rated motor torque. The + sign corresponds to the motor mode and the – sign to the generator mode (braking).
[Drv Thermal]	THD	Drive thermal state, from 0 to 200% of the rated thermal state
[Mot Thermal]	THR	Motor thermal state, from 0 to 200% of the rated thermal state
[Mot Therm2]	THR2	Motor thermal 2 state
[Mot Therm3]	THR3	Motor thermal 3 state
[Mot therm4]	THR4	Motor thermal 4 state
[Torque Lim.]	TQL	Torque limit
[Torque 4Q]	TR4Q	Signed motor torque, between -3 and +3 times the rated motor torque. The + and - signs correspond to the physical direction of the torque, regardless of mode (motor or generator)
[Motor Torq.]	TRQ	Motor torque, from 0 to 3 times the rated motor torque
[Unsigned Trq Ref]	UTR	Unsigned torque reference
[Motor volt.]	UOP	Voltage applied to the motor, between 0 and [Nom Motor Voltage] UNS

### [PTO High Freq] PTOU ★

Scaling parameter for 100 % of the analog signal.

This parameter can be accessed if [PTO Mode Selection] PTOM is set to [PTO Assigned Param] CONS.

Setting	Description
-1,000,000.00...1,000,000.00 Hz	Setting range: the lower setting value is limited to [PTO Low Freq] PTOB. <b>Factory setting:</b> 1,000,000.00 Hz

### [PTO Low Freq] PTOB ★

Scaling parameter for 0 % of the analog signal.

This parameter can be accessed if [PTO Mode Selection] PTOM is set to [PTO Assigned Param] CONS.

Setting	Description
-1,000,000.00...1,000,000.00 Hz	Setting range: the maximum setting value is limited to [PTO High Freq] PTOU. <b>Factory setting:</b> 0.00 Hz

### [PTO Freq Value] PTOF ★

This parameter can be accessed if [PTO Mode Selection] PTOM is set to [PTO Assigned Param] CONS.

Setting	Description
-1,000,000.00...1,000,000.00 Hz	Setting range <b>Factory setting:</b> Read-only parameter

## [DQxx Configuration] D0xx- Menu

### Access

[Complete settings] → [Input/Output] → [DI/DQ] → [DQxx Configuration]

### About This Menu

These menus are used to configure the digital outputs of the drive:

- **[DQ1 configuration] D01-**: The digital output DQ1 embedded to the drive.
- **[DQ2 Configuration] D02-**: The digital output DQ2 embedded to the drive. DQ2 is only available with power equal to or lower than 22 kW.
- **[DQ11 Configuration] D011-** and **[DQ12 Configuration] D012-**: the digital output DQ11 and DQ12 if the VW3A3203 Extended I/O option module is inserted.

**NOTE:** On drive with power equal to or lower than 22 kW, the digital output DQ1 (respectively DQ2) can also be used as a digital input DI6 (respectively DI7). If a function is assigned to this digital input, DQ1 (respectively DQ2) can no longer be used as a digital output.

**NOTE:** On drive with power equal to or greater than 30 kW, the digital output DQ1 can also be used as a Pulse Train Output (PTO). If a function is assigned to this PTO, DQ1 can no longer be used as a digital output.

Use the touch wheel to scroll through the digital outputs. Click OK to access the configuration of the digital output.

On Graphic Display Terminal, if an output is assigned then a check mark is displayed.

For a given digital output (DQxx), the configuration is composed by:

- **[DQxx assignment] D0xx-**: the assignment of the digital output DQxx,
- **[DQxx actv delay] DxxD**: the delay time of the digital output DQxx. It represents the delay before modifying the state of the output when the assigned event becomes true,
- **[DQxx status] DxxS**: the active level of the digital output DQxx. It defines the state 1 or 0 of the output to the "True" state of the assigned event.
- **[DQxx hold delay] DxxH**: the holding time of the digital output DQxx. It represents the delay before modifying the state of the output when the assigned event becomes false.
- **[Enable DQxx fallback] DxxF / LOxF**: parameter used to enable/disable the fallback mode triggered in case of communication interruption (if the output is controlled by fieldbus communication).

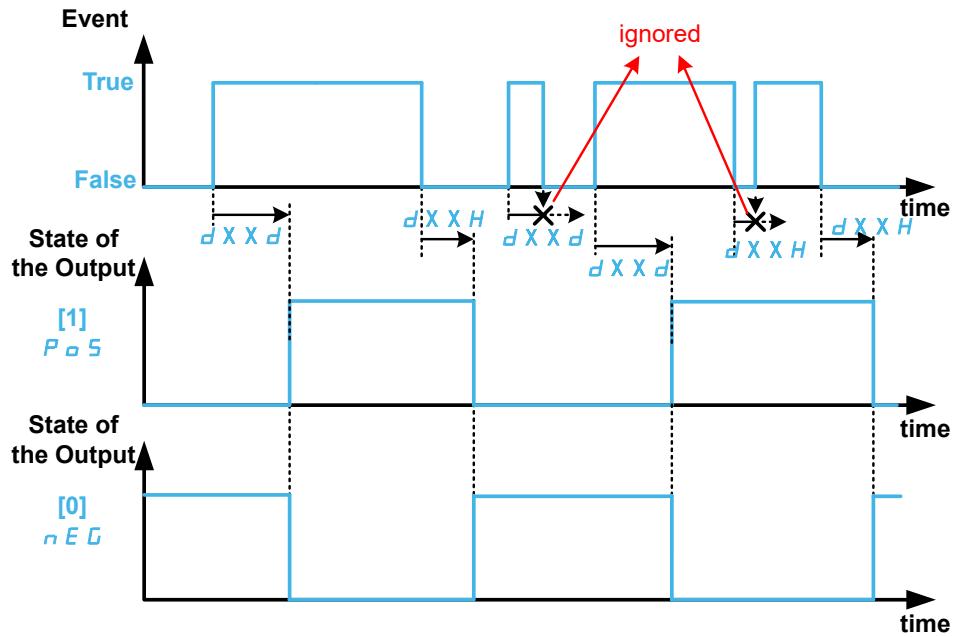

**[DQxx assignment] DOxx ★**

[DQ1 Assignment] DO1, [DQ2 Assign] DO2, [DQ11 assignment] DO11, [DQ12 assignment] DO12

Digital output xx assignment.

It is used to assign an output to an event or a function.

Possible settings: Identical to [Rx Assignment] Rx Menus, page 450.

If the output is set to [CDxx] CDxx or [Cxxx] Cxxx and has been enabled, transition to operating state Fault such as, but not limited to, communication interruption, will not disable the output.

<b>▲ WARNING</b>
<p><b>LOSS OF CONTROL</b></p> <p>Only set the output to [CDxx] CDxx or [Cxxx] Cxxx after having verified that this setting cannot result in unsafe conditions including communication interruption.</p> <p><b>Failure to follow these instructions can result in death, serious injury, or equipment damage.</b></p>

**[DQxx actv delay] DxxD ★**

DQxx activation delay time.

[DQ1 Delay time] DO1D, [DQ2 Delay time] DO2D, [DQ11 actv delay] D11D, [DQ12 actv delay] D12D

It represents the delay before modifying the state of the output when the assigned event becomes true.

If the corresponding output is assigned to one of the following assignments, the delay is forced to 0 ms and it cannot be modified:

- [Operating State Fault] FLT,
- [Mains Contactor] LLC,
- [DC charging] DCO,
- [Brake Sequence] BLC,

- **[Output cont]** OCC,

Value range	Description
0...60,000 ms (step: 1 ms)	0...9,999 ms then 10.00...60.00 s on the Display Terminal . <b>Factory setting:</b> 0 ms

## [DQxx status] DxxS ★

**[DQ1 Active at]** DO1S, **[DQ2 Active at]** DO2S, **[DQ11 status]** D11S, **[DQ12 status]** D12S

DQxx status (output active level)

It defines the state 1 or 0 of the output to the “True” state of the assigned event.

If the output is assigned to one of the following assignments, the delay is forced to **[High Level]** POS:

- **[Operating State Fault]** FLT,
- **[Mains Contactor]** LLC,
- **[DC charging]** DCO,
- **[Brake Sequence]** BLC,
- **[Output cont]** OCC,

Value	Code / Value	Description
<b>[High Level]</b>	POS	State 1 if the event is true. <b>Factory Setting</b>
<b>[Low Level]</b>	NEG	State 0 if the event is true.

## [DQxx hold delay] DxxH ★

**[DQ1 Holding time]** DO1H, **[DQ2 Holding time]** DO2H, **[DQ11 hold delay]** D11H, **[DQ12 hold delay]** D12H

DQxx holding delay time.

It represents the delay before modifying the state of the output when the assigned event becomes false.

If the corresponding output is assigned to one of the following assignments, the delay is forced to 0 ms and it cannot be modified:

- **[Operating State Fault]** FLT,
- **[Mains Contactor]** LLC,
- **[DC charging]** DCO,
- **[Brake Sequence]** BLC,
- **[Output cont]** OCC,

Value range	Description
0...9,999 ms (step: 1 ms)	<b>Factory setting:</b> 0 ms

## [Enable DQxx fallback] DxxF / LOxF

**[Enable DQ1 fallback]** LO1F, **[Enable DQ2 fallback]** LO2F, **[Enable DQ11 fallback]** D11F, **[Enable DQ12 fallback]** D12F

Enable DQxx fallback.

**[Enable DQ1 fallback]** L01F is forced to **[No]** NO if:

- for drive with power equal to or lower than 22kW, a function is assigned to DI6/DQ1 (see **[DI6 Low Assignment]** L6L, **[DI6 High Assignment]** L6H and **[DQ1 Assignment]** DO1).
- for drive with power equal to or greater than 30kW, a function is assigned to DQ/PTO (see **[DQ1 Assignment]** DO1 and **[PTO Assign]** PTO).

**[Enable DQ2 fallback]** L02F is forced to **[No]** NO if a function is assigned to DI7/DQ2 (see **[DI7 Low Assignment]** L7L, and **[DQ2 Assign]** DO2).

**[Enable DQ11 fallback]** D11F (respectively **[Enable DQ12 fallback]** D12F) is forced to **[No]** NO if **[DQ11 assignment]** DO11 (respectively **[DQ12 assignment]** DO12) is assigned.

If the output is controlled by fieldbus and has been enabled, transition to operating state Fault such as, but not limited to, communication interruption, will not disable the output if this parameter is set to **[No]** NO .

<b>⚠ WARNING</b>
<p><b>LOSS OF CONTROL</b></p> <ul style="list-style-type: none"> <li>• Verify that using this default setting does not result in unsafe conditions including communication interruption.</li> <li>• Set this parameter to <b>[Yes]</b> YES to disable the output if an error is triggered.</li> </ul> <p><b>Failure to follow these instructions can result in death, serious injury, or equipment damage.</b></p>

Value	Code / Value	Description
<b>[No]</b>	NO	<p>Fallback feature disabled.</p> <p>When the output is assigned, the output value is defined according to its assignment, page 429.</p> <p>When the output is not assigned, the state of the output can be controlled via a bit of OL1R. If an error is triggered, the output remains unchanged.</p> <p><b>NOTE:</b> On drive with power equal to or greater than 30 kW, depending on the configuration of PTO - DQ Switch (SW2), DQ1 output value is controlled via:</p> <ul style="list-style-type: none"> <li>• a bit of OL1R (if DQ selected),</li> <li>• the internal parameter PTOC (if PTO selected).</li> </ul> <p><b>Factory setting</b></p>
<b>[Yes]</b>	YES	<p>Fallback feature enabled.</p> <p>The state of the output is controlled via a bit of OL1R (refer to the communication parameter addresses file). If an error is detected, the output is disabled.</p> <p><b>NOTE:</b> On drive with power equal to or greater than 30 kW, depending on the configuration of PTO - DQ Switch (SW2), DQ1 output value can be controlled via:</p> <ul style="list-style-type: none"> <li>• a bit of OL1R (if DQ selected),</li> <li>• the internal parameter PTOC (if PTO selected).</li> </ul> <p><b>NOTE:</b> On drive with power equal to or greater than 30 kW, depending on the configuration of PTO - DQ Switch (SW2), if an error is detected, the output DQ1 is:</p> <ul style="list-style-type: none"> <li>• disabled (if DQ selected),</li> <li>• modified to <b>[PTO Min Output Freq]</b> PTOL (if PTO selected).</li> </ul> <p><b>NOTE:</b> If an error is detected, the process applied on the output (e.g. delays, active level) remains applied.</p>

## [Input/Output] - [AI/AQ]

### [AI1 configuration] AI1- Menu

#### Access

[Complete settings] → [Input/Output] → [AI/AQ] → [AI1 configuration]

#### About This Menu

The input can be delinearized by configuring an intermediate point on the input/output curve of this input:

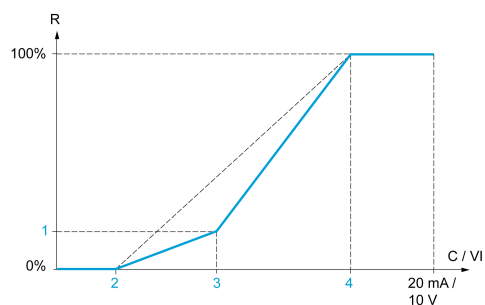

R Reference

C / VI Current or Voltage Input

1 [Y Interm. point]

2 [Min value] (0%)

3 [X Interm. point]

4 [Max value] (100%)

**NOTE:** For [X Interm. point], 0% corresponds to [Min value] and 100% to [Max value].

### [AI1 assignment] AI1A

Analog input AI1 functions assignment.

Read-only parameter, cannot be configured. It displays all the functions associated with input AI1 in order to verify, for example, for compatibility problems.

If no functions have been assigned, [No] NO is displayed.

### [AI1 Type] AI1T

#### Configuration of AI1.

Setting	Code / Value	Description
[Voltage]	10U	0-10 Vdc <b>Factory setting</b>
[Current]	0A	0-20 mA



**[AI1 Min. Value] UI1L1** ★

*AI1 voltage scaling parameter of 0%.*

This parameter can be accessed if [AI1 Type] AI1T is set to [Voltage] 10U.

Setting	Description
0.0...10.0 Vdc	Setting range <b>Factory setting:</b> 0.0 Vdc

**[AI1 Max Value] UI1H1** ★

*AI1 voltage scaling parameter of 100%.*

This parameter can be accessed if [AI1 Type] AI1T is set to [Voltage] 10U.

Setting	Description
0.0...10.0 Vdc	Setting range <b>Factory setting:</b> 10.0 Vdc

**[AI1 Min. Value] CRL1** ★

*AI1 current scaling parameter of 0%.*

This parameter can be accessed if [AI1 Type] AI1T is set to [Current] 0A.

Setting	Description
0.0...20.0 mA	Setting range <b>Factory setting:</b> 0.0 mA

**[AI1 Max Value] CRH1** ★

*AI1 current scaling parameter of 100%.*

This parameter can be accessed if [AI1 Type] AI1T is set to [Current] 0A.

Setting	Description
0.0...20.0 mA	Setting range <b>Factory setting:</b> 20.0 mA

**[AI1 filter] AI1F**

*AI1 filter.*

Setting ( )	Description
0.00...10.00 s	Setting range <b>Factory setting:</b> 0.00 s

**[AI1 X Interm. Point] AI1E**

Input delinearization point coordinate. Percentage of the physical input signal.

0% corresponds to **[AI1 Min. Value]** (U1L1)

100% corresponds to **[AI1 Max Value]** (U1H1)

Setting ( )	Description
0...100%	Setting range <b>Factory setting:</b> 0%

## [AI1 Interm. point Y] AI1S

Input delinearization point coordinate (frequency reference).

Percentage of the internal frequency reference corresponding to the **[AI1 X Interm. Point]** (AI1E) percentage of physical input signal.

Setting ( )	Description
0...100%	Setting range <b>Factory setting:</b> 0%

## [AI1 range] AI1L

This parameter can be accessed if **[AI1 Type]** AI1T is set to **[Current]** 0A.

This parameter is forced to **[0 - 100%]** POS if:

- **[AI1 Type]** AI1T is not set to **[Current]** 0A, or
- **[AI1 Min. Value]** CRL1 is lower than 3.0 mA

Setting	Code / Value	Description
<b>[0 - 100%]</b>	POS	Unidirectional: AI1 current scaling is 0% up to 100%. <b>Factory Setting</b>
<b>[+/- 100%]</b>	POSNEG	Bidirectional: AI1 current scaling is -100% up to 100%. <b>[AI1 Min. Value]</b> CRL1 corresponds to -100%. <b>[AI1 Max Value]</b> CRH1 corresponds to 100%.

## [AI2 configuration] AI2– Menu

### Access

[Complete settings] → [Input/Output] → [AI/AQ] → [AI2 configuration]

### [AI2 Assignment] AI2A

Identical to [AI1 assignment] AI1A , page 432.

### [AI2 Type] AI2T

*Configuration of AI2.*

Setting	Code / Value	Description
[Voltage]	10U	0-10 Vdc
[Voltage +/-]	N10U	-10/+10 Vdc Factory setting

### [AI2 Min. Value] UIL2 ★

*AI2 voltage scaling parameter of 0%.*

This parameter can be accessed if [AI2 Type] AI2T is set to [Voltage] 10U.

Identical to [AI1 Min. Value] UIL1 , page 433.

### [AI2 Max value] UIH2 ★

*AI2 voltage scaling parameter of 100%.*

This parameter can be accessed if [AI2 Type] AI2T is set to [Voltage] 10U.

Identical to [AI1 Max Value] UIH1 , page 433.

### [AI2 filter] AI2F

Identical to [AI1 filter] AI1F , page 433.

### [AI2 X Interm. Point] AI2E

AI2 delinearization input level.

Identical to [AI1 X Interm. Point] AI1E , page 433.

### [AI2 Interm. point Y] AI2S

AI2 delinearization output level.

Identical to [AI1 Interm. point Y] AI1S , page 434.

## [AI3 configuration] AI3- Menu

### Access

[Complete settings] → [Input/Output] → [AI/AQ] → [AI3 configuration]

### About This Menu

This menu can be accessed on drives with a power greater than 22kW.

### [AI3 Assignment] AI3A

Identical to [AI1 assignment] AI1A , page 432.

### [AI3 Type] AI3T

**Configuration of AI3.**

Identical to [AI2 Type] AI2T , page 435 with factory setting: [Current] 0A.

### [AI3 Min. Value] UII3 ★

**AI3 voltage scaling parameter of 0%.**

Identical to [AI1 Min. Value] UII1 , page 433.

This parameter can be accessed if [AI3 Type] AI3T is set to [Voltage] 10U.

### [AI3 Max Value] UIH3 ★

**AI3 voltage scaling parameter of 100%.**

Identical to [AI1 Max Value] UIH1 , page 433.

This parameter can be accessed if [AI3 Type] AI3T is set to [Voltage] 10U.

### [AI3 Min. Value] CRL3 ★

**AI3 current scaling parameter of 0%.**

Identical to [AI1 Min. Value] CRL1 , page 433.

This parameter can be accessed if [AI3 Type] AI3T is set to [Current] 0A.

### [AI3 Max Value] CRH3 ★

**AI3 current scaling parameter of 100%.**

Identical to [AI1 Max Value] CRH1 , page 433.

This parameter can be accessed if [AI3 Type] AI3T is set to [Current] 0A.

### [AI3 filter] AI3F

AI3 cutoff time of the low filter.

Identical to [AI1 filter] AI1F , page 433.

### [AI3 X Interm. point] AI3E

AI3 delinearization input level.

Identical to [AI1 X Interm. Point] AI1E , page 433.

### [AI3 Y Interm. point] AI3S

AI3 delinearization output level.

Identical to [AI1 Interm. point Y] AI1S , page 434.

### [AI3 range] AI3L

This parameter can be accessed if [AI3 Type] AI3T is set to [Current] 0A.

Identical to [AI1 range] AI1L , page 437

## [AI4 configuration] AI4- Menu

### Access

[Complete settings] → [Input/Output] → [AI/AQ] → [AI4 configuration]

### [AI4 assignment] AI4A ★

This parameter can be accessed if VW3A3203 I/O extension module has been inserted.

Identical to [AI1 assignment] AI1A , page 432.

### [AI4 Type] AI4T ★

#### Configuration of AI4.

This parameter can be accessed if VW3A3203 I/O extension module has been inserted.

Setting	Code / Value	Description
[Voltage]	10U	0-10 Vdc
[Current]	0A	0-20 mA Factory setting
[Voltage +/-]	N10U	-10/+10 Vdc

### [AI4 Min. Value] UII4 ★

*AI4 voltage scaling parameter of 0%.*

Identical to [AI1 Min. Value] UII1 , page 433.

### [AI4 Max Value] UIH4 ★

*AI4 voltage scaling parameter of 100%.*

Identical to [AI1 Max Value] UIH1 , page 433.

### [AI4 Min. Value] CRL4 ★

*AI4 current scaling parameter of 0%.*

Identical to [AI1 Min. Value] CRL1 , page 433.

### [AI4 Max Value] CRH4 ★

*AI4 current scaling parameter of 100%.*

Identical to [AI1 Max Value] CRH1 , page 433.

### [AI4 filter] AI4F ★

AI4 cutoff time of the low filter.

This parameter can be accessed if VW3A3203 I/O extension module has been inserted.

Identical to **[AI1 filter]** AI1F , page 433.

### [AI4 X Interm. point] AI4E ★

AI4 delinearization input level.

This parameter can be accessed if VW3A3203 I/O extension module has been inserted.

Identical to **[AI1 X Interm. Point]** AI1E , page 433.

### [AI4 Y Interm.point] AI4S ★

AI4 delinearization output level.

This parameter can be accessed if VW3A3203 I/O extension module has been inserted.

Identical to **[AI1 Interm. point Y]** AI1S , page 434.

### [AI4 range] AI4L

This parameter can be accessed if **[AI4 Type]** AI4T is set to **[Current]** 0A.

Identical to **[AI1 range]** AI1L , page 439

## [AI5 configuration] AI5- Menu

### Access

[Complete settings] → [Input/Output] → [AI/AQ] → [AI5 configuration]

### [AI5 assignment] AI5A ★

This parameter can be accessed if VW3A3203 I/O extension module has been inserted.

Identical to [AI1 assignment] AI1A , page 432.

### [AI5 Type] AI5T ★

#### **Configuration of AI5.**

This parameter can be accessed if VW3A3203 I/O extension module has been inserted.

Identical to [AI1 Type] AI1T. , page 438

### [AI5 Min. Value] UII5 ★

**AI5 voltage scaling parameter of 0%.**

Identical to [AI1 Min. Value] UII1 , page 433.

### [AI5 Max Value] UIH5 ★

**AI5 voltage scaling parameter of 100%.**

Identical to [AI1 Max Value] UIH1 , page 433.

### [AI5 Min. Value] CRL5 ★

**AI5 current scaling parameter of 0%.**

Identical to [AI1 Min. Value] CRL1 , page 433.

### [AI5 Max Value] CRH5 ★

AI5 current scaling parameter of 100%.

Identical to [AI1 Max Value] CRH1 , page 433.

### [AI5 filter] AI5F ★

AI5 cutoff time of the low filter.

This parameter can be accessed if VW3A3203 I/O extension module has been inserted.

Identical to [AI1 filter] AI1F , page 433.



### [AI5 X Interm. point] AI5E ★

AI5 delinearization input level.

This parameter can be accessed if VW3A3203 I/O extension module has been inserted.

Identical to [AI1 X Interm. Point] AI1E , page 433.

### [AI5 Y Interm.point] AI5S ★

AI5 delinearization output level.

This parameter can be accessed if VW3A3203 I/O extension module has been inserted.

Identical to [AI1 Interm. point Y] AI1S , page 434.

### [AI5 range] AI5L

This parameter can be accessed if [AI5 Type] AI5T is set to [Current] 0A.

Identical to [AI1 range] AI1L , page 441

## [AQ1 configuration] AO1– Menu

### Access

[Complete settings] → [Input/Output] → [AI/AQ] → [AQ1 configuration]

### Minimum and Maximum Output Values

The minimum output value, in volts, corresponds to the lower limit of the assigned parameter and the maximum value corresponds to its upper limit. The minimum value may be greater than the maximum value.

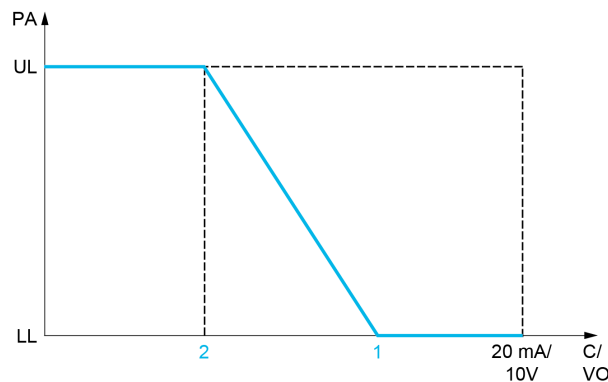
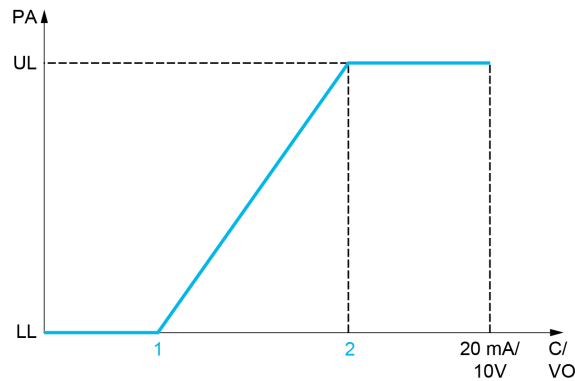

**PA** Parameter assigned

**C / VO** Current or voltage output

**UL** Upper limit

**LL** Lower limit

**1 [AQx min output]** AOLx or UOLx

**2 [AQx max output]** AOHx or UOHx

### Scaling of the Assigned Parameter

The scale of the assigned parameter can be adapted in accordance with the requirements by modifying the values of the lower and upper limits with two parameters for each analog output (**[Scaling AQx min]** ASLx and **[Scaling AQx max]** ASHx).

These parameters are given in %. 100 % corresponds to the total variation range of the configured parameter, so: 100% = upper limit - lower limit.

For example, **[Sign. Torque]** STQ which varies between –3 and +3 times the rated torque, 100% corresponds to 6 times the rated torque.

- The **[Scaling AQx min] ASLx** parameter modifies the lower limit: new value = lower limit + (range x ASLx). The value 0% (factory setting) does not modify the lower limit.
- The **[Scaling AQx max] ASHx** parameter modifies the upper limit: new value = lower limit + (range x ASLx). The value 100% (factory setting) does not modify the upper limit.
- **[Scaling AQx min] ASLx** must always be lower than **[Scaling AQx max] ASHx**.

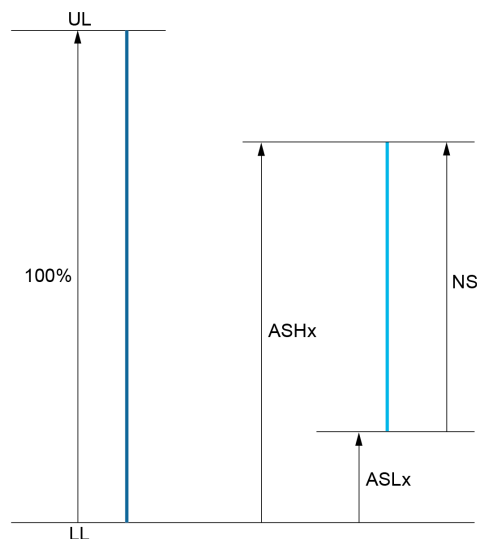

**UL** Upper limit of the assigned parameter

**LL** Lower limit of the assigned parameter

**NS** New scale

**1** ASHx

**2** ASLx

## Application Example

In an application, it is requested to read on the analog output AQ1 the value of the motor current. The value must in current (0...20 mA) and the full range must correspond to 0 up to 2 x nominal motor current (2 x IN motor).

In this example, IN motor corresponds to 0.8 x IN drive.

Consequently, the analog output AQ1 must be configured as following:

- Set **[AQ1 assignment] AO1** to **[Motor Current] OCR**. By default, the total variation range is 0 to 2 times the nominal drive current (2 x IN drive).
- Set **[AQ1 Type] AO1T** to **[Current] 0A**. Then, set **[AQ1 min output] AOL1** and **[AQ1 max output] AOH1**. By default, they are equal to 0.0 mA and 20.0 mA, that is corresponding to the requirements.
- The requested minimum value is 0 A (0 x IN motor = 0 x IN drive): **[Scaling AQ1 min] ASL1** does not need to be modified (its factory setting is 0 %).
- The requested total variation range is 2 x IN motor (= 1.6 x IN drive). By default, the full range for **[Motor Current] OCR** is 2 x IN drive. It means that the requested total variation range must be reduced to 80 % (1.6/2 = 0.8). Consequently, **[Scaling AQ1 max] ASH1** must be set to 80 %.

## [AQ1 assignment] AO1

**AQ1 assignment.**

Setting	Code / Value	Description
[Not Configured]	NO	Not assigned <b>NOTE:</b> In this case, the output can be controlled via the internal parameter <b>AO1R</b> (refer to the communication parameter addresses file). By default, if an error (such as a communication interruption) is detected, the output remains unchanged. Use the parameter <b>[Enable AQ1 fallback] AOF1</b> to disable the output in case of error detection.
[M/S Out Speed Reference]	MSSO	Master / slave output speed reference
[M/S Out Torque Reference]	MSTO	Master / slave output torque reference
[Motor Current]	OCR	Current in the motor, from 0 to 2 In (In = rated drive current indicated in the Installation manual and on the drive nameplate)
[Motor Frequency]	OFR	Output frequency, from 0 to <b>[Max Frequency] TFR</b> <b>Factory Setting</b>
[Measured Motor Freq]	OFRR	Measured motor frequency
[Sig. O/P Frq.]	OFS	Signed output frequency, between <b>-[Max Frequency] TFR</b> and <b>+ [Max Frequency] TFR</b>
[PID Error]	OPE	PID controller detected error between <b>-5%</b> and <b>+5%</b> of <b>[Max PID feedback] PIF2 - [Min PID feedback] PIF1</b>
[PID Feedbk]	OPF	PID controller feedback between <b>[Min PID feedback] PIF1</b> and <b>[Max PID feedback] PIF2</b>
[PID Output]	OPI	PID controller output between <b>[Low Speed] LSP</b> and <b>[High Speed] HSP</b>
[Motor Power]	OPR	Motor power, between 0 and 2.5 times <b>[Nominal Motor Power] NPR</b>
[PID Ref.]	OPS	PID controller reference between <b>[Min PID Process] PIP1</b> and <b>[Max PID Process] PIP2</b>
[Ramp Out.]	ORP	From 0 to <b>[Max Frequency] TFR</b>
[sign Ramp]	ORS	Signed ramp output, between <b>-[Max Frequency] TFR</b> and <b>+ [Max Frequency] TFR</b>
[Signed Trq Ref]	STR	Signed torque reference
[Sign. Torque]	STQ	Signed motor torque, between <b>-3</b> and <b>+3</b> times the rated motor torque. The <b>+</b> sign corresponds to the motor mode and the <b>-</b> sign to the generator mode (braking).
[Drv Thermal]	THD	Drive thermal state, from 0 to 200% of the rated thermal state
[Mot Thermal]	THR	Motor thermal state, from 0 to 200% of the rated thermal state
[Mot Therm2]	THR2	Motor thermal 2 state
[Mot Therm3]	THR3	Motor thermal 3 state
[Mot therm4]	THR4	Motor thermal 4 state
[Torque Lim.]	TQL	Torque limit
[Torque 4Q]	TR4Q	Signed motor torque, between <b>-3</b> and <b>+3</b> times the rated motor torque. The <b>+</b> and <b>-</b> signs correspond to the physical direction of the torque, regardless of mode (motor or generator)
[Motor Torq.]	TRQ	Motor torque, from 0 to 3 times the rated motor torque
[Unsigned Trq Ref]	UTR	Unsigned torque reference
[Motor volt.]	UOP	Voltage applied to the motor, between 0 and <b>[Nom Motor Voltage] UNS</b>

## [AQ1 Type] AO1T

Select according to the requirements the type of output.

Setting	Code / Value	Description
[Voltage]	10U	0-10 Vdc If necessary, adjust [AQ1 min Output] UOL1 and [AQ1 max Output] UOH1.
[Current]	0A	0-20 mA If necessary, adjust [AQ1 min output] AOL1 and [AQ1 max output] AOH1. <b>Factory setting</b>

## [AQ1 min output] AOL1 ★

This parameter can be accessed if [AQ1 Type] AO1T is set to [Current] 0A.

Setting	Description
0.0...20.0 mA (step: 0.1 mA)	Setting range <b>Factory setting:</b> 0.0 mA

## [AQ1 max output] AOH1 ★

This parameter can be accessed if [AQ1 Type] AO1T is set to [Current] 0A.

Setting	Description
0.0...20.0 mA (step: 0.1 mA)	Setting range <b>Factory setting:</b> 20.0 mA

## [AQ1 min Output] UOL1 ★

This parameter can be accessed if [AQ1 Type] AO1T is set to [Voltage] 10U.

Setting	Description
0.0...10.0 Vdc (step: 0.1 Vdc)	Setting range <b>Factory setting:</b> 0.0 Vdc

## [AQ1 max Output] UOH1 ★

This parameter can be accessed if [AQ1 Type] AO1T is set to [Voltage] 10U.

Setting	Description
0.0...10.0 Vdc (step: 0.1 Vdc)	Setting range <b>Factory setting:</b> 10.0 Vdc

## [Scaling AQ1 min] ASL1

Scaling of the lower limit of the assigned parameter, as a % of the maximum possible variation.

Setting	Description
0.0...[Scaling AQ1 max] ASH1 (step: 0.1 %)	Setting range <b>Factory setting:</b> 0.0%

## [Scaling AQ1 max] ASH1

Scaling of the upper limit of the assigned parameter, as a % of the maximum possible variation.

Setting	Description
[Scaling AQ1 min] ASL1...100.0% (step: 0.1 %)	Setting range <b>Factory setting:</b> 100.0%

## [AQ1 Filter] AO1F

Enable/disable the low pass-filter and configure its time constant.

Setting	Description
0.00...10.00 s (step: 0.01 s)	Setting range. If this parameter is set to 0.00 s, the filter is deactivated. <b>Factory setting:</b> 0.00 s

## [Enable AQ1 fallback] AOF1

This parameter is forced to **[No] NO** if **[AQ1 assignment] AO1** is set to a value different from **[Not Configured] NO**.

If the output is controlled by fieldbus and has been enabled, transition to operating state Fault such as, but not limited to, communication interruption, will not disable the output if this parameter is set to **[No] NO**.

### **⚠ WARNING**

#### **LOSS OF CONTROL**

- Verify that using this default setting does not result in unsafe conditions including communication interruption.
- Set this parameter to **[Yes] YES** to disable the output if an error is triggered.

**Failure to follow these instructions can result in death, serious injury, or equipment damage.**

Setting	Code / Value	Description
[No]	NO	<p>Fallback feature disabled.</p> <p>When the output is assigned, the output value is defined according to its assignment, page 443.</p> <p>When the output is not assigned, the output value can be controlled via the internal parameter <b>AO1R</b> (refer to the communication parameter addresses file). If an error is detected, the output remains unchanged.</p> <p><b>Factory setting</b></p>
[Yes]	YES	<p>Fallback feature enabled.</p> <p>The output value can be controlled via the internal parameter <b>AO1R</b> (refer to the communication parameter addresses file). If an error is detected, the output is disabled.</p> <p><b>NOTE:</b> If an error is detected, the process applied on the output (e.g. min, max, filter) remains applied.</p>

## [AQ2 configuration] AO2– Menu

### Access

[Complete settings] → [Input/Output] → [AI/AQ] → [AQ2 configuration]

### About This Menu

This menu is used to configure the analog output AQ2.

This menu can only be accessed on drives with a power greater than 22kW.

In this menu, the following parameters can be accessed:

- [AQ2 assignment] **AO2**
- [AQ2 Type] **AO2T**
- [AQ2 min output] **AOL2**
- [AQ2 max output] **AOH2**
- [AQ2 min Output] **UOL2**
- [AQ2 max Output] **UOH2**
- [Scaling AQ2 min] **ASL2**
- [Scaling AQ2 max] **ASH2**
- [AQ2 Filter] **AO2F**
- [Enable AQ2 fallback] **AOF2**

Refer to [AQ1 configuration] **AO1**– for more information about analog output configuration and the possible settings.

**NOTE:** In factory setting, the analog input AQ2 is not assigned and is configured in [Current] **0A**.

## [Virtual AI1] AV1– Menu

### Access

[Complete settings] → [Input/Output] → [AI/AQ] → [Virtual AI1]

### [AIV1 assignment] AV1A

Virtual analog input function assignment. Read-only parameter.

Setting	Code / Value	Description
[No]	NO	Not assigned
[Torque Ref Offset]	AITQO	Torque offset source
[Torque Ref Ratio]	AITQR	Torque ratio source
[Ref Frequency 2 Summing]	AISA2	Reference frequency 2 summing
[Torque limitation]	AITAA	Torque limitation: activation by an analog value
[Torque limitation 2]	AITAA2	Torque limitation: activation by an analog value
[Subtract Ref Freq 2]	AIDA2	Subtract reference frequency 2
[Ref Frequency 3 Summing]	AISA3	Reference frequency 3 summing
[Subtract Ref Freq 3]	AIDA3	Subtract reference frequency 3
[Ref Frequency 2 multiplier]	AIMA2	Reference frequency 2 multiplier
[Ref Frequency 3 multiplier]	AIMA3	Reference frequency 3 multiplier

### [AIV1 Channel Assign] AIC1

*Channel assignment for virtual Analog input AIV1.*

Setting	Code / Value	Description
[Not Configured]	NO	Not assigned <b>Factory setting</b>
[Ref. Freq-Modbus]	MDB	Reference frequency via Modbus
[Ref. Freq-CANopen]	CAN	Reference frequency via CANopen if a CANopen module has been inserted
[Ref. Freq-Com. Module]	NET	Reference frequency via fieldbus module if a fieldbus module has been inserted
[Embedded Ethernet]	ETH	Embedded Ethernet <b>NOTE:</b> This selection can be accessed on ATV340•••N4E drives.



**[AIV1 Type] AV1T****Configuration of virtual analog input AIV1.**

Setting	Code / Value	Description
[+/- 8192]	INEG	-8192/+8192 <b>Factory setting</b>
[+/- 100%]	PNEG	-100.00/+100.00 %

## [Input/Output] - [Relay]

### [Relay] RELA– Menu

#### Access

[Complete settings] → [Input/Output] → [Relay]

#### About This Menu

This menu is used to configure the relays of the drive:

- **[R1 configuration] R1** – to **[R3 configuration] R3** –: the relays R1 to R3 embedded to the drive. R3 can only be accessed on drives with power greater than 22 kW,
- **[R4 configuration] R4** – to **[R6 configuration] R6** –: the relays R4 to R6 if the VW3A3204 relay output option module is inserted,

On Graphic Display Terminal (VW3A1111), **[Relay] RELA–** menu is the fourth tab displayed in the menu **[Input/Output] IO** – (the tab is named “Relay”).

Use the touch wheel to scroll through the relays. Click OK to access the configuration of the relay.

On Graphic Display Terminal, if a relay is assigned then a check mark is displayed.

For a given relay (Rx), the configuration is composed by:

- **[Rx Assignment] Rx**: the assignment of the relay Rx,
- **[Rx Delay time] Rx:D**: the delay time of the relay Rx. It represents the delay before modifying the state of the relay when the assigned event becomes true,
- **[Rx Active at] Rx:S**: the active level of the relay Rx. It defines the state 1 or 0 of the relay to the true state of the assigned event.
- **[Rx Holding time] Rx:H**: the holding time of the relay Rx. It represents the delay before modifying the state of the relay when the assigned event becomes false.
- **[Enable Rx fallback] Rx:F**: parameter used to enable/disable the fallback mode triggered in case of communication interruption (if the relay is controlled by fieldbus communication).

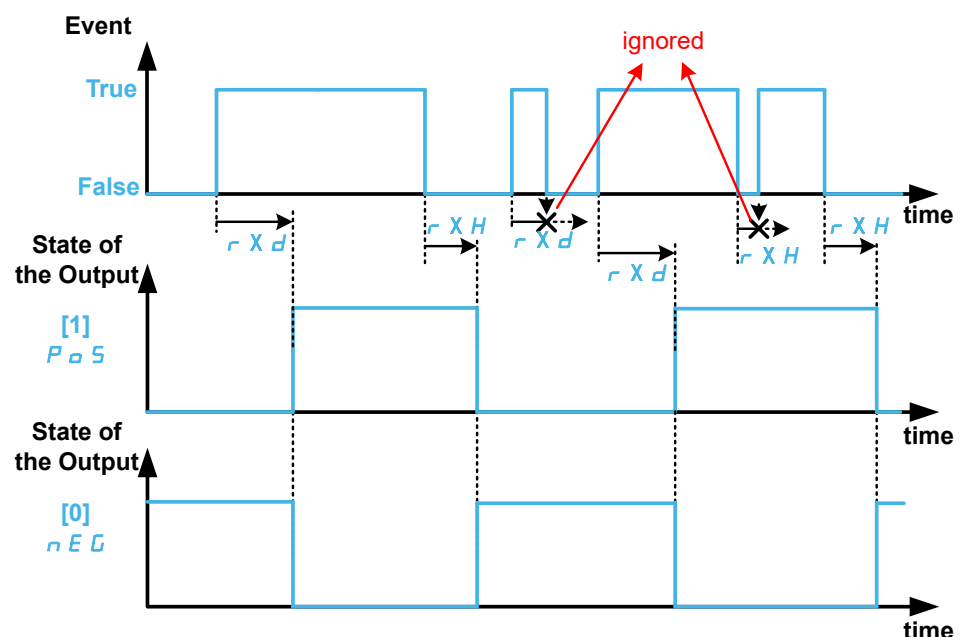

## [Rx Assignment] Rx

[R1 Assignment] R1, [R2 Assignment] R2, [R3 Assignment] R3, [R4 Assignment] R4, [R5 Assignment] R5, [R6 Assignment] R6

It is used to assign the relay to an event or a function. The following table gives the possible settings:

If the output is set to [CDxx] CDxx or [Cxxx] Cxxx and has been enabled, transition to operating state Fault such as, but not limited to, communication interruption, will not disable the output.

**⚠ WARNING**

**LOSS OF CONTROL**

Only set the output to [CDxx] CDxx or [Cxxx] Cxxx after having verified that this setting cannot result in unsafe conditions including communication interruption.

**Failure to follow these instructions can result in death, serious injury, or equipment damage.**

Setting	Code / Value	Description
[Not Assigned]	NO	Not assigned.  <b>NOTE:</b> In this case, the output can be controlled via the internal parameter <b>OL1R</b> (refer to the communication parameter addresses file). By default, if an error (such as a communication interruption is detected), the output remains unchanged. Use the parameter <b>[Enable Rx Fallback] r X F</b> to disable the output in case of error detection.  <b>Factory setting</b> <sup>(1)</sup>
[Warning Grp 1]... [Warning Grp 5]	AG1...AG5	Warning group 1 to Warning group 5.
[Slipping warn]	ANA	Anti-veering warning
[AI1 4-20 Warning]... [AI5 4-20 Warning]	AP1...AP5	4-20 mA loss warning on AI <sup>(3)</sup>  <b>NOTE:</b> AI3 can only be accessed on drive with power greater than 22 kW.
[Neg Torque]	ATS	Actual torque sign
[Brake Contact Warn]	BCA	Brake contact warning
[Brake Sequence]	BLC	Brake sequence <sup>(2)</sup>  The output is automatically configured to this function by setting the parameter <b>[Brake assignment] BLC</b> .
[HMI L/R cmd]	BMP	Control via the Graphic Display Terminal is active. (only active with Local/Remote button)
[BR Thermal Warning]	BOA	Braking resistor temperature warning.
[In braking]	BRS	In braking sequence
[Load Mvt Warn]	BSA	Brake speed warning
[CD00]...[CD15]	CD00...CD15	Bit x digital input ctrl word (e.g. virtual digital input CMD.0...CMD.15). The state of the output is modified accordingly with the bit of the control word. If an error is triggered (such as a communication error), the output remains unchanged.  <b>NOTE:</b> CD00...CD10 are only accessible with <b>[Control Mode] CHCF</b> set to <b>[I/O profile] IO</b> .
[C100]...[C115]	C100...C115	Bit x Modbus ctrl word (e.g. Virtual digital input CMD1.00...CMD1.15 with integrated Modbus Serial). The state of the output is modified accordingly with the bit of the Modbus control word. If an error is triggered (such as a communication error), the output remains unchanged.

Setting	Code / Value	Description
		<b>NOTE:</b> C100...C110 are only accessible with [Control Mode] <b>CHCF</b> set to [I/O profile] <b>IO</b> .
[C200]...[C215]	C200...C215	Bit x CANopen ctrl word (e.g. Virtual digital input CMD2.00...CMD2.15 with CANopen® fieldbus module). The state of the output is modified accordingly with the bit of the CANopen control word. If an error is triggered (such as a communication error), the output remains unchanged. <b>NOTE:</b> C200...C210 are only accessible with [Control Mode] <b>CHCF</b> set to [I/O profile] <b>IO</b> .
[C300]...[C315]	C300...C315	Bit x Com module ctrl word (e.g. Virtual digital input CMD3.00...CMD3.15 with fieldbus module). The state of the output is modified accordingly with the bit of the fieldbus module control word. If an error is triggered (such as a communication error), the output remains unchanged. <b>NOTE:</b> C300...C310 are only accessible with [Control Mode] <b>CHCF</b> set to [I/O profile] <b>IO</b> .
[C500]...[C515]	C500...C515	Bit x Ethernet ctrl word (e.g. Virtual digital input CMD3.00...CMD3.15 with Ethernet embedded). The state of the output is modified accordingly with the bit of the Ethernet embedded control word. If an error is triggered (such as a communication error), the output remains unchanged. <b>NOTE:</b> C500...C510 are only accessible with [Control Mode] <b>CHCF</b> set to [I/O profile] <b>IO</b> .
[set 1 active]...[set 3 active]	CFP1...CFP3	Parameter set 1, 2 or 3 is active.
[Cnfg.0 act.]...[Cnfg.3 act.]	CNF0...CNF3	Configuration 0, 1, 2 or 3 is active
[Current Thd Reached]	CTA	Motor current threshold ([High Current Thd] <b>CTD</b> ) reached
[Low Current Reached]	CTAL	Current low threshold ([Low I Threshold] <b>CTDL</b> ) reached
[DC charged]	DBL	DC bus charged
[DC charging]	DCO	DC charging <sup>(2)</sup> The output is automatically configured to this function by setting the parameter [DC Charging Assign] <b>DCO</b> .
[Dynamic Load Warning]	DLDA	Dynamic load detection.
[External Error Warning]	EFA	External error warning
[Mot Freq High Thd 2]	F2A	Second frequency threshold ([Freq. threshold 2] <b>F2D</b> ) reached
[Mot Freq Low Thd 2]	F2AL	Second frequency low threshold ([2 Freq. Threshold] <b>F2DL</b> ) reached
[High Speed Reached]	FLA	High speed reached
[Operating State Fault]	FLT	Operating state fault
[Pulse Warn Thd Reached]	FQLA	Pulse warning threshold reached
[Fallback speed]	FRF	Reaction on event / fallback speed
[Mot Freq High Thd]	FTA	Motor frequency threshold ([Motor Freq Thd] <b>FTD</b> ) reached
[Mot Freq Low Thd]	FTAL	Frequency low threshold ([Low Freq.Threshold] <b>FTDL</b> ) reached
[Internal Error 22]	INFM	Internal error 22 (Embedded Ethernet)
[Mains Contactor]	LLC	Mains contactor <sup>(2)</sup> The output is automatically configured to this function by setting the parameter [Mains Contactor] <b>LLC</b> .

Setting	Code / Value	Description
[Limit Switch Reached]	LSA	Limit switch function activated.
[I present]	MCP	Motor current present
[Forward]	MFRD	Run forward
[Reverse]	MRRS	Run reverse
[M/S Device Warn]	MSDA	M/S Device Warn <sup>(2)</sup>
[Output cont]	OCC	Output contactor control <sup>(2)</sup> The output is automatically configured to this function by setting the parameter [Out. Contactor Assign] OCC.
[Process Overload Warning]	OLA	Overload warning
[PID error Warning]	PEE	PID error warning
[PID Feedback Warn]	PFA	PID feedback warning
[PID High Fdbck Warn]	PFAH	PID feedback high threshold (PAH) reached
[PID Low Fdbck Warn]	PFAL	PID feedback low threshold (PAL) reached
[Regulation Warning]	PISH	PID regulation unable to reach the set point
[Power Removal State]	PRM	Power removal state. Without power supply, the information cannot be delivered. With this setting value, the power supply must be not external.
[Ready]	RDY	Ready to start
[Pwr Backup Warn]	RFTA	Power backup mode warning
[Speed Maintained]	RLS	Reaction on event / maintain speed
[Ramp switching]	RP2	Ramp switching state
[Slack Rope Warning]	RSDA	Rope Slack
[Trq ctrl Warning]	RTA	Torque control time-out warning
[Ref Freq High Thd reached]	RTAH	Frequency reference high threshold reached
[Ref Freq Low Thd reached]	RTAL	Frequency reference low threshold reached
[Device Running]	RUN	Drive running
[Rdy Or Run State]	RYRN	Device in ready or running state.
[Ref Freq Reached]	SRA	Frequency reference reached
[Modbus Com Inter.]	SLF1	Modbus communication interruption warning
[Lim T/I Reached]	SSA	Limit torque / I reached: Torque current limitation warning
[Per Type of Stop]	STT	Reaction on event / stop on STT without an error triggered after stop.
[STO fct status]	STOS	Safe torque off function status <sup>(4)</sup>
[Dev Thermal reached]	TAD	Drive thermal threshold reached
[Device Therm Warn]	THA	Drive thermal state warning
[IGBT Thermal Warning]	TJA	Thermal junction warning
[AI1 Th Warning]...[AI5 Th Warning]	TP1A...TP5A	Thermal warning on AI <sup>(3)</sup> <b>NOTE:</b> AI3 can only be accessed on drive with power greater than 22 kW.
[Temp Sens AI1 Warn]...[Temp Sens AI5 Warn]	TS1A...TS5A	Temperature sensor AI warning (open circuit) <sup>(3)</sup> <b>NOTE:</b> AI3 can only be accessed on drive with power greater than 22 kW.

Setting	Code / Value	Description
[Mot2 Therm Thd reached]...[Mot4 Therm Thd reached]	TS2...TS4	Motor thermal threshold TTD2, TTD3 or TTD4 is reached
[Motor Therm Thd reached]	TSA	Motor thermal threshold ([Motor Therm Thd] TTD) reached
[High Torque Warning]	TTHA	High torque threshold
[Low Torque Warning]	TTLA	Low torque threshold
[Process Undld Warn]	ULA	Underload warning
[Preventive UnderV Active]	UPA	Undervoltage prevention warning
[Undervoltage Warning]	USA	Undervoltage warning
<p>(1): On relay R1, the factory setting is [Operating State Fault] FLT. .</p> <p>(2): This setting cannot be accessed with R1.</p> <p>(3): Event on AI2 is not available on ATV340</p>		

(4): This parameter displays the state of the safety function STO.

Value	Code / Value	Description
[Active]	STO	STO active. This setting is displayed when STOA and STOB both have a low status. The relay is in state 0 (relay open).
[Not active]	IDLE	STO not active. Drive in IDLE state. This state is displayed when STOA and STOB both have a high status. The relay is in state 1 (relay closed).
[Error]	FLT	Drive is in error. This state is displayed when STOA and STOB have different status (High/Low). The relay is in state 0 (relay open).

## [Rx Delay time] RxD

[R1 Delay time] R1D, [R2 Delay time] R2D, [R3 Delay time] R3D, [R4 Delay time] R4D, [R5 Delay time] R5D, [R6 activ delay time] R6D

Rx activation delay time.

It represents the delay before modifying the state of the relay when the assigned event becomes true.

If the corresponding relay is assigned to one of the following assignments, the delay is forced to 0 ms and it cannot be modified:

- [Operating State Fault] FLT,
- [Mains Contactor] LLC,
- [DC charging] DCO,
- [Brake Sequence] BLC,
- [Output cont] OCC,

Value range	Description
0...60,000 ms (step: 1 ms)	Factory setting: 0 ms

## [Rx Active at] RxD

[R1 Active at] R1S, [R2 Active at] R2S, [R3 Active at] R3S, [R4 Active at] R4S, [R5 Active at] R5S, [R6 Active at] R6S

Rx status (output active level).

It defines the state 1 or 0 of the relay to the true state of the assigned event.

If the relay R1...R6 is assigned to one of the following assignments, the delay is forced to **[High Level] POS**:

- **[Operating State Fault] FLT**,
- **[Mains Contactor] LLC**,
- **[DC charging] DCO**,
- **[Brake Sequence] BLC**,
- **[Output cont] OCC**,

Value	Code / Value	Description
<b>[High Level]</b>	POS	State 1 if the event is true.  <b>Factory setting</b>
<b>[Low Level]</b>	NEG	State 0 if the event is true.

### [Rx Holding time] RxH

**[R1 Holding time] R1H**, **[R2 Holding time] R2H**, **[R3 Holding time] R3H**, **[R4 Holding time] R4H**, **[R5 Holding time] R5H**, **[R6 hold delay time] R6H**

It represents the delay before modifying the state of the relay when the assigned event becomes false.

If the corresponding relay is assigned to one of the following assignments, the delay is forced to 0 ms and it cannot be modified:

- **[Operating State Fault] FLT**,
- **[Mains Contactor] LLC**,
- **[DC charging] DCO**,
- **[Brake Sequence] BLC**,
- **[Output cont] OCC**,

Value range	Description
0...9,999 ms (step: 1 ms)	<b>Factory setting:</b> 0 ms

### [Enable Rx fallback] RxF

**[Enable R1 fallback] R1F**, **[Enable R2 fallback] R2F**, **[Enable R3 fallback] R3F**, **[Enable R4 fallback] R4F**, **[Enable R5 fallback] R5F**, **[Enable R6 fallback] R6F**

This parameter is forced to **[No] NO** if **[Rx Assignment] Rx** is set to a value different from **[Not Assigned] NO**.

If the output is controlled by fieldbus and has been enabled, transition to operating state Fault such as, but not limited to, communication interruption, will not disable the output if this parameter is set to **[No] NO**.

▲ WARNING
<p><b>LOSS OF CONTROL</b></p> <ul style="list-style-type: none"> <li>• Verify that using this default setting does not result in unsafe conditions including communication interruption.</li> <li>• Set this parameter to <b>[Yes] YES</b> to disable the output if an error is triggered.</li> </ul> <p><b>Failure to follow these instructions can result in death, serious injury, or equipment damage.</b></p>

Value	Code / Value	Description
[No]	NO	<p>Fallback feature disabled.</p> <p>When the output is assigned, the state of the output is defined according to its assignment, page 451</p> <p>When the corresponding output is not assigned, the state of the output can be controlled via a bit of <b>OL1R</b> (refer to the communication parameter addresses file). If an error is detected, the output remains unchanged.</p> <p><b>Factory setting</b></p>
[Yes]	YES	<p>Fallback feature enabled.</p> <p>The state of the relay can be controlled via a bit of <b>OL1R</b> (refer to the communication parameter addresses file). If an error is detected, the output is disabled.</p> <p><b>NOTE:</b> If an error is detected, the process applied on the output (e.g. delays, active level) remains applied.</p>



# [Input/Output] IO – Menu

## Access

[Complete settings] → [Input/Output]

## About This Menu

This parameter can be accessed with the Plain Text Remote Terminal or via the commissioning software.

## [Ref Freq template] BSP

Reference frequency template selection.

This parameter defines how the speed reference is taken into account, for analog inputs and pulse input. In the case of the PID controller, this is the PID output reference.

The limits are set by the [Low Speed] LSP and [High Speed] HSP parameters

Setting ( )	Code / Value	Description
[Standard]	BSD	<p><b>F</b> Frequency  <b>R</b> Reference                      At reference = 0, the frequency = [Low Speed] LSP  <b>Factory setting</b></p>
[Pedestal]	BLS	<p><b>F</b> Frequency  <b>R</b> Reference                      At reference = 0 to [Low Speed] LSP, the frequency = [Low Speed] LSP</p>

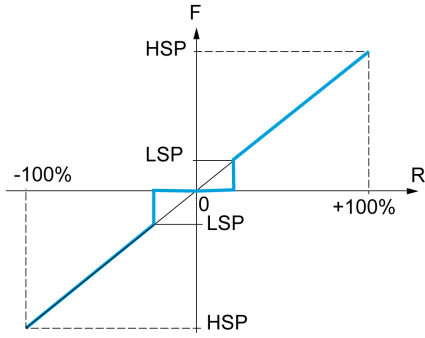
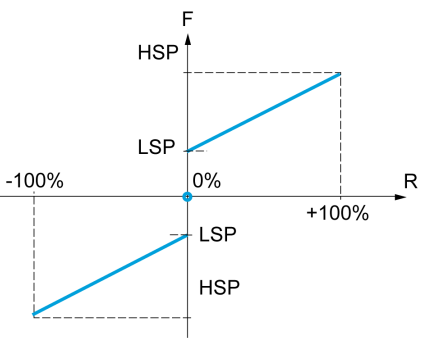
Setting ( )	Code / Value	Description
[Deadband]	BNS	 <p><b>F</b> Frequency</p> <p><b>R</b> Reference At reference = 0 to <b>[Low Speed]</b> LSP the frequency = 0</p>
[Deadband at 0%]	BNS0	 <p><b>F</b> Frequency</p> <p><b>R</b> Reference This operation is the same as <b>[Standard]</b> BSD, except that in the following cases at zero reference, the frequency = 0: The signal is less than <b>[Min nvalue]</b>, which is greater than 0 (example: 1 Vdc on a 2–10 Vdc input) The signal is greater than <b>[Min nvalue]</b>, which is greater than <b>[Max value]</b> (example: 11 Vdc on a 10–0 Vdc input).</p> <p>If the input range is configured as “bidirectional”, operation remains identical to <b>[Standard]</b> BSD.</p>

## [Encoder configuration]

### [Encoder configuration] IEN– Menu

#### Access

[Complete settings] → [Encoder configuration]

#### About This Menu

This menu can be accessed if an encoder module (VW3A3420, VW3A3422, VW3A3423, or VW3A3424) has been inserted, and the available selections depend on the type of encoder module used.

#### Encoder Check Procedure

This procedure applies to all types of encoder.

Step	Action
1	Configure the parameters of the encoder used
2	Set <b>[Motor control type] CTT</b> to a value other than <b>[FVC] FVC</b> even if it is the required configuration. For example, use <b>[SVC V] VVC</b> for an asynchronous motor and <b>[Sync. mot.] SYN</b> for a synchronous motor.
3	Configure the motor parameters in accordance with the specifications on the nameplate. <ul style="list-style-type: none"> <li>Asynchronous motor: <b>[Nominal Motor Power] NPR</b>, <b>[Nom Motor Voltage] UNS</b>, <b>[Nom Motor Current] NCR</b>, <b>[Nominal Motor Freq] FRS</b>, <b>[Nominal Motor Speed] NSP</b>.</li> <li>Synchronous motor: <b>[Sync Nominal I] NCRS</b>, <b>[Nom SyncMotor Speed] NSPS</b>, <b>[Pole pairs] PPNS</b>, <b>[Syn. EMF constant] PHS</b>, <b>[Autotune L d-axis] LDS</b>, <b>[Autotune L q-axis] LQS</b>, <b>[SyncMotor Stator R] RSAS</b>.</li> </ul>
4	Set <b>[Encoder usage] ENU</b> to <b>[No] NO</b> .
5	Perform auto-tuning
6	Set <b>[Encoder check] ENC</b> to <b>[Yes] YES</b> .
7	Set the motor rotating at stabilized speed around 15% of the rated speed for at least 3 seconds, and use the <b>[Display] MON–</b> menu to monitor its behavior using <b>[Measured output fr.] MMF</b> parameter.
8	If an <b>[Encoder] ENF</b> error is detected, <b>[Encoder check] ENC</b> returns to <b>[Not done] NO</b> . <ul style="list-style-type: none"> <li>Check the parameter settings (see steps 1 to 5 above).</li> <li>Check that the mechanical and electrical operation of the encoder, its power supply, and connections are all OK.</li> <li>Reverse the direction of rotation of the motor (<b>[Output Ph Rotation] PHR</b> parameter) or the encoder signals</li> </ul>
9	Repeat the operations from step 6 onwards until <b>[Encoder check] ENC</b> changes to <b>[Done] DONE</b> .
10	If necessary, change <b>[Motor control type] CTT</b> to <b>[FVC] FVC</b> or <b>[Sync.CL] FSY</b> . <b>NOTE:</b> In this case <b>[Encoder usage] ENU</b> is automatically set to <b>[Speed Regulation] REG</b> .

#### [Encoder Type] UEC P

This parameter can be accessed if VW3A3420 or VW3A3422 or VW3A3424 are inserted.

The list of choice depends on the encoder module inserted.

Setting	Code / Value	Description
[Undefined]	UND	Unknow / No encoder type selected <b>Factory setting</b>
[Hiperface]	SCHP	SinCos Hiperface encoder
[SinCos]	SC	SinCos encoder
[SSI]	SSI	SSI encoder
[AB]	AB	AB encoder
[Resolver]	RES	Resolver encoder
[EnDat 2.2]	EN22	Endat 2.2 encoder
[HTL]	HTL	HTL encoder

## [AB Encoder type] ENS

This parameter can be accessed if [Encoder Type] UECP is set to [AB] AB or [HTL] HTL.

**NOTE:** This parameter is forced to [AABB] AABB if the encoder module is different from HTL encoder.

### ⚠ WARNING

#### LOSS OF CONTROL

If you use an HTL encoder module (VW3A3424) and set [Encoder usage] ENU to [Speed Regulation] REG, you must set the parameter [AB Encoder type] ENS to [AABB] AABB.

**Failure to follow these instructions can result in death, serious injury, or equipment damage.**

Setting	Code / Value	Description
[AABB]	AABB	A, /A, B, /B signals <b>Factory setting</b>
[AB]	AB	A, B signals
[A]	A	A signal <b>NOTE:</b> In the case of an HTL encoder module, this parameter cannot be set to [A] A, if [Encoder usage] ENU is set to [Speed Regulation] REG.

## [Encoder supply volt.] UECV ★

Rated voltage of encoder used. The list of choice depends on the encoder module inserted.

This parameter can be accessed if [Encoder Type] UECP is not set to:

- [Undefined] UND, or
- [Resolver] RES.

Setting	Code / Value	Description
[Undefined]	UND	Not defined <b>Factory setting</b>
[5 Vdc]	5V	5 Volts
[12 Vdc]	12V	12 Volts

Setting	Code / Value	Description
[15 Vdc]	15V	15 Volts
[24 Vdc]	24V	24 Volts

### [Number of pulses] PGI ★

Number of pulses per encoder revolution.

The parameter can be accessed if

- An encoder module VW3A3420 has been inserted and if [Encoder Type] UECF is set to [AB] AB or,
- An encoder module VW3A3424 has been inserted and if [Encoder Type] UECF is set to [HTL] HTL.

Setting	Description
100...10,000	<b>Factory setting:</b> 1024

### [Encoder check] ENC

#### Encoder check.

Setting	Code / Value	Description
[Not done]	NO	Check not performed
[Yes]	YES	Activates monitoring of the encoder.
[Done]	DONE	Check performed successfully.  The check procedure checks: <ul style="list-style-type: none"> <li>• The direction of rotation of the encoder/motor</li> <li>• The presence of signals (wiring continuity)</li> <li>• The number of pulses/revolution. If an error is detected, the drive triggers an [Encoder] ENF .</li> </ul>

### [Encoder usage] ENU

#### Encoder usage.

Setting	Code / Value	Description
[No]	NO	Function inactive
[Speed Monitoring]	SEC	The encoder provides speed feedback for monitoring only.
[Speed Regulation]	REG	The encoder provides speed feedback for regulation and monitoring. This configuration is automatic if the drive is configured for closed-loop operation [Motor control type] CTT = [FVC] FVC or [Sync.CL] FSY. If [Motor control type] CTT = [SVC V] VVC the encoder operates in speed feedback mode and enables static correction of the speed to be performed. This configuration is not accessible for other [Motor control type] CTT values.  <b>NOTE:</b> In the case of a HTL encoder module, this parameter cannot be set to [Speed Regulation] REG if [AB Encoder type] ENS is set to [A] A.
[Speed Reference]	PGR	The encoder provides a speed reference. It can only be selected with an incremental encoder module.

**[Encoder rotation inv.] ENRI***Inversion of encoder rotation direction.*

Setting	Code / Value	Description
[No]	NO	Inversion of the encoder deactivated <b>Factory setting</b>
[Yes]	YES	Inversion of the encoder activated

**[Resolver Exct. Freq.] REFQ ★**

This parameter can be accessed if [Encoder Type] UECP is set to [Resolver] RES.

Setting	Code / Value	Description
[3 kHz]	3K	3 kHz
[4 kHz]	4K	4 kHz
[5 kHz]	5K	5 kHz
[6 kHz]	6K	6 kHz
[7 kHz]	7K	7 kHz
[8 kHz]	8K	8 kHz <b>Factory setting</b>
[9 kHz]	9K	9 kHz
[10 kHz]	10K	10 kHz
[11 kHz]	11K	11 kHz
[12 kHz]	12K	12 kHz

**[Transformation ratio] TRES ★**

This parameter can be accessed if [Encoder Type] UECP is set to [Resolver] RES.

Setting	Code / Value	Description
[0.3]	03	0.3
[0.5]	05	0.5 <b>Factory setting</b>
[0.8]	08	0.8
[1.0]	10	1.0

**[Resolver poles nbr] RPPN ★**

This parameter can be accessed if [Encoder Type] UECP is set to [Resolver] RES.

Setting	Code / Value	Description
[2 poles]	2P	2 poles <b>Factory setting</b>
[4 poles]	4P	4 poles

Setting	Code / Value	Description
[6 poles]	6P	6 poles
[8 poles]	8P	8 poles

### [Sincos lines count] UELC ★

This parameter can be accessed if [Encoder Type] UECP is set to [SinCos] SC.

Setting	Code / Value	Description
[Undefined]	UND	Undefined Factory setting
[1...10000]		Setting range

### [SSI parity] SSCP ★

This parameter can be accessed if [Encoder Type] UECP is set to [SSI] SSI.

Setting	Code / Value	Description
[Undefined]	UND	Undefined Factory setting
[No parity]	NO	No parity
[Even parity]	EVEN	Even parity

### [SSI frame size] SSFS ★

The parameter can be accessed if [Encoder Type] UECP is set to [SSI] SSI.

Setting	Description
[Auto] AUTO...31	Setting range Factory setting: [Auto] AUTO

### [Nbr of revolutions] ENMR ★

Format of the number of revolutions (in number of bits).

The parameter can be accessed if [Encoder Type] UECP is set to [SSI] SSI.

Setting	Description
[Undefined] UND...25	Setting range Factory setting: [Undefined] UND

### [Turn bit resolution] ENTR ★

Resolution per revolution (in number of bits).

The parameter can be accessed if [Encoder Type] UECP is set to [SSI] SSI.

Setting	Description
[Undefined] UND...25	Setting range Factory setting: [Undefined] UND

## [SSI code type] SSCD ★

The parameter can be accessed if [Encoder Type] UECP is set to [SSI] SSI.

Setting	Code / Value	Description
[Undefined]	UND	Undefined Factory setting
[Binary code]	BIN	Binary code
[Gray code]	GRAY	Gray code

## [Clock frequency] ENSP ★

The parameter can be accessed if [Encoder Type] UECP is set to [SSI] SSI.

Setting	Code / Value	Description
[200 kHz]	200k	200 kHz Factory setting
[1 MHz]	1M	1 MHz

## [AB Encoder Max Freq] ABMF ★

This parameter can be accessed if [Encoder Type] UECP is set to [AB] AB or [HTL] HTL and, [Access Level] LAC is set to [Expert] EPR.

This parameter can be used in case of EMC perturbations to adjust the filter of the encoder.

Setting	Code / Value	Description
[150 kHz]	150K	150 kHz
[300 kHz]	300K	300 kHz Factory setting
[500 kHz]	500K	500 kHz
[1000 kHz]	1M	1000 kHz

## [Encoder filter activ.] FFA ★

This parameter can be accessed if [Access Level] LAC is set to [Expert] EPR and:

- [Encoder usage] ENU is not set to [No] NO, or
- [Emb Enc Usage] EENU is not set to [No] NO.

Setting	Code / Value	Description
[No]	NO	Filter deactivated Factory setting
[Yes]	YES	Filter activated



## [Encoder filter value] FFR ★

This parameter can be accessed if:

- [Access Level] LAC is set to [Expert] EPR, and
- [Encoder filter activ.] FFA is set to [Yes] YES.

Setting	Description
0.0...40.0 ms	Setting range  Factory setting: according to encoder rating

## [Stop on top Z] TOST ★

This parameter can be used for homing. If the approach speed is set to high an [DC Bus Overvoltage] OBF error is triggered.

Some encoder provides a top Z signal. With the function linked to this parameter, it is possible to stop the motor on the detection of this signal.

- If the assigned input or bit is at 1 (high level), the function is active: the drive stops the motor with a fast stop on the detection of the next top Z signal.
- If [2/3-Wire Control] TCC is set to [2-Wire Control] 2C and if [2-wire type] TCT is set to [Level] LEL or [Level With Fwd Priority] PFO, the motor restarts when the assigned input or bit switches to 0 (low level) with a run command still activated. If it is not the case, a new run command must be sent.

This parameter can be accessed if:

- A VW3A3420 Digital encoder module has been inserted and [Encoder Type] UECP is set to [AB] AB.
- An embedded encoder is present and if [Emb Enc Type] EECP is set to [AB] AB.

Value range	Code / Value	Description
[Not Assigned]	NO	Not assigned  Factory setting
[DI1]...[DI8]	LI1...LI8	Digital input DI1...DI8  NOTE: DI8 selection can be accessed on drives with a power greater than 22kW.
[DI11]...[DI16]	LI11...LI16	Digital input DI11...DI16 if VW3A3203 I/O extension module has been inserted
[CD00]... [CD10]	CD00...CD10	Virtual digital input CMD.0...CMD.10 in [I/O profile] IO configuration
[CD11]... [CD15]	CD11...CD15	Virtual digital input CMD.11...CMD.15 regardless of configuration
[C101]... [C110]	C101...C110	Virtual digital input CMD1.01...CMD1.10 with integrated Modbus Serial in [I/O profile] IO configuration
[C111]... [C115]	C111...C115	Virtual digital input CMD1.11...CMD1.15 with integrated Modbus Serial regardless of configuration
[C201]... [C210]	C201...C210	Virtual digital input CMD2.01...CMD2.10 with CANopen® fieldbus module in [I/O profile] IO configuration
[C211]... [C215]	C211...C215	Virtual digital input CMD2.11...CMD2.15 with CANopen® fieldbus module regardless of configuration
[C301]... [C310]	C301...C310	Virtual digital input CMD3.01...CMD3.10 with a fieldbus module in [I/O profile] IO configuration
[C311]... [C315]	C311...C315	Virtual digital input CMD3.11...CMD3.15 with a fieldbus module regardless of configuration

Value range	Code / Value	Description
[C501]... [C510]	C501...C510	Virtual digital input CMD5.01...CMD5.10 with integrated Ethernet in [I/O profile] IO configuration <b>NOTE:</b> This selection can be accessed on ATV340...N4E drives.
[C511]... [C515]	C511...C515	Virtual digital input CMD5.11...CMD5.15 with integrated Ethernet regardless of configuration <b>NOTE:</b> This selection can be accessed on ATV340...N4E drives.

## [Reset Position Assign] RPOS

This parameter resets the value of [Encoder Pulse Count] PUC and [Enc Pulse Count 32b] PUCD parameters.

This parameter can be accessed if [Access Level] LAC is set to [Expert] EPR

Identical to [Stop on top Z] TOST.

## [Embedded Encoder]

### [Embedded Encoder] IEE- Menu

#### Access

[Complete settings] → [Embedded Encoder]

#### About This Menu

This menu can be accessed on drives with power **up to 22kW** and if no encoder module (VW3A3420, VW3A3422, VW3A3423 or VW3A3424) has been inserted.

#### [Emb Enc Type] EECF

##### *Emb. enc. type.*

The list of choice depends on the encoder module inserted.

Setting	Code / Value	Description
[None]	NONE	No encoder connected <b>Factory setting</b>
[AB]	AB	AB encoder
[SinCos]	SC	SinCos encoder

#### [Emb Enc Supply Volt] EECV ★

##### *Emb. enc. supply volt..*

Setting	Code / Value	Description
[5 Vdc]	5V	5 Volts
[12 Vdc]	12V	12 Volts <b>Factory setting</b>
[24 Vdc]	24V	24 Volts

#### [Emb Enc Pulses Nb] EPGI ★

Number of pulses per encoder revolution.

The parameter can be accessed if [Emb Enc Type] EECF is set to [AB] AB

Setting	Description
100...10,000	<b>Factory setting:</b> 1024

#### [Encoder check] ENC

##### *Encoder check.*

Setting	Code / Value	Description
[Not done]	NO	Check not performed
[Yes]	YES	Activates monitoring of the encoder.
[Done]	DONE	Check performed successfully. The check procedure checks: <ul style="list-style-type: none"> <li>• The direction of rotation of the encoder/motor</li> <li>• The presence of signals (wiring continuity)</li> <li>• The number of pulses/revolution. If an error is detected, the drive triggers an <b>[Encoder]</b> ENF .</li> </ul>

## [Emb Enc Usage] EENU

### Emb. enc. usage

Setting	Code / Value	Description
[No]	NO	Function inactive <b>Factory setting</b>
[Speed Monitoring]	SEC	The encoder provides speed feedback for monitoring only.
[Speed Regulation]	REG	The encoder provides speed feedback for regulation and monitoring. This configuration is automatic if the drive is configured for closed-loop operation ( <b>[Motor control type]</b> CTT = <b>[FVC]</b> FVC or <b>[Sync.CL]</b> FSY. If <b>[Motor control type]</b> CTT = <b>[SVC V]</b> VVC the encoder operates in speed feedback mode and enables static correction of the speed to be performed. This configuration is not accessible for other <b>[Motor control type]</b> CTT values.
[Speed Reference]	PGR	The encoder provides a speed reference. It can only be selected with an incremental encoder module.

## [Emb Enc Rotation Inv] EERI

### Emb. enc. rotation inv..

Setting	Code / Value	Description
[No]	NO	Inversion of the encoder deactivated <b>Factory setting</b>
[Yes]	YES	Inversion of the encoder activated

## [Emb Enc Sincos lines] EELC ★

This parameter can be accessed if **[Emb Enc Type]** EECF is set to **[SinCos]** SC.

Setting	Code / Value	Description
[Undefined]	UND	Undefined <b>Factory setting</b>
[1...10000]		Setting range

## [Encoder filter activ.] FFA ★

This parameter can be accessed if **[Encoder usage]** ENU is not set to **[No]** NO.

This parameter can be accessed if:

- **[Encoder usage]** `ENU` is not set to **[No]** `NO`, or
- **[Emb Enc Usage]** `EENU` is not set to **[No]** `NO`.

Setting	Code / Value	Description
<b>[No]</b>	<code>NO</code>	Filter deactivated <b>Factory setting</b>
<b>[Yes]</b>	<code>YES</code>	Filter activated

### [Encoder filter value] `FFR` ★

This parameter can be accessed if:

- **[Access Level]** `LAC` is set to **[Expert]** `EPR`, and
- **[Encoder filter activ.]** `FFA` is set to **[Yes]** `YES`.

Setting	Description
0.0...40.0 ms	Setting range <b>Factory setting:</b> according to encoder rating

### [Stop on top Z] `TOST` ★

This parameter can be used for homing. If the approach speed is set to high an **[DC Bus Overvoltage]** `OBV` error is triggered.

This parameter can be accessed if:

- **[Emb Enc Type]** `EETCP` is set to **[AB]** `AB`.

Value range	Code / Value	Description
<b>[Not Assigned]</b>	<code>NO</code>	Not assigned <b>Factory setting</b>
<b>[DI1]...[DI8]</b>	<code>LI1...LI8</code>	Digital input DI1...DI8 <b>NOTE:</b> DI8 selection can be accessed on drives with a power greater than 22kW.
<b>[DI11]...[DI16]</b>	<code>LI11...LI16</code>	Digital input DI11...DI16 if VW3A3203 I/O extension module has been inserted
<b>[CD00]... [CD10]</b>	<code>CD00...CD10</code>	Virtual digital input CMD.0...CMD.10 in <b>[I/O profile]</b> <code>IO</code> configuration
<b>[CD11]... [CD15]</b>	<code>CD11...CD15</code>	Virtual digital input CMD.11...CMD.15 regardless of configuration
<b>[C101]... [C110]</b>	<code>C101...C110</code>	Virtual digital input CMD1.01...CMD1.10 with integrated Modbus Serial in <b>[I/O profile]</b> <code>IO</code> configuration
<b>[C111]... [C115]</b>	<code>C111...C115</code>	Virtual digital input CMD1.11...CMD1.15 with integrated Modbus Serial regardless of configuration
<b>[C201]... [C210]</b>	<code>C201...C210</code>	Virtual digital input CMD2.01...CMD2.10 with CANopen® fieldbus module in <b>[I/O profile]</b> <code>IO</code> configuration
<b>[C211]... [C215]</b>	<code>C211...C215</code>	Virtual digital input CMD2.11...CMD2.15 with CANopen® fieldbus module regardless of configuration
<b>[C301]... [C310]</b>	<code>C301...C310</code>	Virtual digital input CMD3.01...CMD3.10 with a fieldbus module in <b>[I/O profile]</b> <code>IO</code> configuration
<b>[C311]... [C315]</b>	<code>C311...C315</code>	Virtual digital input CMD3.11...CMD3.15 with a fieldbus module regardless of configuration

Value range	Code / Value	Description
[C501]... [C510]	C501...C510	Virtual digital input CMD5.01...CMD5.10 with integrated Ethernet in <b>[I/O profile]</b> IO configuration <b>NOTE:</b> This selection can be accessed on ATV340...N4E drives.
[C511]... [C515]	C511...C515	Virtual digital input CMD5.11...CMD5.15 with integrated Ethernet regardless of configuration <b>NOTE:</b> This selection can be accessed on ATV340...N4E drives.

## [Reset Position Assign] RPOS

This parameter resets the value of **[Encoder Pulse Count]** PUC and **[Enc Pulse Count 32b]** PUCD parameters.

This parameter can be accessed if **[Access Level]** LAC is set to **[Expert]** EPR

Identical to **[Stop on top Z]** TOST.

# [Error/Warning handling]

## [Auto Fault Reset] ATR- Menu

### Access

[Complete settings] → [Error/Warning handling] → [Auto Fault Reset]

### [Auto Fault Reset] ATR

This function can be used to automatically perform individual or multiple Fault Resets. If the cause of the error that has triggered the transition to the operating state Fault disappears while this function is active, the drive resumes normal operation. While the Fault Reset attempts are performed automatically, the output signal "Operating state Fault" is not available. If the attempts to perform the Fault Reset are not successful, the drive remains in the operating state Fault and the output signal "Operating state Fault" becomes active.

<b>⚠ WARNING</b>
<p><b>UNANTICIPATED EQUIPMENT OPERATION</b></p> <ul style="list-style-type: none"> <li>• Verify that activating this function does not result in unsafe conditions.</li> <li>• Verify that the fact that the output signal "Operating state Fault" is not available while this function is active does not result in unsafe conditions.</li> </ul> <p><b>Failure to follow these instructions can result in death, serious injury, or equipment damage.</b></p>

The drive fault relay remains activated if this function is active. The speed reference and the operating direction must be maintained.

It is recommended to use 2-wire control ([2/3-Wire Control] TCC is set to [2-Wire Control] 2C and [2-wire type] TCT is set to [Level] LEL, refer to [2/3-Wire Control] TCC.

If the restart has not taken place once the configurable time [Fault Reset Time] TAR has elapsed, the procedure is aborted and the Drive response to external error. remains locked until it is turned off and then on again.

The detected error codes, which permit this function, are listed in the Diagnostics part of the manual.

Setting	Code / Value	Description
[No]	NO	Function inactive <b>Factory setting</b>
[Yes]	YES	Automatic restart, after locking in error state, if the detected error has disappeared and the other operating conditions permit the restart. The restart is performed by a series of automatic attempts separated by increasingly longer waiting periods: 1 s, 5 s, 10 s, then 1 minute for the following attempts.

### [Fault Reset Time] TAR ★

Maximum time for automatic restart function.

This parameter appears if [Auto Fault Reset] ATR is set to [Yes] YES. It can be used to limit the number of consecutive restarts on a recurrent detected error.

Setting	Code / Value	Description
[5 minutes]	5	5 minutes <b>Factory setting</b>
[10 minutes]	10	10 minutes
[30 minutes]	30	30 minutes
[1 hour]	1H	1 hour
[2 hours]	2H	2 hours
[3 hours]	3H	3 hours
[Unlimited]	CT	Continuous



## [Fault reset] RST- Menu

### Access

[Complete settings] → [Error/Warning handling] → [Fault reset]

### [Fault Reset Assign] RSF

Detected errors are cleared manually when the assigned input or bit changes to 1 if the cause of the detected error has been removed.

All errors cannot be cleared via a Fault Reset. Refer to the table in the part Diagnostics and Troubleshooting to have the full list , page 549.

The **STOP/RESET** key on the Display Terminal performs the same function.

Value range	Code / Value	Description
[Not Assigned]	NO	Not assigned
[DI1]...[DI8]	LI1...LI8	Digital input DI1...DI8 used at high level <b>Factory setting:</b> [DI4] LI4 <b>NOTE:</b> <ul style="list-style-type: none"> <li>On drives with a power equal to or lower than 22 kW, DI6 and DI7 are respectfully DQ1 and DQ2 used as Digital Input.</li> <li>DI8 selection can only be accessed on drives with a power greater than 22kW.</li> </ul>
[DI11]...[DI16]	LI11...LI16	Digital input DI11...DI16 if VW3A3203 extended I/O module has been inserted.
[CD00]... [CD15]	CD00...CD15	Virtual digital input CMD.0...CMD.10 in [I/O profile] IO configuration.
[C101]... [C115]	C101...C115	Virtual digital input CMD1.01...CMD1.15 with integrated Modbus Serial in [I/O profile] IO configuration.
[C201]... [C215]	C201...C215	Virtual digital input CMD2.01...CMD2.10 with CANopen® fieldbus module in [I/O profile] IO configuration.
[C301]... [C315]	C301...C315	Virtual digital input CMD3.01...CMD3.15 with a fieldbus module in [I/O profile] IO configuration.
[C501]... [C515]	C501...C515	Virtual digital input CMD5.01...CMD5.150 with embedded Ethernet in [I/O profile] IO configuration.

### [Product restart] RP ★

The Restart function performs a Fault Reset and then restarts the drive. During this Restart procedure, the drive goes through the same steps as if it had been switched off and on again. Depending on the wiring and the configuration of the drive, this may result in immediate and unanticipated operation.

<b>▲ WARNING</b>
<b>UNANTICIPATED EQUIPMENT OPERATION</b>
The Restart function performs a Fault Reset and restarts the drive. <ul style="list-style-type: none"> <li>Verify that activating this function does not result in unsafe conditions.</li> </ul> <b>Failure to follow these instructions can result in death, serious injury, or equipment damage.</b>

Product restart.

This parameter can be accessed if **[Access Level]** LAC is set to **[Expert]** EPR mode.

This parameter can be used to reset all detected errors without having to disconnect the drive from the supply mains.

Value	Code / Value	Description
[No]	NO	Function inactive <b>Factory setting</b>
[Yes]	YES	Reinitialization. Press and hold down the OK key for 2 s. The parameter changes back to <b>[No]</b> NO automatically as soon as the operation is complete. The drive can only be reinitialized when locked.

## [Prod Restart Assign] RPA ★

The Restart function performs a Fault Reset and then restarts the drive. During this Restart procedure, the drive goes through the same steps as if it had been switched off and on again. Depending on the wiring and the configuration of the drive, this may result in immediate and unanticipated operation.

### ⚠ WARNING

#### UNANTICIPATED EQUIPMENT OPERATION

The Restart function performs a Fault Reset and restarts the drive.

- Verify that activating this function does not result in unsafe conditions.

**Failure to follow these instructions can result in death, serious injury, or equipment damage.**

This parameter can be accessed if **[Access Level]** LAC is set to **[Expert]** EPR mode.

Value range	Code / Value	Description
[Not Assigned]	NO	Not assigned <b>Factory setting</b>
[DI1]...[DI8]	LI1...LI8	Digital input DI1...DI8 used at high level <b>NOTE:</b> <ul style="list-style-type: none"> <li>• On drives with a power equal to or lower than 22 kW, DI6 and DI7 are respectfully DQ1 and DQ2 used as Digital Input.</li> <li>• DI8 selection can only be accessed on drives with a power greater than 22kW.</li> </ul>
[DI11]...[DI16]	LI11...LI16	Digital input DI11...DI16 if VW3A3203 extended I/O module has been inserted.

## [Extended Fault Reset] HRFC ★

When HRFC is set to YES, it allows you to reset hardware type error with the Fault Reset function (see above **[Fault Reset Assign]** RSF).

All hardware type errors cannot be cleared via a this feature. Refer to the table in the part Diagnostics and Troubleshooting to have the full list , page 549.

This feature allows to clear these hardware type errors without disconnection the drive from the power supply.

**NOTICE****INOPERATIVE DRIVE**

- Verify that enabling this parameter does not result in equipment damage.
- Before resetting the detected error, identify and correct the cause of the error.

**Failure to follow these instructions can result in equipment damage.**

This parameter can be accessed if **[Access Level]** LAC is set to **[Expert]** EPR mode.

Value	Code / Value	Description
[No]	NO	Not enable <b>Factory setting</b>
[Yes]	YES	Enable, some hardware type errors can be reset via Fault Reset function.

## [Catch on the fly] FLR– Menu

### Access

[Complete settings] → [Error/Warning handling] → [Catch on the fly]

### [Catch On Fly] FLR

Used to enable a smooth restart if the run command is maintained after the following events:

- Loss of line supply or disconnection.
- Clearing clearance of current detected error or automatic restart.
- Freewheel stop.

The speed given by the drive resumes from the estimated or measured speed of the motor at the time of the restart, then follows the ramp to the reference speed.

This function requires 2-wire level control.

When the function is operational, it activates at each run command, resulting in a slight delay of the current (0.5 s max).

[Catch On Fly] FLR is forced to [Not Configured] NO if

- [Motor control type] CTT is set to [FVC] FVC or [Sync.CL] FSY, or
- [Auto DC Injection] ADC is set to [Continuous] CT, or
- [Brake assignment] BLC is not set to [No] NO, or
- [BL Mode] BQM is not set to [Not Configured] NO.

Setting	Code / Value	Description
[Not Configured]	NO	Function inactive. <b>Factory setting</b>
[Yes On Freewheel]	YES	Function active only after freewheel stop.
[Yes Always]	ALL	Function active after all stop type

**NOTE:** For synchronous reluctance motor, it is recommended to set [Angle setting type] AST to [Rotational Current Injection] RCI.

### [Catch on Fly Sensitivity] VCB ★

This parameter can only be accessed if [Access Level] LAC is set to [Expert] EPR.

If the value of parameter [Catch on Fly Sensitivity] VCB is reduced below the default value, this can result in an incorrect calculation of the speed of the motor.

<b>▲ WARNING</b>
<p><b>LOSS OF CONTROL</b></p> <ul style="list-style-type: none"> <li>• Only reduce the value of parameter [Catch on Fly Sensitivity] VCB in increments of yyyy.</li> <li>• After each reduction of the value of parameter [Catch on Fly Sensitivity] VCB, perform a comprehensive commissioning test to verify that the speed of the motor is correct.</li> </ul> <p><b>Failure to follow these instructions can result in death, serious injury, or equipment damage.</b></p>

Setting	Description
0.10...100.00 V	Setting range <b>Factory setting:</b> 0.20 V

### [Catch On Fly Mode] COFM

Velocity detection method for the Catch on Fly function.

[Catch On Fly Mode] COFM is forced to [Measured] HWCOF for synchronous motors.

Setting	Code / Value	Description
[Measured]	HWCOF	Hardware catch on the fly The motor voltage signal should be greater than [Catch on Fly Sensitivity] VCB to be able to estimate the speed. <b>Factory setting</b>
[Computed]	SWCOF	Software catch on the fly A signal is injected to estimate the speed and the position of the rotor. [Computed] SWCOF method is not effective for a motor velocity range exceeding -HSP or +HSP.

## [Error detect disabling] INH– Menu

### Access

[Complete settings] → [Error/Warning handling] → [Error detect disabling]

### [Disable Error Detect] INH ★

In rare cases, the monitoring functions of the device may be unwanted because they impede the purpose of the application. A typical example is a smoke extractor fan operating as a part of a fire protection system. If a fire occurs, the smoke extractor fan should operate as long as possible, even if, for example, the permissible ambient temperature of the device is exceeded. In such applications, damage to or destruction of the device may be acceptable as collateral damage, for example, to keep other damage from occurring whose hazard potential is assessed to be more severe.

A parameter is provided to disable certain monitoring functions in such applications so that automatic error detection and automatic error responses of the device are no longer active. You must implement alternative monitoring functions for disabled monitoring functions that allow operators and/or master control systems to adequately respond to conditions which correspond to detected errors. For example, if overtemperature monitoring of the device is disabled, the device of a smoke extractor fan may itself cause a fire if errors go undetected. An overtemperature condition can be, for example, signaled in a control room without the device being stopped immediately and automatically by its internal monitoring functions.

## ⚠ DANGER

### ERROR DETECTION FUNCTIONS DISABLED, NO ERROR DETECTION

- Only use this parameter after a thorough risk assessment in compliance with all regulations and standards that apply to the device and to the application.
- Implement alternative monitoring functions for disabled monitoring functions that do not trigger automatic error responses of the device, but allow for adequate, equivalent responses by other means in compliance with all applicable regulations and standards as well as the risk assessment.
- Commission and test the system with the monitoring functions enabled.
- During commissioning, verify that the device and the system operate as intended by performing tests and simulations in a controlled environment under controlled conditions.

**Failure to follow these instructions will result in death or serious injury.**

This parameter can be accessed if [Access Level] LAC is set to [Expert] EPR.

If the assigned input or bit state is:

- 0: error detection is enabled.
- 1: error detection is disabled.

Current errors are cleared on a rising edge from 0 to 1 of the assigned input or bit.

Detection of following errors can be disabled: ANF, BOF, BSQF, CNF, COF, DLF, ENF, EPF1, EPF2, ETHF, FCF1, FCF2, FDR1, FDR2, FWER, IFA, IFB, IFC, IFD, IHF, INFB, INFV, LFF1, LFF3, LFF4, LFF5, LKON, MDLF, MSDF, OBF, OHF, OLC, OLF, OPF1, OPF2, OSF, PGLF, PHF, SLF1, SLF2, SLF3, SOF, SPF, SRF, SSF, STF, T1CF, T3CF, T4CF, T5CF, TECF, TH1F, TH3F, TH4F, TH5F, THEF, TJF, TLOF, TNF, ULF, USF..

Value range	Code / Value	Description
[Not Assigned]	NO	Not assigned <b>Factory setting</b>
[DI1]...[DI8]	LI1...LI8	Digital input DI1...DI8 <b>NOTE:</b> DI8 selection can be accessed on drives with a power greater than 22kW.
[DI11]...[DI16]	LI11...LI16	Digital input DI11...DI16 if VW3A3203 I/O extension module has been inserted
[CD00]... [CD10]	CD00...CD10	Virtual digital input CMD.0...CMD.10 in <b>[I/O profile]</b> IO configuration
[CD11]... [CD15]	CD11...CD15	Virtual digital input CMD.11...CMD.15 regardless of configuration
[C101]... [C110]	C101...C110	Virtual digital input CMD1.01...CMD1.10 with integrated Modbus Serial in <b>[I/O profile]</b> IO configuration
[C111]... [C115]	C111...C115	Virtual digital input CMD1.11...CMD1.15 with integrated Modbus Serial regardless of configuration
[C201]... [C210]	C201...C210	Virtual digital input CMD2.01...CMD2.10 with CANopen® fieldbus module in <b>[I/O profile]</b> IO configuration
[C211]... [C215]	C211...C215	Virtual digital input CMD2.11...CMD2.15 with CANopen® fieldbus module regardless of configuration
[C301]... [C310]	C301...C310	Virtual digital input CMD3.01...CMD3.10 with a fieldbus module in <b>[I/O profile]</b> IO configuration
[C311]... [C315]	C311...C315	Virtual digital input CMD3.11...CMD3.15 with a fieldbus module regardless of configuration
[C501]... [C510]	C501...C510	Virtual digital input CMD5.01...CMD5.10 with integrated Ethernet in <b>[I/O profile]</b> IO configuration <b>NOTE:</b> This selection can be accessed on ATV340...N4E drives.
[C511]... [C515]	C511...C515	Virtual digital input CMD5.11...CMD5.15 with integrated Ethernet regardless of configuration <b>NOTE:</b> This selection can be accessed on ATV340...N4E drives.

## [External error] ETF– Menu

### Access

[Complete settings] → [Error/Warning handling] → [External error]

### [Ext Error assign] ETF

If the assigned bit state is:

- 0: there is no external error.
- 1: there is an external error

Setting	Code / Value	Description
[Not Assigned]	NO	Not assigned <b>Factory setting</b>
[DI1]...[DI8]	LI1...LI8	Digital input DI1...DI8 <b>NOTE:</b> DI8 selection can be accessed on drives with a power greater than 22kW.
[DI11]...[DI16]	LI11...LI16	Digital input DI11...DI16 if VW3A3203 I/O extension module has been inserted
[CD00]... [CD10]	CD00...CD10	Virtual digital input CMD.0...CMD.10 in [I/O profile] IO configuration
[CD11]... [CD15]	CD11...CD15	Virtual digital input CMD.11...CMD.15 regardless of configuration
[C101]... [C110]	C101...C110	Virtual digital input CMD1.01...CMD1.10 with integrated Modbus Serial in [I/O profile] IO configuration
[C111]... [C115]	C111...C115	Virtual digital input CMD1.11...CMD1.15 with integrated Modbus Serial regardless of configuration
[C201]... [C210]	C201...C210	Virtual digital input CMD2.01...CMD2.10 with CANopen® fieldbus module in [I/O profile] IO configuration
[C211]... [C215]	C211...C215	Virtual digital input CMD2.11...CMD2.15 with CANopen® fieldbus module regardless of configuration
[C301]... [C310]	C301...C310	Virtual digital input CMD3.01...CMD3.10 with a fieldbus module in [I/O profile] IO configuration
[C311]... [C315]	C311...C315	Virtual digital input CMD3.11...CMD3.15 with a fieldbus module regardless of configuration
[C501]... [C510]	C501...C510	Virtual digital input CMD5.01...CMD5.10 with integrated Ethernet in [I/O profile] IO configuration <b>NOTE:</b> This selection can be accessed on ATV340••N4E drives.
[C511]... [C515]	C511...C515	Virtual digital input CMD5.11...CMD5.15 with integrated Ethernet regardless of configuration <b>NOTE:</b> This selection can be accessed on ATV340••N4E drives.

### [Ext Error Resp] EPL

Drive response to external error.

Type of stop in the event of an external detected error.

Setting	Code / Value	Description
[Ignore]	NO	External detected error ignored
[Freewheel Stop]	YES	Freewheel stop <b>Factory setting</b>



Setting	Code / Value	Description
[Per STT]	STT	Stop according to configuration of [Type of stop] STT, page 288, without tripping. In this case, the detected error relay does not open and the drive is ready to restart as soon as the detected error has been removed, according to the restart conditions of the active command channel (for example, according to [2/3-Wire Control] TCC and [2-wire type] TCT, page 200 if control is via the terminals). Configuring a warning for this detected error is recommended (assigned to a digital output, for example) in order to indicate the cause of the stop.
[Fallback Speed]	LFF	Change to fallback speed, maintained as long as the detected error persists and the run command has not been removed <sup>(1)</sup>
[Speed maintained]	RLS	The drive maintains the speed being applied when the detected error occurred, as long as the detected error is active and the run command has not been removed <sup>(1)</sup>
[Ramp stop]	RMP	Stop on ramp
[Fast stop]	FST	Fast stop
[DC injection]	DCI	DC injection stop. This type of stop cannot be used with some other functions.
(1) Because, in this case, the detected error does not trigger a stop, it is advisable to assign a relay or digital output to its indication.		

[FallbackSpeed] LFF ★

This parameter can be accessed if the error response parameter is set to [FallbackSpeed] LFF.

Setting	Description
0.0...599.0 Hz	Setting range <b>Factory setting:</b> 0.0 Hz

## [External error] – [Monitoring circuit A] CMCA– to [Monitoring circuit D] CMCD– Menus

### Access

[Complete settings] → [Error/Warning handling] → [External error] → [Monitoring circuit A] to [Monitoring circuit D]

### About These Menus

These menus are used to assign external “Monitoring Circuits” events to drive inputs in order to trigger an error or a warning.

The Monitoring Circuits, wired to these assigned inputs (using [MonitorCircuit x Assign] IFAx), give the possibility to manage 2 levels of monitoring according to [MonitorCircuit x ErrorResp] IFRx configuration:

- A Warning level: the drive triggers a warning [MonitorCircuit x Warn] IWx without stopping the application. Because, in this case, the detected error does not trigger a stop, it is recommended to assign a relay or logic output to its indication.
- An Error level: the drive triggers an error [MonitorCircuit x Error] IFx and stops the application.

Additionally, it is possible to define:

- [MonitorCircuit x Monitor] IFMx: The required drive state conditions to have the monitoring active.
- [MonitorCircuit x Delay] IFDx: The delay before triggering the error or the warning.

### [MonitorCircuit x Assign] IFAx

[MonitorCircuit A Assign] IFAA, [MonitorCircuit B Assign] IFAB, [MonitorCircuit C Assign] IFAC, [MonitorCircuit D Assign] IFAD

Monitoring circuit X assignment (with X = A, B, C or D)

This parameter is used to assign an digital input or a bit to the Monitoring Circuit X.

Monitoring event active when the assigned digital input (high level) or bit switches to 1. With low level, it is when the digital input switches to 0.

Setting	Code / Value	Description
[Not Assigned]	NO	Not assigned <b>Factory setting</b>
[DI1]...[DI8]	LI1...LI8	Digital input DI1...DI8 <b>NOTE:</b> DI8 selection can be accessed on drives with a power greater than 22kW.
[DI11]...[DI16]	LI11...LI16	Digital input DI11...DI16 if VW3A3203 Extended I/O module has been inserted
[DI1 (Low level)]...[DI8 (Low level)]	L1L...L8L	Digital input DI1...DI8 used at low level <b>NOTE:</b> DI8 selection can be accessed on drives with a power greater than 22kW.
[DI11 (Low level)]...[DI16 (Low level)]	L11L...L16L	Digital input DI11...DI16 used at low level if VW3A3203 Extended I/O module has been inserted
[CD00]...[CD15]	CD00...CD15	Bit x digital input ctrl word (e.g. virtual digital input CMD.00...CMD.15). <b>NOTE:</b> CD00...CD10 are only accessible with [Control Mode] CHCF set to [I/O profile] IO.

Setting	Code / Value	Description
[C101]... [C115]	C101...C115	Bit x Modbus ctrl word (e.g. Virtual digital input CMD1.01... CMD1.15 with integrated Modbus Serial) <b>NOTE:</b> C101...C110 are only accessible with [Control Mode] CHCF set to [I/O profile] IO.
[C201]... [C215]	C201...C215	Bit x CANopen ctrl word (e.g. Virtual digital input CMD2.01... CMD2.15 with CANopen® fieldbus module) <b>NOTE:</b> C201...C210 are only accessible with [Control Mode] CHCF set to [I/O profile] IO.
[C301]... [C315]	C301...C315	Bit x Com module ctrl word (e.g. Virtual digital input CMD3.01... CMD3.15 with fieldbus module) <b>NOTE:</b> C301...C310 are only accessible with [Control Mode] CHCF set to [I/O profile] IO.
[C501]... [C515]	C501...C515	Bit x Ethernet ctrl word (e.g. Virtual digital input CMD3.01... CMD3.15 with Ethernet embedded) <b>NOTE:</b> This selection can be accessed on ATV340...N4E drives. <b>NOTE:</b> C501...C510 are only accessible with [Control Mode] CHCF set to [I/O profile] IO.

### [MonitorCircuit x Monitor] IFMx ★

[MonitorCircuit A Monitor] IFMA, [MonitorCircuit B Monitor] IFMB,  
[MonitorCircuit C Monitor] IFMC, [MonitorCircuit D Monitor] IFMD

Monitoring circuit X error monitoring type (with X = A, B, C or D)

This parameter defines the required drive state conditions to have the monitoring of “monitoring circuit x” active.

This parameter can be accessed if Monitoring circuit X is assigned (i.e. [MonitorCircuit x Assign] IFAx is set to a value different from [No] NO).

Setting	Code / Value	Description
[Always Active]	ALL	Always active: monitoring is active irrespective of the drive state. <b>Factory setting</b>
[Ready & Run State]	RRY	Ready and Run state: monitoring is active only if the drive is in RDY or RUN.
[Run State]	RUN	Run state: monitoring is active only if the drive is in RUN.

### [MonitorCircuit x Delay] IFDx ★

[MonitorCircuit A Delay] IFDA, [MonitorCircuit B Delay] IFDB,  
[MonitorCircuit C Delay] IFDC, [MonitorCircuit D Delay] IFDD

Monitoring circuit X delay (with X = A, B, C or D)

This parameter defines a delay before triggering the error or warning. This delay starts when the drive meets the condition defined by [MonitorCircuit x Monitor] IFMx and the input assigned to [MonitorCircuit x Assign] IFAx switches in the correct state.

This parameter can be accessed if Monitoring circuit X is assigned (i.e. [MonitorCircuit x Assign] IFAx is set to a value different from [No] NO).

Setting	Description
0...300 s (step: 1 s)	Setting range <b>Factory setting:</b> 0 s

**[MonitorCircuit x ErrorResp] IFRx** ★

**[MonitorCircuit A ErrorResp] IFR<sub>A</sub>**, **[MonitorCircuit B ErrorResp] IFR<sub>B</sub>**,  
**[MonitorCircuit C ErrorResp] IFR<sub>C</sub>**, **[MonitorCircuit D ErrorResp] IFR<sub>D</sub>**

Response to monitoring circuit X error (with X = A, B, C or D)

This parameter defines the drive response to the “monitoring circuit X” related event that occurs at the end of the delay **[MonitorCircuit x Delay] IFR<sub>Dx</sub>**.

Concerned warnings: **[MonitorCircuit x Warn] IW<sub>x</sub>**

Concerned errors: **[MonitorCircuit x Error] IF<sub>x</sub>**

This parameter can be accessed if Monitoring circuit X is assigned (i.e. **[MonitorCircuit x Assign] IFA<sub>x</sub>** is set to a value different from **[No] NO**).

Setting	Code / Value	Description
<b>[Ignore]</b>	NO	Detected error ignored: A warning is triggered. <sup>(1)</sup>
<b>[Freewheel Stop]</b>	YES	Freewheel stop: the drive stops in freewheel and an error is triggered.  <b>Factory setting</b>
<b>[Per STT]</b>	STT	Stop according to <b>[Type of stop] STT</b> parameter but without error or warning triggered after stop.
<b>[Fallback Speed]</b>	LFF	Change to fallback speed (defined with <b>[Fallback Speed] LFF</b> ), maintained as long as the detected event persists and the run command has not been removed <sup>(1)</sup>
<b>[Speed maintained]</b>	RLS	Speed maintained as long as the detected event persists and the run command has not been removed <sup>(1)</sup>
<b>[Ramp stop]</b>	RMP	Stop on ramp: the drive stops on ramp and an error is triggered.
<b>[Fast stop]</b>	FST	Fast stop: the drive stops on fast stop and an error is triggered.
<b>[DC injection]</b>	DCI	DC injection: the drive stops on DC injection and an error is triggered.
<sup>(1)</sup> : Because, in this case, the detected error does not trigger a stop, it is recommended to assign a relay or logic output to its indication.		

## [Output phase loss] OPL- Menu

### Access

[Complete settings] → [Error/Warning handling] → [Output phase loss]

### [OutPhaseLoss Assign] OPL

**⚠️ DANGER**

**HAZARD OF ELECTRIC SHOCK, EXPLOSION OR ARC FLASH**

If output phase monitoring is disabled, phase loss and, by implication, accidental disconnection of cables, are not detected.

- Verify that the setting of this parameter does not result in unsafe conditions.

**Failure to follow these instructions will result in death or serious injury.**

**NOTE:** [OutPhaseLoss Assign] OPL is set to [Function Inactive] NO when [Motor control type] CTT is set to [Sync. mot.] SYN, [Sync.CL] FSY, [SYN\_U VC] SYNU or [Reluctance Motor] SRVC. Additionally if [HF inj. activation] HFI is set to [No] NO, [OutPhaseLoss Assign] OPL is forced to [Function Inactive] NO.

Setting	Code / Value	Description
[Function Inactive]	NO	Function inactive
[OPF Error Triggered]	YES	Tripping on [OutPhaseLoss Assign] OPL with freewheel stop <b>Factory setting</b>
[No Error Triggered]	OAC	No detected error triggered, but management of the output voltage in order to avoid an overcurrent when the link with the motor is re-established and catch on the fly performed (even if this function has not been configured).The drive switches to [Output cut] SOC state after [OutPhaseLoss Delay] ODT time. Catch on fly is possible as soon as the drive is in stand by output cut [Output cut] SOC state.

### [OutPhaseLoss Delay] ODT

Output (motor) phase loss detection time.

Time delay for taking the [OutPhaseLoss Assign] OPL detected error into account.

Setting ( )	Description
0.5...10 s	Setting range <b>Factory setting: 0.5 s</b>

## [Input phase loss] IPL– Menu

### Access

[Complete settings] → [Error/Warning handling] → [Input phase loss]

### [InPhaseLoss Assign] IPL ★

Loss of input phase error response.

If one supply mains phase is missing and if this leads to performance decrease, an **[Input Phase Loss]** PHF error is triggered.

If 2 or 3 supply mains phases are missing, the drive operate until an **[Supply Mains UnderV]** USF error is triggered.

Setting	Code / Value	Description
[Ignore]	NO	The input phase loss monitoring function is disabled to be used when the drive is supplied via a single-phase supply or by the DC bus
[Freewheel Stop]	YES	The drive stops in freewheel in case of a supply mains phase loss has been detected <b>Factory setting</b>

## [4-20 mA loss] LFL- Menu

### Access

[Complete settings] → [Error/Warning handling] → [4-20 mA loss]

### [AI1 4-20mA loss] LFL1

Drive behavior on AI1 4-20 event.

Setting	Code / Value	Description
[Ignore]	NO	Detected error ignored. This is the only possible configuration if [AI1 Min. Value] CRL1 is not greater than 3 mA <b>Factory setting</b>
[Freewheel Stop]	YES	Freewheel stop
[Per STT]	STT	Stop according to configuration of [Type of stop] STT, without tripping. In this case, the error relay does not open and the drive is ready to restart as soon as the detected error disappears, according to the restart conditions of the active command channel (for example, according to [2/3-Wire Control] TCC and [2-wire type] TCT if control is via the terminals). Configuring a warning for this detected error is recommended (assigned to a digital output, for example) in order to indicate the cause of the stop
[Fallback Speed]	LFF	Change to fallback speed, maintained as long as the detected error persists and the run command has not been removed <sup>(1)</sup>
[Speed maintained]	RLS	The drive maintains the speed being applied when the detected error occurred, as long as the detected error is active and the run command has not been removed <sup>(1)</sup> . If the run order is removed and a new run order is given while the error is still active, the speed setpoint is defined by [Spd Maint Behavior] RLS: <ul style="list-style-type: none"> <li>• [Spd Maint Behavior] RLS=0, then the speed setpoint is 0 Hz</li> <li>• [Spd Maint Behavior] RLS=LSp, then the speed setpoint is the value of the [Low Speed] LSP parameter.</li> </ul>
[Ramp stop]	RMP	Stop on ramp
[Fast stop]	FST	Fast stop
[DC injection]	DCI	DC injection stop. This type of stop cannot be used with some other functions

(1) Because, in this case, the detected error does not trigger a stop, it is advisable to assign a relay or digital output to its indication.

### [AI2 4-20mA loss] LFL2

Drive behavior on AI2 4-20 event.

Identical to [AI1 4-20mA loss] LFL1

### [AI3 4-20mA loss] LFL3

Drive behavior on AI3 4-20 event.

Identical to [AI1 4-20mA loss] LFL1

### [AI4 4-20mA loss] LFL4 ★

Drive behavior on AI4 4-20 event.

Identical to **[AI1 4-20mA loss]** [LFL1](#)

This parameter can be accessed if VW3A3203 I/O extension module has been inserted.

## **[AI5 4-20mA loss]** [LFL5](#) ★

Drive behavior on AI5 4-20 event.

Identical to **[AI1 4-20mA loss]** [LFL1](#)

This parameter can be accessed if VW3A3203 I/O extension module has been inserted.

## **[FallbackSpeed]** [LFF](#) ★

*Fall back speed.*

Setting	Description
0.0...599.0 Hz	Setting range <b>Factory setting:</b> 0.0 Hz

## **[AI Loss Inhibition]** [INLF](#)

Drive behavior on AI 4-20 event inhibition.

Setting	Code / Value	Description
<b>[No]</b>	NO	The drive behaves according to the selection of the AI 4-20 mA Loss <b>Factory setting</b>
<b>[Yes]</b>	YES	When the lost AI is assigned to <b>[Ref Freq 1 Config]</b> <a href="#">FR1</a> , <b>[Ref.1B channel]</b> <a href="#">FR1B</a> or <b>[Ref Freq 2 Config]</b> <a href="#">FR2</a> , the drive ignores the response to the 4-20 mA loss event when set to <b>[Speed maintained]</b> <a href="#">RLS</a> or <b>[Fallback Speed]</b> <a href="#">LFF</a> , and prioritizes the channels switching by applying the reference frequency given through the reference channels <b>[Ref Freq 1 Config]</b> <a href="#">FR1</a> or <b>[Ref.1B channel]</b> <a href="#">FR1B</a> or <b>[Ref Freq 2 Config]</b> <a href="#">FR2</a> or <b>[Forced Local Chan]</b> <a href="#">FLOC</a> (according to <b>[Freq Switch Assign]</b> <a href="#">RFC</a> , <b>[Ref 1B switching]</b> <a href="#">RCB</a> and <b>[Forced Local Assign]</b> <a href="#">FLO</a> parameters). <b>Note:</b> When the lost AI is assigned to <b>[Forced Local Chan]</b> <a href="#">FLOC</a> , the reference channel switching is possible only after deactivating <b>[Forced Local Assign]</b> <a href="#">FLO</a> .



## [Fallback speed] LFF- Menu

### Access

[Complete settings] → [Error/Warning handling] → [Fallback speed]

### [FallbackSpeed] LFF

*Fall back speed.*

Setting	Description
0.0...599.0 Hz	Setting range <b>Factory setting:</b> 0.0 Hz

## [Spd Maint Behavior] RLS– Menu

### Access

[Complete settings] → [Error/Warning handling] → [Spd Maint Behavior]

### [Spd Maint Behavior] RLS

#### ⚠ WARNING

##### LOSS OF CONTROL

- Only modify this parameter after a thorough risk assessment in compliance with all regulations and standards that apply to the device and to the application.
- Only modify this parameter from the default value if you can positively exclude that this can result in unsafe condition.
- Always consider to limit the duration of this usage by identifying and clearing, as soon as possible, the cause of the detected error

**Failure to follow these instructions can result in death, serious injury, or equipment damage.**

[Speed maintained] RLS behavior on ramp output 0.

This parameter defines the speed setpoint when the response to the [4-20 mA loss] LFL event is [Speed maintained] RLS.

Setting	Code / Value	Description
0		The speed setpoint is 0 <b>Factory setting</b>
[Low Speed]	LSP	The speed setpoint equals the value of the [Low Speed] LSP when the speed reference is 0 Hz before the [4-20 mA loss] LFL event

## [Fieldbus monitoring] CLL- Menu

### Access

[Complete settings] → [Error/Warning handling] → [Fieldbus monitoring]

### [Modbus Error Resp] SLL

<b>⚠ WARNING</b>
<p><b>LOSS OF CONTROL</b></p> <p>If this parameter is set to [Ignore] NO, Modbus communication monitoring is disabled.</p> <ul style="list-style-type: none"> <li>• Only use this setting after a thorough risk assessment in compliance with all regulations and standards that apply to the device and to the application.</li> <li>• Only use this setting for tests during commissioning.</li> <li>• Verify that communication monitoring has been re-enabled before completing the commissioning procedure and performing the final commissioning test.</li> </ul> <p><b>Failure to follow these instructions can result in death, serious injury, or equipment damage.</b></p>

Behavior of the drive in the event of a communication interruption with integrated Modbus.

Setting	Code / Value	Description
[Ignore]	NO	Detected error ignored
[Freewheel Stop]	YES	Freewheel stop <b>Factory setting</b>
[Per STT]	STT	Stop according to configuration of [Type of stop] STT, without tripping. In this case, the error relay does not open and the drive is ready to restart as soon as the detected error disappears, according to the restart conditions of the active command channel (for example, according to [2/3-Wire Control] TCC and [2-wire type] TCT if control is via the terminals <sup>(1)</sup> )
[Fallback Speed]	LFF	Change to fallback speed, maintained as long as the detected error persists and the run command has not been removed <sup>(1)</sup>
[Speed maintained]	RLS	The drive maintains the speed being applied when the detected error occurred, as long as the detected error is active and the run command has not been removed <sup>(1)</sup> . If the run order is removed and a new run order is given while the error is still active, the speed setpoint is defined by [Spd Maint Behavior] RLS: <ul style="list-style-type: none"> <li>• [Spd Maint Behavior] RLS=0, then the speed setpoint is 0 Hz</li> <li>• [Spd Maint Behavior] RLS=LSp, then the speed setpoint is the value of the [Low Speed] LSP parameter.</li> </ul>
[Ramp stop]	RMP	Stop on ramp
[Fast stop]	FST	Fast stop
[DC injection]	DCI	DC injection stop. This type of stop cannot be used with some other functions

(1) Because, in this case, the detected error does not trigger a stop, it is advisable to assign a relay or digital output to its indication.

## [FallbackSpeed] LFF

### *Fall back speed.*

Setting	Description
0.0...599.0 Hz	Setting range <b>Factory setting:</b> 0.0 Hz

## [Fallback Channel] AFFL

Automatic fallback behavior in case of fieldbus communication interruption.

For more information about this parameter refer to [Fallback Channel] AFFL, page 497.

## [Embedded modbus TCP] EMTC- Menu

### Access

[Complete settings] → [Error/Warning handling] → [Embedded modbus TCP]

### [Eth Error Response] ETHL

<b>▲ WARNING</b>
<p><b>LOSS OF CONTROL</b></p> <p>If this parameter is set to [Ignore] NO, Ethernet communication monitoring is disabled.</p> <ul style="list-style-type: none"> <li>• Only use this setting after a thorough risk assessment in compliance with all regulations and standards that apply to the device and to the application.</li> <li>• Only use this setting for tests during commissioning.</li> <li>• Verify that communication monitoring has been re-enabled before completing the commissioning procedure and performing the final commissioning test.</li> </ul> <p><b>Failure to follow these instructions can result in death, serious injury, or equipment damage.</b></p>

The error response to a communication interruption is effective if the communication channel is involved in the active command channel.

**NOTE:** For ATV340••••S, the setting of this parameter must be let to [Freewheel Stop] YES.

Setting	Code / Value	Description
[Ignore]	NO	Detected error ignored
[Freewheel Stop]	YES	Freewheel stop <b>Factory setting</b>
[Per STT]	STT	Stop according to configuration of [Type of stop] STT, without tripping. In this case, the error relay does not open and the drive is ready to restart as soon as the detected error disappears, according to the restart conditions of the active command channel (for example, according to [2/3-Wire Control] TCC and [2-wire type] TCT if control is via the terminals <sup>(1)</sup> )
[Fallback Speed]	LFF	Change to fallback speed, maintained as long as the detected error persists and the run command has not been removed <sup>(1)</sup>
[Speed maintained]	RLS	The drive maintains the speed being applied when the detected error occurred, as long as the detected error is active and the run command has not been removed <sup>(1)</sup> . If the run order is removed and a new run order is given while the error is still active, the speed setpoint is defined by [Spd Maint Behavior] RLS: <ul style="list-style-type: none"> <li>• [Spd Maint Behavior] RLS=0, then the speed setpoint is 0 Hz</li> <li>• [Spd Maint Behavior] RLS=LSp, then the speed setpoint is the value of the [Low Speed] LSP parameter.</li> </ul>
[Ramp stop]	RMP	Stop on ramp
[Fast stop]	FST	Fast stop
[DC injection]	DCI	DC injection stop. This type of stop cannot be used with some other functions
<p>(1) Because, in this case, the detected error does not trigger a stop, it is advisable to assign a relay or digital output to its indication.</p>		

## [FallbackSpeed] LFF ★

### *Fall back speed.*

Setting	Description
0.0...599.0 Hz	Setting range <b>Factory setting:</b> 0.0 Hz

## [Fallback Channel] AFFL

Automatic fallback behavior in case of fieldbus communication interruption.

For more information about this parameter refer to [Fallback Channel] AFFL, page 497.

## [Communication Module] COMO- Menu

### Access

[Complete settings] → [Error/Warning handling] → [Communication Module]

### [Fieldbus Interrupt Resp] CLL

<b>⚠ WARNING</b>
<p><b>LOSS OF CONTROL</b></p> <p>If this parameter is set to [Ignore] NO, Modbus communication monitoring is disabled.</p> <ul style="list-style-type: none"> <li>• Only use this setting after a thorough risk assessment in compliance with all regulations and standards that apply to the device and to the application.</li> <li>• Only use this setting for tests during commissioning.</li> <li>• Verify that communication monitoring has been re-enabled before completing the commissioning procedure and performing the final commissioning test.</li> </ul> <p><b>Failure to follow these instructions can result in death, serious injury, or equipment damage.</b></p>

Response to fieldbus module communication interruption.

Setting	Code / Value	Description
[Ignore]	NO	Detected error ignored
[Freewheel Stop]	YES	Freewheel stop <b>Factory setting</b>
[Per STT]	STT	Stop according to configuration of [Type of stop] STT, without tripping. In this case, the error relay does not open and the drive is ready to restart as soon as the detected error disappears, according to the restart conditions of the active command channel (for example, according to [2/3-Wire Control] TCC and [2-wire type] TCT if control is via the terminals) <sup>(1)</sup>
[Fallback Speed]	LFF	Change to fallback speed, maintained as long as the detected error persists and the run command has not been removed <sup>(1)</sup>
[Speed maintained]	RLS	The drive maintains the speed being applied when the detected error occurred, as long as the detected error is active and the run command has not been removed <sup>(1)</sup> . If the run order is removed and a new run order is given while the error is still active, the speed setpoint is defined by [Spd Maint Behavior] RLS: <ul style="list-style-type: none"> <li>• [Spd Maint Behavior] RLS=0, then the speed setpoint is 0 Hz</li> <li>• [Spd Maint Behavior] RLS=LSp, then the speed setpoint is the value of the [Low Speed] LSP parameter.</li> </ul>
[Ramp stop]	RMP	Stop on ramp
[Fast stop]	FST	Fast stop
[DC injection]	DCI	DC injection stop. This type of stop cannot be used with some other functions
<p>(1) Because, in this case, the detected error does not trigger a stop, it is advisable to assign a relay or digital output to its indication.</p>		

## [CANopen Error Resp] COL

<b>⚠ WARNING</b>
<p><b>LOSS OF CONTROL</b></p> <p>If this parameter is set to <b>[Ignore] NO</b>, CANopen communication monitoring is disabled.</p> <ul style="list-style-type: none"> <li>• Only use this setting after a thorough risk assessment in compliance with all regulations and standards that apply to the device and to the application.</li> <li>• Only use this setting for tests during commissioning.</li> <li>• Verify that communication monitoring has been re-enabled before completing the commissioning procedure and performing the final commissioning test.</li> </ul> <p><b>Failure to follow these instructions can result in death, serious injury, or equipment damage.</b></p>

Response to CANopen error.

Behavior of the drive in the event of a communication interruption with CANopen®.

**Possible settings:** Identical to **[Fieldbus Interrupt Resp] CLL**.

**Factory setting:** **[Freewheel Stop] YES**

## [Eth Error Response] ETHL

<b>⚠ WARNING</b>
<p><b>LOSS OF CONTROL</b></p> <p>If this parameter is set to <b>[Ignore] NO</b>, Ethernet communication monitoring is disabled.</p> <ul style="list-style-type: none"> <li>• Only use this setting after a thorough risk assessment in compliance with all regulations and standards that apply to the device and to the application.</li> <li>• Only use this setting for tests during commissioning.</li> <li>• Verify that communication monitoring has been re-enabled before completing the commissioning procedure and performing the final commissioning test.</li> </ul> <p><b>Failure to follow these instructions can result in death, serious injury, or equipment damage.</b></p>

Response to Ethernet error.

The error response to a communication interruption is effective if the communication channel is involved in the active command channel.

**NOTE:** For ATV340.....S, the setting of this parameter must be let to **[Freewheel Stop] YES**.

**Possible settings:** Identical to **[Fieldbus Interrupt Resp] CLL**.

**Factory setting:** **[Freewheel Stop] YES**

## [FallbackSpeed] LFF ★

*Fall back speed.*

Setting	Description
0.0...599.0 Hz	Setting range <b>Factory setting:</b> 0.0 Hz



## [Fallback Channel] AFFL

Fieldbus communication loss fallback channel.

Automatic fallback behavior in case of fieldbus communication interruption.

If this feature is enabled, in case of communication interruption, [Freq Switch Assign] RFC and [Command Switching] CCS are both forced to channel 1 or channel 2 (depending on [Fallback Channel] AFFL configuration) while the communication interruption is active. During this fallback behavior [Fallback Channel] AFFL warning remains active.

It is required to not use continuously the fallback mode. The cause of the communication interruption must be analyzed and cleared to switch back to normal operation using fieldbus.

### ⚠ WARNING

#### WRONG BEHAVIOR

- Only modify this parameter from the default value after a thorough risk assessment in compliance with all regulations and standards that apply to the device and to the application.
- Only modify this parameter from the default value if you can positively exclude that this can result in unsafe conditions.
- Perform a comprehensive commissioning test to verify correct operation of the application when fallback mode is active.

**Failure to follow these instructions can result in death, serious injury, or equipment damage.**

This parameter can be accessed if [Access Level] LAC is set to [Expert] EPR.

This feature is incompatible with 2-wire control on level (i.e. this parameter is forced to [Not Active] NO if [2-wire type] TCT is set to [Level] LEL or [Level With Fwd Priority] PFO).

Setting	Code / Value	Description
[Not Active]	NO	Feature disabled. <sup>(1)</sup> <b>Factory setting</b>
[Fallback To CH1]	CH1	Fallback to channel 1. <sup>(2)</sup>
[Fallback To CH2]	CH2	Fallback to channel 2. <sup>(2)</sup>

<sup>(1)</sup>: If this parameter is switched back to [Not Active] NO, verify that the settings of the parameters listed below are configured accordingly with the application requirements.

<sup>(2)</sup>: According to the channel switched on in case of communication interruption, the related communication monitoring parameters must be disabled manually.

List of parameters:

- [Modbus Error Resp] SLL,
- [Fieldbus Interrupt Resp] CLL,
- [CANopen Error Resp] COL,
- [Eth Error Response] ETHL.

## [Undervoltage handling] USB– Menu

### Access

[Complete settings] → [Error/Warning handling] → [Undervoltage handling]

### [Undervoltage Resp] USB

*Response to undervoltage.*

Setting	Code / Value	Description
[Error Triggered]	0	The drive triggers an error (the detected error relay assigned to [Operating State Fault] FLT is opened) <b>Factory setting</b>
[Error Triggered w/o Relay]	1	The drive triggers an error (the detected error relay assigned to [Operating State Fault] FLT remains closed)
[Warning Triggered]	2	The warning and detected error relay remain closed. The warning can be assigned to a digital output or a relay

### [Mains voltage] URES

Rated voltage of the mains supply in Vac.

The factory setting value of this parameter depends of drive rating.

Settings	Code / Value	Description
[380 Vac]	380	380 Vac
[400 Vac]	400	400 Vac
[415 Vac]	415	415 Vac
[440 Vac]	440	440 Vac
[460 Vac]	460	460 Vac
[480 Vac]	480	480 Vac

### [Undervoltage level] USL

The factory setting is determined by the drive voltage rating.

Setting	Description
100...354 Vac	Setting range, according to drive rating <b>Factory setting:</b> According to drive rating

### [UnderVolt timeout] UST

*Undervoltage timeout.*

Setting	Description
0.2...999.9 s	Setting range <b>Factory setting:</b> 0.2 s

## [Stop Type PLoss] STP

Behavior in the event of the undervoltage prevention level being reached.

Setting	Code / Value	Description
[Inactive]	NO	No action <b>Factory setting</b>
[Maintain DC Bus]	MMS	This stop mode uses the inertia of the application to maintain the control block powered, and thus to keep operational I/O state and fieldbus link as long as possible.
[Ramp Stop]	RMP	Stop following an adjustable deceleration ramp <b>[Max stop time] STM</b> in order to help to prevent from uncontrolled stop of the application.
[Freewheel Stop]	LNf	Lock (freewheel stop) without triggering an error

## [UnderV. restart tm] TSM ★

This parameter can be accessed if **[Stop Type PLoss] STP** is set to **[Ramp Stop] RMP**.

The time delay before authorizing the restart after a complete stop for **[Stop Type PLoss] STP** is set to **[Ramp Stop] RMP** if the voltage has returned to normal.

Setting ( )	Description
1.0...999.9 s	Setting range <b>Factory setting:</b> 1.0 s

## [Prevention level] UPL ★

This parameter can be accessed if **[Stop Type PLoss] STP** is set to **[Inactive] NO**.

The adjustment range and factory setting are determined by the drive voltage rating and the **[Mains voltage] URES** value.

Setting	Description
141...414 V	Setting range <b>Factory setting:</b> According to drive rating

## [Max stop time] STM ★

This parameter can be accessed if **[Stop Type PLoss] STP** is set to **[Ramp Stop] RMP**.

This parameter defines the deceleration ramp time in case of mains loss. During this controlled stop, the drive is powered thanks to the inertia of the application, the motor is in generator mode. It is recommended to verify that the deceleration set is compatible with the application inertia.

Setting ( )	Description
0.01...60.00 s	Setting range <b>Factory setting:</b> 1.00 s

## [DC bus maintain time] TBS ★

This parameter can be accessed if [Stop Type PLoss] STP is set to [Maintain DC Bus] MMS.

Setting ( )	Description
1...9999 s	Setting range <b>Factory setting:</b> 9999 s

## [Ground Fault] GRFL- Menu

### Access

[Complete settings] → [Error/Warning handling] → [Ground Fault]

### About This Menu

This menu can be accessed if [Access Level] LAC is set to [Expert] EPR

If the internal ground fault detection [Ground Fault Activation] GRFL causes unwanted results in your application, it is possible to substitute the internal ground fault detection by an appropriate external ground fault monitoring system. Setting the parameter [Ground Fault Activation] GRFL to [Disable Error Detect] INH or to a percentage value of the nominal current of the drive disables the internal ground fault detection of the drive or reduces its effectiveness. Therefore, you must install an external ground fault detection system that is able to reliably detect ground faults.

**⚠️⚠️ DANGER**

**GROUND FAULT MONITORING DISABLED**

- Only set the parameter [Ground Fault Activation] GRFL to [Disable Error Detect] INH or to a percentage value of the nominal current of the drive after a thorough risk assessment in compliance with all regulations and standards that apply to the device and to the application.
- Implement an alternative, external ground fault monitoring function that allows for an adequate, equivalent response to a ground fault of the drive in compliance with all applicable regulations and standards as well as the risk assessment.
- Commission and test the system with all monitoring functions enabled.
- During commissioning, verify that the alternative, external ground fault detection system properly detects any type of ground faults by performing tests and simulations in a controlled environment under controlled conditions.

**Failure to follow these instructions will result in death or serious injury.**

## [Ground Fault Activation] GRFL

**NOTE:** The setting of this parameter is taken into account after a product restart.

Setting	Code / Value	Description
[No]	INH	Disables error detection
[Yes]	YES	Use product internal value. Around 25 % of the drive nominal current on drives with a power greater than 11 kW. Around 50 % of the drive nominal current on drives with a power equal or lower than 11 kW. <b>Factory setting</b>
0.0...100.0%	_	Setting range, in % of the drive nominal current

## [Motor thermal monit] THT- Menu

### Access

[Complete settings] → [Error/Warning handling] → [Motor thermal monit]

### About this Menu

Motor thermal protection by calculating the  $I^2t$ .

**NOTE:** The motor thermal state is memorized when the drive is switched off. The power-off time is used to calculate the motor thermal state at the next startup.

- Self-cooled motors: The trigger curves depend on the motor frequency.
- Forced-cooled motors: Only the 50 Hz trigger curves needs to be considered, regardless of the motor frequency.

Below a curve for 50Hz motor.

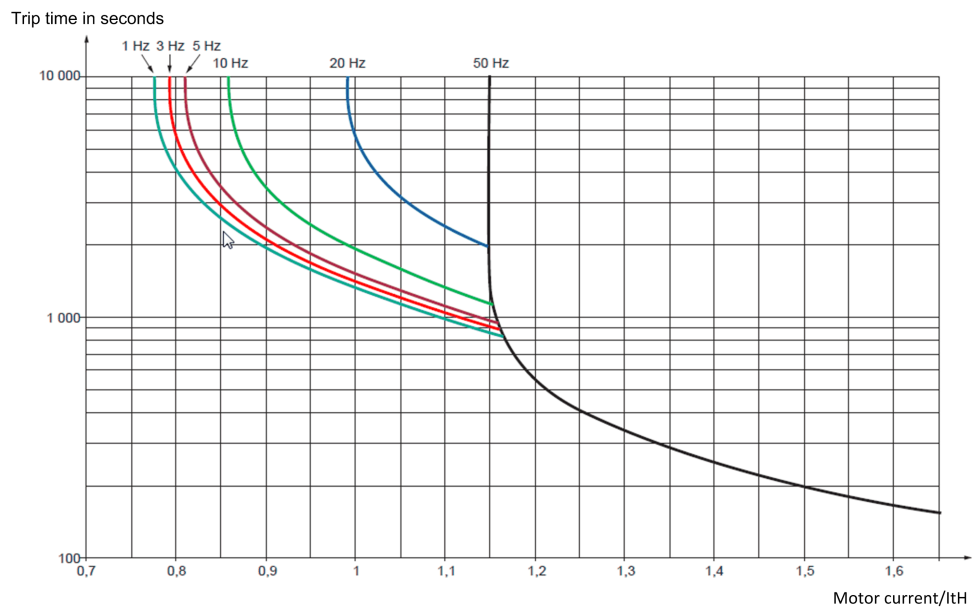

Below a curve for 60Hz motor.

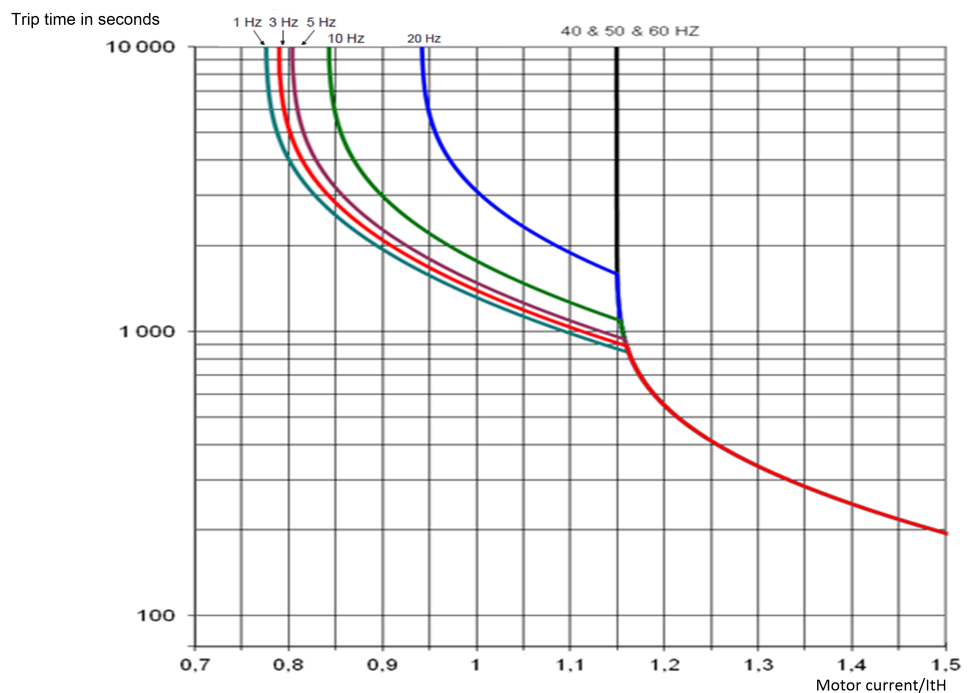

## [Motor Th Current] ITH

Motor thermal monitoring current to be set to the rated current indicated on the nameplate.

Setting ( )	Description
0.2...1.8_In <sup>(1)</sup>	Setting range <b>Factory setting:</b> According to drive rating
(1) Corresponding to the rated drive current indicated in the installation manual and on the drive nameplate.	

## [Motor Thermal Mode] THT

**NOTE:** An error is detected when the thermal state reaches 118% of the rated state and reactivation occurs when the state falls back below 100%.

Setting	Code / Value	Description
[No]	NO	No thermal monitoring
[Self cooled]	ACL	Self ventilated motor <b>Factory setting</b>
[Force-cool]	FCL	Fan-cooled motor

## [Encoder monitoring] SDD– Menu

### Access

[Complete settings] → [Error/Warning handling] → [Encoder monitoring]

### [Load slip detection] SDD

#### Load slip detection.

Setting	Code / Value	Description
[No]	NO	No error triggered. The warning may be assigned to a digital output or a relay <b>Factory setting</b>
[Yes]	YES	Error triggered. [Load slip detection] SDD is set to [Yes] YES if [Motor control type] CTT is set to [FVC] FVC or [Sync.CL] FSY.  The [Load slipping] ANF error is triggered by comparing the ramp output and the speed feedback, and is effective for speeds greater than 10% of the [Nominal Motor Freq] FRS.  In the event of an error is triggered, the drive stops in freewheel, and if the brake logic control function has been configured, the brake command is set to 0.

### [Encoder Coupling Monit] ECC ★

This parameter can be accessed if [Encoder usage] ENU is not set to [No] NO.

Setting	Code / Value	Description
[No]	NO	Error not monitored <b>Factory setting</b>
[Yes]	YES	Error monitored. If the brake logic control function has been configured, the factory setting changes to [Yes] YES.  [Encoder Coupling Monit] ECC set to [Yes] YES is only possible if: <ul style="list-style-type: none"> <li>• [Load slip detection] SDD is set to [Yes] YES, and</li> <li>• [Encoder usage] ENU is not set to [No] NO, and</li> <li>• [Brake assignment] BLC is not set to [No] NO</li> </ul> The error monitored is the break in the mechanical coupling of the encoder.  In the event of an error, the drive switches to a freewheel stop, and if the brake logic control function has been configured, the brake command is released.

### [Encoder check time] ECT ★

This parameter can be accessed if:

- [Encoder usage] ENU is not set to [No] NO, and
- [Encoder Coupling Monit] ECC is not set to [No] NO.

Setting ( )	Description
2.0...10.0 s	Setting range <b>Factory setting:</b> 2.0 s



## [Braking Resistor monit] BRP- Menu

### Access

[Complete settings] → [Error/Warning handling] → [Braking Resistor monit]

### About This Menu

This function is used to monitored the thermal state of the brake resistors.

The calculation used for the monitoring estimates the overall thermal state of all the brake resistors. The brake resistor monitoring function does not replace the thermal contact monitoring of each managed braking resistor. This function does not monitor the IGBT, the short circuit and the presence of the braking resistor(s). The internal calculation uses the characteristics of the equivalent braking resistor such as the time constant, the equivalent power and the rated value of the resistor. Refer to the braking resistor supplier to gather the information. See for example the following table:

catalog number	time constant (in s)	catalog number	time constant (in s)	catalog number	time constant (in s)
VW3A7730	23	VW3A7740	39	VW3A7750	74
VW3A7731	39	VW3A7741	50	VW3A7751	116
VW3A7732	36	VW3A7742	161	VW3A7752	94
VW3A7733	74	VW3A7743	140	VW3A7753	179
VW3A7734	94	VW3A7744	131	VW3A7754	227
VW3A7735	140	VW3A7745	167	VW3A7755	235
VW3A7736	104	VW3A7746	202	VW3A7756	271
VW3A7737	217	VW3A7747	236	VW3A7757	289
VW3A7738	283	VW3A7748	234		

Depending on the setting of [Braking Resistor Monit] BRO, if [DBR thermal state] THB reaches 100 %, the error [Braking Resistor ovlld] BOF or the warning [BR Thermal Warning] BOA is triggered.

### [Braking Resistor Monit] BRO

#### Braking resistor monitoring.

Setting	Code / Value	Description
[Ignore]	NO	No braking resistor monitoring (thereby preventing access to the other function parameters). <b>Factory setting</b>
[Warning]	YES	The warning may be assigned to a logic output or a relay.
[Error]	FLT	Triggering a [Braking Resistor ovlld] BOF with locking of drive (freewheel stop).

### [Braking Resistor Power] BRP ★

Rated power of the resistor used.

Insert the total power of all installed braking resistors.

This parameter can be accessed if **[Braking Resistor Monit]** **BRO** is not set to **[Ignore]** **NO**.

Setting ( )	Description
0.1...3,000.0 kW	Setting range <b>Factory setting:</b> 0.1 kW

## [Braking Resistor Value] **BRV** ★

Rated value of the braking resistor in ohms.

This parameter can be accessed if **[Braking Resistor Monit]** **BRO** is not set to **[Ignore]** **NO**.

Setting ( )	Description
0.1...200.0 Ohm	Setting range <b>Factory setting:</b> 0.1 Ohm

## [Braking Resist T Constant] **BRTC** ★

This parameter can be accessed if **[Braking Resistor Monit]** **BRO** is not set to **[Ignore]** **NO**.

Setting ( )	Description
0...200 s	Setting range <b>Factory setting:</b> 45 s

## [DBR thermal state] **THB**

Read-only parameter.

At power on, the value is updated according to the time the drive has been powered off.

This parameter is expressed in % of the nominal power (**[Braking Resistor Power]** **BRP**).

Setting	Description
0...118%	Setting range <b>Factory setting:</b> _

## [Torque or I limit detect] TID- Menu

### Access

[Complete settings] → [Error/Warning handling] → [Torque or I limit detect]

### [Trq/I limit. stop] SSB

Torque current limitation: behaviour configuration.

Setting	Code / Value	Description
[Ignore]	NO	Detected error ignored <b>Factory setting</b>
[Freewheel Stop]	YES	Freewheel stop
[Per STT]	STT	Stop according to [Type of stop] STT parameter but without an error triggered after stop
[Fallback Speed]	LFF	Change to fallback speed, maintained as long as the detected error persists and the run command has not been removed <sup>(1)</sup>
[Speed maintained]	RLS	The drive maintains the speed being applied when the detected error occurred, as long as the detected error is active and the run command has not been removed <sup>(1)</sup> .
[Ramp stop]	RMP	Stop on ramp
[Fast stop]	FST	Fast stop
[DC injection]	DCI	DC injection
<sup>1</sup> Because, in this case, the detected error does not trigger a stop, it is recommended to assign a relay or logic output to its indication.		

### [Trq/I Limit Timeout] STO

Torque current limitation: [Torque Limitation Error] SSF error delay and [Torque Limit Reached] SSA warning delay.

Setting ( )	Description
1...9,999 ms	Setting range <b>Factory setting:</b> 1,000 ms

## [Drive overload monit] OBR– Menu

### Access

[Complete settings] → [Error/Warning handling] → [Drive overload monit]

### Drive Overload Monitoring

When [Drive Overload Monit] **TLOL** is set to [I2t Current Reduction] **I2T**, the drive adapts automatically its overload capabilities.

The current limitation is automatically reduced depending of the machine cycles.

If [Dual rating] **DRT** is set to [Normal Duty] **NORMAL**, the maximum overload capabilities are:

- 110% of drive nominal current for 60 seconds.
- 135% of drive nominal current for 2 seconds.

If [Dual rating] **DRT** is set to [Heavy Duty] **HIGH**, the maximum overload capabilities are:

- 150% of drive nominal current for 60 seconds.
- 180% of drive nominal current for 2 seconds.

If the drive currents is greater than the 2 or 60 seconds limits given above, the current limitation of the drive is reduced automatically and the [Current Reduc Warn] **TLOW** warning is activated.

The current limitation can be reduced up to drive nominal current.

**NOTE:** The overload state is stored when the product is powered off. At next power on, the drive reacts according to the value of [I2t Actual Load Value] **TLOA**.

## [DriveTemp ErrorResp] OHL

*Drive overtemp error response.*

Setting	Code / Value	Description
[Ignore]	NO	Detected error ignored
[Freewheel Stop]	YES	Freewheel stop <b>Factory setting</b>
[Per STT]	STT	Stop according to configuration of [Type of stop] <b>STT</b> , without tripping. In this case, the error relay does not open and the drive is ready to restart as soon as the detected error disappears, according to the restart conditions of the active command channel (for example, according to [2/3-Wire Control] <b>TCC</b> and [2-wire type] <b>TCT</b> if control is via the terminals) <sup>(1)</sup>
[Fallback Speed]	LFF	Change to fallback speed, maintained as long as the detected error persists and the run command has not been removed <sup>(1)</sup>
[Speed maintained]	RLS	The drive maintains the speed being applied when the detected error occurred, as long as the detected error is active and the run command has not been removed <sup>(1)</sup> . If the run order is removed and a new run order is given while the error is still active, the speed setpoint is defined by [Spd Maint Behavior] <b>RLS</b> : <ul style="list-style-type: none"> <li>• [Spd Maint Behavior] <b>RLS</b>=0, then the speed setpoint is 0 Hz</li> <li>• [Spd Maint Behavior] <b>RLS</b>=LSp, then the speed setpoint is the value of the [Low Speed] <b>LSP</b> parameter.</li> </ul>
[Ramp stop]	RMP	Stop on ramp
[Fast stop]	FST	Fast stop

Setting	Code / Value	Description
[DC injection]	DCI	DC injection stop. This type of stop cannot be used with some other functions
(1) Because, in this case, the detected error does not trigger a stop, it is advisable to assign a relay or digital output to its indication.		

## [Dev Thermal Warning] THA

Drive thermal state warning (for [Dev Thermal reached] TAD warning).

Setting ( )	Description
0...118%	Setting range <b>Factory setting:</b> 100%

## [Drive Overload Monit] TLOL

<b>NOTICE</b>
<p><b>OVERHEATING</b></p> <p>If [Drive Overload Monit] TLOL is set to [Disabled] DIS, drive overheating monitoring is disabled.</p> <ul style="list-style-type: none"> <li>Verify that the settings of this parameter do not result in equipment damage.</li> </ul> <p><b>Failure to follow these instructions can result in equipment damage.</b></p>

**NOTE:** If [Drive Overload Monit] TLOL is set to [Reduce to I Nom Drive] LIM the drive reduces, after the specified overload time, an overload current down to the drive nominal current. This function does not work for constant load applications. For all applications with increasing loads the drive therefore operates on slightly reduced speed but without triggering an error.

Setting	Code / Value	Description
[Disabled]	DIS	Disabled. <b>Factory setting:</b> For drives with power greater than 22 kW. This setting can only be accessed on drives with a power equal to or lower than 22 kW if [Brake assignment] BLC is not assigned.
[I2t Current Reduction]	I2T	I2t Current Reduction <b>Factory setting:</b> For drives with power up to 22 kW. This setting can only be accessed on drives with a power greater than 22 kW.
[Error Triggered]	TRIP	Error triggered
[Reduce to I Nom Drive]	LIM	The motor current is limited to drive nominal current. This setting can only be accessed on drives with a power greater than 22 kW if [Brake assignment] BLC is not assigned.

## [I2t Actual Load Value] TLOA

If the value of this parameter is greater than 100%, the current limitation is automatically reduced.

- This value increases only if the actual current is greater than the drive nominal current.

- This value decreases automatically depending of internal calculations.

This parameter can be accessed if **[Drive Overload Monit]** TLOL is set to **[I2t Current Reduction]** I2T.

Setting ( )	Description
-3276.7...3276.7 %	Setting range <b>Factory setting:</b> 0.0 %

## [I2t Mean Load Value] TLOM

This parameter indicates the average load value of the drive.

This parameter can be accessed if **[Drive Overload Monit]** TLOL is set to **[I2t Current Reduction]** I2T.

Setting ( )	Description
-3276.7...3276.7 %	Setting range <b>Factory setting:</b> 0.0 %

## [Warn grp 1 definition] A1C– to [Warn grp 5 definition] A5C– Menus

### Access

[Complete settings] → [Error/Warning handling] → [Warning groups config]  
→ [Warn grp 1 definition] to [Warn grp 5 definition]

### About This Menu

The following submenus group the warnings into 1 to 5 groups, each of which can be assigned to a relay or a digital output for remote signaling.

When one or a number of warnings selected in a group occur, this warning group is activated.

### List of Warnings

The list of warning codes is available in the chapter "Diagnostics and Troubleshooting".

## [ON lock settings] LKON- Menu

### Access

[Complete settings] → [Error/Warning handling] → [ON lock settings]

### About This Menu

The “On lock” function helps to prevent the drive to start if the system is not ready to switch-on by meanings of the monitoring of drive-related devices (such as external auxiliary contacts, control voltages, cubicle fans, door contacts).

All auxiliary contacts of the external devices, which need to be monitored, are connected in series to the digital input assigned to the "ON lock" function (using the parameter [ON Lock Assignment] LKOS).

If the drive is not running, the drive remains locked in [Freewheel Stop] NST and [ON Lock Warning] LKON is active until the locking event is resolved (i.e. until all monitored contacts connected to the digital input allows the drive to be ready).

If the drive is running and locking is triggered, an error and/or a warning is triggered according to the configuration of [ON Lock Response] LKOR.

Below an example with “ON lock” assigned to a digital input (low level):

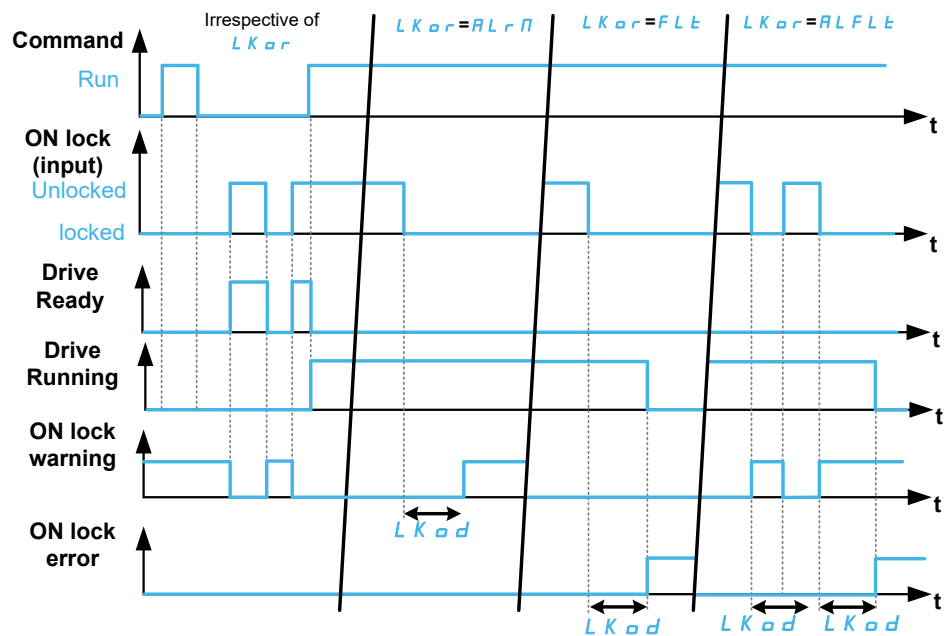

### [ON Lock Assignment] LKOS

On locking of the drive when the assigned digital input (high level) or bit switches to 1. With low level, on locking when the digital input switches to 0.

Setting	Code / Value	Description
[Not Assigned]	NO	Not assigned <b>Factory setting</b>
[DI1]...[DI8]	LI1...LI8	Digital input DI1...DI8 <b>NOTE:</b> DI8 selection can be accessed on drives with a power greater than 22kW.
[DI11]...[DI16]	LI11...LI16	Digital input DI11...DI16 if VW3A3203 Extended I/O module has been inserted



Setting	Code / Value	Description
[DI1 (Low level)]...[DI8 (Low level)]	L1L...L8L	Digital input DI1...DI8 used at low level <b>NOTE:</b> DI8 selection can be accessed on drives with a power greater than 22kW.
[DI11 (Low level)]...[DI16 (Low level)]	L11L...L16L	Digital input DI11...DI16 used at low level if VW3A3203 Extended I/O module has been inserted
[CD00]...[CD15]	CD00...CD15	Bit x digital input ctrl word (e.g. virtual digital input CMD.00...CMD.15). <b>NOTE:</b> CD00...CD10 are only accessible with [Control Mode] CHCF set to [I/O profile] IO.
[C101]...[C115]	C101...C115	Bit x Modbus ctrl word (e.g. Virtual digital input CMD1.01...CMD1.15 with integrated Modbus Serial) <b>NOTE:</b> C101...C110 are only accessible with [Control Mode] CHCF set to [I/O profile] IO.
[C201]...[C215]	C201...C215	Bit x CANopen ctrl word (e.g. Virtual digital input CMD2.01...CMD2.15 with CANopen® fieldbus module) <b>NOTE:</b> C201...C210 are only accessible with [Control Mode] CHCF set to [I/O profile] IO.
[C301]...[C315]	C301...C315	Bit x Com module ctrl word (e.g. Virtual digital input CMD3.01...CMD3.15 with fieldbus module) <b>NOTE:</b> C301...C310 are only accessible with [Control Mode] CHCF set to [I/O profile] IO.
[C501]...[C515]	C501...C515	Bit x Ethernet ctrl word (e.g. Virtual digital input CMD3.01...CMD3.15 with Ethernet embedded) <b>NOTE:</b> This selection can be accessed on ATV340...N4E drives. <b>NOTE:</b> C501...C510 are only accessible with [Control Mode] CHCF set to [I/O profile] IO.

## [ON Lock Response] LKOR

This parameter is used to set the type of ON locking event response.

This parameter can be accessed if [ON Lock Assignment] LKOS is assigned.

Setting ( )	Code / Value	Description
[Warning]	ALRM	Warning: if a locking event is detected while the drive is running, [ON Lock Warning] LKON is triggered after the configured time [ON Lock Time Delay] LKOD. It is advisable to assign a relay or digital output to its indication. <b>NOTE:</b> The warning is cleared as soon as the locking event is resolved. <b>Factory setting</b>
[Error]	FLT	Error: if the locking event is detected while the drive is running, [ON Lock Warning] LKON is triggered after the configured time [ON Lock Time Delay] LKOD.
[Warning Then Error]	ALFLT	Warning then error with time delay: if the locking event is detected while the drive is running, [ON Lock Warning] LKON is triggered and, after the configured time [ON Lock Time Delay] LKOD, [ON Lock Warning] LKON is triggered. <b>NOTE:</b> The warning is cleared as soon as the locking event is resolved.

## [ON Lock Time Delay] LKOD

This parameter can be accessed if [ON Lock Assignment] LKOS is assigned.

Setting ( )	Description
0.0...300.0 s (step: 0.1 s)	setting range <b>Factory setting:</b> 0.0 s

## [Maintenance]

### [Diagnostics] DAU- Menu

#### Access

[Complete settings] → [Maintenance] → [Diagnostics]

#### About This Menu

This menu allows you to make simple test sequences for diagnostics.

#### [Fan Diagnostics] FNT

This starts a test sequence.

#### [HMI LED diagnostics] HLT

This starts a test sequence.

#### [IGBT Diag w motor] IWT

This starts a test sequence with the connected motor (open circuit/short-circuit).

#### [IGBT Diag w/o motor] IWOT

This starts a test sequence without the motor (short-circuit).

## [Customer event 1] CE1– Menu

### Access

[Complete settings] → [Maintenance] → [Customer events] → [Customer event 1]

### About This Menu

This menu allows you to define customized customer events based on the time.

## [Config Warning 1] CCA1

### Configuration of customer warning 1.

Setting	Code / Value	Description
[Not Configured]	NO	Not configured <b>Factory setting</b>
[Counter]	CPT	Counter
[Date and Time]	DT	Date and time

## [Counter limit 1] CCL1

### Configuration counter limit 1.

Setting	Description
0...4294967295 s	Setting range <b>Factory setting:</b> 0 s

## [Counter Source 1] CCS1

### Configuration counter Source 1.

Setting	Code / Value	Description
[Mains/ Control ON]	0	Mains or control supply on
[Mains Supply ON]	1	Mains supply on
[Drive is Running]	2	Drive in running state <b>Factory setting</b>

## [Time counter 1] CC1

### Time counter 1.

Setting	Description
0...4294967295 s	Setting range <b>Factory setting:</b> 0 s

## [Date Time Warn 1] CDT1 ★

This parameter can be accessed with the Display Terminal only.

Setting ( )	Description
hh:mm DD/MM/YYYY	Setting range <b>Factory setting:</b> 00:00 01/01/2000

## [Customer event 2] CE2– to [Customer event 5] CE5– Menus

### Access

[Complete settings] → [Maintenance] → [Customer events] → [Customer event 2] to [Customer event 5]

### About This Menu

Identical to [Customer event 1] CE1– menu , page 516.

## [Config Warning 2] CCA2 to [Config Warning 5] CCA5

*Configuration of customer warning 2 to Configuration of customer warning 5.*

## [Counter limit 2] CCL2 to [Counter limit 5] CCL5

*Configuration counter limit 2 to Configuration counter limit 5.*

## [Counter Source 2] CCS2 to [Counter Source 5] CCS5

*Configuration counter Source 2 to Configuration counter Source 5.*

## [Time counter 2] CC2 to [Time counter 5] CC5

*Time counter 2 to Time counter 5.*

## [Date Time Warn 2] CDT2 to [Date Time Warn 5] CDT5 ★

*Date time warning 2 to Date time warning 5.*

This parameter can be accessed with the Display Terminal only.

## [Customer events] CUEV– Menu

### Access

[Complete settings] → [Maintenance] → [Customer events]

### [Warning Clearing] CAR

*Customer warning clearing.*

Setting (°)	Code / Value	Description
[No Warning Clearing]	NO	No warning clearing <b>Factory setting</b>
[Clear Event 1 Warning]	RA1	Clear event 1 warning
[Clear Event 2 Warning]	RA2	Clear event 2 warning
[Clear Event 3 Warning]	RA3	Clear event 3 warning
[Clear Event 4 Warning]	RA4	Clear event 4 warning
[Clear Event 5 Warning]	RA5	Clear event 5 warning

## [Fan management] FAMA- Menu

### Access

[Complete settings] → [Maintenance] → [Fan management]

### About This Menu

Fan speed and [Fan Operation Time] FPBT are monitored values.

An abnormal low speed or the fan trigger a warning [Fan Feedback Warning] FFDA. As soon as [Fan Operation Time] FPBT reach the predefined value of 45,000 hours, a warning [Fan Counter Warning] FCTA is triggered.

[Fan Operation Time] FPBT counter can be set to 0 by using the [Counter Reset] RPR parameter.

### [Fan mode] FFM

#### Fan mode.

Setting (↺)	Code / Value	Description
[Standard]	STD	The operation of the fan is enabled when the motor is running. According to the drive rating, this could be the only available setting <b>Factory setting</b>
[Always]	RUN	The fan is always activated
[Never]	STP	If the software version is: <ul style="list-style-type: none"> <li>up to V1.5 (excluded), the fan of the drive is disabled.</li> <li>V1.5 or higher, this selection has no effect. The operation of the fan is enabled when the motor is running</li> </ul>
[Economy]	ECO	The fan is activated only if necessary, according to the internal thermal state of the drive

If [Fan mode] FFM is set to [Never] STP, the fan of the drive is disabled.

<b>NOTICE</b>
<p><b>OVERHEATING</b></p> <p>Verify that the ambient temperature does not exceed 40 °C (104 ° F) if the fan is disabled.</p> <p><b>Failure to follow these instructions can result in equipment damage.</b></p>

## [Maintenance] CSMA- Menu

### Access

[Complete settings] → [Maintenance]

### [Counter Reset] RPR

**NOTE:** The list of possible values depends on the product size.

Setting ( )	Code / Value	Description
[No]	NO	No <b>Factory setting</b>
[Reset Run Time]	RTH	Run time reset
[Reset Power On Time]	PTH	Power ON time reset
[Reset Fan Counter]	FTH	Reset fan counter
[Reset Start Count]	NSM	Clear number of motor starts



# [Communication]

## What's in This Chapter

[Communication] COM- ..... 521

## [Communication] COM-

### Introduction



[Communication] COM- menu presents the fieldbus submenus.

### What is in This Chapter?

This chapter contains the following topics inside [Comm parameters] CMP- submenu:

Menu	Description	Related manual
[Modbus SL] MSL- → [Modbus Fieldbus] MD1-	This menu is related to the Modbus serial communication port at the bottom of the control block.  NOTE: [Modbus add Com.C.] AMOC is a parameter similar to [Modbus Address] ADD for Ethernet-IP Modbus TCP fieldbus.	NVE61654
[Modbus SL] MSL- → [Modbus HMI] MD2-	This menu is related to the Modbus serial communication port on the front of the control block. It is used by default for the Display Terminal . The Display Terminal is only compliant with the following settings (factory settings): [Modbus 2 baud rate] TBR2 equal to [19200 bps] 19200, [Term 2 word order] TWO2 equal to [ON] HIGH and [Modbus 2 format] TFO2 equal to [8-E-1] 8E1.	-
[Embd Eth Config] ETE-	This menu is related to the Ethernet Embedded communication.  NOTE: This menu can only be accessed on ATV340●●N4E.	NVE61653
[CANopen] CNO-	This menu is related to the CANopen module (VW3A3608, VW3A3618, VW3A3628).	NVE61655
[DeviceNet] DNC-	This menu is related to the DeviceNet fieldbus module (VW3A3609).	NVE61683
[Profibus] PBC-	This menu is related to the Profibus DP fieldbus module (VW3A3607).	NVE61656
[Profinet] PNC-	This menu is related to the Profinet fieldbus module (VW3A3627).	NVE61678

[Powerlink] EPL-	This menu is related to the POWERLINK fieldbus module (VW3A3619).	NVE61681
[EtherCAT Module] ETC-	This menu is related to the EtherCAT fieldbus module (VW3A3601).	NVE61686

**NOTE:**

- These menus can be accessed if the corresponding option has been inserted and if the firmware of the option module and the drive are compatibles. In addition of the fieldbus manuals, refer to the Instruction Sheet of the option modules (S1A45591) and the installation manual of the drive for more information.
- Access to the communication parameters to carry out searches (example: parameter address and format) and sort operations (NVE61728).
- The drive needs to be restarted to apply the modification of a communication parameters.

# [File management] FMT–

## What's in This Chapter

[Transfer config file] TCF– Menu .....	524
[Factory settings] FCS Menu .....	525
[Firmware update] FWUP– Menu .....	527

## Introduction



[File management] FMT– menu presents the management of drive configuration files.

## [Transfer config file] TCF- Menu

### Access

[File management] → [Transfer config file]

### [Copy To The Device] OPF

This allows to select a previously saved drive configuration from the Graphic Display Terminal memory and transfer it to the drive.

The drive needs to be restarted after a configuration file transfer.

### [Copy From Device] SAF

This allows to save the actual drive configuration into the Graphic Display Terminal memory.

**NOTE:** The Graphic Display Terminal can store up to 16 configuration files.

## [Factory settings] FCS Menu

### Access

[File management] → [Factory settings]

### About This Menu

This function is used to perform a factory setting of the drive or to restore the drive to a selected configuration. The following table shows an example of standard procedure to perform a factory setting or to restore a configuration.

Step	Description
1	To restore the drive to a selected configuration, select the customer parameter set to be restored with [Config. Source] FCSI, else verify [Config. Source] FCSI is set to [Macro Config] INI to perform a factory setting. <b>NOTE:</b> Before selecting the customer parameter set used to restore a configuration, customer parameters must have previously been saved on this set (using [Save Configuration] SCSi).
2	Select with [Parameter group list] FRY the menus to be restored or reset to factory setting. In case a configuration is restored, it is recommended to select [All] ALL.
3	Perform the factory setting or restore the configuration with [Go to Factory Settings] GFS. On the Display Terminal several screens to consider are displayed.

### [Config. Source] FCSI ★

#### Source configuration.

This parameter allows to select the configuration to restore in case of factory setting operation.

**NOTE:** Before selecting with this parameter the customer parameter set used to restore a configuration, customer parameters must have been saved on this set (using [Save Configuration] SCSi).

Setting	Code / Value	Description
[Macro Config]	INI	Factory setting parameter set <b>Factory setting</b>
[Config 1]	CFG1	Customer parameter set 1
[Config 2]	CFG2	Customer parameter set 2
[Config 3]	CFG3	Customer parameter set 3

### [Parameter group list] FRY

Selection of menus to be restored when Go to Factory setting function is activated

Setting	Code / Value	Description
[All]	ALL	All parameters in all menus. <b>NOTE:</b> The following parameter list is not impacted by this selection: [Motor Standard] BFR, [Dual rating] DRT, [Password] PWD and [Webserver] WBS menu.
[Device Configuration]	DRM	All menus, except for [My preferences] MYP- menu, [Communication] COM- menu.

Setting	Code / Value	Description
[Motor param]	MOT	[Motor control] DRC– menu parameters and [Motor Th Current] ITH parameter in [Motor thermal monit] THT– menu.
[Comm. menu]	COM	Restores [Comm. menu] COM– menu. It can only be selected if [Config. Source] FCSI is set to [Macro Config] INI.
[Display config.]	DIS	Restores [Customization] CUS– menu and [Visibility] VIS– menu. It can only be selected if [Config. Source] FCSI is set to [Macro Config] INI.

**Note:** In factory configuration and after a return to "factory settings", [Parameter group list] FRY will be empty.

## [Go to Factory Settings] GFS

This function allows to perform a factory setting or to restore a previously saved configuration.

<b>⚠ WARNING</b>
<p><b>UNANTICIPATED EQUIPMENT OPERATION</b></p> <p>Verify that restoring the factory settings is compatible with the type of wiring used.</p> <p><b>Failure to follow these instructions can result in death, serious injury, or equipment damage.</b></p>

It is only possible to revert to the factory settings if at least one group of parameters has previously been selected ([Parameter group list] FRY displayed above).

## [Save Configuration] SCS1 ★

This parameter allows to save configurations to be restored later.

The active configuration to be saved does not appear for selection. For example, if it is [Config 0] STR0, only [Config 1] STR1, [Config 2] STR2 and [Config 3] STR3 appear. The parameter changes back to [No] NO as soon as the operation is complete.

Setting	Code / Value	Description
[No]	NO	No <b>Factory setting</b>
[Config 0]	STR0	Store customer parameter set 0
[Config 1]	STR1	Store customer parameter set 1
[Config 2]	STR2	Store customer parameter set 2
[Config 3]	STR3	Store customer parameter set 3

## [Firmware update] FWUP- Menu

### Access

[File management] → [Firmware update]

### About This Menu

This function is used to update the software of the drive and can only be used by Schneider Electric Services.

For more information contact your local Schneider Electric Services.

# [My preferences] MYP–

## What's in This Chapter

[LANGUAGE] .....	528
[Password] .....	529
[Parameter access] .....	531
[Customization] .....	533
[Date/Time Settings] .....	536
[Access Level] LAC– Menu .....	537
[Webserver] .....	538
[Functions key mgnt] .....	539
[LCD settings] .....	540
[QR code] .....	541
[Pairing password] .....	542

## Introduction



[My preferences] MYP– menu presents the possible settings for the user-defined HMI and parameter access.

## [LANGUAGE]

### [LANGUAGE] LNG– Menu

#### Access

[My preferences] → [LANGUAGE]

#### About This Menu

This menu allows to select the Display Terminal language.



## [Password]

### [Password] COD– Menu

#### Access

**[My preferences]** → **[Password]**

#### About This Menu

Enables the configuration to be protected with an access code or a password to be entered in order to access a protected configuration:

- The drive is unlocked when the password is set to **[No password defined]** NO or when the correct password has been entered. All menus can be accessed.
- Before protecting the configuration with a password, you must:
  - Define the **[Upload rights]** ULR and **[Download rights]** DLR.
  - Make a careful note of the password and keep it in a place where you are able to find it.

Locking the drive modifies the menu access. If the password is locked:

- **[My menu]** MYMN– menu (in **[Simply Start]** SYS– menu) remains visible if not empty,
- **[Dashboard]** DSH–, **[Diagnostics]** DIA– and **[Display]** MON– menus remain visible with the read-only parameters. Sub-menus with settable parameters are not visible.
- **[Complete settings]** CST– and **[Communication]** COM– menus are not visible,
- **[Transfer config file]** TCF– menu (in **[File management]** FMT– menu) remains visible.
- in the **[My preferences]** MYP– menu, remains visible:
  - **[LANGUAGE]** LNG,
  - **[Password]** COD– menu,
  - **[Display screen type]** MSC– menu (in **[Customization]** CUS– menu),
  - **[Date/Time Settings]** RTC,
  - **[Access Level]** LAC, and
  - **[LCD settings]** CNL– menu.

#### [Password status] PSST

Read only parameter.

Setting	Code / Value	Description
<b>[No password defined]</b>	NO	No password defined <b>Factory setting</b>
<b>[Password is unlocked]</b>	ULK	Password is unlocked
<b>[Password is locked]</b>	LOCK	Password is locked

## [Password] PWD

6-characters password. To lock the drive, define and enter your password. **[Password status]** PSST value switches to **[Password is locked]** LOCK.

To unlock the drive, the password must be entered. Once the correct code has been entered, the drive is unlocked and **[Password status]** PSST value switches to **[Password is unlocked]** ULK. Access is locked again the next time the drive is switched on.

To modify the password, unlock the drive then enter the new password. Entering a new password locks the drive.

To remove the password, the drive must be unlocked and the password 000000 must be entered. **[Password status]** PSST value switches to **[No password defined]** NO. At next switch-on, the drive remains unlocked.

## [Upload rights] ULR

### Upload rights.

Setting 	Code / Value	Description
<b>[Permitted]</b>	ULR0	Commissioning tools or the Display Terminal can save the whole configuration (password, monitoring, configuration) <b>Factory setting</b>
<b>[Not allowed]</b>	ULR1	Commissioning tools or the Display Terminal cannot save the configuration if the drive is not protected by a password or if the in-correct password has been entered

## [Download rights] DLR

### Download rights.

Setting 	Code / Value	Description
<b>[Locked drv]</b>	DLR0	Lock drive: the configuration can be downloaded to the drive only if the drive is protected by a password, which is the same as the password of the configuration to be downloaded
<b>[Unlock. drv]</b>	DLR1	Unlock drive: the configuration can be downloaded to the drive or a configuration can be modified if the drive is unlocked or is not protected by a password <b>Factory setting</b>
<b>[Not allowed]</b>	DLR2	The configuration cannot be downloaded
<b>[Lock/unlock]</b>	DLR3	Combination of <b>[Locked drv]</b> DLR0 and <b>[Unlock. drv]</b> DLR1

## [Parameter access]

### [Restricted channels] PCD- Menu

#### Access

[\[My preferences\]](#) → [\[Parameter access\]](#) → [\[Restricted access\]](#) → [\[Restricted channels\]](#)

#### About This Menu

Following channels can be selected to disable the accessibility to the related parameters.

##### [HMI] CON

Display Terminal.

##### [PC TOOL] PWS

DTM-based commissioning software.

##### [MODBUS] MDB

Embedded Modbus serial.

##### [CANopen] CAN

CANopen fieldbus module.

##### [COM. Module] NET

Fieldbus option module.

### [Restricted Params] PPA- Menu

#### Access

[\[My preferences\]](#) → [\[Parameter access\]](#) → [\[Restricted access\]](#) → [\[Restricted Params\]](#)

#### About This Menu

In these screens, all parameters in the **[Complete settings]** CST- menu can be protected and are displayed for selection, except for the Expert parameters.

Press the **All** key to select all the parameters. Press the **None** key again to deselect all the parameters.

Content of the **[Complete settings]** CST- menu. No selections can be made in this screen if there are no parameters.

## [Visibility] VIS- Menu

### Access

[My preferences] → [Parameter access] → [Visibility]

### About This Menu

Selection to display all parameters or only the active parameters.

## [Parameters] PVIS

#### *Parameters.*

Setting ↻	Code / Value	Description
[Active]	ACT	Only active parameters can be accessed <b>Factory setting</b>
[All]	ALL	All parameters can be accessed

## [Customization]

### [My menu config.] MYC– Menu

#### Access

[My preferences] → [Customization] → [My menu config.]

#### About This Menu

This menu allows to customize the [My menu] MYMN– Menu, page 53.

### [Parameter Selection] UMP

This menu shows the content of [Complete settings] CST– menu and it allows to:

- Select the parameters visible in [My menu] MYMN–, and
- Remove the selected visible parameters from [My menu] MYMN–.

No selection can be made if there are no parameters in the displayed current screen.

### [Display Selection] MDP

This menu shows the content of [Display] MON– menu and it allows to:

- Select the parameters visible in [My menu] MYMN–, and
- Remove the selected visible parameters from [My menu] MYMN–.

No selection can be made if there are no parameters in the displayed current screen.

### [Selected list] UML

This menu displays the parameters selected via [Parameter Selection] UMP and [Display Selection] MDP.

With the Graphic Display Terminal, this menu allows to sort and remove the selected parameters using the function keys (F1, F2 and F3).

**NOTE:** Up to 25 parameters can be selected to be displayed in the customized menu..

### [My menu] MYMN

Used to define the name of the customized menu.

## [Display screen type] MSC– Menu

### Access

[My preferences] → [Customization] → [Display screen type]

### About This Menu

This parameter allows to select the type of display for the default screen.

## [Display value type] MDT

*HMI displayed value type.*

Setting ( )	Code / Value	Description
[Digital]	DEC	Digital values <b>Factory setting</b>
[Bar graph]	BAR	Bar graph
[List]	LIST	List of values
[Vu Meter]	VUMET	Vu meter

## [Parameter Selection] MPC

Customized selection.

This view allows to select the parameters to display on the default screen.

## [Bar Selection] PBS– Menu

### Access

[My preferences] → [Customization] → [Bar Selection]

### About This Menu

This view allows to select the parameters to display on the top line of the Display Terminal screen.

## **[Custom parameters] CYP- Menu**

### **Access**

**[My preferences] → [Customization] → [Custom parameters]**

### **About This Menu**

This menu allows to rename up to 15 parameters.

### **[Parameter Selection] SCP**

This view allows to select up to 15 parameters.

### **[Custom Selection] CPM**

This view allows to set for each selected parameter:

- The name
- The unit if relevant (a custom unit is available)
- A multiplier (1...1000) if relevant
- A divisor (1...1000) if relevant
- An offset (-99.00...99.00) if relevant

## **[Service Message] SER- Menu**

### **Access**

**[My preferences] → [Customization] → [Service Message]**

### **About This Menu**

This menu allows to define a user-defined service message (5 lines, 23 digits per line).

This defined message is displayed in **[Diagnostics] DIA-** → **[Diag. data] DDT-** → **[Service Message] SER-** submenu , page 62.

### **[LINE 1] SML01 to [LINE 5] SML05**

These elements are used to define line-by-line the content of the service message.

## [Date/Time Settings]

### [Date/Time Settings] RTC– Menu

#### Access

[My preferences] → [Date/Time Settings]

#### About This Menu

This view allows to set date and time. This information is used for the time stamping of all logged data.

If a time server is connected over Ethernet and configured in the webserver, date and time data are updated automatically according to the configuration.

Date and time information shall be available (time server available and configured, or Graphic Display Terminal plugged) at drive power up to enable the time stamping of the logged data.

Modifying these settings results in modification of previously logged data value in case of average data based on time.



## [Access Level] LAC- Menu

### Access

[My preferences] → [Access Level]

## [Access Level] LAC

Access level: to define the level of access control.

Setting ( )	Code / Value	Description
[Basic]	BAS	Access to the [Simply Start] SYS-, [Dashboard] DSH-, [Diagnostics] DIA-, and [My preferences] MYP- menus only.
[Standard]	STD	Access to all menus including [Display] MON-, [Complete settings] CST-, [Communication] COM-, [My preferences] MYP- and [File management] FMT-. <b>Factory setting</b>
[Expert]	EPR	Access to all menus and to additional parameters.

## [Webserver]

### [Webserver] WBS– Menu

#### Access

[\[My preferences\]](#) → [\[Webserver\]](#)

#### About This Menu

This menu allows to manage Web services.

This menu can only be accessed on ATV340●●●N4E. For more information refer to the Embedded Ethernet manual.

#### [EnableEmbWeb] EWEE

Enable Web services for the embedded Ethernet adapter.

Setting	Code / Value	Description
[No]	NO	Webserver disabled
[Yes]	YES	Webserver enabled <b>Factory setting</b>

#### [Reset Eth Embd Pwd] RWPE

For embedded ethernet, it resets the user authentication password and the administrator access (ADMIN) webserver password to the default value. Once reset, the default password can be read using Default Password.

Setting ( )	Code / Value	Description
[No]	NO	Password reset is not requested. <b>Factory setting</b>
[Yes]	YES	Password reset is requested. <b>NOTE:</b> The parameter switches to <b>[No]</b> NO when the operation is done.

#### Default Password

8-characters default password.

It shows the ethernet embedded default password used for both webserver connection (Administrator access) and user authentication.

**NOTE:** The user authentication is a feature provided to help prevent unauthorized and malicious connection to the device. The access to the connected device via a software tool provided by Schneider Electric (such as SoMove) is restricted to authenticated users. For more information, refer to the DTM online help.

The default password must not be used. A new password must be defined after a password reset or at the first connection to the drive.

**NOTE:** This default password is also available on the sticker of the drive.

## [Functions key mgnt]

### [Functions key mgnt] FKG– Menu

#### Access

[My preferences] → [Functions key mgnt]

#### About This Menu

This menu allows to assign functions to the Graphic Display Terminal function keys.

### [F1 key assignment] FN1 to [F4 key assignment] FN4

Following possible assignments cannot be accessed in [I/O profile] IO configuration.

Setting	Code / Value	Description
[No]	NO	Not assigned <b>Factory setting</b>
[Jog]	FNJOG	Function key jog affectation
[Preset Speed 1]	FNPS1	Function key preset speed 1 assignment
[Preset Speed 2]	FNPS2	Function key preset speed 2 assignment
[PID Ref Freq 1]	FNPR1	Function key preset PID 1 assignment
[PID Ref Freq 2]	FNPR2	Function key preset PID 2 assignment
[+speed]	FNUSP	Function key faster assignment
[-speed]	FNDSP	Function key slower assignment

## [LCD settings]

### [LCD settings] CNL- Menu

#### Access

[\[My preferences\]](#) → [\[LCD settings\]](#)

#### About This Menu

This menu allows to set the Display Terminal related parameters.

#### [Screen contrast] CRST

##### Screen contrast.

Setting	Description
0...100%	Setting range <b>Factory setting:</b> 50%

#### [Standby] SBY

**NOTE:** Disabling the automatic standby function of the display terminal backlight reduces the backlight service time.

Setting	Description
NO...10 min	Automatic backlight OFF time <b>Factory setting:</b> 10 min

#### [Display Terminal locked] KLCK

Display Terminal key locked. Press **ESC** and **Home** keys to Lock manually & unlock the Display Terminal keys. The **Stop** key remains active when the Display Terminal is locked.

Setting ( )	Description
NO...10 min	Setting range <b>Factory setting:</b> 5 min

## [QR code]

### [QR code] QRC– Menu

#### Access

[\[My preferences\]](#) → [\[QR code\]](#)

#### About This Menu

This menu can only be accessed with the Graphic Display Terminal.

It gives access to 5 QR Codes:

- **[QR code]** QCC: scanning this QR code brings to a landing page on Internet with the information on the Technical product datasheet and a link for Schneider Electric App available for services.
- **[My Link 1]** MYL1- to **[My Link 4]** MYL4-: 4 QR codes customized with the commissioning software. By default, scanning these QR codes brings to the same landing page as **[QR code]** QCC. To customize these QR codes with SoMove, go to “**Device > HMI Personalization > QR codes**”.

**NOTE:** The name “My link x” can also be changed during the customization.

## [Pairing password]

### [Pairing password] PPI

#### Access

[\[My preferences\]](#) → [\[Pairing password\]](#)

#### About This Menu

This function can only be accessed in Expert mode. This function is used to detect whenever an option module has been replaced or the software has been modified in any way. When a pairing password is entered, the parameters of the option modules currently inserted are stored. On every subsequent power-up, these parameters are verified and, in the event of a discrepancy, the drive locks in **[Boards Compatibility]** HCF. Before the drive can be restarted, it is necessary to revert to the original situation or reenter the pairing password.

The following parameters are verified:

- The type of option modules.
- The software version of the drive and the option modules.
- The serial number for the control block boards.

### [Pairing password] PPI

#### *Pairing password.*

Setting	Description
[OFF] OFF...9,999	Setting range Factory setting: OFF

The **[OFF]** OFF value signifies that the pairing password function is inactive.

The **[ON]** ON value signifies that the pairing password function is active and that a password is required to start the drive in the event of a **[Boards Compatibility]** HCF detected error.

As soon as the password has been entered, the drive is unlocked and the code changes to **[ON]** ON.

# Maintenance

## Limitation of Warranty

The warranty does not apply if the product has been opened, except by Schneider Electric services.

## Servicing

### DANGER

#### HAZARD OF ELECTRIC SHOCK, EXPLOSION OR ARC FLASH

Read and understand the instructions in **Safety Information** chapter before performing any procedure in this chapter.

**Failure to follow these instructions will result in death or serious injury.**

The temperature of the products described in this manual may exceed 80 °C (176 °F) during operation.

### WARNING

#### HOT SURFACES

- Ensure that any contact with hot surfaces is avoided.
- Do not allow flammable or heat-sensitive parts in the immediate vicinity of hot surfaces.
- Verify that the product has sufficiently cooled down before handling it.
- Verify that the heat dissipation is sufficient by performing a test run under maximum load conditions.

**Failure to follow these instructions can result in death, serious injury, or equipment damage.**

### WARNING

#### INSUFFICIENT MAINTENANCE

Verify that the maintenance activities described below are performed at the specified intervals.

**Failure to follow these instructions can result in death, serious injury, or equipment damage.**

Adherence to the environmental conditions must be ensured during operation of the device. In addition, during maintenance, verify and, if appropriate, correct all factors that may have an impact on the environmental conditions.

## Spares and Repairs

Serviceable product. Please contact your Customer Care Center on:

[www.se.com/CCC](http://www.se.com/CCC).

## Long Time Storage

If the drive was not connected to mains for an extended period of time, the capacitors must be restored to their full performance before the motor is started.

### **NOTICE**

#### **REDUCED CAPACITOR PERFORMANCE**

- Apply mains voltage to the drive for one hour before starting the motor if the drive has not been connected to mains for the specified periods of time.(1)
- Verify that no Run command can be applied before the period of one hour has elapsed.
- Verify the date of manufacture if the drive is commissioned for the first time and run the specified procedure if the date of manufacture is more than 12 months in the past.

**Failure to follow these instructions can result in equipment damage.**

(1) Period of time:

- 12 months at a maximum storage temperature of +50°C (+122°F)
- 24 months at a maximum storage temperature of +45°C (+113°F)
- 36 months at a maximum storage temperature of +40°C (+104°F)

If the specified procedure cannot be performed without a Run command because of internal mains contactor control, perform this procedure with the power stage enabled, but the motor being at a standstill so that there is no appreciable mains current in the capacitors.

## Fan Replacement

It is possible to order a new fan for the drive maintenance, see the catalog numbers on [www.se.com](http://www.se.com).

## Customer Care Center

For additional support, you can contact our Customer Care Center on:

[www.se.com/CCC](http://www.se.com/CCC).



# Diagnostics and Troubleshooting

## What's in This Part

Warning Codes .....	546
Error Codes .....	548

## Overview

This chapter describes the various types of diagnostics and provides troubleshooting assistance.

### **DANGER**

#### **HAZARD OF ELECTRIC SHOCK, EXPLOSION OR ARC FLASH**

Read and understand the instructions in **Safety Information** chapter before performing any procedure in this chapter.

**Failure to follow these instructions will result in death or serious injury.**

# Warning Codes

## List of Available Warnings Messages

Setting	Code	Description
[No Warning stored]	NOA	No warning stored
[Fallback Frequency]	FRF	Reaction on event: Fallback frequency
[Speed Maintained]	RLS	Reaction on event: Speed maintained
[Type of stop]	STT	Reaction on event: Stop following [Type of stop] STT without triggering an error
[Ref Frequency Warning]	SRA	Frequency reference reached
[PID error Warning]	PBE	PID error warning , page 330
[PID Feedback Warn]	PFA	PID feedback warning , page 322
[PID High Fdbck Warn]	PFAH	PID feedback high threshold reached , page 322
[PID Low Fdbck Warn]	PFAL	PID feedback low threshold reached , page 322
[Limit Switch Reached]	LSA	Limit switch reached , page 357
[Slack Rope Warning]	RSDA	Slack rope warning , page 263
[Dynamic Load Warning]	DLDA	Dynamic load warning , page 264
[AI3 Th Warning]	TP3A	AI3 Thermal warning , page 147
[AI4 Th Warning]	TP4A	AI4 Thermal warning , page 147
[AI5 Th Warning]	TP5A	AI5 Thermal warning , page 147
[AI1 4-20 Warning]	AP1	AI1 4-20 mA loss warning
[AI3 4-20 Warning]	AP3	AI3 4-20 mA loss warning
[AI4 4-20 Warning]	AP4	AI4 4-20 mA loss warning
[AI5 4-20 Warning]	AP5	AI5 4-20 mA loss warning
[Device Therm Warn]	THA	Drive overheating warning
[IGBT Thermal Warning]	TJA	IGBT thermal state warning
[Fan Counter Warning]	FCTA	Fan counter speed warning , page 519
[Fan Feedback Warning]	FFDA	Fan feedback warning , page 519
[BR Thermal Warning]	BOA	Braking resistor thermal warning
[Ext. Error Warning]	EFA	External error warning , page 480
[Undervoltage Warning]	USA	Undervoltage warning
[Preventive UnderV Active]	UPA	Controlled stop threshold is reached
[Mot Freq High Thd]	FTA	Motor frequency high threshold 1 reached , page 333
[Mot Freq Low Thd]	FTAL	Motor frequency low threshold 1 reached , page 333
[Pulse Warn Thd Reached]	FQLA	Pulse warning threshold reached , page 404
[Mot Freq Low Thd 2]	F2AL	Motor frequency low threshold 2 reached , page 333
[High Speed Reached]	FLA	High speed reached warning
[Ref Freq High Thd reached]	RTAH	Reference frequency high threshold reached , page 334
[Ref Freq Low Thd reached]	RTAL	Reference frequency low threshold reached , page 335
[2nd Freq Thd Reached]	F2A	Motor frequency high threshold 2 reached , page 334
[Current Thd Reached]	CTA	Motor current high threshold reached , page 333
[Low Current Reached]	CTAL	Motor current low threshold reached , page 333
[High Torque Warning]	TTHA	High torque threshold reached , page 335

Setting	Code	Description
[Low Torque Warning]	TTLA	Low torque threshold reached , page 335
[Process Undld Warning]	ULA	Process underload warning , page 396
[Process Overload Warning]	OLA	Overload warning , page 399
[Torque Limit Reached]	SSA	Torque limit reached , page 507
[Torque Control Warning]	RTA	Torque control warning , page 368
[Dev Thermal reached]	TAD	Drive thermal threshold reached
[Motor Therm Thd reached]	TSA	Motor thermal threshold reached , page 334
[Mot2 Therm Thd reached]	TS2	Motor 2 thermal threshold reached , page 334
[Mot3 Therm Thd reached]	TS3	Motor 3 thermal threshold reached , page 334
[Mot4 Therm Thd reached]	TS4	Motor 4 thermal threshold reached , page 334
[Power High Threshold]	PTHA	Power high threshold reached
[Power Low Threshold]	PTHL	Power low threshold reached
[Cust Warning 1]	CAS1	Customer warning 1 active , page 516
[Cust Warning 2]	CAS2	Customer warning 2 active , page 517
[Cust Warning 3]	CAS3	Customer warning 3 active
[Cust Warning 4]	CAS4	Customer warning 4 active
[Cust Warning 5]	CAS5	Customer warning 5 active
[Power Cons Warning]	POWD	Power consumption warning
[Slipping warn]	ANA	Slipping warning , page 504
[Load Mvt Warn]	BSA	Load movement warning
[Brake Cont Warn]	BCA	Brake contact warning
[AI1 Th Warning]	TP1A	AI1 Thermal warning , page 147
[Current Reduc Warn]	TLOW	Current reduction warning
[M/S Device Warn]	MSDA	Master/Slave device warning , page 204
[Backlash Warn]	BSQA	Backlash warning , page 267
[Encoder Thermal Warn]	TPEA	Encoder module thermal warning , page 147
[Temp Sens AI1 Warn]	TS1A	Temperature sensor AI1 warning (open circuit)
[Temp Sens AI3 Warn]	TS3A	Temperature sensor AI3 warning (open circuit)
[Temp Sens AI4 Warn]	TS4A	Temperature sensor AI4 warning (open circuit)
[Temp Sens AI5 Warn]	TS5A	Temperature sensor AI5 warning (open circuit)
[DC Bus Ripple Warn]	DCRW	DC Bus Ripple Warning
[Fallback Channel]	AFFL	Automatic fallback behavior activated after a fieldbus communication interruption , page 497
[MonitorCircuit A Warn]	IWA	Monitoring circuit A warning
[MonitorCircuit B Warn]	IWB	Monitoring circuit B warning
[MonitorCircuit C Warn]	IWC	Monitoring circuit C warning
[MonitorCircuit D Warn]	IWD	Monitoring circuit D warning
[ON Lock Warning]	LKON	ON lock warning resulting from an external device not ready.
[Internal Error 22]	INFM	Internal error 22 (Embedded Ethernet)
[Pwr Backup Warn]	RFTA	Power backup mode warning
[Modbus Com Inter.]	SLF1	Modbus communication interruption warning

# Error Codes

## What's in This Chapter

Overview .....	549
[Load slipping] <i>A n F</i> .....	551
[Angle error] <i>A S F</i> .....	551
[Brake Control] <i>b L F</i> .....	552
[Brake Resistor ovid] <i>b o F</i> .....	552
[Brake Feedback] <i>b r F</i> .....	553
[Backlash Error] <i>b S 9 F</i> .....	553
[DB unit sh. circuit] <i>b u F</i> .....	554
[DB unit op. circuit] <i>b u F o</i> .....	554
[Circuit Breaker Error] <i>C b F</i> .....	555
[Incorrect Configuration] <i>C F F</i> .....	555
[Invalid Configuration] <i>C F ,</i> .....	556
[Conf Transfer Error] <i>C F , 2</i> .....	556
[Pre-settings Transfer Error] <i>C F , 3</i> .....	557
[Empty Configuration] <i>C F , 4</i> .....	557
[Fieldbus Com Interrupt] <i>C n F</i> .....	558
[CANopen Com Interrupt] <i>C o F</i> .....	558
[Precharge Capacitor] <i>C r F 1</i> .....	559
[Channel Switch Error] <i>C S F</i> .....	559
[DC Bus Ripple Error] <i>d C r E</i> .....	560
[Dynamic Load Error] <i>d L F</i> .....	560
[Encoder Coupling] <i>E C F</i> .....	561
[EEPROM Control] <i>E E F 1</i> .....	562
[EEPROM Power] <i>E E F 2</i> .....	562
[Encoder] <i>E n F</i> .....	563
[External Error] <i>E P F 1</i> .....	564
[Fieldbus Error] <i>E P F 2</i> .....	564
[Embd Eth Com Interrupt] <i>E t H F</i> .....	565
[Out Contact Closed Error] <i>F C F 1</i> .....	565
[Out Contact Opened Error] <i>F C F 2</i> .....	566
[FDR 1 Error] <i>F d r 1</i> .....	566
[FDR 2 Error] <i>F d r 2</i> .....	567
[Firmware Update Error] <i>F W E r</i> .....	567
[Boards Compatibility] <i>H C F</i> .....	568
[MonitorCircuit A Error] <i>, F A</i> .....	568
[MonitorCircuit B Error] <i>, F b</i> .....	569
[MonitorCircuit C Error] <i>, F C</i> .....	569
[MonitorCircuit D Error] <i>, F d</i> .....	570
[Input Overheating] <i>, H F</i> .....	570
[Internal Link Error] <i>, L F</i> .....	571
[Internal Error 0] <i>, n F 0</i> .....	571
[Internal Error 1] <i>, n F 1</i> .....	572
[Internal Error 2] <i>, n F 2</i> .....	572
[Internal Error 3] <i>, n F 3</i> .....	573
[Internal Error 4] <i>, n F 4</i> .....	573
[Internal Error 6] <i>, n F 6</i> .....	574
[Internal Error 7] <i>, n F 7</i> .....	574
[Internal Error 8] <i>, n F 8</i> .....	575
[Internal Error 9] <i>, n F 9</i> .....	575
[Internal Error 10] <i>, n F A</i> .....	576
[Internal Error 11] <i>, n F b</i> .....	576
[Internal Error 12] <i>, n F C</i> .....	577
[Internal Error 13] <i>, n F d</i> .....	577
[Internal Error 14] <i>, n F E</i> .....	578
[Internal Error 15] <i>, n F F</i> .....	578
[Internal Error 16] <i>, n F G</i> .....	579
[Internal Error 17] <i>, n F H</i> .....	579
[Internal Error 18] <i>, n F I</i> .....	580
[Internal Error 19] <i>, n F J</i> .....	580
[Internal Error 20] <i>, n F K</i> .....	581
[Internal Error 21] <i>, n F L</i> .....	581
[Internal Error 22] <i>, n F M</i> .....	582
[Internal Error 25] <i>, n F P</i> .....	582

[Internal Error 27] <i>i n F r</i> .....	583
[Input Contactor] <i>L C F</i> .....	583
[AI1 4-20mA loss] <i>L F F 1</i> .....	584
[AI3 4-20mA loss] <i>L F F 3</i> .....	584
[AI4 4-20mA loss] <i>L F F 4</i> .....	585
[AI5 4-20mA loss] <i>L F F 5</i> .....	585
[ON Lock Error] <i>L K o n</i> .....	586
[Load Mvt Error] <i>l d C F</i> .....	586
[MultiDrive Link Error] <i>l d L F</i> .....	587
[M/S Device Error] <i>l S d F</i> .....	587
[DC Bus Overvoltage] <i>o b F</i> .....	588
[Overcurrent] <i>o C F</i> .....	588
[Drive Overheating] <i>o H F</i> .....	589
[Process Overload] <i>o L C</i> .....	589
[Motor Overload] <i>o L F</i> .....	590
[Single Output Phase Loss] <i>o P F 1</i> .....	590
[Output Phase Loss] <i>o P F 2</i> .....	591
[Supply Mains Overvoltage] <i>o S F</i> .....	592
[Program Loading Error] <i>P G L F</i> .....	593
[Program Running Error] <i>P G r F</i> .....	593
[Input phase loss] <i>P H F</i> .....	594
[Rotation Angle Monit] <i>r A d F</i> .....	594
[Safety Function Error] <i>S A F F</i> .....	595
[Safety Violation] <i>S A V F</i> .....	595
[Motor short circuit] <i>S C F 1</i> .....	596
[Ground Short Circuit] <i>S C F 3</i> .....	596
[IGBT Short Circuit] <i>S C F 4</i> .....	597
[Motor Short Circuit] <i>S C F 5</i> .....	597
[Safety Config Error] <i>S C F F</i> .....	598
[Modbus Com Interruption] <i>S L F 1</i> .....	598
[PC Com Interruption] <i>S L F 2</i> .....	599
[HMI Com Interruption] <i>S L F 3</i> .....	599
[Safety IO Error] <i>S i o F</i> .....	600
[Motor Overspeed] <i>S o F</i> .....	601
[Encoder Feedback Loss] <i>S P F</i> .....	602
[Security Files Corrupt] <i>S P F C</i> .....	603
[Torque timeout] <i>S r F</i> .....	604
[Torque Limitation Error] <i>S S F</i> .....	604
[Motor Stall Error] <i>S t F</i> .....	605
[AI1 Thermal Sensor Error] <i>t 1 C F</i> .....	606
[AI3 Thermal Sensor Error] <i>t 3 C F</i> .....	607
[AI4 Thermal Sensor Error] <i>t 4 C F</i> .....	608
[AI5 Thermal Sensor Error] <i>t 5 C F</i> .....	609
[Encoder Th Sensor Error] <i>t E C F</i> .....	609
[AI1 Th Level Error] <i>t H 1 F</i> .....	610
[AI3 Th Level Error] <i>t H 3 F</i> .....	610
[AI4 Th Level Error] <i>t H 4 F</i> .....	611
[AI5 Th Level Error] <i>t H 5 F</i> .....	611
[Encoder Th Detected Error] <i>t H E F</i> .....	612
[IGBT Overheating] <i>t J F</i> .....	612
[Drive Overload] <i>t L o F</i> .....	613
[Autotuning Error] <i>t n F</i> .....	613
[Process Underload] <i>u L F</i> .....	614
[Supply Mains UnderV] <i>u S F</i> .....	614

## Overview

### Clearing the Detected Error

This table presents the steps to follow if intervention on the drive system is required:

Step	Action
1	Disconnect all power, including external control power that may be present.
2	Lock all power disconnects in the open position.
3	Wait 15 minutes to allow the DC bus capacitors to discharge (the drive LEDs are not indicators of the absence of DC bus voltage).
4	Measure the voltage of the DC bus between the PA/+ and PC/- terminals to ensure that the voltage is less than 42 Vdc.
5	If the DC bus capacitors do not discharge completely, contact your local Schneider Electric representative. Do not repair or operate the drive.
6	Find and correct the cause of the detected error.
7	Restore power to the drive to confirm that the detected error has been rectified.

After the cause has been removed, the detected error can be cleared by:

- Switching off the drive.
- Using the **[Product restart]** *RP* parameter.
- Using the digital input or the control bit assigned to **[Prod Restart Assign]** *RPA*.
- Using the **[Auto Fault Reset]** *ATR*– function.
- A digital input or control bit set to the **[Fault reset]** *RST*– function.
  - For **[Fault Reset Assign]** *RSF* and **[Extended Fault Reset]** *HRFC* refer to **[Fault reset]** *RST*– Menu.
- Pressing the **STOP/RESET** key on the Display Terminal depending on the setting of **[Stop Key Enable]** *PST*.

## How To Clear the Error Code?

The following table summarizes the possibilities to clear a detected error after the cause has been removed:

How to clear the error code after the cause has been removed	List of the cleared error
<ul style="list-style-type: none"> <li>• Switch off the drive.</li> <li>• Use the <b>[Product restart]</b> <i>RP</i> parameter.</li> <li>• Use the digital input or the control bit assigned to <b>[Prod Restart Assign]</b> <i>RPA</i>.</li> </ul>	All detected error.
<ul style="list-style-type: none"> <li>• As soon as its cause has been removed.</li> </ul>	<i>CFF, CFI, CFI2, CFI3, CFI4, CSF, FWER, HCF, PGLF, PHF, USF</i>
<ul style="list-style-type: none"> <li>• Use the digital input or the control bit assigned to <b>[Fault Reset Assign]</b> <i>RSF</i>.</li> <li>• Pressing the <b>RESET</b> button on the HMI panel</li> </ul>	<i>ANF, ASF, BRF, BSQF, ECF, ENF, SOF, SPF, TNF</i>
<ul style="list-style-type: none"> <li>• Use the digital input or the control bit assigned to <b>[Fault Reset Assign]</b> <i>RSF</i>.</li> <li>• Pressing the <b>RESET</b> button on the HMI panel</li> <li>• Use the <b>[Auto Fault Reset]</b> <i>ATR</i>– function.</li> </ul>	<i>BOF, CNF, COF, DLF, EPF1, EPF2, ETHF, FCF2, FDR1, FDR2, IFA, IFB, IFC, IFD, IHF, INF9, INFB, LCF, LFF1, LFF3, LFF4, LFF5, LKON, MDLF, MSDF, OBF, OHF, OLC, OLF, OPF1, OPF2, OSF, RADF, SCF4, SCF5, SLF1, SLF2, SLF3, SRF, SSF, STF, T1CF, T3CF, T4CF, T5CF, TECF, TH1F, TH3F, TH4F, TH5F, THEF, TJF, TLOF, ULF</i>
<p>If <b>[Extended Fault Reset]</b> <i>HRFC</i> is set to <b>YES</b>:</p> <ul style="list-style-type: none"> <li>• Use the digital input or the control bit assigned to <b>[Fault Reset Assign]</b> <i>RSF</i> ,</li> <li>• Press the <b>STOP/RESET</b> key on the Display Terminal depending on the setting of <b>[Stop Key Enable]</b> <i>PST</i>.</li> </ul>	<i>CRF1, INFD, SCF1</i>

## [Load slipping] $A n F$



### Probable Cause

Not following the ramp. The difference between the output frequency and the speed feedback is not correct.



### Remedy

- Confirm the drive rating according to the application (motor, load, and so on.)
- Verify the motor, gain, and stability parameters.
- Add a braking resistor.
- Verify the mechanical coupling and wiring of the encoder.
- If the torque control function is used and if the encoder is assigned to speed feedback,
  - Set **[Load slip detection]**  $S d d = [No] n o$ .
  - Set both **[Positive deadband]**  $d b P$  and **[Negative deadband]**  $d b n$  to a value less than 10% of the nominal motor frequency.



### Clearing the Error Code

This detected error can be cleared manually with the **[Fault Reset Assign]**  $R S F$  parameter after its cause has been removed.

## [Angle error] $A 5 F$



### Probable Cause

This error is triggered during the phase-shift angle measurement if the motor phase is disconnected or if the motor inductance is too high.



### Remedy

- Verify the motor phases and the maximum current allowed by the drive.



### Clearing the Error Code

This detected error can be cleared manually with the **[Fault Reset Assign]**  $R S F$  parameter after its cause has been removed.

## [Brake Control] $b L F$



### Probable Cause

- Brake release current not reached.
- The torque set point is not reached.
- The fluxing current is not stable.



### Remedy

- Verify the drive/motor connection.
- Verify the motor windings.
- Verify the **[Brk Release Current]**  $i_{br}$  and **[Brake release I Rev]**  $i_{rd}$  settings.



### Clearing the Error Code

This detected error requires a power reset.

## [Brake Resistor ovid] $b o F$



### Probable Cause

The braking resistor is overloaded.



### Remedy

- Wait for the braking resistor to cool down.
- Verify the nominal power of the braking resistor.
- Verify the **[Braking Resistor Power]**  $b_r P$  and **[Braking Resistor Value]**  $b_r V$  parameters.



### Clearing the Error Code

This detected error can be cleared with the **[Auto Fault Reset]**  $ATR$  or manually with the **[Fault Reset Assign]**  $RSF$  parameter after its cause has been removed.



## [Brake Feedback] *b r F*



### Probable Cause

- The status of the brake feedback contact or the status of the brake relay feedback is not correct compared to the brake logic control.
- The brake does not stop the motor quickly enough (detected by measuring the speed on the "Pulse input" input).



### Remedy

- Verify the brake feedback circuit.
- Verify the brake logic control circuit.
- Verify the brake behavior.
- Verify that the setting of **[Brake Release Time] *b r t*** and **[Brake Engage Time] *BET*** take into account the brake response time, **[Brake Fdbk Filter] *F b C***, and **[Brake Rly Fdbk Filter] *F b r i***.



### Clearing the Error Code

This detected error can be cleared manually with the **[Fault Reset Assign] *R S F*** parameter after its cause has been removed.

## [Backlash Error] *b 5 9 F*



### Probable Cause

The torque threshold used for backlash function can not be reached after **[BL Monit Delay] *b 9 t***.



### Remedy

- Verify the settings
- Verify the coupling



### Clearing the Error Code

This detected error can be cleared manually with the **[Fault Reset Assign] *R S F*** parameter after its cause has been removed.

## [DB unit sh. circuit] $b_{UF}$



### Probable Cause

- Short-circuit from braking unit.
- Braking unit not connected. (not applicable for drive system braking unit option).



### Remedy

- Verify the wiring of the braking unit.
- Verify that the braking unit value is not too low.



### Clearing the Error Code

This detected error requires a power reset.

## [DB unit op. circuit] $b_{UF0}$



### Probable Cause

- Open circuit from braking circuit and/or braking resistor.
- Braking resistor not connected/detected.



### Remedy

- Verify the wiring of the braking resistor.
- Verify by measurement that the resistance of the braking resistor is not too high.
- Verify the parameter  $b_{r1}$ .



### Clearing the Error Code

This detected error requires a power reset.

## [Circuit Breaker Error] $L\ b\ F$



### Probable Cause

The DC bus voltage level is not correct compared to the circuit breaker logic control (start or stop pulse) after the configured timeout **[Mains V. time out]**  $L\ L\ E$ .



### Remedy

- Verify the circuit breaker logic control (pulse time for start and stop).
- Verify the mechanical state of the circuit breaker.



### Clearing the Error Code

This detected error requires a power reset.

## [Incorrect Configuration] $L\ F\ F$



### Probable Cause

- Option module changed or removed.
- Control board replaced by a control board configured on a drive with a different rating.
- The current configuration is inconsistent.



### Remedy

- Verify that there is no detected error on the option module.
- In the event of the control block being changed deliberately, see the remarks below.
- Return to factory settings or retrieve the backup configuration if it is valid.



### Clearing the Error Code

This detected error is cleared as soon as its cause has been removed.

## [Invalid Configuration] [ F , ]



### Probable Cause

Invalid configuration.

The configuration loaded in the drive via the commissioning tool or fieldbus is inconsistent.



### Remedy

- Verify the loaded configuration.
- Load a valid configuration.



### Clearing the Error Code

This detected error is cleared as soon as its cause has been removed.

## [Conf Transfer Error] [ F , 2 ]



### Probable Cause

- The configuration transfer to the drive was not successful or interrupted.
- The configuration loaded is not compatible with the drive.



### Remedy

- Verify the configuration loaded previously.
- Load a compatible configuration.
- Use PC software commissioning tool to transfer a compatible configuration
- Perform a factory setting



### Clearing the Error Code

This detected error is cleared as soon as its cause has been removed.

## [Pre-settings Transfer Error] [ F , 3 ]



### Probable Cause

The configuration transfer to the drive was not successful or interrupted.



### Remedy

Contact your local Schneider Electric representative.



### Clearing the Error Code

This detected error is cleared as soon as its cause has been removed.

## [Empty Configuration] [ F , 4 ]



### Probable Cause

The selected configuration for the **[Multimotors config] P P C** - function has not been created previously.



### Remedy

- Verify the configurations saved.
- Switch to a compatible configuration.



### Clearing the Error Code

This detected error is cleared as soon as its cause has been removed.

## [Fieldbus Com Interrupt] $\square \square F$



### Probable Cause

Communication interruption on fieldbus module.

This error is triggered when the communication between the fieldbus module and the master (PLC) is interrupted.



### Remedy

- Verify the environment (electromagnetic compatibility).
- Verify the wiring.
- Verify the timeout.
- Replace the option module.
- Contact your local Schneider Electric representative.



### Clearing the Error Code

This detected error can be cleared with the **[Auto Fault Reset]**  $ATR$  or manually with the **[Fault Reset Assign]**  $RSF$  parameter after its cause has been removed.

## [CANopen Com Interrupt] $\square \square F$



### Probable Cause

Communication interruption on the CANopen® fieldbus.



### Remedy

- Verify the communication fieldbus.
- Verify the timeout.
- Refer to the CANopen® manual (NVE61655), page 16.



### Clearing the Error Code

This detected error can be cleared with the **[Auto Fault Reset]**  $ATR$  or manually with the **[Fault Reset Assign]**  $RSF$  parameter after its cause has been removed.

## [Precharge Capacitor] $C r F I$



### Probable Cause

- Charging circuit control detected error or charging resistor damaged.
- Supply mains too low.



### Remedy

- Turn off the drive and then turn on again.
- Verify the internal connections.
- Verify the voltage and the parameters of **[Undervoltage handling]**  $u 5 b$ .
- Contact your local Schneider Electric representative.



### Clearing the Error Code

This detected error can be cleared manually with the **[Extended Fault Reset]**  $HRFC$  parameter after the cause has been removed.

## [Channel Switch Error] $C 5 F$



### Probable Cause

Switch to an invalid channel.



### Remedy

Verify the function parameters.



### Clearing the Error Code

This detected error is cleared as soon as its cause has been removed.

## [DC Bus Ripple Error] $d C r E$



### Probable Cause

Persistent ripple observed on the DC bus or DC bus capacitors damaged.



### Remedy

- Turn off the drive and then turn on again.
- Verify correct behavior of the input filter.
- Verify the mains wirings.
- Verify the internal connections.
- Contact your local Schneider Electric representative.



### Clearing the Error Code

This detected error requires a power reset.

## [Dynamic Load Error] $d L F$



### Probable Cause

Load variation out of range.



### Remedy

Verify for a mechanical cause of load instability.



### Clearing the Error Code

This detected error can be cleared with the **[Auto Fault Reset]**  $ATR$  or manually with the **[Fault Reset Assign]**  $RSF$  parameter after its cause has been removed.



## [Encoder Coupling] E C F



### Probable Cause

The mechanical coupling of the encoder is broken.

The detection is active when **[Encoder Coupling Monit] E C C** parameter is set to **[Yes] Y E 5**.

It triggers the error when the speed feedback is 0 and the drive is in torque or current limitation.

The limits for speed feedback are:

- 5 Hz for minimum
- 10% of **[Nominal Motor Freq] F r 5** for maximum
- Verify the setting of **[Encoder Coupling Monit] E C C** parameter.
- Verify the setting of **[Encoder check time] E C E** parameter.

The monitoring is not compatible with torque or current limitation functions.



### Remedy

Verify the mechanical coupling of the encoder.



### Clearing the Error Code

This detected error can be cleared manually with the **[Fault Reset Assign] R S F** parameter after its cause has been removed.

## [EEPROM Control] E E F I



### Probable Cause

An error of the internal memory of the control block has been detected.



### Remedy

- Verify the environment (electromagnetic compatibility).
- Switch off the product.
- Return to factory settings.
- Contact your local Schneider Electric representative.



### Clearing the Error Code

This detected error requires a power reset.

## [EEPROM Power] E E F 2



### Probable Cause

An error of the internal memory of the power board has been detected.



### Remedy

- Verify the environment (electromagnetic compatibility).
- Switch off the product.
- Return to factory settings.
- Contact your local Schneider Electric representative.



### Clearing the Error Code

This detected error requires a power reset.

## [Encoder] $E_n F$



### Probable Cause

Encoder feedback error.

The difference between the measured and estimated speed is greater than 4% of **[Nominal Motor Freq]**  $F_r 5$  or **[Sync Nominal Freq]**  $F_r 5 5$ .



### Remedy

- Verify the configuration parameters for the encoder used.
- Verify the mechanical and electrical operation of the encoder.
- Verify the consistency between the encoder signals and the direction of rotation of the motor.
- If necessary, reverse the direction of rotation of the motor (**[Output Ph rotation]**  $P H_r$  parameter)
- Verify the encoder module.
- Verify the encoder type and supply voltage.



### Clearing the Error Code

This detected error can be cleared manually with the **[Fault Reset Assign]**  $R S F$  parameter after its cause has been removed.

## [External Error] *E P F 1*



### Probable Cause

- Event triggered by an external device, depending on user.
- An external error has been triggered via Embedded Ethernet.
- The error is caused by an external circuit.
- Ethernet configuration file is corrupted.



### Remedy

- Remove the cause of the external error.
- Perform a factory setting of the Ethernet configuration or modify the **IP Mode**.



### Clearing the Error Code

This detected error can be cleared with the **[Auto Fault Reset]** *ATR* or manually with the **[Fault Reset Assign]** *RSF* parameter after its cause has been removed.

## [Fieldbus Error] *E P F 2*



### Probable Cause

Event triggered by an external device, depending on user.



### Remedy

Remove the cause of the external error.



### Clearing the Error Code

This detected error can be cleared with the **[Auto Fault Reset]** *ATR* or manually with the **[Fault Reset Assign]** *RSF* parameter after its cause has been removed.

## [Embd Eth Com Interrupt] *E L H F*



### Probable Cause

Communication interruption on the Ethernet IP ModbusTCP bus.



### Remedy

- Verify the communication bus.
- Refer to the Ethernet manual (NVE61653), page 16.



### Clearing the Error Code

This detected error can be cleared with the **[Auto Fault Reset]** *ATR* or manually with the **[Fault Reset Assign]** *RSE* parameter after its cause has been removed.

## [Out Contact Closed Error] *F C F I*



### Probable Cause

The output contactor remains closed although the opening conditions have been met.



### Remedy

- Verify the output contactor and its wiring.
- Verify the contactor feedback wiring.



### Clearing the Error Code

This detected error requires a power reset.

## [Out Contact Opened Error] *F C F 2*



### Probable Cause

The output contactor remains opened although the closing conditions have been met.



### Remedy

- Verify the output contactor and its wiring.
- Verify the contactor feedback wiring.



### Clearing the Error Code

This detected error can be cleared with the **[Auto Fault Reset]** *ATR* or manually with the **[Fault Reset Assign]** *RSF* parameter after its cause has been removed.

## [FDR 1 Error] *F d r 1*



### Probable Cause

- Embedded Ethernet FDR error
- Communication interruption between the drive and the PLC
- Configuration file incompatible, empty or invalid
- Drive rating not consistent with the configuration file



### Remedy

- Verify the drive and PLC connection
- Verify the communication workload
- Restart the transfer of configuration file from drive to PLC



### Clearing the Error Code

This detected error can be cleared with the **[Auto Fault Reset]** *ATR* or manually with the **[Fault Reset Assign]** *RSF* parameter after its cause has been removed.

## [FDR 2 Error] *F d r 2*



### Probable Cause

- Ethernet fieldbus module FDR error
- Communication interruption between the drive and the PLC
- Configuration file incompatible, empty or corrupted
- Drive rating not consistent with the configuration file



### Remedy

- Verify the drive and PLC connection
- Verify the communication workload
- Restart the transfer of configuration file from drive to PLC



### Clearing the Error Code

This detected error can be cleared with the **[Auto Fault Reset]** *ATR* or manually with the **[Fault Reset Assign]** *RSE* parameter after its cause has been removed.

## [Firmware Update Error] *F W E r*



### Probable Cause

Firmware update function has detected an error.



### Remedy

- Contact your local Schneider Electric representative.



### Clearing the Error Code

This detected error is cleared as soon as its cause has been removed.

## [Boards Compatibility] H C F



### Probable Cause

Hardware configuration error.

The **[Pairing password] P P** , parameter has been enabled and an option module has been changed.



### Remedy

- Refit the original option module.
- Confirm the configuration by entering the **[Pairing password] P P** , if the module was changed deliberately.



### Clearing the Error Code

This detected error is cleared as soon as its cause has been removed.

## [MonitorCircuit A Error] , F R



### Probable Cause

The digital input assigned to **[MonitorCircuit A Assign] , F R R** is active for longer than **[MonitorCircuit A Delay] , F d R**.



### Remedy

- Verify the connected device and its wiring.
- Verify the **[MonitorCircuit A Assign] , F R R** parameter assignment.



### Clearing the Error Code

This detected error can be cleared with the **[Auto Fault Reset] ATR** or manually with the **[Fault Reset Assign] RSF** parameter after its cause has been removed.



## [MonitorCircuit B Error] , F b



### Probable Cause

The digital input assigned to **[MonitorCircuit B Assign]** , F R b is active for longer than **[MonitorCircuit B Delay]** , F d b .



### Remedy

- Verify the connected device and its wiring.
- Verify the **[MonitorCircuit B Assign]** , F R b parameter assignment.



### Clearing the Error Code

This detected error can be cleared with the **[Auto Fault Reset]** ATR or manually with the **[Fault Reset Assign]** RSE parameter after its cause has been removed.

## [MonitorCircuit C Error] , F c



### Probable Cause

The digital input assigned to **[MonitorCircuit C Assign]** , F R c is active for longer than **[MonitorCircuit C Delay]** , F d c .



### Remedy

- Verify the connected device and its wiring.
- Verify the **[MonitorCircuit C Assign]** , F R c parameter assignment.



### Clearing the Error Code

This detected error can be cleared with the **[Auto Fault Reset]** ATR or manually with the **[Fault Reset Assign]** RSE parameter after its cause has been removed.

## [MonitorCircuit D Error] , F d



### Probable Cause

The digital input assigned to **[MonitorCircuit D Assign]** , F R d is active for longer than **[MonitorCircuit D Delay]** , F d d.



### Remedy

- Verify the connected device and its wiring.
- Verify the **[MonitorCircuit D Assign]** , F R d parameter assignment.



### Clearing the Error Code

This detected error can be cleared with the **[Auto Fault Reset]** ATR or manually with the **[Fault Reset Assign]** RSF parameter after its cause has been removed.

## [Input Overheating] , H F



### Probable Cause

The AFE brick temperature is too high.



### Remedy

Verify the drive ventilation and the ambient temperature. Wait for the drive to cool down before restarting.



### Clearing the Error Code

This detected error can be cleared with the **[Auto Fault Reset]** ATR or manually with the **[Fault Reset Assign]** RSF parameter after its cause has been removed.

## [Internal Link Error] *ILF*



### Probable Cause

Communication interruption between option module and the drive.



### Remedy

- Verify the environment (electromagnetic compatibility).
- Verify the connections.
- Replace the option module.
- Contact your local Schneider Electric representative.



### Clearing the Error Code

This detected error requires a power reset.

## [Internal Error 0] *INF0*



### Probable Cause

- Communication interruption between microprocessors of the control board.
- The power board rating is not valid.



### Remedy

Contact your local Schneider Electric representative.



### Clearing the Error Code

This detected error requires a power reset.

## [Internal Error 1] *INF 1*



### Probable Cause

The power board rating is not valid.



### Remedy

Contact your local Schneider Electric representative.



### Clearing the Error Code

This detected error requires a power reset.

## [Internal Error 2] *INF 2*



### Probable Cause

The power board is incompatible with the control block software.



### Remedy

Contact your local Schneider Electric representative.



### Clearing the Error Code

This detected error requires a power reset.

## [Internal Error 3] *INF3*



### Probable Cause

Internal communication detected error.



### Remedy

- Verify the wiring on drive control terminals (internal 10V supply for analog inputs overloaded).
- Contact your local Schneider Electric representative.



### Clearing the Error Code

This detected error requires a power reset.

## [Internal Error 4] *INF4*



### Probable Cause

Internal data inconsistent.



### Remedy

Contact your local Schneider Electric representative.



### Clearing the Error Code

This detected error requires a power reset.

## [Internal Error 6] *INF 6*



### Probable Cause

- The option module installed in the drive is not recognized.
- The removable control terminal modules (if existing) are not present or not recognized.
- The embedded Ethernet adapter is not recognized.



### Remedy

- Verify the catalog number and compatibility of the option module.
- Plug the removable control terminal modules after the drive has been switched off.
- Contact your local Schneider Electric representative.



### Clearing the Error Code

This detected error requires a power reset.

## [Internal Error 7] *INF 7*



### Probable Cause

Communication interruption with CPLD component of Control board.



### Remedy

Contact your local Schneider Electric representative.



### Clearing the Error Code

This detected error requires a power reset.

## [Internal Error 8] *INF8*



### Probable Cause

The internal power switching supply is not correct.



### Remedy

Contact your local Schneider Electric representative.



### Clearing the Error Code

This detected error requires a power reset.

## [Internal Error 9] *INF9*



### Probable Cause

An error on the current circuit measurement has been detected.



### Remedy

Contact your local Schneider Electric representative.



### Clearing the Error Code

This detected error can be cleared with the **[Auto Fault Reset]** *ATR* or manually with the **[Fault Reset Assign]** *RSF* parameter after its cause has been removed.

## [Internal Error 10] *INFR*



### Probable Cause

The input stage is not operating correctly.



### Remedy

Contact your local Schneider Electric representative.



### Clearing the Error Code

This detected error requires a power reset.

## [Internal Error 11] *INFB*



### Probable Cause

The internal drive thermal sensor is not operating correctly.



### Remedy

Contact your local Schneider Electric representative.



### Clearing the Error Code

This detected error can be cleared with the **[Auto Fault Reset]** *ATR* or manually with the **[Fault Reset Assign]** *RSF* parameter after its cause has been removed.



## [Internal Error 12] *INF C*



### Probable Cause

Internal current supply error.



### Remedy

Contact your local Schneider Electric representative.



### Clearing the Error Code

This detected error requires a power reset.

## [Internal Error 13] *INF d*



### Probable Cause

Differential current deviation.



### Remedy

Contact your local Schneider Electric representative.



### Clearing the Error Code

This detected error can be cleared manually with the **[Extended Fault Reset]** *HRFC* parameter after the cause has been removed.

## [Internal Error 14] *INFE*



### Probable Cause

Internal microprocessor detected error.



### Remedy

- Verify that the error code can be cleared.
- Contact your local Schneider Electric representative.



### Clearing the Error Code

This detected error requires a power reset.

## [Internal Error 15] *INFF*



### Probable Cause

Serial memory flash format error.



### Remedy

Contact your local Schneider Electric representative.



### Clearing the Error Code

This detected error requires a power reset.

## [Internal Error 16] *INF G*



### Probable Cause

Communication interruption or internal error of output relays option module



### Remedy

- Verify that the option module is correctly connected to the slot
- Replace the option module.
- Contact your local Schneider Electric representative.



### Clearing the Error Code

This detected error requires a power reset.

## [Internal Error 17] *INF H*



### Probable Cause

Communication interruption with the Extension module of digital & analog I/O or internal error of the Extension module of digital & analog I/O.



### Remedy

- Verify that the option module is correctly connected to the slot
- Replace the option module.
- Contact your local Schneider Electric representative.



### Clearing the Error Code

This detected error requires a power reset.

## [Internal Error 18] *INF I*



### Probable Cause

Safety Module Internal Error

- Communication interruption with Safety function module.
- Internal error of the Safety function module.



### Remedy

- Verify the Safety Module errors for additional information.
- Verify that the option module is correctly inserted into the slot.
- Replace the option module.
- Contact your local Schneider Electric representative.



### Clearing the Error Code

This detected error requires a power reset.

## [Internal Error 19] *INF J*



### Probable Cause

An error on the encoder module has been detected.



### Remedy

- Verify if the encoder option module is connected correctly to the slot.
- Verify the compatibility of the encoder.
- Contact your local Schneider Electric representative.



### Clearing the Error Code

This detected error requires a power reset.

## [Internal Error 20] *INFK*



### Probable Cause

Option module interface board error.



### Remedy

Contact your local Schneider Electric representative.



### Clearing the Error Code

This detected error requires a power reset.

## [Internal Error 21] *INFL*



### Probable Cause

Internal Real Time Clock error. It could be a communication error between the keypad and the drive or a clock oscillator start error.



### Remedy

Contact your local Schneider Electric representative.



### Clearing the Error Code

This detected error requires a power reset.

## [Internal Error 22] *inFP*



### Probable Cause

An error on the embedded Ethernet adapter has been detected.



### Remedy

Verify the connection to the Ethernet port.  
Contact your local Schneider Electric representative.



### Clearing the Error Code

This detected error requires a power reset.

## [Internal Error 25] *inFP*



### Probable Cause

Incompatibility between Control Board hardware version and firmware version.



### Remedy

- Update the firmware package.
- Contact your local Schneider Electric representative.



### Clearing the Error Code

This detected error requires a power reset.

## [Internal Error 27] *INFR*



### Probable Cause

Diagnostics in CPLD have detected an error.



### Remedy

Contact your local Schneider Electric representative.



### Clearing the Error Code

This detected error requires a power reset.

## [Input Contactor] *LCF*



### Probable Cause

The drive is not switched on even though **[Mains V. time out]** *LCt* timeout has elapsed.



### Remedy

- Verify the input contactor and its wiring.
- Verify the **[Mains V. time out]** *LCt* timeout.
- Verify the supply mains/contactor/drive wiring.



### Clearing the Error Code

This detected error can be cleared with the **[Auto Fault Reset]** *ATR* or manually with the **[Fault Reset Assign]** *RSF* parameter after its cause has been removed.

## [AI1 4-20mA loss] L F F I



### Probable Cause

Loss of the 4-20 mA on analog input AI1.

This error is triggered when the measured current is below 2 mA.



### Remedy

- Verify the connection on the analog inputs.
- Verify the setting of **[AI1 4-20mA loss] L F L I** parameter.



### Clearing the Error Code

This detected error can be cleared with the **[Auto Fault Reset] ATR** or manually with the **[Fault Reset Assign] RSF** parameter after its cause has been removed.

## [AI3 4-20mA loss] L F F 3



### Probable Cause

Loss of the 4-20 mA on analog input AI3.

This error is triggered when the measured current is below 2 mA.



### Remedy

- Verify the connection on the analog inputs.
- Verify the setting of **[AI3 4-20mA loss] L F L 3** parameter.



### Clearing the Error Code

This detected error can be cleared with the **[Auto Fault Reset] ATR** or manually with the **[Fault Reset Assign] RSF** parameter after its cause has been removed.



## [AI4 4-20mA loss] L F F 4



### Probable Cause

Loss of the 4-20 mA on analog input AI4.

This error is triggered when the measured current is below 2mA.



### Remedy

- Verify the connection on the analog inputs.
- Verify the setting of **[AI4 4-20mA loss] L F L 4** parameter.



### Clearing the Error Code

This detected error can be cleared with the **[Auto Fault Reset] ATR** or manually with the **[Fault Reset Assign] RSE** parameter after its cause has been removed.

## [AI5 4-20mA loss] L F F 5



### Probable Cause

Loss of the 4-20 mA on analog input AI5.

This error is triggered when the measured current is below 2 mA.



### Remedy

- Verify the connection on the analog inputs.
- Verify the setting of **[AI5 4-20mA loss] L F L 5** parameter.



### Clearing the Error Code

This detected error can be cleared with the **[Auto Fault Reset] ATR** or manually with the **[Fault Reset Assign] RSE** parameter after its cause has been removed.

## [ON Lock Error] L K □ □



### Probable Cause

External device not ready.



### Remedy

Verify external device assigned to ON lock input.



### Clearing the Error Code

This detected error can be cleared with the **[Auto Fault Reset]** *ATR* or manually with the **[Fault Reset Assign]** *RSF* parameter after its cause has been removed.

## [Load Mvt Error] □ □ □ F



### Probable Cause

Load movement for which no command has been given.



### Remedy

Verify the brake command circuit. Verify the brake.



### Clearing the Error Code

This detected error requires a power reset.

## [MultiDrive Link Error] $\Pi d L F$



### Probable Cause

- The communication has been interrupted while running.
- The function has detected an inconsistency in the system configuration.



### Remedy

- Check the communication network.
- Check the configuration of the multi-drive link function.



### Clearing the Error Code

This detected error can be cleared with the **[Auto Fault Reset]**  $ATR$  or manually with the **[Fault Reset Assign]**  $RSE$  parameter after its cause has been removed.

## [M/S Device Error] $\Pi S d F$



### Probable Cause

- For a master, one or more slaves are not present or not ready.
- For a slave, the master is not present.



### Remedy

- Verify the drive status.
- Verify the settings of the master/slave architecture.



### Clearing the Error Code

This detected error can be cleared with the **[Auto Fault Reset]**  $ATR$  or manually with the **[Fault Reset Assign]**  $RSE$  parameter after its cause has been removed.

## [DC Bus Overvoltage] $\square b F$



### Probable Cause

- Deceleration time too short or driving load too high.
- Supply mains voltage too high.



### Remedy

- Increase the deceleration time.
- Configure the **[Dec ramp adapt.]**  $b r R$  function if it is compatible with the application.
- Verify the supply mains voltage.



### Clearing the Error Code

This detected error can be cleared with the **[Auto Fault Reset]**  $ATR$  or manually with the **[Fault Reset Assign]**  $RSF$  parameter after its cause has been removed.

## [Overcurrent] $\square C F$



### Probable Cause

- Parameters in the **[Motor data]**  $\Pi \square R$  - menu are not correct.
- Inertia or load too high.
- Mechanical locking.



### Remedy

- Verify the motor parameters.
- Verify the size of the motor/drive/load.
- Verify the state of the mechanism.
- Decrease **[Current limitation]**  $C L r$ .
- Increase the switching frequency.



### Clearing the Error Code

This detected error requires a power reset.

## [Drive Overheating] □ H F



### Probable Cause

Drive temperature too high.



### Remedy

Verify the motor load, the drive ventilation, and the ambient temperature. Wait for the drive to cool down before restarting.



### Clearing the Error Code

This detected error can be cleared with the **[Auto Fault Reset]** [ATR](#) or manually with the **[Fault Reset Assign]** [RSF](#) parameter after its cause has been removed.

## [Process Overload] □ L C



### Probable Cause

Process overload.



### Remedy

- Verify and remove the cause of the overload.
- Verify the parameters of the **[Process overload]** □ L d - function.



### Clearing the Error Code

This detected error can be cleared with the **[Auto Fault Reset]** [ATR](#) or manually with the **[Fault Reset Assign]** [RSF](#) parameter after its cause has been removed.

## [Motor Overload] $\square$ L F



### Probable Cause

Triggered by excessive motor current.



### Remedy

- Verify the setting of the motor thermal monitoring
- Verify the motor load. Wait for the motor to cool down before restarting
- Verify the setting of the following parameters:
  - **[Motor Th Current]**  $\text{r L H}$
  - **[Motor Thermal Mode]**  $\text{L H L}$
  - **[Motor Therm Thd]**  $\text{L L d}$
  - **[MotorTemp ErrorResp]**  $\square$  L L



### Clearing the Error Code

This detected error can be cleared with the **[Auto Fault Reset]**  $\text{ATR}$  or manually with the **[Fault Reset Assign]**  $\text{RSF}$  parameter after its cause has been removed.

## [Single Output Phase Loss] $\square$ P F I



### Probable Cause

Loss of one phase at drive output.



### Remedy

Verify the wiring from the drive to the motor.



### Clearing the Error Code

This detected error can be cleared with the **[Auto Fault Reset]**  $\text{ATR}$  or manually with the **[Fault Reset Assign]**  $\text{RSF}$  parameter after its cause has been removed.

## [Output Phase Loss] $\square P F \varrho$



### Probable Cause

- Motor not connected or motor power too low.
- Output contactor opened.
- Instantaneous instability in the motor current.



### Remedy

- Verify the wiring from the drive to the motor.
- If an output contactor is being used, set **[OutPhaseLoss Assign]** OPL to **[No Error Triggered]** OAC.
- If the drive is connected to a low-power motor or not connected to a motor: In factory settings mode, motor phase loss detection is active **[Output Phase Loss]  $\square P L = [OPF Error Triggered] \varphi E 5$** . Deactivate motor phase loss detection **[Output Phase Loss]  $\square P L = [Function Inactive] n \sigma$** .
- Verify and optimize the following parameters: **[IR compensation]  $\mu F r$** , **[Nom Motor Voltage]  $\mu n 5$**  and **[Rated mot. current]  $n C r$**  and perform **[Autotuning]  $t \mu n$** .



### Clearing the Error Code

This detected error can be cleared with the **[Auto Fault Reset]  $A T R$**  or manually with the **[Fault Reset Assign]  $R S F$**  parameter after its cause has been removed.

## [Supply Mains Overvoltage] $\square$ 5 F



### Probable Cause

- Supply mains voltage too high.
- Disturbed supply mains.



### Remedy

Verify the supply mains voltage.



### Clearing the Error Code

This detected error can be cleared with the **[Auto Fault Reset]**  $ATR$  or manually with the **[Fault Reset Assign]**  $RSF$  parameter after its cause has been removed.



## [Program Loading Error] P G L F



### Probable Cause

Verify that the error code can be cleared.



### Remedy

Contact your local Schneider Electric representative.



### Clearing the Error Code

This detected error is cleared as soon as its cause has been removed.

## [Program Running Error] P G r F



### Probable Cause

Verify that the error code can be cleared.



### Remedy

Contact your local Schneider Electric representative.



### Clearing the Error Code

This detected error requires a power reset.

## [Input phase loss] P H F



### Probable Cause

- Drive incorrectly supplied or a tripped fused.
- One phase is unavailable.
- 3-phase Drive used on a single-phase supply mains.
- Unbalanced load.



### Remedy

- Verify the power connection and the fuses.
- Use a 3-phase supply mains.
- Disable the detected error by **[Input phase loss]**  $i P L = [No]$  if single phase supply mains or DC bus supply is used.



### Clearing the Error Code

This detected error is cleared as soon as its cause has been removed.

## [Rotation Angle Monit] r R d F



### Probable Cause

The monitoring of the rotation angle has detected a too high deviation.



### Remedy

- Check for mechanical problems in the system.
- Verify the settings of the monitoring function.



### Clearing the Error Code

This detected error can be cleared with the **[Auto Fault Reset]**  $ATR$  or manually with the **[Fault Reset Assign]**  $RSF$  parameter after its cause has been removed.

## [Safety Function Error] *S A F F*



### Probable Cause

- Debounce time exceeded.
- Internal hardware error.
- STOA and STOB have a different status (high/low) for more than 1 second.



### Remedy

- Verify the wiring of the digital inputs STOA and STOB.
- Contact your local Schneider Electric representative.



### Clearing the Error Code

This detected error requires a power reset.

## [Safety Violation] *S A V F*



### Probable Cause

- Safety Module Violation Error.
- Safety Module has detected a violation of defined limits.



### Remedy

- Verify the Safety Module errors for additional information.
- Contact your local Schneider Electric representative.



### Clearing the Error Code

This detected error requires a power reset.

## [Motor short circuit] 5 C F 1



### Probable Cause

Short-circuit or grounding at the drive output.



### Remedy

- Verify the cables connecting the drive to the motor, and the motor insulation.
- Adjust the switching frequency.
- Connect chokes in series with the motor.
- Verify the adjustment of speed loop and brake.
- Increase the [Time to restart]  $t_{tr}$



### Clearing the Error Code

This detected error can be cleared manually with the [Extended Fault Reset]  $HRFC$  parameter after the cause has been removed.

## [Ground Short Circuit] 5 C F 3



### Probable Cause

Significant ground leakage current at the drive output if several motors are connected in parallel.



### Remedy

- Verify the cables connecting the drive to the motor, and the motor insulation.
- Adjust the switching frequency.
- Connect chokes in series with the motor.
- If you have long cables, verify the setting of [Ground Fault Activation]  $G_{rFL}$ .



### Clearing the Error Code

This detected error requires a power reset.

## [IGBT Short Circuit] 5 C F 4



### Probable Cause

Power component detected error.

At product power-on, the IGBTs are tested for short circuit. Thereby an error (short circuit or interruption) has been detected on at least one IGBT. The time to check each transistor is between 1 and 10  $\mu$ s.



### Remedy

Verify the setting of **[Output Short Circuit Test] 5 E r E** parameter.

Contact your local Schneider Electric representative.



### Clearing the Error Code

This detected error can be cleared with the **[Auto Fault Reset] ATR** or manually with the **[Fault Reset Assign] RSE** parameter after its cause has been removed.

## [Motor Short Circuit] 5 C F 5



### Probable Cause

Short-circuit at drive output.



### Remedy

- Verify the cables connecting the drive to the motor, and the motor's insulation.
- Contact your local Schneider Electric representative.



### Clearing the Error Code

This detected error can be cleared with the **[Auto Fault Reset] ATR** or manually with the **[Fault Reset Assign] RSE** parameter after its cause has been removed.

## [Safety Config Error] 5 C F F



### Probable Cause

- Safety Module Configuration Error.
- Incorrect configuration linked to the Safety Module has been detected.



### Remedy

- Verify the Safety Module errors for additional information.
- Contact your local Schneider Electric representative.



### Clearing the Error Code

This detected error requires a power reset.

## [Modbus Com Interruption] 5 L F I



### Probable Cause

Communication interruption on the Modbus port.



### Remedy

- Verify the communication bus.
- Verify the timeout.
- Refer to the Modbus user manual.



### Clearing the Error Code

This detected error can be cleared with the **[Auto Fault Reset]** *ATR* or manually with the **[Fault Reset Assign]** *RSF* parameter after its cause has been removed.

## [PC Com Interruption] 5 L F 2



### Probable Cause

Communication interruption with the commissioning software.



### Remedy

- Verify the commissioning software connecting cable.
- Verify the timeout.



### Clearing the Error Code

This detected error can be cleared with the **[Auto Fault Reset]** [ATR](#) or manually with the **[Fault Reset Assign]** [RSF](#) parameter after its cause has been removed.

## [HMI Com Interruption] 5 L F 3



### Probable Cause

Communication interruption with the Graphic display terminal.

This error is triggered when the command or reference value are given using the Graphic Display Terminal and if the communication is interrupted during more than 2 seconds.



### Remedy

- Verify the Graphic display terminal connection.
- Verify the timeout.



### Clearing the Error Code

This detected error can be cleared with the **[Auto Fault Reset]** [ATR](#) or manually with the **[Fault Reset Assign]** [RSF](#) parameter after its cause has been removed.

## [Safety IO Error] 5 1 0 F



### Probable Cause

- Safety Module IO Error.
- Error on input / output of the Safety Module.
- Error on encoder signal.



### Remedy

- Verify the Safety Module errors for additional information.
- Contact your local Schneider Electric representative.



### Clearing the Error Code

This detected error requires a power reset.



## [Motor Overspeed] $5 \square F$



### Probable Cause

- Instability or driving load too high.
- If a downstream contactor is used, the contacts between the motor and the drive have not been closed before applying a Run command.
- The overspeed threshold (corresponding to 110 % of **[Max frequency]**  $f_r$ ) has been reached.



### Remedy

- Verify the motor parameter settings.
- Verify the size of the motor/drive/load.
- Verify and close the contacts between the motor and the drive before applying a Run command.
- Verify the consistency between **[Max frequency]**  $f_r$  and **[High Speed]**  $HSP$ . It is recommended to have at least **[Max frequency]**  $f_r \geq 110\%$  \* **[High Speed]**  $HSP$ .



### Clearing the Error Code

This detected error can be cleared manually with the **[Fault Reset Assign]**  $RSF$  parameter after its cause has been removed.

## [Encoder Feedback Loss] 5 P F



### Probable Cause

This error is triggered if:

- The measured speed is lower than 2 % of **[Nominal Motor Freq]**  $F_r 5$ .
- The difference between the stator speed and the measured speed is greater than 20 % of **[Nominal Motor Freq]**  $F_r 5$ .
- EMC perturbations on the network:
  - Ground cabling.
  - Ground Shielding.
  - Cable routing (control & power mixed).
- No input signal or top Z signal after two rotation has been done.
- Encoder feedback signal missing.
- Supply voltage of the encoder missing or not strong enough.
- Missing of at least one wire at the encoder connection.
- No signal on the pulse input if the input is used for speed measurement.



### Remedy

- Verify the error code value **[Encoder Fdbck Error]**  $E_n C E$ .
- Verify the wiring between the encoder and the drive.
- Verify the encoder.
- Verify the encoder settings.
- Verify the wiring of the pulse input and the sensor used.
- Use a shielded cable and ground both ends.
- Verify the encoder power supply. Reduce **[Encoder Supply Voltage]**  $U_{E C V}$  value.
- Check the supply voltage of the encoder, more details in the ATV340 Installation manual.



### Clearing the Error Code

This detected error can be cleared manually with the **[Fault Reset Assign]**  $R S F$  parameter after its cause has been removed.

## [Security Files Corrupt] S P F L



### Probable Cause

Security files corrupted or missing.



### Remedy

Switch off the product. At next switch-on, the security file will be created again, and the information related to cybersecurity (such as channel policy and password) are set back to the default value.



### Clearing the Error Code

This detected error requires a power reset.

## [Torque timeout] 5 r F



### Probable Cause

The torque control function is not able to regulate the torque within the configured dead band. The drive has switched to speed control for longer than **[Torque ctrl time out] r t o**.



### Remedy

- Verify the settings of the **[Torque control] t o r** - function.
- Verify that there are no mechanical constraints.



### Clearing the Error Code

This detected error can be cleared with the **[Auto Fault Reset] ATR** or manually with the **[Fault Reset Assign] RSF** parameter after its cause has been removed.

## [Torque Limitation Error] 5 5 F



### Probable Cause

The drive was in torque limitation or current limitation state during **[Trq/l Limit Timeout] 5 t o**.



### Remedy

- Verify the settings of the **[Torque limitation] t o L** - function.
- Verify that there are no mechanical constraints.



### Clearing the Error Code

This detected error can be cleared with the **[Auto Fault Reset] ATR** or manually with the **[Fault Reset Assign] RSF** parameter after its cause has been removed.

## [Motor Stall Error] 5 L F



### Probable Cause

The stall monitoring function has detected an error.

The **[Motor Stall Error] 5 L F** is triggered on the following conditions:

- The output frequency is smaller than the stalling frequency **[Stall Frequency] 5 L P 3**
- The output current is higher than the stalling current **[Stall Current] 5 L P 2**
- For a duration longer than the stalling time **S[Stall Max Time] 5 L P 1**.



### Remedy

- Search for a mechanical blocking of the motor.
- Search for a possible cause of motor overload.
- Verify the settings of the monitoring function.



### Clearing the Error Code

This detected error can be cleared with the **[Auto Fault Reset] ATR** or manually with the **[Fault Reset Assign] RSE** parameter after its cause has been removed.

## [AI1 Thermal Sensor Error] $E$ $I$ $C$ $F$



### Probable Cause

The thermal monitoring function has detected an error of the thermal sensor connected to the analog input AI1:

- Open circuit, or
- Short circuit



### Remedy

- Verify the sensor and its wiring.
- Replace the sensor.



### Clearing the Error Code

This detected error can be cleared with the **[Auto Fault Reset]**  $ATR$  or manually with the **[Fault Reset Assign]**  $RSF$  parameter after its cause has been removed.

## [AI3 Thermal Sensor Error] E 3 C F



### Probable Cause

The thermal monitoring function has detected an error of the thermal sensor connected to the analog input AI3:

- Open circuit, or
- Short circuit



### Remedy

- Verify the sensor and its wiring.
- Replace the sensor.
- Verify the setting of **[AI3 Type] R 1 E** parameter.



### Clearing the Error Code

This detected error can be cleared with the **[Auto Fault Reset] ATR** or manually with the **[Fault Reset Assign] RSE** parameter after its cause has been removed.

## [AI4 Thermal Sensor Error] E 4 C F



### Probable Cause

The thermal monitoring function has detected an error of the thermal sensor connected to the analog input AI4:

- Open circuit, or
- Short circuit



### Remedy

- Verify the sensor and its wiring.
- Replace the sensor.
- Verify the setting of **[AI4 Type] R 1 4 E** parameter



### Clearing the Error Code

This detected error can be cleared with the **[Auto Fault Reset] ATR** or manually with the **[Fault Reset Assign] RSF** parameter after its cause has been removed.



## [AI5 Thermal Sensor Error] $\text{E 5 CF}$



### Probable Cause

The thermal monitoring function has detected an error of the thermal sensor connected to the analog input AI5:

- Open circuit, or
- Short circuit



### Remedy

- Verify the sensor and its wiring.
- Replace the sensor.
- Verify the setting of **[AI5 Type]**  $R 15 E$  parameter.



### Clearing the Error Code

This detected error can be cleared with the **[Auto Fault Reset]**  $ATR$  or manually with the **[Fault Reset Assign]**  $RSE$  parameter after its cause has been removed.

## [Encoder Th Sensor Error] $\text{E E CF}$



### Probable Cause

The thermal sensor monitoring function has detected a thermal sensor on the encoder module analog input:

- Open circuit, or
- Short circuit.



### Remedy

- Verify the sensor and its wiring.
- Replace the sensor.



### Clearing the Error Code

This detected error can be cleared with the **[Auto Fault Reset]**  $ATR$  or manually with the **[Fault Reset Assign]**  $RSE$  parameter after its cause has been removed.

## [AI1 Th Level Error] $\text{E H 1 F}$



### Probable Cause

The thermal sensor monitoring function has detected a high temperature on analog input AI1.



### Remedy

- Search for a possible cause of overheating.
- Verify the settings of the monitoring function.



### Clearing the Error Code

This detected error can be cleared with the **[Auto Fault Reset]**  $\text{ATR}$  or manually with the **[Fault Reset Assign]**  $\text{RSF}$  parameter after its cause has been removed.

## [AI3 Th Level Error] $\text{E H 3 F}$



### Probable Cause

The thermal sensor monitoring function has detected a high temperature on analog input AI3.



### Remedy

- Search for a possible cause of overheating.
- Verify the settings of the monitoring function.



### Clearing the Error Code

This detected error can be cleared with the **[Auto Fault Reset]**  $\text{ATR}$  or manually with the **[Fault Reset Assign]**  $\text{RSF}$  parameter after its cause has been removed.

## [AI4 Th Level Error] *E H 4 F*



### Probable Cause

The thermal sensor monitoring function has detected a high temperature on analog input AI4.



### Remedy

- Search for a possible cause of overheating.
- Verify the settings of the monitoring function.



### Clearing the Error Code

This detected error can be cleared with the **[Auto Fault Reset]** *ATR* or manually with the **[Fault Reset Assign]** *RSE* parameter after its cause has been removed.

## [AI5 Th Level Error] *E H 5 F*



### Probable Cause

The thermal sensor monitoring function has detected a high temperature on analog input AI5.



### Remedy

- Search for a possible cause of overheating.
- Verify the settings of the monitoring function.



### Clearing the Error Code

This detected error can be cleared with the **[Auto Fault Reset]** *ATR* or manually with the **[Fault Reset Assign]** *RSE* parameter after its cause has been removed.

## [Encoder Th Detected Error] $\text{E H E F}$



### Probable Cause

The thermal sensor monitoring function has detected a high temperature on encoder module analog input.



### Remedy

- Search for a possible cause of overheating.
- Verify the settings of the monitoring function.



### Clearing the Error Code

This detected error can be cleared with the **[Auto Fault Reset]**  $\text{ATR}$  or manually with the **[Fault Reset Assign]**  $\text{RSF}$  parameter after its cause has been removed.

## [IGBT Overheating] $\text{E J F}$



### Probable Cause

Drive power stage overheating.



### Remedy

- Verify the size of the load/motor/drive according to environment conditions.
- Reduce the switching frequency.
- Increase the ramp time.
- Decrease the current limitation.



### Clearing the Error Code

This detected error can be cleared with the **[Auto Fault Reset]**  $\text{ATR}$  or manually with the **[Fault Reset Assign]**  $\text{RSF}$  parameter after its cause has been removed.

## [Drive Overload] $t L o F$



### Probable Cause

The **[Drive overload monit]**  $o b r$  - function has detected an error.



### Remedy

- Verify the size of the load/motor/drive according to environment conditions.
- Verify the settings of the **[Drive Overload Monit]**  $t L o L$  parameter.



### Clearing the Error Code

This detected error can be cleared with the **[Auto Fault Reset]**  $ATR$  or manually with the **[Fault Reset Assign]**  $RSF$  parameter after its cause has been removed.

## [Autotuning Error] $t n F$



### Probable Cause

- Special motor or motor whose power is not suitable for the drive.
- Motor not connected to the drive.
- Motor not stopped.



### Remedy

- Verify that the motor/drive are compatible.
- Verify that the motor is connected to the drive during autotuning.
- If an output contactor is being used, verify that it is closed during autotuning.
- Verify that the motor is present and stopped during autotuning.
- In case of reluctance motor, reduce **[PSI Align Curr Max]** MCr.



### Clearing the Error Code

This detected error can be cleared manually with the **[Fault Reset Assign]**  $RSF$  parameter after its cause has been removed.

## [Process Underload] $\cup L F$



### Probable Cause

Process underload.



### Remedy

- Verify and remove the cause of the underload.
- Verify the parameters of the **[Process underload]**  $\cup L d$  - function



### Clearing the Error Code

This detected error can be cleared with the **[Auto Fault Reset]**  $ATR$  or manually with the **[Fault Reset Assign]**  $RSF$  parameter after its cause has been removed.

## [Supply Mains UnderV] $\cup 5 F$



### Probable Cause

- Supply mains too low.
- Transient voltage dips.



### Remedy

Verify the voltage and the parameters of **[Undervoltage handling]**  $\cup 5 b$ .



### Clearing the Error Code

This detected error is cleared as soon as its cause has been removed.

# FAQ

## Introduction

If the display does not light up, verify the supply mains to the drive.

The assignment of the fast stop or freewheel functions help to prevent the drive starting if the corresponding digital inputs are not switched on. The drive then displays **[Freewheel]**  $n\ 5\ E$  in freewheel stop and **[Fast stop]**  $F\ 5\ E$  in fast stop. This is a normal behavior since these functions are active at zero so that the drive is stopped if there is a wire break.

Verify that the run command input is activated in accordance with the selected control mode (**[2/3-wire control]**  $E\ C\ C$  and **[2-wire type]**  $E\ C\ E$  parameters).

If the reference channel or command channel is assigned to a fieldbus, when the supply mains is connected, the drive displays **[Freewheel]**  $n\ 5\ E$  . It remains in stop mode until the fieldbus gives a command.

## Drive lock in blocking state

The drive is locked in a blocking state and displays **[Freewheel Stop]**  $n\ 5\ E$  , if a Run command such as Run forward, Run reverse, DC injection is still active during:

- A product reset to the factory settings,
- A manual "Fault Reset" using **[Fault Reset Assign]**  $r\ 5\ F$  ,
- A manual "Fault reset" by applying a product switched off and on again,
- A stop command given by a channel that is not the active channel command (such as Stop key of the display terminal in 2/3 wires control),

It will be necessary to deactivate all active Run commands prior to authorizing a new Run command.

## Option Module Changed or Removed

When an option module is removed or replaced by another, the drive locks in **[Incorrect configuration]**  $C\ F\ F$  error mode at power-on. If the option module has been deliberately changed or removed, the detected error can be cleared by pressing the **OK** key twice, which causes the factory settings to be restored for the parameter groups affected by the option module.

## Control Block Changed

When a control block is replaced by a control block configured on a drive with a different rating, the drive locks in **[Incorrect configuration]**  $C\ F\ F$  error mode at power-on. If the control block has been deliberately changed, the detected error can be cleared by pressing the **OK** key twice, which **causes all the factory settings to be restored.**





# Glossary

## D

### Display terminal :

The display terminal menus are shown in square brackets.

For example: **[Communication]**

The codes are shown in round brackets.

For example: **( C o P )** -

Parameter names are displayed on the display terminal in square brackets.

For example: **[Fallback Speed]**

Parameter codes are displayed in round brackets.

For example: **( L F F )**

## E

### Error :

Discrepancy between a detected (computed, measured, or signaled) value or condition and the specified or theoretically correct value or condition.

## F

### Factory setting:

Factory settings when the product is shipped

### Fault Reset:

A function used to restore the drive to an operational state after a detected error is cleared by removing the cause of the error so that the error is no longer active.

### Fault:

Fault is an operating state. If the monitoring functions detect an error, a transition to this operating state is triggered, depending on the error class. A "Fault reset" is required to exit this operating state after the cause of the detected error has been removed. Further information can be found in the pertinent standards such as IEC 61800-7, ODVA Common Industrial Protocol (CIP).

## M

### Monitoring function:

Monitoring functions acquire a value continuously or cyclically (for example, by measuring) in order to check whether it is within permissible limits. Monitoring functions are used for error detection.

## P

### Parameter:

Device data and values that can be read and set (to a certain extent) by the user.

### PELV:

Protective Extra Low Voltage, low voltage with isolation. For more information: IEC 60364-4-41

### PLC:

Programmable logic controller

**Power stage:**

The power stage controls the motor. The power stage generates current for controlling the motor.

**W**

**Warning:**

If the term is used outside the context of safety instructions, a warning alerts to a potential error that was detected by a monitoring function. A warning does not cause a transition of the operating state.



Schneider Electric  
35 rue Joseph Monier  
92500 Rueil Malmaison  
France

+ 33 (0) 1 41 29 70 00

[www.se.com](http://www.se.com)

As standards, specifications, and design change from time to time,  
please ask for confirmation of the information given in this publication.

© 2023 Schneider Electric. All rights reserved.

NVE61643.08