

Industrial Inverter

(For three-phase inductive motors)

Instruction Manual

Ultra-Compact, Easy-To-Use Inverter

TOSVERT™ *VF-nC1*

<p>Single-phase 100V class 0.1 to 0.75kW Single-phase 200V class 0.2 to 2.2kW Three-phase 200V class 0.1 to 2.2kW</p>

NOTICE

1. Make sure that this instruction manual is delivered to the end user of the inverter unit.
2. Read this manual before installing or operating the inverter unit, and store it in a safe place for reference.

© Toshiba Schneider Inverter Corporation 2002
 All Rights Reserved.

Safety precautions	I
Contents	
Read first	1
Connection	2
Simple operation	3
Basic VF-nC1 operations	4
Basic parameters	5
Extended parameters	6
Variety of operation	7
Monitoring the operation status	8
Taking measures to satisfy the CE / UL / CSA	9
Peripheral devices	10
Table of parameters and data	11
Specifications	12
Before making a service call - Trip information and remedies	13
Inspection and maintenance	14
Warranty	15
Disposal of the inverter	16
使用说明书	Q
Betriebsanleitung	R
Manuale d'uso	S
Manual de instrucciones	T
Manual de Instruções	U
Manuel d'instructions	V

How to set a setup parameter



Setup parameter

After you set the basic parameter tYP to 3 (Initialize to default setting) or the first power, the inverter will be in setup parameter mode. When the inverter is in this mode, you need to set a setup parameter, as described below, to make the inverter ready for operation.

Set the setup parameter according to the logic for control input signals used and the base frequency of the motor connected. (If you are not sure which setup parameter should be selected among $n50$, $P50$ and $n60$ and what values should be specified, consult your reseller.) Each setup parameter automatically sets all parameters relating to the logic for control input signals used and the base frequency of the motor connected.

This parameter setting is needed only for the VFNC1 (S)-□□□□P-W.

Follow these steps to change the setup parameter [Example: Changing from $n50$ to $n60$: sink logic (negative common) and a base frequency of 60Hz]

Key operated	LED display	Operation
	$n50$	Turn the power on.
 	$n60$	Select a parameter among $n50$, $P50$ and $n60$, using the Δ and ∇ keys. Select $n60$ in this case.
	$in\ 1t$	Press the ENTER key to confirm your change. When $in\ 1t$ is displayed, you can set the setup parameter.
	0.0	The operation frequency is displayed (Standby).

- ★ You can change this parameter setting. To do so, you need to reset the basic parameter tYP to 3 (default setting).
- ★ You can also change the parameters in the table below individually even after setting a setup parameter.

The settings of the parameters listed below are changed by the setup parameter. When you search for C.U parameters, only the parameters in the shaded area will be displayed as changed parameters.



■ Values set by each setup parameter

Parameters set	$n50$ (Mainly in Asia)	$P50$ (Mainly in Europe)	$n60$ (Mainly in North America)
$F127$	0 [Sink logic (negative common)]	100 (Source logic (positive common))	0 [Sink logic (negative common)]
$F4091F171$	220 (V)	220 (V)	230 (V)
$F417$	1410 (min^{-1})	1410 (min^{-1})	1710 (min^{-1})
$FH.U.L.F204$	50.0 (Hz)	50.0 (Hz)	60.0 (Hz)
$wL1F170$	50.0 (Hz)	50.0 (Hz)	60.0 (Hz)

I. Safety precautions

The items described in these instructions and on the inverter itself are very important so that you can use the inverter safely prevent injury to yourself and other people around you as well as prevent damage to property in the area. Thoroughly familiarize yourself with the symbols and indications shown below and then continue to read the manual. Make sure that you observe all warnings given.



Explanation of markings

Marking	Meaning of marking
 Warning	Indicates that errors in operation may lead to death or serious injury.
 Caution	Indicates that errors in operation may lead to injury (*1) to people or that these errors may cause damage to physical property. (*2)

(*1) Such things as injury, burns or shock that will not require hospitalization or long periods of outpatient treatment.

(*2) Physical property damage refers to wide-ranging damage to assets and materials.

Meanings of symbols

Symbol	Meaning of Symbol
	Indicates prohibition (Don't do it). What is prohibited will be described in or near the symbol in either text or picture form.
	Indicates something mandatory (must be done). What is mandatory will be described in or near the symbol in either text or picture form.
	Indicates warning or caution. What the warning - caution should be applied to will be described in or near the symbol in either text or picture form.

■ Limits in purpose

This inverter is used for controlling speeds of three-phase induction motors in general industrial use.





1-phase power input inverter is 3-phase outputs, therefore 1-phase motor is not able to drive.





Safety precautions



- ▼ The inverter cannot be used in any device that would present danger to the human body or from which malfunction or error in operation would present a direct threat to human life (nuclear power control device, aviation and space flight control device, traffic device, life support or operation system, safety device, etc.). If the inverter is to be used for any special purpose, first get in touch with the people in charge of sales.
- ▼ This product was manufactured under the strictest quality controls but if it is to be used in critical equipment, for example, equipment in which errors in malfunctioning signal output system would cause a major accident, safety devices must be installed on the equipment.
- ▼ Do not use the inverter for loads other than those of properly applied three-phase induction motors in general industrial use. (Use in other than properly applied three-phase induction motors may cause an accident.)



General operation

 Warning		See item
 Disassembly prohibited	<ul style="list-style-type: none"> Never disassemble, modify or repair. This can result in electric shock, fire and injury. For repairs, call your sales agency. 	2.
 Prohibited	<ul style="list-style-type: none"> Never remove the front cover when power is on or open door if enclosed in a cabinet. The unit contains many high voltage parts and contact with them will result in electric shock. Don't stick your fingers into openings such as cable wiring hole and cooling fan covers. This can result in electric shock or other injury. Don't place or insert any kind of object into the inverter (electrical wire cuttings, rods, wires). This can result in electric shock or fire. Do not allow water or any other fluid to come in contact with the inverter. This can result in electric shock or fire. 	2.1 2. 2. 2.
 Mandatory	<ul style="list-style-type: none"> Turn power on only after attaching the front cover or closing door if enclosed in a cabinet. If power is turned on without the front cover attached or closing door if enclosed in a cabinet. This can result in electric shock or other injury. If the inverter begins to emit smoke or an unusual odor, or unusual sounds, immediately turn power off. If the equipment is continued in operation in such a state, the result may be fire. Call your local sales agency for repairs. Always turn power off if the inverter is not used for long periods of time since there is a possibility of malfunction caused by leaks, dust and other material. If power is left on with the inverter in that state, it may result in fire. 	2.1 3. 3.



 Caution		See item																								
 Prohibited contact	<ul style="list-style-type: none"> Do not touch heat radiating fins. These devices are hot, and you'll get burned if you touch them. 	3.																								
 Prohibited	<ul style="list-style-type: none"> Avoid operation in any location where there is direct spraying of the following solvents or other chemicals. The plastic parts may be damaged to a certain degree depending on their shape, and there is a possibility of the plastic covers coming off and the plastic units being dropped. If the chemical or solvent is anything other than those shown below, please contact us in advance. <p style="text-align: center;">(Table 1) Examples of applicable chemicals and solvents</p> <table border="1" style="margin-left: auto; margin-right: auto;"> <thead> <tr> <th>Chemical</th> <th>Solvent</th> </tr> </thead> <tbody> <tr> <td>Hydrochloric acid (density of 10% or less)</td> <td>Methanol</td> </tr> <tr> <td>Sulfuric acid (density of 10% or less)</td> <td>Ethanol</td> </tr> <tr> <td>Nitric acid (density of 10% or less)</td> <td>Triol</td> </tr> <tr> <td>Caustic soda</td> <td>Mesopropanol</td> </tr> <tr> <td>Ammonia</td> <td>Glycerin</td> </tr> <tr> <td>Sodium chloride (salt)</td> <td></td> </tr> </tbody> </table> <p style="text-align: center;">(Table 2) Examples of unapplicable chemicals and solvents</p> <table border="1" style="margin-left: auto; margin-right: auto;"> <thead> <tr> <th>Chemical</th> <th>Solvent</th> </tr> </thead> <tbody> <tr> <td>Phenol</td> <td>Gasoline, kerosene, light oil</td> </tr> <tr> <td>Benzenesulfonic acid</td> <td>Turpentine oil</td> </tr> <tr> <td></td> <td>Benzol</td> </tr> <tr> <td></td> <td>Thinner</td> </tr> </tbody> </table>	Chemical	Solvent	Hydrochloric acid (density of 10% or less)	Methanol	Sulfuric acid (density of 10% or less)	Ethanol	Nitric acid (density of 10% or less)	Triol	Caustic soda	Mesopropanol	Ammonia	Glycerin	Sodium chloride (salt)		Chemical	Solvent	Phenol	Gasoline, kerosene, light oil	Benzenesulfonic acid	Turpentine oil		Benzol		Thinner	1.4.4
Chemical	Solvent																									
Hydrochloric acid (density of 10% or less)	Methanol																									
Sulfuric acid (density of 10% or less)	Ethanol																									
Nitric acid (density of 10% or less)	Triol																									
Caustic soda	Mesopropanol																									
Ammonia	Glycerin																									
Sodium chloride (salt)																										
Chemical	Solvent																									
Phenol	Gasoline, kerosene, light oil																									
Benzenesulfonic acid	Turpentine oil																									
	Benzol																									
	Thinner																									



■Transportation • Installation



 Warning		See item
 Prohibited	<ul style="list-style-type: none"> Do not install or operate the inverter if it is damaged or any component is missing. This can result in electric shock or fire. Please consult your local sales agency for repairs. Do not place any inflammable objects nearby. If a flame is emitted due to malfunction, it may result in a fire. Do not install in any location where the inverter could come into contact with water or other fluids. This can result in electric shock or fire. 	1.4.4 1.4.4 2.
 Mandatory	<ul style="list-style-type: none"> Must be used in the environmental conditions prescribed in the instruction manual. Use under any other conditions may result in malfunction. Must be installed in non-inflammables such as metals. The rear panel gets very hot. If installation is in an inflammable object, this can result in fire. Do not operate with the front panel cover removed. This can result in electric shock. An emergency stop device must be installed that fits with system specifications (e.g. shut off input power then engage mechanical brake). Operation cannot be stopped immediately by the inverter alone, thus risking an accident or injury. All options used must be those specified by Toshiba. The use of any other option may result in an accident. 	1.4.4 1.4.4 1.4.4 1.4.4 1.4.4

 Caution		See item
 Prohibited	<ul style="list-style-type: none"> When transporting or carrying, do not hold by the front panel covers. The covers may come off and the unit will drop out resulting in injury. Do not install in any area where the unit would be subject to large amounts of vibration. That could result in the unit falling, resulting in injury. 	2. 1.4.4
 Mandatory	<ul style="list-style-type: none"> The main unit must be installed on a base that can bear the unit's weight. If the unit is installed on a base that cannot withstand that weight, the unit may fall resulting in injury. If braking is necessary (to hold motor shaft), install a mechanical brake. The brake on the inverter will not function as a mechanical hold, and if used for that purpose, injury may result. 	1.4.4 1.4.4



■Wiring



 Warning		See item
 Prohibited	<ul style="list-style-type: none"> Do not connect input power to the output (motor side) terminals (U/T1,V/T2,W/T3). That will destroy the inverter and may result in fire. Do not connect resistors to the DC terminals (across PA/+PC/- or PO-PC/-). That may cause a fire. Connect resistors as directed by the instructions for "Installing separate braking resistors." Within 15 minutes after turning off input power, do not touch wires of devices (MCCB) connected to the input side of the inverter. That could result in electric shock. If you take the power supply from an outlet, do not over the outlet's rated current. That could emit the outlet and may result in an ignition. 	2.2 2.2 2.2 10.1

 Warning		See item
 Mandatory	<ul style="list-style-type: none"> • Electrical construction work must be done by a qualified expert. Connection of input power by someone who does not have that expert knowledge may result in fire or electric shock. • Connect output terminals (motor side) correctly. If the phase sequence is incorrect, the motor will operate in reverse and that may result in injury. • Wiring must be done after installation. If wiring is done prior to installation that may result in injury or electric shock. • The following steps must be performed before wiring. <ul style="list-style-type: none"> ① Turn off all input power. ② Wait at least 15 minutes and check to make sure that the charge lamp is no longer lit. ③ Use a tester that can measure DC voltage (400VDC or more), and check to make sure that the voltage to the DC main circuits (across PA/+ -PC/-) is 45V or less. If these steps are not properly performed, the wiring will cause electric shock. • Tighten the screws on the terminal board to specified torque. If the screws are not tightened to the specified torque, it may lead to fire. • Check to make sure that the input power voltage is +10%, -15% of the rated power voltage written on the rating label ($\pm 10\%$ when the load is 100% in continuous operation) If the input power voltage is not +10%, -15% of the rated power voltage ($\pm 10\%$ when the load is 100% in continuous operation) this may result in fire. 	2.1 2.1 2.1 2.1 2.1 1.4.4
 Be Grounded	<ul style="list-style-type: none"> • Ground must be connected securely. If the ground is not securely connected, it could lead to electric shock or fire when a malfunction or current leak occurs. 	2.1 2.2

 Caution		See item
 Prohibited	<ul style="list-style-type: none"> • Do not attach equipment (such as noise filters or surge absorbers) that has built-in capacitors to the output (motor side) terminals. That could result in a fire. 	2.1

Operations



 Warning		See item
 Prohibited	<ul style="list-style-type: none"> • Do not touch inverter terminals when electrical power is going to the inverter even if the motor is stopped. Touching the inverter terminals while power is connected to it may result in electric shock. • Do not touch switches when the hands are wet and do not try to clean the inverter with a damp cloth. Such practices may result in electric shock. • Do not go near the motor in alarm-stop status when the retry function is selected. The motor may suddenly restart and that could result in injury. Take measures for safety, e.g. attaching a cover to the motor, against accidents when the motor unexpectedly restarts. 	3. 3. 3.
 Mandatory	<ul style="list-style-type: none"> • Turn input power on after attaching the front cover. When storing inside the cabinet and using with the front cover removed, always close the cabinet doors first and then turn power on. If the power is turned on with the front cover or the cabinet doors open, it may result in electric shock. • Make sure that operation signals are off before resetting the inverter after malfunction. If the inverter is reset before turning off the operating signal, the motor may restart suddenly causing injury. 	3. 3.

 Caution		See item
 Prohibited	<ul style="list-style-type: none"> Observe all permissible operating ranges of motors and mechanical equipment. (Refer to the motor's instruction manual.) Not observing these ranges may result in injury. 	3.



When sequence for restart after a momentary power failure is selected (inverter)

 Caution		See item
 Mandatory	<ul style="list-style-type: none"> Stand clear of motors and mechanical equipment If the motor stops due to a momentary power failure, the equipment will start suddenly after power recovers. This could result in unexpected injury. Attach warnings about sudden restart after a momentary power failure on inverters, motors and equipment for prevention of accidents in advance. 	6.11.1 6.11.1



When retry function is selected (inverter)

 Caution		See item
 Mandatory	<ul style="list-style-type: none"> Stand clear of motors and equipment. If the motor and equipment stop when the alarm is given, selection of the retry function will restart them suddenly after the specified time has elapsed. This could result in unexpected injury. Attach warnings about sudden restart in retry function on inverters, motors and equipment for prevention of accidents in advance. 	6.11.3 6.11.3

Maintenance and inspection

 Warning		See item
 Prohibited	<ul style="list-style-type: none"> Do not replace parts. This could be a cause of electric shock, fire and bodily injury. To replace parts, call the local sales agency. 	14.2
 Mandatory	<ul style="list-style-type: none"> The equipment must be inspected every day. If the equipment is not inspected and maintained, errors and malfunctions may not be discovered and that could result in accidents. Before inspection, perform the following steps. <ol style="list-style-type: none"> ① Turn off all input power to the inverter. ② Wait for at least 15 minutes and check to make sure that the charge lamp is no longer lit. ③ Use a tester that can measure DC voltages (400VDC or more), and check to make sure that the voltage to the DC main circuits (across PA/+ -PC/-) is 45V or less. If inspection is performed without performing these steps first, it could lead to electric shock. 	14. 14.

Disposal

 Caution		See item
 Mandatory	<ul style="list-style-type: none"> If you throw away the inverter, have it done by a specialist in industry waste disposal*. If you throw away the inverter by yourself, this can result in explosion of capacitor or produce noxious gases, resulting in injury. <p>(*) Persons who specialize in the processing of waste and known as "industrial waste product collectors and transporters" or "industrial waste disposal persons."</p> <p>If the collection, transport and disposal of industrial waste is done by someone who is not licensed for that job, it is a punishable violation of the law. (Law on Waste Disposal and Cleaning)</p>	16.



Attach caution labels

Shown here are examples of caution labels to prevent, in advance, accidents in relation to inverters, motors and other equipment.

If the inverter has been programmed for auto-restart function after momentary power failure or retry function, place caution labels in a place where they can be easily seen and read.

If the inverter has been programmed for restart sequence of momentary power failure, place caution labels in a place where they can be easily seen and read.

(Example of caution label)

	Caution (Functions programmed for restart)
Do not go near motors and equipment. Motors and equipment that have stopped temporarily after momentary power failure will restart suddenly after recovery.	

If the retry function has been selected, place caution labels in a location where they can be easily seen and read.

(Example of caution label)

	Caution (Functions programmed for retry)
Do not go near motors and equipment. Motors and equipment that have stopped temporarily after an alarm will restart suddenly after the specified time has elapsed.	

— Contents —



I.	Safety precautions	1
1.	Read first	A-1
1.1	Check purchased product	A-1
1.2	Contents of the product code	A-1
1.3	Name and function of each part	A-2
1.4	Notes on the application	A-9
2.	Connection	B-1
2.1	Cautions on wiring	B-1
2.2	Standard connections	B-2
2.3	Description of terminals	B-7
3.	Simple operation	C-1
3.1	Simple operation of the VF-nC1	C-2
4.	Basic VF-nC1 operations	D-1
4.1	How to set parameters	D-2
5.	Basic parameters	E-1
5.1	Selecting an operation mode	E-1
5.2	Meter setting and adjustment	E-2
5.3	Standard default setting	E-4
5.4	Selecting forward and reverse runs (operation panel only)	E-5
5.5	Setting acceleration/deceleration time	E-5
5.6	Maximum frequency	E-6
5.7	Upper limit and lower limit frequencies	E-6
5.8	Base frequency	E-7
5.9	Selecting control mode	E-7
5.10	Setting the electronic thermal	E-9
5.11	Preset speed operation (speeds in 15 steps)	E-11
6.	Extended parameters	F-1
6.1	Output signal-related parameters	F-1
6.2	Parameters related to terminal function selection	F-3
6.3	Basic parameters 2	F-7
6.4	Analog signals for frequency setting	F-8
6.5	Operation frequency	F-10
6.6	DC braking	F-11
6.7	Jump frequency – Jumping resonant frequencies	F-12
6.8	Preset speed operation frequencies 8 to 15	F-12
6.9	PWM carrier frequency	F-12
6.10	Trip-less intensification	F-13
6.11	Performing PI control	F-17
6.12	Improving torque and speed characteristics	F-19
6.13	Acceleration/deceleration patterns and acceleration/deceleration 2	F-20
6.14	Protection functions	F-21
6.15	Operation panel parameters	F-26
6.16	Communication function (common serial)	F-28
7.	Variety of operation	G-1
7.1	Setting the operation frequency	G-1
7.2	Setting the operation mode	G-3
8.	Monitoring the operation status	H-1
8.1	Status monitor mode	H-1

8.2	Display of trip information	H-3
9.	Taking measures to satisfy the CE / UL / CSA	I-1
9.1	Compliance with the CE Marking	I-1
9.2	Compliance with UL Standard and CSA Standard	I-6
10.	Peripheral devices	J-1
10.1	Selection of wiring materials and devices	J-1
10.2	Installation of a magnetic contactor	J-3
10.3	Installation of an overload relay	J-3
11.	Table of parameters and data	K-1
11.1	User parameters	K-1
11.2	Basic parameters	K-1
11.3	Extended parameters	K-3
12.	Specifications	L-1
12.1	Models and their standard specifications	L-1
12.2	External dimensions/weights	L-4
13.	Before making a service call – Trip information and remedies	M-1
13.1	Trip causes/warnings and remedies	M-1
13.2	Restoring the inverter from a trip	M-6
13.3	If the motor does not run while no trip message is displayed ...	M-7
13.4	How to determine the causes of other problems	M-8
14.	Inspection and maintenance	N-1
14.1	Regular inspection	N-1
14.2	Periodical inspection	N-2
14.3	Making a call for servicing	N-4
14.4	Keeping the inverter in storage	N-4
15.	Warranty	O-1
16.	Disposal of the inverter	P-1

1. Read first

1.1 Check purchased product

Before using the product you have purchased, check to make sure that it is exactly what you ordered.

 Caution	
 Mandatory	Use an inverter that conforms to the specifications of power supply and three-phase induction motor being used. If the inverter being used does not conform to those specifications, not only will the three-phase induction motor not rotate correctly, but it may cause serious accidents through overheating and fire.

Applicable motor label

Pet name
Power supply
Motor capacity

VFNC1-2007P
3PH - 200V - 0.75kW

Inverter main unit



Name plate

Inverter type →

Power supply →

Rated output current and capacity →

TOSHIBA
TRANSISTOR INVERTER

VFNC1-2007P
0.75kW-1.8kW-1HP

INPUT	OUTPUT
U(V) 3PH 200/240	3PH 200/240
F(Hz) 50/60	0.5/200
I(A) 6.3	4.0

AIC1000A FUSE CC/J 8max
Cu AWG14-75°C
0.8Nm 7.1lb-in

Lot No. 030 12345678
Serial No. 131791180123

Motor Protective Device Class 10



TOSHIBA CORPORATION
TSU

Carton box

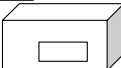

Applicable motor label



Name plate



1.2 Contents of the product code

Here is explained the type and form written on the label

Type					Form													
V	F	N	C	1	S	-	2	0	0	7	P	L	-	W	-	A		
Model name		Input voltage		Applicable motor capacity		Additional functions 2		Destination		Special specification code								
TOSVERT VF-nC1 Series		1:100V~115V 2:200V~240V		001: 0.1kW 002: 0.2kW 004: 0.4kW 007: 0.75kW 015: 1.5kW 022: 2.2kW		L : High-attenuation filter inside		W : World wide - :Japan		ADD: □□ is the number								
Number of power phases																		
S: single-phase None: three-phase																		
														Additional functions 1				
														P : Operation panel type				

* The code indicates a Toshiba's procurement route.

Caution: Always shut power off first then check the ratings label of inverter held in a cabinet.

1.3 Name and function of each part

1.3.1 Operation keypad panel

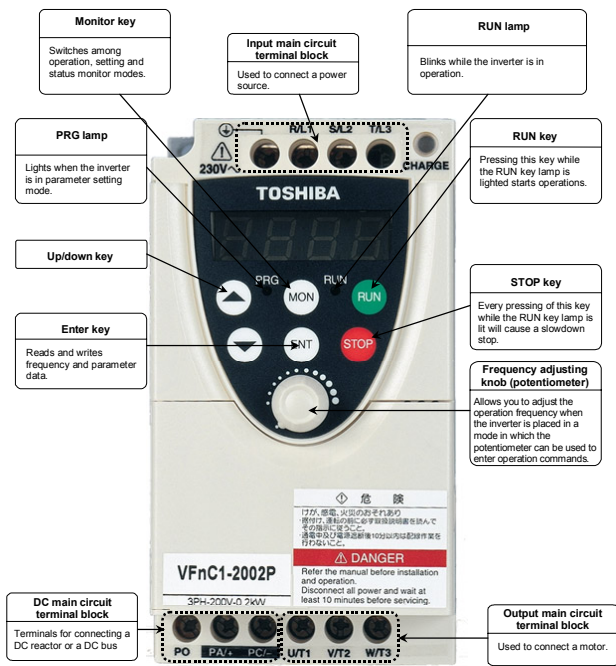

[Front panel]

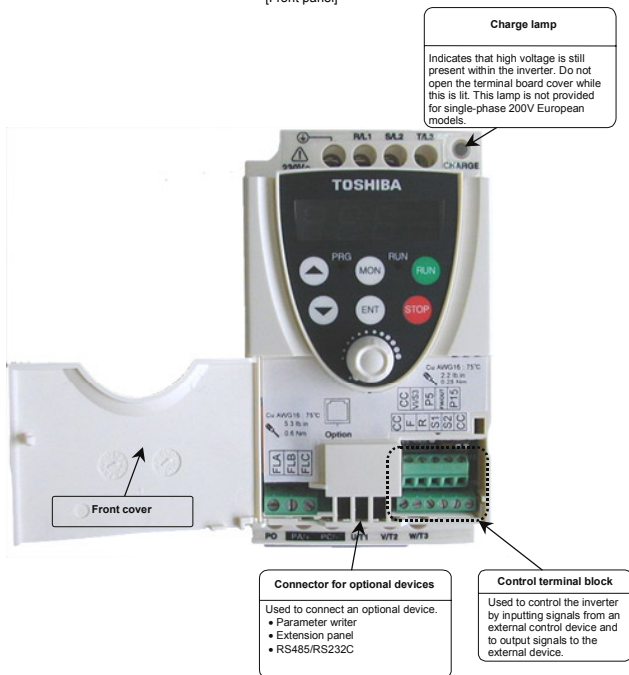

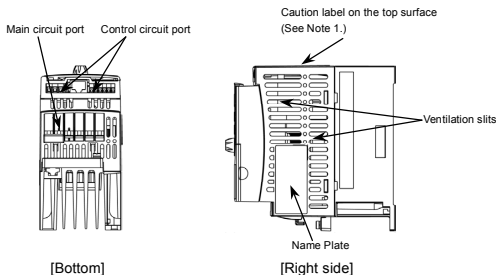

Note 1: When installing the inverter where the ambient temperature will rise above 40°C, detach this caution label.

An example of a caution label on the top surface translation



■ Self-up terminal block

The self-up terminals , R/L1, S/L2, (T/L3), U/T1, V/T2 and W/T3 on the main circuit board were factory-set to the UP position to allow you to connect cables smoothly. After you have connected cables to these terminals, tighten them securely.

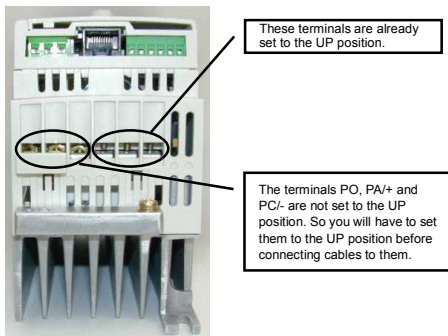

Note: The self-up (self-lifting) terminals of VFNC1 are constructed with plastic body and screws, therefore please take following precautions.

- Do not unscrew the power terminals to UP position frequently. (Less than 5 times is recommended)
- Do not press the screw when unscrew the main terminals.
- Do not unscrew quickly like using an Electric screw driver.
- Do not pull the power wire during unscrewing the power terminals to UP position.
- Do not unscrew the power terminal to UP position with over torque.
- Do not make any deformation of the cover when unscrewing the power terminals.

1.3.2 Main circuit and control circuit terminal blocks

1) Main circuit terminal block

When using a crimp terminal, cover its caulked part with a tube or use an insulated terminal.

Screw size	tightening torque
M3 screw	0.8N · m
M3.5 screw	1.0N · m

VFNC1-2001P~2007P

[Main circuit input terminals]

M3 screw



[Main circuit output terminals]

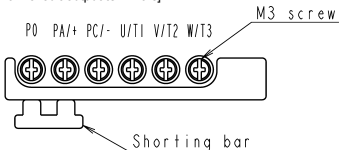

VFNC1-2015P~2022P

[Main circuit input terminals]

M3.5 screw

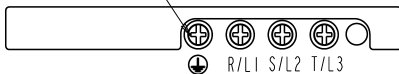

[Main circuit output terminals]

M3.5 screw

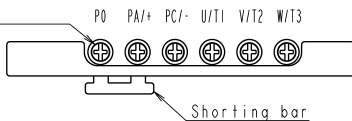

VFNC1S-1001P~1004P
VFNC1S-2002P~2007P

[Main circuit input terminals]

M3 screw



[Main circuit output terminals]

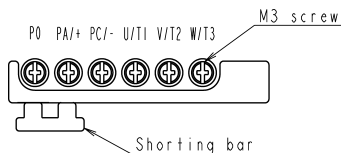

VFNC1S-1007P
VFNC1S-2015P~2022P

[Main circuit input terminals]

M3.5 screw



[Main circuit output terminals]

M3.5 screw

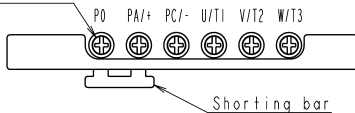

VFNC1S-2002PL~2007PL

[Main circuit input terminals]

M3 screw



[Main circuit output terminals]

M3 screw

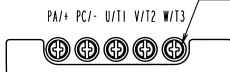

VFNC1S-2015PL~2022PL

[Main circuit input terminals]

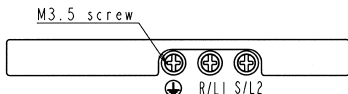

[Main circuit output terminals]

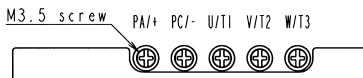

2) Control circuit terminal block

The same type of terminal block is provided for all models.

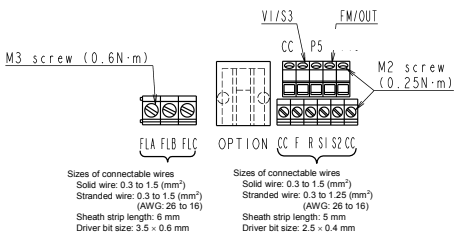



For details of each terminal, see 2.3.2.

1.4 Notes on the application

1.4.1 Motors

When the VF-nC1 and the motor are used in conjunction, pay attention to the following items.

 Caution	
 Mandatory	Use an inverter that conforms to the specifications of the three-phase induction motor and power supply being used. If the inverter being used does not conform to those specifications, not only will the three-phase induction motor not rotate correctly, but it may cause serious accidents through overheating and fire.

Comparisons with commercial power operation.

The VF-nC1 Inverter employs the sinusoidal PWM system. However, the output voltage and output current do not assume a precise sine wave, they have a distorted wave that is close to sinusoidal waveform. This is why compared to operation with a commercial power there will be a slight increase in motor temperature, noise and vibration.

Operation in the low-speed area

When running continuously at low speed in conjunction with a general purpose motor, there may be a decline in that motor's cooling effect. If this happens, operate with the output decreased from rated load.

If you want to run continuously low speed operations at rated torque, please use the VF motor made especially for Toshiba inverter. When operating in conjunction with a VF motor, you must change the inverter's motor overload protection level to "VF motor use (ULN)".

Adjusting the overload protection level

The VF-nC1 Inverter protects against overloads with its overload detection circuits (electronic thermal). The electronic thermal's reference current is set to the inverter's rated current, so that it must be adjusted in line with the rated current of the general purpose motor being used in combination.

High speed operation at and above 60Hz

Operating at frequencies greater than 60Hz will increase noise and vibration. There is also a possibility that such operation will exceed the motor's mechanical strength limits and the bearing limits so that you should inquire to the motor's manufacturer about such operation.

Method of lubricating load mechanisms.

Operating an oil-lubricated reduction gear and gear motor in the low-speed areas will worsen the lubricating effect. Check with the manufacturer of the reduction gear to find out about operable gearing area.

Extremely low loads and low inertia loads

The motor may demonstrate instability such as abnormal vibrations or overcurrent trips at light loads of 50 percent or under of the load percentage, or when the load's inertia moment is extremely small. If that happens reduce the carrier frequency.

Occurrence of instability

Unstable phenomena may occur under the load and motor combinations shown below.

- Combined with a motor that exceeds applicable motor ratings recommended for the inverter
 - Combined with special motors such as explosion-proof motors
- To deal with the above lower the settings of inverter carrier frequency.
- Combined with couplings between load devices and motors with high backlash
 - Combined with loads that have sharp fluctuations in rotation such as piston movements

Braking a motor when cutting off power supply

A motor with its power cut off goes into free-run, and does not stop immediately. To stop the motor quickly as soon as the power is cut off install an auxiliary brake. There are different kinds of brake devices, both electrical and mechanical. Select the brake that is best for the system.

Loads that generate negative torque

When combined with loads that generate negative torque the protection for overvoltage and overcurrent on the inverter will go into operation and may cause a trip. For this kind of situation, you must install a dynamic braking resistor, etc. that complies with the load conditions.

Motor with brake

If a motor with brake is connected directly to the output side of the inverter, the brake will not release because voltage at startup is low. Wire the brake circuit separately from the motor's main circuits.

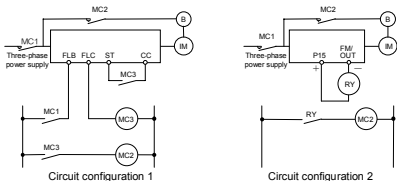

In circuit configuration 1, the brake is turned on and off through MC2 and MC3. If the circuit is configured in some other way, the overcurrent trip may be activated because of the locked rotor current when the brake goes into operation. Circuit configuration 2 uses low-speed signal FM/OUT to turn on and off the brake. Turning the brake on and off with a low-speed signal may be better in such applications as elevators. Please confer with us before designing the system.

1.4.2 Inverters

Protecting inverters from overcurrent

The inverter has an overcurrent protection function. However because the programmed current level is set to the inverter's maximum applicable motor, if the motor is one of small capacity and it is in operation, the overcurrent level and the electronic thermal protection must be readjusted. If adjustment is necessary, see 5-10 in Chapter 5, and make adjustments as directed.

Inverter capacity

Do not operate a large capacity motor with a small capacity (kVA) inverter even with light loads. Current ripple will raise the output peak current making it easier to set off the overcurrent trip.

Power factor improving capacitors

Power factor improving capacitors cannot be installed on the output side of the inverter. When a motor is run that has a power factor improving capacitor attached to it, remove the capacitors. This can cause inverter malfunction trips and capacitor destruction.

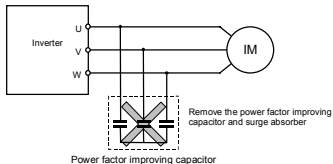

Operating at other than rated voltage

Connections to voltages other than the rated voltage described in the rating label cannot be made. If a connection must be made to a power supply other than one with rated voltage, use a transformer to raise or lower the voltage to the rated voltage.

Circuit interrupting when two or more inverters are used on the same power line.

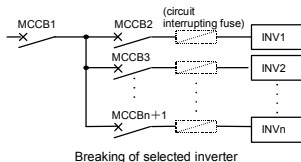

There is no fuse in the inverter's main circuit. Thus, as the diagram above shows, when more than one inverter is used on the same power line, you must select interrupting characteristics so that only the MCCB2 will trip and the MCCB1 will not trip when a short occurs in the inverter (INV1). When you cannot select the proper characteristics install a circuit interrupting fuse between the MCCB2 and the INV1.

■ Disposal

If an inverter is no longer usable, dispose of it as industrial waste.

1.4.3 What to do about leak current

⚠ Warning

Current may leak through the inverter's input/output wires because of insufficient electrostatic capacity on the motor with bad effects on peripheral equipment. The leak current's value is affected by the carrier frequency and the length of the input/output wires. Test and adopt the following remedies against leak current.

(1) Leakage current from the inverter main unit

As compared with other types of inverters, a large amount of current leaks from your inverter when it is used in delta connection (with one phase grounded). Take this into consideration when selecting an earth leakage breaker.

<Leakage current in delta connection (one phase grounded)> (For reference only)

VFNC1-2001P to 2022P	: About 1mA
VFNC1S-2002P to 2007P	: About 6mA
VFNC1S-1001P to 1007P	: About 3mA
VFNC1S-2002PL to 2007PL	: About 11mA
VFNC1S-2015P to 2022P	: About 3mA
VFNC1S-2015PL to 2022PL	: About 17mA

(2) Effects of leakage current across ground

Leakage current may flow not just through the inverter system but also through ground wires to other systems. Leakage current will cause earth leakage breakers, leak current relays, ground relays, fire alarms and sensors to operate improperly, and it will cause superimposed noise on the CRT screen or display of incorrect current amounts during current detection with the CT.

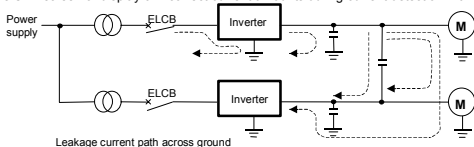

Remedies:

1. Reduce PWM carrier frequency.
The setting of PWM carrier frequency is done with the parameter $F300$.
2. Use high frequency remedial products for earth leakage breakers. If you use equipment like this, there is no need to reduce the PWM carrier frequency.
3. If the sensors and CRT are affected, it can be remedied using the reduction of PWM carrier frequency described in 1 above, but if this cannot be remedied since there is an increase in the motor's magnetic noise, please consult with Toshiba.

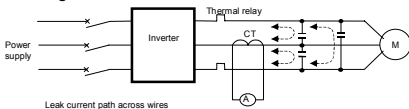
(3) Affects of leakage current across lines**① Thermal relays**

The high frequency component of current leaking into electrostatic capacity between inverter output wires will increase the effective current values and make externally connected thermal relays operate improperly. If the wires are more than 50 meters long, it will be easy for the external thermal relay to operate improperly with models having motors of low rated current (several A(ampere) or less), because the leak current will increase in proportion to the motor rating.

Remedies:

1. Use the electronic thermal built into the inverter.
The setting of the electronic thermal is done using parameter $Q L N \& t H r$.
2. Reduce the inverter's PWM carrier frequency. However, that will increase the motor's magnetic noise. Use parameter $F300$ for setting the PWM carrier frequency.
3. This can be improved by installing $0.1\mu\text{F}$ - $0.5\mu\text{F}$ - 1000V film capacitor to the input/output terminals of each phase in the thermal relay.

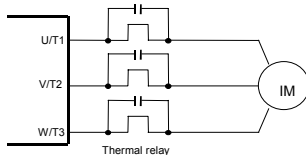
**② CT and ammeter**

If a CT and ammeter are connected externally to detect inverter output current, the leak current's high frequency component may destroy the ammeter. If the wires are more than 50 meters long, it will be easy for the high frequency component to pass through the externally connected CT and be superimposed on and burn the ammeter with models having motors of low rated current (several A(ampere) or less) because the leak current will increase in proportion to the motor's rated current.







Remedies:

1. Use a multi-function programmable output terminal for the inverter's control circuit.
A current can be put out via the FM/OUT terminal.
If the meter is connected, use an ammeter of 1mAdc full scale or a voltmeter of 7.5V-1mA full scale.
2. Use the monitor functions built into the inverter.
Use the monitor functions on the panel built into the inverter to check current values.

1.4.4 Installation

■ Installation environment

The VF-nC1 Inverter is an electronic control instrument. Take full consideration to installing it in the proper operating environment.

 Warning	
 Prohibited	<ul style="list-style-type: none"> Do not place any inflammable substances near the VF-nC1 Inverter. If an accident occurs in which flame is emitted, this could lead to fire.
 Mandatory	<ul style="list-style-type: none"> Operate under the environmental conditions prescribed in the instruction manual. Operations under any other conditions may result in malfunction.
 Caution	
 Prohibited	<ul style="list-style-type: none"> Do not install the VF-nC1 Inverter in any location subject to large amounts of vibration. This could cause the unit to fall, resulting in bodily injury.
 Mandatory	<ul style="list-style-type: none"> Check to make sure that the input power voltage is +10%, -15% of the rated power voltage written on the rating label ($\pm 10\%$ when the load is 100% in continuous operation) If the input power voltage is not +10%, -15% of the rated power voltage ($\pm 10\%$ when the load is 100% in continuous operation) this may result in fire.

- Do not install in any location of high temperature, high humidity, moisture condensation and freezing and avoid locations where there is exposure to water and/or where there may be large amounts of dust, metallic fragments and oilmist.
- Do not install in any location where corrosive gases or grinding fluids are present.
- Operate in areas where ambient temperature ranges from -10°C to 50°C . However, when installing the inverter where the ambient temperature will rise above 40°C , detach the caution label on the top surface.

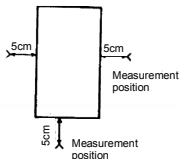

Note: The inverter is a heat-emitting body. Make sure to provide proper space and ventilation when installing in the cabinet. When installing the inverter in a cabinet, you are recommended to detach the caution label even if the temperature in the cabinet is below 40°C .

- Do not install in any location that is subject to large amounts of vibration.





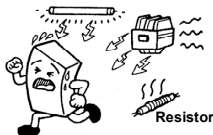

- If the VF-nC1 Inverter is installed near any of the equipment listed below, provide measures to insure against errors in operation.



Solenoids:	Attach surge suppressor on coil.
Brakes:	Attach surge suppressor on coil.
Magnetic contactors:	Attach surge suppressor on coil.
Fluorescent lights:	Attach surge suppressor on coil.
Resistors:	Place far away from VF-nC1 Inverter.

How to install

 Warning	
 Prohibited	<ul style="list-style-type: none"> Do not install and operate the inverter if it is damaged or any component is missing. This can result in electric shock or fire. Please consult your local agency for repairs.
 Mandatory	<ul style="list-style-type: none"> Must be installed in nonflammables such as metals. The rear panel gets very hot so that if installation is in an inflammable object, this can result in fire. Do not operate with the front panel cover removed. This can result in electric shock. An emergency stop device must be installed that fits with system specifications (e.g. cuts off input power then engages mechanical brakes). Operation cannot be stopped immediately by the inverter alone, thus risking an accident or injury. All options used must be those specified by Toshiba. The use of any other option may result in an accident.

 Caution	
 Mandatory	<ul style="list-style-type: none"> The main unit must be installed on a base that can bear the unit's weight. If the unit is installed on a base that cannot withstand that weight, the unit may fall resulting in injury. If braking is necessary (to hold motor shaft), install a mechanical brake. The brake on the inverter will not function as a mechanical hold, and if used for that purpose, injury may result.

Installation location

Select a location with good indoor ventilation, place lengthwise in the vertical direction and attach to a metal wall surface.

If you are installing more than one inverter, the separation between inverters should be at least 5 centimeters, and they should be arranged in horizontal rows.

If the inverters are horizontally arranged with no space between them (side-by-side installation), peel of the ventilation seals on top of the inverters and operate at 40°C or less, and reduce (See 6.9) the rated output current.

- Standard installation
- Horizontal installation (side-by-side installation)

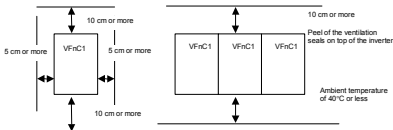

The space shown in the diagram is the minimum allowable space. Because air cooled equipment has cooling fans built in on the top or bottom surfaces, make the space on top and bottom as large as possible to allow for air passage.

Note: Do not install in any location where there is high humidity or high temperatures and where there are large amounts of dust, metallic fragments and oilmist. If you are going to install the equipment in any area that presents a potential problem, please consult with Toshiba before doing so.

■ Calorific values of the inverter and the required ventilation

The energy loss when the inverter converts power from AC to DC and then back to AC is about 5-10 percent. In order to suppress the rise in temperature inside the cabinet when this loss becomes heat loss, the interior of the cabinet must be ventilated and cooled.

Voltage Class	Operating motor capacity (kW)	Inverter Type	Calorific Values (W)	Amount of forcible air cooling ventilation required (m ³ /min)	Heat discharge surface area required for sealed storage cabinet (m ²)	
			Carrier frequency 12kHz			
Single-Phase 100V Class	0.1	VFNC1S-	:1001P	12	0.07	0.24
	0.2		:1002P	21	0.12	0.42
	0.4		:1004P	30	0.17	0.6
	0.75		:1007P	55	0.31	1.1
Single-Phase 200V Class	0.2	VFNC1S-	:2002P(L)	21	0.12	0.42
	0.4		:2004P(L)	30	0.17	0.6
	0.75		:2007P(L)	55	0.31	1.1
	1.5		:2015P(L)	96	0.55	1.9
	2.2		:2022P(L)	126	0.72	2.5
Three-Phase 200V Class	0.1	VFNC1-	:2001P	12	0.07	0.24
	0.2		:2002P	21	0.12	0.42
	0.4		:2004P	30	0.17	0.6
	0.75		:2007P	55	0.31	1.1
	1.5		:2015P	96	0.55	1.9
	2.2		:2022P	126	0.72	2.5

Notes

- 1) The heat loss for the optional external devices (input reactor, DC reactor, radio noise reduction filters, etc.) is not included in the calorific values in the table.
- 2) Case of 100% Load Continuation operation.

■ Panel designing taking into consideration the effects of noise.

The inverter generates high frequency noise. When designing the control panel setup, consideration must be given to that noise. Examples of measures are given below.

- Wire so that the main circuit wires and the control circuit wires are separated. Do not place them in the same conduit, do not run them parallel, and do not bundle them.
- Provide shielding and twisted wire for control circuit wiring.
- Separate the input (power) and output (motor) wires of the main circuit. Do not place them in the same conduit, do not run them parallel, and do not bundle them.
- Ground the inverter ground terminals (⊕).
- Install surge suppressor on any magnetic contactor and relay coils used around the inverter.
- Install noise filters if necessary.



■ Installing more than one unit in a cabinet

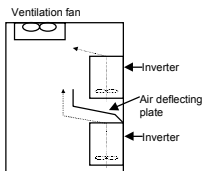

If you are installing two or more inverters in one cabinet, pay attention to the following.

- Inverters may be installed side by side with each other with no space left between them. When installing inverters side by side, detach the caution label on the top surface of each inverter and use them where the ambient temperature will not rise above 40°C.
- When using inverters where the ambient temperature will exceed 40°C, allow a space of 5 cm or more between inverters and detach the caution label on the top surface of each inverter.
- Ensure a space of at least 20 cm on the top and bottom of the inverters.
- Install an air deflecting plate so that the heat rising up from the inverter on the bottom does not affect the inverter on the top.









2. Connection

 Warning	
 Disassembly prohibited	<ul style="list-style-type: none"> Never disassemble, modify or repair. This can result in electric shock, fire and injury. For repairs, call your sales agency.
 Prohibited	<ul style="list-style-type: none"> Don't stick your fingers into openings such as cable wiring hole and cooling fan covers. This can result in electric shock or other injury. Don't place or insert any kind of object into the inverter (electrical wire cuttings, rods, wires). This can result in electric shock or fire. Do not allow water or any other fluid to come in contact with the inverter. That may result in electric shock or fire.

 Caution	
 Prohibited	<ul style="list-style-type: none"> When transporting or carrying, do not hold by the front panel covers. The covers may come off and the unit will drop out resulting in injury.

2.1 Cautions on wiring

 Warning	
 Prohibited	<ul style="list-style-type: none"> Never remove the front cover when power is on or open door if enclosed in a cabinet. The unit contains many high voltage parts and contact with them will result in electric shock.
 Mandatory	<ul style="list-style-type: none"> Turn power on only after attaching the front cover or closing door if enclosed in a cabinet. If power is turned on without the front cover attached or closing door if enclosed in a cabinet. This can result in electric shock or other injury. Electrical construction work must be done by a qualified expert. Connection of input power by someone who does not have that expert knowledge may result in fire or electric shock. Connect output terminals (motor side) correctly. If the phase sequence is incorrect, the motor will operate in reverse and that may result in injury. Wiring must be done after installation. If wiring is done prior to installation that may result in injury or electric shock. The following steps must be performed before wiring. <ol style="list-style-type: none"> ① Shut off all input power. ② Wait at least 15 minutes and check to make sure that the charge lamp is no longer lit. ③ Use a tester that can measure DC voltage (400VDC or more), and check to make sure that the voltage to the DC main circuits (across PA/+ -PC/C) is 45V or less. If these steps are not properly performed, the wiring will cause electric shock. Tighten the screws on the terminal board to specified torque. If the screws are not tightened to the specified torque, it may lead to fire.
 Be Grounded	<ul style="list-style-type: none"> Ground must be connected securely. If the ground is not securely connected, it could lead to electric shock or fire when a malfunction or current leak occurs.

 Caution	
 Prohibited	<ul style="list-style-type: none"> Do not attach devices with built-in capacitors (such as noise filters or surge absorber) to the output (motor side) terminal. This could cause a fire.

2

Preventing radio noise

To prevent electrical interference such as radio noise, separately bundle wires to the main circuit's power terminals (R/L1, S/L2, T/L3) and wires to the motor terminals (U/T1, V/T2, W/T3).



Control and main power supply

The control power supply and the main circuit power supply for the VF-nC1 are the same. If a malfunction or trip causes the main circuit to be shut off, control power will also be shut off. When checking the cause of the malfunction or the trip, use the trip holding retention selection parameter.

Wiring

- Because the space between the main circuit terminals is small use sleeved pressure terminals for the connections. Connect the terminals so that adjacent terminals do not touch each other.
- For ground terminal  use wires of the size that is equivalent to or larger than those given in table 10.1 and always ground the inverter (100V/200V voltage class: D type ground [former type 3 ground]).
Use as large and short a ground wire as possible and wire it as close as possible to the inverter.
- See the table in 10.1 for wire sizes.
- The length of the main circuit wire in 10.1 should be no longer than 30 meters. If the wire is longer than 30 meters, the wire size (diameter) must be increased.

2.2 Standard connections

 Warning	
 Prohibited	<ul style="list-style-type: none"> Do not connect input power to the output (motor side) terminals (U/T1, V/T2, W/T3). Connecting input power to the output could destroy the inverter or cause a fire. Do not connect resistors to DC terminals (across PA/+-PC/- or across PO-PC/-). It could cause a fire. First shut off input power and wait at least 15 minutes before touching wires on equipment (MCCB) that is connected to inverter power side. Touching the wires before that time could result in electric shock.
 Be grounded	<ul style="list-style-type: none"> Securely connect to ground with a ground wire. If a secure connection to ground is not made, this could cause electric shock or fire when a malfunction or leak current occurs.

2.2.1 Standard connection diagram (1)

This diagram shows a standard wiring of the main circuit.

(1) Sink <common: CC>

■ When using V1/S3 terminal as an analog input terminal (F 109 : 0 or 1)

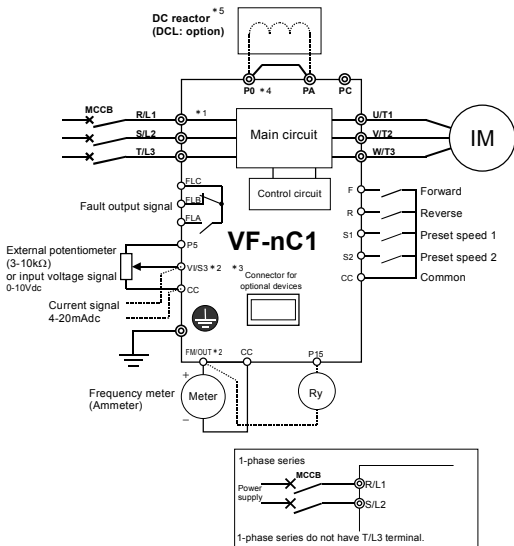

*1: Only European model has a built-in noise filter.

*2: The terminal can be switched between FM/OUT and V1/S3 by changing a parameter.

*3: The terminal can also be used as an input terminal by changing a parameter.

*4: European models are not provided with PO terminal.

*5: 1-phase 100V models cannot be used with DC reactors.

■When using V1/S3 terminal as a logic input terminal (F 109 : 2)

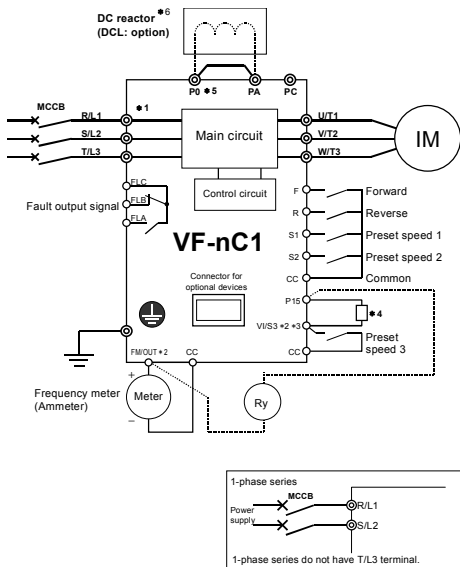

*1: Only European model has a built-in noise filter.

*2: The terminal can be switched between FM/OUT and V1/S3 by changing a parameter.

*3: The terminal can also be used as an input terminal by changing a parameter.

*4: To use V1/S3 terminal as an input terminal, P15 and V1/S3 must be short-circuited with a resistor (recommended resistance: 4.7kΩ-1/4W).

*5: European models are not provided with PO terminal.

*6: 1-phase 100V models cannot be used with DC reactors.

2.2.2 Standard connection diagram (2)

(2) Source <common: P15>

■ When using V1/S3 terminal as an analog input terminal (*F 109 : 0 or 1*)

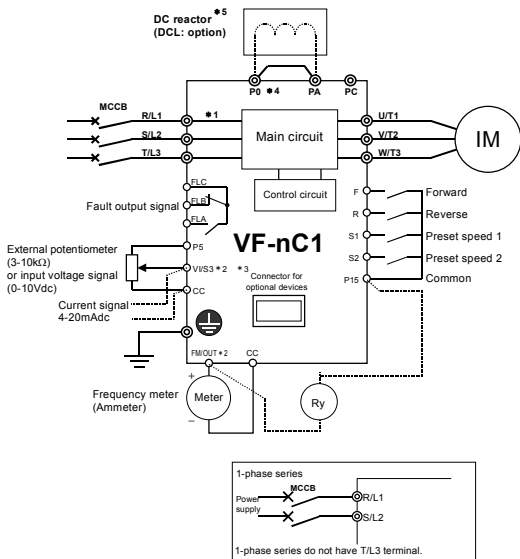

*1: Only European model has a built-in noise filter.

*2: The terminal can be switched between FM/OUT and V1/S3 by changing a parameter.

*3: The terminal can also be used as an input terminal by changing a parameter.

*4: European models are not provided with PO terminal.

*5: 1-phase 100V models cannot be used with DC reactors.

■When using V1/S3 terminal as a logic input terminal (F 109 : 2)

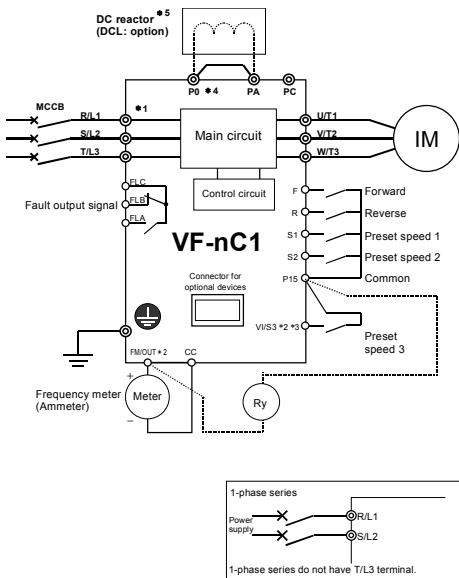

- *1: Only European model has a built-in noise filter.
- *2: The terminal can be switched between FM/OUT and V1/S3 by changing a parameter.
- *3: The terminal can also be used as an input terminal by changing a parameter.
- *4: European models are not provided with PO terminal.
- *5: 1-phase 100V models cannot be used with DC reactors.

2.3 Description of terminals

2.3.1 Main circuit terminals

This diagram shows an example of wiring of the main circuit. Use options if necessary.

■ Power supply and motor connections

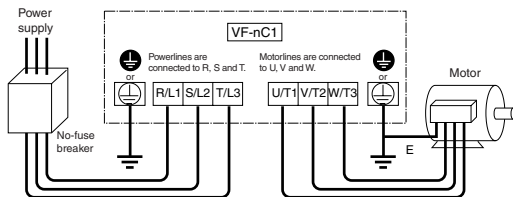

■ Connections with peripheral equipment

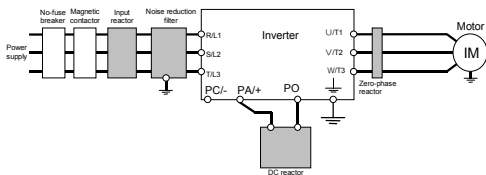

■ Main circuit

Terminal symbol	Terminal function
	Grounding terminal for connecting inverter case. 2 grounding terminals.
R/L1, S/L2, T/L3	100V class: 1-phase 100V to 115V - 50/60Hz 200V class: 1-phase 200V to 240V - 50/60Hz, 3-phase 200V-240V - 50/60Hz *1-phase series have R/L1 and S/L2 terminal.
U/T1, V/T2, W/T3	Connect to a (3-phase induction) motor
PC/-	This is a negative potential terminal in the internal DC main circuit.
PO, PA/+	Terminals for connecting a DC reactor (DCL: optional external device). Shorted when shipped from the factory. Before installing DCL remove the short bar. 1-phase 100V models cannot be used with DC reactors. 1-phase 200V models for Europe are not provided with PO terminal.

2.3.2 Control circuit terminals (sink logic (common: CC))

The control circuit terminal board is the same for all models.

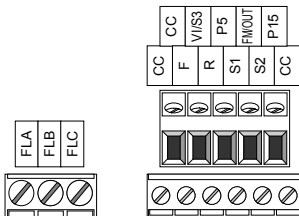

Terminal symbol	Input/output	Function	Specifications	Inverter internal circuit
F	Input	Shorting across F-CC causes forward rotation; open causes slowdown and stop. (If ST is always ON)	Dry contact input 15Vdc - 5mA or less <u>*Sink/source selectable by changing a parameter</u>	
R	Input	Shorting across R-CC causes reverse rotation; open causes slowdown and stop. (If ST is always ON)		
S1	Input	Shorting across S1-CC causes preset speed operation.		
S2	Input	Shorting across S2-CC causes preset speed operation.		
CC	Common to input/output	Control circuit's equipotential terminal.		
P5	Output	Power output for analog input setting.	5Vdc (permissible load current: 10mAdc)	
VI/S3	Input	Multifunction programmable analog input. Standard default setting: Analog input 0-10Vdc and frequency 0-80Hz. Possible to use as analog input (4 (0)-20mA) or contact input (programmable contact input) by changing a parameter.	10Vdc: (internal impedance: 42kΩ) 4-20mA: (internal impedance: 250Ω)	

Terminal symbol	Input/output	Function	Specifications	Inverter internal circuit
FM/OUT	Output	Multifunction programmable output. Standard default setting: output frequency. Meters connectable to FM/OUT: 1mAdc full-scale ammeter or 7.5Vdc (10Vdc) -1mA full-scale voltmeter (PWM output). Possible to switch to programmable open collector output by changing a parameter.	1mA full-scale DC ammeter or 7.5Vdc (10Vdc) full-scale DC voltmeter Open collector output: 24Vdc-50mA	
P15	Output	15Vdc power output. ※For more on how to use, see 6.1.1 and 6.2.6.	15Vdc-100mA	
FLA FLB FLC	Output	Multifunction programmable relay contact output. Contact ratings: 250Vac - 2A (cosφ=1), 30Vdc - 1A, 250Vac - 1A (cosφ=0.4). Standard default setting: Monitoring of status of inverter's protection function. Activation of the protection function causes circuit FLA-FLC to close and circuit FLB-FLC to open.	250Vac-2A (cosφ=1): at resistance load 30Vdc-1A 250Vac-1A (cosφ=0.4)	

■ Sink logic (negative common)/source logic (positive common)

… Logic switching of input/output terminals

Current flowing out turns control input terminals on. These are called sink logic terminals. (For all models except models with a built-in noise filter, control input terminals are factory-set to sink logic.) The general used method in Europe is source logic in which current flowing into the input terminal turns it on.

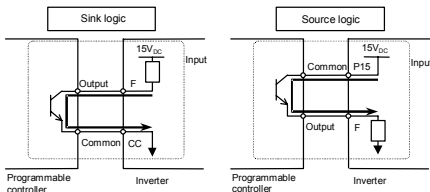

Output terminals cannot be switched between sink logic and source logic.
See the figures below for connection to sink logic and source logic terminals.

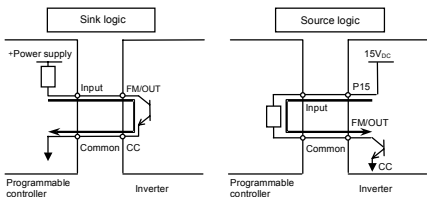

■ Switching the input terminal logic between sink and source

Input terminals of the VF-nC1 inverter can be switched between sink logic and source logic, using the $F127$ parameter.

When switching between sink logic and source logic, do it before connecting cables to inverter's control circuit terminals. When the confirmation message $E50$ or $E51$ is displayed after switching between sink logic and source logic, using the $F127$ parameter, reset the inverter, using the operation panel, by turning the power off, or by inputting a reset signal from an external control device.

■ Switching the VI/S3 terminal between logic input and analog input

The VI/S3 terminal of the VF-nC1 inverter can be switched between contact input and analog input by changing a parameter setting. When switching between contact input and analog input, do it before connecting cables to inverter's control circuit terminals ($F109$).

If switching between contact input and analog input is done after cable connection, the inverter and/or the external device connected might be damaged. Before turning on the inverter, make sure all cables are connected correctly to the control terminals.



When using the VI/S3 terminal as an contact input terminal (sink logic), be sure to insert a resistor* between the P15 and VI/S3 terminals. (Recommended resistance: 4.7kΩ-1/4W).



■ Switching the FM/OUT terminal between meter output (PWM output) and open collector output

The FM/OUT terminal of the VF-nC1 inverter can be switched between meter output (PWM output) and open collector output.

When switching between meter output (PWM output) and open collector output, do it before connecting an external device to the inverter. After switching from meter output (PWM output) to open collector output, and vice versa, check using the $F354$ parameter to be sure that the desired function is assigned to the FM/OUT terminal, and then turn the power off. After the completion of cable connection, turn the power back on. If switching between meter output and open collector output is done after cable connection, the inverter might be damaged.

3. Simple operation

 Warning	
 Prohibited	<ul style="list-style-type: none"> Do not touch inverter terminals when electrical power is connected to the inverter even if the motor is stopped. Touching the inverter terminals while power is connected to it may result in electric shock. Do not touch switches when the hands are wet and do not try to clean the inverter with a damp cloth. Such practices may result in electric shock. Do not go near the motor in alarm-stop status when the retry function is selected. The motor may suddenly restart and that could result in injury. Take measures for safety, e.g. attaching a cover to the motor, against accidents when the motor unexpectedly restarts.
 Mandatory	<ul style="list-style-type: none"> Turn power on only after attaching the front cover or closing door if enclosed in a cabinet. If power is turned on without the front cover attached or closing door if enclosed in a cabinet, that may result in electric shock or other injury. If the inverter begins to emit smoke or an unusual odor, or unusual sounds, immediately turn power off. If the equipment is continued in operation in such a state, the result may be fire. Call your local sales agency for repairs. Always turn power off if the inverter is not used for long periods of time. Turn input power on after attaching the front cover. When enclosed inside a cabinet and using with the front cover removed, always close the cabinet doors first and then turn power on. If the power is turned on with the front cover or the cabinet doors open, it may result in electric shock. Make sure that operation signals are off before resetting the inverter after malfunction. If the inverter is reset before turning off the operating signal, the motor may restart suddenly causing injury.

 Caution	
 Contact prohibited	<ul style="list-style-type: none"> Do not touch heat radiating fins. These devices are hot, and you'll get burned if you touch them.
 Prohibited	<ul style="list-style-type: none"> Always observe the permissible operating ranges of motors and other equipment (see the instruction manual for the motor). If these ranges are not observed, it could result in injury.

3.1 Simple operation of the VF-nC1

The procedures for setting operation frequency and the methods of operation can be selected from the following.

Run / stop

- : (1) Run and stop from the operation panel
- (2) Run and stop using external signals to the terminal block
- (3) Run and stop by serial communications (with an optional external device)

Frequency setting

- : (1) Setting of frequency using the potentiometer on the inverter main unit
- (2) Frequency setting using the UP and DOWN keys on the operation panel
- (3) Setting of frequency using external signals to the terminal block (0-10Vdc, 4-20mA)
- (4) Frequency setting by serial communications (with an optional external device)

Use the basic parameters $CnQd$ (command mode selection) and $FnQd$ (frequency setting mode selection) for selecting.

Title	Function	Adjustment range	Default setting
$CnQd$	Command mode selection	0: Terminal block 1: Operation panel	1
$FnQd$	Frequency setting mode selection	0: Terminal block 1: Operation panel 2: Internal potentiometer 3: Serial communications 4: Terminal block/potentiometer switching	2



[Steps in setting parameters]

Key operated	LED display	Operation
	0.0	Displays the operation frequency (operation stopped). (When standard monitor display selection $F7IQ=0$ is set to [Operation frequency])
(MON)	RUH	The first basic parameter "History (RUH)" is displayed.
(▲) (▼)	$CnQd$	Press either the ▲ key or the ▼ key to select " $CnQd$."
(ENT)	1	Press the ENTER key to display the parameter setting. (Standard default setting: 1)
(▲) (▼)	0	Change the parameter to 0 (Terminal board) by pressing the ▲ key.
(ENT)	$0 \Leftrightarrow CnQd$	Press the ENTER key to save the changed parameter. $CnQd$ and the parameter set value are displayed alternately.
(▲) (▼)	$FnQd$	Press either the ▲ key or the ▼ key to select " $FnQd$."
(ENT)	2	Press the ENTER key to display the parameter setting. (Standard default setting: 2)
(▲) (▼)	1	Change the parameter to 1 (Operation panel) by pressing the ▼ key
(ENT)	$1 \Leftrightarrow FnQd$	Press the ENTER key to save the changed parameter. $FnQd$ and the parameter set value are displayed alternately.

* Pressing the MON key twice returns the display to standard monitor mode (displaying operation frequency).

3.1.1 How to start and stop

(1) Start and stop using the operation panel keys (CNOd : 1)

Use the  and  keys on the operation panel to start and stop the motor.

 : Motor starts.

 : Motor stops (slowdown stop).

(2) Start and stop using external signals to the terminal board (CNOd : 0)

Use external signals to the inverter terminal board to start and stop the motor. (Sink logic connection)

Short F and CC terminals: run forward

Open F and CC terminals: slow down and stop



★Coast stop

The standard default setting is for slowdown stop. To make a coast stop, assign an ST terminal function to an idle terminal using the programmable terminal function. For coast stop, open the ST-CC when stopping the motor in the state described at left. The monitor on the inverter at this time will display *0FF*.

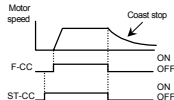

3.1.2 How to set the frequency

(1) Setting the frequency using the potentiometer on the inverter main unit (FNOd : 2)

Set the frequency with the notches on the potentiometer.





Move clockwise through the higher notches for the higher frequencies.





Since the potentiometer has hysteresis, its settings may change to some degree after the power is turned off and turned back on.

(2) Setting the frequency using the operation panel (FNOd : 1)

Set the frequency from the operation panel.

 : Moves the frequency up

 : Moves the frequency down
Example of operating a run from the panel

Key operated	LED display	Operation
	0.0	Displays the operation frequency. (When standard monitor display selection F710=0 is set to 0 (operation frequency))
 	50.0	Set the operation frequency.
	50.0 ⇄ Fc	Press the ENTER key to save the operation frequency setting. Fc and the frequency are displayed alternately.
 	60.0	Pressing the Δ key or the ∇ key will change the operation frequency even during operation.

* Press the ENTER key after changing the operation frequency, otherwise it will not be saved, although it is displayed.

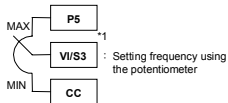
(3) Setting the frequency using external signals to the terminal board (FNOd : 0)**Frequency setting****1) Setting the frequency using external potentiometer****★Potentiometer control**

Set frequency using the potentiometer (3-10k Ω -1/4W)
For more detailed information on adjustments, see 6.4.



* The F109 parameter (VI/S3 terminal function selection) is used to specify a function for the VI/S3 input terminal. The FCHG parameter (frequency command forced switching) makes it possible to use both the analog input frequency signal and the frequency signal set with the internal potentiometer, which can be switched by activating or deactivating the input terminals.
See 5.1 for details.

* It is necessary to set the F203 (=47~50 approx.) in case of using the potentiometer with P5.

Note: The current input and voltage input functions cannot be used at the same time.

2) Setting the frequency using input voltage (0-10V)

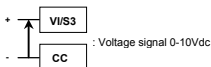

★Voltage signal

Setting frequency using voltage signals (0-10V). For more detailed information on adjustments, see 6.4.

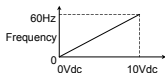

- * The $FREQ$ parameter (VI/S3 terminal function selection) is used to specify a function for the VI/S3 input terminal. The FCHG parameter (frequency command forced switching) makes it possible to use both the analog input frequency signal and the frequency signal set with the internal potentiometer, which can be switched by activating or deactivating the input terminals. See 5.1 for details.

Note: The current input and voltage input functions cannot be used at the same time.

3) Setting the frequency using current input (4-20mA)

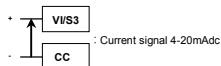

★Current signal

Setting frequency using current signals (4-20mA). For more detailed information on adjustments, see 6.4.

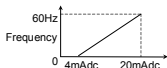

- * The $FREQ$ parameter (VI/S3 terminal function selection) is used to specify a function for the VI/S3 input terminal. The FCHG parameter (frequency command forced switching) makes it possible to use both the analog input frequency signal and the frequency signal set with the internal potentiometer, which can be switched by activating or deactivating the input terminals. See 5.1 for details.

Note: The current input and voltage input functions cannot be used at the same time.

(4) Setting the frequency by serial communications ($FREQ$: 3)

The frequency can also be set from a higher-order external control device via optionally available communications conversion units (RS2001Z, RS20035, RS2002Z and RS4001Z).

4. Basic VF-nC1 operations

The VF-nC1 has the following three monitor modes.

Standard monitor mode : The standard inverter mode. This mode is enabled when inverter power goes on.

After mode is for monitoring the output frequency and setting the frequency designated value by UP/DOWN key of operation panel. In it is also displayed information about status alarms during running and trips.

- Setting frequency designated values - see 3.1.2
- Status alarm

If there is an error in the inverter, the alarm signal and the frequency will flash alternately in the LED display.

Ⓛ : When a current flows at or higher than the overcurrent stall level.

P : When a voltage is generated at or higher than the over voltage stall level.

L : When a load reaches 50% or higher of the overload trip value.

H : When temperature inside the inverter rises to the overheating protection alarm level.

All VF-nC1 series of inverters: About 110°C

Setting monitor mode : The mode for setting inverter parameters.

For more on how to set parameters, see 4.1.

Status monitor mode : The mode for monitoring all inverter status.

Allows monitoring of set frequencies, output current/voltage and terminal information.

For more on how to use the monitor, see 8.1.

Pressing the **(MON)** key will move the inverter through each of the modes.

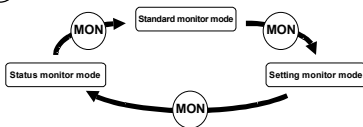

4.1 How to set parameters

Setting monitor mode

The standard default parameters are programmed before the unit is shipped from the factory. Parameters can be divided into three major categories. Select the parameter to be changed or to be searched and retrieved.

Setup parameters : Parameters necessary for specifying a logic for control input signals and a base frequency for the motor when turning on the inverter for the first time.

This parameter setting is needed only for the VFNC1 (S)-□□□□P - W.

Basic parameters : Parameters necessary for operating the inverter.

Extended parameters : Parameters necessary for using various extended functions.

Special parameters : Parameters necessary for using special functions. Three special parameters are included in the basic parameters of the VF-nC1.

*1: Three special parameters

RUF : Calls up only functions necessary to meet the user's needs and, sets up the inverter.

RUH : Displays the five parameters changed last in reverse order of change. This parameter comes in very handy when readjusting inverter, using the same parameters.

Gr.U : Displays parameters whose settings are different from the factory default settings. Use this parameter to check settings you made or you want to change.

★Adjustment range of parameters

H I : An attempt has been made to assign a value that is higher than the programmable range. Or, as a result of changing other parameters, the programmed value of the parameter that is now selected exceeds the upper limit.

L O : An attempt has been made to assign a value that is lower than the programmable range. Or, as a result of changing other parameters, the programmed value of the parameter that is now selected exceeds the lower limit.

If the above alarm is flashing on and off, no setting can be done of values that are equal to or greater than *H I* or equal to or lower than *L O*.

While these codes are flashing on and off, no change can be made to any parameter.

4.1.1 How to set a setup parameter



Setup parameter

After you set the basic parameter tYP to 3 (Initialize to default setting) or the first power, the inverter will be in setup parameter mode. When the inverter is in this mode, you need to set a setup parameter, as described below, to make the inverter ready for operation.

Set the setup parameter according to the logic for control input signals used and the base frequency of the motor connected. (If you are not sure which setup parameter should be selected among $n50$, $P50$ and $n60$ and what values should be specified, consult your reseller.) Each setup parameter automatically sets all parameters relating to the logic for control input signals used and the base frequency of the motor connected.

This parameter setting is needed only for the VFNC1 (S)-□□□□P□-W.

Follow these steps to change the setup parameter [Example: Changing from $n50$ to $n60$: sink logic (negative common) and a base frequency of 60Hz]

Key operated	LED display	Operation
	$n50$	Turn the power on.
 	$n60$	Select a parameter among $n50$, $P50$ and $n60$, using the Δ and ∇ keys. Select $n60$ in this case.
	$in it$	Press the ENTER key to confirm your change. When $in it$ is displayed, you can set the setup parameter.
	0.0	The operation frequency is displayed (Standby).

- ★ You can change this parameter setting. To do so, you need to reset the basic parameter tYP to 3 (default setting).
- ★ You can also change the parameters in the table below individually even after setting a setup parameter.

The settings of the parameters listed below are changed by the setup parameter. When you search for CrU parameters, only the parameters in the shaded area will be displayed as changed parameters.

■ Values set by each setup parameter

Parameters set	$n50$ (Mainly in Asia)	$P50$ (Mainly in Europe)	$n60$ (Mainly in North America)
$F127$	0 [Sink logic (negative common)]	100 [Source logic (positive common)]	0 [Sink logic (negative common)]
$F409/F171$	220 (V)	220 (V)	230 (V)
$F417$	1410 (min ⁻¹)	1410 (min ⁻¹)	1710 (min ⁻¹)
$FH.U.L.F204$	50.0 (Hz)	50.0 (Hz)	60.0 (Hz)
$wLIF170$	50.0 (Hz)	50.0 (Hz)	60.0 (Hz)

4.1.2 How to set the basic parameters

Basic parameters

All of the basic parameters can be set by the same step procedures.

[Steps in key entry for basic parameters]

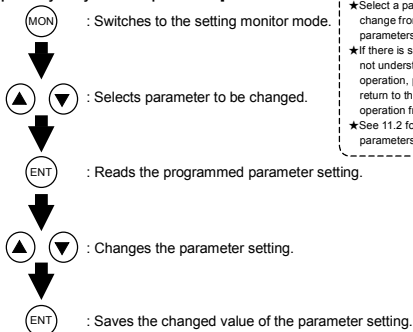

- ★ Select a parameter you want to change from the table of parameters.
- ★ If there is something that you do not understand during the operation, press the MON key to return to the 0.0 indication (or operation frequency).
- ★ See 11.2 for the table of basic parameters.

Steps in setting are as follows (the example shown is one of changing the maximum frequency from 80Hz to 60Hz).

Key operated	LED display	Operation
	0.0	Displays the operation frequency (operation stopped). (When standard monitor display selection $F \uparrow 0 = 0$ is set to 0 [operation frequency]).
(MON)	RUH	The first basic parameter "History (RUH)" is displayed.
(▲) (▼)	FH	Press either the ▲ key or the ▼ key to select "FH".
(ENT)	80.0	Pressing the ENTER key reads the maximum frequency.
(▲) (▼)	60.0	Press the ▼ key to change the maximum frequency to 60Hz.
(ENT)	60.0 \leftrightarrow FH	Press the ENTER key to save the changed maximum frequency. FH and frequency are displayed alternately.
After this (ENT)	\rightarrow Displays the same programmed parameter.	(MON) \rightarrow Switches to the display in the status monitor mode. (▲) (▼) \rightarrow Displays names of other parameters.

4.1.3 How to set extended parameters

The VF-nC1 has extended parameters to allow you to make full use of its functions. All extended parameters are expressed with *F* and three digits.

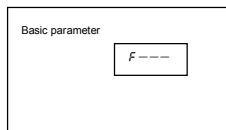

F 100~F 173
 F 200~F 294
 F 300~F 363
 F 400~F 419
 F 500~F 505
 F 600~F 633
 F 700~F 710
 F 800~F 880

Press the MON key once and use the ▲ key and the ▼ key to select "F ---" from the basic parameters.

Press the ▲ key and the ▼ key to select the parameter to be changed. Then, press the ENTER key to display the set parameter.

[Steps in key entry for extended parameters]

- : Switches to the setting monitor mode. (displays *R U H*)
 - : Selects "F ---" from basic parameters.
 - : Displays the first extended parameter.
 - : Selects the extended parameter to be changed.
 - : Reads the programmed parameter setting.
 - : Changes the parameter setting.
 - : Saves the changed value of the extended parameter setting.
- Pressing the key instead of the key moves back to the previous status.

★ See 11.3 for the table of extended parameters.

■ Example of parameter setting

The steps in setting are as follows. (Example of changing the starting frequency selection $F240$ from 0.5 to 1.0 .)

Key operated	LED display	Operation
	0.0	Displays the operation frequency (operation stopped). (When standard monitor display selection $F710=0$ is set to (operation frequency))
(MON)	RUH	The first basic parameter "History (RUH)" is displayed.
(▲) (▼)	F---	Press either the ▲ key or the ▼ key to change to the parameter group F---.
(ENT)	F100	Press the ENTER key to display the first extended parameter $F100$.
(▲) (▼)	F240	Press the ▲ key to change to the dynamic braking selection $F240$.
(ENT)	0.5	Pressing the ENTER key allows the reading of parameter setting.
(▲) (▼)	1.0	Press the ▲ key to change the dynamic braking selection from 0.5Hz to 1.0Hz
(ENT)	1.0 ⇔ F240	Pressing the ENTER key alternately flashes on and off the parameter and changed value and allows the save of those values.

If there is anything you do not understand during this operation, press the (MON) key several times to start over from the step of RUH display.

4.1.4 How to set (use) special parameters

(1) Setting a parameter, using the wizard function (RUF)

Wizard function (RUF):

The wizard function refers to the special function of calling up only functions necessary to set up the inverter in response to the user's needs. When a purpose-specific wizard is selected, a group of parameters needed for the specified application (function) is formed and the inverter is switched automatically to the mode of setting the group of parameters selected. You can set up the inverter easily by simply setting the parameters in the group one after another. The wizard function (RUF) provides four purpose-specific wizards.

Title	Function	Adjustment range	Default setting
RUF	Wizard function	0 : - 1 : Basic setting wizard 2 : Preset speed operation wizard 3 : Analog signal operation wizard 4 : Motor 1/2 switching operation wizard 5 : Torque up wizard*	0

* This parameter is valid only for VFNC1 (S)-□□□□□-W type.

■ How to use the wizard function

Here are the steps to follow to set parameters, using the wizard function. (When the basic setting wizard (*RUF*) is set to 1)

Key operated	LED display	Operation
	<i>0.0</i>	Displays the operation frequency (operation stopped). (When standard monitor display selection <i>F 7 1 0</i> = <i>0</i> is set to 0 [operation frequency]).
(MON)	<i>RUH</i>	The first basic parameter "History (<i>RUH</i>)" is displayed.
(▲) (▼)	<i>RUF</i>	Select the wizard function (<i>RUF</i>) by pressing the ▲ or ▼ key.
(ENT)	<i>0</i>	Press the ENTER key to confirm your choice. <i>0</i> is displayed.
(▲) (▼)	<i>i</i>	Switch to purpose-specific wizard <i>i</i> by pressing the ▲ or ▼ key.
(ENT)	<i>[n d</i>	Press the ENTER key to confirm your choice. The first parameter in the purpose-specific wizard parameter group is displayed. (See Table below)
(▲) (▼)	<i>***</i>	After moving to the purpose-specific wizard parameter group, change the setting of each parameter by pressing the ▲ or ▼ key and the ENTER key.
	<i>E n d</i>	<i>E n d</i> is dialed on completion of the setting of the wizard parameter group.
(MON) (MON) (MON)	Display of parameter ↓ <i>RUF</i> ↓ <i>F r - F</i> ↓ <i>0.0</i>	Press the MON key to exit the wizard parameter group. By pressing the MON key, you can return to the default monitoring mode (display of operation frequency).

If there is anything you do not understand during this operation, press the (MON) key several times to start over from the step of *RUH* display.
HE R d or *E n d* is affixed respectively to the first or last parameter in each wizard parameter group.

Table of parameters that can be changed using the wizard function

Basic setting wizard	Preset-speed setting wizard	Analog input operation wizard	Motor 2 switching operation wizard	Torque UP wizard*
<i>E n d</i>	<i>E n d</i>	<i>E n d</i>	<i>F 1 1 1</i>	<i>u L</i>
<i>F n d</i>	<i>F n d</i>	<i>F n d</i>	<i>F 1 1 2</i>	<i>P L</i>
<i>R C C</i>	<i>R C C</i>	<i>R C C</i>	<i>F 1 1 3</i>	<i>F 4 0 1</i>
<i>d E C</i>	<i>d E C</i>	<i>d E C</i>	<i>F 1 1 4</i>	<i>F 4 0 9</i>
<i>F H</i>	<i>F H</i>	<i>F H</i>	<i>u L</i>	<i>F 4 1 5</i>
<i>u L</i>	<i>u L</i>	<i>u L</i>	<i>F 4 0 9</i>	<i>F 4 1 7</i>
<i>F 4 0 9</i>	<i>F 1 0 9</i>	<i>L L</i>	<i>u b</i>	
	<i>F 1 1 1</i>	<i>F 1 0 9</i>	<i>F 4 1 5</i>	
	<i>F 1 1 2</i>	<i>F 2 0 1</i>	<i>t M r</i>	
	<i>F 1 1 3</i>	<i>F 2 0 2</i>	<i>R C C</i>	
	<i>F 1 1 4</i>	<i>F 2 0 3</i>	<i>d E C</i>	
	<i>F 1 1 5</i>	<i>F 2 0 4</i>	<i>F 1 7 0</i>	
	<i>S r 1</i>		<i>F 1 7 1</i>	
	<i>S r 2</i>		<i>F 1 7 2</i>	
	<i>S r 3</i>		<i>F 1 7 3</i>	
	<i>S r 4</i>		<i>F S 0 0</i>	
	<i>S r 5</i>		<i>F S 0 1</i>	
	<i>S r 6</i>			
	<i>S r 7</i>			
	<i>S r 8</i>			
	<i>F 2 8 7</i>			
	<i>F 2 8 8</i>			
	<i>F 2 8 9</i>			
	<i>F 2 9 0</i>			
	<i>F 2 9 1</i>			
	<i>F 2 9 2</i>			
	<i>F 2 9 3</i>			
	<i>F 2 9 4</i>			

* This parameter is valid only for VFNC1 (S)-□□□□□-W type.

(2) Searching for a history of changes, using the history function (R U H)

History function (R U H)

The history function automatically searches for the five parameters set or changed last and displays them in reverse order of setting or change. This parameter can also be used to set or change parameters.

Notes

- Parameters set or changed using the setup parameter also are included among parameters displayed.
- H E R d and E n d are added respectively to the first and last parameters in a history of changes.

4

■ How to use the history function

Key operated	LED display	Operation
	0.0	Displays the operation frequency (operation stopped). (When standard monitor display selection F 7 I 0 = 0 is set to 0 [operation frequency]).
(MON)	R U H	The first basic parameter "History (R U H)" is displayed.
(ENT)	R C C	Press the ENTER key to search for and display the next parameter set or changed last.
(ENT)	8.0	Press the ENTER key to display the setting of the parameter found.
(▲) (▼)	5.0	Change the setting by pressing the ▲ or ▼ key.
(ENT)	5.0 ↔ R C C	Press the ENTER key to confirm the new setting. The name and new setting of the parameter are displayed alternately and the setting is saved.
(▲) (▼)	***	Similarly, press the ▲ or ▼ key to display the parameter you want to set or change next, and change and confirm the setting.
(▲) (▼)	E n d	On completion of a search for all parameters, E n d is displayed again.
(MON) (MON) (MON)	Display of parameter ↓ R U H ↓ F r - F ↓ 0.0	To abort the search operation, press the MON key. Press the MON key once during a search to return to setting mode. Similarly, by pressing the MON key, you can go back to the status monitor mode and default monitor mode (display of operation frequency).

(3) Searching for and changing parameters, using the user parameter group function $\bar{U}r.U$

User parameter group function ($\bar{U}r.U$):

















The user parameter group function automatically searches for only parameters whose settings are different from the factory default settings, and displays them as $\bar{U}r.U$ parameters. This parameter can also be used to set and change parameters in $\bar{U}r.U$.

Notes

- Parameters that have been returned to their factory default settings are not displayed as $\bar{U}r.U$ parameters.
- Parameters that have been set using the setup parameter are also displayed as $\bar{U}r.U$ parameters.

■ How to search for and change parameters

Follow the steps below to search for and change parameters.

Key operated	LED display	Operation
	0.0	Displays the operation frequency (operation stopped). (When standard monitor display selection $F7:ID=0$ is set to 0 [operation frequency]).
	RUH	The first basic parameter "History (RUH)" is displayed.
 	$\bar{U}r.U$	Select $\bar{U}r.U$ by pressing Δ or ∇ key.
	$U---$	Press the ENTER key to enter the user parameter search/ setting change mode.
 or  	$U--F$ ($U--r$) RCC	Parameters whose settings are different from the factory default setting are searched for and displayed. To change the parameter displayed, press the ENTER key or the Δ key. (Press the ∇ key to make a search in the reverse direction.)
	8.0	Press the ENTER key to display the setting.
 	5.0	Change the setting by pressing the Δ or ∇ key.
	$5.0 \leftrightarrow RCC$	Press the ENTER key to confirm the new setting. The name and new setting of the parameter are displayed alternately, and the setting is saved.
 ()	$U--F$ ($U--r$)	Similarly, press the Δ or ∇ key to display the parameter you want to set or change next, and change and confirm the setting.
 ()	$\bar{U}r.U$	On completion of a search for all parameters, $\bar{U}r.U$ is displayed again.
 	Display of parameter \downarrow $F--F$ \downarrow 0.0	To abort the search operation, press the MON key. Press the MON key once during a search to return to the setting mode. Similarly, by pressing the MON key, you can go back to the status monitor mode and default monitor mode (display of operation frequency).

If you feel puzzled as to how to operate, press the  key several times to go back to the step where RUH is displayed, and perform these steps all over again.

4.1.5 Parameters that cannot be changed while running

For reasons of safety, the following parameters have been set up so that they cannot be reprogrammed while the inverter is running.

[Basic parameters]

<i>C P 0 d</i> (Command mode selection)	} Set <i>F 7 0 0</i> , and <i>C P 0 d</i> and <i>F P 0 d</i> can be changed while the inverter is running.
<i>F P 0 d</i> (Frequency setting mode selection)	
<i>t Y P</i> (Standard setting mode selection)	
<i>F H</i> (Maximum frequency (Hz))	
<i>u L</i> (Base frequency 1 (Hz))	<i>F 2 5 1</i> (DC braking current (%))
<i>P t</i> (V/f control mode selection)	<i>F 3 0 0</i> (PWM carrier frequency)
	<i>F 3 0 1</i> (Auto-restart control selection)
	<i>F 3 0 2</i> (Regenerative power ride-through control)

[Extended parameters]

<i>F 1 0 9</i> (Analog input/logic input function selection)	<i>F 3 0 5</i> (Over voltage limit operation)
<i>F 1 1 0</i> (Always active function selection (ST))	<i>F 4 0 1</i> (Slip frequency gain)
<i>F 1 1 1</i> (Input terminal selection 1 (F))	<i>F 4 0 9</i> (Base frequency voltage 1 (V))
<i>F 1 1 2</i> (Input terminal selection 2 (R))	<i>F 4 1 5</i> (Motor rated current)
<i>F 1 1 3</i> (Input terminal selection 3 (S1))	<i>F 4 1 6</i> (Motor no-load current)
<i>F 1 1 4</i> (Input terminal selection 4 (S2))	<i>F 4 1 7</i> (Motor rated speed)
<i>F 1 1 5</i> (Input terminal selection 5 (V/S3))	<i>F 4 1 8</i> (Speed control gain)
<i>F 1 2 7</i> (Sink/Source selection)	<i>F 4 1 9</i> (Speed control stable coefficient)
<i>F 1 3 0</i> (Output terminal selection 1 (OUT/FM))	<i>F 6 0 1</i> (Stall prevention level)
<i>F 1 3 2</i> (Output terminal selection 3 (FL))	<i>F 6 0 3</i> (External input trip stop mode selection)
<i>F 1 7 0</i> (Base frequency 2 (Hz))	<i>F 6 0 8</i> (Input phase failure detection mode selection)
<i>F 1 7 1</i> (Base frequency voltage 2 (V))	<i>F 6 2 7</i> (Under voltage trip selection)

4.1.6 Returning all parameters to standard default setting

Setting the standard default setting parameter $\xi Y P$ to 3, all parameters can be returned to the those factory default settings.

Note: For more details on the standard default setting parameter $\xi Y P$, see 5.3.

Notes on operation

- We recommend that before this operation you write down on paper the values of those parameters, because when setting $\xi Y P$ to 3, all parameters with changed values will be returned to standard factory default setting.

■ Steps for returning all parameters to standard default setting

Key operated	LED display	Operation
	0.0	Displays the operation frequency (perform during operation stopped).
(MON)	R U H	The first basic parameter "History (R U H)" is displayed.
(▲) (▼)	$\xi Y P$	Press the ▲ key or the ▼ key to change to $\xi Y P$.
(ENT)	3 0	Pressing the ENTER key displays the programmed parameters. ($\xi Y P$ will always display zero "0" on the right, the previous setting on the left.)
(▲) (▼)	3 3	Press the ▲ key or the ▼ key to change the set value. To return to standard factory default setting, change to "3".
(ENT)	i n i t	Pressing the ENTER key displays " i n i t " while returning all parameters to factory default setting.
	n 5 0	Turn the power on.
(▲) (▼)	n 6 0	Select a parameter among n 5 0, P 6 0 and n 6 0, using the ▲ and ▼ keys. Select n 6 0 in this case.
(ENT)	i n i t	Press the ENTER key to confirm your change. When i n i t is displayed, you can set the setup parameter.
	0.0	The operation frequency is displayed (Standby).
	0.0	The operation frequency is displayed again.

If there is something that you do not understand during this operation, press the (MON) key several times and start over again from the step of R U H display.

5. Basic parameters

Basic parameters refer to parameters you have to set first before using the inverter.

5.1 Selecting an operation mode

Cmd : Command mode selection

Fnd : Frequency setting mode selection

• Function

Cmd (command mode selection) :

Used to select a mode of entering Run and Stop commands from the inverter (operation panel or terminal board).

Fnd (frequency setting mode selection) :



Used to select a mode of entering frequency setting commands from the inverter (internal potentiometer, operation panel, terminal board, serial communications with an external control device, or internal potentiometer/terminal board switching).

<Command mode selection>

Title	Function	Adjustment range	Default setting
Cmd	Command mode selection	0: Terminal block 1: Operation panel	1

[Settings]

0 :  A Run or Stop command is entered by inputting an ON or OFF signal from an external control device.

1 :  A Run or Stop command is entered by pressing the  or  key on the operation panel.
(When an optional expansion operation panel is used)

* There are two kinds of functions: function of responding to signals from the device specified with the **Cmd** parameter, and function of responding to singles from the terminal board only.

Cmd =1	External input signal	Function
	Input terminal function 12 (PNL/TB) OFF	Operation panel operation
	Input terminal function 12 (PNL/TB) ON	Terminal board operation



* When the highest-priority command is entered from an external control device or a terminal block, it takes priority over commands from the device specified with the **Cmd** parameter.

<Frequency setting mode selection>

Title	Function	Adjustment range	Default setting
Fnd	Frequency setting mode selection	0: Terminal block 1: Operation panel 2: Internal potentiometer 3: Serial communications (with an optional control device) 4: Terminal block/internal potentiometer switching	2

[Settings]

0 :  A frequency setting command is entered by inputting a signal* from an external control device. (*: V1/S3 terminal: 0~(5)10Vdc or 4~20mAdc)

1 :  The operation frequency is set by pressing the  or  key on the operation panel or an expansion operation panel (optional).

2 :  The operation frequency is set using the internal potentiometer built into the inverter. Turning the knob clockwise increases the frequency.

3 :  The operation frequency is set by serial communications with an optional control device.

4 :  Switching between frequency setting by means of analog signals and that by means of the internal potentiometer is done by activating or deactivating the input terminals (multi-function programmable input terminals).

☆The following control input terminals are always operative, no matter how the $\mathcal{C}nQd$ parameter (command mode selection) and the $FnQd$ parameter (frequency setting mode selection) are set.

- Reset terminal (enabled only when a trip occurs.)
- Standby terminal
- External input trip stop terminal

☆Before changing the setting of the $\mathcal{C}nQd$ parameter (command mode selection) or the $FnQd$ parameter (frequency setting mode selection), be sure to put the inverter out of operation. (When $F1Qd$ is set to 2, the settings of these parameters can be changed even during operation.)

- There are two kinds of functions: function of responding to signals from the device specified with the $FnQd$ parameter and function of responding to signals from the terminal board only.
- When the highest-priority command is entered from an external device or a terminal board, it takes priority over commands from the device specified with the $FnQd$ parameter.

$FnQd=0$	VI input	
$FnQd=1$	PNL/TB:OFF	UP and DOWN keys on operation panel
	PNL/TB:ON	VI input $\mathcal{C}nQd$: Terminal board
$FnQd=2$	PNL/TB:OFF	Internal potentiometer
	PNL/TB:ON	VI input $\mathcal{C}nQd$: Terminal board
$FnQd=3$	PNL/TB:OFF	Serial communications
	PNL/TB:ON	VI input $\mathcal{C}nQd$: Terminal board
$FnQd=4$	FCHG:OFF PNL/TB:OFF	Internal potentiometer
	FCHG:ON PNL/TB:OFF	VI input
	PNL/TB:ON	VI input
	PNL/TB:ON	VI input $\mathcal{C}nQd$: Terminal board

* To switch between current input and voltage input, use the $F1Q9$ parameter (Analog input / logic input function selection).

5.2 Meter setting and adjustment

$FnSL$: FM/OUT terminal functions selection

Fn : Meter adjustment

• Function

The FM/OUT terminal can be switched between meter output (PWM output) and open collector. When connecting a meter to the FM/OUT terminal, set the $FnSL$ parameter to a number other than -1 (open collector output) and connect the meter between FM/OUT (positive side) and CC (negative side).

If you want to connect a meter to the inverter, choose a full-scale 0~1mAdc ammeter or a full-scale 0~7.5Vdc-1mA voltmeter.

The meter output of VFNC1 may have some errors because of PWM waveform. Especially if the meter output is near 0, the errors may be increased.

■ Adjustment scale with meter adjustment $F\bar{n}$ parameter

Connect meters as shown below.

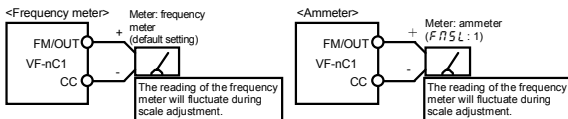

☆Optional frequency meter: QS-60T

☆Make the maximum ammeter scale at least 150 percent of the inverter's rated output current.

[Connected meter selection parameters]

Title	Function	Adjustment range	Default setting
$F\bar{n}S\bar{L}$	Meter selection	-1 : Open collector output 0 : Output frequency 1 : Output current 2 : Set frequency 3 : For adjustment (current fixed at 100%) 4 : For adjustment (current fixed at 50%) 5 : For adjustment (output fixed at the max frequency) 6 : For adjustment (gain display)	0

■ Resolution

All FM terminals have a maximum of 1/256

[Example of how to adjustment the FM terminal frequency meter]

* Use the meter's adjustment screw to pre-adjust zero-point.

Key operated	LED display	Operation
-	60.0	Displays the operation frequency. (When standard monitor display selection $F\bar{7}I\bar{0}$ is set to 0 [operation frequency])
(MON)	RUH	The first basic parameter "RUH" is displayed.
(▲) (▼)	$F\bar{n}$	Press either the ▲ key or the ▼ key to select " $F\bar{n}$."
(ENT)	60.0	Press the ENTER key to confirm your choice. A value corresponding to the setting of $F\bar{n}S\bar{L}$ (FM/OUT terminal functions selection) is displayed.
(▲) (▼)	60.0	Press the ▲ key or the ▼ key to adjust the meter. The meter reading will change at this time but be careful because there will be no change in the inverter's digital LED (monitor) indication.
(ENT)	60.0 ↔ $F\bar{n}$	The adjustment is complete. $F\bar{n}$ and the frequency are displayed alternately.
(MON) (MON)	60.0	The display returns to its original indications (displaying the operation frequency). (When standard monitor display selection $F\bar{7}I\bar{0}$ is set to 0 [operation frequency].)

[Hint]
It's easier to make the adjustment if you push and hold for several seconds.

■ Adjusting the meter in inverter stop state

If, when adjusting the meter for output current, there are large fluctuations in data during adjustment, making adjustment difficult, the meter can be adjusted in inverter stop state.

If $F\bar{n}S\bar{L}$ is set to 3 "for adjustment (current fixed at 100%)", the inverter puts out signals via the FM / OUT terminal, assuming that 100% of current (inverter's rated current) is flowing. In this state, adjust the meter with the $F\bar{n}$ (Meter adjustment) parameter. ($F\bar{n}S\bar{L} : 4, 5, 6, 7$ can be adjusted in the same way.)

After meter adjustment is ended, set $F\bar{n}S\bar{L}$ to 1 (output current).

5.3 Standard default setting

ⓧ : Standard setting mode selection

• Function

Allows setting of all parameters to the standard default setting, etc. at one time. (Except the setting of $F\beta$)

Title	Function	Adjustment range	Default setting
ⓧ	Standard setting mode selection	0 : - 1 : Default setting 50Hz 2 : Default setting 60Hz 3 : Default setting 4 : Trip clear 5 : Cumulative operation time clear	0

★ This function will be displayed as 0 during reading on the right. This previous setting is displayed on the left.

Ex. ⓧ

★ ⓧ cannot be set during the inverter operating. Always stop the inverter first and then program.

[Setting values]

50Hz standard setting ($\text{ⓧ}=1$)

To set the following parameters for a base frequency of 50Hz, set the ⓧ parameter to 1. (This setting does not affect the settings of any other parameters.)

- Maximum frequency FH : 50Hz
- Base frequency $2F170$: 50Hz
- VI/S3 point 2 frequency $F204$: 50Hz
- Base frequency $1\omega L$: 50Hz
- Upper limit frequency UL : 50Hz
- Motor rated speed $F417$: 1410min⁻¹

60Hz standard setting ($\text{ⓧ}=2$)

To set the following parameters for a base frequency of 60Hz, set the ⓧ parameter to 2. (This setting does not affect the settings of any other parameters.)

- Maximum frequency FH : 60Hz
- Base frequency $2F170$: 60Hz
- VI/S3 point 2 frequency $F204$: 60Hz
- Base frequency $1\omega L$: 60Hz
- Upper limit frequency UL : 60Hz
- Motor rated speed $F417$: 1710min⁻¹

Default setting ($\text{ⓧ}=3$)

Setting ⓧ to 3 will return all parameters to the standard values that were programmed at the factory.

☆ When 3 is programmed, [In I] will be displayed for a short time after setting and will then be erased and displayed the original indication "n 50" (Setup parameter). (Only for VFNC1 (S)-□□□□P□-W type) This setting clears all trip history data but it does not clear cumulative operation time data. This setting does not affect the settings of the following parameters.

- FM/OUT terminal functions selection $F\beta 5L$
- Meter adjustment $F\beta$
- Analog input/logic input function selection $F109$
- Sink/source selection $F127$
- Free notes $F880$

See 4.1.1 for setting of setup parameters.

Trip clear ($\text{ⓧ}=4$)

Setting ⓧ to 4 initializes the past four sets of recorded error history data.

* (The parameter does not change.)

Cumulative operation time clear ($\text{ⓧ}=5$)

Setting ⓧ to 5 allows the initial resetting of the cumulative operation time monitor (0 [zero] time).

* (The parameter does not change.)

5.4 Selecting forward and reverse runs (operation panel only)

F_r : Forward/reverse selection (Operation panel)

• **Function**

Program the direction of rotation when the running and stopping are made using the RUN key and STOP key on the operation panel. Valid when \overline{CND} (command mode) is set to 1 (operation panel).

[Parameter setting]

Title	Function	Adjustment range	Default setting
F_r	Forward/reverse selection (Operation panel)	0: Forward run 1: Reverse run	0

★ Check the direction of rotation on the status monitor.

$F_r - F$: Forward run $F_r - r$: Reverse run ⇒ For monitoring, see 8.1.

★ When the F and R terminals are used for switching between forward and reverse rotation from the terminal board, the F_r forward/reverse run selection is rendered invalid.

Short across the F-CC terminals: forward rotation

Short across the R-CC terminals: reverse rotation

★ This function is valid only when \overline{CND} is set to 1 (operation panel).

5.5 Setting acceleration/deceleration time

ACC : Acceleration time 1 (s)

DEC : Deceleration time 1 (s)

• **Function**

- 1) For acceleration time ACC , program the time that it takes for the inverter output frequency to go from 0Hz to maximum frequency F_H .
- 2) For deceleration time DEC , program the time that it takes for the inverter output frequency to go from maximum frequency F_H to 0Hz.

Set acceleration time from 0Hz operation frequency to maximum frequency F_H and deceleration time as the time when operation frequency goes from maximum frequency F_H to 0Hz.

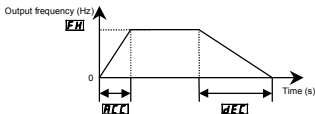

[Parameter setting]

Title	Function	Adjustment range	Default setting
ACC	Acceleration time 1 (s)	0.1-3000 seconds	10.0
DEC	Deceleration time 1 (s)	0.1-3000 seconds	10.0

☆ If the programmed value is shorter than the optimum acceleration/deceleration time determined by load conditions, overcurrent stall or overvoltage stall function may make the acceleration/deceleration time longer than the programmed time. If an even shorter acceleration/deceleration time is programmed, there may be an overcurrent trip or overvoltage trip for inverter protection. (For further details, see 13.1).

5.6 Maximum frequency

FH : Maximum frequency (Hz)

• **Function**

- 1) Programs the range of frequencies output by the inverter (maximum output values).
- 2) This frequency is used as the reference for acceleration/deceleration time.

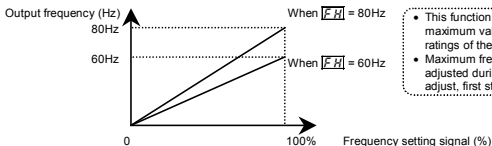

★ If FH is increased, adjust the upper limit frequency UL as necessary.

■ **Parameter setting**

Title	Function	Adjustment range	Default setting
FH	Maximum frequency (Hz)	30.0~200 (Hz)	*

* The value is changed according to the set-up parameter condition.

(VFNC1 (S)-□□□□P□-W type)

80 [Hz] for VFNC1 (S)-□□□□P□-W type.

5.7 Upper limit and lower limit frequencies

UL : Upper limit frequency (Hz)

LL : Lower limit frequency (Hz)

• **Function**

Programs the lower limit frequency that determines the lower limit of the output frequency and the upper limit frequency that determines the upper limit of that frequency.

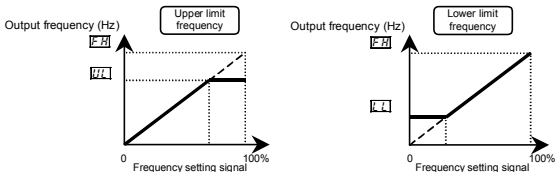

★ Signals with a frequency higher than the frequency set with UL will not be put out.

★ The output frequency cannot be set below the frequency set with LL .

■ **Parameter setting**

Title	Function	Adjustment range	Default setting
UL	Upper limit frequency (Hz)	0.5~ FH (Hz)	*
LL	Lower limit frequency (Hz)	0.0~ UL (Hz)	0.0

* The value is changed according to the set-up parameter condition.

(VFNC1 (S)-□□□□P□-W type)

80 [Hz] for VFNC1 (S)-□□□□P□-W type.

5.8 Base frequency

ωL : Base frequency 1 (Hz)

• Function

Sets the base frequency in conformance with load specifications or the motor's rated frequency.

Note: This is an important parameter that determines the constant torque control area.

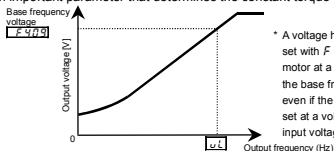

* A voltage higher than the voltage set with $F409$ is applied to the motor at a frequency higher than the base frequency set with ωL , even if the $F409$ parameter is set at a voltage lower than the input voltage.

■ Parameter setting

Title	Function	Adjustment range	Default setting
ωL	Base frequency 1 (Hz)	25~200 (Hz)	*

When operating the inverter with $P\tau = 3$ selected, change the setting of $F417$ to the value printed on the rating plate, in addition to the setting of ωL .

* The value is changed according to the set-up parameter condition.
 (VFNC1 (S)-□□□□P□-W type)
 60 [Hz] for VFNC1 (S)-□□□□P□ type.

5.9 Selecting control mode

$P\tau$: V/F control mode selection

ωb : Torque boost 1 (%)

$F401$: Slip frequency gain

• Function

With VF-nC1, the V/F controls shown below can be selected.

- V/F constant
- Vector control

* When torque is not produced enough at low speeds, adjust the rotational speed using the torque boost parameter. To correct the slip frequency, use the $F401$ parameter (slip correction gain).

■ Parameter setting

Title	Function	Adjustment range	Default setting
$P\tau$	V/F control mode selection	0 (1,2): V/F constant 3: Sensorless vector control	0

Follow the steps below to set the $P\tau$ parameter.

(Example: Setting the V/F control mode selection parameter ($P\tau$) to 3 (Vector control))

Key operated	LED display	Operation
	0.0	Displays the operation frequency (operation stopped). (When standard monitor display selection $F710=0$ is set to 0 [operation frequency]).
(ENT)	RUH	The first basic parameter "History (RUH)" is displayed.
(▲)	$P\tau$	Switch to the control mode selection parameter ($P\tau$) by pressing the Δ key.
(ENT)	0	Press the ENTER key to display the parameter setting. (Default setting: 0 (V/F))
(▲)	3	Change the setting to 3 (Vector control) by pressing the Δ key.
(ENT)	$3 \leftrightarrow P\tau$	Press the ENTER key to save the new setting. $P\tau$ and the parameter setting "3" are displayed alternately.

1) Constant torque characteristic

Setting of V/F control mode selection P_{L} to $\bar{0}$ (V/F constant)

This setting is applied to loads, such as conveyers and cranes that require the same torque as the rated torque even at low speeds.

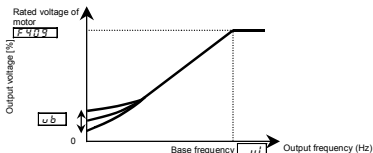

© To further increase the torque, increase the setting of the torque boost parameter ($u b$).

Parameter setting

Title	Function	Adjustment range	Default setting
$u b$	Torque boost 1 (%)	0.0~30.0(%)	Depends on the model.

The default torque characteristic is set based on the torque characteristic of World Energy series 4P motors manufactured by Toshiba Industrial Machinery.

When using the inverter with a VF motor or a motor with 6 or more poles, set the torque boost parameter at 80% or so of the default setting.

When the inverter is used with a special motor with a particular V/F ratio, it requires adjustments.

Excessively boosting torque could result in an overcurrent trip. To avoid this, do not increase torque by more than 1.2 times the default torque.

2) Correcting the error in rotational speed due to the slippage of the motor

Setting of V/F control mode selection P_{L} to $\bar{3}$ (Vector control)

Setting this parameter to 3 causes the inverter to monitor the load currents and automatically correct the error in speed caused by the slippage of the motor. Slip correction gain is adjusted to correct the error in speed caused by the slippage of the motor. ⇒ See 6.12 for details.

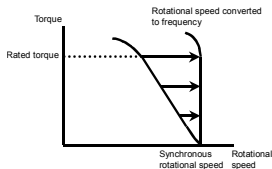

5.10 Setting the electronic thermal

OLN : Electronic thermal protection characteristics**THR** : Motor thermal protection level 1 (%)

● Function

Selects the electronic thermal protection characteristics that fit with the ratings and characteristics of the motor.

■ Parameter setting

Title	Function	Adjustment range				Default setting
		Setting value		Overload protection	Overload stall	
OLN	Electronic thermal protection characteristics	0	Standard motor	○	×	0
		1		○	○	
		2		×	×	
		3	VF motor (special motor)	×	○	
		4		○	×	
		5		○	○	
		6		×	×	
7	×	○				
THR	Motor thermal protection level 1 (%)	30~100 (%)			100	

★ ○ : valid, × : invalid

1) Setting the electronic thermal protection characteristics selection **OLN** and motor electronic thermal protection level 1 **THR**

The electronic thermal protection characteristics selection **OLN** is used to enable or disable the motor overload trip function (**OLZ**) and the overload stall function.

While the inverter overload trip (**OL1**) will be in constant detect operation, the motor overload trip (**OLZ**) can be selected using the parameter **OLN**.

Explanation of terms

Overload stall : When the inverter detects an overload, this function automatically lowers the output frequency before the motor overload trip **OLZ** is activated. The soft stall function allows the drive to run with balanced load current frequency without a trip. This is an optimum function for equipment such as fans, pumps and blowers with variable torque characteristics that the load current decreases as the operating speed decreases.

Note: Do not use the overload stall function with loads having constant torque characteristics (such as conveyor belts in which load current is fixed with no relation to speed).

[Using standard motors (other than motors intended for use with inverters)]

When a motor is used in the lower frequency range than the rated frequency, that will decrease the cooling effects for the motor. This speeds up the start of overload detection operations when a standard motor is used in order to prevent overheating.

■ Setting of electronic thermal protection characteristics selection **OLN**

Setting value	Overload protection	Overload stall
0	○	×
1	○	○
2	×	×
3	×	○

○ : valid, × : invalid

■ Setting of motor electronic thermal protection level 1 **THR**

If the capacity of the motor is smaller than the capacity of the inverter, or the rated current of the motor is smaller than the rated current of the inverter, adjust the electronic thermal protection level 1 **THR** so that it fits the motor's rated current.

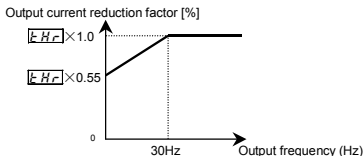

Note: The motor overload protection start level is fixed at 30Hz.

[Using a VF motor (motor for use with inverter)]

■ Setting selection \overline{OL} of electronic thermal protection characteristics

Setting value	Overload protection	Overload stall
4	○	×
5	○	○
6	×	×
7	×	○

○ : valid, × : invalid

A VF motor (motor for use with an inverter) can be used in lower frequency ranges than the general-purpose motor, but if that frequency is extremely low, the effects of cooling on the motor will deteriorate.

■ Setting the motor electronic thermal protection level 1 $\frac{I_H}{I_r}$

If the capacity of the motor being used is smaller than the capacity of the inverter, or the rated current of the motor is smaller than the rated current of the inverter, adjust the electronic thermal protection level 1 $\frac{I_H}{I_r}$ so that it fits the motor's rated current.

* If the indications are in percentages (%), then 100% equals the inverter's rated output current (A).

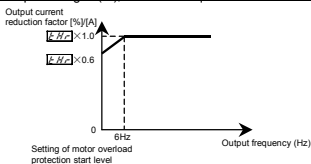

2) Inverter over load characteristics

Set to protect the inverter unit. Cannot be changed or turned off by parameter setting.

If the inverter overload trip function (\overline{OL}) is activated frequently, this can be improved by adjusting the stall operation level \overline{FOL} downward or increasing the acceleration time $d\overline{EL}$ or deceleration time $d\overline{EL}$.

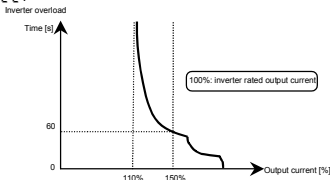

* To protect the inverter, overload trip may activate in a short period of time when output current reaches 150% or higher.

Inverter overload protection characteristics

■ Motor 150%-overload time limit : **F607**

Using the **F607** parameter (motor 150%-overload withstanding time), you can set the time (between 10 and 800 seconds) elapsed before an overload trip occurs (**UL2**) when the motor is operated under a load of 150%.

Title	Function	Adjustment range	Default setting
F607	Motor 150%-overload time limit	10~800 (sec)	300

5.11 Preset speed operation (speeds in 15 steps)

Sr1~**Sr7** : Preset speed operation frequencies 1~7 (Hz)

F287~**F294** : Preset speed operation frequencies 8~15

• **Function**

A maximum of 15 speed steps can be selected just by switching an external contact signal. Multi-speed frequencies can be programmed anywhere from the lower limit frequency **LL** to the upper limit frequency **UL**.

[Setting method]

1) Run/stop

The starting and stopping control is done from the terminal board.

Title	Function	Adjustment range	Default setting	Setting
FN0d	Command mode selection	0: Terminal board 1: Operation panel	1	0

Note: If speed commands (analog signal or digital input) are switched in line with preset speed operations, select the terminal board using the frequency setting mode selection **FN0d**.

⇒ See 3) or 5.1

2) Preset speed frequency setting

Set the speed (frequency) of the number of steps necessary.

Setting from speed 1 to speed 7

Title	Function	Adjustment range	Default setting
Sr1 ~ Sr7	Preset speed operation frequencies 1~7	LL ~ UL (Hz)	0.0

Setting from speed 8 to speed 15

Title	Function	Adjustment range	Default setting
F287 ~ F294	Preset speed operation frequencies 8~15	LL ~ UL (Hz)	0.0

■ Example of a frequency setting for forward 15-speed operation

Examples of preset speed contact input signals: When the input terminals are placed in sink logic mode

○ : ON — : OFF (Speed commands other than preset speed commands are valid when all are OFF)

CC	Terminal	Preset speed														
		1	2	3	4	5	6	7	8	9	10	11	12	13	14	15
S1	S1-CC	○	—	○	—	○	—	○	—	○	—	○	—	○	—	○
	S2-CC	—	○	○	—	—	○	○	—	—	○	○	—	—	○	○
VI/S3	VI/S3-CC	—	—	—	○	○	○	○	—	—	—	—	○	○	○	○
	R-CC	—	—	—	—	—	—	—	○	○	○	○	○	○	○	○

☆ Terminal functions are as follows.

Terminal S1..... Input terminal function selection 3 (S1) **F113=6** (SS1)
 Terminal S2..... Input terminal function selection 4 (S2) **F114=7** (SS2)
 Terminal VI/S3..... { Terminal VI and input terminal function **F109=2** (Contact input)
 selection 5 (VI/S3) **F115=8** (SS3)
 Terminal R..... Input terminal function selection 2 (R) **F112=9** (SS4)

☆SS3 (preset speed 3) and SS4 (preset speed 4) are not assigned to any terminals at the factory. Before use, therefore, assign SS3 and SS4 to reserved terminals, using the input terminal function selection parameter. In the above example, these functions are assigned to the R and VI/S3 terminals.

[Example of a connection diagram] (When the input terminals are placed in sink logic mode)

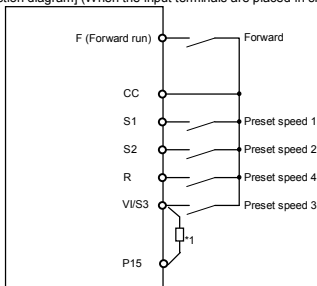

1 : When using the VI/S3 terminal as a contact input terminal, be sure to insert a resistor between the P15 and VI/S3 terminals. (* Recommended resistance: 4.7k Ω -1/4W)

3) Using other speed commands with preset speed command

Command mode selection <i>cmd</i>		0 : Terminal board			1 : Operation panel		
Frequency setting mode selection <i>Freq</i>		0 : Terminal board (Analog signal)	1 : Operation panel	2 : Potentiometer	0 : Terminal board (Analog signal)	1 : Operation panel	2 : Potentiometer
Preset speed command	Entered	Preset speed command Valid Note)			Analog signal Valid	Operation panel Command Valid	Potentiometer Valid
	Not entered	Analog signal Valid	Operation panel Command Valid	Potentiometer Valid	(The inverter doesn't accept preset speed command.)		

Note) The preset speed command is always given priority when other speed commands are input at the same time.

Below is an example of 3-step speed operation with standard default setting.

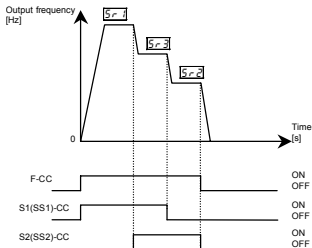

Example of 3-step speed operation

6. Extended parameters

Extended parameters are used for sophisticated operation, fine adjustment and other special purposes. Change parameter settings as required. See Table of extended parameters in Section 11.

6.1 Output signal-related parameters

6.1.1 Low speed signal

F100 : Low speed signal output frequency (Hz)

F130 : Output terminal selection 1 (FM/OUT)

F15L : FM/OUT terminal functions selection

F132 : Output terminal selection 3 (FLA, FLB, FLC)

• Function

If the output frequency exceeds the frequency set with **F100**, an ON signal will be put out. This signal can be used as an electromagnetic brake excitation/release signal.

When using a low speed signal for reversing the direction of rotation of the motor, set the **F100** parameter (low speed signal output frequency) above 1 kHz.

★ The low speed signal output frequency function is assigned by default to the FM/OUT terminal.

★ Before using the FM/OUT terminal, you need to make a selection between meter (PWM) output and open collector output.

To use the FM/OUT terminal as an open collector output terminal, set **F15L** to -1 (open collector output).

★ Signals can be sent to the relay output terminals FLA, FLB and FLC by changing a parameter setting.

[Parameter setting]

Title	Function	Adjustment range	Default setting
F100	Low speed signal output frequency (Hz)	0.6~FH (Hz)	0.6

■ Related parameters

Title	Function	Adjustment range	Default setting
F15L	FM/OUT terminal functions selection	-1: Open collector output 0: Output frequency 1: Output current 2: Frequency setting 3: Adjustment (current output fixed at 100%) 4: Adjustment (current output fixed at 50%) 5: Adjustment (output fixed at the max frequency) 6: Adjustment (gain display)	0
F130	Output terminal selection 1 (FM/OUT)	0~13 (See 6.2.6 for details.)	4
F132	Output terminal selection 3 (FL)	0~13 (See 6.2.6 for details.)	10

• Output terminal setting

The **F130** parameter (output terminal selection 1 (FM/OUT)) is set by default for low speed signal (ON signal).

To switch from ON signal to OFF signal, and vice versa, change the output terminal function setting.

[Parameter setting]

Title	Function	Adjustment range	Setting
F130	Output terminal selection 1 (FM/OUT)	0~13 (See Section 11.)	4 (ON signal) or 5 (OFF signal)

To output signals to the FLA, FLB and FLC terminals, set the **F132** parameter.

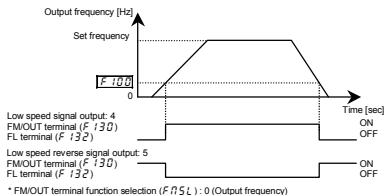

[Connection diagram]

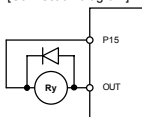

If using the relay with the rated voltage DC12V of operating coil, the maximum allowable voltage should be higher than 120% of rated voltage, and the maximum ampere value should not exceed 50mA.
(Operating coil resistance 250 ~ 800 Ω approx.).

6.1.2 Output of specified speed reach signal (output of arbitrarily set frequency)

F101 : Speed-reach setting frequency (Hz)

F130 : Output terminal selection 1 (FM/OUT)

F15L : FM/OUT terminal functions selection

F132 : Output terminal selection 3 (FLA, FLB, FLC)

•Function

If the output frequency exceeds the **F101**-set frequency ± 2.5 Hz, an OFF signal will be put out.

- ★ The low speed signal output frequency function is assigned by default to the FM/OUT terminal.
- ★ Before using the FM/OUT terminal, you need to make a selection between meter (PWM) output and open collector output.
To use the FM/OUT terminal as an open collector output terminal, set **F15L** to -1 (open collector output).
- ★ Signals can be sent to the relay output terminals FLA, FLB and FLC by changing a parameter setting.

■Parameter for specifying a frequency

Title	Function	Adjustment range	Default setting
F101	Speed-reach setting frequency (Hz)	0.0~FH (Hz)	0.0

■Related parameters

Title	Function	Adjustment range	Default setting
F15L	FM/OUT terminal functions selection	-1: Open collector output 0: Output frequency 1: Output current 2: Frequency setting 3: Adjustment (current output fixed at 100%) 4: Adjustment (current output fixed at 50%) 5: Adjustment (output fixed at the max frequency) 6: Adjustment (gain display)	0
F130	Output terminal selection 1 (FM/OUT)	0~13 (See 6.2.6 for details.)	4
F132	Output terminal selection 3 (FL)	0~13 (See 6.2.6 for details.)	10

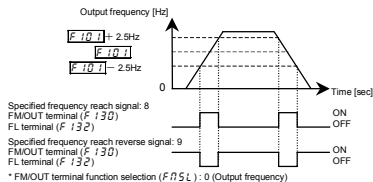

Note: Activate $F130$ to output signals to the FM/OUT terminal, or set $F132$ to 8 or 9 to output signals to the FLA, FLC and FLB terminals.

6.2 Parameters related to terminal function selection

6.2.1 Changing the function of the VI/S3 terminal

$F109$: Analog input/logic input function selection

Function

This parameter is used to switch the function of the VI/S3 terminal between analog signal input and contact signal input.

Parameter setting

Title	Function	Adjustment range	Default setting
$F109$	Analog input/logic input function selection	0: Voltage signal, 1: Current signal, 2: Contact input	0

* To use the VI/S3 terminal as a contact input terminal in sink connection, be sure to insert an adequate resistor* between P15 and VI/S3. (* Recommended resistance: 4.7 k Ω -1/4W)

6.2.2 Keeping an input terminal function always active

$F110$: Always active function selection (ST)

Function

This parameter allows you to select a function you want to keep always active (ON). (Only one function can be selected.)

Parameter setting

Title	Function	Adjustment range	Default setting
$F110$	Always active function selection (ST)	0~40, 49, 54~61 (See Section 11.)	1 (ST)

6.2.3 Changing the function of an input terminal

$F111$: Input terminal selection 1 (F)

$F112$: Input terminal selection 2 (R)

$F113$: Input terminal selection 3 (S1)

$F114$: Input terminal selection 4 (S2)

$F109$: Analog input/logic input function selection *1

$F115$: Input terminal selection 5 (VI/S3)

• Function

These parameters are used to specify a function for each individual input terminal. With these parameters allowing selection from among 45 functions for each input terminal, you can design a system with great flexibility. (For $F\ i\ 15$ (input terminal selection 5), you can make a selection from among 13 functions.)

- *1 Using the $F\ i\ 09$ parameter, you can select a function between analog input (frequency command input) and contact input for the $V\ i\ S3$ terminal. The $V\ i\ S3$ terminal is set by default as a voltage signal input terminal. When using the $V\ i\ S3$ terminal as a contact input terminal, you need to set $F\ i\ 09$ to 2 (contact input enabled), and then to specify a contact input function for it, using $F\ i\ 15$, because it is set by default as a voltage signal input terminal.

Note: Do not set $F\ i\ 09$ parameter if $V\ i\ S3$ terminal is not used as contact input.

■ Setting of contact input terminal function

Terminal symbol	Title	Function	Adjustment range	Default setting
—	$F\ i\ 09$	Analog input/logic input function selection	0~2	0 (voltage input)
—	$F\ i\ 10$	Always active function selection (ST)	—	1 (standby)
F	$F\ i\ 11$	Input terminal selection 1 (F)	0~40, 49,	2 (forward run)
R	$F\ i\ 12$	Input terminal selection 2 (R)	54~61	3 (reverse run)
S1	$F\ i\ 13$	Input terminal selection 3 (S1)	(See Section 11.)	6 (preset speed 1)
S2	$F\ i\ 14$	Input terminal selection 4 (S2)	—	7 (preset speed 2)
The parameter below is enabled only when $F\ i\ 09$ is set to 2.				
$V\ i\ S3$	$F\ i\ 15$	Input terminal selection 5 ($V\ i\ S3$)	5~17	8 (preset speed 3)

Note 1: The $F\ i\ 10$ parameter (always active function selection) allows you to select a function you want to keep always active.

Note 2: The $F\ i\ 15$ parameter (input terminal selection 5 ($V\ i\ S3$)) is enabled only when $F\ i\ 09$ is set to 2.

It is necessary to insert an adequate resistor* between P15 and $V\ i\ S3$.

(*Recommended resistance : 4.7k Ω -1/4W)

■ Connection method

1) A-contact input

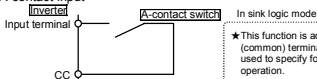

* This function is activated when the input and CC (common) terminals are short-circuited. This function is used to specify forward/reverse run or preset speed operation.

2) Connection with transistor output (Sink logic)

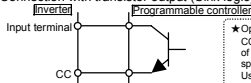

* Operation can be controlled by connecting the input and CC (common) terminals to the output (non-contact switch) of a programmable controller. This function is used to specify forward/reverse run or preset speed operation. Use a transistor that operates at 15Vdc-5mA.

* Interface between inverter and programmable controller

When an open collector output type programmable controller is being used for operation control, turning off the programmable controller with the inverter left ON causes a wrong signal to flow into the inverter, as shown in the figure below, because of a difference in control power potential. To avoid this, be sure to interlock the inverter and the programmable controller so that the programmable controller cannot be turned off when the inverter is on.

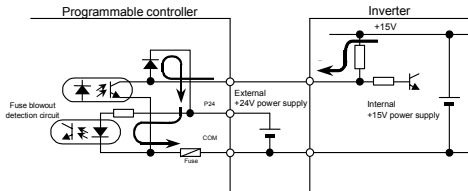

3) Sink logic/source logic input

Switching between sink logic and source logic (input terminal logic) is possible.

6.2.4 Jog run

• Function

The VF-nC1 inverter is capable of jog operation if its input terminal selection function is so set. Jog run refers to jogging or inching a motor. Input of a jog run signal causes the VF-nC1 inverter to produce a jog run signal (fixed at 5Hz) for 0.1 seconds (fixed), regardless of the specified acceleration time. Cutting off a jog run signal causes the motor to coast to a stop.

- The motor continues to run in jog mode as long as both the jog run signal and the operation signal are put out. To enable the jog run function, you need to assign the jog run function (4) to an unassigned input terminal.

For the VF-nC1 inverter, all settings for jog run are fixed, as shown below.

Jogging frequency	5Hz
Jogging stop pattern	Coast stop
Acceleration time	0.1 sec.

<Examples of jog run> (When the jog run function is assigned to the S1 terminal: $F \setminus \setminus \setminus = 4$)

- S1-CC (JOG) ON + F-CC ON: Forward jog run
- S1-CC (JOG) ON + F-CC ON: Reverse jog run
- Normal operation frequency signal input + F-CC ON: Forward run
- Normal operation frequency signal input + R-CC ON: Reverse run

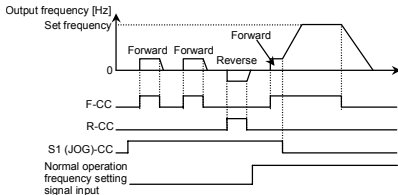

- The jog run terminals (S1-CC) are enabled when the operation frequency is below 5Hz. They do not function when the operation frequency is higher than the jog run frequency (5Hz).
- The motor continues to run in jog mode while the jog run terminals (S1-CC) are electrically connected.
- Jog run has priority, and it continues even if any other operation command is entered during operation.

Note: During jog run, the VF-nC1 inverter may produce an Low-speed detection signal (LOW) signal but not Designated frequency reach signal (RCH) signal, and therefore PI control is not performed.

6.2.5 Switching between control logics

F 127 : Sink/Source selection

• Function

This parameter is used to switch between sink logic (negative common) and source logic (positive common).

■ Parameter setting

Title	Function	Adjustment range	Default setting
F 127	Sink/Source selection	Adjustable within a range of 0 to 200 0: Sink 100: Source Others: Invalid	0

* The value is changed according to the set-up parameter condition. (VFNC1 (S)-□□□□P□-W type) 0 (sink) for VFNC1 (S)-□□□□P□ type.

6.2.6 Changing the function of an output terminal

F130 : Output terminal selection 1 (OUT/FM)

F132 : Output terminal selection 3 (FLA, FLB, FLC)

Function

These parameters are used to send various signals from the inverter to an external device. With these parameters allowing selection from among 14 functions for each output terminal, you can design a system with great flexibility.

How to use

Function of FM/OUT: Use the **F130** parameter to set it.

Function of FLA, FLB, FLC: Use the **F132** parameter to set it.

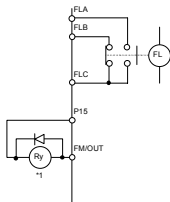

* : The function of the FM/OUT terminal can be switched between meter output (PWM) and open collector output. To use the FM/OUT terminal as an open collector output terminal, set **F154** to -1 (open collector output).

*1 If using the relay with the rated voltage DC12V of operating coil, the maximum allowable voltage should be higher than 120% of rated voltage, and the maximum ampere value should not exceed 50mA.
(Operating coil resistance 250 ~ 800 Ω approx.).

Setting of output terminal functions

Terminal symbol	Title	Function	Adjustment range	Default setting
FM/OUT	F130	Output terminal selection 1 (FM/OUT)	0~13 (See Section 11.)	4 (low speed detection signal)
FL	F132	Output terminal selection 3 (FL)		10 (failure FL)

See 2.3 for details.

Related parameters

Title	Function	Adjustment range	Default setting
F154	FM/OUT terminal functions selection	-1: Open collector output 0: Output frequency 1: Output current 2: Frequency setting 3: Adjustment (current output fixed at 100%) 4: Adjustment (current output fixed at 50%) 5: Adjustment (output fixed at the max frequency) 6: Adjustment (gain display)	0

6.3 Basic parameters 2

6.3.1 Switching motor characteristics via input terminals

- F170** : Base frequency 2 (Hz)
F171 : Base frequency voltage 2 (V)
F172 : Torque boost 2 (%)
F173 : Motor thermal protection level 2 (%)

• Function

These parameters are used to switch between two different types of motors connected to the inverter or to change the characteristic of the motor according to the use conditions or operation mode.

Note: The $P\checkmark$ parameter (V/F control mode selection) is effective only for motor 1.
 If motor 2 is selected, V/F control will be selected regardless of the setting of the $P\checkmark$ parameter (V/F control mode selection).

■ Parameter setting

Title	Function	Adjustment range	Default setting
F170	Base frequency 2 (Hz)	25~200(Hz)	*1
F171	Base frequency voltage 2 (V)	50~500	*2
F172	Torque boost 2 (%)	0.0~30.0(%)	Depends on the model. (See Section 11.)
F173	Motor thermal protection level 2 (%)	30~100(%)	100

*1, *2. The value is changed according to the set-up parameter condition.

(VFNC1 (S)-□□□□P□-W type)

*1 60 [Hz] for VFNC1 (S)-□□□□P□ type.

*2 200 [V] for VFNC1 (S)-□□□□P□ type.

■ Setting of switching terminals

The function of switching from motor 1 to motor 2 is not assigned by default to any terminal. So, assign this function to an unassigned terminal if necessary.

Parameters to be switched vary depending on the function number selected with an input terminal selection parameter.

Function number of input terminal			Parameters to be used and switched
40:MCHG	39:THR2	5:AD2	
OFF	OFF	OFF	Parameter to be used $P\checkmark_{UL}, F409, ub, tHr, ACC, dEC$
OFF	OFF	ON	Parameter to be switched $ACC \rightarrow F500, dEC \rightarrow F501$
OFF	ON	OFF	Parameter to be switched $P\checkmark \rightarrow P\checkmark_{UL} \rightarrow F170, F409 \rightarrow F171, ub \rightarrow F172, tHr \rightarrow F173$
OFF	ON	ON	Parameter to be switched $P\checkmark \rightarrow P\checkmark_{UL} \rightarrow F170, ACC \rightarrow F500, dEC \rightarrow F501, F409 \rightarrow F171, ub \rightarrow F172, tHr \rightarrow F173$
ON	-	-	Parameter to be switched $P\checkmark \rightarrow P\checkmark_{UL} \rightarrow F170, ACC \rightarrow F500, dEC \rightarrow F501, F409 \rightarrow F171, ub \rightarrow F172, tHr \rightarrow F173$

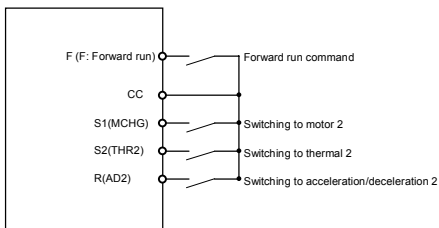

6.4 Analog signals for frequency setting

6.4.1 Setting frequency command characteristics

F109 : Analog input/logic input function selection

F201 : V/S3 reference point 1 setting (%) **F202** : V1/S3 point 1 frequency (Hz)

F203 : V/S3 reference point 2 setting (%) **F204** : V1/S3 point 2 frequency (Hz)

• Function

By changing the setting of **F109**, the function of the V1/S3 terminal can be switched between 0~(5)10Vdc voltage input and 4~20mA dc current input.

The **F201** to **F204** parameters are used to adjust the output frequency according to the analog signal (voltage: 0~(5)10Vdc, current: 4~20mA dc) from an external device.

■ Parameter setting

Title	Function	Adjustment range	Default setting
F109	Analog input/logic input function selection	0: Voltage signal input (0~10(5)Vdc) 1: Current signal input (0(4)~20A dc) 2: Contact input	0
F201	V1/S3 reference point 1 setting (%)	0~100(%)	0
F202	V1/S3 point 1 frequency (Hz)	0.0~200.0(Hz)	0.0
F203	V1/S3 reference point 2 setting (%)	0~100(%)	100
F204	V1/S3 point 2 frequency (Hz)	0.0~200.0(Hz)	*

Note 1: Do not specify the same value for input points 1 and 2. If you do so, the error message "Err 1" will be displayed.

* The value is changed according to the set-up parameter condition.

(VFNC1 (S)-□□□□P□-W type)

80 [Hz] for VFNC1 (S)-□□□□P□ type.

1) Adjustment of 0~10Vdc voltage input

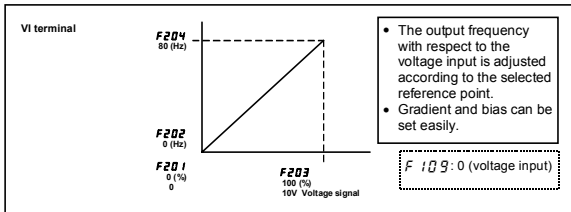

2) Adjustment of 4~20mA current input

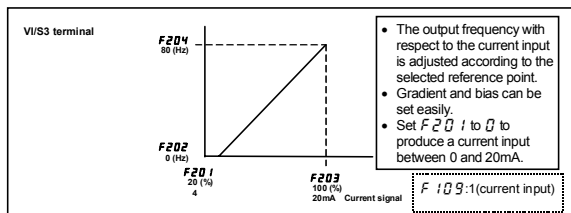

3) Adjustment of 0~5Vdc voltage input and external potentiometer (P5-V1/S3-CC)

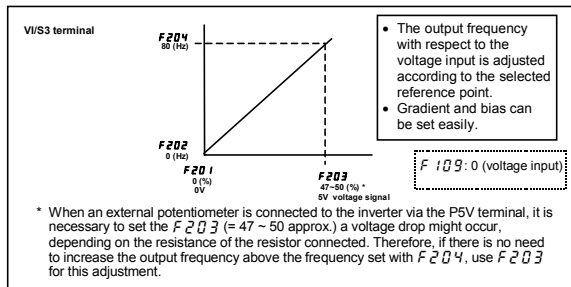

6.5 Operation frequency

6.5.1 Starting frequency

F240 : Starting frequency setting (Hz)

• **Function**

The frequency set with the **F240** parameter is put out immediately after the completion of frequency setting.

[Parameter setting]

Title	Function	Adjustment range	Default setting
F240	Starting frequency setting (Hz)	0.5~10.0(Hz)	0.5

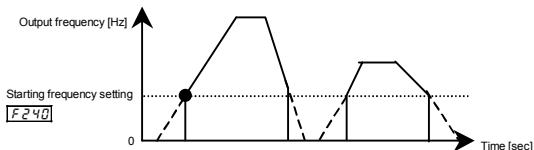

6.5.2 Start/stop control by means of frequency setting signals

F241 : Operation starting frequency (Hz)

F242 : Operation starting frequency hysteresis (Hz)

• **Function**

The start/stop of operation can be controlled, by simply using frequency setting signals.

[Parameter setting]

Title	Function	Adjustment range	Default setting
F241	Operation starting frequency (Hz)	0.0~ F_H (Hz)	0.0
F242	Operation starting frequency hysteresis (Hz)	0.0~ F_H (Hz)	0.0

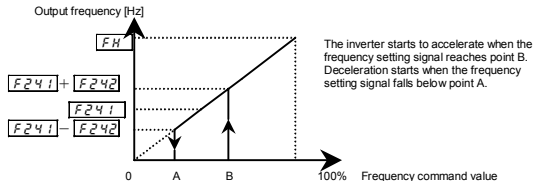

6.6 DC braking

6.6.1 DC braking

F250 : DC braking starting frequency (Hz)

F251 : DC braking current (%)

F252 : DC braking time (s)

• **Function**

Large braking torque can be obtained by applying a direct current to the motor. These parameters are used to set the direct current to be applied to the motor, the application time and the starting frequency.

[Parameter setting]

Title	Function	Adjustment range	Default setting
F250	DC braking starting frequency (Hz)	0.0:(OFF), 0.1~F H(Hz)	0.0
F251	DC braking current (%)	0~100(%)	50.0
F252	DC braking time (s)	0.0:(OFF) 0.1~20.0(sec)	1.0

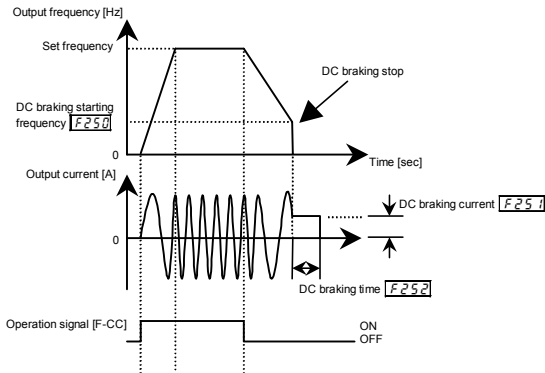

Note: During DC braking, the overload protection sensitivity of the motor increases. To prevent tripping, the DC braking current is adjusted automatically in some cases.

6.7 Jump frequency – Jumping resonant frequencies

F270 : Jump frequency (Hz)

F271 : Jump width (Hz)

• **Function**

Resonance due to the natural frequency of the mechanical system operated can be avoided by jumping the resonant frequency during operation. During jumping, hysteresis characteristics with respect to the resonant frequency are given to the motor.

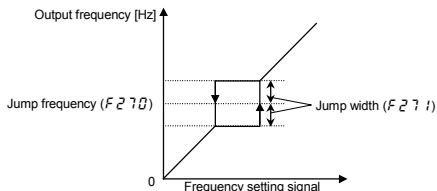

[Parameter setting]

Title	Function	Adjustment range	Setting
F270	Jump frequency (Hz)	LL ~ UL (Hz)	0.0
F271	Jump width (Hz)	0.0 ~ 30.0 (Hz)	0.0

☆ Do not set jump frequencies that overlap each other.

☆ During acceleration or deceleration, the jumping function is disabled for the operation frequency.

6.8 Preset speed operation frequencies 8 to 15

F287 ~ F294 : Preset speed operation frequencies 8 to 15 (Hz)

See Section 5.11 for details.

6.9 PWM carrier frequency

F300 : PWM carrier frequency

• **Function**

- 1) This parameter is used for changing the carrier frequency in order to change the tone of the magnetic noise produced by the motor. This parameter is also effective in preventing the motor from resonating with its load machine or fan cover.
- 2) In addition, this parameter is used to reduce the electromagnetic noise produced by the inverter. To reduce the electromagnetic noise, decrease the carrier frequency.
Note: This reduces the electromagnetic noise but increases the magnetic noise from the motor.
- 3) If the PWM carrier frequency is set above 4kHz, it may fall automatically during acceleration or under certain circumstances where an overcurrent flows.

[Parameter setting]

Title	Function	Adjustment range	Setting
F300	PWM carrier frequency	0:2kHz 1:2kHz(random control) 2:4kHz 3:4kHz(random control) 4:8kHz (automatic reduction mode) *1 5:12kHz(automatic reduction mode) *1 6:16kHz(automatic reduction mode) *1	5

*1 Certain models require to reduce the rated load current according to carrier frequency setting as following table.

Reduction in rated load current

When the PWM carrier frequency is set above 4kHz, the rated current needs to be decreased.

VFNC1S- VFNC1-	Ambient temperature	Carrier frequency			
		4kHz or less	8kHz	12kHz	16kHz
2001P	50°C or less	0.7A	0.7A	0.7A	0.7A
2002P	50°C or less	1.4A	1.4A	1.4A	1.4A
2004P	40°C or less Note 2)	2.4A	2.4A	2.4A	2.4A
	40 to 50°C	2.4A	2.4A	2.4A	2.2A
2007P	40°C or less Note 2)	4A	4A	3.6A	3A
	40 to 50°C	4A	3.6A	3.2A	2.8A
2015P	40°C or less Note 2)	7.5A	7.5A	7.5A	7.1A
	40 to 50°C	7.5A	7.5A	7.1A	6.3A
2022P	40°C or less Note 2)	10.0A	9.5A	8.5A	7.5A
	40 to 50°C	10.0A	8.5A	7.5A	6.5A
1001P	50°C or less	0.7A	0.7A	0.7A	0.7A
1002P	50°C or less	1.4A	1.4A	1.4A	1.4A
1004P	40°C or less Note 2)	2.4A	2.4A	2.4A	2.4A
	40 to 50°C	2.4A	2.4A	2.4A	2.2A
1007P	50°C or less	4A	4A	4A	4A
2002PL	40°C or less Note 2)	1.2A	1.2A	1.2A	1.2A
	40 to 50°C	1.1A	1.1A	1.1A	1.1A
2004PL	40°C or less Note 2)	2.3A	2.3A	2.3A	2.3A
	40 to 50°C	2.1A	2.1A	2.1A	2.1A
2007PL	40°C or less Note 2)	4A	3.6A	3.2A	2.8A
	40 to 50°C	3.6A	3.2A	2.9A	2.5A
2015PL	40°C or less Note 2)	7.5A	7.5A	7.5A	7.1A
	40 to 50°C	6.8A	6.8A	6.8A	6.4A
2022PL	40°C or less Note 2)	10.7A	10.1A	9.1A	8A
	40 to 50°C	9.6A	9.1A	8.2A	7.2A

• **Function**

Although the rated current at 4kHz is shown on the rating plate, the PWM carrier frequency is set to 12kHz by default.

Note 1) In order to protect the inverter, PWM carrier frequency may fall automatically depending on the circumstances even if it is under the derating in accordance with above table.



If using foot-mounted type noise reduction filter EMFAS2011Z or EMFA2006Z with VF-nC1, it is necessary to decrease 5% more of rated current in above table.

Note 2) When installing inverters side by side (without allowing space between them), detach the label on the top surface of each inverter, and reduce the rated output current. The reduction in rated output current at this installation must use not 40°C or less but 40 to 50°C in above table.

6.10 Trip-less intensification

6.10.1 Auto-restart (restart during coasting)

F301 : Auto-restart control selection

 Caution	
 Mandatory	<ul style="list-style-type: none"> Stand clear of motors and mechanical equipment. If the motor stops because of a momentary power failure, the equipment will start suddenly when the power is restored, and could cause injury. To prevent accidents, attach labels caution that there is the risk of a sudden start in the event of a power failure to all inverters, motors and machines.

• Function

This parameter detects the rotational speed and direction of rotation of the motor during coasting in the event of a momentary power failure, and restarts the motor smoothly as soon as power is restored (motor speed search function). Also, this parameter makes it possible to switch from commercial power operation to inverter operation without stopping the motor.

During restart operation, the message "rtr4" is displayed.

Title	Function	Adjustment range	Default setting
F301	Auto-restart control selection	0: Disabled 1: At auto-restart after momentary stop 2: When ST-CC is turned on or off 3: At auto-restart after momentary stop or when ST-CC is turned on or off	0

* When the motor restarts in retry mode, this function will be activated regardless of the parameter setting.

1) Auto-restart after momentary power failure (auto-restart function)

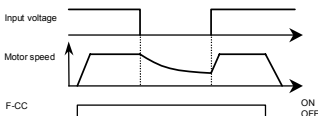

★ F301 set to 1 (3): This function is activated when the power is restored after the main circuits and control power supply has detected an undervoltage.

2) Start of motor during coasting (Motor speed search function)

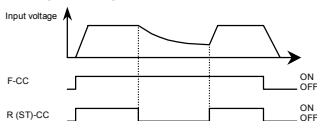

* The ST (standby signal) function is not assigned to any terminal. If necessary, assign this function to an unassigned terminal, using the multi-function programmable terminal function.

★ F301 set to 2 (3): The auto-restart function is activated when R(ST)-CC is short-circuited after they have been opened.

Notes

- A waiting time between 200 and 300 msec is preset to allow the residual voltage in the motor to come down to a specified level during restart. For this reason, the start-up takes more time than usual.
- Use this function when operating a system with one inverter connected with one motor. This function may not be performed properly in a system with one inverter connected with multiple motors.

Application to a crane or hoist

The crane or hoist might allow the load to move downward during the time elapsed before the motor starts after receiving an operation starting command. When applying the inverter to such a lifting gear, set the auto-restart control selection parameter to 0 (disabled) and avoid using the retry function.

6.10.2 Regenerative power ride-through control/slowdown stop control

F302 : Regenerative power ride-through control• **Function**

Regenerative power ride-through control :

Function of letting the motor continue to run using its regenerative energy in the event of a momentary power failure. (Enabled if **F302** is set to 1 (enabled))

Slowdown stop control:

Function of quickly stopping the motor in case a momentary power failure occurs during operation. Motor regenerative energy is used to forcibly bring the motor to a stop.

(Enabled if **F302** is set to 2 (slowdown stop))

If the motor is stopped forcibly, it remains at a standstill until the operation command is cancelled temporarily or the power is turned off.

[Parameter setting]

Title	Function	Adjustment range	Default setting
F302	Regenerative power ride-through control	0: Disabled, 1: Enabled, 2: Slowdown stop	0

Note: Even if this parameter is set to 1 (enabled), the motor may coast to a stop under some load conditions. In that case, use this function along with the auto-restart function.

[When the power is interrupted]

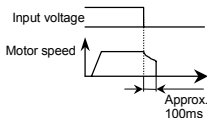

★The time for which the operation of the motor is continued depends on the machine's inertia or load conditions. Before using this function, therefore, perform a test to determine the inertial and load conditions.

★The use of the retry function along with this function allows the motor to be restarted automatically without being brought to a stop.

★Regenerative power ride-through control is performed for about 10ms (if **F302** is set to 1).

[When momentary power failure occurs]

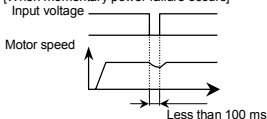

6.10.3 Retry function

F303 : Retry selection (Selecting the number of times)**Caution**

Mandatory

- Stand clear of motors and machines when the retry function is activated. When the retry function is enabled, the motor and machine in alarm-stop status will restart suddenly after the specified time, and could cause injury.
- To prevent accidents, attach words of caution saying that the retry function is enabled to the inverter, motor and machine.

• **Function**

This parameter resets the inverter automatically when the inverter gives an alarm. During the retry process, the motor search function is activated automatically, if necessary for restarting the motor smoothly.

[Parameter setting]

Title	Function	Adjustment range	Default setting
F303	Retry selection (number of times)	0: Disabled, 1~10: 1~10 times	0

Here are typical causes of tripping and the corresponding retry processes.

Cause of tripping	Retry process	Canceling conditions
Momentary power failure Overcurrent Overvoltage Overload	Up to 10 times of retry in succession 1st retry: About 1 sec. after tripping 2nd retry: About 2 sec. after tripping 3rd retry: About 2 sec. after tripping : 10th retry: About 10 sec. after tripping	The retry function will be cancelled at once if: <ul style="list-style-type: none"> • Tripping occurs for any reason other than momentary power failure, overcurrent, overvoltage or overload. • The motor does not restart within the specified number of times.

★ The retry function is not activated if tripping is caused by one of the following:

- | | |
|---|--|
| • \overline{OCR} : Arm overcurrent at start-up | • $\overline{Err2}$: Main body RAM fault |
| • \overline{OCL} : Overcurrent on the load side at start-up | • $\overline{Err3}$: Main body ROM fault |
| • \overline{EPHO} : Output open-phase failure | • $\overline{Err4}$: CPU fault |
| • \overline{E} : External tripping stop | • $\overline{Err5}$: Remote control error |
| • $\overline{UP1}$: Undervoltage stop | • $\overline{Err7}$: Driver fault |
| • $\overline{EF2}$: Ground fault trip | • $\overline{EEP1}$: EEPROM fault |
| • $\overline{EPH1}$: Input open-phase failure | |

★ Protective operation detection relay signals (FLA, FLB and FLC terminals) are not sent during the retry process.

★ A virtual cooling time is provided for overload tripping ($\overline{OL1}$, $\overline{OL2}$), so that the retry process is started after the virtual cooling time and retry time.

★ In the case of overvoltage tripping ($\overline{OP1}$ – $\overline{OP3}$), tripping may recur unless the DC voltage falls below a predetermined level.

★ In the case of overheating tripping (\overline{OH}), tripping may recur unless the internal temperature of the inverter falls below a predetermined level, since the internal temperature is monitored.

★ Even if trip retention selection parameter ($\overline{F502}$) is set to 1, the retry function is enabled if the number of times of retry is set with $\overline{F303}$.

★ During the retry process, the message "r t r Y" and the item specified with the status monitor selection parameter $\overline{F710}$ are displayed alternately.

6.10.4 Avoiding overvoltage tripping

F305 : Over voltage limit operation

• Function

This parameter is used to keep the output frequency constant or increase the frequency to prevent overvoltage tripping due to an increase in DC voltage during deceleration or constant-speed operation. The deceleration time may be prolonged during overvoltage limit operation.

Overvoltage limiting level

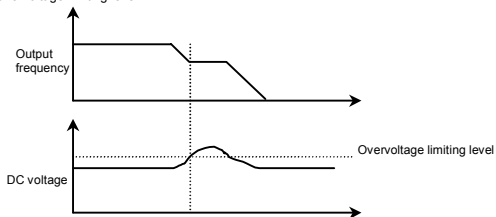

[Parameter setting]

Title	Function	Adjustment range	Default setting
F305	Over voltage limit operation	0: Enabled, 1: Disabled, 2: Enabled (forced quick deceleration)	0

6.11 Performing PI control

- F360** : PI control
F362 : Proportional (P) gain
F363 : Integral (I) gain

• **Function**

These parameters are used to perform various kinds of process control, such as keeping the air quantity, flow rate or pressure constant by inputting feedback signals (4~20mA, 0~10V) from a detector.

[Parameter setting]			
Title	Function	Adjustment range	Default setting
F360	PI control	0: Disabled, 1: Enabled	0
F362	Proportional (P) gain	0.01~100.0	0.30
F363	Integral (I) gain	0.01~100.0	0.20

1) External connection

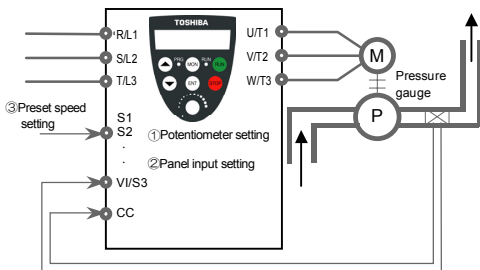

Feedback signal: 4~20mA, 0~10V

2) Types of PI control interfaces

The following combinations of process quantity data (frequency setting) and feedback data can be entered for PI control.

Process quantity input data (frequency setting)		Feedback input data
Setting mode	Frequency setting mode	External analog input
	<i>FNDd</i>	<i>F109</i> : 0 (voltage input)
① Internal potentiometer setting	2	① VI/S3 (DC: 0~10V)
② Panel input setting	1	<i>F109</i> :1 (current input)
③ Preset speed setting	<i>i</i> or <i>c</i>	② VI/S3 (DC: 4~20mA)

Note: When the PI control function is enabled (*F360*: 1), the VI/S3 terminal is used exclusively as a feedback signal input terminal.

Note: Do not set Frequency setting mode (*FNDd*) parameter to 0 if VI/S3 terminal is not used as contact input.

If all terminals for preset speed are off, a speed command other than the preset speed

3) Setting the PI control parameter

Set the extended parameter *F360* (PI control) to *1* (enabled).

- It is recommended to set the parameters *RCL* (acceleration time) and *dEL* (deceleration time) to as small values as possible.
- If there is a need to limit the output frequency, set it with the parameters *UL* (upper limit frequency) and *LL* (lower limit frequency). When process quantities are set from the operation panel, their adjustment ranges are limited by the settings of *UL* (upper limit frequency) and *LL* (lower limit frequency).

4) Adjusting the PI control gain level

Adjust the PI control gain level according to the process quantity, the feedback signal and the object to be controlled.

The following parameters are provided for gain adjustment.

Parameter	Adjustment range	Default setting
F362 (P gain)	0.01~100.0	0.30
F363 (I gain)	0.01~100.0	0.20

F362 (Proportional (P) gain adjustment parameter)

This parameter is used to adjust the proportional gain level during PI control. A correction factor, which is proportional to the particular deviation (the difference between the set frequency and the feedback value), is obtained by multiplying this deviation by the parameter setting. Increasing the P gain increases response. However, increasing it higher than required results in an undesirable event such as hunting.

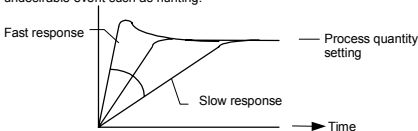

F363 (Integral (I) gain adjustment parameter)

This parameter is used to adjust the integral gain level during PI control. Any deviations remaining after proportional control are cleared to zero (residual deviation offset function).

Increasing the I gain increases response. However, increasing it higher than required results in an undesirable event such as hunting.

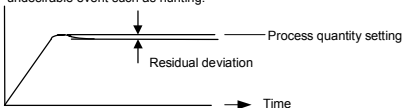

5) Adjusting an analog command voltage

To use feedback input (VI/S3 terminal), perform a voltage-scaling adjustment as required. See Section 6.4.1 for details.

If the feedback input value is very small, the voltage-scaling adjustment value can also be used for gain adjustment.

Example of voltage signal setting

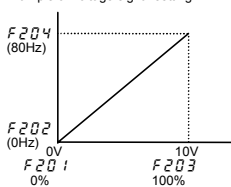

Example of current signal setting

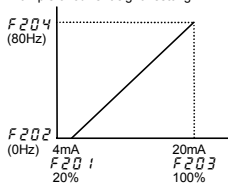

6.12 Improving torque and speed characteristics

6.12.1 Setting motor constants

- Pt** : V/F control mode selection
uL : Base frequency 1 (Hz)
F401 : Slip frequency gain
F409 : Base frequency voltage 1 (V) (rated voltage of motor)

★When setting the **Pt** parameter (V/F control mode selection) to 3 (slip correction), adjust the following parameters, too.

Title	Function	Adjustment range	Default setting
uL	Base frequency 1 (Hz)	25~200 (Hz)	60
F401	Slip frequency gain	0~150 (%)	50
F409	Base frequency voltage 1 (V) (rated voltage of motor)	50~500 (V)	*

* The value is changed according to the set-up parameter condition. (VFNC1 (S)-□□□□P□-W type) 200 [V] for VFNC1 (S)-□□□□P□ type.

F401 : Used to set a motor slippage correction factor. There is no need to change the factory default setting under normal conditions. However, if the motor speed fluctuates considerably with load fluctuations, increase the gain to reduce fluctuations of the motor speed.

F409 : Used to set the rated voltage of the motor. There is no need to change the factory default setting when using ordinary motors. However, when using a motor with a rated voltage and a base frequency other than 200V-50Hz, 200V-60Hz or 220V-60Hz, enter the rated voltage of the motor printed on its rating plate, in addition to its base frequency (uL).

6.12.2 Optimizing control characteristics

Although there is no need to change the settings of the following parameters under normal conditions, control characteristics may be improved by adjusting the parameters according to the motor specifications and load characteristics.

- F415** : Motor rated current
F416 : Motor no-load current
F417 : Motor rated speed
F418 : Speed control gain
F419 : Speed control stable coefficient

Title	Function	Adjustment range	Default setting
F415	Motor rated current	0.1-50.0(A)	Depends on the model (See Section 11.)
F416	Motor no-load current	30-80(%)	Depends on the model (See Section 11.)
F417	Motor rated speed	100-12000(min ⁻¹)	*
F418	Speed control gain	0~100(%)	40
F419	Speed control stable coefficient	0~100(%)	20

* The value is changed according to the set-up parameter condition. (VFNC1 (S)-□□□□P□-W type) 1710 [min⁻¹] for VFNC1 (S)-□□□□P□ type.

★Enabled if the **Pt** parameter (V/F control mode selection) is set to 0 (V/F)

F418 : Used to adjust the effective response to the frequency command.

- Increase the value to increase response.
- Decrease the value to decrease response.

Adjust the value in increments of 10 (%) or so while checking the effective response.

F419 : Used to adjust the effective response to the frequency command.

- Increase the value if overshooting or hunting occurs.
 - Increase the value if the speed reducer makes a gear noise.
 - Increase the value if overvoltage tripping occurs on completion of deceleration.
- Adjust the value in increments of 10 (%) or so while checking the effective response.

★Enabled if the **PL** parameter (V/F control mode selection) is set to 3 (slip correction)

F 4 15 : Used to set the rated current (A) of the motor. Enter the rated current printed on the motor's rating plate.

F 4 16 : Used to set the no-load current in percentage with respect to the rated current of the motor. Enter the value calculated from a motor test report value or the power factor printed on the rating plate of the motor.

F 4 17 : Used to set the rated rotational speed (min⁻¹) of the motor. Enter the rotating speed printed on the motor's rating plate.

F 4 18 : Used to adjust the response to the frequency command.

- Increase the value to increase response.
- Decrease the value to decrease response.

Adjust the value in increments of 10 (%) or so while checking the effective response.

F 4 19 : Used to adjust the effective response to the frequency command.

- Increase the value if overshooting or hunting occurs.
- Increase the value if the speed reducer makes a gear noise.
- Increase the value if overvoltage tripping occurs on completion of deceleration.

Adjust the value in increments of 10 (%) or so while checking the effective response.

6

6.13 Acceleration/deceleration patterns and acceleration/deceleration 2

RCC	: Acceleration time 1 (s)	F500	: Acceleration time 2 (s)
dEC	: Deceleration time 1 (s)	F501	: Deceleration time 2 (s)
		F505	: Acceleration/deceleration 1 and 2 switching frequency

Title	Function	Adjustment range	Default setting
RCC	Acceleration time 1 (s)	0.1~3000(s)	10.0
dEC	Deceleration time 1 (s)	0.1~3000(s)	10.0
F500	Acceleration time 2 (s)	0.1~3000(s)	10.0
F501	Deceleration time 2 (s)	0.1~3000(s)	10.0
F505	Acceleration/deceleration 1 and 2 switching frequency	0~UL (Hz)	0

■ Switching between acceleration and deceleration

- 1) Changing the acceleration/deceleration time by adjusting the internal frequency (**F505**)
 – Changing the acceleration/deceleration time by adjusting the frequency set with **F505** –

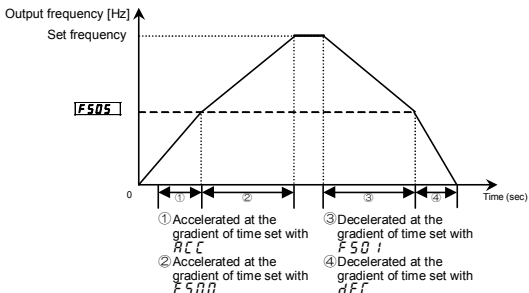

2) Changing the acceleration/deceleration time by adjusting the contact input signal – Changing the acceleration/deceleration time, using external terminals –

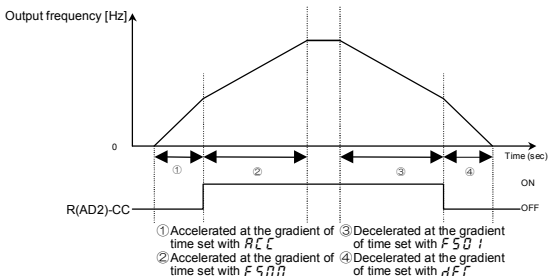

☆ This switching is done when acceleration/deceleration 2 (AD2) is assigned to the R terminal (when $F1i2$ (input terminal selection 2) is set to 5 (acceleration/deceleration 2)), using the multi-function programmable input terminal function.

In this case, set CLd to 0 (terminal block).

No signal for switching to acceleration/deceleration 2 is set by default. If necessary, assign function 5 (AD2) to an unassigned terminal, using the input terminal selection function.

6.14 Protection functions

6.14.1 Current stall setting

F501 : Stall prevention level

• Function

If a current exceeding the level specified with $F501$, the stall prevention function is activated to decrease the output frequency.

When specifying a value larger than 100 (%), set also the tkr parameter (motor electronic thermal protection level) properly.

■ Parameter setting

Title	Function	Adjustment range	Default setting
$F501$	Stall prevention level	30~199 (%) 200: Invalid	150

[Message displayed along with an OL alarm]

If an OL alarm goes off (if a current exceeding the stall prevention level), the output frequency displayed will change and the "L" on the left of it will blink.

Example of display : $L50$

6.14.2 Inverter trip retention

F602 : Inverter trip retention selection

• Function

This parameter is used to prevent the tripped inverter from being restored to working order when the power is turned back on. The inverter can be restored by resetting it from the operation panel (terminal).

[Parameter setting]

Title	Function	Adjustment range	Default setting
F602	Inverter trip retention selection	0: Not retained 1: Retained	0

★Up to four sets of latest trip information displayed by the status monitor function can be stored in memory.

★When the power is turned back on, trip information (such as trip current and voltage) stored by the status monitor function will be cleared.

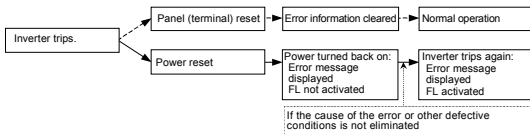

6.14.3 External input trip stop

F603 : External input trip stop mode selection

F252 : DC braking time (s)

• Function

These parameters allow you to specify a method for stopping the inverter when it receives an external trip stop signal via input terminals or an emergency stop signal from the operation panel. When the inverter shuts down, the error message "E" is displayed on the inverter's display panel and the error FL relay (trip output) is activated. When F603 is set to 2 (emergency DC braking), DC braking time also needs to be set using F252.

1) External trip stop by means of a terminal

External trip stop can be performed by means of the a-terminal. Perform the following steps to assign the external stop function to a terminal and to specify a stopping method.

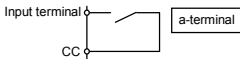

[Parameter setting]

Title	Function	Adjustment range	Default setting
F603	External input trip stop mode selection	0: Coast stop 1: Slowdown stop 2: Emergency braking stop	0
F250	DC braking starting frequency (Hz)	0.0:OFF 0.1~FH(Hz)	0.0
F251	DC braking current (%)	0~100(%)	50
F252	DC braking time (s)	0.0:OFF 0.1~20.0(sec)	1.0

(An example of terminal assignment) Assigning the trip stop function to the R terminal

Title	Function	Adjustment range	Default setting
F112	Input terminal selection 2 (R)	0~40, 49, 54~57	11 (External trip stop)

Notes:

- Emergency stop by means of the specified terminal is possible, even when operation is controlled from the operation panel.
 - If F250 (DC braking starting frequency) is set to 0.0 (Hz) and F252 (DC braking time to 0.0 (sec)), the DC braking function will not be activated even if F603 is set to 2 (emergency DC braking).
- 2) Emergency stop by means of the operation panel**

The emergency stop function can be controlled from the operation panel when the RUN and STOP keys on the panel are not in use for operation (when they are inoperative).

To activate the emergency stop function, press the STOP key on the operation panel twice.

① Press the STOP key — "E F F" will blink.

② Press the STOP key again — Operation will be stopped in accordance with the setting of F603. At the same time, "E" will be displayed and a failure detection signal (FL) will be put out (FL activated).

6.14.4 Output phase failure detection

F605 : Output phase failure detection mode selection

• Function

This parameter allows you to select a mode of detecting an output open-phase failure. If an open-phase failure persists for one second or more, the tripping function and the FL relay will be activated, and at the same time, the error message *EPH* will be displayed.

Set F605 to "2" to open the motor-inverter connection by switching commercial power operation to inverter operation.

Detection errors may occur for special motors such as high-speed motors.

F605=0 (Disabled) No tripping (FL relay not activated)

F605=1 (Enabled) An open-phase check is performed when operation is started for the first time after power has been turned on. The inverter will trip if an open-phase failure persists for one second or more. (FL relay activated)

F605=2 (Enabled) An open-phase check is performed each time operation is started. The inverter will trip if an open-phase failure persists for one second or more. (FL relay activated)

Title	Function	Adjustment range	Default setting
F605	Output open-phase failure detection mode selection	0: Disabled 1: Enabled (Checked at the first start of operation) 2: Enabled (Checked at each start of operation)	0

6.14.5 Motor 150%-overload time limit

F607 : Motor 150%-overload time limit

• Function

This parameter is used to set the time elapsed before the inverter trips when the motor is operated under a load of 150%.

Title	Function	Adjustment range	Default setting
F607	Motor 150%-overload time limit	10~800 (sec)	300

6.14.6 Input phase failure detection

F608 : Input phase failure detection mode selection

• Function

This parameter allows you to select a mode of detecting an input open-phase failure. If the ripple voltage in the main circuit capacitor remains very high for a certain period of time, the inverter will trip and the FL relay will be activated. At the same time, the error message *EPH 1* will be displayed.

If the power capacity is far larger than the inverter capacity (by more than 200kVA and more than 10 times), a detection error may occur. If this occurs, install an AC or DC reactor.

If the motor capacity is very small as compared with the inverter capacity, no open-phase failures may be detected.

F608=0 (Disabled) ... No tripping (FL relay not activated)

F608=1 (Enabled) ... An open-phase check is performed during operation. The inverter trips if the ripple voltage in the main circuit capacitor remains unusually high for a certain period of time. (FL relay activated)

Title	Function	Adjustment range	Default setting
F608	Input phase failure detection mode selection	0: Disabled, 1: Enabled	1

6.14.7 Over-torque alarm

F616 : Over-torque alarm level

F618 : Over-torque detection time

F130 : Output terminal selection 1 (OUT/FM) (**F132**: Output terminal selection 3 (FL))

• Function

An over-torque alarm signal is put out if a torque current exceeding the level set with **F616** (over-torque alarm level) flows for a period of time longer than that set with **F618** (over-torque detection time). To put out the signal via the FM/OUT or FL terminal, this function needs to be assigned to it in advance, using the output terminal function selection parameter.

Title	Function	Adjustment range	Default setting
F616	Over-torque alarm level	0~200(%)	150
F618	Over-torque detection time	0.0: Disabled 0.1~10.0(sec)	0.5
F130	Output terminal selection 1 (OUT/FM)	0~13	4
F132	Output terminal selection 3 (FL)	0~13	10

<Example of operation>

- 1) If function 12 (OT: over-torque detection) is assigned to the FM/OUT terminal, using the output terminal selection parameter **F 130**

F 130 (FM/OUT terminal selection 1): 12 (OT: over-torque detection)

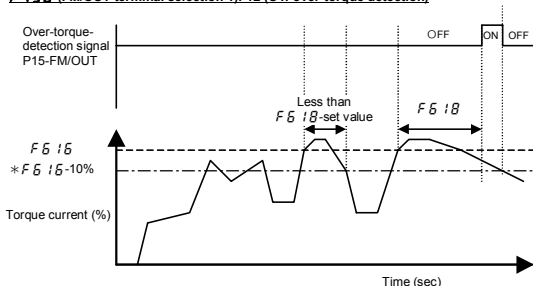

- * The VF-nC1 inverter has 10% of hysteresis to prevent the occurrence of over-torque hunting. Therefore, the over-torque signal is turned off at a level lower than the setting of **F 518** by 10% (hysteresis).

6.14.8 Undervoltage trip

F 527 : Under voltage trip selection

• Function

This parameter is used to select the control mode activated when an undervoltage is detected. The error message "UP 1" will be displayed if the inverter trips because of an undervoltage.

F 527 = 0 : Disabled ···· The inverter shuts down but not trip. (FL relay not activated) The inverter shuts down if the voltage drops below 64% of the rated voltage.

F 527 = 1 : Enabled ···· The inverter shuts down. It trips if the voltage drops below 64% of the rated voltage. (FL relay activated)

F 527 = 2 : Disabled ···· The inverter shuts down but not trip. (FL relay not activated) The inverter shuts down if the voltage drops below 50% of the rated voltage. When setting **F 527** to 1, be sure to install the input reactor of an option.

Title	Function	Adjustment range	Default setting
F 527	Under voltage trip selection	0: Disabled 1: Enabled (shutdown below 64%, FL relay activated) 2: Disabled (shutdown below 50%, FL relay not activated)	0

6.14.9 Analog input disconnection detection

F633 : Analog input disconnection detection

• Function

This parameter is used to detect a break in an analog signal to the V1/S3 terminal. If an analog signal is below the level set with **F633** for 0.3 seconds (approx.), the inverter will assume the signal to be broken and it will trip and display the error message "E-18." (The Analog input disconnection detection function is disabled if **F633** is set to 0.0%.)

Title	Function	Adjustment range	Default setting
F633	Analog input disconnection detection	0: Disabled 1~100%	0

6.15 Operation panel parameters

6.15.1 Prohibiting the change of parameter settings

F700 : Prohibition of change of parameter settings

• Function

This parameter specifies whether parameter setting is changeable or not.

■ Setting methods

[Parameter setting]

Title	Function	Adjustment range	Default setting
F700	Prohibition of change parameter settings	0~7 (See the explanation below.)	

- 0 : Permitted — **ENDD** and **FNDd** settings cannot be changed during operation. (Default)
- 1 : Prohibited — All parameters are read/write-protected.
- 2 : Permitted — **ENDD** and **FNDd** settings also can be changed during operation.
- 3 : Prohibited — Frequency can be changed from the operation panel but all other parameters are read/write-protected.
- 4 : Permitted — The emergency stop function cannot be controlled from the operation panel and **ENDD** and **FNDd** settings cannot be changed during operation.
- 5 : Prohibited — The emergency stop function cannot be controlled from the operation panel but all parameters are read/write-protected.
- 6 : Permitted — The emergency stop function cannot be controlled from the operation panel and **ENDD** and **FNDd** settings also can be changed during operation.
- 7 : Prohibited — The emergency stop function cannot be controlled from the operation panel, frequency can be changed on the operation panel, but any other parameters are write/read-protected.

Note: Some parameters cannot be changed during operation, no matter how **F700** is set. (See 4.1.4.)

■ Canceling the setting

Only the setting of **F700** can be changed anytime, no matter how it is set.

6.15.2 Changing the unit displayed (A/V/min⁻¹)

F 701 : Unit selection

F 702 : Frequency units selection

• Function

These parameters are used to change the unit displayed on the display panel.

% ⇔ A (ampere)/V (volt)

Frequency ⇔ Motor speed or load speed

■ Parameter setting

Title	Function	Adjustment range	Default setting
F 701	Unit selection	0: No change 1: % → A (ampere)/V (volt) 2: Free unit selection enabled (F 702) 3: % → A (ampere)/V (volt) Free unit selection enabled (F 702)	0
F 702	Frequency units selection	0.01~200.0	1.00

Note: For the settings in the parameter list, no units can be converted from % into A (ampere)/V (volt). Conversion from % into A (ampere)/V (volt) can be made in monitor mode only.

■ An example of setting for changing the unit of volt/current displayed from % to A/V

Set F 701 to 1 or 3.

When the VF-nC1-2007P inverter (current rating: 4.0A) is operated under the rated load (full-load).

1) Displayed in percentage

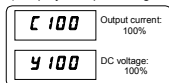

2) Displayed in amperes/volts

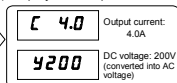

* Conversion from % into A (ampere)/V (volt) can be made in status monitor mode only. For the settings in the parameter list, no units can be converted from % into A (ampere)/V (volt).

■ An example of setting for displaying the motor or load speed

Set F 701 to 2 or 3.

The value obtained by multiplying the operation frequency by the value set with F 702 will be displayed, as shown below.

Value displayed = **Frequency displayed or parameter-set frequency** × Value set with **F 702**

1) Displaying the rotational speed of the motor

To switch from frequency (default: 60Hz) to speed (rotational speed of the 4P motor operated: 1800 (min⁻¹))



2) Displaying the speed of the load

To switch from frequency (default: 60Hz) to speed (speed of the conveyer operated: 6m/min⁻¹)



Note: This parameter is designed to display the value obtained by multiplying the output frequency of the inverter by an integer. Even if the rotational speed of the motor fluctuates with load conditions, the output frequency will always be displayed.

Using F 701, the following parameters can be converted.

- A display Display of the monitored current
- V display Display of the monitored voltage
- Free unit Display of the monitored frequency

6.15.3 Changing the standard monitoring item

F710 : Selection of monitor display selection

• **Function**

This parameter is used to change the item displayed when the power is turned on.

☆When the power is turned on, the operation frequency is displayed by default like this: "0.0" or "OFF". You can change this default monitoring item, using **F710**. In that case, however, no prefixes (such as **L** and **C**) will be displayed.

■ **Parameter settings**

Title	Function	Adjustment range	Default setting
F710	Selection of monitor display selection	0: Operation frequency (Hz/free unit) 1: Frequency command (Hz/free unit) 2: Output current (%/A)	0

6

6.16 Communication function (common serial)

F000 : Communication baud rate

F001 : Parity

F002 : Inverter number

F003 : Communication error trip time

For details, refer to the Communications Equipment User's Manual.

• **Function**

The VF-nC1 series of inverters can be connected to a host computer, controller, and so on (referred to as the computer) via RS232C or RS485 conversion units, so that they can be operated on a network.

<Computer linking function>

Data is exchanged between an inverter and a computer.

- ① Monitoring the inverter's operation status (such as output frequency, current and voltage)
- ② Commands to the inverter (such as RUN and STOP commands)
- ③ Reading, changing and writing inverter parameter settings

<RS232C communications>

Data is exchanged between one inverter and one computer.

<RS485C communications>

Data is exchanged between one computer and multiple inverters (a maximum of 64, or 63 for binary codes)

☆The following unit and cables are optionally available for common serial communications.

- RS232C conversion unit (Model: RS2001Z)
Communications cable (Model: CAB0011 (1m), CAB0013 (3m), CAB0015 (5m))
- Cable with a built-in RS232C conversion unit (Model: 20035)
- RS485C conversion unit with a terminal board (Model: RS4001Z, RS4002Z)
- Communications cable (Model: CAB0011 (1m), CAB0013 (3m), CAB0015 (5m))

Note: Use a cable 5 m or less in length to connect an inverter and an optional common serial unit.

■ Communications parameters (Common serial options)

The data transfer rate, parity type, inverter ID number and communication error trip time can be changed from the operation panel or the computer on the network.

Title	Function	Adjustment range	Default setting
<i>F B 0 0</i>	Communication baud rate	0: 1200bps 1: 2400bps 2: 4800bps 3: 9600bps 4: 19200bps	3
<i>F B 0 1</i>	Parity (Common serial)	0: Non (non parity) 1: Even (even parity) 2: Odd (odd parity)	1
<i>F B 0 2</i>	Inverter number	0~99	0
<i>F B 0 3</i>	Communication error trip time	0: Disabled 1~100 (sec)	0

*: Disabled ... Means that the inverter will not trip even if a communication error occurs.

Trip ... Means that the inverter will trip if a time-out occurs.

If a time-out occurs, the error message "E r r 5" will blink on the display panel.

6.16.1 Using RS232C/RS485 conversion units

■ Setting up the communications function

Commands (RUN/STOP commands) entered across a network have priority (over commands from the operation panel or terminal boards).

■ Data transmission specifications

Item	Specifications
Data transmission scheme	Half-duplex
Connection scheme	Centralized control
Synchronization scheme	Asynchronous
Data transfer rate	Default: 9600 baud (parameter setting) Selectable from among 1200, 2400, 4800, 9600 and 19200 baud
Character transmission	ASCII mode ... JIS X 0201, 8-bit (fixed, ASCII) Binary code ... Binary code, 8-bit (fixed)
Stop bit length	Receive (inverter): 1bit, Send (inverter): 2 bits
Error detection	Parity: Selectable among Even, Odd and Non by parameter setting, Check sum method
Character transmission format	Receiving: 11-bit, Sending: 12-bit
Order of bit transmission	Lower-order bits first
Frame length	Variable to a maximum of 17 bytes

■ Examples of connection for RS485 communications

<Example of connection>

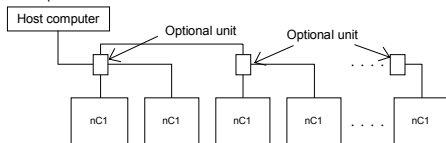

<Selective communications>

When an operation frequency command is sent from the host computer to No. 3 inverter

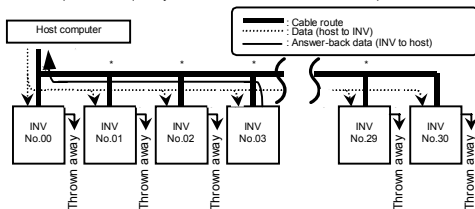

"Thrown away": On receipt of data from the host computer, only inverters with specified ID numbers perform the specified operation, while all other inverters throw the data away and move to the ready state for receiving the next data.

*: Use terminal boards to branch cables.

- ① The host computer sends data to all inverters on the network.
- ② On receiving the data from the computer, each inverter checks the inverter ID number contained in it.
- ③ Only the inverter with the specified ID number (No. 3 in this case) decodes the command and performs the specified operation.
- ④ No. 3 inverter sends the processing results to the host computer, along with its ID number.
- ⑤ Thus, only No. 3 inverter operates in response to the operation frequency command from the host computer.

6.16.2 Free notes

F880 : Free notes

• Function

This parameter allows you to specify an ID number for each inverter for management and maintenance purposes.

■ Parameter setting

Title	Function	Adjustment range	Default setting
F880	Free notes	0~65535	0

Note: Adjustment range of the above mention can set by the computer on the network.
The operation panel can set to the maximum 9999.

7. Variety of operation

7.1 Setting the operation frequency

Applied operation can be performed by selecting the inverter frequency setting, using the basic parameter $F\dot{R}\dot{Q}d$ (frequency setting mode selection).

(1) Internal potentiometer setting

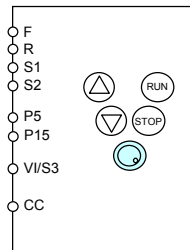

$F\dot{R}\dot{Q}d:2$

(2) Operation panel key setting

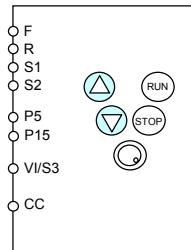

$F\dot{R}\dot{Q}d:1$

Enter the number with the operation panel keys, then press the ENTER key to confirm.

(3) External potentiometer setting

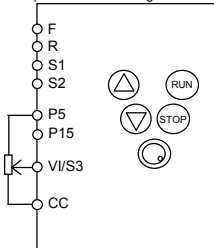

$F\dot{R}\dot{Q}d:0$

$F109:0$ (Input voltage signal)

Use the parameters $F201$ to $F204$ for this setting.

To use P5, set $F203$ at 50% or so.

(4) Input voltage setting (0 to 10Vdc)

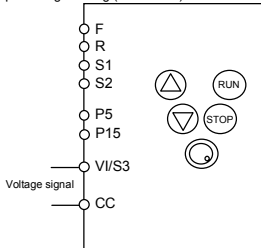

$F\dot{R}\dot{Q}d:0$

$F109:0$ (Input voltage signal)

Use the parameters $F201$ to $F204$ for this setting.

(5) Input current setting (4 to 20mAcd)

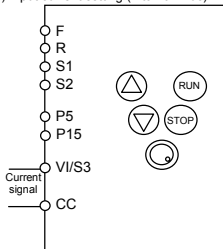

F n d:0

F i 9:1 (Input current signal)

Use the parameters *F 2 0 1* to *F 2 0 4* for this setting.

Set *F 2 0 1* at 20% or so.

(6) Preset-speed setting

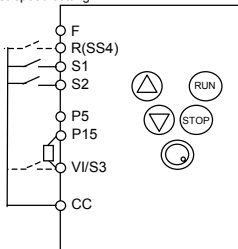

Frequency setting

S r 1 to *S r 7*: 1 to 7-speed run

F 2 8 7 to *F 2 9 4*: 8 to 15-speed run

(1) To select 3-speed run, use the terminals S1 and S2.

(2) To select 7-speed run, use the terminals S1 to S3 (Add S3).

F i 9:2 (Contact input)

F i 1 5:8 (SS3)

(3) To select 15-speed run, use the terminals S1 to S4 (Add S4).

F i 9:2 (Contact input)

F i 1 5:8 (SS3)

F i 1 2:9 (SS4)

Note: When using VI/S3 as an input terminal, be sure to short-circuit P15 and VI/S3 with a resistor.

(7) Setting by means of a remote input device

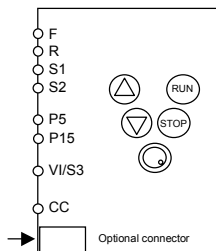

F n d:3 (Serial communications)

(8) Setting for switching between voltage/current and internal potentiometer

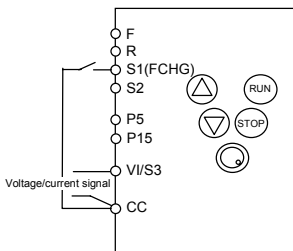

F n d:4 (Terminal block/internal potentiometer switching)

F i 1 3:38 (Frequency command forced switching)

7.2 Setting the operation mode

Applied operation can be performed by selecting the operation mode. To set the operation mode, use the basic parameter CND (command mode selection) and the input terminal selection parameter.

(1) Operation panel operation

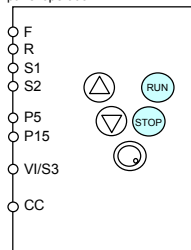

$\text{CND}:1$ (Operation panel)

(2) Terminal board operation

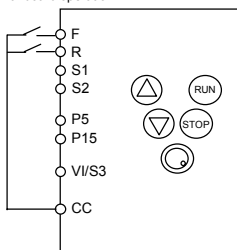

$\text{CND}:0$ (Terminal block)

(3) Operation panel/terminal board switching

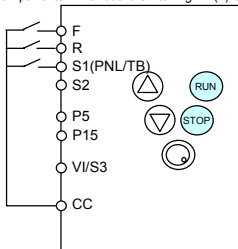

$\text{CND}:1$ (Operation panel)

$F113:12$ (Panel/terminal board switching)

Switching from panel operation to terminal board operation is done by inputting a panel/terminal board switching signal.

(4) Operation from an external input device

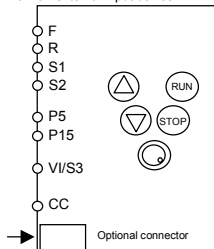

Priority is given to the external input device when the communications function is so set.















8. Monitoring the operation status

8.1 Status monitor mode

In this mode, you can monitor the operation status of the inverter.
To display the operation status during normal operation:

Press the  key twice.

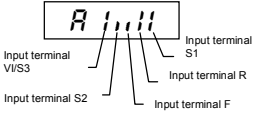
Setting procedure (eg. operation at 60Hz)

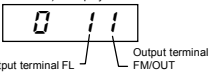
	Item displayed	Key operated	LED display	Communication No.	Description
Note 1			60.0		The operation frequency is displayed (during operation). (When the standard monitor display selection parameter $F \ 7 \ 10$ is set at 0 [operation frequency])
	Parameter setting mode		RUH		The first basic parameter "History (RUH)" is displayed.
	Direction of rotation		$F \ r - F$	FE01	The direction of rotation is displayed. (F : forward run, r : reverse run)
	Operation frequency command		F60.0	FE02	The operation frequency command value is displayed.
Note 2	Load current		L 80	FE03	The inverter output current (load current) is displayed. (Default setting : unit %)
Note 2.3	Input voltage		V 100	FE04	The inverter input (DC) voltage is displayed. (Default setting: unit %)
Note 2	Output voltage		P 100	FE05	The inverter output voltage is displayed. (Default setting: unit %)
Note 2	Torque current		c 80	FE20	The torque current is displayed. (Default setting: unit %)
	PI feedback		d 50	FE22	The PI feedback value is displayed. (Unit: frequency)
	Inverter load factor		L 80	FE27	The inverter load factor is displayed in %.
	Output power		H 80	FE30	The inverter output power is displayed in %.
	Operation frequency		o 60.0	FE00	The operation frequency is displayed.
	Input terminal		R 1111	FE06	The ON/OFF status of each of the control signal input terminals (F, R, S1, S2 and V1/S3) is displayed in bits. ON: 1 OFF: 0 
	Output terminal		0 11	FE07	The ON/OFF status of each of the control signal output terminals (FM/OUT and FL) is displayed in bits. ON: 1 OFF: 0 

(Continued overleaf)

(Continued)

Item displayed	Key operated	LED display	Communication No.	Description
CPU1 version	▲	u ! !	FE08	The version of the CPU1 is displayed.
CPU2 version	▲	u c 0 !	FE73	The version of the CPU2 is displayed.
Memory version	▲	u E 0 !	FE09	The version of the memory mounted is displayed.
Note 4 Past trip 1	▲	0 [3 ⇔ 1	FE10	Past trip 1 (displayed alternately at 0.5-sec. intervals)
Note 4 Past trip 2	▲	0 H ⇔ 2	FE11	Past trip 2 (displayed alternately at 0.5-sec. intervals)
Note 4 Past trip 3	▲	0 P 3 ⇔ 3	FE12	Past trip 3 (displayed alternately at 0.5-sec. intervals)
Note 4 Past trip 4	▲	n E r r ⇔ 4	FE13	Past trip 4 (displayed alternately at 0.5-sec. intervals)
Note 5 Cumulative operation time	▲	t 0.0 !	FE14	The cumulative operation time is displayed. (0.01 corresponds to 1 hours.)
Default display mode	MON	5 0.0		The operation frequency is displayed (during operation).

Note 1: Press the ▲ or ▼ key to change items displayed in the status monitor mode.

Note 2: With the current unit selection parameter or voltage unit selection parameter, you can choose between percentage and ampere (A) for current or between percentage and volt (V) for voltage, respectively.

Note 3: The input (DC) voltage displayed is $1/\sqrt{2}$ times as large as the rectified d.c. input voltage.

Note 4: n E r r is displayed to show the absence of error.

Note 5: The cumulative operation time increments only when the machine is in operation.

8.2 Display of trip information

If the inverter trips, an error code is displayed to suggest the cause. In the status monitor mode, all trip records are retained.

■ Display of trip information

Error code	Communication No.	Description
<i>nErr (*)</i>	0000	No error
<i>OC1</i>	0001	Overcurrent during acceleration
<i>OC2</i>	0002	Overcurrent during deceleration
<i>OC3</i>	0003	Overcurrent during operation
<i>OC4</i>	0004	Load-side overcurrent during start-up
<i>OCR</i>	0005	Armature-side overcurrent during start-up
<i>EPH1</i>	0008	Input phase failure
<i>EPHO</i>	0009	Output phase failure
<i>OP1</i>	000A	Overvoltage during acceleration
<i>OP2</i>	000B	Overvoltage during deceleration
<i>OP3</i>	000C	Overvoltage during constant-speed operation
<i>OL1</i>	000D	Inverter overload trip
<i>OL2</i>	000E	Motor overload trip
<i>OH</i>	0010	Overheat trip
<i>E</i>	0011	Emergency stop
<i>E2P1</i>	0012	E2PROM fault 1
<i>E2P2</i>	0013	E2PROM fault 2
<i>E2P3</i>	0014	E2PROM fault 3
<i>Err2</i>	0015	Inverter RAM fault
<i>Err3</i>	0016	Inverter ROM fault
<i>Err4</i>	0017	CPU fault trip
<i>Err5</i>	0018	Communication error
<i>Err7</i>	001A	Current detector fault
<i>UP1</i>	001E	Undervoltage trip
<i>EF2</i>	0022	Ground fault
<i>OC1P</i>	0025	Overcurrent flowing in element during acceleration
<i>OC2P</i>	0026	Overcurrent flowing in element during deceleration
<i>OC3P</i>	0027	Overcurrent flowing in element during low-speed operation
<i>E-18</i>	0032	Trip caused by a break in an analog signal cable
<i>E-19</i>	0033	CPU communication error
<i>E-20</i>	0034	Excessive torque boosted

(Note) Past trip records (trip records retained or trips that occurred in the past) can be called up.

(Refer to 8.1 "Status monitor mode" for the call-up procedure.)





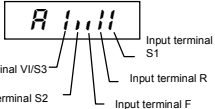
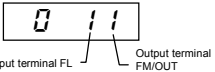



(*) Strictly speaking, this code is not an error code; this code is displayed to show the absence of error when the past trip monitor mode is selected.



■ Example of call-up of trip information

Item displayed	Key operated	LED display	Communication No.	Description
Note 1		0 P 2		Status monitor mode (The code blinks if a trip occurs.) The motor coasts and comes to a stop (coast stop).
Parameter setting mode	MON	R U H		The first basic parameter "History (R U 1)" is displayed.
Direction of rotation	MON	F r - F	FE01	The direction of rotation at the occurrence of a trip is displayed. (F : forward run, r : reverse run)
Operation frequency command	▲	F 6 0 . 0	FE02	The operation frequency command value at the occurrence of a trip is displayed.
Load current	▲	I 1 3 0	FE03	The inverter output current at the occurrence of a trip is displayed. (Default setting: unit %)
Input voltage	▲	V 1 4 1	FE04	The inverter input (DC) voltage at the occurrence of a trip is displayed. (Default setting: unit %)
Output voltage	▲	P 1 0 0	FE05	The inverter output voltage at the occurrence of a trip is displayed. (Default setting: unit %)
Torque current	▲	c 8 0	FE20	The torque current at the occurrence of a trip is displayed in %.
PI feedback	▲	d 5 0	FE22	The PI feedback value at the occurrence of a trip is displayed. (Unit: frequency)
Inverter load factor	▲	L 1 0 0	FE27	The inverter load factor at the occurrence of a trip is displayed in %.
Output power	▲	H 1 0 0	FE30	The output power of the inverter at the occurrence of a trip is displayed in %.
Operation frequency	▲	o 6 0 . 0	FE00	The operation frequency at the occurrence of a trip is displayed.
Input terminal	▲	R 1 1 1 1	FE06	The ON/OFF status of each of the control signal input terminals (F, R, S1, S2 and V1/S3) at the occurrence of a trip is displayed in bits. 
Note 2	▲	0 1 1	FE07	The ON/OFF status of each of the control signal output terminals (FM/OUT and FL) at the occurrence of a trip is displayed in bits. 

(Continued overleaf)

(Continued)

Item displayed	Key operated	LED display	Communication No.	Description
CPU1 version		v 11	FE08	The version of the CPU1 is displayed.
CPU2 version		v c 01	FE73	The version of the CPU2 is displayed.
Memory version		v E 01	FE09	The version of the memory mounted is displayed.
Past trip 1		0 P 2 ⇔ 1	FE10	Past trip 1 (displayed alternately at 0.5-sec. intervals)
Past trip 2		0 H ⇔ 2	FE11	Past trip 2 (displayed alternately at 0.5-sec. intervals)
Past trip 3		0 P 3 ⇔ 3	FE12	Past trip 3 (displayed alternately at 0.5-sec. intervals)
Past trip 4		n E r r ⇔ 4	FE13	Past trip 4 (displayed alternately at 0.5-sec. intervals)
Cumulative operation time		t 0.0 1	FE14	Cumulative operation time (0.01 corresponds to 1 hours.)
Default display mode		0 P 2		Status monitor mode (The LED blanks if trip occurs.)

Note 1: Press the  or  key to change items displayed in the status monitor mode.

Note 2: The FL output is held OFF in case of a trip, since the operation status immediately before the occurrence of the tip is retained by the status monitor output terminal board retention function.

Note 3: Failure trip information is cleared if the power is turned off or the inverter is reset. Therefore, the operation status is displayed and all failure information except for the cause of the failure is cleared, even if the trip information retention function is activated.

9. Taking measures to satisfy the CE / UL / CSA

9.1 Compliance with CE Marking

9.1.1 Abstract

In Europe, EMC directive is enforced starting 1st Jan. of 1996, and Low Voltage Directive starting 1st Jan. of 1997. The display of CE mark that demonstrates that products imported to European Union conform to these directives is required. Inverter itself cannot function alone, but is de-signed as a component in order to control machines or equipment which includes that inverter installed in a cubicle. Therefore the conformance to EMC directive is not required on inverter it-self. But since the object of the Low Voltage directive is equipment that is designed to be used with rated voltage of 50 to 1,000 VAC or 75 to 1,500 VDC, CE should be marked on inverter as to the Low Voltage directive.

But CE has to be marked on the final product installing inverters, that conforms to the EMC directive and the Low Voltage directive. And the product also may conform to Machine directive. The user that makes the final products have to take the responsibility for Marking of CE. For that reason, we recommend installation for Low Voltage directive and measurement for EMC directive, so that the products including our inverter should conform to the EMC and Low Voltage directive.

TOSHIBA carried out Approval testing and confirmation testing on representative models under the circumstances based on installation and measurement so that our products should conform to each directive. But we cannot confirm the conformance of the user's products to the EMC directive. Since EMC environment changes according to the construction of the cubicle and the relation of other installed electric equipment and the condition of wiring and installation, please confirm the conformance to the EMC directive for the final products on your side.

9.1.2 EMC directive

An inverter itself is not an object of CE marking.

A machine which consists of an inverter and a motor is an object of CE marking. The EMC directive includes the emission section and the immunity section. VF-nC1 can conform to EMC directive by means of installing the recommended EMI noise filter to the input side, and wiring properly.

→ Emission: Emission of electromagnetic wave and electromagnetic interference

→ Immunity: Resistance to electromagnetic interference

[EMC directive]

89/336/EEC

Table 1 Relative standard

Noise type	Test item	Standard	Applicable standards
Emission	Conducted Emission	EN61800-3	EN55011 Group 1 class A
	Radiated Emission		EN55011 Group 1 class A
	Electrostatic Discharge		IEC61000-4-2
Immunity	Radiated Electromagnetic field		IEC61000-4-3
	Electrical Fast Transient/Burst		IEC61000-4-4
	Surge Immunity		IEC61000-4-5
	Conducted Disturbances		IEC61000-4-6
	Voltage dips, short interruptions and voltage variations		IEC61000-4-11

9.1.3 Compliance with EMC directive

9.1.3.1 The model, noise filter inside

- (1) Single-phase 200V class : VFNC1S-2002PL to 2022PL
The above mentioned models install EMI noise filter inside. So the conducted and radiated noise can be reduced, optional EMI noise filters are not needed.
(The additional noise filter should be installed, when more effective reduction is required.)
- (2) The main cables such as input to the EMI filter and output of the inverter and the signal cables should be shielded, then cable length should be wired as short as possible. The main input cable should be separated from the main output cable, and cables for control signal also should be separated from main cables, not wiring parallel and not bundling, cross the wires where necessary.
- (3) Install EMI filter and inverter on the same metal back plate in an inverter panel. The metal back plate or the cubicle must be grounded absolutely, by using short thick wires, separated from the main cables.
- (4) Shielded cables should be grounded on the metal back plate in order to reduce the radiated noise from the other cables. It is an effective measure that shielded cables are grounded close to the inverter or/and operation panel or/and EMI filter(less than 10cm).
- (5) Installation of the zero-phase and/or the ferrite core can also effectively reduce the radiated noise further.(Input or/and output of inverter)

【Ex. Countermeasure - main circuit wiring】

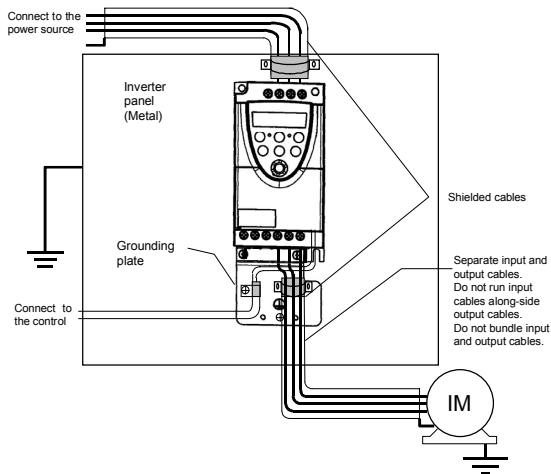
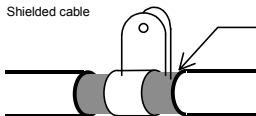

Fig. 1

Shielded cable



Strip the cable and fix it to the metal plate by means of a metal saddle for electrical work or equivalent.

9.1.3.2 The models without EMI filters

- (1) Shingle-phase 100V class : VFNC1-1001P to 1007P
 Three-phase 200V class : VFNC1-2001P to 2022P
 Shingle-phase 200V class : VFNC1S-2002P to 2022P

This subsection explains what measures must be taken to satisfy the EMC directive. Insert a recommended EMI filter (Table 2) on the input side of the inverter to reduce radiation and transmission noises. In the combinations listed in Table 2, inverters were checked for conformity with the EMC directive. For inverters used in Japan, it is recommended to use the NF series of noise filters.

Table 2 lists noise filters recommended for the inverters.

Table 2. Recommended EMI filter selection

Voltage class	Inverter	Filter for class A Compliance Motor cable length 20m or less	Filter for class B Compliance Motor cable length 5m or less
Three-phase 200V class	VFNC1-2001P	EMFA2006Z	-
	VFNC1-2002P	EMFA2006Z	-
	VFNC1-2004P	EMFA2006Z	-
	VFNC1-2007P	EMFA2006Z	-
	VFNC1-2015P	EMFA2015Z	-
	VFNC1-2022P	EMFA2015Z	-
Single-phase 200V class	VFNC1S-2002P	EMFAS2011Z	-
	VFNC1S-2004P	EMFAS2011Z	-
	VFNC1S-2007P	EMFAS2011Z	-
	VFNC1S-2015P	EMFAS2025Z	-
	VFNC1S-2022P	EMFAS2025Z	-
Single-phase 100V class	VFNC1S-1001P	EMFAS2011Z	-
	VFNC1S-1002P	EMFAS2011Z	-
	VFNC1S-1004P	EMFAS2011Z	-
	VFNC1S-1007P	EMFAS2025Z	-
Single-phase 200V class (Built-in filter type)	VFNC1S-2002PL	With a built-in filter	With a built-in filter
	VFNC1S-2004PL	With a built-in filter	With a built-in filter
	VFNC1S-2007PL	With a built-in filter	With a built-in filter
	VFNC1S-2015PL	With a built-in filter	With a built-in filter
	VFNC1S-2022PL	With a built-in filter	With a built-in filter

- The main cables such as input to the EMI filter and output of the inverter and the signal cables should be shielded, then cable length should be wired as short as possible. The main input cable should be separated from the main output cable, and cables for control signal also should be separated from main cables, not wiring parallel and not bundling, cross the wires where necessary.
- Install EMI filter and inverter on the same metal back plate in an inverter panel. The metal back plate or the cubicle must be grounded absolutely, by using short thick wires, separated from the main cables.
- Please separate input cable to EMI filter from output cable as much as possible.
- Shielded cables should be grounded on the metal back plate in order to reduce the radiated noise from the other cables. It is an effective measure that shielded cables are grounded close to the inverter or/and operation panel or/and EMI filter(less than 10cm).

- (6) Installation of the zero-phase and/or the ferrite core can also effectively reduce the radiated noise further. (Input or/and output of inverter)

[Ex. Countermeasure - main circuit wiring]

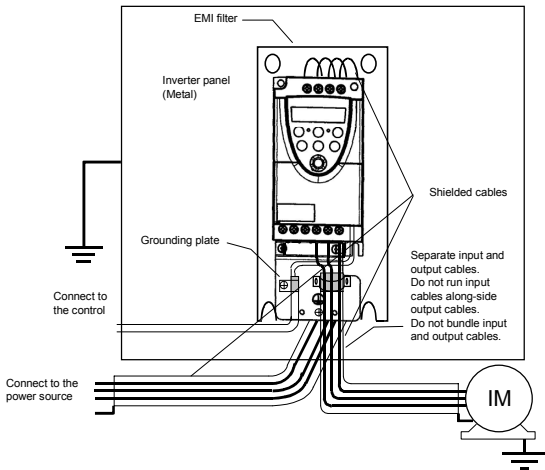

Fig. 2

Note 1)
Process as shown below.

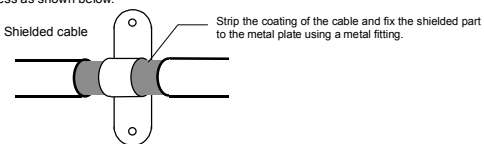

Fig. 3

[Operating with external signals]

To operate with external signals, process as following figures.

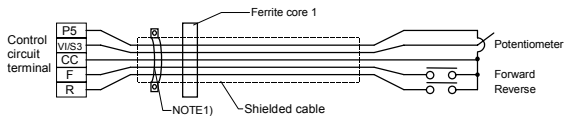

Fig. 4

[Accessories for countermeasure]

- Shielded cable : Showa electric Wire & Cable Co. LTD.
Type form/ CV-S, 600V or less
- Shielded cable : SUMITOMO 3M Co. Ltd. Electro-magnetic guard shielded sleeve
Type form/ DS-5,7,10,14
- EMI filter : Toshiba Schneider Inverter Corporation
Type form/ For further details, see 9.1.3.2
- Ferrite core 1 : TDK Co. Ltd.
Type form/ ZCAT3035-1330

[Apply if needed]

- Grounding plate : Toshiba Schneider Inverter Corporation
Type form/ EMP001Z
- Ferrite core : NEC TOKIN Corporation
Type form/ ESD-R-47D-1
- Zero-phase reactor : Soshin denki Co. Ltd.
Type form/ RC5078 or RC9129
- Radio noise filter : Soshin denki Co. Ltd.
Type form/ NF series

9.1.4 Low voltage directive**Inverter itself is an object of the CE marking.**

The Low Voltage Directive defines the safety of the electric equipment. VF-nC1 series conform to the Low Voltage directive based on EN50178.

Normative standard : EN50178/Electronic equipment for use in power installation

Pollution degree : 2(5.2.15.2)

Over-voltage category : 3 200V class 3.0 mm (5.2.16.1)

EN50178 provides that for electronic equipment used in power installations. The main intention is to stipulate minimum requirements for the design and manufacture of electronic equipment, for protection against electric shock, for testing and for the integration into systems for power installations.

9.1.5 Compliance with Low voltage directive

Please carry out the below mentioned countermeasures for the Low Voltage Directive in case of using VF-nC1 as components of your products.

- (1) Inverter should be installed in a panel. Pay attention to wiring openings, so that it should prevent someone from touching live parts through the opening in case of maintenance.
- (2) No more than 1 cable should be connected to one earth terminal of the main terminal board. In this case, other cables for ground should be grounded on the metal back plate and/or in the cubicle. The cross-sectional area of grounding cable shall be, in any case, not less than;

Table 3. Grounding cable

Voltage class	Capacity of applicable motor(kW)	Inverter model	Wire size
			Grounding cable
Single-phase 100V class	0.1	VFNC1S-1001P	AWG 12 / 3.5 mm ²
	0.2	VFNC1S-1002P	AWG 12 / 3.5 mm ²
	0.4	VFNC1S-1004P	AWG 12 / 3.5 mm ²
	0.75	VFNC1S-1007P	AWG 12 / 3.5 mm ²
Single-phase 200V class	0.2	VFNC1S-2002P(L)	AWG 12 / 3.5 mm ²
	0.4	VFNC1S-2004P(L)	AWG 12 / 3.5 mm ²
	0.75	VFNC1S-2007P(L)	AWG 12 / 3.5 mm ²
	1.5	VFNC1S-2015P(L)	AWG 12 / 3.5 mm ²
	2.2	VFNC1S-2022P(L)	AWG 10 / 5.5 mm ²
Three-phase 200V class	0.1	VFNC1-2001P	AWG 12 / 3.5 mm ²
	0.2	VFNC1-2002P	AWG 12 / 3.5 mm ²
	0.4	VFNC1-2004P	AWG 12 / 3.5 mm ²
	0.75	VFNC1-2007P	AWG 12 / 3.5 mm ²
	1.5	VFNC1-2015P	AWG 12 / 3.5 mm ²
	2.2	VFNC1-2022P	AWG 12 / 3.5 mm ²

- (3) MCCB or fuse should be connected to the input side of the EMI filter.

9.2 Compliance with UL Standard and CSA Standard

The VF-nC1 models, that conform to the UL Standard and CSA Standard have the UL/CSA mark on the nameplate.

9.2.1 Compliance with Installation

The VF-nC1 inverter must be installed in a panel, and used within the ambient temperature specification.

See 1.4.4 for details.

9.2.2 Compliance with Connection

Use the UL conformed cables (Rating 75°C or more, Use the copper conductors only.) with the ring terminal at wiring to the inverter input/ output terminals (R/L1, S/L2, T/L3, U/T1, V/T2, W/T3). For instruction in the United States, Integral solid state short circuit protection does not provide branch circuit protection. Branch circuit protection must be provided in accordance with the National Electrical Code and any additional local codes.

For instruction in the Canada, Integral solid state short circuit protection does not provide branch circuit protection. Branch circuit protection must be provided in accordance with the Canadian Electrical Code and any additional local codes.

See the table in 10.1 for wire size.

9.2.3 Compliance with Peripheral devices

Use the UL listed fuses at connecting to power supply.

Refer to the instruction manual about selecting the rating of them.

Short circuit test is performed under the condition of the power supply short-circuit currents in below.

These currents and fuse currents depend on the drive motor capacities.

Table 4. AIC and fuse

Voltage class	Capacity of applicable motor (kW)	Inverter model	AIC (Interrupting capacity)	Maximum input voltage (V)	Fuse class and currents (A)
Single-phase 100V class	0.1	VFNC1S-1001P	AIC 1000A	120	CC/J 6 max
	0.2	VFNC1S-1002P	AIC 1000A	120	CC/J 8 max
	0.4	VFNC1S-1004P	AIC 1000A	120	CC/J 12 max
	0.75	VFNC1S-1007P	AIC 1000A	120	CC/J 22 max
Single-phase 200V class	0.2	VFNC1S-2002P(L)	AIC 1000A	240	CC/J 4 max
	0.4	VFNC1S-2004P(L)	AIC 1000A	240	CC/J 8 max
	0.75	VFNC1S-2007P(L)	AIC 1000A	240	CC/J 12 max
	1.5	VFNC1S-2015P(L)	AIC 5000A	240	CC/J 22 max
	2.2	VFNC1S-2022P(L)	AIC 5000A	240	CC/J 30 max
Three-phase 200V class	0.1	VFNC1-2001P	AIC 1000A	240	CC/J 3 max
	0.2	VFNC1-2002P	AIC 1000A	240	CC/J 3 max
	0.4	VFNC1-2004P	AIC 1000A	240	CC/J 5 max
	0.75	VFNC1-2007P	AIC 1000A	240	CC/J 8 max
	1.5	VFNC1-2015P	AIC 5000A	240	CC/J 15 max
	2.2	VFNC1-2022P	AIC 5000A	240	CC/J 20 max





Table 5. Power supply short-circuit current and input voltage

Input voltage	Drive motor	Power supply short-circuit current and maximum input voltage
100V	Up to 0.75 kW	Suitable For Use On A Circuit Capable Of Delivering Not More Than 1,000A rms Symmetrical Amperes, 120 Volts Maximum When Protected by CC/J Class Fuses.
200V	Up to 0.75 kW	Suitable For Use On A Circuit Capable Of Delivering Not More Than 1,000A rms Symmetrical Amperes, 240 Volts Maximum When Protected by CC/J Class Fuses.
	1.5 kW and over	Suitable For Use On A Circuit Capable Of Delivering Not More Than 5,000A rms Symmetrical Amperes, 240 Volts Maximum When Protected by CC/J Class Fuses.

9.2.4 Motor thermal protection

Selects the electronic thermal protection characteristics that fit with the ratings and characteristics of the motor. In case of multi motor operation with one inverter, thermal relay should be connected to each motor.

10. Peripheral devices

 Warning	
 Prohibited	<ul style="list-style-type: none"> If you take the power supply from an outlet, do not over the outlet's rated current. That could emit the outlet and may result in an ignition.
 Mandatory	<ul style="list-style-type: none"> When using wiring materials and their optional devices for the inverter, they must be installed in a cabinet. Failure to do so can lead to risk of electric shock and can result in death or serious injury.
 Be Grounded	<ul style="list-style-type: none"> Connect earth cables securely. Failure to do so can lead to risk of electric shock or fire in case of a failure, short-circuit or leak current.

10.1 Selection of wiring materials and devices

Voltage class	Capacity of applicable motor (kW)	Inverter model	Wire size		
			Main circuit (See Note 1.)	DC reactor (optional)	Grounding cable
Single-phase 100V class	0.1	VFNC1S-1001P	AWG 14 / 2.0 mm ²	-	AWG 12 / 3.5 mm ²
	0.2	VFNC1S-1002P	AWG 14 / 2.0 mm ²	-	AWG 12 / 3.5 mm ²
	0.4	VFNC1S-1004P	AWG 14 / 2.0 mm ²	-	AWG 12 / 3.5 mm ²
	0.75	VFNC1S-1007P	AWG 14 / 3.5 mm ²	-	AWG 12 / 3.5 mm ²
Single-phase 200V class	0.2	VFNC1S-2002P(L)	AWG 14 / 2.0 mm ²	AWG 16 / 1.25 mm ²	AWG 12 / 3.5 mm ²
	0.4	VFNC1S-2004P(L)	AWG 14 / 2.0 mm ²	AWG 16 / 1.25 mm ²	AWG 12 / 3.5 mm ²
	0.75	VFNC1S-2007P(L)	AWG 14 / 2.0 mm ²	AWG 14 / 2.0 mm ²	AWG 12 / 3.5 mm ²
	1.5	VFNC1S-2015P(L)	AWG 10 / 3.5 mm ²	AWG 14 / 2.0 mm ²	AWG 12 / 3.5 mm ²
	2.2	VFNC1S-2022P(L)	AWG 10 / 5.5 mm ²	AWG 14 / 2.0 mm ²	AWG 10 / 5.5 mm ²
Three-phase 200V class	0.1	VFNC1-2001P	AWG 14 / 2.0 mm ²	AWG 16 / 1.25 mm ²	AWG 12 / 3.5 mm ²
	0.2	VFNC1-2002P	AWG 14 / 2.0 mm ²	AWG 16 / 1.25 mm ²	AWG 12 / 3.5 mm ²
	0.4	VFNC1-2004P	AWG 14 / 2.0 mm ²	AWG 16 / 1.25 mm ²	AWG 12 / 3.5 mm ²
	0.75	VFNC1-2007P	AWG 14 / 2.0 mm ²	AWG 14 / 2.0 mm ²	AWG 12 / 3.5 mm ²
	1.5	VFNC1-2015P	AWG 10 / 2.0 mm ²	AWG 14 / 2.0 mm ²	AWG 12 / 3.5 mm ²
	2.2	VFNC1-2022P	AWG 10 / 2.0 mm ²	AWG 14 / 2.0 mm ²	AWG 12 / 3.5 mm ²

Note 1: Sizes of the wires connected to the input terminals R, S and T and the output terminals U, V and W when the length of each wire does not exceed 30m.

Note 2: For the control circuit, use shielded wires 0.75 mm² or more in diameter.

Note 3: For grounding, use a cable with a size equal to or larger than the above.

Note 4: When using a crimp terminal, cover its caulked part with a tube or use an insulated terminal.

■ Selection of wiring devices

Voltage class	Capacity of applicable motor (kW)	Inverter model	Non-fuse circuit breaker (MCCB) Earth leakage breaker (ELCB)				Magnetic contactor (MC)				Overload relay (THR)	
			Without reactor		With DC reactor		Without reactor		With DC reactor		Adjusted current (A) (For reference)	Type Note1)
			Rated current (A)	Type MCCB / (ELCB) Note1)	Rated current (A)	Type MCCB / (ELCB) Note1)	Rated current (A)	Type Note1)	Rated current (A)	Type Note1)		
Single-phase 100V class	0.1	VFNC1S-1001P	5		---	---	13		---	---	0.7	TH13U
	0.2	VFNC1S-1002P	10	NJ30E (NVJ30E)	---	---	13	CA13	---	---	1.3	
	0.4	VFNC1S-1004P	15		---	---	13		---	---	2.3	
	0.75	VFNC1S-1007P	30	---	---	19	CA20	---	---	3.6		
Single-phase 200V class	0.2	VFNC1S-2002P(L)	5	NJ30E (NVJ30E)	5	NJ30E (NVJ30E)	13	CA13	13	CA13	1.3	
	0.4	VFNC1S-2004P(L)	10		5		13		13		2.3	
	0.75	VFNC1S-2007P(L)	15		10		13		13		3.6	
	1.5	VFNC1S-2015P(L)	20		15		19	CA20	13		6.8	
	2.2	VFNC1S-2022P(L)	30		30		26	CA25	19		CA20	
Three-phase 200V class	0.1	VFNC1-2001P	5	NJ30E (NVJ30E)	5	NJ30E (NVJ30E)	13	CA13	13	CA13	0.7	
	0.2	VFNC1-2002P	5		5		13		13		1.3	
	0.4	VFNC1-2004P	5		5		13		13		2.3	
	0.75	VFNC1-2007P	10		5		13		13		3.6	
	1.5	VFNC1-2015P	15		10		13		13		6.8	
2.2	VFNC1-2022P	20	15	13	13	9.3						

Note 1: Produced by Toshiba Industrial Products Sales Corporation.

Note 2: Be sure to attach a surge killer to the exciting coil of the relay and the magnetic contactor.

Note 3: When using the auxiliary contacts 2a of the magnetic contactor MC for the control circuit, connect the contacts 2a in parallel to increase reliability.

10.2 Installation of a magnetic contactor

If using the inverter without installing a magnetic contactor (MC) in the primary circuit, use an MCCB (with a power cutoff device) to open the primary circuit when the inverter protective circuit is activated.

■Magnetic contactor in the primary circuit

A magnetic contactor, if installed in the power supply circuit of the inverter, cuts off the power supply to the circuit and prevents the inverter from restarting, in the event of a power failure, a trip of the overload relay (thermal relay) or the activation of the inverter protective circuit.

In addition, if the FL contact of the failure detection relay in the VF-nC1 is connected to the operation circuit of the magnetic contactor on the primary side, the magnetic contactor (MC) will be tripped when the inverter protective circuit is activated.

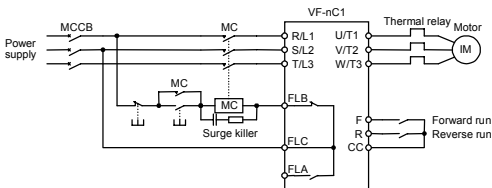

Example of connection of a magnetic contactor in the primary circuit

Notes on wiring

- When frequently switching between start and stop, do not use the magnetic contactor on the primary side as an on-off switch for the inverter. Instead, stop and start the inverter by using terminals F and CC (forward run) or R and CC (reverse run).
- Be sure to attach a surge killer to the exciting coil of the magnetic contactor (MC).

■Magnetic contactor in the secondary circuit

A magnetic contactor may be installed on the secondary side to switch controlled motors or supply commercial power to the load when the inverter is out of operation.

Notes on wiring

- Be sure to interlock the magnetic contactor on the secondary side with the power supply to prevent commercial power from being applied to the inverter output terminals.
- When installing a magnetic contactor (MC) between the inverter and the motor, avoid turning the magnetic contactor on or off during operation. Turning the magnetic contactor on or off during operation causes a current to rush into the inverter which could lead to malfunction.

10.3 Installation of an overload relay

- 1) The VF-nC1 inverter has an electronic-thermal overload protective function. In the following cases, however, the activation level of the electronic thermal protection unit must be adjusted and an overload relay suitable for the motor installed between the inverter and the motor.
 - When using a motor with a current rating different to that of the corresponding Toshiba general-purpose motor
 - When operating a single motor with an output smaller than that of the applicable standard motor or more than one motor simultaneously
- 2) When using the VF-nC1 inverter to operate a constant-torque motor, such as the Toshiba VF motor, adjust the protection characteristic of the electronic thermal protection unit to the VF motor use.
- 3) It is recommended to use a motor with a thermal relay embedded in the motor coil to give sufficient protection to the motor, especially when it runs in a low-speed range.

11. Table of parameters and data

11.1 User parameters

Title	Function	Unit	Minimum setting unit Panel/ Communication	Adjustment range	Default setting	User setting	Reference
<i>F</i> ζ	Operation frequency of operation panel	Hz	0.1/0.01	$\zeta \zeta - \zeta \zeta$	0.0		3.1.2

11.2 Basic parameters

Title	Communication No.	Function	Unit	Minimum setting unit Panel/ Communication	Adjustment range	Default setting	User setting	Reference
<i>R</i> <i>U</i> <i>H</i>	-	History function	-	-	Display latest 5 changed parameters as a group. * Parameters can be edited within a group.	-		4.1.3
<i>R</i> <i>U</i> <i>F</i>	-	Wizard function	-	-	0:- 1:Basic setting wizard 2:Preset speed operation wizard 3:Analog signal operation wizard 4:Motor 1/2 switching operation wizard 5:Torque up wizard *1	0		4.1.3
<i>C</i> <i>M</i> <i>D</i>	0003	Command mode selection	-	-	0:Terminal block 1:Operation panel	1		5.1
<i>F</i> <i>M</i> <i>D</i>	0004	Frequency setting mode selection	-	-	0:Terminal block 1:Operation panel 2:Internal potentiometer 3:Serial communication 4:Terminal block/internal potentiometer switching	2		5.1
<i>F</i> <i>M</i> <i>S</i>	0005	FM/OUT terminal functions selection	-	-	-1: Open collector output 0:Output frequency 1:Output current 2:Set frequency 3:For adjustment (current fixed at 100%) 4:For adjustment (current fixed at 50%) 5:For adjustment (output of max. frequency) 6:For adjustment (display of gain)	0		5.2
<i>F</i> <i>M</i>	0006	Meter adjustment	-	-	-	-		5.2

*1: This parameter is valid only for VFNC1 (S)-□□□□P□-W type.

Title	Communication No.	Function	Unit	Minimum setting unit Panel/Communication	Adjustment range	Default setting	User setting	Reference																																				
ϵYP	0007	Standard setting mode selection	-	-	0:- 1:Set at 50Hz 2:Set at 60Hz 3:Default setting 4:Trip clear 5:Cumulative operation time clear	0		5.3																																				
F_r	0008	Forward/reverse selection (Operation panel)	-	-	0:Forward run 1:Reverse run	0		5.4																																				
R_{CC}	0009	Acceleration time 1	s	0.1/0.1	0.1-3000	10.0		5.5																																				
d_{EC}	0010	Deceleration time 1	s	0.1/0.1	0.1-3000	10.0		5.5																																				
FH	0011	Maximum frequency	Hz	0.1/0.01	30.0-200	*2		5.6																																				
UL	0012	Upper limit frequency	Hz	0.1/0.01	0.5- FH	*2		5.7																																				
LL	0013	Lower limit frequency	Hz	0.1/0.01	0.0- UL	0.0		5.7																																				
uL	0014	Base frequency 1	Hz	0.1/0.01	25-200	*2		5.8																																				
$P\epsilon$	0015	V/F control mode selection	-	-	0 (1, 2): V/F 3: Sensorless vector control	0		5.9																																				
u_b	0016	Torque boost 1	%	0.1/0.1	0.0-30.0	*3		5.9																																				
ϵHr	0600	Motor thermal protection level 1	%	1/1	30-100	100		5.10																																				
ULN	0017	Electronic thermal protection characteristic *4	-	-	<table border="1"> <thead> <tr> <th>Setting</th> <th>Standard motor</th> <th>Overload protection</th> <th>Overload stall</th> </tr> </thead> <tbody> <tr> <td>0</td> <td></td> <td>○</td> <td>×</td> </tr> <tr> <td>1</td> <td></td> <td>○</td> <td>○</td> </tr> <tr> <td>2</td> <td></td> <td>×</td> <td>×</td> </tr> <tr> <td>3</td> <td></td> <td>×</td> <td>○</td> </tr> <tr> <td>4</td> <td></td> <td>○</td> <td>×</td> </tr> <tr> <td>5</td> <td>VF motor</td> <td>○</td> <td>○</td> </tr> <tr> <td>6</td> <td></td> <td>×</td> <td>×</td> </tr> <tr> <td>7</td> <td></td> <td>×</td> <td>○</td> </tr> </tbody> </table>	Setting	Standard motor	Overload protection	Overload stall	0		○	×	1		○	○	2		×	×	3		×	○	4		○	×	5	VF motor	○	○	6		×	×	7		×	○	0		5.10
Setting	Standard motor	Overload protection	Overload stall																																									
0		○	×																																									
1		○	○																																									
2		×	×																																									
3		×	○																																									
4		○	×																																									
5	VF motor	○	○																																									
6		×	×																																									
7		×	○																																									
$Sr1$	0018	Preset speed operation frequencies 1	Hz	0.1/0.01	$LL - UL$	0.0		5.11																																				
$Sr2$	0019	Preset speed operation frequencies 2	Hz	0.1/0.01	$LL - UL$	0.0																																						
$Sr3$	0020	Preset speed operation frequencies 3	Hz	0.1/0.01	$LL - UL$	0.0																																						
$Sr4$	0021	Preset speed operation frequencies 4	Hz	0.1/0.01	$LL - UL$	0.0																																						
$Sr5$	0022	Preset speed operation frequencies 5	Hz	0.1/0.01	$LL - UL$	0.0																																						
$Sr6$	0023	Preset speed operation frequencies 6	Hz	0.1/0.01	$LL - UL$	0.0																																						
$Sr7$	0024	Preset speed operation frequencies 7	Hz	0.1/0.01	$LL - UL$	0.0																																						
$F--$	-	Extended parameter	-	-	-	-	-	4.1.2																																				
$Gr.U$	-	Search for changed settings	-	-	-	-	-	4.1.3																																				

*2: The value is changed according to the set-up parameter condition.

(VFNC1 (S)-□□□□□□□-W type)

FH:80, UL:80, VL:60, F127:0, F170:60, F171:200, F204:80, F409:200, F417:1710 for VFNC1 (S)-□□□□□□□ type.

*3: Parameter values vary depending on the capacity. Refer to page K-8.

*4: ○ : Applicable, × : Inapplicable

11.3 Extended parameters

• Input/output parameters

Title	Communication No.	Function	Unit	Minimum setting unit Panel/Communication	Adjustment range	Default setting	User setting	Reference
F100	0100	Low speed signal output frequency	Hz	0.1/0.01	0.6-FH	0.6		6.1.1
F101	0101	Speed-reach setting frequency	Hz	0.1/0.01	0.0-FH	0.0		6.1.2
F109	0109	Analog input/logic input function selection (VI/S3)	-	-	0: Voltage signal input (0-5 or 10V) 1: Current signal input (4-20mA) 2: Contact input	0		6.2.1
F110	0110	Always active function selection	-	-	0-40, 49, 54-61	1 (ST)		6.2.2
F111	0111	Input terminal selection 1 (F)	-	-	0-40, 49, 54-61	2 (F)		6.2.3
F112	0112	Input terminal selection 2 (R)	-	-	0-40, 49, 54-61	3 (R)		6.2.3
F113	0113	Input terminal selection 3 (S1)	-	-	0-40, 49, 54-61	6 (SS1)		6.2.3
F114	0114	Input terminal selection 4 (S2)	-	-	0-40, 49, 54-61	7 (SS2)		6.2.3
F115	0115	Input terminal selection 5 (VI/S3)*5	-	-	5-17	8 (SS3)		6.2.3
F127	0127	Sink/Source selection	-	-	0: Sink 100: Source 1-99, 101-200: Disabled	*2		6.2.5
F130	0130	Output terminal selection 1 (FM/OUT)*6	-	-	0-13	4 (LOW)		6.2.6
F132	0132	Output terminal selection 3 (FL)	-	-	0-13	10 (FL)		6.2.6
F170	0170	Base frequency 2	Hz	0.1/0.01	25-200	*2		6.3.1
F171	0171	Base frequency voltage 2	V	1/1	50-500	*2		6.3.1
F172	0172	Torque boost 2	%	0.1/0.1	0.0-30.0	*3		6.3.1
F173	0173	Motor thermal protection level 2	%	1/1	30-100	100		6.3.1

*2: The value is changed according to the set-up parameter condition.

(VFNC1 (S)-□□□□P□-W type)

FH:80, UL:80, VL:60, F127:0, F170:60, F171:200, F204:80, F409:200, F417:1710 for VFNC1 (S)-□□□□P□ type.

*3: Parameter values vary depending on the capacity. Refer to page K-8.

*5: This function is enabled if F109 is set at 2 (logic input).

*6: This function is enabled if F132 (open collector output) is set at 1.

• Frequency parameters

Title	Communication No.	Function	Unit	Minimum setting unit Panel/Communication	Adjustment range	Default setting	User setting	Reference
F201	0201	VI/S3 reference point 1 setting	%	1/1	0-100	0		6.4.1
F202	0202	VI/S3 point 1 frequency	Hz	0.1/0.01	0-200	0.0		6.4.1
F203	0203	VI/S3 reference point 2 setting	%	1/1	0-100	100		6.4.1
F204	0204	VI/S3 point 2 frequency	Hz	0.1/0.01	0-200	*2		6.4.1
F240	0240	Starting frequency setting	Hz	0.1/0.01	0.5-10.0	0.5		6.5.1
F241	0241	Operation starting frequency	Hz	0.1/0.01	0.0-FH	0.0		6.5.2
F242	0242	Operation starting frequency hysteresis	Hz	0.1/0.01	0.0-FH	0.0		6.5.2
F250	0250	DC braking starting frequency	Hz	0.1/0.01	0.0-FH	0.0		6.6.1
F251	0251	DC braking current	%	1/1	0-100	50		6.6.1
F252	0252	DC braking time	S	0.1/0.1	0.0-20.0	1.0		6.6.1
F270	0270	Jump frequency	Hz	0.1/0.01	LL-UL	0.0		6.7
F271	0271	Jumping width	Hz	0.1/0.01	0.0-30.0	0.0		6.7
F287	0287	Preset speed operation frequencies 8	Hz	0.1/0.01	LL-UL	0.0		5.11
F288	0288	Preset speed operation frequencies 9	Hz	0.1/0.01	LL-UL	0.0		
F289	0289	Preset speed operation frequencies 10	Hz	0.1/0.01	LL-UL	0.0		
F290	0290	Preset speed operation frequencies 11	Hz	0.1/0.01	LL-UL	0.0		
F291	0291	Preset speed operation frequencies 12	Hz	0.1/0.01	LL-UL	0.0		
F292	0292	Preset speed operation frequencies 13	Hz	0.1/0.01	LL-UL	0.0		
F293	0293	Preset speed operation frequencies 14	Hz	0.1/0.01	LL-UL	0.0		
F294	0294	Preset speed operation frequencies 15	Hz	0.1/0.01	LL-UL	0.0		

*2: The value is changed according to the set-up parameter condition.

(VFNC1 (S)-□□□□P□-W type)

FH:80, UL:80, VL:60, F127:0, F170:60, F171:200, F204:80, F409:200, F417:1710 for VFNC1 (S)-□□□□

□PL-□ type.

• Operation mode parameters

Title	Communication No.	Function	Unit	Minimum setting unit Panel/Communication	Adjustment range	Default setting	User setting	Reference
F300	0300	PWM carrier frequency	-	-	0.2kHz 1:2kHz (Random mode) 2:4kHz 3:4kHz (Random mode) 4:8kHz(auto-reduction mode) 5:12kHz (auto-reduction mode) 6:16kHz (auto-reduction mode)	5		6.9
F301	0301	Auto-restart control selection	-	-	0:Disabled 1:At auto-restart after momentary stop 2:When turning ST-CC on or off 3:At auto-restart after momentary stop or when turning ST-CC on or off	0		6.10.1
F302	0302	Regenerative power ride-through control	-	-	0:Disabled 1:Enabled 2:Deceleration stop	0		6.10.2
F303	0303	Retry selection (Number of times)	Times	1/1	0(OFF), 1-10	0		6.10.3
F305	0305	Over voltage limit operation	-	-	0:Disabled 1:Enabled 2:Enabled (forced shortened deceleration)	0		6.10.4
F360	0360	PI control	-	-	0: Disabled 1: Enabled	0		6.11
F362	0362	Proportional (P) gain	-	0.01/0.01	0.01-100.0	0.30		6.11
F363	0363	Integral (I) gain	-	0.01/0.01	0.01-100.0	0.20		6.11

• Torque boost parameters

Title	Communication No.	Function	Unit	Minimum setting unit Panel/Communication	Adjustment range	Default setting	User setting	Reference
F401	0401	Slip frequency gain	%	1/1	0-150	50		6.12.1
F409	0409	Base frequency voltage 1	V	1/0.1	50-500	*2		6.12.1
F415	0415	Motor rated current	A	0.1/0.1	0.1-50.0	*3		6.12.2
F416	0416	Motor no-load current	%	1/1	30-80	*3		6.12.2
F417	0417	Motor rated speed	min ⁻¹	1/1	100-12000	*2		6.12.2
F418	0418	Speed control gain	%	1/1	0-100	40		6.12.2
F419	0419	Speed control stable coefficient	%	1/1	0-100	20		6.12.2

*2: The value is changed according to the set-up parameter condition.

(VFNC1 (S)-□□□□P□-W type)

FH:80, UL80, VL:60, F127:0, F170:60, F171:200, F204:80, F409:200, F417:1710 for VFNC1 (S)-□□□□P□ type.

*3: Parameter values vary depending on the capacity. Refer to page K-8.

• Acceleration/deceleration time parameters

Title	Communication No.	Function	Unit	Minimum setting unit Panel/Communication	Adjustment range	Default setting	User setting	Reference
F500	0500	Acceleration time 2	s	0.1/0.1	0.1-3000	10.0		6.13
F501	0501	Deceleration time 2	s	0.1/0.1	0.1-3000	10.0		6.13
F505	0505	Acceleration/deceleration 1 and 2 switching frequency	Hz	0.1/0.01	0-44	0.0		6.13

• Protection parameters

Title	Communication No.	Function	Unit	Minimum setting unit Panel/Communication	Adjustment range	Default setting	User setting	Reference
F601	0601	Stall prevention level	%	1/1	30-199 (%) 200 (disabled)	150		6.14.1
F602	0602	Inverter trip retention selection	-	-	0: Not retained, 1: Retained	0		6.14.2
F603	0603	External input trip stop mode selection	-	-	0:Coast stop 1:Slowdown stop 2:Emergency DC braking	0		6.14.3
F605	0605	Output phase failure detection mode selection	-	-	0:Disabled 1:Selected (Output open-phase is checked when operation is started for the first time after power is turned on.) 2:Selected (Output open-phase is checked each time operation is started.)	0		6.14.4
F607	0607	Motor 150%-overload time limit	s	1/1	10~800	300		6.14.5
F608	0608	Input phase failure detection mode selection	-	-	0: Disabled, 1: Enabled	1		6.14.6
F616	0616	Over-torque alarm level	%	1	0-200	150		6.14.7
F618	0618	Over-torque detection time	s	0.1	0.0 (Disabled), 0.1-10.0	0.5		6.14.7
F627	0627	Under voltage trip selection	-	-	0:Disabled 1:Enabled (64% or less: Trip, FL relay activated) 2:Disabled (50% or less: Trip, FL relay not activated)	0		6.14.8
F633	0633	Analog input disconnection detection	%	1	0 (Disabled), 1 - 100%	0		6.14.9

• Operation panel parameters

Title	Communication No.	Function	Unit	Minimum setting unit Panel/ Communication	Adjustment range	Default setting	User setting	Reference
F700	0700	Prohibition of change parameter settings	-	-	0: Permitted (F700, F700 cannot be changed during operation.) 1: Prohibited 2: Permitted (F700, F700 also can be changed during operation) 3: Prohibited (except for panel frequency setting.) 4: 0 + panel emergency stop prohibited 5: 1 + panel emergency stop prohibited 6: 2 + panel emergency stop prohibited 7: 3 + panel emergency stop prohibited	0		6.15.1
F701	0701	Unit selection	-	-	0: 0%, Hz (no change) 1: % to A/V 2: Free unit selection enabled (F702) 3: % to A/V, Free unit selection enabled (F702)	0		6.15.2
F702	0702	Frequency units selection	-	0.01/0.01	0.01-200.0	1.00		6.15.2
F710	0710	Selection of monitor display selection	-	-	0: Operation frequency (Hz/free unit) 1: Frequency command (Hz/free unit) 2: Output current (%/A)	0		6.15.3

• Communication parameters

Title	Communication No.	Function	Unit	Minimum setting unit Panel/ Communication	Adjustment range	Default setting	User setting	Reference
F800	0800	Communication baud rate	-	-	0: 1200bps 1: 2400bps 2: 4800bps 3: 9600bps 4: 19200bps	3		6.16
F801	0801	Parity	-	-	0: NON (non-parity) 1: EVEN (even parity) 2: ODD (odd parity)	1		6.16
F802	0802	Inverter number	-	1	0-99	0		6.16
F803	0803	Communication error trip time	s	1/1	0 (Disabled), 1 - 100 (s)	0		6.16
F880	0880	Free notes	-	1	0~65535 *	0		6.16

* Adjustment range of the above mention can set by the computer on the network.

The operation panel can set to the maximum 9999.

• Factory setting parameter

Title	Communication No.	Function	Unit	Minimum setting unit Panel/ Communication	Adjustment range	Default setting	User setting	Reference
F990	0990	For factory setting	-	-	-	0		-

* This function is effective after software version V110.

■Default settings by inverter rating

Inverter model	Torque boost (%)	Motor rated current (A)	No-load current (%)
	<i>u b 1 F 1 7 2</i>	<i>F 4 1 5</i>	<i>F 4 1 6</i>
VFNC1S-1001P	8.5	0.6	70
VFNC1S-1002P	8.3	1.2	70
VFNC1S-1004P	6.2	2.0	63
VFNC1S-1007P	5.8	3.4	59
VFNC1S-2002P	8.3	1.2	70
VFNC1S-2004P	6.2	2.0	63
VFNC1S-2007P	5.8	3.4	59
VFNC1S-2015P	4.6	6.2	52
VFNC1S-2022P	4.4	8.9	49
VFNC1-2001P	8.5	0.6	70
VFNC1-2002P	8.3	1.2	70
VFNC1-2004P	6.2	2.0	63
VFNC1-2007P	5.8	3.4	59
VFNC1-2015P	4.6	6.2	52
VFNC1-2022P	4.4	8.9	49
VFNC1S-2002PL	8.3	1.2	70
VFNC1S-2004PL	6.2	2.0	63
VFNC1S-2007PL	5.8	3.4	59
VFNC1S-2015PL	4.6	6.2	52
VFNC1S-2022PL	4.4	8.9	49

Table of input terminal functions 1

Function No.	Code	Function	Action
0	-	No function is assigned	No action
1	ST	Standby terminal	ON : Standby, OFF: Free run
2	F	Forward-run command	ON : Forward run, OFF : Deceleration stop
3	R	Reverse-run command	ON : Reverse run, OFF : Deceleration stop (priority to reverse run)
4	JOG	Jog run command	ON : Jog run, OFF: Canceled
5	AD2	Acceleration/deceleration 2 pattern selection	ON : Acceleration/deceleration 2, OFF : Acceleration/deceleration 1
6	SS1	Preset speed command 1	Selection of preset speeds (up to 15 speeds) using 4 bits: SS1 to SS4
7	SS2	Preset speed command 2	
8	SS3	Preset speed command 3	
9	SS4	Preset speed command 4	
10	RST	Reset command	ON : Reset command acceptable ON to OFF: Trip reset
11	EXT	Trip stop command from external input device	ON : \bar{E} Trip stop
12	PNL/TB	Operation panel / terminal board switching	ON : Forced switching from operation panel/internal potentiometer to terminal board control
13	DB	DC braking command	ON : DC braking
14	PI	Prohibition of PI control	ON : PI control prohibited OFF : PI control permitted
15	PWENE	Permission of parameter editing	ON : Edition of parameters permitted, OFF : Edition of parameter prohibited (If F_{700} is so set)
16	ST+RST	Combination of standby and reset commands	ON : Simultaneous input of ST and RST commands
17	ST+PNL/TB	Combination of standby and operation panel/terminal board switching	ON : Simultaneous input of ST and PNL/TB commands
18	F+JOG	Combination of forward run and jog run	ON : Simultaneous input of F and JOG commands
19	R+JOG	Combination of reverse run and jog run	ON : Simultaneous input of R and JOG commands
20	F+AD2	Combination of forward run and acceleration/deceleration 2	ON : Simultaneous input of F and AD2 commands
21	R+AD2	Combination of reverse run and acceleration/deceleration 2	ON : Simultaneous input of R and AD2 commands
22	F+SS1	Combination of forward run and preset speed command 1	ON : Simultaneous input of F and SS1 commands
23	R+SS1	Combination of reverse run and preset speed command 1	ON : Simultaneous input of R and SS1 commands
24	F+SS2	Combination of forward run and preset speed command 2	ON : Simultaneous input of F and SS2 commands
25	R+SS2	Combination of reverse run and preset speed command 2	ON : Simultaneous input of R and SS2 commands
26	F+SS3	Combination of forward run and preset speed command 3	ON : Simultaneous input of F and SS3 commands
27	R+SS3	Combination of reverse run and preset speed command 3	ON : Simultaneous input of R and SS3 commands
28	F+SS4	Combination of forward run and preset speed command 4	ON : Simultaneous input of F and SS4 commands

■Table of input terminal functions 2

Function No.	Code	Function	Action
29	R+SS4	Combination of reverse run and preset speed command 4	ON : Simultaneous input of R and SS4 commands
30	F+SS1+AD2	Combination of forward run, preset speed command 1 and acceleration/deceleration 2	ON : Simultaneous input of F, SS1 and AD2 commands
31	R+SS1+AD2	Combination of reverse run, preset speed command 1 and acceleration/deceleration 2	ON : Simultaneous input of R, SS1 and AD2 commands
32	F+SS2+AD2	Combination of forward run, preset speed command 2 and acceleration/deceleration 2	ON : Simultaneous input of F, SS2 and AD2 commands
33	R+SS2+AD2	Combination of reverse run, preset speed command 2 and acceleration/deceleration 2	ON : Simultaneous input of R, SS2 and AD2 commands
34	F+SS3+AD2	Combination of forward run, preset speed command 3 and acceleration/deceleration 2	ON : Simultaneous input of F, SS3 and AD2 commands
35	R+SS3+AD2	Combination of reverse run, preset speed command 3 and acceleration/deceleration 2	ON : Simultaneous input of R, SS3 and AD2 commands
36	F+SS4+AD2	Combination of forward run, preset speed command 4 and acceleration/deceleration 2	ON : Simultaneous input of F, SS4 and AD2 commands
37	R+SS4+AD2	Combination of reverse run, preset speed command 4 and acceleration/deceleration 2	ON : Simultaneous input of R, SS4 and AD2 commands
38	FCHG	Frequency command forced switching	Enabled if $F\overline{P}\overline{D}d = 4$ (selectable between terminal board and operation panel/internal potentiometer) ON : V1 terminal OFF : Internal potentiometer
39	THR2	No.2 thermal switching	ON : No.2 thermal ($Pt:0, F170, F171, F172, F173$) OFF : No.1 thermal ($Pt: Setting, uL, F409, ub, tHr$)
40	MCHG	No.2 motor switching	ON : No.2 motor ($Pt:0, F170, F171, F172, F173, F500, F501$) OFF : No.1 motor ($Pt: Setting, uL, F409, ub, tHr, RLC, dEL$)
49	HD	Operation holding (Stop of 3-wire operation)	ON : F (forward run) / R (reverse run) held, 3-wire operation OFF : Slowdown stop
54	FreeRun	Standby (inversion)	ON : Free run OFF : Standby
55	RSTN	Reset signal (inversion)	OFF to ON: Trip reset
56	F+ST	Combination of forward run and standby commands	ON : Simultaneous input of F and ST commands
57	R+ST	Combination of reverse run and standby commands	ON : Simultaneous input of R and ST commands

*1 This function is effective after software version V110.

■Table of input terminal functions 3

*2	58	SS1+AD2	Combination of preset speed command 1 and acceleration/deceleration 2	ON : Simultaneous input of SS1 and AD2 commands
*2	59	SS2+AD2	Combination of preset speed command 2 and acceleration/deceleration 2	ON : Simultaneous input of SS2 and AD2 commands
*2	60	SS3+AD2	Combination of preset speed command 3 and acceleration/deceleration 2	ON : Simultaneous input of SS3 and AD2 commands
*2	61	SS4+AD2	Combination of preset speed command 4 and acceleration/deceleration 2	ON : Simultaneous input of SS4 and AD2 commands

*2 This function is effective after software version V120.

■Table of output terminal functions 1

Function No.	Code	Function	Action
0	LL	Frequency lower limit	ON : Output frequency higher than \underline{LL} setting OFF : Output frequency equal to or lower than \underline{LL} setting
1	LLN	Inversion of frequency lower limit	Inverse output of LL
2	UL	Frequency upper limit	ON : Output frequency equal to or higher than \overline{UL} setting OFF : Output frequency lower than \overline{UL} setting
3	ULN	Inversion of frequency upper limit	Inverse output of UL
4	LOW	Low-speed detection signal	ON : Output frequency equal to or higher than $F \overline{LO}$ setting OFF : Output frequency lower than $F \overline{LO}$ setting
5	LOWN	Inversion of low-speed detection signal	Inverse output of LOW
6	RCH	Designated frequency reach signal (completion of acceleration/deceleration)	ON : Output frequency within command frequency $\pm 2.5\text{Hz}$ OFF : Output frequency exceeding command frequency $\pm 2.5\text{Hz}$
7	RCHN	Inversion of designated frequency reach signal (inversion of completion of acceleration/deceleration)	Inverse output of RCH
8	RCHF	Set frequency reach signal	ON : Output frequency within $F \overline{FO}$ setting $\pm 2.5\text{Hz}$ OFF : Output frequency exceeding $F \overline{FO}$ setting $\pm 2.5\text{Hz}$
9	RCHFN	Inversion of set frequency reach signal	Inverse output of RCHF
10	FL	Failure FL (trip output)	ON : Inverter trips
11	FLN	Inversion of failure FL (inversion of trip output)	Inverse output of FL
12	OT	Over-torque detection	ON : Torque current is held above the torque set with $F \overline{BO}$ for a period of time longer than that set with $F \overline{BO}$.
13	OTN	Inversion of over-torque detection	Inverse output of OT

Order of precedence of combined functions

XX: Impossible combination, X: Invalid, +: Valid under some conditions, O: Valid, @: Priority

Function No. / Function	2	3	4	5	6 9	10	11	12	13	14	15	38	1 54	39	40	
2 Forward run command		X	O	O	O	O	X	O	X	O	O	O	O	X	O	O
3 Reverse run command	@		O	O	O	O	X	O	X	O	O	O	O	X	O	O
4 Jog run command (18/19)	+	+		@	+	O	X	O	X	@	O	O	X	O	@	
5 Acceleration/deceleration 2 selection	O	O	X		O	O	X	O	X	O	O	O	O	X	O	+
6~9 Preset-speed run commands 1 to 4	O	O	X	O		O	X	O	X	O	O	O	O	X	O	O
10 Reset command	O	O	O	O	O		X	O	O	O	O	O	O	O	O	O
11 Trip stop command from external input device	@	@	@	@	@	@		O	@	@	O	O	@	@	@	
12 Operation panel/terminal board switching	O	O	O	O	O	O	O		O	O	O	O	O	O	O	
13 DC braking command	@	@	@	@	@	O	X	O		@	O	O	X	@	@	
14 PI control prohibition	O	O	X	O	O	O	X	O	X		O	O	X	O	O	
15 Permission of parameter editing	O	O	O	O	O	O	O	O	O	O		O	O	O	O	
38 Frequency commands forced switching	O	O	O	O	O	O	O	O	O	O	O		O	O	O	
1.54 Free run stop	@	@	@	@	@	O	O	O	@	@	O	O		@	@	
39 No.2 thermal switching	+	+	+	O	+	O	X	O	X	O	O	O	O		+	
40 No.2 motor switching	+	+	+	@	+	O	X	O	X	O	O	O	O	@		

*For the functions of combined terminals (combined functions), refer to the table of their respective functions.

12. Specifications

12.1 Models and their standard specifications

■ Standard specifications

Item		Specification					
Input voltage		3-phase 200V					
Applicable motor (kW)		0.1	0.2	0.4	0.75	1.5	2.2
Rating	Type	VFNC1					
	Form	2001P	2002P	2004P	2007P	2015P	2022P
	Capacity (kVA) Note 1)	0.3	0.6	1.0	1.6	2.9	3.9
	Rated output current (A) Note 2)	0.7	1.4	2.4	4.0	7.5	10.0
	Rated output voltage Note 3)	3-phase 200V to 240V					
Overload current rating	60 seconds at 150%, (50%-reduction value)						
Power supply	Voltage-frequency	3-phase 200V to 240V - 50/60Hz					
	Allowable fluctuation	25/Voltage +10%, -15% Note 4), frequency $\pm 5\%$					
	Ampere Interrupt Capacity (A) AIC	1000	1000	1000	1000	5000	5000
	Protective method	IP20 Enclosed type (JEM 1030)					
	Cooling method	Self-cooling			Forced air-cooled		
Color	Munsell 5Y8/0.5						
Charge lamp	LED indicating the charge status of the capacitor in the main circuit						
Built-in filter	-						

Item		Specification					
Input voltage		1-phase 200V					
Applicable motor (kW)		0.1	0.2	0.4	0.75	1.5	2.2
Rating	Type	VFNC1S					
	Form	-	2002P	2004P	2007P	2015P	2022P
	Capacity (kVA) Note 1)	-	0.6	1.0	1.6	2.9	3.9
	Rated output current (A) Note 2)	-	1.4	2.4	4.0	7.5	10.0
	Rated output voltage Note 3)	3-phase 200V to 240V					
Overload current rating	60 seconds at 150%, (50%-reduction value)						
Power supply	Voltage-frequency	1-phase 200V to 240V - 50/60Hz					
	Allowable fluctuation	Voltage +10%, -15% Note 4), frequency $\pm 5\%$					
	Ampere Interrupt Capacity (A) AIC	-	1000	1000	1000	5000	5000
	Protective method	IP20 Enclosed type (JEM 1030)					
	Cooling method	-	Self-cooling			Forced air-cooled	
Color	Munsell 5Y8/0.5						
Charge lamp	LED indicating the charge status of the capacitor in the main circuit						
Built-in filter	-						

Item		Specification					
Input voltage		1-phase 100V					
Applicable motor (kW)		0.1	0.2	0.4	0.75	1.5	2.2
Rating	Type	VFNC1S					
	Form	1001P	1002P	1004P	1007P	-	-
	Capacity (kVA) Note 1)	0.3	0.6	1.0	1.6	-	-
	Rated output current (A) Note 2)	0.7	1.4	2.4	4.0	-	-
	Rated output voltage Note 3)	3-phase 200V to 230V					
Power supply	Overload current rating	60 seconds at 150%, (50%-reduction value)					
	Voltage-frequency	1-phase 100V to 115V - 50/60Hz					
	Allowable fluctuation	Voltage +10%, -15% Note 4), frequency $\pm 5\%$					
	Ampere Interrupt Capacity (A) AIC	1000	1000	1000	1000	-	-
	Protective method	IP20 Enclosed type (JEM 1030)					
	Cooling method	Self-cooling			Forced air-cooled		-
Color		Munsell 5Y8/0.5					
Charge lamp		LED indicating the charge status of the capacitor in the main circuit					
Built-in filter		-					

Item		Specification					
Input voltage		1-phase 200V (built-in EM1 noise filter)					
Applicable motor (kW)		0.1	0.2	0.4	0.75	1.5	2.2
Rating	Type	VFNC1S					
	Form	-	2002PL	2004PL	2007PL	2015PL	2022PL
	Capacity (kVA) Note 1)	-	0.5	0.9	1.6	2.9	4.1
	Rated output current (A) Note 2)	-	1.2	2.3	4.0	7.5	10.7
	Rated output voltage Note 3)	3-phase 200V to 240V					
Power supply	Overload current rating	60 seconds at 150%, (50%-reduction value)					
	Voltage-frequency	1-phase 200V to 240V - 50/60Hz					
	Allowable fluctuation	Voltage +10%, -15% Note 4), frequency $\pm 5\%$					
	Ampere Interrupt Capacity (A) AIC	-	1000	1000	1000	5000	5000
	Protective method	IP20 Enclosed type (JEM 1030)					
	Cooling method	-	Self-cooling			Forced air-cooled	
Color		Munsell 5Y8/0.5					
Charge lamp		None					
Built-in filter		EMC noise filter (Class B)					

Note)

- Capacity is calculated at 220V for the 200V models.
- Indicates rated output current setting when the PWM carrier frequency (parameter $F300$) is 4kHz or less.
If the PWM carrier frequency setting is fixed above 4 kHz, the rated current needs to be reduced. If the PWM carrier frequency is set above 4 kHz, it could fall automatically if an over-current flaws during acceleration or for any other reason, depending on the amount of current that flows.
The default setting of the PWN carrier frequency is 12kHz.
- Maximum output voltage is the same as the input voltage.
With regard to 100V models, the output voltage may decrease about 10 to 20% if motor load is applied.
When operating VFNC1 in conjunction with general purpose motor (200V), it is necessary to reduce the motor load.
- $\pm 10\%$ when the inverter is used continuously (load of 100%).

Item	Specification		
Principal control functions	Control system	Sinusoidal PWM control	
	Rated output voltage	Adjustable of output voltage in base frequency setting by the correcting supply voltage (Unadjustable to any voltage higher than the input voltage).	
	Output frequency range	0.5 to 200Hz, default setting: 0.5 to 80Hz, maximum frequency: 30 to 200Hz.	
	Minimum setting steps of frequency	operation panel setting, 0.2Hz: analog input (when the max. frequency is 100Hz).	
	Frequency accuracy	Digital setting: within $\pm 0.5\%$ of the max. frequency (-10 to $+50^{\circ}\text{C}$) Analog setting: within $\pm 1.0\%$ of the max. frequency ($25^{\circ}\text{C} \pm 10^{\circ}\text{C}$)	
	Voltage/frequency characteristics	V/f constant, Sensorless vector control, base frequency, base frequency voltage and torque boost amount adjustable	
	Frequency setting signal	Potentiometer on the front panel, external frequency potentiometer (connectable to a potentiometer with a rated impedance of 3-10k Ω), V1/S3 terminal (input impedance: 42k Ω (voltage: 0-10Vdc) or 250 Ω (current: 4-20mAdc)). The characteristic can be set arbitrarily by two-point setting.	
	Start-up frequency/frequency jump	Adjustable within a range of 0.5 to 10Hz / Up to 1 frequency can be adjusted together with their widths.	
	PWM carrier frequency (Note 1)	Selectable from among 2, 4, 8, 12 and 16kHz (Standard default setting: 12kHz), Selectable between fixed mode and auto-reduction mode	
	Acceleration/deceleration time	0.1 to 3000 seconds, switchable between acceleration/deceleration time 1 and 2.	
Operation specifications	Retry operation	Number of times of retry selectable (Max. 10 times). If the protection function is activated, the retry function restarts on completion of a check of the main circuit.	
	Dynamic braking	Charging of capacitor (Deceleration time can be shortened by activating Forced Shortened Deceleration mode.)	
	Dynamic braking	Driving circuit for braking resistor is not provided.	
	DC braking	Braking start-up frequency: 0 to maximum frequency, braking rate: 0 to 100%, braking time: 0 to 20 seconds.	
	Input terminal functions (selectable)	Selectable from among 45 functions, such as forward/reverse run input signal, jog run input signal, standby signal, preset-speed operation input signal, and reset input signal (Also, selectable between sink/source)	
	Output terminal functions (selectable)	Selectable from among 14 functions, such as frequency lower limit output signal, frequency upper limit output signal, low-speed detection output signal, and specified speed attainment output signal. Open collector and relay output possible	
	Failure detection signal	1c-contact output: $250\text{Vac}-1\text{A}-\cos\phi = 0.4$	
	Output for frequency meter/output for ammeter	PWM output: (1mAdc full-scale DC ammeter or 7.5Vdc full-scale DC ammeter/Rectifier-type AC voltmeter, 225% current Max. 1mAdc, 7.5Vdc full-scale)	
	Protective function	Protective function	Stall prevention, current limitation, over-current, output short circuit, over-voltage, over-voltage limitation, undervoltage, ground fault, power supply phase failure, output phase failure, overload protection by electronic thermal function, armature over-load at start-up, load-side over-torque at start, overheating prevention, detection of analog signal break.
		Protection against momentary power failure	Auto-restart/non-stop control after momentary power failure.
Electronic thermal characteristics		Switching between standard motor/constant-torque VF motor, overload trip, overload stall selection.	
Display function	4-digit 7-segments LED	Frequency: inverter output frequency. Alarm : Stall alarm "C", overvoltage alarm "P", overload alarm "L", overheat alarm "H". Status : Inverter status (frequency, cause of activation of protective function, input/output voltage, output current, etc.) and parameter settings. Free-unit display : Arbitrary unit (e.g. rotating speed) corresponding to output frequency.	
	Indicator	Lamps indicating the inverter status by lighting or blinking, such as RUN lamp and PRG lamp.	
Environments	Use environments	Indoor, altitude: 1000m (Max.), not exposed to direct sunlight, corrosive gas, explosive gas or vibration (less than 5.9m/s ²) (10 to 55Hz).	
	Ambient temperature	-10 to 50°C Note)1,2	
	Storage temperature	-20 to +65°C	
	Relative humidity	20 to 93% (free from condensation and vapor).	

Note)1. Above 40°C: Remove the protective seal from the top of VF-nC1, and reduce the rated output current. (See 1.4.4 and 6.9)

Note)2. When installing inverters side by side (without allowing space between them), detach the label on the top surface of each inverter and use them where the ambient temperature is below 40°C, and reduce rated output current. (See 1.4.4 and 6.9)

12.2 External dimensions/weights

■External dimensions/weights

Input voltage	Applicable motor (kW)	Type	Dimensions (mm)						Drawing	Approx. weight (kg)
			W	H	D	W1	H1	D1		
1-phase 200V (Standard)	0.2	VFNC1S-2002P	72	142	100	60	131	8.5	A	1.0
	0.4	VFNC1S-2004P			124					1.0
	0.75	VFNC1S-2007P			137					1.0
	1.5	VFNC1S-2015P	117		155	106			B	1.5
3-phase 200V	2.2	VFNC1S-2022P	72	142	100	60	131	8.5	A	1.0
	0.1	VFNC1-2001P			124					1.0
	0.2	VFNC1-2002P			137					1.0
	0.4	VFNC1-2004P	117		155	106			B	1.5
	0.75	VFNC1-2007P	117		155	106			B	1.5
	1.5	VFNC1-2015P	117		155	106			B	1.5
1-phase 100V	2.2	VFNC1S-2022P	72	142	100	60	131	8.5	A	1.0
	0.1	VFNC1S-1001P			124					1.0
	0.2	VFNC1S-1002P			137					1.0
	0.4	VFNC1S-1004P	117		155	106			B	1.5
1-phase 200V (Europe)	0.75	VFNC1S-1007P	72	142	100	60	131	8.5	A	1.0
	0.2	VFNC1S-2002PL			124					1.0
	0.4	VFNC1S-2004PL			137					1.0
	0.75	VFNC1S-2007PL	117		155	106			B	1.5
	1.5	VFNC1S-2015PL	117		155	106			B	1.5
2.2	VFNC1S-2022PL	117	155	106	B	1.5				

■External dimensions

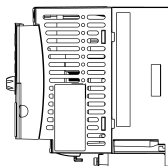
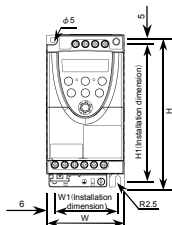

Fig. A

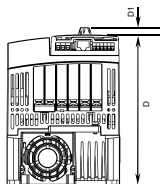
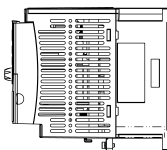
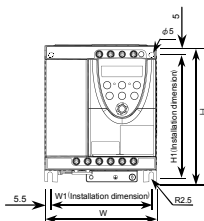

Fig. B

13. Before making a service call - Trip information and remedies

13.1 Trip causes/warnings and remedies

When a problem arises, diagnose it in accordance with the following table. If it is found that replacement of parts is required or the problem cannot be solved by any remedy described in the table, contact your Toshiba dealer.

[Trip information: FL relay activated]

Error code	Alarm code	Problem	Possible causes	Remedies
<i>0C1</i>	0001	Overcurrent during acceleration	<ul style="list-style-type: none"> The acceleration time <i>ACC</i> is too short. The V/F setting is improper. A restart signal is input to the rotating motor after a momentary stop, etc. A special motor (e.g. motor with a small impedance) is used. 	<ul style="list-style-type: none"> Increase the acceleration time <i>ACC</i>. Check the V/F parameter. Use <i>F301</i> (auto-restart) and <i>F302</i> (ride-through control). Increase or decrease the carrier frequency <i>F300</i>.
<i>0C1P</i>	0025	Overcurrent flowing in element during acceleration		
<i>0C2</i>	0002	Overcurrent during deceleration	<ul style="list-style-type: none"> The deceleration time <i>dEC</i> is too short. 	<ul style="list-style-type: none"> Increase the deceleration time <i>dEC</i>.
<i>0C2P</i>	0026	Overcurrent flowing in element during acceleration		
<i>0C3</i>	0003	Overcurrent during operation	<ul style="list-style-type: none"> The load fluctuates abruptly. The load is in an abnormal condition. 	<ul style="list-style-type: none"> Reduce the load fluctuation. Check the load (operated machine).
<i>0C3P</i>	0027	Overcurrent flowing in element during acceleration		
<i>0C4</i>	0005	Arm overcurrent at start-up	<ul style="list-style-type: none"> A main circuit element is defective. 	<ul style="list-style-type: none"> Make a service call.
<i>0C4L</i>	0004	Overcurrent (An overcurrent on the load side at start-up)	<ul style="list-style-type: none"> The insulation of the output main circuit or motor is defective. The motor has too small impedance. 	<ul style="list-style-type: none"> Check the cables and wires for defective insulation.
<i>0P1</i>	000A	Overvoltage during acceleration	<ul style="list-style-type: none"> The input voltage fluctuates abnormally. ①The power supply has a capacity of 200kVA or more. ②A power factor improvement capacitor is opened or closed. ③A system using a thyristor is connected to the same power distribution line. A restart signal is input to the rotating motor after a momentary stop, etc. 	<ul style="list-style-type: none"> Insert a suitable input reactor. Use <i>F301</i> (auto-restart) and <i>F302</i> (ride-through control).

(Continued overleaf)

(Continued)

Error code	Alarm code	Problem	Possible causes	Remedies
$\overline{OP2}$	000B	Overvoltage during deceleration	<ul style="list-style-type: none"> The deceleration time $d\overline{EL}$ is too short. (Regenerative energy is too large.) $F305$ (overvoltage limit operation) is off. The input voltage fluctuates abnormally. <p>①The power supply has a capacity of 200kVA or more. ②A power factor improvement capacitor is opened or closed. ③A system using a thyristor is connected to the same power distribution line.</p>	<ul style="list-style-type: none"> Increase the deceleration time $d\overline{EL}$. Enable $F305$ (overvoltage limit operation). Insert a suitable input reactor.
$\overline{OP3}$	000C	Overvoltage during constant-speed operation	<ul style="list-style-type: none"> The input voltage fluctuates abnormally. ①The power supply has a capacity of 200kVA or more. ②A power factor improvement capacitor is opened or closed. ③A system using a thyristor is connected to the same power distribution line. The motor is in a regenerative state because the load causes the motor to run at a frequency higher than the inverter output frequency. 	<ul style="list-style-type: none"> Insert a suitable input reactor.
$\overline{OL1}$	000D	Inverter overload	<ul style="list-style-type: none"> The acceleration time ACC is too short. The DC braking amount is too large. The V/F setting is improper. A restart signal is input to the rotating motor after a momentary stop, etc. The load is too large. 	<ul style="list-style-type: none"> Increase the acceleration time ACC. Reduce the DC braking amount $F251$ and the DC braking time $F252$. Check the V/F parameter setting. Use $F301$ (auto-restart) and $F302$ (ride-through control). Use an inverter with a larger rating.
$\overline{OL2}$	000E	Motor overload	<ul style="list-style-type: none"> The V/F setting is improper. The motor is locked up. Low-speed operation is performed continuously. An excessive load is applied to the motor during operation. 	<ul style="list-style-type: none"> Check the V/F parameter setting. Check the load (operated machine). Adjust \overline{OLN} to the overload that the motor can withstand during operation in a low speed range.
* \overline{EPHO}	0009	Output phase failure	<ul style="list-style-type: none"> A phase failure occurred in the output line of the main circuit. 	<ul style="list-style-type: none"> Check the main circuit output line, motor, etc., for phase failure. Enable $F605$ (Output phase failure detection).

(Continued overleaf)

(Continued)

Error code	Alarm code	Problem	Possible causes	Remedies
* EPH1	0008	Input phase failure	<ul style="list-style-type: none"> A phase failure occurred in the input line of the main circuit. The inverter may trip because of EPH1 if switching between acceleration and deceleration is done in succession at intervals of less than 1 second. 	<ul style="list-style-type: none"> Check the main circuit input line for phase failure. Enable F608 (input phase failure detection). Set the F608 parameter to 0.
OH	0010	Overheat	<ul style="list-style-type: none"> The cooling fan does not rotate. The ambient temperature is too high. The vent is blocked up. A heat generating device is installed close to the inverter. The thermistor in the unit is broken. 	<ul style="list-style-type: none"> Restart the operation by resetting the inverter after it has cooled down enough. The fan requires replacement if it does not rotate during operation. Secure sufficient space around the inverter. Do not place any heat-generating device near the inverter. Make a service call.
*UP1	001E	Undervoltage trip (main circuit)	<ul style="list-style-type: none"> The input voltage (in the main circuit) is too low. 	<ul style="list-style-type: none"> Check the input voltage. Enable F627 (undervoltage trip selection). To cope with a momentary stop due to undervoltage, enable F302 (ride-through control) and F301 (auto-restart).
EF2	0022	Ground fault trip Arm overcurrent	<ul style="list-style-type: none"> A ground fault occurs in the output cable or the motor. A main circuit element is defective. 	<ul style="list-style-type: none"> Check the cable and the motor for ground faults. Make a service call.
E	0011	Emergency stop	<ul style="list-style-type: none"> During automatic operation or remote operation, a stop command is entered from the operation panel or a remote input device. 	<ul style="list-style-type: none"> Reset the inverter.
Err2	0015	Main unit RAM fault	<ul style="list-style-type: none"> The control RAM is defective. 	<ul style="list-style-type: none"> Make a service call.
Err3	0016	Main unit ROM fault	<ul style="list-style-type: none"> The control ROM is defective. 	<ul style="list-style-type: none"> Make a service call.
Err4	0017	CPU fault trip	<ul style="list-style-type: none"> The control CPU is defective. 	<ul style="list-style-type: none"> Make a service call.
Err5	0018	Remote control error	<ul style="list-style-type: none"> An error arises during remote operation. 	<ul style="list-style-type: none"> Check the remote control device, cables, etc.
Err7	001A	Current detector fault	<ul style="list-style-type: none"> The current detector is defective. 	<ul style="list-style-type: none"> Make a service call.
EEP1	0012	EEPROM fault 1	<ul style="list-style-type: none"> A data writing error occurs. 	<ul style="list-style-type: none"> Turn off the inverter, then turn it on again. If it does not recover from the error, make a service call.
EEP2	0013	EEPROM fault 2	<ul style="list-style-type: none"> Power supply is cut off during tYP operation and data writing is aborted. 	<ul style="list-style-type: none"> Turn the power off temporarily and turn it back on, and then try tYP operation again.
EEP3	0014	EEPROM fault 3	<ul style="list-style-type: none"> A data writing error occurs. 	<ul style="list-style-type: none"> Turn off the inverter, then turn it on again. If it does not recover from the error, make a service call.
* E-18	0032	Break in analog signal cable	<ul style="list-style-type: none"> The signal input via VI/S3 is below the analog signal detection level set with F633. 	<ul style="list-style-type: none"> Check the cables for breaks and change the setting of F633 if no breaks are found.

(Continued overleaf)

(Continued)

Error code	Alarm code	Problem	Possible causes	Remedies
E-19	0033	CPU communications error	<ul style="list-style-type: none"> A communications error occurs between control CPUs. 	<ul style="list-style-type: none"> Make a service call.
E-20	0034	Excessive torque boosted	<ul style="list-style-type: none"> The torque boost parameter ωb is set too high. The impedance of the motor is too small. 	<ul style="list-style-type: none"> Decrease the setting of the torque boost parameter ωb If no improvement results, contact Toshiba Technical Support Center.

* With a parameter, you can choose between trip-on and -off.

[Alarm information] Each message in the table is displayed to give a warning but does not cause the inverter to trip.

Error code	Problem	Possible causes	Remedies
OFF	ST terminal OFF	<ul style="list-style-type: none"> The ST-CC circuit is opened. 	<ul style="list-style-type: none"> Close the ST-CC circuit.
UVFF	Undervoltage in main circuit	<ul style="list-style-type: none"> The supply voltage between R, S and T is under voltage. 	<ul style="list-style-type: none"> Measure the main circuit supply voltage. If the voltage is at a normal level, the inverter requires repairing.
rt r Y	Retry in process	<ul style="list-style-type: none"> The inverter is in the process of retry. A momentary stop occurred. 	<ul style="list-style-type: none"> The inverter is normal if it restarts after several tens of seconds. The inverter restarts automatically. Be careful of the machine because it may suddenly restart.
E r r i	Frequency point setting error	<ul style="list-style-type: none"> The frequency setting signals at points 1 and 2 are set too close to each other. 	<ul style="list-style-type: none"> Set the frequency setting signals at points 1 and 2 apart from each other.
CLr	Clear command acceptable	<ul style="list-style-type: none"> This message is displayed when pressing the STOP key while an error code is displayed. 	<ul style="list-style-type: none"> Press the STOP key again to clear the trip.
EOFF	Emergency stop command acceptable	<ul style="list-style-type: none"> The operation panel is used to stop the operation in automatic control or remote control mode. 	<ul style="list-style-type: none"> Press the STOP key for an emergency stop. To cancel the emergency stop, press any other key.
H I L D	Setting error alarm / An error code and data are displayed alternately twice each.	<ul style="list-style-type: none"> An error is found in a setting when data is reading or writing. 	<ul style="list-style-type: none"> Check whether the setting is made correctly.
HE Rd / E n d	Display of first/last data items	<ul style="list-style-type: none"> The first or last data item in the R U H I R U F data group is displayed. 	<ul style="list-style-type: none"> Press the MON key to exit the data group.
db	DC braking	<ul style="list-style-type: none"> DC braking in process 	<ul style="list-style-type: none"> The message goes off in several tens of seconds if no problem occurs. Note)
E i	Flowing out of excess number of digits	<ul style="list-style-type: none"> The numeric value displayed (e.g., frequency) has a larger number of digits than the display panel. (The number next to the E refers to the excess number of digits.) 	<ul style="list-style-type: none"> When a frequency is displayed, decrease the setting of F 7 0 2 (free unit).

(Continued overleaf)

(Continued)

Error code	Problem	Possible causes	Remedies
5 L O P	Momentary power failure slowdown stop prohibition function activated	<ul style="list-style-type: none"> The slowdown stop prohibition function set with F 3 0 2 (momentary power failure ride-through operation) is activated. 	<ul style="list-style-type: none"> To restart operation, reset the inverter or input an operation signal again.
i n i t	Parameters in the process of initialization	<ul style="list-style-type: none"> Parameters are being initialized to default values. 	<ul style="list-style-type: none"> Normal if the message disappears after a while (several seconds to several tens of seconds).
	Setup parameters in the process of being set	<ul style="list-style-type: none"> Setup parameters are in the process of being set. 	<ul style="list-style-type: none"> Normal if the message disappears after a while (several seconds to several tens of seconds). (European model only)
E - 1 ?	Operation panel key fault	<ul style="list-style-type: none"> The RUN or STOP key is held down for more than 5 seconds. The RUN or STOP key is faulty. 	<ul style="list-style-type: none"> Check the operation panel.
E - 5 0	Source logic switching confirmation alarm	<ul style="list-style-type: none"> The input terminal is switched to source logic mode. 	<ul style="list-style-type: none"> Check whether cables are connected correctly, and then specify a proper logic. Check whether cables are connected correctly, and then reset the inverter or turn it off temporarily and turn it back on. Logics will be switched.
E - 5 1	Source logic switching confirmation alarm	<ul style="list-style-type: none"> The input terminal is switched to source logic mode. 	<ul style="list-style-type: none"> Check whether cables are connected correctly, and then specify a proper logic. Check whether cables are connected correctly, and then reset the inverter or turn it off temporarily and turn it back on. Logics will be switched.

(Note) When the ON/OFF function is selected for DC braking (DB), using the input terminal selection parameter, you can judge the inverter to be normal if "d b" disappears when opening the circuit between the terminal and CC.

[Alarms displayed during operation]

L	Overcurrent alarm	Same as O L (overcurrent)
P	Overvoltage alarm	Same as O P (overvoltage)
L	Overload alarm	Same as O L 1 O L 2 (overload)
H	Overheat alarm	Same as O H (overheat)

If two or more problems arise simultaneously, one of the following alarms appears and blinks.

L P, P L, L P L

The blinking alarms L, P, L, H are displayed in this order from left to right.

13.2 Restoring the inverter from a trip

Do not reset the inverter when tripped because of a failure or error before eliminating the cause. Resetting the tripped inverter before eliminating the problem causes it to trip again.

The inverter can be restored from a trip by any of the following operations:

- (1) By turning off the power (Keep the inverter off until the LED turns off.)
Note) Refer to 6.1 4.2 (inverter trip retention selection $F 6 \text{ } \bar{O} \text{ } \bar{C}$) for details.
- (2) By means of an external signal [Short-circuiting of control terminals RST and CC → open (Assignment of functions to input terminals is necessary)]
- (3) By operation panel operation
- (4) By inputting a trip clear signal from a remote input device
(Refer to the Communications Equipment User's Manual for details.)

To reset the inverter by operation panel operation, follow these steps.

1. Press the STOP key and make sure that $\bar{L} \text{ } \bar{r}$ is displayed.
2. Pressing the STOP key again will reset the inverter if the cause of the trip has already been eliminated.

☆When any overload function [$\bar{O} \text{ } \bar{L} \text{ } \bar{I}$: inverter overload, $\bar{O} \text{ } \bar{L} \text{ } \bar{C}$: motor overload,] is active, the inverter cannot be reset by inputting a reset signal from an external device or by operation panel operation before the virtual cooling time has passed.

Virtual cooling time..... $\bar{O} \text{ } \bar{L} \text{ } \bar{I}$: about 30 seconds after the occurrence of a trip
 $\bar{O} \text{ } \bar{L} \text{ } \bar{C}$: about 120 seconds after the occurrence of a trip

[Caution]

Turning the inverter off then turning it on again resets the inverter immediately. You can use this mode of resetting if there is a need to reset the inverter immediately. Note, however, that this operation may damage the system or the motor if it is repeated frequently.

☆If the inverter trips because of overheating ($\bar{O} \text{ } \bar{H}$), do not reset the inverter immediately but wait until the temperature in the inverter comes down, because its internal temperature is monitored.

13.3 If the motor does not run while no trip message is displayed ...

If the motor does not run while no trip message is displayed, follow these steps to track down the cause.

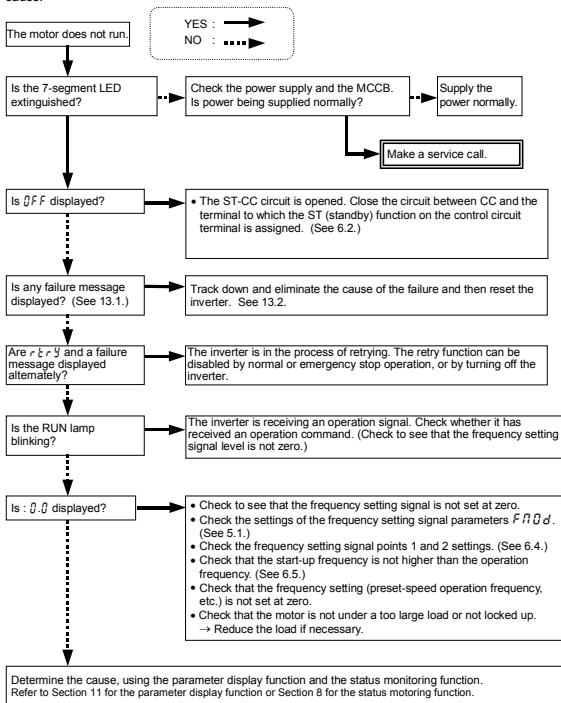

13.4 How to determine the causes of other problems

The following table provides a listing of other problems, their possible causes and remedies.

Problems	Causes and remedies
The motor runs in the wrong direction.	<ul style="list-style-type: none"> • Invert the phases of the output terminals U, V and W. • Invert the forward/reverse run-signal terminals of the external input device. (See 6.2 "Assignment of functions to control terminals".)
The motor runs but its speed does not change normally.	<ul style="list-style-type: none"> • The load is too heavy. Reduce the load. • The soft stall function is activated. Disable the soft stall function. (See 5.10.) • The maximum frequency FH and the upper limit frequency UL are set too low. Increase the maximum frequency FH and the upper limit frequency UL. • The frequency setting signal is too low. Check the signal set value, circuit, cables, etc. • Check the setting characteristics (point 1 and point 2 settings) of the frequency setting signal parameters. (See 6.4.) • If the motor runs at a low speed, check to see that the stall prevention function is activated because the torque boost amount is too large. Adjust the torque boost amount (ub) and the acceleration time (RLC). (See 5.1.)
The motor does not accelerate or decelerate smoothly.	<ul style="list-style-type: none"> • The acceleration time (RLC) or the deceleration time (dEL) is set too short. Increase the acceleration time (RLC) or the deceleration time (dEL).
A too large current flows into the motor.	<ul style="list-style-type: none"> • The load is too heavy. Reduce the load. • If the motor runs at a low speed, check whether the torque boost amount is too large. (See 5.9.)
The motor runs at a higher or lower speed than the specified one.	<ul style="list-style-type: none"> • The motor has an improper voltage rating. Use a motor with a proper voltage rating. • The motor terminal voltage is too low. Check the setting of the base frequency voltage parameter ($F403$). (See 6.12.) Replace the cable with a cable larger in diameter. • The reduction gear ratio, etc., are not set properly. Adjust the reduction gear ratio, etc. • The output frequency is not set correctly. Check the output frequency range. • Adjust the base frequency. (See 5.8.)
The motor speed fluctuates during operation.	<ul style="list-style-type: none"> • The load is too heavy or too light. Reduce the load fluctuation. • The inverter or motor used does not have a rating large enough to drive the load. Use an inverter or motor with a rating large enough. • Check whether the frequency setting signal changes.
Parameter settings cannot be changed.	<p>Change the setting of the parameter $F700$ (prohibition of change of parameter setting) to 0.2.4.6 (permitted) if it is set at 1.3.5.7 (prohibited).</p> <p>* For safety's sake, some parameters cannot be set during operation. (See 4.1.4.)</p>

How to cope with parameter setting-related problems

If you forget parameters which have been reset	<p>You can search for all reset parameters and change their settings.</p> <p>* Refer to 4.1.3 for details.</p>
If you want to return all reset parameters to their respective default settings	<p>You can return all parameters which have been reset to their default settings.</p> <p>* Refer to 4.1.5 for details.</p>

14. Inspection and maintenance

Warning



Mandatory

- The equipment must be inspected every day. If the equipment is not inspected and maintained, errors and malfunctions may not be discovered which could lead to accidents.
 - Before inspection, perform the following steps.
 - ① Shut off all input power to the inverter.
 - ② Wait for at least 15 minutes and check that the charge lamp is no longer lit.
 - ③ Use a tester that can measure DC voltages (800V DC or more), and check that the voltage to the DC main circuits (across PA-PC) does not exceed 45V.
- Performing an inspection without carrying out these steps first could lead to electric shock.

Be sure to inspect the inverter regularly and periodically to prevent it from breaking down because of the environment of use, such as temperature, humidity, dust and vibration, or deterioration of its components with aging.

14.1 Regular inspection

Since electronic parts are susceptible to heat, install the inverter in a cool, well-ventilated and dust-free place. This is essential for increasing the service life.

The purpose of regular inspections is to maintain the correct environment of use and to find any sign of failure or malfunction by comparing current operation data with past operation records.

Subject of inspection	Inspection procedure			Criteria for judgment
	Inspection item	Inspection cycle	Inspection method	
1. Indoor environment	1) Dust, temperature and gas	Occasionally	1) Visual check, check by means of a thermometer, smell check	1) Improve the environment if it is found to be unfavorable. 2) Check for any trace of water condensation. 3) Max. temperature: 40°C (50°C inside the cabinet)
	2) Drops of water or other liquid	Occasionally	2) Visual check	
	3) Room temperature	Occasionally	3) Check by means of a thermometer	
2. Units and components	1) Vibration and noise	Occasionally	Tactile check of the cabinet	If something unusual is found, open the door and check the transformer, reactors, contactors, relays, cooling fan, etc., inside. If necessary, stop the operation.
3. Operation data (output side)	1) Load current	Occasionally	Moving-iron type AC ammeter	To be within the rated current, voltage and temperature. No significant difference from data collected in a normal state.
	2) Voltage (*)	Occasionally	Rectifier type AC voltmeter	
	3) Temperature	Occasionally	Thermometer	



*) The voltage measured may slightly vary from voltmeter to voltmeter. When measuring the voltage, always take readings from the same circuit tester or voltmeter.

■ Check points

1. Something unusual in the installation environment
2. Something unusual in the cooling system
3. Unusual vibration or noise
4. Overheating or discoloration
5. Unusual odor
6. Unusual motor vibration, noise or overheating

14.2 Periodical inspection

Make a periodical inspection at intervals of 3 or 6 months depending on the operating conditions.

 Warning	
 Mandatory	<ul style="list-style-type: none"> • Before inspection, perform the following steps. <ol style="list-style-type: none"> ① Shut off all input power to the inverter. ② Wait for at least 15 minutes and check that the charge lamp is no longer lit. ③ Use a tester that can measure DC voltages (800V DC or more), and check that the voltage to the DC main circuits (across PA-PC) does not exceed 45V. • Performing an inspection without carrying out these steps first could lead to electric shock.
 Prohibited	<ul style="list-style-type: none"> • Never replace any part. • This could be a cause of electric shock, fire or bodily injury. To replace parts, call the local sales agency.

■ Check items

1. Check to see if all screwed terminals are tightened firmly. If any screw is found loose, tighten it again with a screwdriver.
2. Check to see if all crimped terminals are fixed properly. Check them visually to see that there is no trace of overheating around any of them.
3. Check visually all cables and wires for damage.
4. With a vacuum cleaner, remove dirt and dust, especially from the vents and the printed circuit boards. Always keep them clean to prevent an accident due to dirt or dust.
5. When leaving the inverter unused for a long time, check it for functioning once every 2 years or so by supplying it with electricity for at least 5 hours with the motor disconnected. It is advisable not to supply the commercial power directly to the inverter but to gradually increase the power supply voltage with a transformer.
6. If the need arises, conduct an insulation test on the main circuit terminal board only, using a 500V insulation tester. Never conduct an insulation test on control terminals other than terminals on the printed circuit board or on control terminals. When testing the motor for insulation performance, separate it from the inverter in advance by disconnecting the cables from the inverter output terminals U, V and W. When conducting an insulation test on peripheral circuits other than the motor circuit, disconnect all cables from the inverter so that no voltage is applied to the inverter during the test.

(Note) Before an insulation test, always disconnect all cables from the main circuit terminal board and test the inverter separately from other equipment.

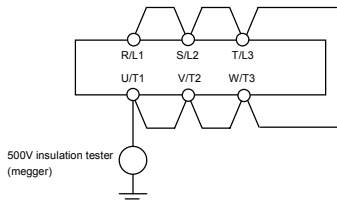

7. Never test the inverter for pressure. A pressure test may cause damage to its components.
8. Voltage and temperature check

Recommended voltmeter:

Input side — Moving-iron type voltmeter (⚡)

Output side — Rectifier type voltmeter (→)

It will be very helpful for detecting a defect if you always measure and record the ambient temperature before, during and after the operation.

■ Replacement of expendable parts

The inverter is composed of a large number of electronic parts including semiconductor devices. The following parts deteriorate with the passage of time because of their composition or physical properties. The use of aged or deteriorated parts leads to degradation in the performance or a breakdown of the inverter. To avoid such trouble, the inverter should be checked periodically. No parts of the inverter except the cooling fan can be replaced individually, and the whole inverter needs to be replaced if a significant defect is found in it.

Note) Generally, the life of a part depends on the ambient temperature and the conditions of use. The life spans listed below are applicable to parts when used under normal environmental conditions.

1) Cooling fan

The fan, which cools down heat-generating parts, has a service life of about 30,000 hours (about 2 or 3 years of continuous operation). The fan also needs to be replaced if it makes a noise or vibrates abnormally.

2) Smoothing capacitor

The smoothing aluminum electrolytic capacitor in the main circuit DC section degrades in performance because of ripple currents, etc. It becomes necessary to replace the capacitor after it is used for about 5 years under normal conditions.

<Criteria for appearance check>

- Absence of liquid leak
- Safety valve in the depressed position
- Measurement of electrostatic capacitance and insulation resistance

Note: For the replacement of consumable parts, ask your nearest Toshiba branch or office.

The operation time is helpful for roughly determining the time of replacement. For the replacement of parts, contact the service network or Toshiba branch office printed on the back cover of this instruction manual.

■ Standard replacement cycles of principal parts

The table below provides a listing of the replacement cycles of parts when used under normal conditions (average ambient temperature: 30°C, load factor: not more than 80%, operation time: 12 hours per day). The replacement cycle of each part does not mean its service life but the number of years over which its failure rate does not increase significantly.

Part name	Standard replacement cycle	Replacement mode and others
Cooling fan	2 to 3 years	Replacement with a new one
Smoothing capacitor	5 years	Replace with a new one (depending on the check results)
Contactors and relays	-	Whether to replace or not depends on the check results
Timer	-	Whether to replace or not depends on the operation time
Fuse	10 years	Replacement with a new one
Aluminum capacitor on printed circuit board	5 years	Replace with a new circuit board (depending on the check results)

(Extract from "Guide to periodical inspections of general-purpose inverters" issued by the Japan Electrical Manufacturers' Association.)

Note) The life of a part greatly varies depending on the environment of use.

14.3 Making a call for servicing

For the Toshiba service network, refer to the back cover of this instruction manual. If defective conditions are encountered, please contact the Toshiba service section in charge via your Toshiba dealer.

When making a call for servicing, please inform us of the contents of the rating label on the right panel of the inverter, the presence or absence of optional devices, etc., in addition to the details of the failure.

14.4 Keeping the inverter in storage

Take the following precautions when keeping the inverter in storage temporarily or for a long period of time.

1. Store the inverter in a well-ventilated place away from heat, damp, dust and metal powder.
2. If the printed circuit board in your inverter has an anti-static cover (black cover), do not leave it detached from the circuit board during storage, though the cover must be detached before turning on the inverter.
3. If no power is supplied to the inverter for a long time, the performance of its large-capacity electrolytic capacitor declines.

When leaving the inverter unused for a long time, supply it with electricity once every two years, for 5 hours or more each, to recover the performance of the large-capacity electrolytic capacitor and also to check the function of the inverter. It is advisable not to supply the commercial power directly to the inverter but to gradually increase the power supply voltage with a transformer, etc.

15. Warranty

Any part of the inverter that proves defective will be repaired and adjusted free of charge under the following conditions:

1. This warranty applies only to the inverter main unit.
2. Any part of the inverter which fails or is damaged under normal use within twelve months from the date of delivery shall be repaired free of charge.
3. For the following kinds of failure or damage, the repair cost shall be borne by the customer even within the warranty period.
 - Failure or damage caused by improper or incorrect use or handling, or unauthorized repair or modification of the inverter
 - Failure or damage caused by the inverter falling or an accident during transportation after the purchase
 - Failure or damage caused by fire, salty water or wind, corrosive gas, earthquake, storm or flood, lightning, abnormal voltage supply, or other natural disasters
 - Failure or damage caused by the use of the inverter for any purpose or application other than the intended one
4. All expenses incurred by Toshiba for on-site services shall be charged to the customer, unless a service contract is signed beforehand between the customer and Toshiba, in which case the service contract has priority over this warranty.

16. Disposal of the inverter



Caution



Mandatory

- If you throw away the inverter, have it done by a specialist in industry waste disposal*. If you throw away the inverter by yourself, this can result in explosion of capacitor or produce noxious gases, resulting in injury.
(*) Persons who specialize in the processing of waste and known as "industrial waste product collectors and transporters" or "industrial waste disposal persons."
If the collection, transport and disposal of industrial waste is done by someone who is not licensed for that job, it is a punishable violation of the law. (Law on Waste Disposal and Cleaning)

For safety's sake, do not dispose of the disused inverter yourself but ask an industrial waste disposal agent.

Disposing of the inverter improperly could cause its capacitor to explode and emit toxic gas, causing injury to persons.

TOSHIBA

TOSHIBA INDUSTRIAL PRODUCTS SALES CORPORATION

International Operations
9-11, Nihonbashi-honcho 4-chome,
Chuo-ku, Tokyo 103-0023, Japan
TEL: +81-(0)3-5644-5509
FAX: +81-(0)3-5644-5519

TOSHIBA INTERNATIONAL CORPORATION

13131 West Little York RD., Houston,
TX 77041, U.S.A
TEL: +1-713-466-0277
FAX: +1-713-466-8773

TOSHIBA ASIA PACIFIC PTE., LTD

152 Beach Rd., #16-00 Gateway East,
Singapore 189721
TEL: +65-6297-0990
FAX: +65-6297-5510

TOSHIBA CHINA CO., LTD

HSBC Tower, 1000 Lujiazui Ring Road,
Pudong New Area, Shanghai
200120, The People's Republic of China
TEL: +86-(0)21-6841-5666
FAX: +86-(0)21-6841-1161

TOSHIBA INTERNATIONAL CORPORATION PTY., LTD

2 Morton Street Parramatta, NSW2150, Australia
TEL: +61-(0)2-9768-6600
FAX: +61-(0)2-9890-7542

TOSHIBA INFORMATION, INDUSTRIAL AND POWER SYSTEMS TAIWAN CORP.

6F, No66, Sec1 Shin Sheng N.RD, Taipei,
Taiwan
TEL: +886-(0)2-2581-3639
FAX: +886-(0)2-2581-3631

- For further information, please contact your nearest Toshiba Representative or International Operations - Producer Goods.
- The data given in this manual are subject to change without notice.