

Vector inverter for Hybrid injection molding machines

ADP200

Quick start up guide Specification and installation

Language: English

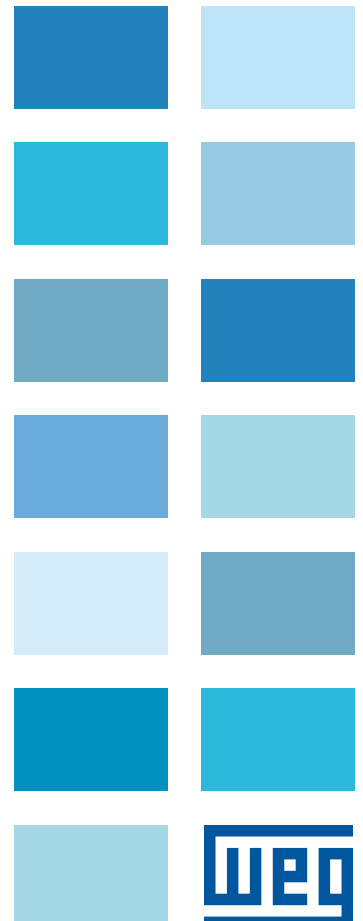

Information about this manual

The ADP200 Quick start guide is a handy-sized manual for mechanical installation, electrical connection and fast start-up.

The manual explaining the functions and a description of the parameters can be found on WEG website. Downloads section ([https://www.weg.net/...](https://www.weg.net/)).

Software version

This manual is updated according the software version V 4.X.3

The identification number of the software version is indicated on the identification plate of the drive or can be checked with the **Firmware ver.rel** - PAR 490 parameter, menu 2.6.

General information

Note !

.....
In industry, the terms "Inverter", "Regulator" and "Drive" are sometimes interchanged. In this document, the terms "Drive" and "Inverter" will be used.
.....

Before using the product, read the safety instruction section carefully. Keep the manual in a safe place and available to engineering and installation personnel during the product functioning period.

WEG Automation Europe S.r.l. has the right to modify products, data and dimensions without notice. The data can only be used for the product description and they can not be understood as legally stated properties.

Thank you for choosing this WEG product.

We will be glad to receive any possible information which could help us improving this manual. The e-mail address is the following: techdoc@weg.net.

All rights reserved.

Table of Contents

Information about this manual	2
1 - Safety Precautions	5
1.1 Symbols used in the manual	5
1.2 Safety precaution.....	5
1.3 General warnings	6
1.4 Disclaimer	6
2 - Introduction to the product.....	7
2.1 Dedicated features	8
2.2 Application features	8
2.3 Identification of components.....	9
2.4 Product identification	10
3 - Transport, storage and disposal	11
3.1 General.....	11
3.2 Permissible Environmental Conditions.....	11
3.3 Disposal.....	12
4 - Specification	13
4.1 Environmental Conditions.....	13
4.2 Standards	13
4.3 Precision.....	13
4.3.1 Speed control	13
4.3.2 Speed control limits.....	13
4.3.3 Torque control.....	13
4.3.4 Current rating	13
4.4 Input electrical data	14
4.5 Output electrical data	14
4.5.1 Derating values in overload condition	15
4.5.2 Derating values for switching frequency.....	15
4.5.3 Kalt: Ambient temperature reduction factor.....	16
4.6 Voltage level of the inverter for safe operations	16
4.8 Cooling	16
4.9 Weights and dimensions.....	17
5- Options	20
5.1 Optional external fuses	20
5.1.1 Network side fuses (F1)	20
5.2 Input chokes	21
5.2.1 AC input chokes	21
5.2.2 DC input chokes	22
5.3 AC output chokes	22
5.4 External braking resistors (optional).....	23
5.5 EMC Filter.....	24
6 - Mechanical installation	25
6.1 Maximum inclination and assembly clearances	25
6.2 Fastening positions	26
7 - Wiring Procedure.....	27
7.1 Power section.....	29
7.1.1 Cable cross-sections	29
7.1.2 Connection of shielding (recommended).....	30
7.1.3 EMC guide line.....	31
7.1.4 Block diagram of power section	32
7.1.5 Internal EMC filter (standard).....	32
7.1.6 Power line connection	33
7.1.7 Connection of AC and DC chokes.....	34
7.1.7.1 Connection of AC choke	34
7.1.7.2 Connection of DC choke.....	34
7.1.8 Motor connection.....	35
7.1.9 Connection of braking resistor (optional).....	35
7.2 Regulation section	36
7.2.1 Cable cross-sections	36
7.2.2 Connection of I/O card	37
7.2.2.1 Terminal strip and connection ADP200-...24 models.....	37
7.2.3 Feedback Connection	38
7.3 Connection diagrams.....	39
7.3.1 Regulation potentials, digital I/O.....	39

7.3.2 Typical connection diagram.....	41
7.4 Serial interface (PC connector)	42
7.4.1 Drive/RS485 port point-to-point connection	42
7.4.2 Drive / RS485 port point-to-point connection (isolated).....	43
7.4.3 RS 485 multi-drop connection	43
7.5 CAN interface	44
7.6 Optional Keypad interface (keypad connector)	45
7.7 Saving data on the Memory Card.....	45
7.8 Braking	46
7.8.1 Braking unit (internal).....	46
8 - Use of the keypad	47
8.1 Description of keypads	47
8.1.1 KB-ADP200 integrated keypad	47
8.1.1.1 Membrane keypad	47
8.1.1.2 Meaning of LEDs	47
8.1.2 KB-ADV100 optional programming keypad.....	48
8.1.2.1 Membrane keypad	48
8.1.2.2 Meaning of LEDs.....	48
8.2 Navigating with the integrated keypad.....	49
8.2.1 Scanning of first and second level menus	49
8.2.2 Display.....	49
8.2.3 Changing values.....	51
8.2.4 Error messages when modifying a parameter.....	52
8.2.5 Displaying and closing Messages	52
8.2.6 Displaying and resetting Alarms	53
8.2.6.1 Alarm Log	53
8.2.7 Startup wizard	53
8.2.8 Motor self-tuning.....	54
8.2.9 Saving and overwriting parameters on Memory card.....	54
8.2.10 Loading parameters and firmware from Memory card	55
8.2.11 Correspondence table displayed character/alphabet	55
8.3 Navigating with the optional keypad	56
8.3.1 Scanning of the first and second level menus	56
8.3.2 Display of a parameter	56
8.3.3 Scanning of the parameters	57
8.3.4 List of the last parameters modified	57
8.3.5 Parameter modification	57
8.3.6 How to save parameters	58
8.3.7 Configuration of the display.....	59
8.3.7.1 Language selection	59
8.3.7.2 Selection of Easy/Expert mode	59
8.3.8 Startup display.....	59
8.3.9 Back-lighting of the display.....	59
8.3.10 Alarms	59
8.3.10.1 Alarm reset	59
8.3.11 Messages	60
8.3.12 Saving and recovery of new parameter settings	60
8.3.12.1 Selection of the keypad memory	60
8.3.12.2 Saving of parameters on the keypad	60
8.3.12.3 Load parameters from keypad	61
8.3.12.4 Transfer of parameters between drives	61
8.3.13 Saving and recovery of new parameter settings on memory card	61
8.3.14 Loading firmware from Memory card.....	62
9 - Commissioning via keypad	63
9.1 Startup wizard for brushless motors (with the integrated keypad).....	65
9.2 Startup wizard for brushless motors (with the optional keypad)	71
10 - Troubleshooting.....	78
10.1 Alarms.....	78
10.2 Speed fbk loss alarm according to the type of feedback	82
10.2.1 Reset Speed fbk loss alarm	84
10.2.2 Encoder error alarm	84
10.3 Messages	85
Appendix.....	89
A.1 - Inserting expansion cards	89
A.2 - I/O Card	90
A.2.1 Input/Output features	91
A.3 Encoders and encoder expansion cards.....	94
A.3.1 Encoders.....	94
A.3.2 Phasing.....	95
A.3.3 Encoder cards.....	96

1 - Safety Precautions

1.1 Symbols used in the manual



Warning!

Indicates a procedure, condition, or statement that, if not strictly observed, could result in personal injury or death.

Indique le mode d'utilisation, la procédure et la condition d'exploitation. Si ces consignes ne sont pas strictement respectées, il y a des risques de blessures corporelles ou de mort.



Caution

Indicates a procedure, condition, or statement that, if not strictly observed, could result in damage to or destruction of equipment.

Indique le mode d'utilisation, la procédure et la condition d'exploitation. Si ces consignes ne sont pas strictement respectées, il y a des risques de détérioration ou de destruction des appareils.



Indicates that the presence of electrostatic discharge could damage the appliance. When handling the boards, always wear a grounded bracelet.

Indique que la présence de décharges électrostatiques est susceptible d'endommager l'appareil. Toujours porter un bracelet de mise à la terre lors de la manipulation des cartes.



Attention

Indicates a procedure, condition, or statement that should be strictly followed in order to optimize these applications.

Indique le mode d'utilisation, la procédure et la condition d'exploitation. Ces consignes doivent être rigoureusement respectées pour optimiser ces applications.

Note !

Indicates an essential or important procedure, condition, or statement.

Indique un mode d'utilisation, de procédure et de condition d'exploitation essentiels ou importants.

Qualified personnel

For the purpose of this Instruction Manual, a "Qualified person" is someone who is skilled to the installation, mounting, start-up and operation of the equipment and the hazards involved. This operator must have the following qualifications:

- trained in rendering first aid.
- trained in the proper care and use of protective equipment in accordance with established safety procedures.
- trained and authorized to energize, de-energize, clear, ground and tag circuits and equipment in accordance with established safety procedures.

Personne qualifiée

Aux fins de ce manuel d'instructions, le terme « personne qualifiée » désigne toute personne compétente en matière d'installation, de montage, de mise en service et de fonctionnement de l'appareil et au fait des dangers qui s'y rattachent. L'opérateur en question doit posséder les qualifications suivantes :

- formation lui permettant de dispenser les premiers soins
- formation liée à l'entretien et à l'utilisation des équipements de protection selon les consignes de sécurité en vigueur
- formation et habilitation aux manoeuvres suivantes : branchement, débranchement, vérification des isolations, mise à la terre et étiquetage des circuits et des appareils selon les consignes de sécurité en vigueur.

Use for intended purpose only

The power drive system (electrical drive + application plant) may be used only for the application stated in the manual and only together with devices and components recommended and authorized by WEG.

Utiliser uniquement dans les conditions prévues

Le système d'actionnement électrique (drive électrique + installation) ne peut être utilisé que dans les conditions d'exploitation et les lieux prévus dans le manuel et uniquement avec les dispositifs et les composants recommandés et autorisés par WEG.

1.2 Safety precaution

The following instructions are provided for your safety and as a means of preventing damage to the product or components in the machines connected. This section lists instructions, which apply generally when handling electrical drives. Specific instructions that apply to particular actions are listed at the beginning of each chapters.

Les instructions suivantes sont fournies pour la sécurité de l'utilisateur tout comme pour éviter l'endommagement du produit ou des composants à l'intérieur des machines raccordées. Ce paragraphe dresse la liste des instructions

généralement applicables lors de la manipulation des drives électriques.
Les instructions spécifiques ayant trait à des actions particulières sont répertoriées au début de chaque chapitre.

Read the information carefully, since it is provided for your personal safety and will also help prolong the service life of your electrical drive and the plant you connect to.

Lire attentivement les informations en matière de sécurité personnelle et visant par ailleurs à prolonger la durée de vie utile du drive tout comme de l'installation à laquelle il est relié.

1.3 General warnings



Warning!

.....
This equipment contains dangerous voltages and controls potentially dangerous rotating mechanical parts. Non-compliance with Warnings or failure to follow the instructions contained in this manual can result in loss of life, severe personal injury or serious damage to property.

Cet appareil utilise des tensions dangereuses et contrôle des organes mécaniques en mouvement potentiellement dangereux. L'absence de mise en pratique des consignes ou le non-respect des instructions contenues dans ce manuel peuvent provoquer le décès, des lésions corporelles graves ou de sérieux dégâts aux équipements.

Only suitable qualified personnel should work on this equipment, and only after becoming familiar with all safety notices, installation, operation and maintenance procedures contained in this manual. The successful and safe operation of this equipment is dependent upon its proper handling, installation, operation and maintenance.

Seul un personnel dûment formé peut intervenir sur cet appareil et uniquement après avoir assimilé l'ensemble des informations concernant la sécurité, les procédures d'installation, le fonctionnement et l'entretien contenues dans ce manuel. La sécurité et l'efficacité du fonctionnement de cet appareil dépendent du bon accomplissement des opérations de manutention, d'installation, de fonctionnement et d'entretien.

In the case of faults, the drive, even if disabled, may cause accidental movements if it has not been disconnected from the mains supply.

En cas de panne et même désactivé, le drive peut provoquer des mouvements fortuits s'il n'a pas été débranché de l'alimentation secteur.

Electrical Shock

The DC link capacitors remain charged at a hazardous voltage even after cutting off the power supply.

Never open the device or covers while the AC Input power supply is switched on. Minimum time to wait before working on the terminals or inside the device is listed in [section 4.6](#).

Risque de décharge électrique

Les condensateurs de la liaison à courant continu restent chargés à une tension dangereuse même après que la tension d'alimentation a été coupée.

Ne jamais ouvrir l'appareil lorsqu'il est sous tension. Le temps minimum d'attente avant de pouvoir travailler sur les bornes ou bien à l'intérieur de l'appareil est indiqué dans la [section 4.6](#).

Electrical Shock and Burn Hazard

When using instruments such as oscilloscopes to work on live equipment, the oscilloscope's chassis should be grounded and a differential probe input should be used. Care should be used in the selection of probes and leads and in the adjustment of the oscilloscope so that accurate readings may be made. See instrument manufacturer's instruction book for proper operation and adjustments to the instrument.

Décharge Électrique et Risque de Brûlure

Lors de l'utilisation d'instruments (par exemple oscilloscope) sur des systèmes en marche, le châssis de l'oscilloscope doit être relié à la terre et une sonde différentiel devrait être utilisé en entrée. Les sondes et conducteurs doivent être choisis avec soin pour effectuer les meilleures mesures à l'aide d'un oscilloscope. Voir le manuel d'instruction pour une utilisation correcte des instruments.

Fire and Explosion Hazard

Fires or explosions might result from mounting Drives in hazardous areas such as locations where flammable or combustible vapors or dusts are present. Drives should be installed away from hazardous areas, even if used with motors suitable for use in these locations.

Risque d'incendies et d'explosions

L'utilisation des drives dans des zones à risques (présence de vapeurs ou de poussières inflammables), peut provoquer des incendies ou des explosions. Les drives doivent être installés loin des zones dangereuses, et équipés de moteurs appropriés.

.....

1.4 Disclaimer

Any remote connection functions shall be used only under adequate security conditions, in compliance with current regulatory provisions and only by properly trained personnel. The evaluation of such conditions is up to the user.

2 - Introduction to the product

The new ADP200 inverter series represents an innovative concept in drive technology, the result of constant technological research and the know-how in plastics applications that the WEG Group has acquired by working side by side with major sector players.

This new series has been engineered and developed to satisfy the real needs of plastics machine manufacturers and to provide them the best and most economically competitive innovations on international markets.

Based on full mechanical modularity, a powerful and "fully open" programming platform, and a specific PID algorithm for injection molding machine servo-pump control, the ADP200 offers completely flexible integration and high performance for plastics applications.

The ADP200 features the following as standard:

1) Motor type: Synchronous

2) Control mode: Vector control with feedback (Encoder expansion card mandatory)

3A) I/O configuration and Resolver encoder (HW Release (*) of IO card = D):

EXP-IO-D8A4R2-ADP card

- 6 digital inputs (DI) + enable (EN-HW);
- 2 digital outputs (DO);
- 3 differential analog inputs (AI):
 - 1 for pressure sensor:
Voltage: 0...10 V or 0.1...10.1 V (3 wires)
Current: 0...20 mA or 4...20mA (2 wires)
 - 2 for flow/pressure references or general purpose:
Voltage: ± 10 V
Current: 0...20 mA or 4...20 mA
- 1 analog output (AO):
Voltage: 0...10 V or 0.1...10.1 V
Current: 0...20 mA or 4...20mA
- 2 relay outputs (RO);
- 1 motor protection input (MOT): compatible with PTC, KTY, Klixon;
- Screw terminals.

Encoder card, EXP-RES-I1-ADP (code S5L81P, HW Release (*) of Encoder card = C)

- Resolver encoder
- Excitation Frequency: from 2.0 to 10 kHz
- Transformation ratio: from 0.1 to 1.0
- Excitation Voltage: from 1.1 Vrms to 5.6 Vrms
- Screw terminals (no.8)

3B) I/O configuration and Resolver encoder (HW Release of IO card = G)*:

I/O Optional card (EXP-IO-D8A4R2-SM-ADP):

- 6 digital inputs (DI) + enable (EN-HW);
- 2 digital outputs (DO);
- 3 differential analog inputs (AI):
 - 1 for pressure sensor:
Voltage: 0...10 V or 0.1...10.1 V (3 wires)
Current: 0...20 mA or 4...20mA (2 wires)
 - 2 for flow/pressure references or general purpose:
Voltage: ± 10 V
Current: 0...20 mA or 4...20 mA
- 1 analog output (AO):
Voltage: 0...10 V or 0.1...10.1 V or ± 10 V
Current: 0...20 mA or 4...20mA
- 2 relay outputs (RO);
- 1 motor protection input (MOT): compatible with PTC, KTY, Klixon;
- Spring-cage terminals.

Encoder card, EXP-RES-I1-S-ADP (code S5L81P, HW (*) Release of Encoder card = C)

- Resolver encoder
- Excitation Frequency: from 2.0 to 10 kHz
- Transformation ratio: from 0.1 to 1.0
- Excitation Voltage: from 1.1 Vrms to 5.6 Vrms
- Spring-cage terminals (no. 6)
- Metal guide for terminal insertion

* See section "2.4 Product identification" on page 10.

> **Encoder optional cards:**

- EXP-RES-I1R1-ADP, Resolver encoder + Repeat
- EXP-DE-I1R1F2-ADL, Digital encoder 3 Channels card + Repeat + 2 Freeze
- EXP-EN/SSI-I1R1F2-ADL, Sinusoidal encoder card - Absolute EnDat + Repeat + 2 Freeze
- EXP-HIP-I1R1F2-ADL, Hiperface encoder 3 Channels card + Repeat + 2 Freeze
- EXP-SE-I1R1F2-ADL, Sinusoidal encoder 3 Channels card + Repeat + 2 Freeze
- EXP-SESC-I1R1F2-ADL, Sinusoidal SinCos encoder 3 Channels card + Repeat + 2 Freeze.

2.1 Dedicated features

- Self-tuning rotational and stand still of speed-current-flux regulators and motor data identification
- Torque control
- Simplified Start-up menu
- Motor, Drive and Braking resistor I2t thermal protection
- Multispeed function (16 programmable preset)
- 4 independent programmable Multi-ramp with jerks
- Jog function
- Motorpotentiometer function
- Droop function
- Double motor parameters setting
- Variable switching frequency
- Motor temperature monitoring
- Advanced programming via MDPLC tool (IEC 61131-3 standard environment)

2.2 Application features

- PID function block for injection molding machine application 1
- Flow and pressure limit control
- Pressure sensor status control
- Adaptive Feedforward
- Automatic switchover between closed-loop speed and pressure control
- Speed and pressure control loops tuning
- Pump Rotation direction identification
- Multipump convergent and divergent control.

2.3 Identification of components

The inverter converts the constant frequency and voltage of an existing three-phase network into DC voltage, from which it obtains a new three-phase network with variable voltage and frequency. With this variable three-phase network the speed of three-phase synchronous motors can be controlled continuously.

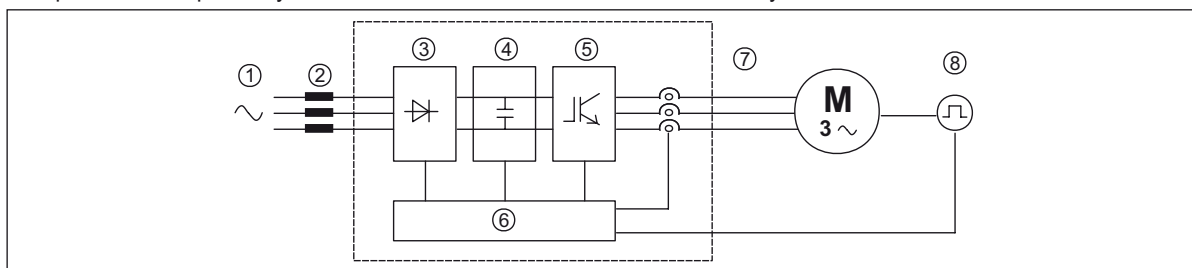

- 1. Mains supply voltage**
- 2. Mains choke** (see chapter 5.2)
- 3. Three-phase rectifier bridge**
Converts AC voltage into DC voltage via a three-phase full wave bridge.
- 4. Intermediate circuit**
With pre-load resistor and levelling capacitors DC voltage (U_{DC}) = $\sqrt{2}$ x mains voltage (U_{LN}).
- 5. IGBT inverter bridge**
Converts DC voltage into three-phase AC voltage with variable amplitude and frequency.
- 6. Configurable control section**
Cards for controlling and regulating the closed and open-loop power section. Commands, references and reactions are connected to these.
- 7. Output voltage**
Three-phase AC voltage.
- 8. Speed feedback encoder** (see section A.3 of the Appendix).

2.4 Product identification

The basic technical data of the inverter are included in the product code and data plate.

The inverter must be selected according to the rated current of the motor.



The rated output current of the drive must be higher than or equal to the rated current of the motor used.

Name of model (code)

ADP200 2 075 -KB P -F-4-C-RS -24

24 VDC external power supply:	24 = included
Encoder Repetition: [Empty] = not included (standard)	ER = with encoder repetition
Encoder card: RS = Resolver (standard); ED = EnDat; SI = Sinusoidal Encoder;	DE = Digital Encoder; HI = Hiperface; SC = Sinusoidal SinCos Encoder;
CANBus:	C = included
Rated voltage:	4 = 400Vca, three-phase
EMI Filter: F = included	[Empty] = not included
PID IMM application:	P = included
Braking unit: X = not included	B = included
Keypad: K = included	(1-line x 4-character alpha-numerical LED display)
Inverter power in kW: 075 = 7.5kW 110 = 11kW 150 = 15kW 185 = 18.5kW 220 = 22kW	300 = 30kW 370 = 37kW 450 = 45kW 550 = 55kW 750 = 75kW
Mechanical dimensions of the drive: 2 = size 2 3 = size 3	4 = size 4 5 = size 5 5S = size 5 slim

Servodrive, ADP200 series

Data plate		Firmware and card revision plate									
Serial number	 WEG AUTOMATION EUROPE S.R.L. Via G.Carducci,24 I-21040-Gerenzano (Va)	<table border="1"> <thead> <tr> <th>Firmware Release</th> <th>HW release</th> <th>S/N</th> <th>Prod. CONF.</th> </tr> </thead> <tbody> <tr> <td>3.0.0</td> <td>C C -N -G</td> <td>09012345</td> <td>SM · CFG A1</td> </tr> </tbody> </table>		Firmware Release	HW release	S/N	Prod. CONF.	3.0.0	C C -N -G	09012345	SM · CFG A1
Firmware Release	HW release	S/N	Prod. CONF.								
3.0.0	C C -N -G	09012345	SM · CFG A1								
Drive model	Type: ADP200-4450-KBP-F-4-C-RS S/N: 09012345	Firmware revision	Cards revision								
Input (mains supply, frequency, AC Input Current at constant torque)	Inp: 230-400-480Vac (Fctry set=400) 50/60Hz 3Ph 96A@230Vac 99A@400Vac 93A@480Vac	Power Regulation	Braking unit								
Output (Output voltage, frequency, power, current, overload)	Out: 0-480Vac 300Hz 3Ph 45kW@400Vac 60Hp@460Vac 90A@400V Ov1d. 178%-60s 61A@460V Ov1d. 170%-60s	Safety	Software revision								
Approvals	Code:  Made in Italy UL LISTED IND CONTEQ.31KF Factory ID: G 	Product configuration									

Position of plates on the drive

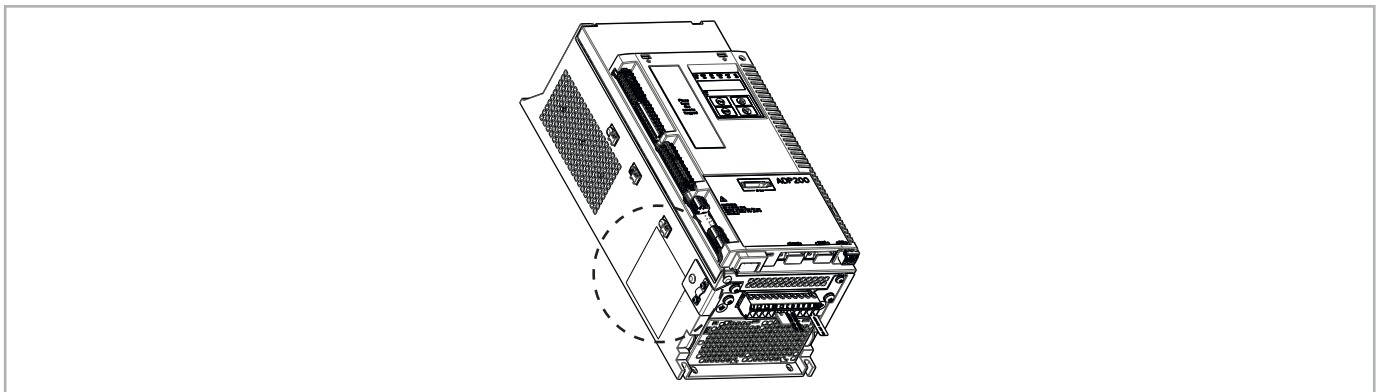

3 - Transport, storage and disposal



Correct transport, storage, erection and mounting, as well as careful operation and maintenance are essential for proper and safe operation of the equipment.

Protect the inverter against physical shocks and vibration during transport and storage. Also be sure to protect it against water (rainfall) and excessive temperatures.

Le bon accomplissement des opérations de transport, de stockage, d'installation et de montage, ainsi que l'exploitation et l'entretien minutieux, sont essentiels pour garantir à l'appareil un fonctionnement adéquat et sûr.

Protéger l'inverseur contre les chocs physiques et les vibrations pendant le transport et le stockage. S'assurer aussi de le protéger contre l'eau (pluie) et les températures excessives.

If the Drives have been stored for longer than two years, the operation of the DC link capacitors may be impaired and must be "reformed". Before commissioning devices that have been stored for long periods, connect them to a power supply for two hours with no load connected in order to regenerate the capacitors, (the input voltage has to be applied without enabling the drive).

En cas de stockage des variateurs pendant plus de deux ans, il est conseillé de contrôler l'état des condensateurs CC avant d'en effectuer le branchement. Avant la mise en service des appareils, ayant été stockés pendant long temps, il faut alimenter variateurs à vide pendant deux heures, pour régénérer les condensateurs : appliquer une tension d'alimentation sans actionner le variateur.

3.1 General

A high degree of care is taken in packing the ADP200 Drives and preparing them for delivery. They should only be transported with suitable transport equipment (see weight data). Observe the instructions printed on the packaging. This also applies when the device is unpacked and installed in the control cabinet.

Upon delivery, check the following:

- the packaging for any external damage
- whether the delivery note matches your order.

Open the packaging with suitable tools. Check whether:

- any parts were damaged during transport
- the device type corresponds to your order

In the event of any damage or of an incomplete or incorrect delivery please notify the responsible sales offices immediately. The devices should only be stored in dry rooms within the specified temperature ranges.

Note!

A certain degree of moisture condensation is permissible if this arises from changes in temperature. This does not, however, apply when the devices are in operation. Always ensure that there is no moisture condensation in devices that are connected to the power supply!

3.2 Permissible Environmental Conditions

Temperature:

storage	-25...+55°C (-13...+131°F), class 1K4 per EN50178
	-20...+55°C (-4...+131°F), for devices with keypad
transport	-25...+70°C (-13...+158°F), class 2K3 per EN50178
	-20...+60°C (-4...+140°F), for devices with keypad

Air humidity:

storage	from 5% to 95 % and from 1 g/m ³ to 29 g/m ³ (Class 1K3 as per EN50178)
transport	95 % (1), 60 g/m ³ (2)

A light condensation of moisture may occur for a short time occasionally if the device is not in operation (class 2K3 as per EN50178)

Air pressure:

storage	[kPa] 86 a 106 (class 1K4 as per EN50178)
transport	[kPa] 70 a 106 (class 2K3 as per EN50178)

- (1) Greatest relative air humidity occurs with the temperature @ 40°C (104°F) or if the temperature of the device is brought suddenly from -25 ...+30°C (-13°...+86°F).
- (2) Greatest absolute air humidity if the device is brought suddenly from 70...15°C (158°...59°F).

3.3 Disposal

Nota !

.....
Please dispose of this unit with care as an industrial waste and according to your required local regulations.
.....



Pursuant to Article 26 of Italian Legislative Decree no. 49 of 14 March 2014 "Implementation of Directive 2012/19/EU on waste electrical and electronic equipment (WEEE)"

The symbol showing a crossed-out wheeled bin on equipment or its packaging indicates that the product must be collected separately from other waste at the end of its useful life.

The manufacturer is responsible for organising and managing the separate collection of this piece of equipment at the end of its useful life.

Users wishing to dispose of the equipment must therefore contact the manufacturer to obtain instructions from the same on how to have the equipment collected separately at the end of its useful life.



By collecting the disused equipment separately, it can be recycled, treated or disposed of in an environmentally friendly manner, thus helping to prevent the environment and public health from being affected negatively and enabling reuse and/or recycling of the materials forming the same equipment.

4 - Specification

4.1 Environmental Conditions

Installation location _____	Pollution degree 2 or lower (free from direct sunlight, vibration, dust, corrosive or inflammable gases, fog, vapour oil and dripped water, avoid saline environment)
Installation altitude _____	Max 2000m (6562 feet) above sea level. With 1.2% reduction in output current for every 100 m starting from 1000 m.
Mechanical conditions for installation _____	Vibrational stress: EN 60721-3-3 Class 3M1
Operating temperature _____	-10... +40°C (14°...104°F)
Operating temperature _____	+40 ... +50°C (+104 ... +122°F) with 1% derating every °C starting from 40°C and up to 50°C. Operation at temperatures of > 50°C is not allowed
Air humidity (operating) _____	from 5 % to 85 % and from 1 g/m ³ to 25 g/m ³ without moisture condensation or icing
Air pressure (operating) [kPa] _____	from 70 to 106

4.2 Standards

Immunity / emissions _____	In compliance with EN61800-3. Conducted emission C2 up to 11kW and C3 with "F" configuration.
Climatic conditions _____	EN 60721-3-3
Electrical safety _____	EN 50178, EN 61800-5-1
Vibration _____	Class 3M1 EN 60721-3-3
EMC compatibility _____	EN 61800-3
Protection degree _____	IP20
Approvals _____	  UL US LISTED (UL 508C)
Directive EC _____	LVD 2014/35/EU, EMC 2014/30/EU

4.3 Precision

4.3.1 Speed control

Speed control precision _____ Flux vector CL control with feedback and brushless: 0.01 % motor rated speed

4.3.2 Speed control limits

Speed range (1) _____ ± 32000 rpm
Speed format (1) _____ 32 bit
Max frequency _____ Flux vector CL control with feedback and brushless: 300 Hz
Min frequency _____ 0 Hz

(1) referred to Full scale speed, PAR 680.

4.3.3 Torque control

Torque resolution (2) _____ > 0.1 %
Torque control precision (2) _____ Flux vector CL with feedback: ± 5%
Direct torque control _____ yes
Current limitation _____ Limits ±, Mot/gen limits, Variable limits

(2) referred to rated torque

4.3.4 Current rating

Overload (3) _____ slow overload = 170% * 60 sec; fast overload = 200% * 3 sec.
Switching frequency _____ 8 kHz max (4 kHz default)

(3) referred to PWM frequency = 4 kHz .

4.4 Input electrical data

Connection to TT and TN networks _____ yes
 Choke _____ Sizes 2...3: Optional (AC side), sizes 4-5 : integrated (DC side)

Size	Input voltage U_{LN} (Vac)	Input frequency (Hz)	Overvoltage threshold (Vdc)	Undervoltage threshold (Vdc)	In AC input current for continuous operation			DC-Link Capacity (μ F)
					@ 230 Vac (Arms)	@ 400 Vac (Arms)	@ 480 Vac (Arms)	
2075	three-phase 230-400-480Vac -15%+10%	50/60 Hz, \pm 5%	820 Vdc	@ 480 Vac = 470 Vdc @ 460 Vac = 450 Vdc @ 400 Vac = 391 Vdc @ 230 Vac = 225 Vdc	24	24	21	680
2110					28	28	25	1020
3150					40	40	35	1500
3185					48	48	43	2250
3220					51	51	46	2700
4300/4301 ⁽¹⁾					64	65	61	2350
4370/4371 ⁽¹⁾					79	80	75	2350
4450/4451 ⁽¹⁾					96	99	93	2800
5550 ⁽¹⁾					112	116	109	4700
5750 ⁽¹⁾					158	161	148	5600
5S550 ⁽²⁾					113 ⁽³⁾	120 ⁽³⁾	114 ⁽³⁾	4700
5S750 ⁽²⁾					158 ⁽³⁾	161 ⁽³⁾	148 ⁽³⁾	5600

(1) With integrated DC input choke, in accordance with EN 61800-3.

(2) ADP200-5S550 and 5S750 models: AC input external choke is mandatory.

(3) Input current is with AC input choke.

Note !

For external DC or AC input chokes please refer to chapter 5.2.

4.5 Output electrical data

Motor type _____ Synchronous
 Maximum output voltage U_2 _____ $0.98 \times U_{LN}$ (U_{LN} = AC input voltage)
 Maximum output frequency f_2 _____ 300 Hz

Size	In Rated output current (fsw = default)			Pn mot (Recommended motor power, fsw = default)				fsw (4) Switching frequency		Reduction factor				IGBT braking unit
	@ U_{LN} = 230VAC (A)	@ U_{LN} = 400VAC (A)	@ U_{LN} = 460VAC (A)	@ U_{LN} = 230VAC (kW)	@ U_{LN} = 230VAC (Hp)	@ U_{LN} = 400VAC (kW)	@ U_{LN} = 460VAC (Hp)	Other (kHz)	Default (kHz)	Kt (1)	KALT (2)	Kv (3)	Kf (5)	
2075	18.5	18.5	16.7	4	5	7.5	10	8	4	0.9	1.2	0.9	0.7	Standard internal (with external resistor); braking torque 150% MAX External optional on 5750 size.
2110	22	22	19.8	5.5	7.5	11	15	8	4	0.9	1.2	0.9	0.7	
3150	32	32	28.8	7.5	10	15	20	8	4	0.9	1.2	0.9	0.7	
3185	39	39	35.1	9	15	18.5	25	8	4	0.9	1.2	0.9	0.7	
3220	42	42	37.8	11	15	22	30	8	4	0.9	1.2	0.9	0.7	
4300/4301	60	60	54	15	20	30	40	8	4	0.9	1.2	0.9	0.7	
4370/4371	75	75	67.5	18.5	25	37	50	8	4	0.9	1.2	0.9	0.7	
4450/4451	90	90	81	22.0	30	45	60	8	4	0.9	1.2	0.9	0.7	
5550 / 5S550	105	105	94	30	40	55	75	8	4	0.9	1.2	0.9	0.7	
5750 - 5S750	150	150	135	37	50	75	100	8	4	0.9	1.2	0.9	0.7	

The derating factors shown in the table are applied to the rated DC output by the user. They are not automatically implemented by the drive: $I_{drive} = I_n \times K_{alt} \times K_t \times K_v$

(1) Kt: Derating factor for ambient temperature of 50°C (1% every °C above 40°C)

(2) KALT: Derating factor for installation at altitudes above 1000 meters a.s.l. Value to be applied = 1.2% each 100 m increase above 1000 m (up to a maximum of 2000 m).

E.g.: Altitude 2000 m, $K_{alt} = 1.2\% \times 10 = 12\%$ derating; I_n derated = $(100 - 12)\% = 88\% I_n$

(3) Kv : Derating factor for mains voltage at 460/480Vac.

(4) There is also the possibility to set a variable switching frequency through parameter setting.

(5) For fixed Switching frequency fsw = 8 kHz.

4.5.1 Derating values in overload condition

In overload conditions the output current depends on the output frequency, as shown in the figure below.

Size	Tambient [°C]	K1 [%OL]	K2 [Hz]	K3 [Hz]
2075	40	169	0,1	1,5
2110	40	199	0	0,1
3150	40	191	0	0,6
3185	40	200	0	0
3220	40	180	0	1,1
4300/4301	40	176	0	2
4370/4371	40	200	0	0
4450/4451	40	189	0	0,9
5550 / 5S550	40	200	0	0
5750 / 5S750	40	200	0	0

Figure 4.5.1-A: Current derating curves according to the variation of the output frequency

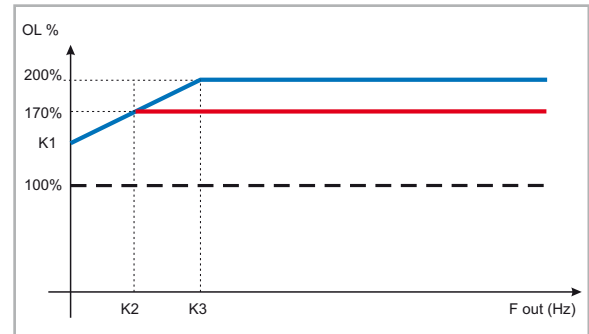

K1, K2 and K3 are 3 values identifying current derating curves according to the variation of the output frequency. These values depend on the temperature of the heatsink. The values of K1, K2 and K3 shown in the table refer to the ambient temperature of 40 ° C, with constant switching frequency of 4kHz and with drive used in continuous operation at nominal current plus fast and slow overload. During operation at variable switching frequency, the drive automatically switches from working frequency of 8kHz to 4kHz, when the temperature of the heat sink exceeds the threshold T heatsink th (see Figure 4.5.2)

Note !

Accessories (brake resistors, filters EMI and external AC input choke) are sized specifically for the injection molding machine application. For other applications, refer to WEG customer service.

Figure 4.5.1-B: Overload cycles

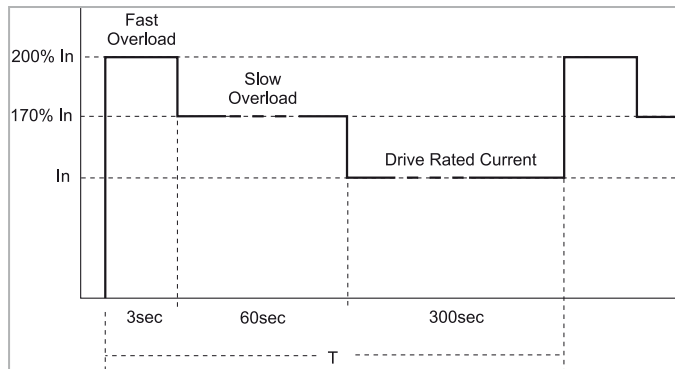

4.5.2 Derating values for switching frequency

ADP200 is factory set to 4kHz constant switching frequency (PAR 568 **Switching freq mode** = [0] Constant). The figure 4.5.2 is valid only when PAR 568 **Switching freq mode** = [1] Variable, refer to ADP200 FP manual for more details. The switching frequency is modified according to the temperature of the drive (measured on the heat sink), as shown in the figure below.

Figure 4.5.2: Ratio between switching frequency/heat sink temperature

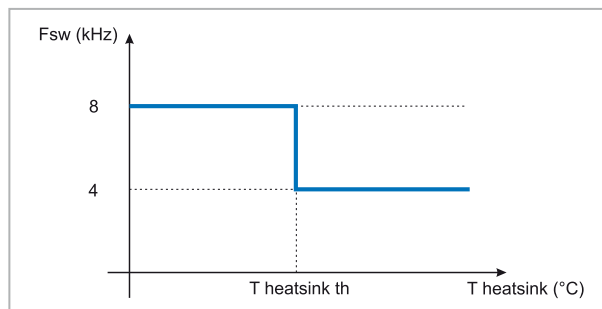

4.5.3 Kalt: Ambient temperature reduction factor

Figure 4.5.3: Tamb reduction coefficient

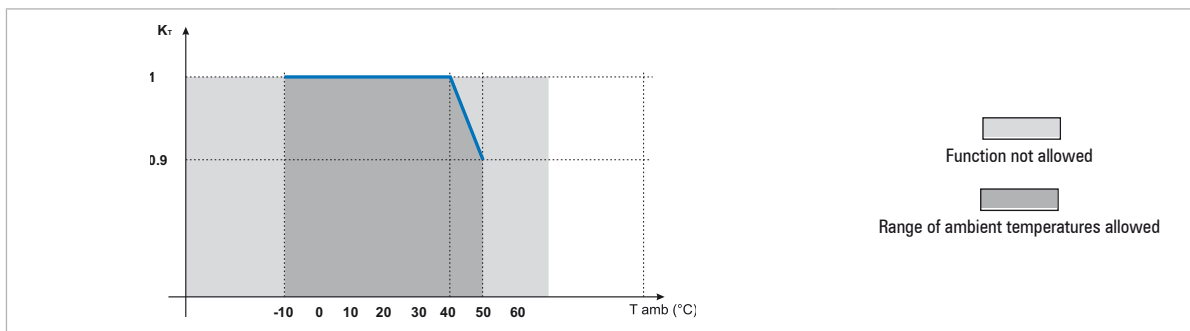

4.6 Voltage level of the inverter for safe operations

The **minimum time** between the moment in which an ADP200 inverter is disabled from the mains and that in which an operator can operate on internal parts of the inverter, without the danger of electric shock, **is 5 minutes**.



.....
 This value takes into account the time to turn off an inverter supplied at 460 VAC + 10%, without any options (time indicated for disabled inverter condition).

4.8 Cooling

All inverters are equipped with internal fans.

Size	Pv (Heat dissipation) @ULN=230...460VAC (*)	Fan capacity		Minimum cabinet opening for cooling (cm ²)
		Heat sink (m ³ /h)	Internal (m ³ /h)	
2075	220	2 x 58	-	144
2110	250	2 x 35	-	144
3150	350	2 x 98	32	328
3185	410	2 x 98	32	328
3220	450	2 x 104	32	328
4300/4301	680	2 x 98	2 x 64	512
4370/4371	800	2 x 190	2 x 64	595
4450/4451	980	2 x 190	2 x 64	595
5550 / 5S550	1100	2 x 285	170	864
5750 / 5S750	1750	2 x 285	2 x 170	1152

(*) values that refer to operation at default switching frequency (4kHz) and rated current.

4.9 Weights and dimensions

Figure 4.9.1: Size 2 dimensions

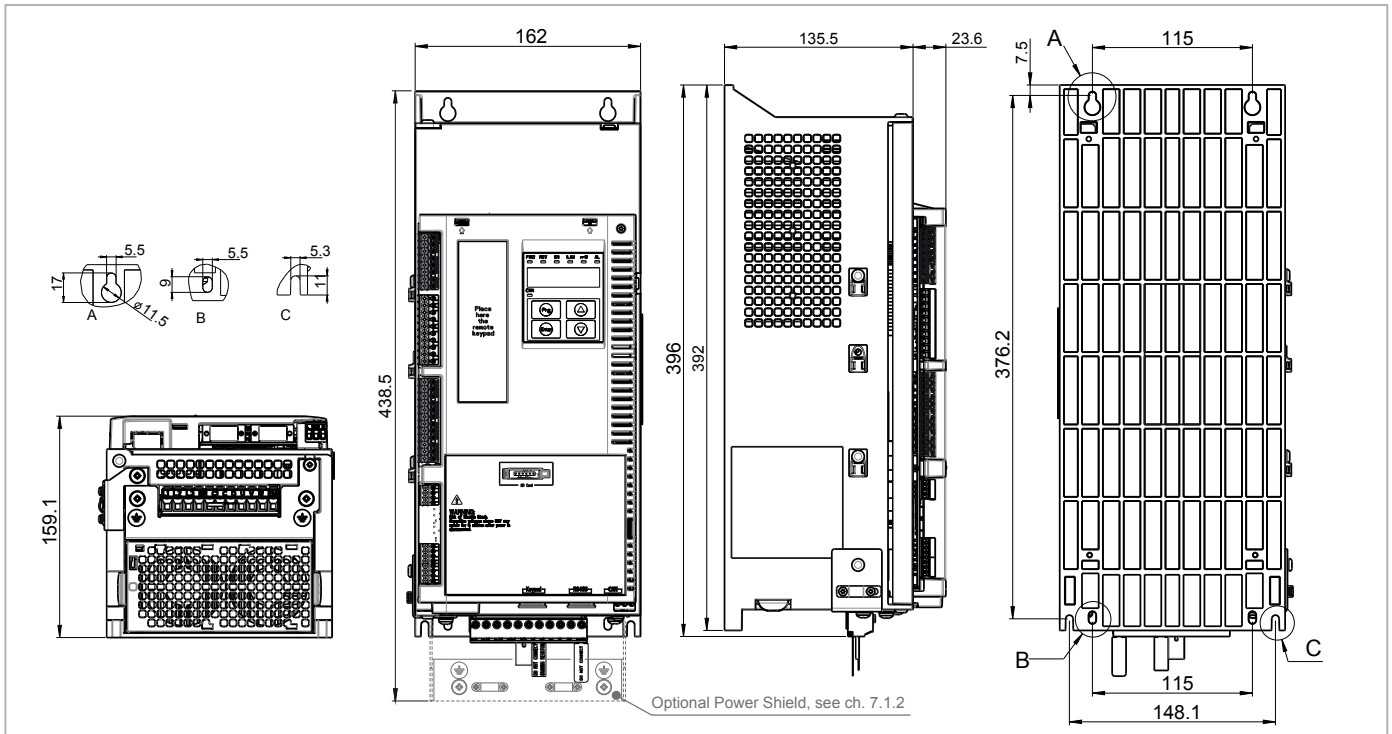

Sizes	Dimensions: Width x Height x Depth		Weight	
	(mm)	(inches)	(kg)	(lbs)
ADP200-2075-...	162 x 396 (438.5)* x 159	6.38 x 15.59 (17.26)* x 6.26	7.8	17.2
ADP200-2110-...				

Figure 4.9.2: Size 3 dimensions

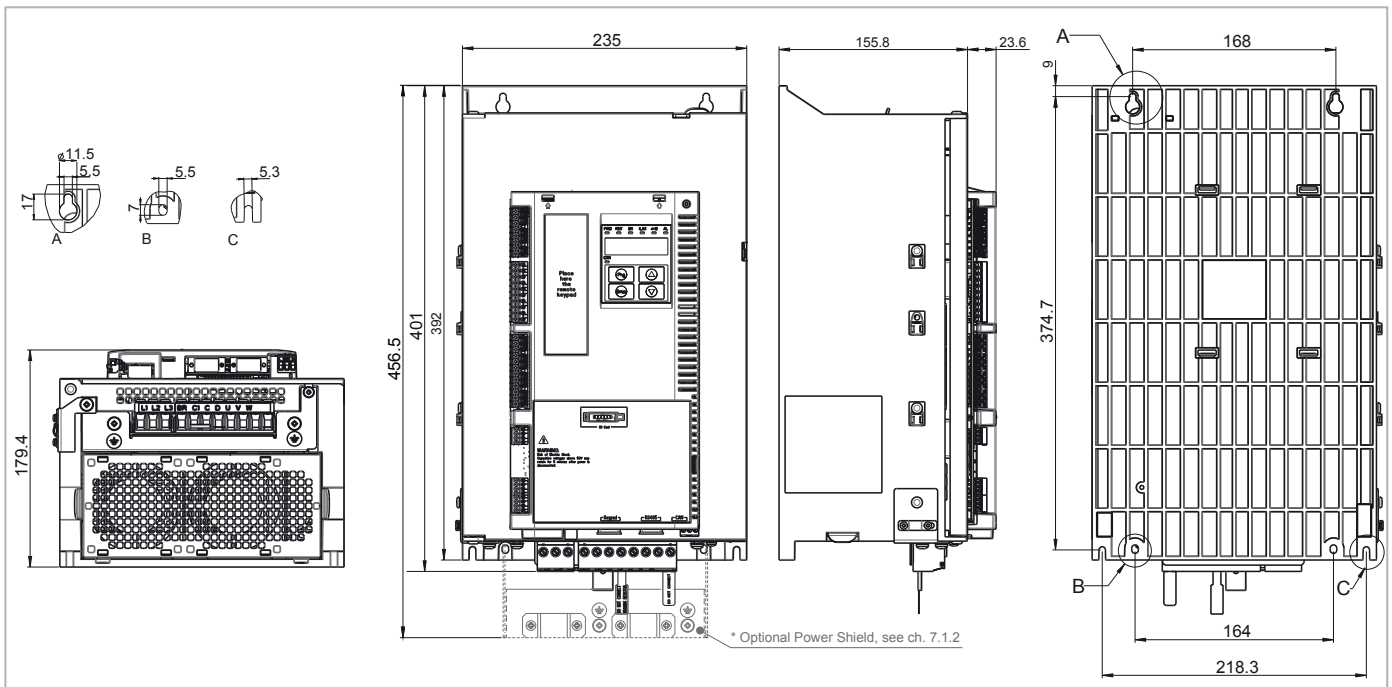

Sizes	Dimensions: Width x Height x Depth		Weight	
	(mm)	(inches)	(kg)	(lbs)
ADP200-3150-...	235 x 401 (456.5)* x 179.4	9.25 x 15.79 (17.97)* x 7.06	10.5	23.15
ADP200-3185-...				
ADP200-3220-...				

Figure 4.9.3: Size 4 dimensions

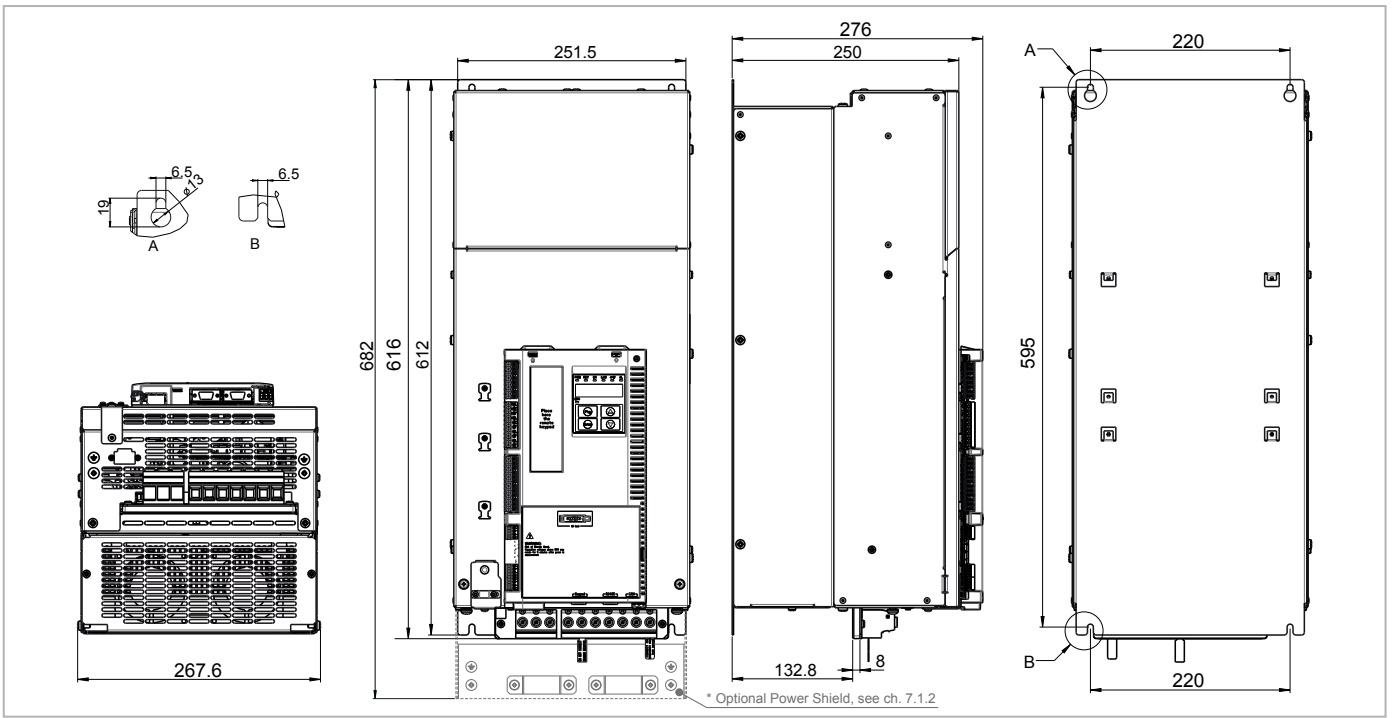

Sizes	Dimensions: Width x Height x Depth		Weight	
	(mm)	(inches)	(kg)	(lbs)
ADP200-4300/4301-...	267.6 x 616 (682)* x 276	10.53 x 24.25 (26.85)* x 10.87	32	70.6
ADP200-4370/4371-...				
ADP200-4450/4451-...				

Figure 4.9.4: Size 5 dimensions (55kW)

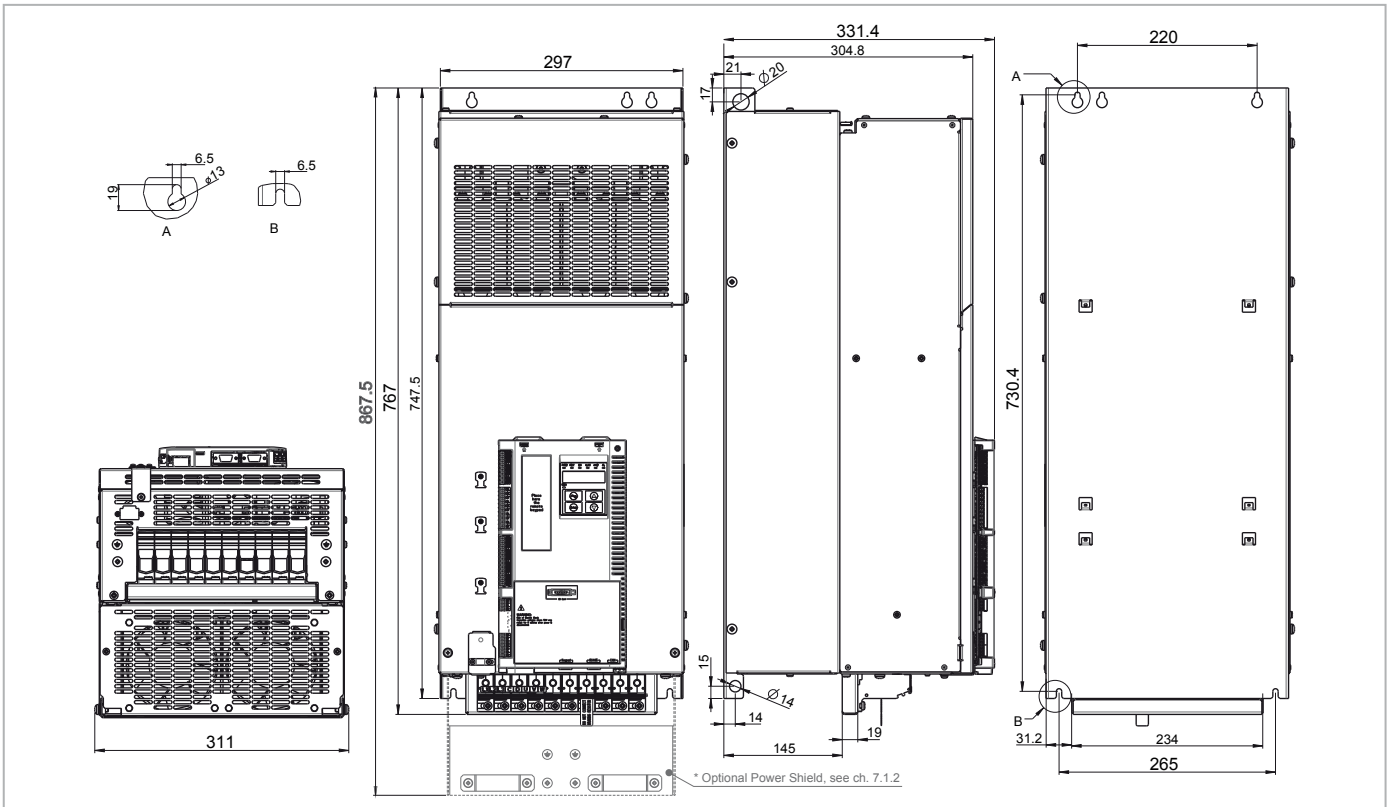

Sizes	Dimensions: Width x Height x Depth		Weight	
	(mm)	(inches)	(kg)	(lbs)
ADP200-5550-...	311 x 767 (867.5)* x 331.4	12.2 x 30.2 (34.15)* x 13.05	60	132.3

Figure 4.9.5: Size 5 dimensions (75kW)

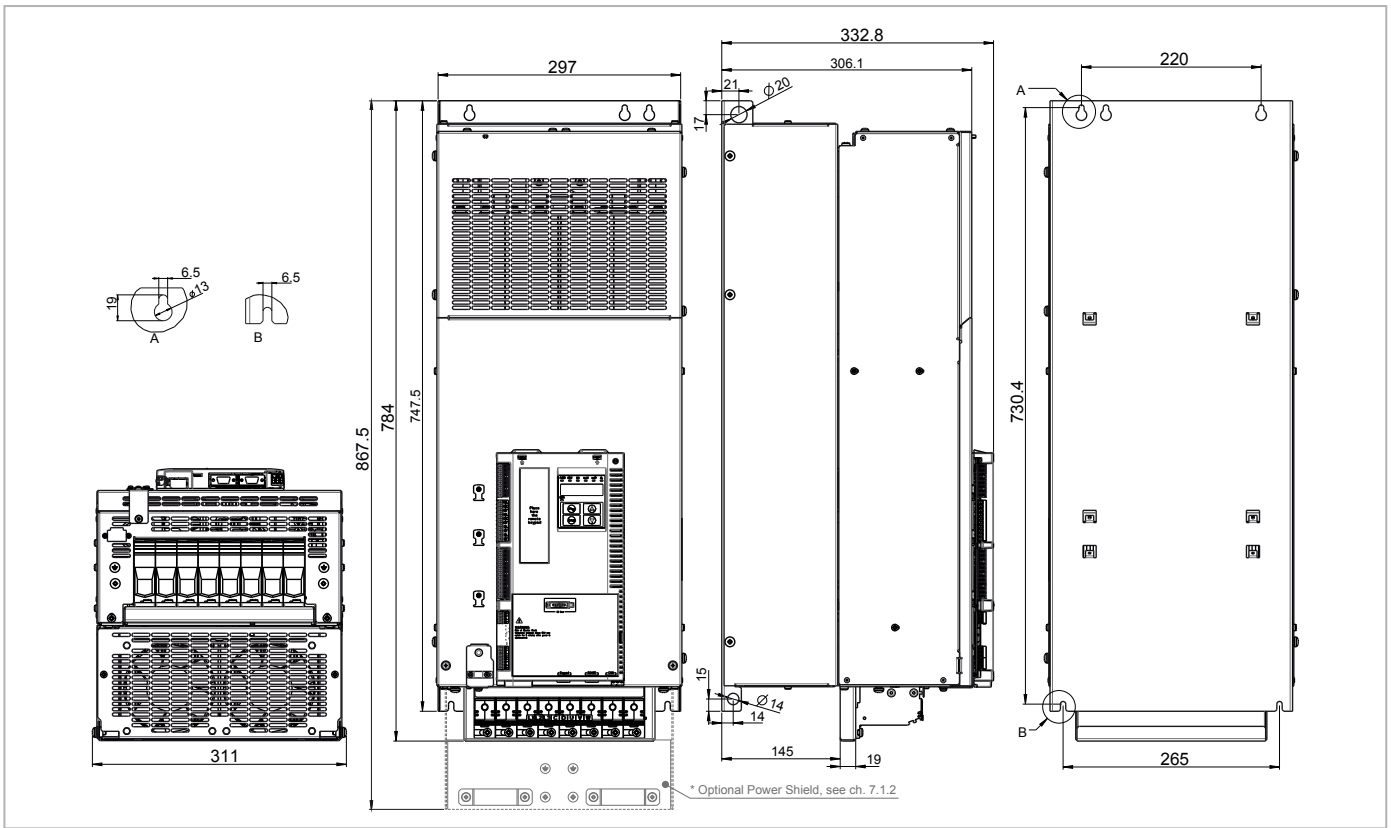

Sizes	Dimensions: Width x Height x Depth		Weight	
	(mm)	(inches)	(kg)	(lbs)
ADP200-5750-...	311 x 784 (867.5)* x 332.8	12.2 x 30.8 x 13.1	60	132.3

Figure 4.9.6: Size 5S dimensions (55-75kW)

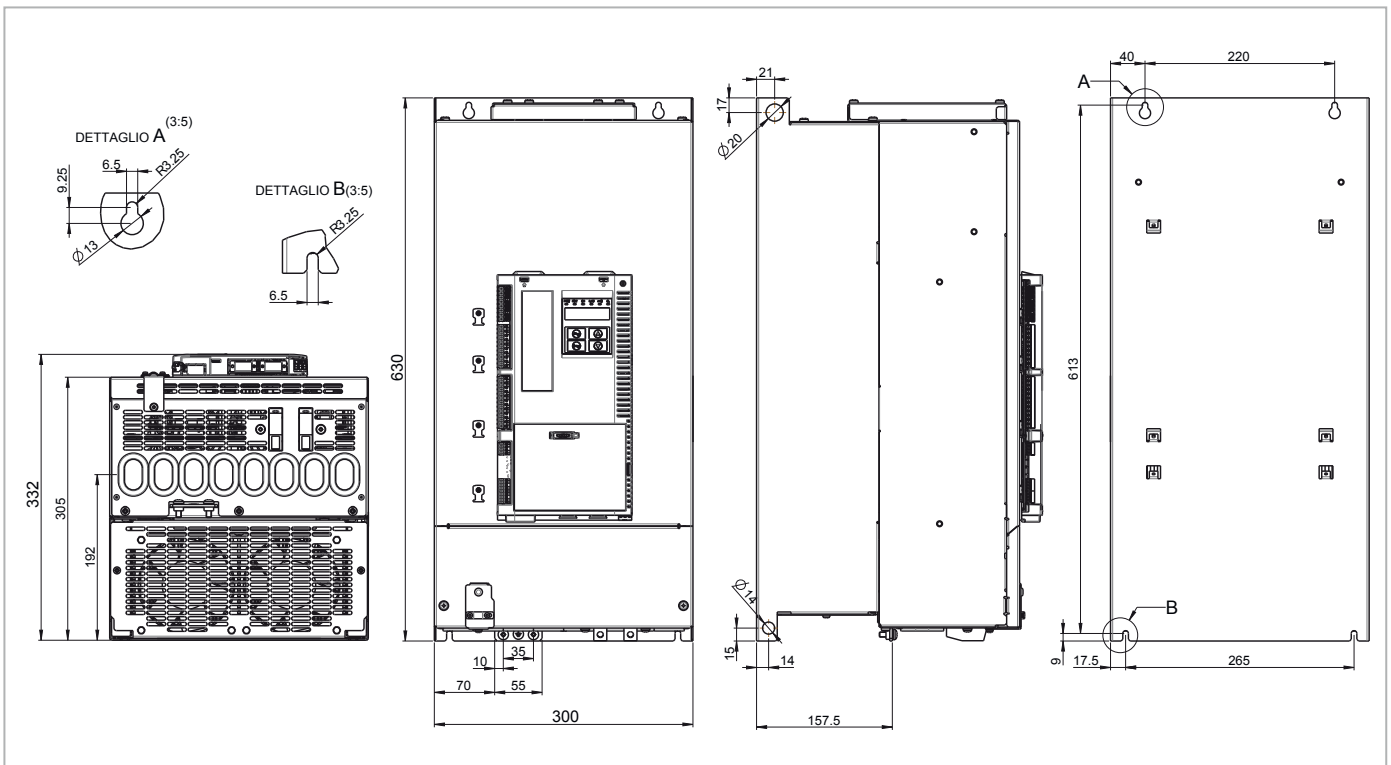

Sizes	Dimensions: Width x Height x Depth		Weight	
	(mm)	(inches)	(kg)	(lbs)
ADP200-5S550-... ADP200-5S750-...	300 x 630 x 332	11,8 x 24,8 x 13,07	42	92,6

5- Options

5.1 Optional external fuses

5.1.1 Network side fuses (F1)

The inverter must be fused upstream on the network side.
Use fast-acting fuses only.

Size	F1 - External network side fuses					
	DC link capacitor hours of service life [h]		EUROPE		AMERICA	
	Without mains choke (*)	With mains choke	Type	Code	Type	Code
2075	> 20000	> 50000	GRD3/35	F4D20	A70P40	S7G52
2110	> 20000	> 50000	Z22GR40	F4M16	A70P40	S7G52
3150	> 20000	> 50000	Z22GR63	F4M17	A70P60-4	S7I34
3185	> 20000	> 50000	Z22GR80	F4M19	A70P80	S7G54
3220	> 20000	> 50000	Z22GR80	F4M19	A70P80	S7G54
4300/4301	> 25000	-	Z22GR80	F4M19	A70P80	S7G54
4370/4371	> 25000	-	Z22GR100	F4M21	A70P100	S849B
4450/4451	> 25000	-	Z22GR100	F4M21	A70P100	S849B
5550	> 25000	-	S00/üf1/80/200A/690V	F4G23	A70P200	S7G58
5750	> 25000	-	S00/üf1/80/200A/690V	F4G23	A70P200	S7G58
5S550	> 25000	50000	S00/üf1/80/200A/690V	F4G23	A70P200	S7G58
5S750	> 25000	50000	S00/üf1/80/200A/690V	F4G23	A70P200	S7G58

Technical data for fuses, including dimensions, weights, power leakage, fuse carriers etc. are reported in the corresponding manufacturers' data sheets:

GRD... (E27), S00...

Jean Müller, Eltville

A70...

Ferraz

(*) Pcc max

5.2 Input chokes

The three-phase mains choke is strongly recommended in order to:

- limit the RMS input current of the ADP200 inverter,
- increase the life of intermediate circuit capacitors and reliability of input diodes,
- reduce mains harmonic content,
- reduce problems due to power supply via a low impedance line ($\leq 1.3\%$).

5.2.1 AC input chokes

AC mains 230V/50Hz,						
Size	Pmotor recommended	In (without AC input chokes) (A)	In with LR3 AC input chokes		Pcc mains max, without AC input chokes (kVA)	Input THD @ rated Iout with LR3 AC input chokes
			(A)	mH, model (code)		
2075	4	24	20	0.89mH, LR3y-2075 (S7AB6)	461	<40
2110	5.5	28	24	0.68mH, LR3y-3110 (S7AB7)	548	<40
3150	7.5	40	34	0.51mH, LR3y-3150 (S7AB8)	797	<40
3185	9	48	42	0.35mH, LR3-22 (S7FF4)	971	<40
3220	11	51	45	0.35mH, LR3-22 (S7FF4)	1,046	<40
4300/4301	15	64	-	-	-	-
4370/4371	18.5	79	-	-	-	-
4450/4451	22.0	96	-	-	-	-
5550	30	112	-	-	-	-
5750	37	158	-	-	-	-
5S550	30	-	113	0.13mH, LR3-055 (S7FF1)	-	<40
5S750	37	-	158	0.15mH, LR3-090 (S7D19)	-	<40

AC mains 400V/50Hz,						
Size	Pmotor recommended	In (without AC input chokes) (A)	In with LR3 AC input chokes (code)		Pcc mains max, without AC input chokes (kVA)	Input THD @ rated Iout with LR3 AC input chokes
			(A)	mH, model (code)		
2075	7.5	24	20	0.89mH, LR3y-2075 (S7AB6)	986	<50
2110	11	28	25	0.68mH, LR3y-3110 (S7AB7)	1,172	<50
3150	15	40	35	0.51mH, LR3y-3150 (S7AB8)	1,705	<50
3185	18.5	48	44	0.35mH, LR3-22 (S7FF4)	2,078	<50
3220	22	51	47	0.35mH, LR3-22 (S7FF4)	2,238	<50
4300/4301	30	65	-	-	-	-
4370/4371	37	80	-	-	-	-
4450/4451	45	99	-	-	-	-
5550	55	116	-	-	-	-
5750	75	161	-	-	-	-
5S550	55	-	120	0.13mH, LR3-055 (S7FF1)	-	<55
5S750	75	-	161	0.15mH, LR3-090 (S7D19)	-	<45

AC mains 480V/50Hz,						
Size	Pmotor recommended	In (without AC input chokes) (A)	In with LR3 AC input chokes (code)		Pcc mains max, without AC input chokes (kVA)	Input THD @ rated Iout with LR3 AC input chokes
			(A)	mH, model (code)		
2075	7.5	21	19	0.89mH, LR3y-2075 (S7AB6)	1,065	<60
2110	11	25	24	0.68mH, LR3y-3110 (S7AB7)	1,266	<60
3150	15	35	33	0.51mH, LR3y-3150 (S7AB8)	1,842	<60
3185	18.5	43	41	0.35mH, LR3-22 (S7FF4)	2,245	<60
3220	22	46	44	0.35mH, LR3-22 (S7FF4)	2,417	<60
4300/4301	30	61	-	-	-	-
4370/4371	37	75	-	-	-	-
4450/4451	45	93	-	-	-	-
5550	55	109	-	-	-	-
5750	75	148	-	-	-	-
5S550	55	-	114	0.13mH, LR3-055 (S7FF1)	-	<65
5S750	75	-	148	0.15mH, LR3-090 (S7D19)	-	<55

Note:

- For the standard application of the ADP200 (injection molding machine with servopump), LR3 input choke for sizes 7.5kW to 22kW can be omitted only if the Pcc line is below the values shown in the table.
- For machines or processes with continuous working cycles at nominal data, the input choke may be mandatory. Please contact WEG sales department for further information and details.
- (*) AC input choke is mandatory on ADP200-5S550 / ADP200-5S750 sizes.
- Use of the input choke extends the life of the drive.

5.2.2 DC input chokes

Size	THD (%)	In (@400V/50Hz, with DC input chokes) (A)	Model	Code	Dimensions: WxHxd mm [inches]	Weight kg [lbs]
2075	< 35 %	16	LDC-007	S7AI12	125 x 122 x 127 [4.92 x 4.8x5]	4.9 [10.8]
2110		21	LDC-011	S7AI13	125 x 142 x 127 [4.92 x 5.59 x 5]	6.6 [14.55]
3150		28	LDC-015	S7AI14	125 x 152 x 1 27 [4.92 x 5.98 x 5]	8 [17.63]
3185		35	LDC-022	S7AI15	155 x 148 x 160 [4.92 x 5.82 x 6.3]	8.5 [18.74]
3220		40	LDC-022	S7AI15	155 x 148 x 160 [4.92 x 5.82 x 6.3]	8.5 [18.74]
4300/4301	45	Internal choke				
4370/4371	40					
4450/4451	45					
5550	50					
5750	40					

Note!

The DC input choke is not integrated and can not be connected on ADP200-5S550 / ADP200-5S750 sizes.

5.3 AC output chokes

The ADP200 inverter can be used with standard motors or motors designed specifically for use with inverters. The latter usually have a higher isolation rating to better withstand PWM voltage. Examples of reference regulations are provided below: motors designed for use with inverters do not require any specific filtering of output from the inverter. For standard motors, especially with long cable runs (typically over 100 m) an output choke may be necessary to maintain the voltage waveform with the specified limits.

The range of recommended chokes are listed in the following table. The rated current of the chokes should be approx. 20% higher than that of the inverter in order to take into account additional losses due to modulation of the output waveform.

Size	Model	Code	Dimensions: WxHxd mm [inches]	Weight kg [lbs]
2075	LU3-011	S7FG4	180 x 185 x130	8 [17.64]
2110	LU3-011	S7FG4	180 x 185 x130	8 [17.64]
3150	LU3-015	S7FH2	180 x 185 x140	7 [15.43]
3185	LU3-022	S7FH3	180 x 185 x160	8.2 [18.08]
3220	LU3-022	S7FH3	180 x 185 x160	8.2 [18.08]
4300/4301	LU3-030	S7FH4	180 x 185 x170	10 [22.05]
4370/4371	LU3-037	S7FH5	180 x 185 x170	10 [22.05]
4450/4451	LU3-055	S7FH6	240 x 216 x170	16 [35.27]
5550 / 5S550	LU3-055	S7FH6	240 x 216 x170	16 [35.27]
5750 / 5S750	LU3-090	S7FH10	180 x 165 x195	15 [33.07]

Note!

With the inverter operated at the rated current and a frequency of 50 Hz, the output chokes cause a voltage drop of approx. 2% of the output voltage.

5.4 External braking resistors (optional)

Recommended combinations for use with internal braking unit.

Table 5.4.1: Recommended combination ADP200

Size	List and technical data of standard external resistors							
	Resistor type	Code	Q.ty	PNBR (W)	RBR (Ω)	Max Overload 1" - service 10% Ebr [kJ]	Max Overload 1" - service 5% Ebr [kJ]	Housing
2075	SRF 600 T 68R	S8SA21	1	600	68	6	12	IP54
2110	SRF 600 T 40R	S8SA22	1	600	40	6	12	IP54
3150	SRF 600 T 26R	S8SA17	1	600	26	6	12	IP54
3185	SRF 600 T 18R	S8SA23	1	600	18	6	12	IP54
3220	SRF 600 T 18R	S8SA23	1	600	18	6	12	IP54
4300/4301	SRF 1K0 T 12R	S8SA18	1	1000	12	10	20	IP54
4370/4371	SRF 1K0 T 12R	S8SA18	1	1000	12	10	20	IP54
4450/4451	SRF 1K0 T 10R	S8SA19	1	1000	10	10	20	IP54
5550 / 5S550	SRF 1K0 T 8R	S8SA20	1	1000	8	10	20	IP54
5750 (*) / 5S750	SRF 1K0 T 8R	S8SA20	1	1000	8	10	20	IP54

(*) Recommended combination for use with external braking unit BUy 1050.

Size	Resistor type	Dimensions: WxHxD mm [inches]	Weight kg [lbs]
2075	SRF 600 T 68R	320 [12.6] x 27 [1.06] x 36 [1.42]	0.65 [1.4]
2110	SRF 600 T 40R	320 [12.6] x 27 [1.06] x 36 [1.42]	0.65 [1.4]
3150	SRF 600 T 26R	320 [12.6] x 27 [1.06] x 36 [1.42]	0.65 [1.4]
3185	SRF 600 T 18R	320 [12.6] x 27 [1.06] x 36 [1.42]	0.65 [1.4]
3220	SRF 600 T 18R	320 [12.6] x 27 [1.06] x 36 [1.42]	0.65 [1.4]
4300/4301	SRF 1K0 T 12R	320 [12.6] x 100 [3.93] x 30 [1.18]	2.35 [5.2]
4370/4371	SRF 1K0 T 12R	320 [12.6] x 100 [3.93] x 30 [1.18]	2.35 [5.2]
4450/4451	SRF 1K0 T 10R	320 [12.6] x 100 [3.93] x 30 [1.18]	2.35 [5.2]
5550 / 5S550	SRF 1K0 T 8R	320 [12.6] x 100 [3.93] x 30 [1.18]	2.35 [5.2]
5750 (*) / 5S750	SRF 1K0 T 8R	320 [12.6] x 100 [3.93] x 30 [1.18]	2.35 [5.2]

PNBR Braking resistor rated power

RBR Braking resistor ohmic value

EBR Maximum energy that can be dissipated on the resistor

Braking resistors may be subject to unexpected overloads due to faults.

Resistors **MUST** be protected using thermal cutouts. These devices must not interrupt the circuit in which the resistor is inserted but their auxiliary contact must cut off the power supply to the power section of the drive. If the resistor requires a protection contact, this must be used together with that of the thermal cutout.

A la suite de pannes, les résistances de freinage peuvent être sujettes à des surcharges imprévues. La protection des résistances au moyen de dispositifs de protection thermique est absolument capitale. Ces dispositifs ne doivent pas interrompre le circuit qui abrite la résistance, mais leur contact auxiliaire doit couper l'alimentation du côté puissance du drive. Si la résistance prévoit un contact de protection, ce dernier doit être utilisé conjointement à celui du dispositif de protection thermique.



5.5 EMC Filter

The ADP200-...-F inverters are equipped with an internal EMI filter:

Sizes		Conducted emissions according to Category / Motor cable length
ADP200-2075-...-F	Models with an internal EMI filter	EN 61800-3 C2 / 10 m
ADP200-2110-...-F	Models with an internal EMI filter	EN 61800-3 C3 / 10 m
ADP200-3150-...-F		
ADP200-3185-...-F		
ADP200-3220-...-F		
ADP200-4300/4301-...-F		
ADP200-4370/4371-...-F		
ADP200-4450/4451-...-F		
ADP200-5550-...-F ADP200-5S550-...-F		
ADP200-5750-...-F ADP200-5S750-...-F		

For ADP200 models without integrated EMI filters the **optional external filters** are reported in the table:

Sizes	Type	Code	Dimensions: WxHxd mm [inches]	Weight kg [lbs]	Conducted emissions according to Category / Motor cable length
ADP200-2075	EMI-FTF-480-16	S7GHO	250 [9.84] x 45 [1.77] x 70 [2.76]	0.8 [1.8]	EN 61800-3 C2 / 30 m
ADP200-2110	EMI-FTF-480-30	S7GHP	270 [10.63] x 50 [1.97] x 85 [3.35]	1 [2.2]	
ADP200-3150	EMI-FTF-480-30	S7GHP	270 [10.63] x 50 [1.97] x 85 [3.35]	1 [2.2]	
ADP200-3185	EMI-FTF-480-42	S7GOA	310 [12.20] x 50 [1.97] x 85 [3.35]	1.3 [2.9]	EN 61800-3 C3 / 30 m
ADP200-3220	EMI-FTF-480-42	S7GOA	310 [12.20] x 50 [1.97] x 85 [3.35]	1.3 [2.9]	
ADP200-4300/4301	EMI FTF-480-55	S7GOB	250 [9.84] x 90 [3.54] x 85 [3.35]	1.9 [4.2]	
ADP200-4370/4371	EMI FTF-480-75	S7GOC	270 [10.63] x 80 [3.15] x 135 [5.31]	2.6 [5.7]	
ADP200-4450/4451	EMI FTF-480-100	S7GOD	270 [10.63] x 90 [3.54] x 150 [5.91]	3 [6.6]	
ADP200-5550 ADP200-5S550	EMI FTF-480-100	S7GOD	270 [10.63] x 90 [3.54] x 150 [5.91]	3 [6.6]	
ADP200-5750 ADP200-5S750	EMI FTF-480-130	S7GOE	270 [10.63] x 90 [3.54] x 150 [5.91]	3.6 [7.9]	

6 - Mechanical installation



The Drive must be mounted on a wall that is constructed of heat resistant material. While the Drive is operating, the temperature of the Drive's cooling fins can rise to a temperature of 158° F (70°C).

Le drive doit être monté sur un mur construit avec des matériaux résistants à la chaleur. Pendant le fonctionnement du drive, la température des ailettes du dissipateur thermique peut arriver à 70°C (158° F).

Because the ambient temperature greatly affects Drive life and reliability, do not install the Drive in any location that exceeds the allowable temperature.

Étant donné que la température ambiante influe sur la vie et la fiabilité du drive, on ne devrait pas installer le drive dans des places où la température permise est dépassée.

Be sure to remove the desiccant dryer packet(s) when unpacking the Drive. (If not removed these packets may become lodged in the fan or air passages and cause the Drive to overheat).

Lors du déballage du drive, retirer le sachet déshydraté. (Si celui-ci n'est pas retiré, il empêche la ventilation et provoque une surchauffe du drive).

Protect the device from impermissible environmental conditions (temperature, humidity, shock etc.).

Protéger l'appareil contre des effets extérieurs non permis (température, humidité, chocs etc.).

6.1 Maximum inclination and assembly clearances

The inverters must be mounted in such a way that air can flow freely around them, [see paragraph 4.8 Cooling](#).

- Maximum angle of inclination _____ 30° (referred to vertical position)
- Minimum top and bottom distance _____ 150 mm
- Minimum free space to the front _____ 25 mm
- Minimum distance between drives _____ 25 mm
- Minimum distance to the side with the cabinet _____ 25 mm

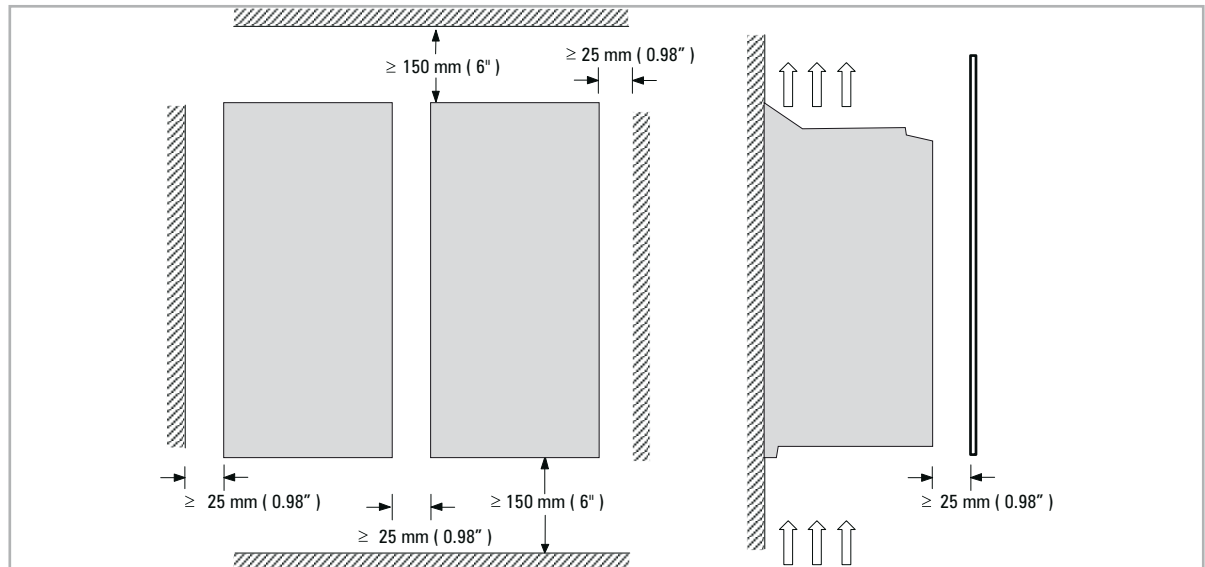

6.2 Fastening positions

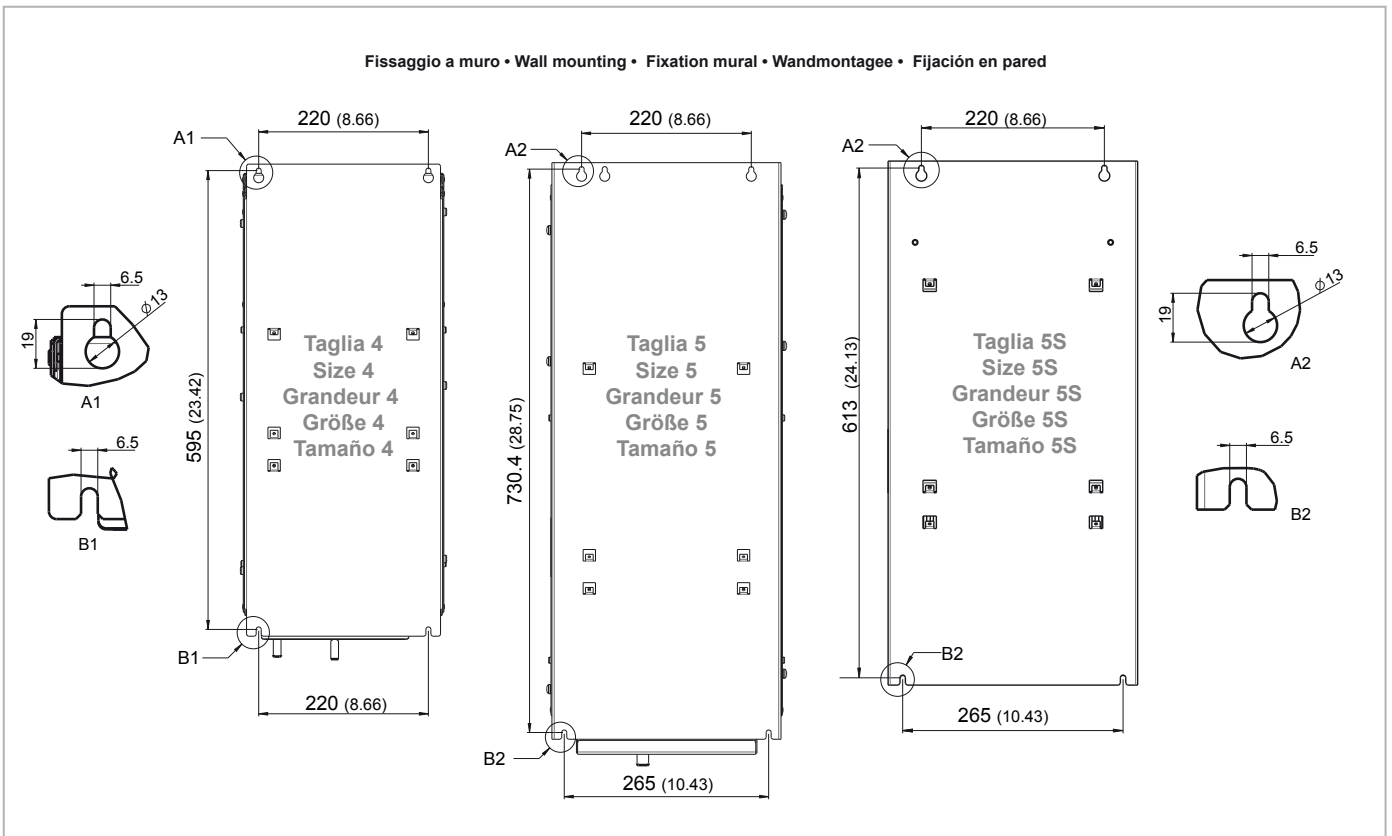
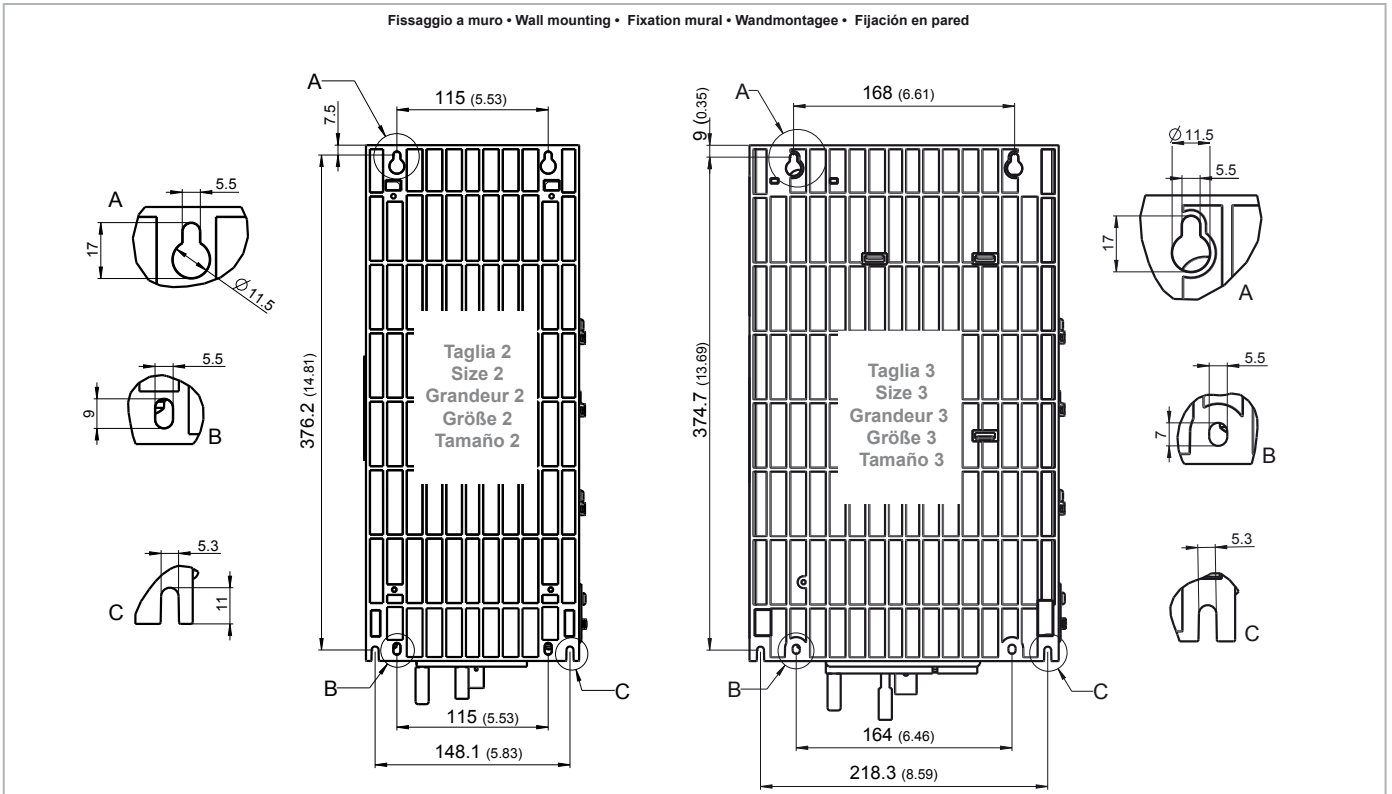

	Recommended screws for fastening
Size 2 - 3	4 x M5 x 12 mm screws + Grover (spring-lock) washer + flat washer
Size 4	4 x M6 x 16 mm screws + Grover (spring-lock) washer + flat washer
Size 5 - 5S	5 x M6 x 16 mm screws + Grover (spring-lock) washer + flat washer

Note!

Other dimensions see chapter 4.9 Weights and dimensions.

7 - Wiring Procedure



Warning!

Adjustable frequency drives are electrical apparatus for use in industrial installations. Parts of the Drives are energized during operation. The electrical installation and the opening of the equipment should therefore only be carried out by qualified personnel. Improper installation of motors or Drives may therefore cause the failure of the device as well as serious injury to persons or material damage. Drive is not equipped with motor overspeed protection logic other than that controlled by software. Follow the instructions given in this manual and observe the local and national safety regulations applicable.

Les drives à fréquence variable sont des dispositifs électriques utilisés dans des installations industriels. Une partie des drives sont sous tension pendant l'opération. L'installation électrique et l'ouverture des drives devrait être exécuté uniquement par du personnel qualifié. De mauvaises installations de moteurs ou de drives peuvent provoquer des dommages matériels ou blesser des personnes. On doit suivre les instructions données dans ce manuel et observer les règles nationales de sécurité.

Replace all covers before applying power to the Drive. Failure to do so may result in death or serious injury.

Remettre tous les capots avant de mettre sous tension le drive. Des erreurs peuvent provoquer de sérieux accidents ou même la mort.



Warning!

The drive must always be grounded. If the drive is not connected correctly to ground, extremely hazardous conditions may be generated that may result in death or serious injury.

Le drive doit toujours être raccordé au système de mise à la terre. Un mauvais raccordement du drive au système de mise à la terre peut se traduire par des conditions extrêmement dangereuses susceptibles d'entraîner le décès ou de graves lésions corporelles.

Never open the device or covers while the AC Input power supply is switched on. Minimum time to wait before working on the terminals or inside the device is listed in section 4.6.

Ne jamais ouvrir l'appareil lorsqu'il est sous tension. Le temps minimum d'attente avant de pouvoir travailler sur les bornes ou bien à l'intérieur de l'appareil est indiqué dans la section 4.6.

Do not touch or damage any components when handling the device. The changing of the isolation gaps or the removing of the isolation and covers is not permissible.

Manipuler l'appareil de façon à ne pas toucher ou endommager des parties. Il n'est pas permis de changer les distances d'isolement ou bien d'enlever des matériaux isolants ou des capots.



Caution

Do not connect power supply voltage that exceeds the standard specification voltage fluctuation permissible. If excessive voltage is applied to the Drive, damage to the internal components will result.

Ne pas raccorder de tension d'alimentation dépassant la fluctuation de tension permise par les normes. Dans le cas d'une alimentation en tension excessive, des composants internes peuvent être endommagés.

Operation with Residual Current Device (Differential switch)

If an RCD (also known as an RCCB or ELCB) is installed, it must have a high leakage current (≥ 300 mA).

RCD: Residual Current Device

RCCB: Residual Current Circuit Breaker

ELCB: Earth Leakage Circuit Breaker

Note:

The residual current operated circuit-breakers used must provide protection against direct-current components in the fault current and must be suitable for briefly suppressing power pulse current peaks. It is recommended to protect the frequency inverter by fuse separately.

The regulations of the individual country (e.g. VDE regulations in Germany) and the regional power suppliers must be observed!

Les RCD utilisés doivent assurer la protection contre les composants à courant continu présents dans le courant de défaut et doivent être capables de supprimer des crêtes de courant en peu de temps. Il est recommandé de protéger séparément l'onduleur au moyen de fusibles.

Respecter la réglementation des pays concernés (par exemple, les normes VDR en Allemagne) et des fournisseurs locaux d'énergie électrique.



Caution

Functioning of the Drive without a ground connection is not permitted. To avoid disturbances, the armature of the motor must be grounded using a separate ground connector from those of other appliances.

Défense de faire fonctionner le drive sans qu'il y ait eu raccordement de mise à la terre préalable. Pour éviter les perturbations, la carcasse du moteur doit être mise à la terre à l'aide d'un raccord de mise à la masse séparé de ceux des autres appareils.

The grounding connector shall be sized in accordance with the NEC or Canadian Electrical Code. The connection shall be made by a UL listed or CSA certified closed-loop terminal connector sized for the wire gauge involved. The connector is to be fixed using the crimp tool specified by the connector manufacturer.

Le raccordement devrait être fait par un connecteur certifié et mentionné à boucle fermé par les normes CSA et UL et dimensionné pour l'épaisseur du câble correspondant. Le connecteur doit être fixé à l'aide d'un instrument de serrage spécifié par le producteur du connecteur.

Do not perform a megger test between the Drive terminals or on the control circuit terminals.

Ne pas exécuter un test megger entre les bornes du drive ou entre les bornes du circuit de contrôle.

No voltage should be connected to the output of the drive (terminals U2, V2 and W2). The parallel connection of several drives via the outputs and the direct connection of the inputs and outputs (bypass) are not permissible.

Aucune tension ne doit être appliquée sur la sortie du convertisseur (bornes U2, V2 et W2). Il n'est pas permis de raccorder la sortie de plusieurs convertisseurs en parallèle, ni d'effectuer une connexion directe de l'entrée avec la sortie du convertisseur (Bypass).

The electrical commissioning should only be carried out by qualified personnel, who are also responsible for the provision of a suitable ground connection and a protected power supply feeder in accordance with the local and national regulations. The motor must be protected against overloads.

La mise en service électrique doit être effectuée par un personnel qualifié. Ce dernier est responsable de l'existence d'une connexion de terre adéquate et d'une protection des câbles d'alimentation selon les prescriptions locales et nationales. Le moteur doit être protégé contre la surcharge.

If the Drives have been stored for longer than two years, the operation of the DC link capacitors may be impaired and must be "reformed". Before commissioning devices that have been stored for long periods, connect them to a power supply for two hours with no load connected in order to regenerate the capacitors, (the input voltage has to be applied without enabling the drive).

En cas de stockage des variateurs pendant plus de deux ans, il est conseillé de contrôler l'état des condensateurs CC avant d'en effectuer le branchement. Avant la mise en service des appareils, ayant été stockés pendant long temps, il faut alimenter variateurs à vide pendant deux heures, pour régénérer les condensateurs : appliquer une tension d'alimentation sans actionner le variateur.

7.1 Power section

7.1.1 Cable cross-sections

Size	Terminals: L1 - L2 - L3 - BR - C1 - C - D - U - V - W						
	Maximum cable cross-section (flexible conductor)		Minimum cable cross-section (flexible conductor)		Recommended stripping	Recommended terminal	Tightening torque (min)
	(mm ²)	AWG	(mm ²)	AWG	(mm)	(mm)	(Nm)
2075	6	8	0.2	24	10	None / pin	0.7 ... 0.8
2110	6	8	0.2	24	10	None / pin	0.7 ... 0.8
3150	16	6	0.75	18	14	None / pin	1.7 ... 1.8
3185	16	6	0.75	18	14	None / pin	1.7 ... 1.8
3220	16	6	0.75	18	14	None / pin	1.7 ... 1.8
Terminals: L1 - L2 - L3 - BR1 - BR2 - C - D - U - V - W							
4300/4301	35	2	0.5	20	18	None / pin	2.4 ... 4.5
4370/4371	35	2	0.5	20	18	None / pin	2.4 ... 4.5
4450/4451	35	2	0.5	20	18	None / pin	2.4 ... 4.5
5550	95 (BR1/BR2=50)	4/0 (BR1/BR2=1/0)	10	4/0	23 (BR1/BR2=27)	None / pin	14 (BR1/BR2=10)
5750	95	4/0	10	4/0	23	None / pin	14

Note!

The power terminal strip is extractable on sizes 2075 ... 3220. The EM terminal strip is extractable on all mechanical sizes.

Size	Terminals: BR1 - BR2						
	Maximum cable cross-section (flexible conductor)		Minimum cable cross-section (flexible conductor)		Recommended stripping	Recommended terminal	Tightening torque (min)
	(mm ²)	AWG	(mm ²)	AWG	(mm)	(mm)	(Nm)
5S550 / 5S750	25	2	10	10	19	None	4.5

Sizes	Terminals: L1 - L2 - L3 - C - D - U - V - W				
	Cable cross-section		Lock screw diameter	Recommended terminal	Tightening torque (min)
	(mm ²)	AWG	(mm)	(mm)	(Nm)
5S550 / 5S750	50	1/0	M10	Eyelet - Fork	25

Size	Terminals: $\frac{1}{2}$ on structural work				
	Cable cross-section		Lock screw diameter	Recommended terminal	Tightening torque (min)
	(mm ²)	AWG	(mm)	(mm)	(Nm)
3220	Same as the maximum cross-section used for the power terminal strip		M5	Eyelet - Fork	6
4300/4301	16	6	M6	Eyelet - Fork	10
4370/4371	16	6	M6	Eyelet - Fork	10
4450/4451	16	6	M6	Eyelet - Fork	10
5550	50	1/0	M6	Eyelet - Fork	10
5750	50	1/0	M6	Eyelet - Fork	10
5S550 / 5S750	50	1/0	M10	Eyelet - Fork	25

Note!

The power terminal strip is extractable on sizes 2055 ... 3110.

Note!

The minimum cross-section for both ground connections must comply with EN61800-5-1 prescriptions. Always ground both points on structural steel.

7.1.2 Connection of shielding (recommended)

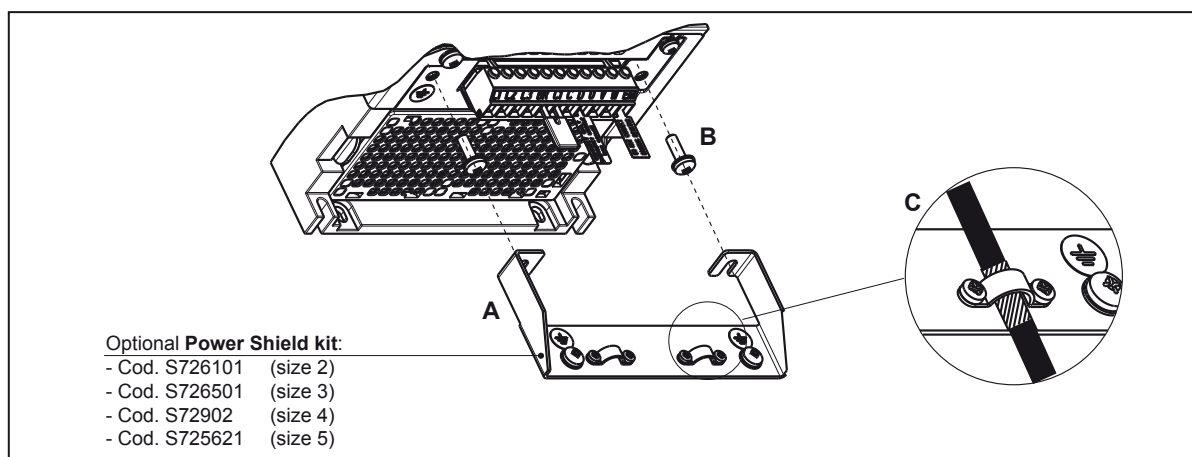

Loosen the two screws (B), put the metal support (A) (optional, POWER SHIELD KIT) in place and screw down tightly. Fasten the power cable shield to the omega sections (C) as illustrated in the figure.

- Sizes 5S550 and 5S750 : for these sizes the metal support (A) is not provided. Cable shielding must be provided by the installer.

7.1.3 EMC guide line



Warning!

In a domestic environment, this product may cause radio interference, in which case supplementary mitigation measures may be required.

Dans un environnement domestique, ce produit peut causer des interférences radio, auquel cas des mesures d'atténuation supplémentaire peuvent être nécessaires.



Attention

The converters are protected in order to be used in industrial environments where, for immunity purposes, large amounts of electromagnetic interference can occur. Proper installation practices will ensure safe and trouble-free operation. If you encounter problems, follow the guidelines which follow.

- Check for all equipment in the cabinet are well grounded using short, thick grounding cable connected to a common star point or busbar. Better solution is to use a conductive mounting plane and use that as EMC ground reference plane.
- Flat conductors, for EMC grounding, are better than other type because they have lower impedance at higher frequencies.
- Make sure that any control equipment (such as a PLC) connected to the inverter is connected to the same EMC ground or star point as the inverter via a short thick link.
- Connect the return ground from the motors controlled by the drives directly to the ground connection (\perp) on the associated inverter.
- Separate the control cables from the power cables as much as possible, using separate trunking, if necessary at 90° to each other.
- Whenever possible, use screened leads for the connections to the control circuitry
- Ensure that the contactors in the cubicle are suppressed, either with R-C suppressors for AC contactors or 'flywheel' diodes for DC contactors fitted to the coils. Varistor suppressors are also effective. This is important when the contactors are controlled from the inverter relay.
- Use screened or armored cables for the motor connections and ground the screen at both ends using the cable clamps.
- Use power shield kit to connect shield of motor cable to drive.

Note!

For further information regarding electro-magnetic compatibility standards, according to Directive 2014/30/EU, conformity checks carried out on WEG appliances, connection of filters and mains inductors, shielding of cables, ground connections, etc., consult the "Electro-magnetic compatibility guide" (1S5E84) you can download from www.weg.net.

7.1.4 Block diagram of power section

This type is equipped with an EMI input filter (models ADP200-...-F-...), an AC/DC converter, a system for pre-loading DC capacitors, a DC/AC converter, a power supply unit and an integrated braking unit (except ADP200-5750 size, see below).

A specific external resistor must be connected to perform the braking function.

The connection of the external braking resistor depends on the drive size:

- (1) connect the resistor between terminals C and BR
- (2) (3) connect the resistor between terminals BR1 and BR2.
- (4) an optional external BUy braking unit can be used and connected to terminals C and D. Refer to the BUy hand-book for further information.

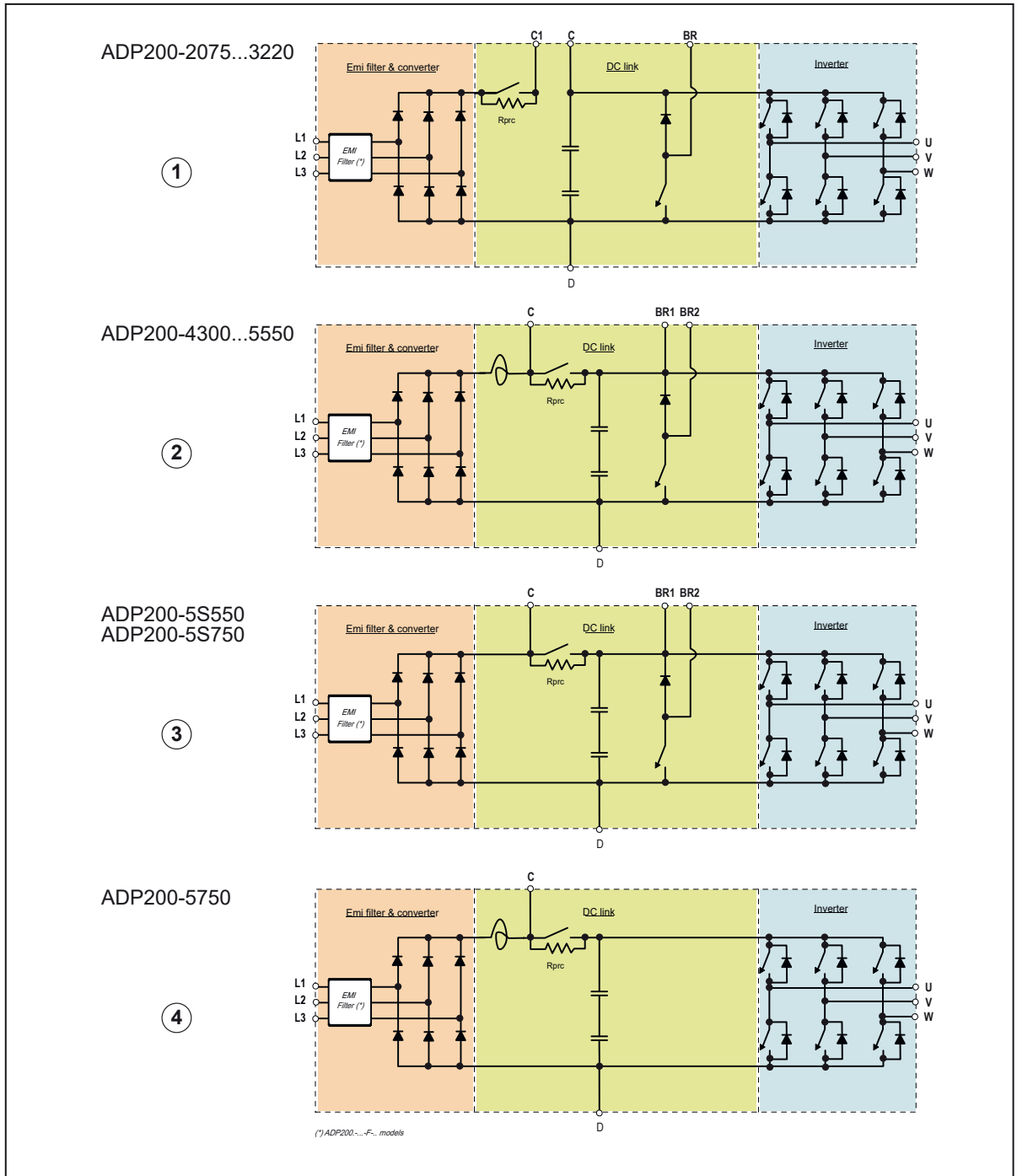

7.1.5 Internal EMC filter (standard)

In compliance with EN61800-3. Conducted emission C2 up to 11kW and C3 with "F" configuration. (External filter available for standard version, no filter inside).

7.1.6 Power line connection

ADP200-2075...5750 sizes

Power terminals are directly accessible by the user.

ADP200-5S550 and 5S750 sizes

To access power terminals:

- loosen the screws (1) and (2) using a Phillips screwdriver and remove plastic rivet (3);
- remove cover (A) and shield (B).

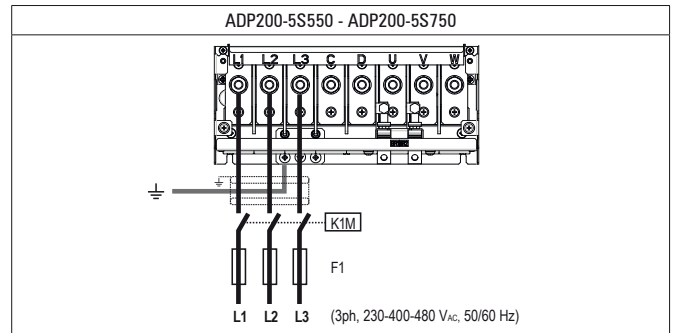
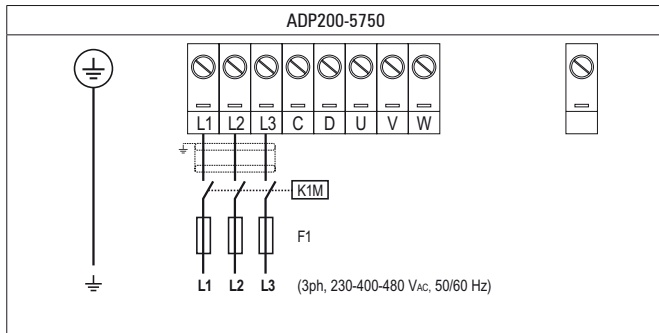
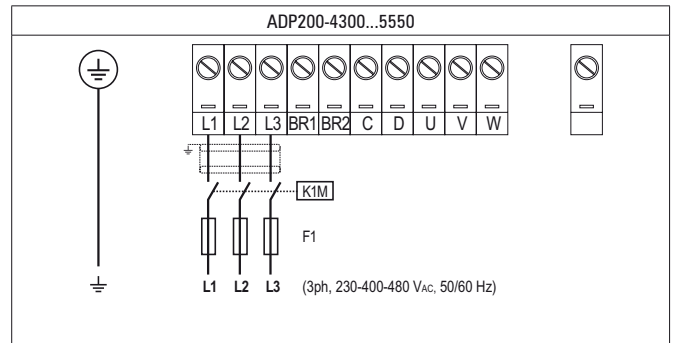
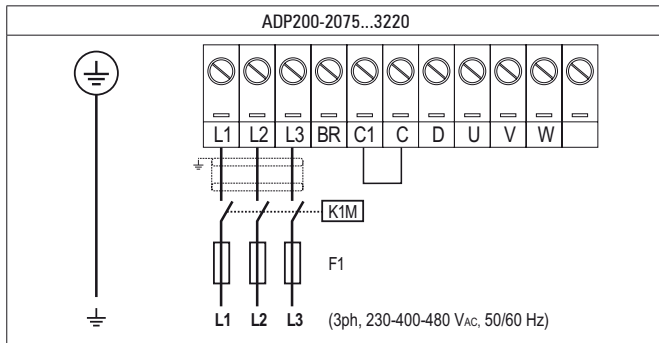
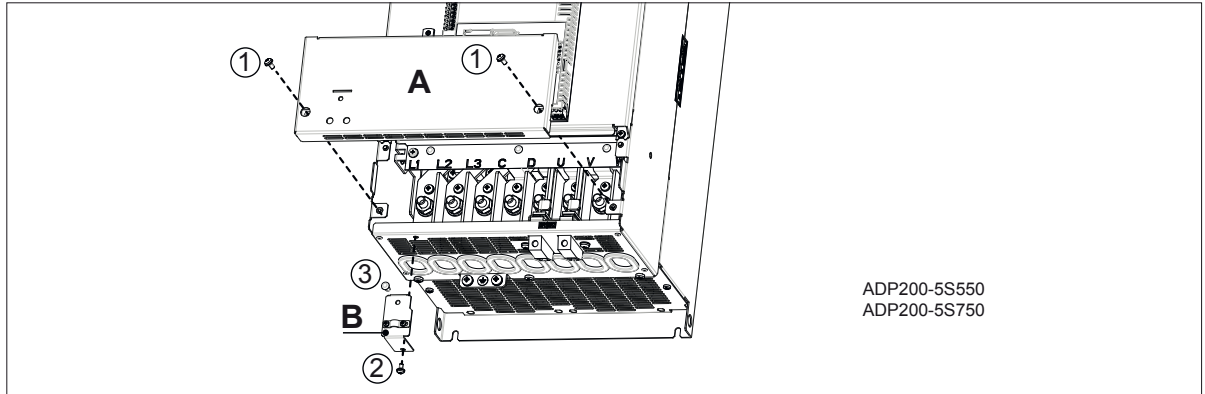

Note!

Recommended combination F1 fuses: [see paragraph 5.1.1.](#)

7.1.7 Connection of AC and DC chokes

Size	AC-Choke	DC-Choke
2075	Optional (*) <i>(*) Mandatory if Pcc line exceeds the values on chapter "5.2.1 AC input chokes".</i>	Optional With DC choke, input THD = < 35% Without DC choke, input THD = > 70%
2110		
3150		
3185		
3220		
4300/4301		
4370/4371	Not necessary	Integrated
4450/4451		
5550		
5750		
5S550	Mandatory	Not integrated and not connectable (no terminals)
5S750		

The drive can use both a three-phase choke on the AC power line and, for 7.5 to 22 kW drives only, a DC choke between terminals C1 and C.

Refer to [chapter 5.2](#) for the recommended chokes.



Attention

.....
If no DC choke is used, terminals C1 and C must be bridged (sizes 2 and 3).
.....

7.1.7.1 Connection of AC choke

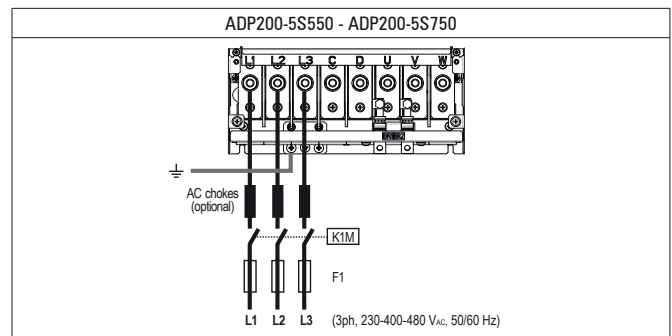
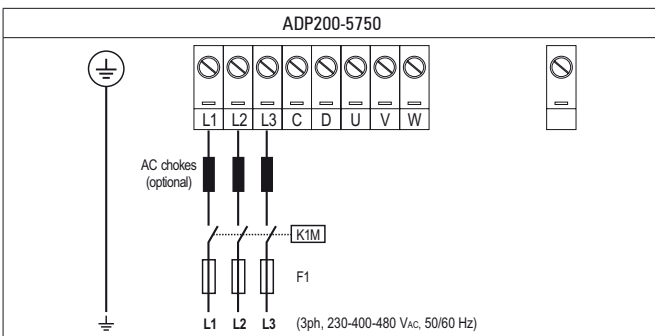
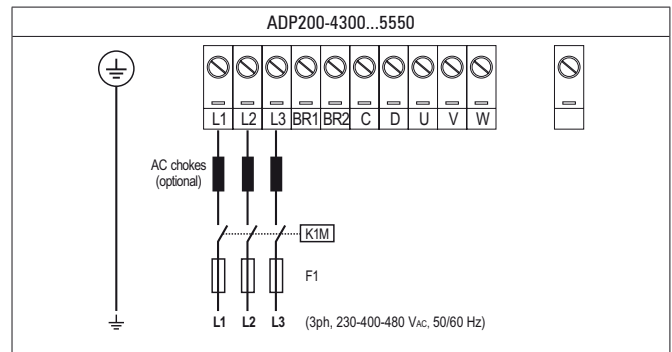
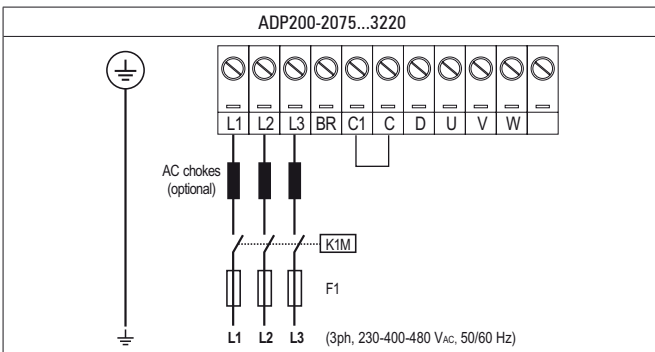

7.1.7.2 Connection of DC choke

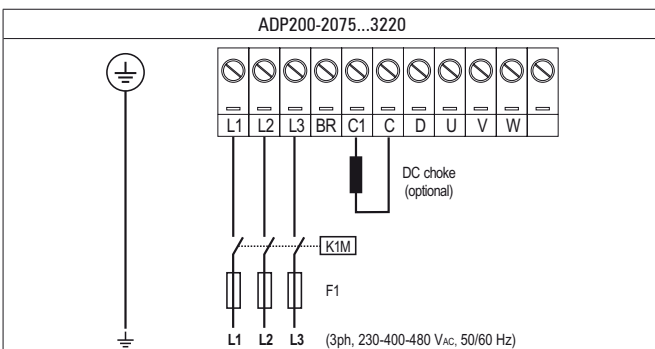

7.1.8 Motor connection

To access power terminals see chapter 7.1.6.

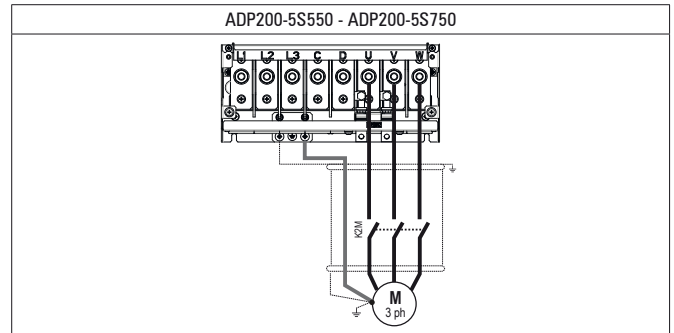
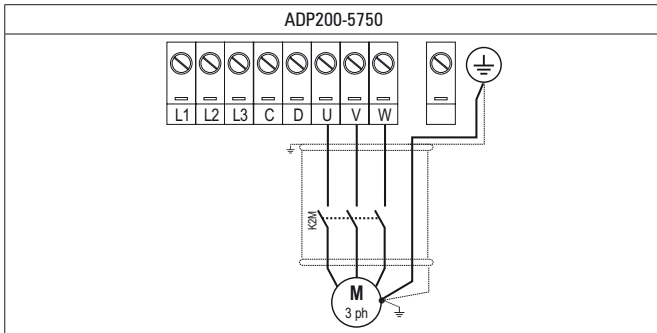
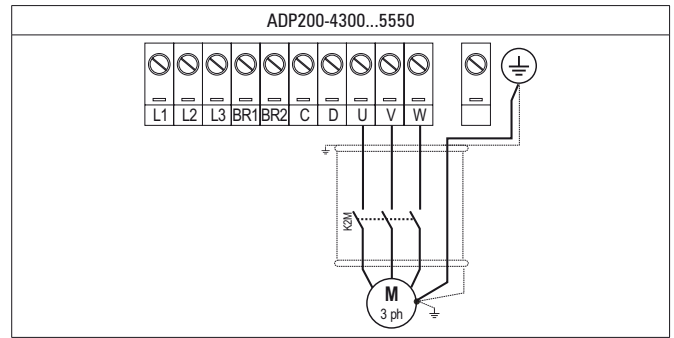
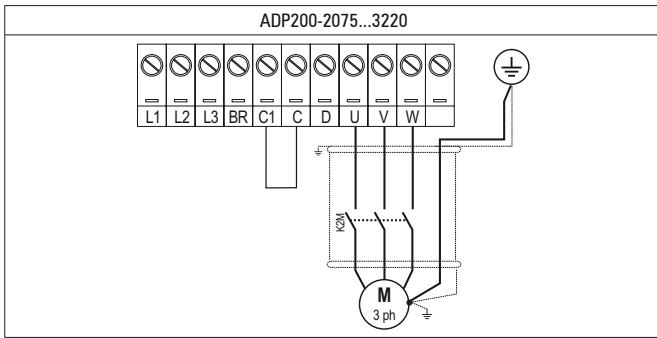

7.1.9 Connection of braking resistor (optional)

To access power terminals see chapter 7.1.6.

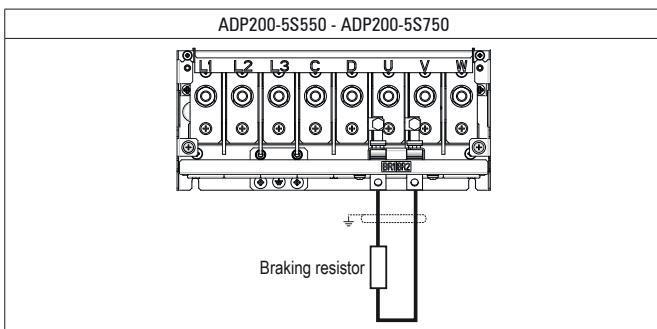
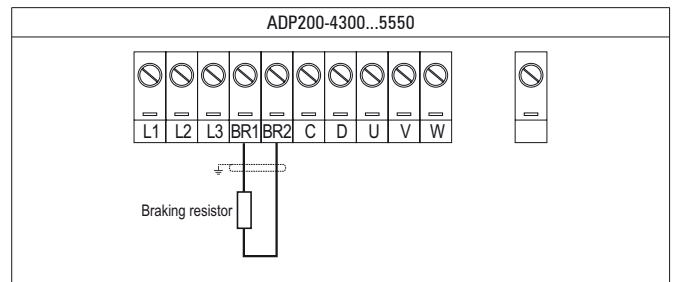
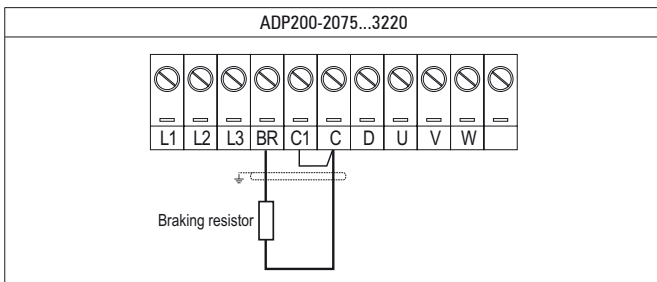

Note!

Recommended combination braking resistors: [see paragraph 5.4.](#)

For size 5750 an optional external BUy braking unit can be used and connected to terminals C and D. Refer to the BUy handbook for further information.

7.2 Regulation section

Figure 7.2.1: Identification of cards and terminals

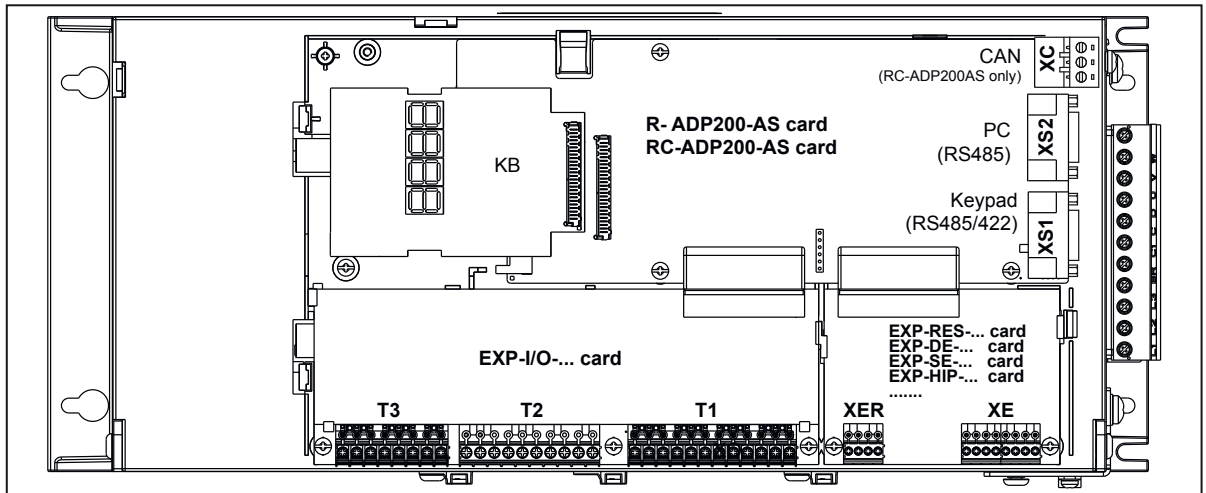

7.2.1 Cable cross-sections

Terminals	Maximum cable cross-section		Recommended stripping (mm)	Tightening torque (min) (Nm)
	(mm ²)	(AWG)		
T3, T2, T1, XC	0,2 ... 2.5 (1 cable) 0,2 ... 0.75 (2 cables)	26 ... 12 26 ... 19	5	0.4
XER*, XE*	0,2 ... 1.5 (1 cable) 0,2 ... 0.5 (2 cables)	26 ... 16 26 ... 19	5	0.25

* Suggested Cable: shielded couples plus a total external shield.

7.2.3 Feedback Connection

This section describes the feedback connections for the standard ADP200-...-RS series.
For optional cards see section A3 of the Appendix.



Caution!

.....
The names of the terminals and of the relative connection differs for the various card versions.
.....

For more information see [section A3 of the Appendix](#).
.....

Note!

.....
All terminal boards are extractable.
.....

Figure 7.2.4: Connection of shielding (recommended)

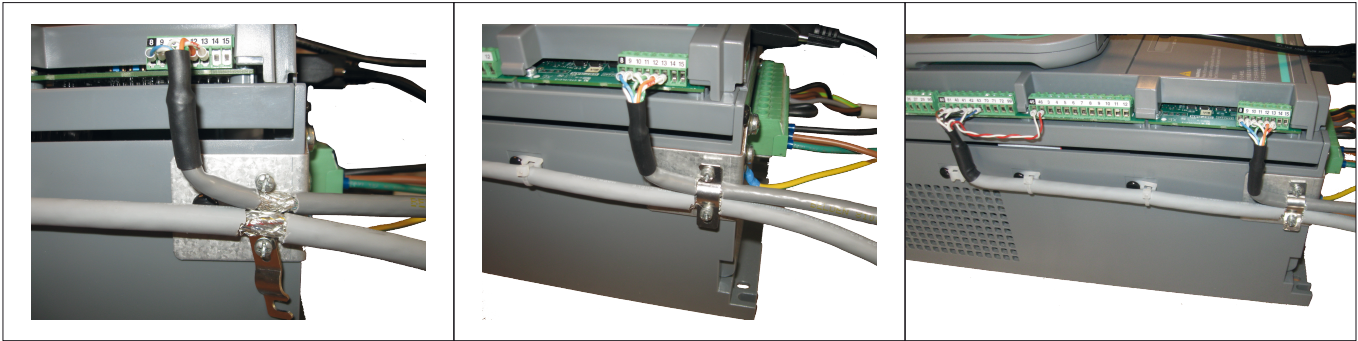

- **Connection resolver encoder**

For technical specification see the section "[A.3.3 Encoder cards](#)".

EXP-RES-I1-ADP
(Screw terminals)

XE

EXC	EXC	COS	COS	SIN	SIN		
-	+	-	+	-	+		
8	9	10	11	12	13	14	15

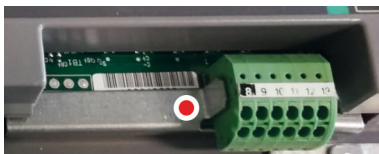

Metal guide for terminal insertion

EXP-RES-I1-S-ADP
(Spring-cage terminals)

XE

EXC	EXC	COS	COS	SIN	SIN
-	+	-	+	-	+
8	9	10	11	12	13

RESOLVER ENCODER (RES)

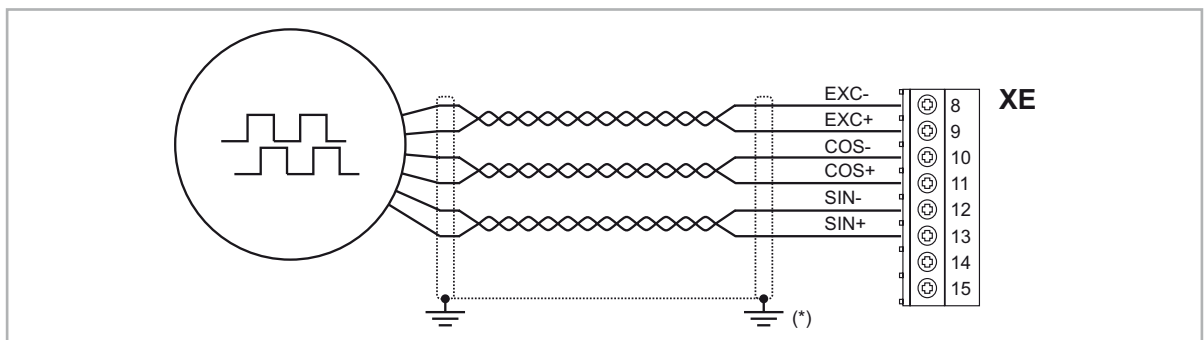

(*) Connection of shielding, see figure 7.2.4

7.3 Connection diagrams

Note!

This chapter describes the typical wiring diagrams with reference to ADP200 drives with standard configuration.

7.3.1 Regulation potentials, digital I/O

Figure 7.3.1.1: Regulation potentials (ADP200)

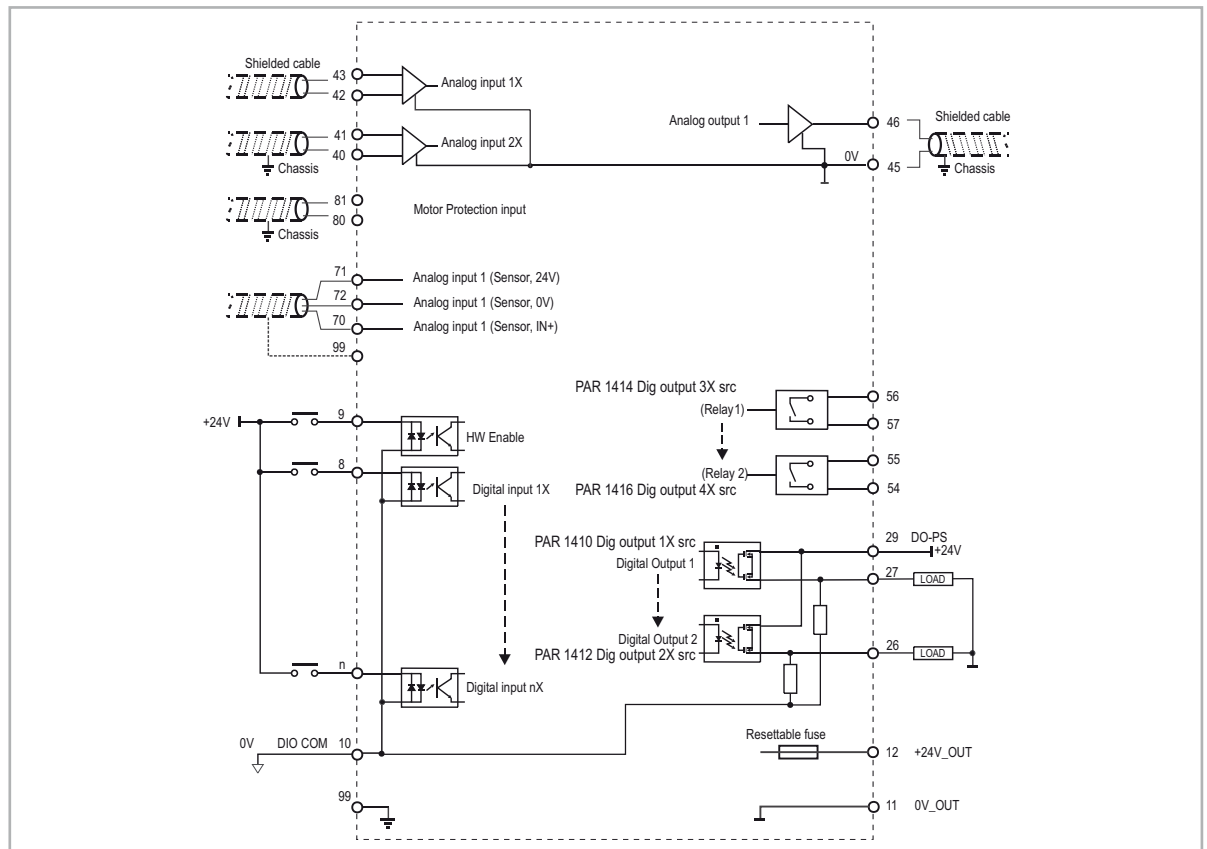

Figure 7.3.1.2: +24V internal - IO sink mode (PNP)

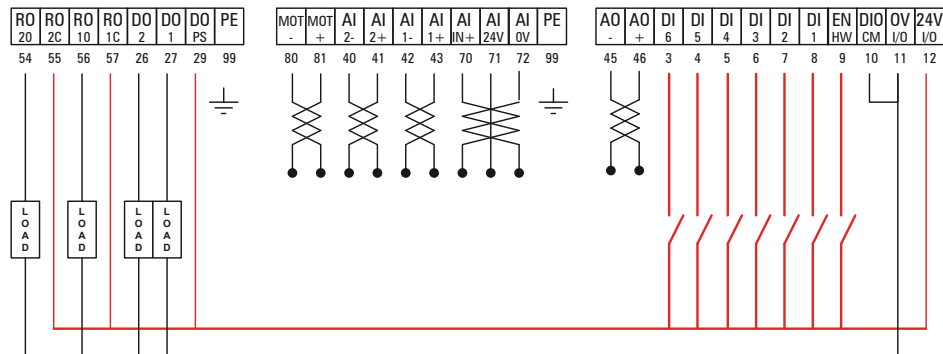

Figure 7.3.1.3: +24V internal - IO source mode (NPN)

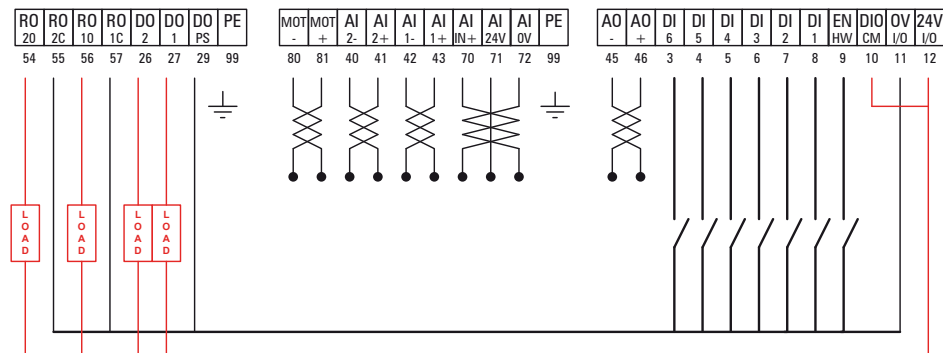

Figure 7.3.1.4: +24V external - IO sink mode (PNP)

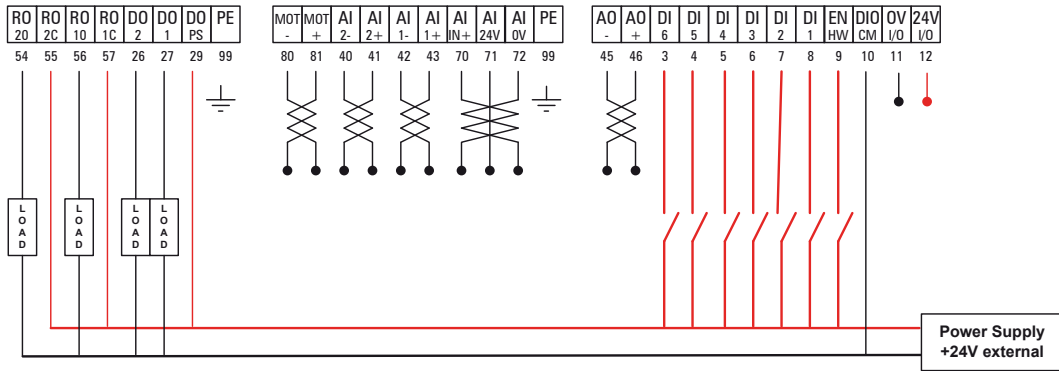

Figure 7.3.1.5: +24V external - IO source mode (NPN)

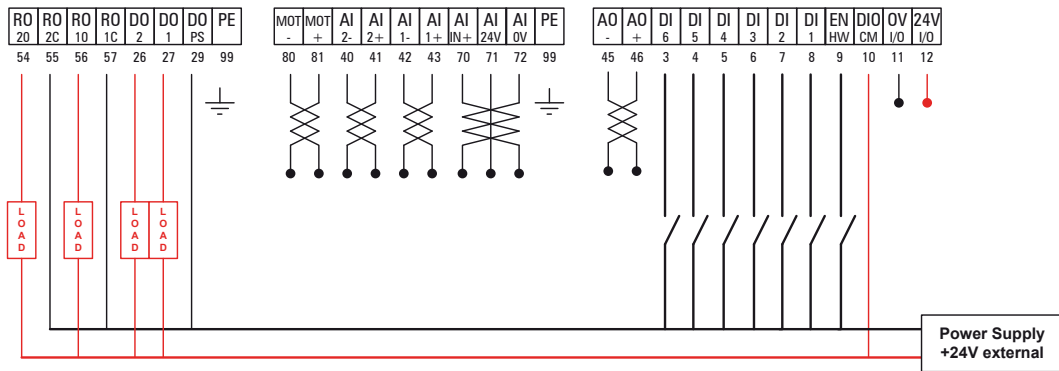
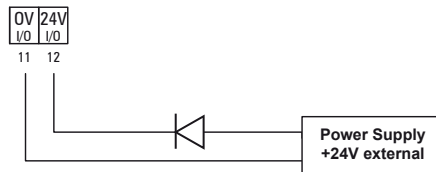
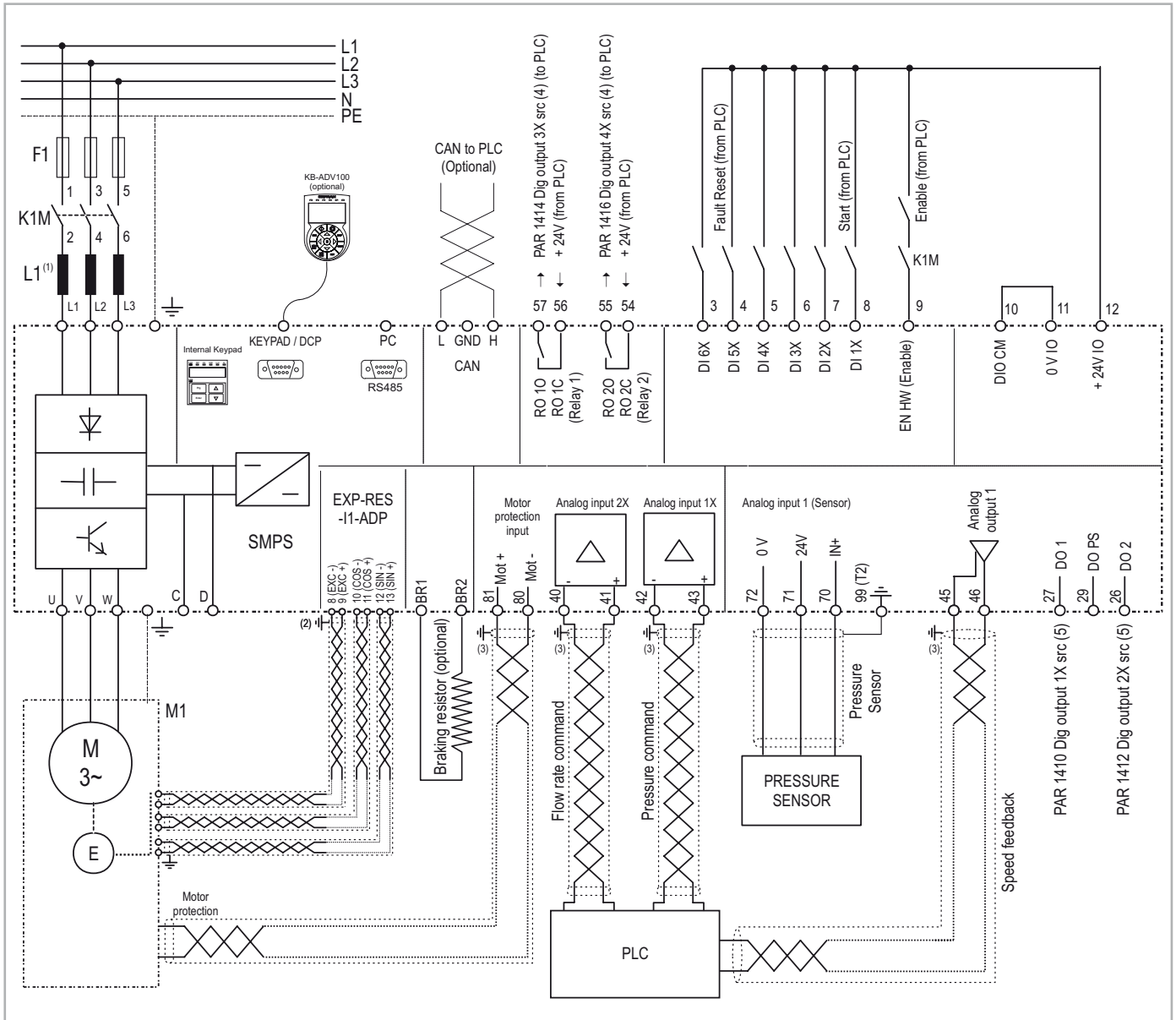

Figure 7.3.1.6: External diode on +24V external



7.3.2 Typical connection diagram

Figure 7.3.2.1: Typical connection diagram (ADP200-4300 ...5550 sizes)



- (1) ADP200-4300... 5750: Integrated choke on DC link (not integrated on ADP200-5S... models).
- (2) Connect resolver shield directly to chassis as shown on fig. 7.2.4.
- (3) Connect the shields of Motor protection, Analog Input 1/2X and Analog Output signals directly to chassis (or to terminal 99 of T3 strip) as shown on figure 7.2.4.
- (4) Default value = PAR 6000 Null (meaning: open contact).
- (5) Default value = PAR 6000 Null (meaning: 0V for digital outputs).

7.4 Serial interface (PC connector)

PIN	Function	I/O	Elect. Interface
1	-	-	-
2	-	-	-
3	A	I/O	RS485
4	EQP	-	RS485
5	0V (Ground)	-	Supply
6	+5V	-	Supply
7	B	I/O	RS485
8	0V (Ground)	-	Supply
9	DIR	0	RS485

O = Output, I/O = Input/ Output

The ADP200 drive is provided with a port as standard (9-pin D-SUB receptacle connector) for connection of the RS485 serial line used for drive-PC point-to-point or multipoint communication (with the WEG_eXpress configuration software).

Note!

The port is **not galvanically isolated**. The **OPT-RS485-ADP** option must be used if galvanic separation is required.

7.4.1 Drive/RS485 port point-to-point connection

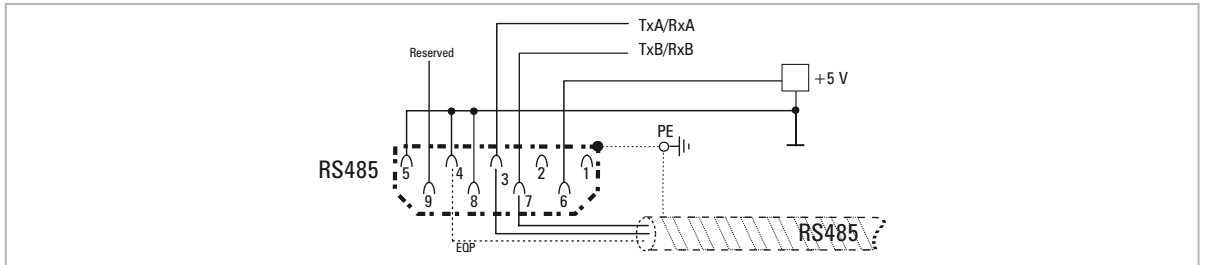

Figure 7.5.1: Serial connection (not isolated)

A twin-pair consisting of two symmetrical conductors, spiral wound with a common shield plus the bonding connection cable, connected as shown in the figure, must be used for connection. The transmission speed is 38.4 kBaud.

For connection of the RS485 serial line to the PC, see the figure below.

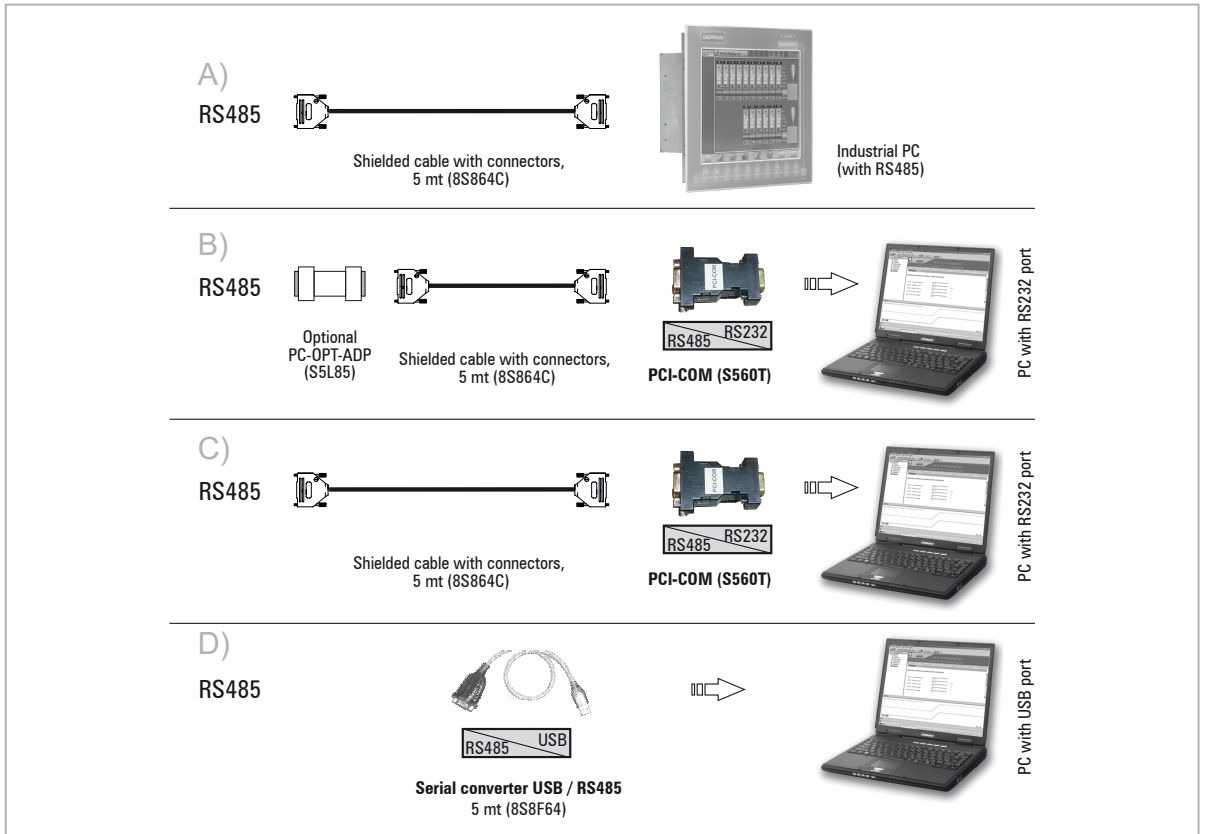

Figure 7.5.2: RS485 connection to the PC

A) Connection of an industrial PC with RS485

The following are required for connection:

- shielded cable for the **RS485 / RS485** connection (see figure 7.4.2), code 8S864C.

B) Connection to a PC with RS232 port and OPT-RS485-ADP option (isolated, for point to point and multidrop)

The following are required for connection:

- optional **OPT-RS485-ADP** card (for galvanic isolation), code S5L85
- an optional **PCI-COM** adapter, code S560T
- a shielded cable (code 8S864C) for connection to the RS485 port of the drive to the RS232 connector of the PC, see figure 7.4.2.

C) Connection to a PC with RS232 port (not isolated)

The following are required for connection:

- an optional **PCI-COM** adapter, code S560T
- a shielded cable (code 8S864C) for connection to the RS485 port of the drive to the RS232 connector of the PC, see figure 7.4.2.

D) Connection to a PC with USB port (not isolated)

The following is required for connection: optional adapter **USB/ RS485**, code 8S8F64, see figure 7.4.2 .

7.4.2 Drive / RS485 port point-to-point connection (isolated)

To make the connection with galvanic isolation, the **OPT-RS485-ADP** optional card is required.

The card is equipped with a 9-pin D-SUB male receptacle connector which must be inserted in the **RS485** connector of the ADP200 drive.

Connect **P1** side to RS485 connector of ADP200, and **J1** side to the PC serial line, the adapters indicated in paragraph 7.4.1 must be used.

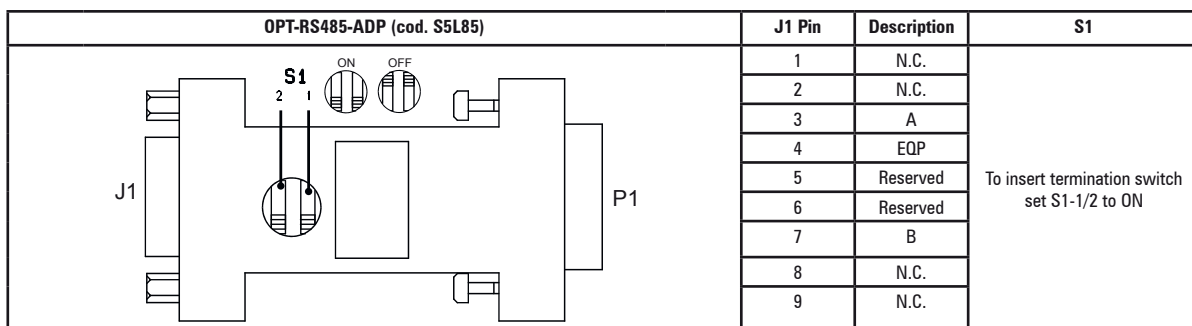
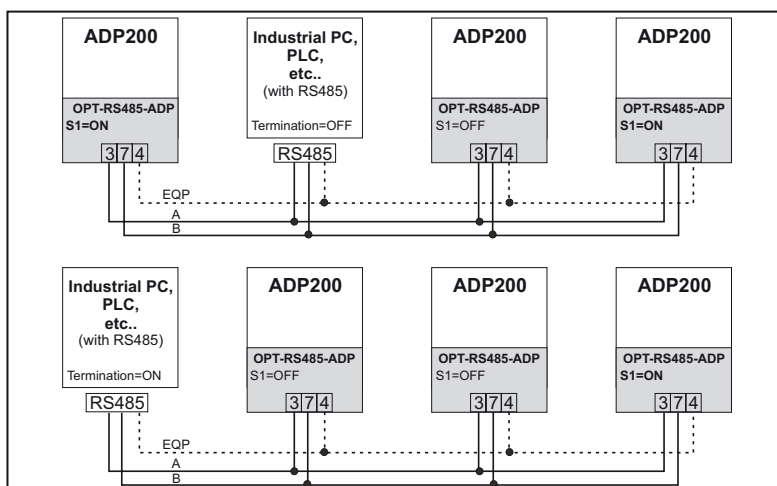

Figure 7.4.3: OPT-RS485-ADP card

7.4.3 RS 485 multi-drop connection

For the multi-drop connection, the **OPT-RS485-ADP** optional card must be installed on each drive; the ends of the connection must have **S1** termination switch set to ON. The multi-drop connection is always galvanically insulated.

Up to 20 drives can be connected; the maximum length of the connection is 200 meters.



7.5 CAN interface

CANopen is a communication profile for CAL-based industrial systems (refer to the CANopen CAL-Base COMMUNICATION PROFILE for Industrial Systems; CiA 301 CANopen application layer and communication profile Version: 4.2.0 21 February 2011").

The ADP200 can be requested with the interface for connection to CAN networks at the time of ordering (ADP200-...-C models). The CAN protocol (ISO 11898) used is CAN2.0A with 11-bit identifier. The integrated CANopen interface has been developed as a Minimum Capability Device. Data are exchanged cyclically; the master reads the data made available by the slaves and writes the reference data to the slaves.

The interface is provided with functional isolation (> 1 kV).

Connection is via the CAN (XC) connector and no power supply is required.

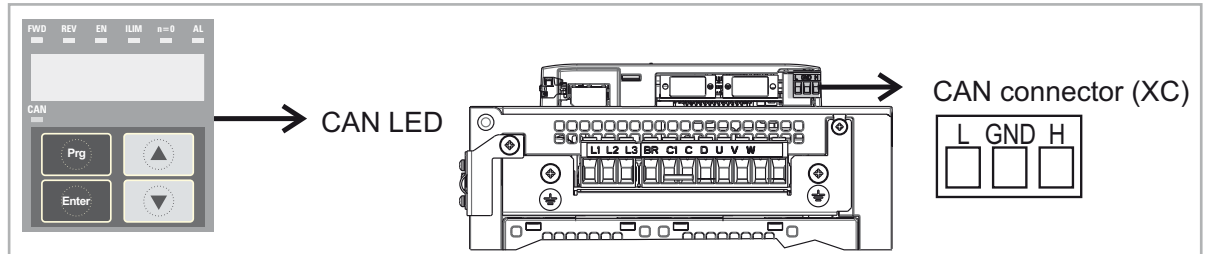

Terminal	Name	Function	Cable cross-section
L	CAN_L	CAN_L bus line (low dominant)	0.2 ... 2.5 mm ² AWG 26 ... 12
GND	CAN_GND	Ground / OV / V-	
H	CAN_H	CAN_H bus line (high dominant)	

LEDs	Meaning
CAN (green)	
Off	Stop
Flashing	Pre-operational
On	Operational

A shielded twin-pair (of the type described in the CANopen specifications) must be used for connection to the bus, and must be laid separately from the power cables, at a distance of at least 20 cm. Cable shielding must be grounded at the two ends. If the cable shielding is grounded at different points of the system, use equipotential connection cables to reduce the current flow between the drive and the CANbus master.

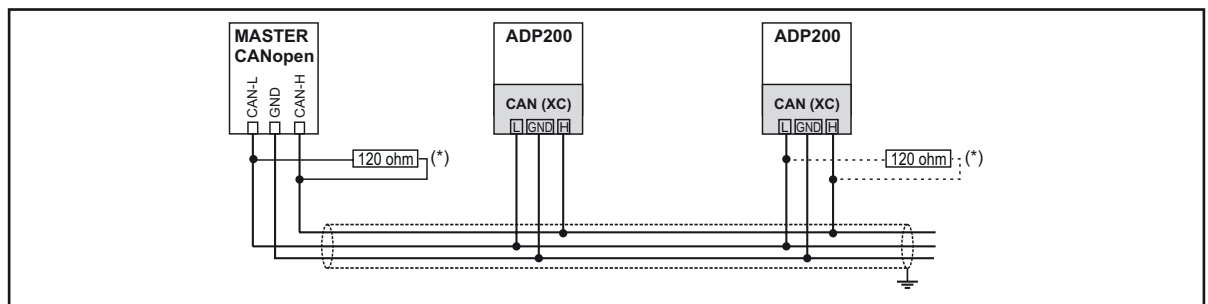

Figure 7.5.1: CANbus connection

Note!

(*) As regards terminations: the first and last termination on the network must have a 120 ohm resistor between pins L and H.

Termination on RC-ADP200A and RC-ADP200AS control card

As an alternative to an external resistance, the termination can be inserted by using jumper P3 (present only on models ADP200-...-C).

With the jumper ON, the termination is inserted; with the jumper OFF, the termination is not inserted.

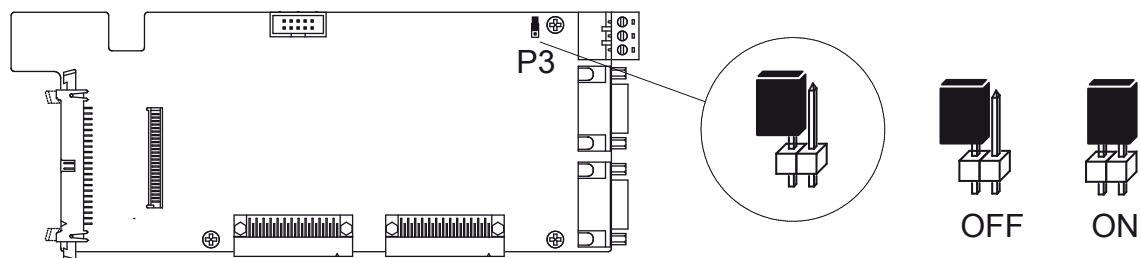
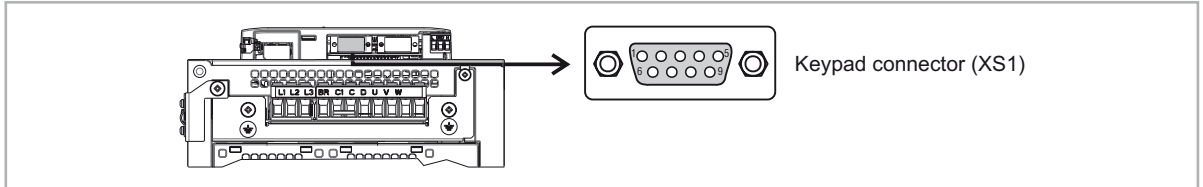

Figure 7.5.2: Termination on RC-ADP200A and RC-ADP200AS regulation card

7.6 Optional Keypad interface (keypad connector)



Several devices can be connected to the multifunction keypad connector (9-pin D-SUB female receptacle connector XS1) and are automatically recognised and managed.

- The keypad is supplied with a 40 cm-long cable, for longer distances, a 1:1 non-crossover cable must be used (9 shielded cables, e.g. code 8S864C, length 4.5 m or 8S874C, length 10 m).
- Very long cables (max. 15 m) must be of good quality with low voltage loss (max. 0.3 ohm/m).



Caution

.....
The connections have no galvanic isolation!
.....

7.7 Saving data on the Memory Card

With the ADP200 drive, data can be saved on a normal Secure Digital-type memory card. In order to use the memory card, the specific adapter (SD-ADL) must be connected by inserting it into the dedicated slot on the front of the drive. For further information, see chapter 8.9.

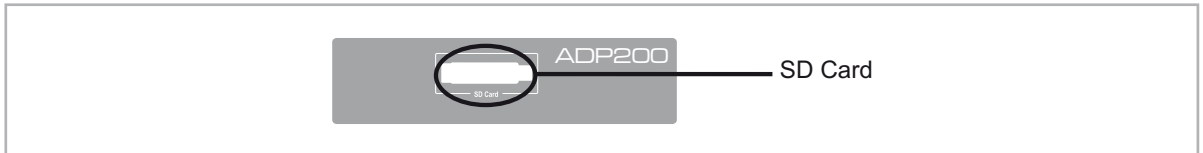

7.8 Braking

There are various possible types of braking:

- Internal Braking Unit
- Injection of direct current from the Inverter into the motor (D.C. braking)

There are two essential differences between the two braking methods:

- A braking unit can be used for speed reduction (e.g.: from 1000 to 800 rpm), whereas D.C. braking can only be used for braking to standstill.
- The energy in the drive is converted into heat in both cases. This conversion takes place in a braking resistor encased in the braking unit. With D.C. braking, the energy is converted into heat in the motor itself, resulting in a further rise in motor temperature.

7.8.1 Braking unit (internal)

Frequency-regulated motors during the deceleration behave as generators, recovering energy that flows through the inverter bridge, in the intermediate circuit as continuous current.

This leads to an increase in the intermediate circuit voltage.

Braking units (BU) are therefore used in order to prevent the DC voltage rising to an impermissible value. When used, these activate a braking resistor that is connected in parallel to the capacitors of the intermediate circuit. The feedback energy is converted to heat via the braking resistor (R_{BR}), thus providing very short deceleration times and restricted four-quadrant operation.

In the standard configuration, ADP200 drives ($\leq 55\text{kW}$) comprise an internal braking unit.

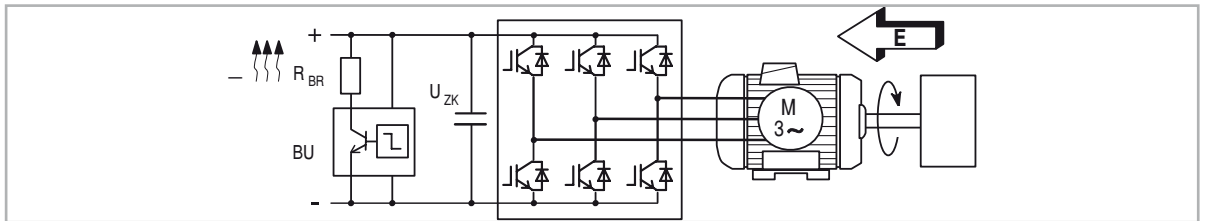

Figure 7.8.1: Operation with braking unit (circuit diagram)

Note!

When the internal braking unit is present the protection must consist of fast-acting fuses! Follow the relative assembly instructions.

A twisted cable must be used for the connection of the braking resistor (terminals BR and C or BR1 and BR2). If the resistor includes a thermal protection device (Klixon), this must be connected to the "External fault" input of the drive.

Table 7.8.1: Technical data of the internal braking unit

Size	I_{RMS} (A)	I_{PK} (A)	R_{BR} (Ω)
2075	8.5	12	68
2110	15.5	22	36
3150	22	31	26
3185	26.3	37.2	18
3220	26.3	37.2	18
4300/4301	47	67	12
4370/4371	47	67	12
4450/4451	57	80	10
5550 5S550 5S750	71	100	8

I_{RMS} Braking unit rated current, duty cycle = 50%

I_{PK} Peak current that can be delivered for max 60 seconds

R_{BR} Minimum braking resistance value

Table 7.8.2: Braking unit intervention threshold

V_{BR} @ 480 V		V_{BR} @ 460 V		V_{BR} @ 400 V	
ON	OFF	ON	OFF	ON	OFF
800 Vdc	790 Vdc	768 Vdc	758 Vdc	670 Vdc	660 Vdc

Note!

For the combination of recommended braking resistors [refer to chapter 5.4](#).

8 - Use of the keypad

This chapter describes the integrated keypad and the optional KB-ADV100 keypad and methods of use for displaying and programming inverter parameters.

8.1 Description of keypads

8.1.1 KB-ADP200 integrated keypad

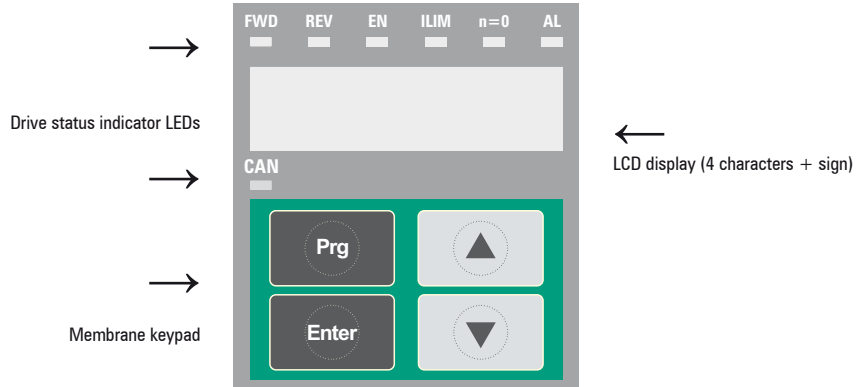

The integrated programming keypad is used to display status and diagnostics parameters during operation.

8.1.1.1 Membrane keypad

This section describes the keys on the membrane keypad and their functions

Symbol	Reference	Description
Prg		Returns to the higher level menu or submenu. Exits a parameter, and a list of parameters. It can be used to exit an error or alarm message.
Enter	Enter	Enters the submenu or selected parameter, or selects an operation. It is used when modifying parameters to confirm the new value that has been set.
▲	Up	Moves the selection up in a menu or list of parameters. During modification of a parameter, increases the value of the blinking digit.
▼	Down	Moves the selection down in a menu or list of parameters. During modification of a parameter, decreases the value of the blinking digit.

8.1.1.2 Meaning of LEDs

There are 7 drive status indicator LEDs on the front of the ADP200 drive.

LEDs	Colour	Meaning of LEDs
FWD	Yellow	Motor is rotating in forward direction
REV	Yellow	Motor is rotating in reverse direction
EN	Green	The LED is lit during IGBT modulation (drive operating)
ILIM	Red	When this LED is lit the drive has reached a current limit condition. During normal functioning, this LED is off.
N=0	Yellow	The LED is lit when motor speed is 0.
AL	Red	The LED is lit when the drive signals that an alarm has been triggered
CAN	Green	The LED is only present in types ADP200.-...C. LED flashes = pre-operational. LED stays on = operational. LED off = Stop.

8.1.2 KB-ADV100 optional programming keypad

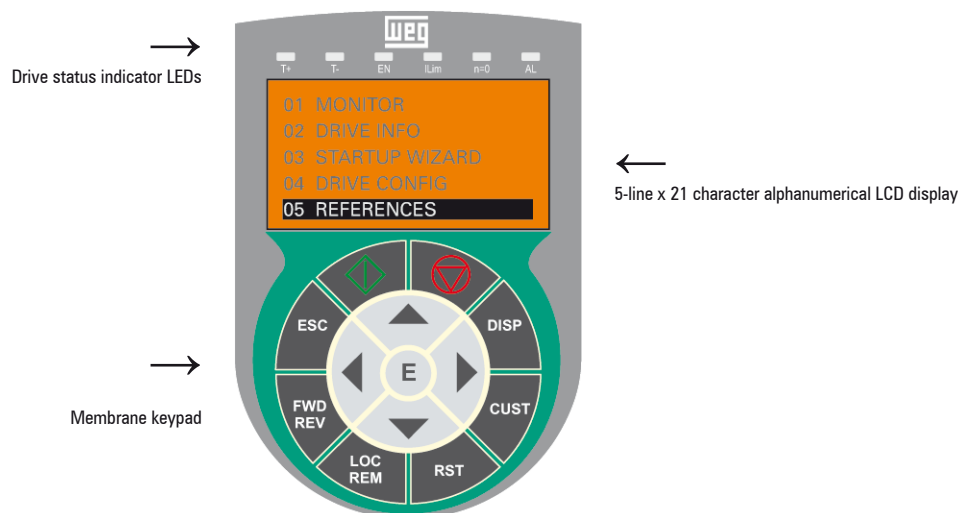

The optional programming keypad is used to display the status and diagnostics parameters during operation. It has a strip of magnetic material on the back so that it can be attached to the front of the drive or other metal surface (e.g. door of the electrical panel). The keypad can be used remotely from distances of up to 15 m. A 70 cm-long connection cable is supplied as standard. Up to 5 sets of parameters can be saved using the KB-ADV100 keypad and sent to other drives.

8.1.2.1 Membrane keypad

This section describes the keys on the membrane keypad and their functions

Symbol	Reference	Description
	Start	Starts the motor
	Stop	Stops the motor
ESC	Escape	Returns to the higher level menu or submenu. Exits a parameter, a list of parameters, the list of the last 10 parameters. Can be used to exit a message that requires use of this.
FWD REV	Forward/Reverse	Reverses the direction of rotation of the motor
LOC REM	Local/Remote	Changes the method of use from local to remote and vice versa. Is active only if the drive is not enabled.
RST	Reset	Resets alarms, only if the causes have been eliminated.
CUST	Custom	Displays the last 10 parameters that have been modified. To exit these functions, press the ◀ key.
DISP	Display	Displays a list of drive functioning parameters.
E	Enter	Enters the submenu or selected parameter, or selects an operation. It is used when modifying parameters to confirm the new value that has been set.
▲	Up	Moves the selection up in a menu or list of parameters. During modification of a parameter, increases the value of the digit under the cursor.
▼	Down	Moves the selection down in a menu or list of parameters. During modification of a parameter, decreases the value of the digit under the cursor.
◀	Left	Returns to the higher level menu. During modification of a parameter, moves the cursor to the left.
▶	Right	Accesses the submenu or parameter selected. During modification of a parameter, moves the cursor to the right.

8.1.2.2 Meaning of LEDs

LEDs	Colour	Meaning of LEDs
T+	Yellow	the LED is lit, when the drive operates with a positive torque
T-	Yellow	the LED is lit, when the drive operates with a negative torque
EN	Green	The LED is lit during IGBT modulation (drive operating)
ILIM	Red	When this LED is lit the drive has reached a current limit condition. During normal functioning, this LED is off.
N=0	Yellow	The LED is lit when motor speed is 0.
AL	Red	The LED is lit when the drive signals that an alarm has been triggered

8.2 Navigating with the integrated keypad

8.2.1 Scanning of first and second level menus

First level

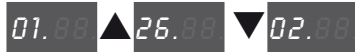

First level menus are shown by 2 digits.

First level

Second level



Second level menus are shown by 4 digits separated by a point.
The first two indicate the first level, the second two the second level.

The numbering of the menus is that displayed on the standard keypad.
Use the up and down arrow keys to scroll the menu.
Press **Enter** to open a menu item.
Press **Prg** to go back.

Note !

.....
This example is only visible in Expert mode.
.....

8.2.2 Display

• List of parameters (IPA)

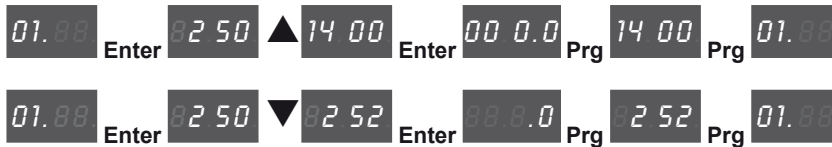

When you access a list of parameters from the menu, the first value to be displayed is the parameter's IPA.

Scroll the list using the arrow keys.
Press **Enter** to display the value of the parameter.
Press **Prg** to return to the menu.

Note !

.....
For IPAs > 9999 (therefore, the application) the integrated display shows a point at the bottom right to indicate that the parameters are 10000 + the number displayed. In this way, the user can distinguish among parameters when navigating on menus with parameters mixed among the application and FW.
.....

• Display using "windows"

With the optional keypad, numbers of up to 10 digits plus the sign can be displayed.

With the integrated keypad only 4 digits plus the sign are displayed.

The four digits are considered as a window on the complete number, which can alternately display the four least significant digits, the four intermediate digits or the 2 most significant digits.

The active window is always shown by a flashing point, in a different position:

> **Bottom window:** indicated by the flashing point of the second digit from the right:

		Top		Middle				Bottom					
Window	>>>									7	8	9	0
Complete number	>>>			1	2	3	4	5	6	7	8	9	0

> **Middle window:** indicated by the flashing point of the second digit from the left:

		Top		Middle				Bottom					
Window	>>>			3	4	5	6						
Complete number	>>>			1	2	3	4	5	6	7	8	9	0

> **Top window:** indicated by the flashing point of the first digit from the left:

		Top		Middle				Bottom					
Window	>>>		1	2									
Complete number	>>>		1	2	3	4	5	6	7	8	9	0	

Note !

Flashing points and characters in grey.

E.g.:

Synchronous list, Menu 19.6 - FUNCTIONS / PADS, PAR 3726 Pad 14 = **122102** :

22.98 Enter ▲ (x5) 22.10. Enter 37 00 ▼ (x5) 37 08 Enter

The point flashes, the bottom window is displayed

27 0.2 ▲

The point flashes, the middle window is displayed

88.12 ▲

The point flashes, the top window is displayed

88.21

• **Float numbers**

In float numbers the decimal part is always in the bottom window and the middle window displays the decimal point in the first digit on the right.

> **Bottom window:** decimal part. Only the decimal values defined in the parameter configuration are displayed

		Top	Middle	Bottom
Window	>>>			7 8
Complete number	>>>		4 5 6.	7 8

> **Middle window:** the decimal point is displayed in the first digit on the right

		Top	Middle	Bottom
Window	>>>		4 5 6.	
Complete number	>>>		4 5 6.	7 8

E.g.:

Synchronous list, Menu 16 - MOTOR DATA, PAR 2002 **Rated current** = **9.6 A** :

16.98 Enter ▼ 20 02 Enter 9.9. ▼ the flashing point of the second digit from the left displays the middle window

6.98. The point flashes, the decimal values are displayed in the bottom window

• **Displaying values**

To display the value of a parameter, for integer parameters the bottom window is shown first, while for float parameters the middle window is shown first.

Use the up and down arrow keys to change the window in display mode. The window scrolls cyclically to the right with the down arrow and to the left with the up arrow.

Binary values are read only values and the up and down keys can be used to scroll the bottom, middle and top part. The position displayed is shown by the flashing window indicator.

E.g., integer parameters:

Synchronous list, Menu 2 - DRIVE INFO, PAR 510 **Time drive power on** = 6:13 h.min

02. Enter ▼ (x10) 5 10 Enter 6.13. ▼ the flashing point of the second digit from the right displays the bottom window

E.g.. float parameters:

Synchronous list, MOTOR DATA, PAR 2002 **Rated current** = 9.6 A

16.88 Enter ▼ 20.02 Enter 09.89. the flashing point of the second digit from the left displays the middle window

E.g.. BIT parameters:

Synchronous list, Menu 1 - MONITOR, 1066 **Enable state mon** = 0

01.88 Enter ▲ (x5) 10.66 Enter 99.8.0

8.2.3 Changing values

Note !

Flashing points and characters in grey.

• **Changing integer numerical values**

Press **Enter** to access "Edit" mode.

The first digit on the right starts flashing, which means the value can be changed using the up and down arrow keys. When you press **Enter** again, the next digit on the left flashes; if the digit is the last in the window, the display moves to the next window.

Pressing **Enter** on the last digit saves the value.

Press **Enter** and hold down to save the parameter even if it is not the last digit of the parameter.

Press **Prg** to exit the "Edit" mode without saving the parameter.

E.g.:

Synchronous list, Menu 22.15 – TEMP CONTROL, PAR 3504 **Drv temp thr** (default = 45 °C)

22.88 Enter ▲ 22.15. Enter ▼ 35.04. Enter 4.5 Enter
00.4.5 Enter ▲ (x4) 00.4.9 Enter 00.4.9 Enter 00.4.9 Enter 00.4.9 Enter
00.00 Enter 00.00 Enter 00.00 Enter 00.00 Enter 00.00 Enter 10.00 Enter 00.4.9
22.88 Enter ▲ 22.15. Enter ▼ 35.04. Enter 4.5 Enter 00.4.5 Enter ▲ (x4)
00.4.9 Enter (> 2 sec) 00.4.9

• **Changing Float numerical values**

When a float parameter is selected, the integer part is displayed first with a fixed point on the right indicating that the number continues with the decimal part.

If you press **Enter** in this state, only the integer part is changed.

To modify the decimal part as well, first display the bottom window by pressing the down arrow key, then press **Enter** to modify the number from the decimal part.

Press **Prg** to exit the "Edit" mode without saving the parameter.

E.g.:

Synchronous list, Menu 6 – RAMPS, PAR 700 **Acceleration time 0** (default = 10.00 s)

06.88 Enter 7.00 Enter 10.10. Enter 00.10. ▼ 00.09. Enter (> 2 sec) 10.09. ▼ Enter
00.0.0 ▲ 01.0.0 Enter (> 2 sec) 10.0.9 ▼ 01.0.0

- **Modifying Enum values**

When you press **Enter** on an Enum value, the first digit on the right flashes.
 Use the arrow keys to scroll all the enum values of that parameter cyclically.
 Press **Enter** again to accept the value.
 Press **Prg** to reject the value and restore the previous value.

E.g.:

Synchronous list, Menu 4.15 – DRIVE CONFIG, PAR 578 **Language select** (default = [0] **English**)



- **Modifying Link values**

When you press **Enter** on a Link value, the first digit on the right flashes.
 Use the arrow keys to scroll all the links in the list associated with that parameter cyclically.
 Press **Enter** again to accept the value.
 Press **Prg** to reject the value and restore the previous value.

E.g.:

Synchronous list, Menu 13 – DIGITAL OUTPUTS, PAR 1410 **Dig output 1X src** (default = [6000] **Null**)



- **Modifying On-Off values**

Boolean values are displayed with the words On and Off.
 When you press **Enter**, the first digit on the right flashes.
 Use the up and down arrow keys to change the value cyclically from On to Off.
 Press **Enter** again to accept the value.
 Press **Prg** to reject the value and restore the previous value.

E.g.:

Synchronous list, Menu 4.14 – DRIVE CONFIG , PAR 576 **Display backlight** (default = [0] **OFF**)



8.2.4 Error messages when modifying a parameter

When accepting a value, if you hold **Enter** down or press **Enter** on the last digit, an error message may be displayed:

- RO** Read only parameter, if **Enter** is pressed on a read only parameter
- ORNG** Value outside range
- DRVE** Drive enabled, if you are trying to modify a parameter than cannot be modified with the drive enabled
- ERR** Other errors

Press **Prg** to clear the error message.

8.2.5 Displaying and closing Messages

Note !

Some messages may be displayed on the integrated keypad at start-up or during operation. The list of messages is provided in chapter "10.3 Messages" .

Sub-codes shown on the integrated keypad:



See ch. 13, Message "Opt cfg change" [OCFG], Sub-code = 0014H-20: Card removed from slot 2.



See ch. 13, Message "Autotune (phasing) [SLFP], Sub-code = 41: Incorrect Incremental encoder impulse count.

Press **Prg** to exit a message if it does not close automatically.

8.2.6 Displaying and resetting Alarms

Note !

The alarms are shown on the display of the integrated keypad with the abbreviated text shown in brackets "[XXX]" in chapter "10.1 Alarms" on page 88.

Active alarms are displayed by a flashing indicator.

Alarms that have been removed but not yet reset are fixed.

If there is more than one alarm, these can be displayed using the up and down arrow keys.

Press **Prg** to exit the alarm display mode.

To reset an alarm, press the up and down arrow keys together.

To display the sub-codes, press **Enter**:

E.g.:

PLCE Enter 00 01 Prg

Index	Error message shown on the display [on the integrated keypad]	Sub-code	Description
47	Error config plc [PLCE] 	Condition: may occur during loading of the Mdplc application The Mdplc application present on the drive is not run. 0004H-4	The application downloaded has a different Crc on DataBlock and Function table

8.2.6.1 Alarm Log

Enter menu 25 - ALARM LOG to display the list of alarms

Use the arrow keys to scroll the list with the abbreviations shown in chapter 10.1.

Press **Enter** to display the alarm code.

8.2.7 Startup wizard

Enter Menu 3 - STARTUP WIZARD to scroll the list of operations, which are abbreviated as follows:

Operations displayed on the optional keypad	Operations displayed on the integrated keypad
Set motor data?	MOT
Run autotune rot?	ROT
Run autotune still?	STIL
Set encoder param?	ENC
Run phasing rot ?	PHAr
Run phasing still ?	PHAS
Set max speed?	SdPTI
Set ramps?	rAPIP
Set application par?	PLCP
Save parameters?	SAVE
End of sequence!	END

Press **Enter** to enter the selected operation.

At this point, the list of associated parameters that must be modified as described previously is displayed.

Motor self-tuning is described below.

Press the down arrow to move on to the next operation.

Press the up arrow to return to the previous operation.

Press **Prg** to abort the STARTUP WIZARD sequence.

Note !

The STARTUP WIZARD cannot run simultaneously on the two keypads (integrated and optional).

When running on one, it cannot be accessed from the other.

Note !

For further information see chapter "9.2 Startup wizard for brushless motors (with the optional keypad)".

8.2.8 Motor self-tuning

From Startup wizard **Run Autotune still** to enable motor self-tuning.
The following warning messages are displayed at the start and end of Self-tuning:

Operations displayed on the optional keypad	Operations displayed on the integrated keypad
Close Enable input	C EN
Open Enable input	O EN

When the self-tuning procedure is executed its progress is displayed. In this phase the first digit on the right indicates the progress of the procedure by rotating the external segments of the display.

If an error occurs, the word **Er** is displayed with the error code. Press **Prg** to exit the error.

Note !

For further information see chapter "9.2 Startup wizard for brushless motors (with the optional keypad)".

8.2.9 Saving and overwriting parameters on Memory card

(Software version V2.X.0 and later)

Note:

- the files read/saved by the drive are in the \ADP200 directory
- to prevent firmware loading errors, the \ADP200 directory on the Memory card must have only one FL2 file.

You can save one or more parameter configurations or overwrite an existing configuration on the Memory card (SD-Secure Digital card).

The parameters configuration on the SD card is shown as a .dat file in the following format:
ADP_0000.dat, ADP_0001.dat,....., ADP_xxxx.dat

After you enter the save menu, use the up/down arrow keys to select the command to save a new configuration or to select an existing one to overwrite. Press Enter to confirm.

After you enter the menu, the first available command is the one to save a new configuration.

Existing configurations are identified by characters 5 to 8 of the file name (for ex. 0001, 0002, xxxx).

• **Sequence for saving one or more new configurations** (from drive to SD card)

Menu 04 CONFIG DRIVE, parameter 04.17 **Save to SD card**, PAR 596:

01.00 ▼ (x3) 04.00 Enter 550 ▲ (x2) 596 Enter ErE Enter nEy Enter

Automatic saving of new configuration (for ex. if 0000 and 0001 already exist)

0002 (x1 s) the name of the new configuration is shown for 1 sec.

done Prog to return to 596

If the procedure is re-run, the next configuration saved is 0003, etc.

• **Sequence for saving on an existing configuration** (from drive to SD card)

Menu 04 CONFIG DRIVE, parameter 04.17 **Save to SD card**, PAR 596:

Let's say configurations ADP_0000.dat, ADP_0001.dat and ADP_0002.dat are saved on the SD card and you want to overwrite configuration ADP_0002.dat.

01.00 ▼ (x3) 04.00 Enter 550 ▲ (x2) 596 Enter ErE Enter nEy Enter

Press the ▼ key until reaching the file corresponding to the configuration to overwrite

0000 ▼ (x2) 0002 Enter done Prog to return to 596

8.2.10 Loading parameters and firmware from Memory card

(software version V2.X.0 and later)

Note:

- the files read/saved by the drive are in the \ADP200 directory
- to prevent firmware loading errors, the \ADP200 directory on the Memory card must have only one FL2 file

- **Loading a parameter configuration** (from SD card to drive)

To select a parameter configuration previously saved on the memory card (SD-Secure Digital) and load it on the Drive (Menu 04 CONFIG DRIVE, parameter 04.18 **Load from SD card**, PAR 598).

Let's say you previously saved configurations ADP_0000.dat, ADP_0001.dat and ADP_0002.dat on the SD card and you want to load configuration ADP_0002.dat.

01. ▾ (x3) 04. Enter 550 ▲ (x1) 598 Enter ENT Enter

The first available .FL2 or .DAT file is displayed (we assume the firmware update file is not present in addition to the parameter configurations),

0000 ▾ (x2) 0002 Enter done Prog to return to 598

- **Loading firmware** (from SD card to drive)

To update the system firmware from memory card (SD-Secure Digital) to Drive (Menu 04 CONFIG DRIVE, parameter 04.18 **Load from SD card**, PAR 598).

Let's say you previously saved configurations ADP_0000.dat, ADP_0001.dat and ADP_0002.dat and firmware file ADP-200Syn_2_0_0_Fw_Lang_PID_IMM_1_19_37_2_A1.fl2 on the SD card.

01. ▾ (x3) 04. Enter 550 ▲ (x1) 598 Enter ENT Enter

The first available FL2 or .DAT file is displayed:

0000 ▾ until showing the message that identifies the firmware file:

FL2 Enter ENT Enter

The firmware update procedure starts, during which no messages can be displayed on the keypad until the procedure ends.

8.2.11 Correspondence table displayed character/alphabet

A	B	C	D	E	F	G	H	I	J	K	L	M	N	O	P	Q	R	S	T	U	V	W	X	Y	Z
A	B	C	D	E	F	G	H	I	J	K	L	M	N	O	P	Q	R	S	T	U	V	W	X	Y	Z

1	2	3	4	5	6	7	8	9	0
1	2	3	4	5	6	7	8	9	0

8.3 Navigating with the optional keypad

8.3.1 Scanning of the first and second level menus

First level

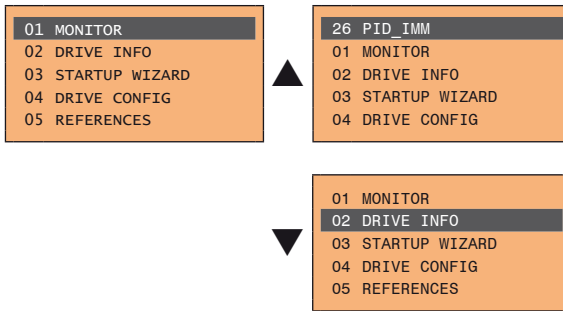

First level

Second level

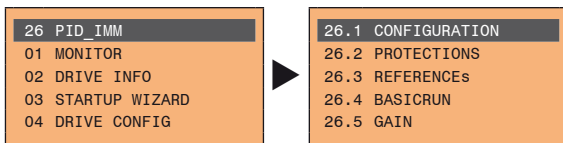

8.3.2 Display of a parameter

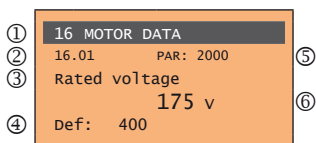

(1) Reference to the menu where the parameter is to be found (in this case menu 16 - MOTOR DATA)

(2) Position of the parameter in the menu structure (01)

(3) Description of the parameter (Rated voltage)

(4) Depends on the type of parameter:

- Numeric parameter: displays the numeric value of the parameter, in the format required, and unit of measurement.
- Binary selection: the parameter may assume only 2 states, indicated as **On - Off** or 0 - 1.
- LINK type parameter: displays the description of the parameter set from the selection list.
- ENUM type parameter: displays the description of the selection
- Command: displays the method of execution of the command

(5) Parameter number

(6) In this position, the following may be displayed:

- Numeric parameter: displays the default, minimum and maximum values of the parameter. These values are displayed in sequence pressing the ► key.
- LINK type parameter: displays the number (PAR) of the parameter set.
- ENUM type parameter: displays the numeric value corresponding to the current selection.
- Command: in the case of an error in the command, indicates that **ESC** must be pressed to terminate the command.
- Messages and error conditions:

Param read only	attempt to modify a read-only parameter
Password active	the parameter protection password is active
Drive enabled	attempt to modify a non-modifiable parameter with the drive enabled
Input value too high	the value entered too high
Input value too low	the value entered too low
Out of range	attempt to insert a value outside the min. and max. limits

8.3.3 Scanning of the parameters

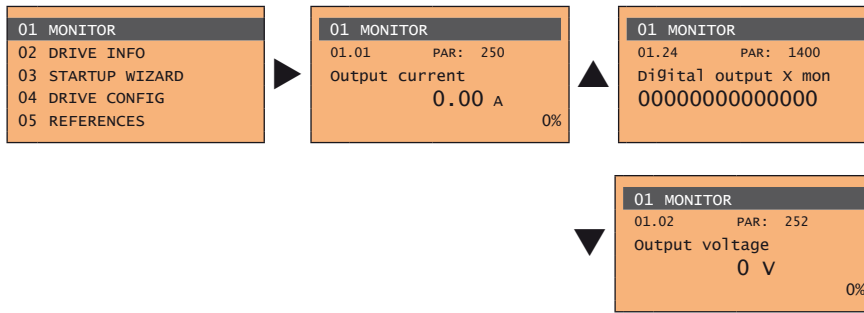

8.3.4 List of the last parameters modified

Pressing the **CUST** key, a list containing the last 10 parameters modified is accessed. One parameter is displayed at a time and the list can be scrolled using the **▲** and **▼** keys. To exit this list, press the **▶** key.

8.3.5 Parameter modification

To enter parameter modification mode, press the **E** key when the parameter to be modified is displayed. To save the value of the parameter, following modification, press the **E** key again.

Note!

To save permanently, see paragraph 8.4.

To exit modification mode without saving the value, press the **ESC** key. The operations to be carried out to modify the value depend on the type of the parameter, as described below.

Note!

For further information about the type of parameters displayed, see paragraph 8.2.2.

- **Numeric parameters**

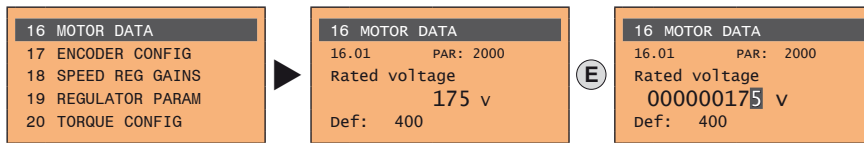

When **E** is pressed to access modification mode, the cursor is activated on the digit corresponding to the unit. Using the **◀** and **▶** keys, the cursor can be moved to all the digits, including trailing zeros that are normally not displayed. With the **▲** and **▼** keys, the digit under the cursor is increased or decreased. Press **E** to confirm the modification or **ESC** to cancel.

- **Binary parameters (BIT type)**

The parameter may assume only two states which are indicated as **On-Off** or **0-1**.

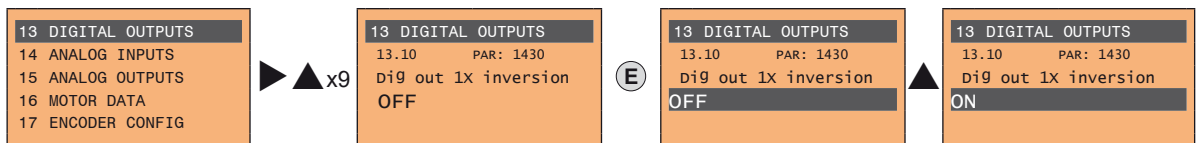

Press **E** to activate modification mode. The entire line is displayed in reverse. Use the **▲** and **▼** keys to move from one state to another. Press **E** to confirm the modification or **ESC** to cancel.

- **LINK parameters**

The parameter may assume the number of another parameter as value.

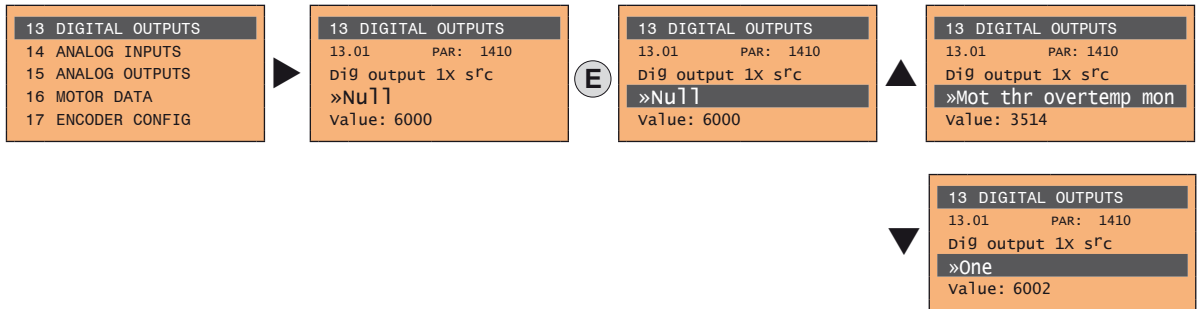

Press **E** to activate modification mode. The entire line is displayed in reverse. The elements of the list of parameters associated with this parameter can be scrolled using the **▲** and **▼** keys. Press **E** to confirm the modification or **ESC** to cancel.

- **ENUM parameters**

The parameter may assume only the values contained in a selection list.

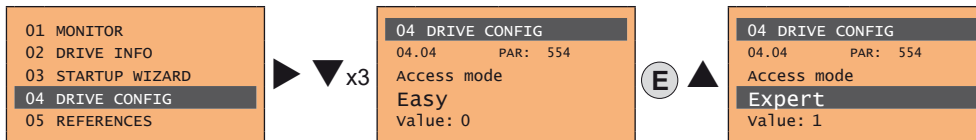

Press **E** to activate modification mode. The entire line is displayed in reverse. The elements of the selection list can be scrolled using the **▲** and **▼** keys. Press **E** to confirm the modification or **ESC** to cancel.

- **Execution of commands**

A parameter can be used to carry out a number of operations on the drive. For an example, see next paragraph: in this case the request "**Press E to execute**" is displayed.

To execute the command, press **E**. During execution of the command, the "**In progress**" caption is displayed to indicate that the operation is in course. At the end of execution, if the result is positive, the "**Done**" caption is displayed for few seconds. If execution has failed, an error message is displayed.

8.3.6 How to save parameters

To save parameters in the non-volatile memory of the drive:

Menu 04 DRIVE CONFIG, parameter 04.01 **Save parameters**, PAR : 550. This is used to save changes to parameter settings so that they are maintained even after power-off.

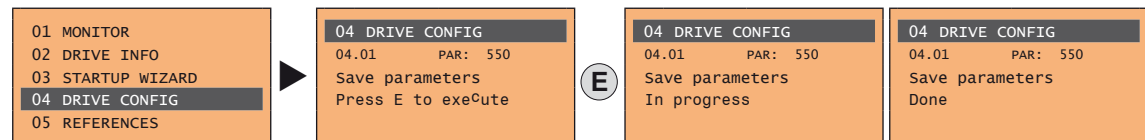

To exit, press the **◀** key.

8.3.7 Configuration of the display

8.3.7.1 Language selection

Menu 04 DRIVE CONFIG, parameter 04.15 **Language select**, PAR: 578, default=English. This is used to set one of the languages available: English, Italian, French, German, Spanish and Turkish.

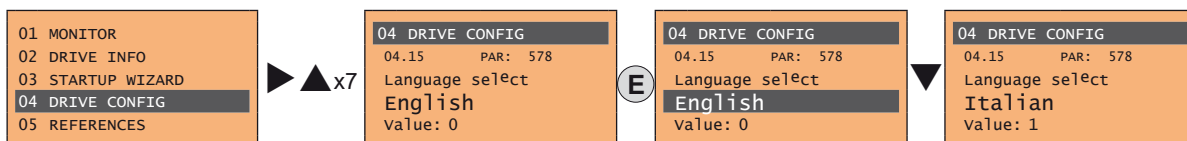

Press **E** to confirm the modification or **ESC** to cancel.

8.3.7.2 Selection of Easy/Expert mode

Menu 04 DRIVE CONFIG, parameter 04.04 **Access mode**, PAR: 554.

Enables two methods of access to be configured:

Easy (default) only the main parameters are displayed

Expert for advanced users, all the parameters are displayed

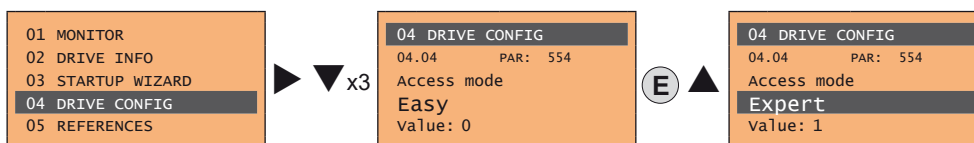

8.3.8 Startup display

Menu 04 DRIVE CONFIG, parameter 04.13 **Startup display**, PAR: 574.

This is used to set the parameter that will be displayed automatically at drive power-on.

Entering the value -1 (default), the function is disabled and the main menu is displayed at power-on.

8.3.9 Back-lighting of the display

Menu 04 DRIVE CONFIG, parameter 04.14 **Display backlight**, PAR: 576. Sets lighting of the display:

On the light of the display always stays on.

Off (default) the light switches off approx. 3 minutes after the last key is pressed.

8.3.10 Alarms

The alarms page is displayed automatically when an alarm occurs.

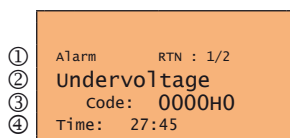

(1) **Alarm:** identifies the alarm page.

RTN: indicates that the alarm has been reset; if the alarm is still active, nothing is displayed.

x/y: **x** indicates the position of this alarm in the list of alarms and **y** the number of alarms (the alarm with lowest **x** is the most recent)

(2) Description of the alarm

(3) Sub-code of the alarm, provides other information in addition to the description

(4) Moment the alarm occurred in machine time.

The list of alarms is scrolled using the **▲** and **▼** keys.

Note!

For further information, see [chapter 10.1](#).

8.3.10.1 Alarm reset

- If the alarm page is displayed:**

Pressing the **RST** key, the alarms are reset and all alarms that have been reset are eliminated from the list. If, after this operation, the list of alarms is empty, the alarm page is closed. If the list is not empty, press the **▶** key to exit the alarms page.

- If the alarm page is not displayed:**

Press the **RST** key to reset the alarms. If active alarms are still present following reset, the alarm page is opened.

8.3.11 Messages

Operator messages are displayed with this page.

There are two types of messages:

- timed (closed automatically after a certain number of seconds),
- permanent (continue to be displayed until the operator presses the **ESC** key).

Several concurrent messages are enqueued and presented to the operator in sequence, starting from the most recent.

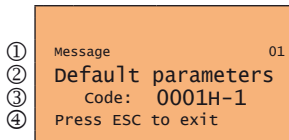

(1) **Message**: identifies a message.

xx indicates how many messages are enqueued. The queue may contain a maximum of 10 messages and the message with the highest number is the most recent.

(2) Description of the message

(3) Sub-code of the message. Provides extra information in addition to the description.

(4) **“Press ESC to exit”** is displayed if the message requires acknowledgment.

When a message is closed, the next message is displayed until the queue is empty.

Note!

For further information, see [chapter 10.3](#).

8.3.12 Saving and recovery of new parameter settings

Drive parameters can be saved on the keypad in 5 different memory areas. This function is useful for obtaining various sets of parameters, for safety backup or transferring parameters from one drive to another.

8.3.12.1 Selection of the keypad memory

Note!

This example is only visible in Expert mode.

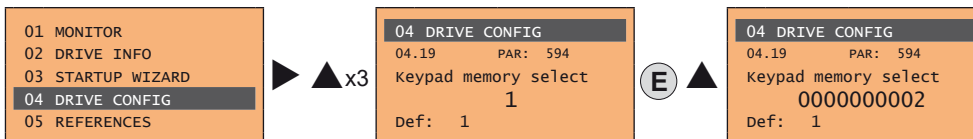

Menu 04 DRIVE CONFIG, parameter 04.19 **Keypad memory select**, PAR: 594. The keypad features 5 memory areas dedicated to saving parameters.

The memory to be used is selected using the **Keypad memory select** parameter. Subsequent saving and recovery operations will be carried out on the memory selected.

8.3.12.2 Saving of parameters on the keypad

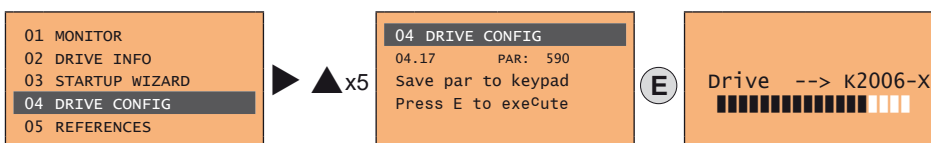

Menu 04 DRIVE CONFIG, parameter 04.17 **Save par to keypad**, PAR: 590. This is used to transfer the parameters from the drive to the selected keypad memory. To start the operation, press the **E** key.

During transfer, a bar is displayed which indicates progress of the operation.

Instead of the letter **X**, the number of the currently selected keypad memory is displayed.

At the end of transfer, if this has been completed successfully, the **“Done”** caption is displayed for a few seconds with subsequent return to the initial page.

If an error occurs during transfer, the following message is displayed:

```

Message      01
Save par failed
Code:      XX
Press ESC to exit
  
```

The code **XX** indicates the type of error, see [paragraph 10.3](#). To exit the error message, press the **ESC** key.

8.3.12.3 Load parameters from keypad

Menu 04 DRIVE CONFIG, parameter 04.18 **Load par from keypad**, PAR: 592. This is used to transfer the parameters from the selected memory of the keypad to the drive.

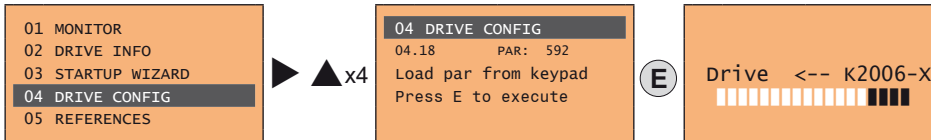

To start the operation, press the **E** key. During transfer, a bar is displayed which indicates progress of the operation. Instead of the letter **X**, the number of the currently selected keypad memory is displayed. At the end of transfer, if this has been completed successfully, the **“Done”** caption is displayed for a few seconds with subsequent return to the initial page.

If an error occurs during transfer, the following message is displayed:

```

Message      01
Load par failed
Code:      XX
Press ESC to exit
  
```

The code **XX** indicates the type of error, see [paragraph 10.3](#). To exit the error message, press the **ESC** key.

8.3.12.4 Transfer of parameters between drives

Transfer the parameters of the source drive to the keypad memory as indicated in paragraph 8.3.12.2, then connect the keypad to the drive where the new setting is to be saved and follow the procedure described in paragraph 8.3.12.3.



.....
To prevent possible damage to equipment, it is advisable to disconnect and connect the keypad with the drive off.

8.3.13 Saving and recovery of new parameter settings on memory card

To save drive parameters on the memory card (SD-Secure Digital): Menu 04 DRIVE CONFIG, parameter 04.20 **Save to SD card**, PAR 596:

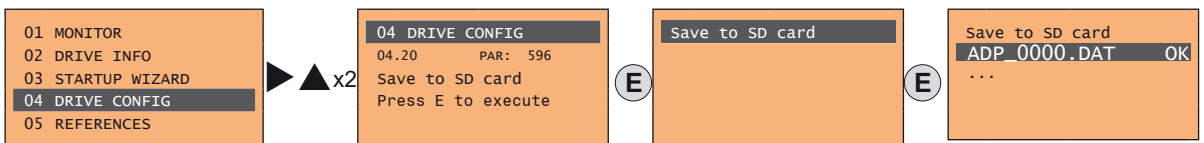

To transfer (recover) parameters from the memory card (SD-Secure Digital) to the drive: Menu 04 DRIVE CONFIG, parameter 04.21 **Load from SD card**, PAR 598:

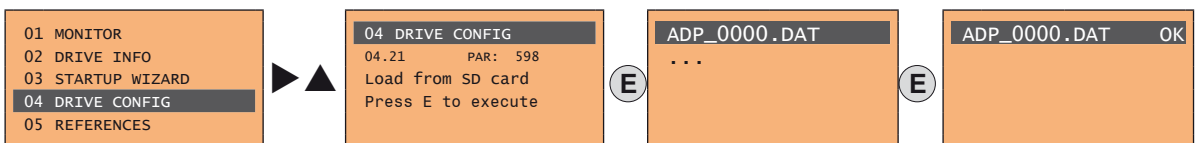

8.3.14 Loading firmware from Memory card

To update the system firmware from memory card (SD-Secure Digital) to Drive (Menu 04 CONFIG DRIVE, parameter 04.18 **Load from SD card**, PAR 598).

Let's say you previously saved configurations ADP_0000.dat, ADP_0001.dat and ADP_0002.dat and firmware file ADP-200Syn_2_0_0_Fw_Lang_PID_IMM_1_19_37_2__A1.fl2 on the SD card.

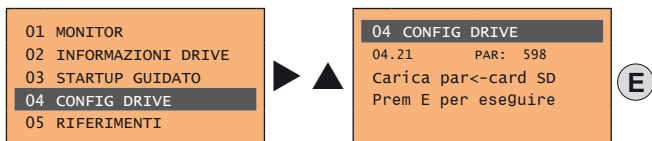

The first available FL2 or .DAT file is displayed:

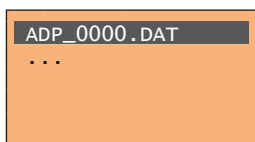

until showing the message that identifies the firmware file:

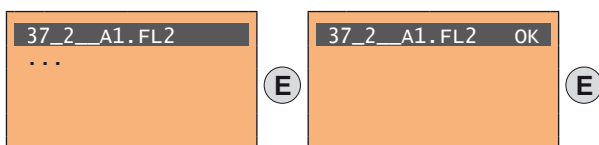

The firmware update procedure starts, during which no messages can be displayed on the keypad until the procedure ends.

9 - Commissioning via keypad



Warning!

Adjustable frequency drives are electrical apparatus for use in industrial installations. Parts of the Drives are energized during operation. The electrical installation and the opening of the equipment should therefore only be carried out by qualified personnel. Improper installation of motors or Drives may therefore cause the failure of the device as well as serious injury to persons or material damage. Drive is not equipped with motor overspeed protection logic other than that controlled by software. Follow the instructions given in this manual and observe the local and national safety regulations applicable.

Les drives à fréquence variable sont des dispositifs électriques utilisés dans des installations industriels. Une partie des drives sont sous tension pendant l'opération. L'installation électrique et l'ouverture des drives devrait être exécuté uniquement par du personnel qualifié. De mauvaises installations de moteurs ou de drives peuvent provoquer des dommages matériels ou blesser des personnes. On doit suivre les instructions données dans ce manuel et observer les règles nationales de sécurité.

Always connect the Drive to the protective ground \perp (PE) via the marked connection.

ADP200 Drives and AC Input filters have ground leakage currents greater than 3.5 mA. EN 50178 specifies that with leakage currents greater than 3.5 mA the protective conductor ground connection (\perp) must be fixed type and doubled for redundancy if its section is lower than 10mm² CU or 16mm² AL.

Il faut toujours connecter le variateur à la terre \perp (PE). Le courant de dispersion vers la terre est supérieur à 3,5 mA sur les variateurs et sur les filtres à courant alterné. Les normes EN 50178 spécifient qu'en cas de courant de dispersion vers la terre, supérieur à 3,5 mA, la mise à la terre (\perp) doit avoir une double connexion pour la redondance si sa section est inférieure à 10mm² CU ou 16mm² AL.

Only permanently-wired input power connections are allowed. This equipment must be grounded (IEC 536 Class 1, NEC and other applicable standards).

If a Residual Current-operated protective Device (RCD) is to be used, it must be an RCD type B. Machines with a three phase power supply, fitted with EMC filters, must not be connected to a supply via an ELCB (Earth Leakage Circuit-Breaker - see DIN VDE 0160, section 5.5.2 and EN 61800-5-1 section 4.3.10).

The following terminals can carry dangerous voltages even if the inverter is inoperative:

- the power supply terminals L1, L2, L3, C1, C, D.
- the motor terminals U, V, W.

This equipment must not be used as an 'emergency stop mechanism' (see EN 60204, 9.2.5.4).

Seuls des branchements électriques permanents par câble en entrée sont admis. Mettre l'appareil à la masse (IEC 536 Classe 1, NEC et autres normes applicables).

S'il s'avère nécessaire d'utiliser un dispositif protecteur de courant résiduel (RCD), il convient de choisir un RCD de type B. Les machines à alimentation triphasée et dotées de filtres EMC ne doivent pas être raccordées au bloc d'alimentation par le biais d'un disjoncteur ELCB (Earth Leakage Circuit-Breaker – cf. DIN VDE 0160, paragraphe 5.5.2 et EN50178 paragraphe 5.2.11.1).

Les bornes suivantes peuvent recevoir des tensions dangereuses, même si l'onduleur est désactivé :

- bornes d'alimentation L1, L2, L3, C1, C, D.
- bornes du moteur U, V, W.

Ne pas utiliser cet appareil en tant que « dispositif d'arrêt d'urgence » (cf. EN 60204, 9.2.5.4).

Do not touch or damage any components when handling the device. The changing of the isolation gaps or the removing of the isolation and covers is not permissible.

Manipuler l'appareil de façon à ne pas toucher ou endommager des parties. Il n'est pas permis de changer les distances d'isolement ou bien d'enlever des matériaux isolants ou des capots.

According to the EC directives the ADP200 and accessories must be used only after checking that the machine has been produced using those safety devices required by the 2006/42/EC set of rules, as far as the machine industry is concerned. These standards do not apply in the Americas, but may need to be considered in equipment being shipped to Europe.

Selon les normes EC, les drives ADP200 et leurs accessoires doivent être employés seulement après avoir vérifié que la machine ait été produit avec les mêmes dispositifs de sécurité demandés par la réglementation 2006/42/EC concernant le secteur de l'industrie. Ces standards ne s'appliquent pas sur le continent américain ; en revanche, il se peut qu'ils doivent être pris en compte pour les équipements expédiés en Europe.

ADP200 operate at high voltages.

L'ADP200 fonctionne à des tensions élevées.

Wherever faults occurring in the control equipment can lead to substantial material damage or even grievous bodily injury (i.e. potentially dangerous faults), additional external precautions must be taken or facilities provided to ensure or enforce safe operation, even when a fault occurs (e.g. independent limit switches, mechanical interlocks, etc.).

Adopter des mesures de précaution supplémentaires à l'extérieur du drive (par exemple, des interrupteurs de fin de course, des interrupteurs mécaniques, etc.) ou fournir des fonctions aptes à garantir ou à mettre en place un fonctionnement sécurisé en cas de survenue d'une panne de l'appareil de commande susceptible d'occasionner des dégâts matériels d'envergure, voire même des lésions corporelles graves (par exemple, des pannes potentiellement dangereuses).

Certain parameter settings may cause the inverter to restart automatically after an input power failure.

Certaines configurations de paramètres peuvent provoquer le redémarrage automatique de l'onduleur après une coupure de l'alimentation.

This equipment is suitable for use in a circuit capable of delivering not more than 10,000 symmetrical amperes (rms), for a maximum voltage of 480 V.

Cet appareil est conçu pour une utilisation sur un circuit d'alimentation en mesure de délivrer 10.000 ampères symétriques (rms) maximum pour une tension maximale de 480V.

Never open the device or covers while the AC Input power supply is switched on. Minimum time to wait before working on the terminals or inside the device is listed in **section 4.6**.

Ne jamais ouvrir l'appareil lorsqu'il est sous tension. Le temps minimum d'attente avant de pouvoir travailler sur les bornes ou bien à l'intérieur de l'appareil est indiqué dans la section 4.6.

Fire and Explosion Hazard:

Fires or explosions might result from mounting Drives in hazardous areas such as locations where flammable or combustible vapors or dusts are present. Drives should be installed away from hazardous areas, even if used with motors suitable for use in these locations.

Risque d'incendies et d'explosions.

L'utilisation des drives dans des zones à risques (présence de vapeurs ou de poussières inflammables), peut provoquer des incendies ou des explosions. Les drives doivent être installés loin des zones dangereuses, et équipés de moteurs appropriés.



Caution

Protect the device from impermissible environmental conditions (temperature, humidity, shock etc.).
Protéger l'appareil contre des effets extérieurs non permis (température, humidité, chocs etc.).

To the output of the drive (terminals U, V, W) :

- no voltage should be connected to the output of the drive
- the parallel connection of several drives are not permissible
- the direct connection of the inputs and outputs (bypass) are not permissible
- capacitive load (e.g. Var compensation capacitors) should not be connected.

A la sortie du convertisseur (bornes U, V et W) :

- aucune tension ne doit être appliquée
- aucune charge capacitive ne doit être connectée
- il n'est pas permis de raccorder la sortie de plusieurs convertisseurs en parallèle
- il n'est pas permis d'effectuer une connexion directe de l'entrée avec la sortie du convertisseur (Bypass).

The electrical commissioning should only be carried out by qualified personnel, who are also responsible for the provision of a suitable ground connection and a protected power supply feeder in accordance with the local and national regulations. The motor must be protected against overloads.

La mise en service électrique doit être effectuée par un personnel qualifié. Ce dernier est responsable de l'existence d'une connexion de terre adéquate et d'une protection des câbles d'alimentation selon les prescriptions locales et nationales. Le moteur doit être protégé contre la surcharge.

Do not connect power supply voltage that exceeds the standard specification voltage fluctuation permissible. If excessive voltage is applied to the Drive, damage to the internal components will result.

Ne pas raccorder de tension d'alimentation dépassant la fluctuation de tension permise par les normes. Dans le cas d'une alimentation en tension excessive, des composants internes peuvent être endommagés.

Do not operate the Drive without the ground wire connected.

The motor chassis should be grounded to earth through a ground lead separate from all other equipment ground leads to prevent noise coupling.

Ne pas faire fonctionner le drive sans prise de terre.

Le châssis du moteur doit être mis à la terre à l'aide d'un connecteur de terre séparé des autres pour éviter le couplage des perturbations.

No dielectric tests should be carried out on parts of the drive. A suitable measuring instrument (internal resistance of at least 10 kΩ/V) should be used for measuring the signal voltages.

Il ne faut pas exécuter de tests de rigidité diélectrique sur des parties du convertisseurs. Pour mesurer les tensions des signaux, il faut utiliser des instruments de mesure appropriés (résistance interne minimale 10kΩ/V).

9.1 Startup wizard for brushless motors (with the integrated keypad)

The ADP200 can operate with regulation modes: field-oriented vector control of permanent magnet synchronous motors (brushless).

Note!

Before starting, check the factory setting:

Menu 02 DRIVE INFO, parameter 02.01 **Control type**, PAR: 480, default = [25] Synchronous.

02. **Enter** 480 **Enter** 25

Menu 04 DRIVE CONFIG, parameter 04.03 **Regulation mode**, PAR: 552, default = [2] Flux vector CL.

04. **Enter** ▼x2 552 **Enter** 2

The STARTUP WIZARD is a guided procedure used for quick start-up of the drive that helps to set the main parameters.

It consists of a series of questions, relating to the various sequences for entering and calculating the parameters necessary for correct drive and PID_IMM application operation. The order of these sequences is as follows:

- | | |
|---|--------------------|
| • Electrical connections | See step 1 |
| • Motor overtemperature setting | See step 2 |
| • Setting motor parameters | See step 3 |
| • Autotune with rotating motor / at stand-still or coupled to the load | See step 4 |
| • Setting encoder parameters | See step 5 |
| • Encoder phasing (rotating or still) | See step 6 |
| • Setting speed parameters | See step 7 |
| • Motor overload setting | See step 8 |
| • Braking resistor setting | See step 9 |
| • Setting application parameters | See step 10 |
| • Analog input setting | See step 11 |
| • Saving parameters | See step 12 |

The format of the function selection page is as follows:

03. **Enter** No t

Pressing the **Enter** key, the function to be programmed is accessed.

Press the ▼ (Down) key to move to the next function skipping the current function.

Press the ▲ (Up) key to return to the previous function.

To terminate the sequence of functions and return to the menu, press the **Prg** key.

The end of the start-up sequence is indicated with:

do nE Press the **Prg** key to exit the sequence and return to the menu.

Note!

For more details on showed parameters refer to "Functions description and parameters list" ADP200FP-SYN user manual, code 1S9FPEN.

For more details on application parameters (Step 10) refer to "Pressure/Flow Control for Hybrid Injection Molding Machines" ADP200_PID-IMM user manual.

Step 1 - Electrical connections

Make the connections as described in paragraph 7.3.2.

Checks to be performed before powering the drive

- Check that the supply voltage is correct and that the input terminals on the drive (L1, L2 and L3) are connected correctly.
- Check that the output terminals on the drive (U, V and W) are connected to the motor correctly.
- Check that all the drive control circuit terminals are connected correctly. Check that all control inputs are open.
- Check the encoder connections, see section A.3 of the Appendix.

Powering the drive

- After completing all the checks described above, power the drive and proceed to step 2.

Step 4A - Self-tuning with rotating motor (Autotune rotation)

Use this procedure when the motor is not coupled or the transmission does not represent more than 5% of the load. This procedure obtains the most accurate data.

rot Enter 20 22 Enter E nt Enter do nE 00 00 ... 6 5 1 00 do nE
 (1) (2)(3) (4) (5)

- (1) Press the **Enter** key to proceed to the autotune procedure.
- (2) Press the **Enter** key to start the autotune procedure.
- (3) Enable the drive by connecting terminal 9 (Enable) to terminal 12 (+24 V). To abort this operation, press the **Prg** key.
- (4) Once the drive is enabled the autotune procedure starts. This may take a few minutes, depending on the type of motor being used.
- (5) At the end of the procedure the following screen is displayed. After opening the Enable contact, proceed to step 5. Press the **Prg** x2 and **▼** keys.

Note!

At the end of the autotune procedure there is a request to open the Enable contact (terminals 9 - 12); this results in the automatic execution of the **Take tune parameters** command (menu 16 MOTOR DATA, PAR: 2078).

The calculated parameters are saved in a RAM memory to enable the drive to perform the necessary calculations. These data are lost if the device is switched off. To save the motor data follow the procedure described in step 12.

Step 4B - Self-tuning with motor at stand-still or coupled to the load (Autotune still)

Use this procedure when the motor is **coupled to the transmission** and cannot rotate freely.

St iL Enter 20 24 Enter E nt Enter do nE 00 00 ... 6 5 1 00 do nE
 (1) (2)(3) (4) (5)

- (1) Press the **Enter** key to proceed to the autotune procedure.
- (2) Press the **Enter** key to start the autotune procedure.
- (3) Enable the drive by connecting terminal 9 (Enable) to terminal 12 (+24 V). To abort this operation, press the **Prg** key.
- (4) Once the drive is enabled the autotune procedure starts. This may take a few minutes, depending on the type of motor being used.
- (5) At the end of the procedure the following screen is displayed. After opening the Enable contact, proceed to step 5. Press the **Prg** x2 and **▼** keys x2.

Note!

At the end of the autotune procedure there is a request to open the Enable contact (terminals 9 - 12); this results in the automatic execution of the **Take tune parameters** command (menu 16 MOTOR DATA, PAR: 2078).

The calculated parameters are saved in a RAM memory to enable the drive to perform the necessary calculations. These data are lost if the device is switched off. To save the motor data follow the procedure described in step 12.

Step 5 - Setting encoder parameters (Standard card EXP-RES-I1-ADP)



The incorrect configuration of the encoder tension can permanently damage the device; therefore, it is advisable to check the values on the encoder's specification plate.

En C Enter 21 00 ▼ 21 85 ▼ 21 02 ▼ 21 16 Enter (x2) 00 01 ▲ 0002 ppr Enter (x3s) Prg
 ▼ 21 18 Enter (x2) 500.0 ▲ 5001 Hz ▼ 4999 Hz Enter (x3s)

At the end of the procedure proceed to step 7. Press the **Prg** x2 and **▼** keys.

Step 6 - Encoder phasing (Standard card EXP-RES-I1-ADP)

ADP200 drives have a command to start automatic phasing of the resolver.

Phasing must be repeated whenever:

- the drive is replaced (alternatively, download parameters taken from previous drive)
- the motor is replaced
- the encoder is replaced

Note!

For more information see parameters 17.23 PAR 2190 **Autophase rotation** and 17.24 PAR 2192 **Autophase still** on "Functions description and parameters list" manual (ADP200 Vector inverter for Hybrid injection molding machines).

See section A.3.2 Phasing in the Appendix for further information.

Step 6A - Encoder phasing with rotating motor

PH Ar Enter 21.90 Enter E nt Enter do nE 88 80 ... 86 5 o En 1 00 do nE

(1) (2) (3) (4) (5)

Step 6B - Encoder phasing with still motor

PH AS Enter 21.92 Enter E nt Enter do nE 88 80 ... 86 5 o En 1 00 do nE

(1) (2) (3) (4) (5)

- (1) Press the **Enter** key to proceed to the autotune procedure.
- (2) Press the **Enter** key to start the autotune procedure.
- (3) Enable the drive by connecting terminal 9 on the I/O card (Enable) to terminal 12 (+24 V). To abort this operation, press the **Prg** key.
- (4) Once the drive is enabled the autophase procedure starts. This may take a few minutes, depending on the type of motor being used.
- (5) At the end of the procedure the following screen is displayed. After opening the Enable contact, proceed to step 7. Press the **Prg** x2 and **▼** keys.

Step 7 - Setting the speed parameters

Setting the maximum speed reference value: this defines the maximum motor speed value (in rpm) that can be reached with each single reference signal (analog or digital).

Setting of the threshold above which the overspeed alarm Overspeed is enabled.

Sd Pn Enter 86 80 Enter (x2) 300.0 ▲ 3001 rpm
 ▼ 45 40 Enter (x2) 360.0 ▼ 2999 rpm Enter (x3s) Prg
 ▲ 3601 rpm
 ▼ 3599 rpm Enter (x3s) Prg

Proceed to the next step. Press the **Prg** and **▼** keys.

Note!

The factory (default) setting depends on the size of the drive that is connected. These values refer to the ADP200-2110-...

Step 8 - Motor overload setting

Enabling of the motor overload control, setting of the motor overload value (the value is expressed as a percentage of **Rated current** PAR 2002 * **Motor service factor** PAR 3206 and setting of the motor overload duration in seconds).

nt oL Enter 32 00 Enter (x2) 80 FF ▲ on
 ▼ 32 02 Enter (x2) 01 50 ▼ on Enter (x3s) Prg
 ▲ 151.0 %
 ▼ 149.0 % Enter (x3s) Prg

▼ 32 04 Enter (x2) 00.30 ▲ 31.0 s
▼ 29.0 s Enter (x3s) Prg

Proceed to the next step. Press the **Prg** and ▼ keys.

Step 9 – Braking resistor setting

External braking resistor: enabling of the overload control, setting of the resistance value and of the power that can be continuously dissipated.

br Enter 32 50 Enter (x2) 0F F8 ▲ on
▼ on Enter (x3s) Prg
▼ 32 52 Enter (x2) 00.49 ▲ 50.0 ohm
▼ 48.0 ohm Enter (x3s) Prg
▼ 32 54 Enter (x2) 00.01 ▲ 2.3 kW
▼ 0.3 kW Enter (x3s) Prg

Proceed to the next step. Press the **Prg** and ▼ keys.

Step 10 - Setting application parameters

For more details refer to PID-IMM Application manual.

Note !

For IPAs > 9999 (therefore, the application) the integrated display shows a point at the bottom right to indicate that the parameters are 10000 + the number displayed. In this way, the user can distinguish among parameters when navigating on menus with parameters mixed among the application and FW.

PL CP Enter 10 00 Enter (x2) 24.00 ▲ 2401
▼ 2399 Enter (x3s) Prg
▼ 10 06 Enter (x2) 01.40 ▲ 014.1
▼ 013.9 Enter (x3s) Prg
▼ 10 08 Enter (x2) 02.49 ▲ 250
▼ 248 Enter (x3s) Prg
▼ 10 14 Enter (x2) 0 FF ▲ on
▼ on Enter (x3s) Prg

Step 11 – Analog input setting

Analog inputs (integrated and from optional expansion card): selection of the type of input (voltage or current) and self-tuning command for the relative analog inputs gain.

AI n Enter 15 02 Enter (x2) 00 01 ▲ 1
▼ 2 Enter (x3s) Prg
▼ 15 06 Enter E nt Enter do nE Prg
▼ 16 02 Enter (x2) 00 01 ▲ 0
▼ 2 Enter (x3s) Prg
▼ 16 06 Enter E nt Enter do nE Prg
▼ 16 08 Enter E nt Enter do nE Prg
▼ 16 52 Enter (x2) 00 01 ▲ 0
▼ 2 Enter (x3s) Prg
▼ 16 56 Enter E nt Enter do nE Prg

▼ 16 58 Enter E nt Enter do nE Prg

Proceed to the next step. Press the **Prg** and ▼ keys.

Step 12 - Save parameters

To save the new parameter settings, so that they are maintained also after power-off, proceed as follows:

SA vE Enter 8550 Enter E nt Enter do nE Prg
(1) (2) (3) (4)

- (1) Press the **Enter** key to start the save parameters procedure.
- (2) Press **Enter** to confirm
- (3) End of procedure
- (4) When the parameters have been saved correctly the drive displays this screen to show that the startup wizard is complete.

Press the **Prg** (x3s) key.

9.2 Startup wizard for brushless motors (with the optional keypad)

The ADP200 can operate with regulation modes: field-oriented vector control of permanent magnet synchronous motors (brushless).

Note!

Before starting, check the factory setting:

Menu 02 DRIVE INFO, parameter 02.01 **Control type**, PAR: 480, default=Synchronous.

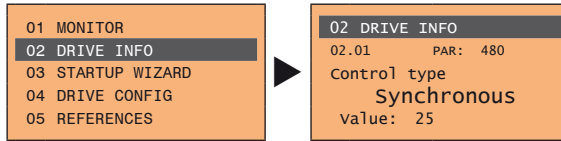

Menu 04 DRIVE CONFIG, parameter 04.03 **Regulation mode**, PAR: 552, default=Flux vector CL.

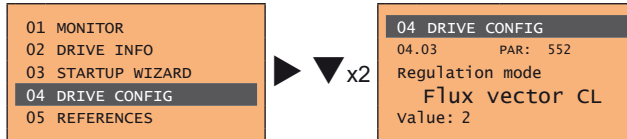

The STARTUP WIZARD is a guided procedure used for quick start-up of the drive that helps to set the main parameters.

It consists of a series of questions, relating to the various sequences for entering and calculating the parameters necessary for correct drive and PID_IMM application operation. The order of these sequences is as follows:

- | | |
|---|--------------------|
| • Electrical connections | See step 1 |
| • Motor overtemperature setting | See step 2 |
| • Setting motor parameters | See step 3 |
| • Autotune with rotating motor / at stand-still or coupled to the load | See step 4 |
| • Setting encoder parameters | See step 5 |
| • Encoder phasing (rotating or still) | See step 6 |
| • Setting speed parameters | See step 7 |
| • Motor overload setting | See step 8 |
| • Braking resistor setting | See step 9 |
| • Setting application parameters | See step 10 |
| • Analog input setting | See step 11 |
| • Saving parameters | See step 12 |

The format of the function selection page is as follows:

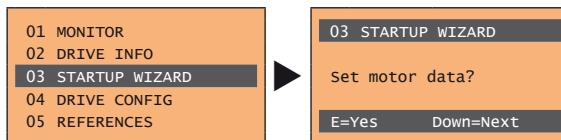

Pressing the **E** key, the function to be programmed is accessed.

Press the **▼** (Down) key to move to the next function skipping the current function.

Press the **▲** (Up) key to return to the previous function.

To terminate the sequence of functions and return to the menu, press the **ESC** key.

The end of the start-up sequence is indicated with the page:

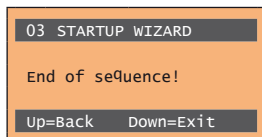

Press the **▼** (Down) key to exit the sequence and return to the menu.

Note!

For more details on showed parameters refer to "Functions description and parameters list" ADP200FP-SYN user manual, code 1S9FPEN.

For more details on application parameters (Step 10) refer to "Pressure/Flow Control for Hybrid Injection Molding Machines" ADP200_PID-IMM user manual.

Step 1 - Electrical connections

Make the connections as described in paragraph 7.3.2.

Checks to be performed before powering the drive

- Check that the supply voltage is correct and that the input terminals on the drive (L1, L2 and L3) are connected correctly.
- Check that the output terminals on the drive (U, V and W) are connected to the motor correctly.
- Check that all the drive control circuit terminals are connected correctly. Check that all control inputs are open.
- Check the encoder connections, see section A.3 of the Appendix.

Powering the drive

- After completing all the checks described above, power the drive and proceed to step 2.

Step 2 – Motor overtemperature setting

Motor OT protection management: selection of the source, threshold and sensor type setting, behaviour of the drive in case of a motor overtemperature alarm.

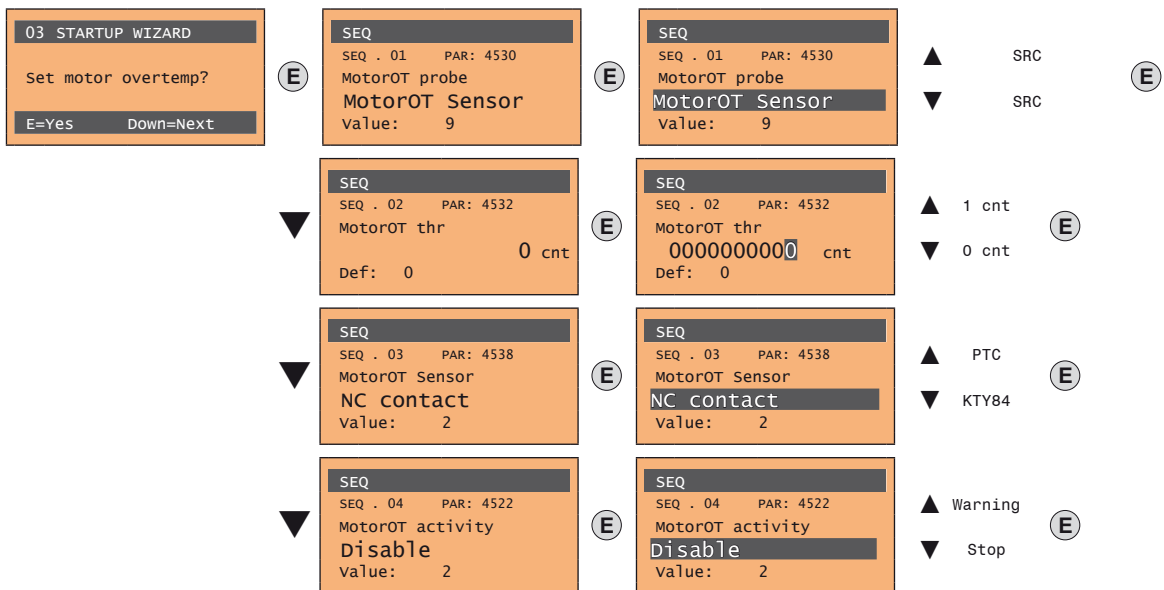

Proceed to the next step.

Step 3 - Setting motor parameters

Note!

Def: The factory (default) setting depends on the size of the drive that is connected. These values refer to the ADP200-2110-...

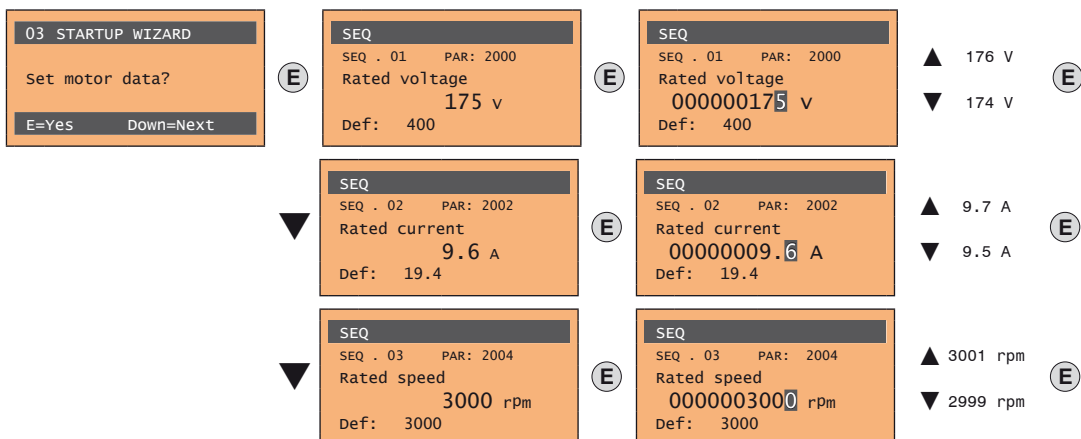

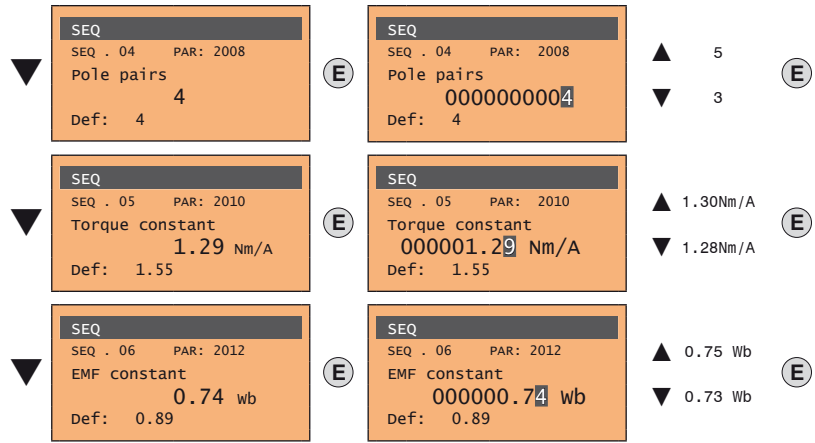

Set the plate data of the motor connected, following the instructions given on the previous pages.

- Rated voltage [V]:** the rated voltage of the motor indicated on the data plate.
- Rated current [A]:** motor rated current; approximately, the value should not be less than 0.3 times the rated current of the drive, output current class 1 @ 400 V on the data plate of the drive.
- Rated speed [rpm]:** motor rated speed; see data plate.
- Pole pairs:** Number of motor pole pairs; see data plate.
- Torque constant (KT):** (KT) Ratio between the torque generated by the motor and the current required to supply it.
- EMF constant:** (KE = KT / $\sqrt{3}$) Electromotive force constant, which represents the ratio between motor voltage and motor rated speed.

Note!

When data entry is complete the **Take parameters** command is executed automatically (menu 16 MOTOR DATA, PAR: 2020). The motor data entered during the STARTUP WIZARD procedure are saved in a RAM memory to enable the drive to perform the necessary calculations. These data are lost if the device is switched off. To save the motor data follow the procedure described in step 9.

At the end of the procedure proceed to step 4.

Step 4 - Autotune of the motor

The drive carries out the motor autotune procedure (real measurement of motor parameters). Autotuning may take a few minutes.

Note!

If this operation generates an error message (e.g. Error code 1), check the connections of the power and control circuits (see **step 1** - Connections), check the motor data settings (see **step 2** - Setting motor parameters) and then repeat the guided Autotune procedure.

Note!

Autotuning can be cancelled at any time by pressing 

Step 4A - Self-tuning with rotating motor (Autotune rotation)

Use this procedure when the motor is not coupled or the transmission does not represent more than 5% of the load. This procedure obtains the most accurate data.

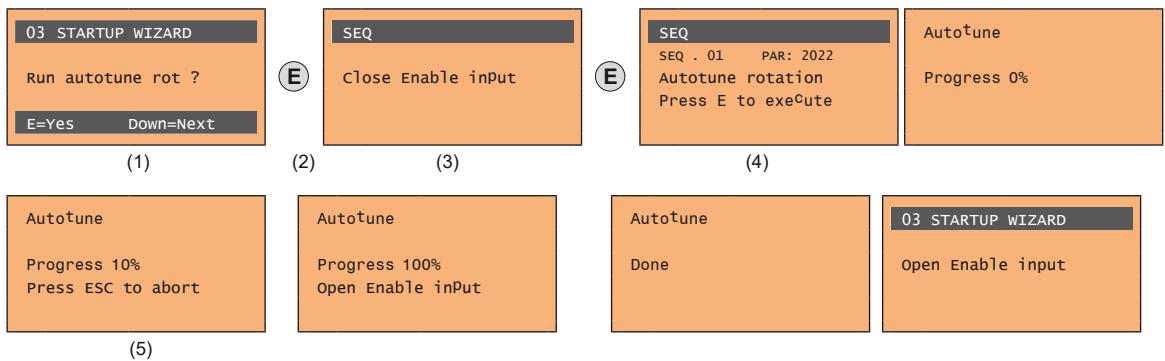

Step 4B - Self-tuning with motor at stand-still or coupled to the load (Autotune still)

Use this procedure when the motor is coupled to the transmission and cannot rotate freely.



May cause limited rotation of the shaft.

Peut entraîner une rotation de l'arbre limitée.

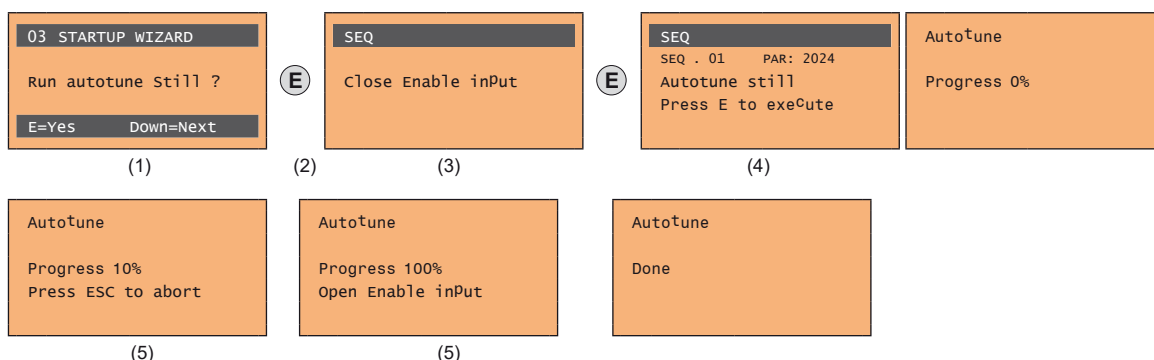

- (1) Press the **E** key to proceed to the autotune procedure.
- (2) Press the **E** key to start the autotune procedure.
- (3) Enable the drive by connecting terminal 9 on the I/O card (Enable) to terminal 12 (+24 V). To abort this operation, press the **ESC** key.
- (4) Once the drive is enabled the autotune procedure starts. This may take a few minutes, depending on the type of motor being used.
- (5) At the end of the procedure the following screen is displayed. After opening the Enable contact, proceed to step 4.

Note!

At the end of the autotune procedure there is a request to open the Enable contact (terminals 9 - 12); this results in the automatic execution of the **Take tune parameters** command (menu 16 MOTOR DATA, PAR: 2078).

The calculated parameters are saved in a RAM memory to enable the drive to perform the necessary calculations. These data are lost if the device is switched off. To save the motor data follow the procedure described in step 9.

Step 5 - Setting encoder parameters (Standard card EXP-RES-I1-ADP)



The incorrect configuration of the encoder tension can permanently damage the device; therefore, it is advisable to check the values on the encoder's specification plate.

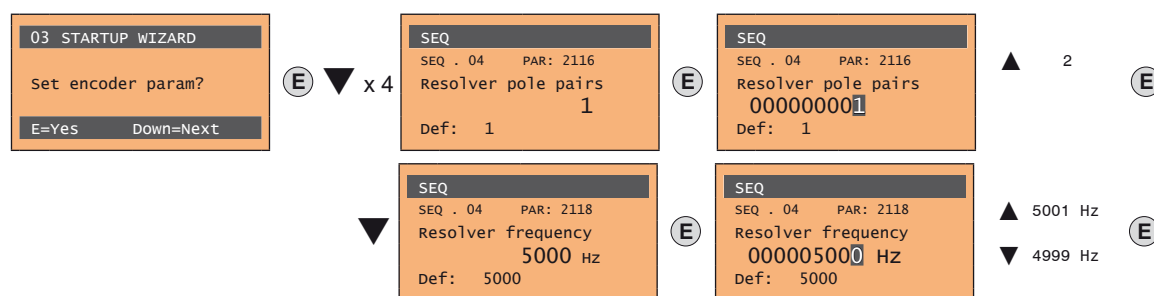

Proceed to the next step.

Step 6 - Encoder phasing (Standard card EXP-RES-I1-ADP)

ADP200 drives have a command to start automatic phasing of the resolver.

Phasing must be repeated whenever:

- the drive is replaced (alternatively, download parameters taken from previous drive)
- the motor is replaced
- the encoder is replaced

Note !

For more information see parameters 17.23 PAR 2190 **Autophase rotation** and 17.24 PAR 2192 **Autophase still** on "Functions description and parameters list" manual (ADP200 Vector inverter for Hybrid injection molding machines).

See section A.3.2 Phasing in the Appendix for further information.

Step 6A - Encoder phasing with rotating motor

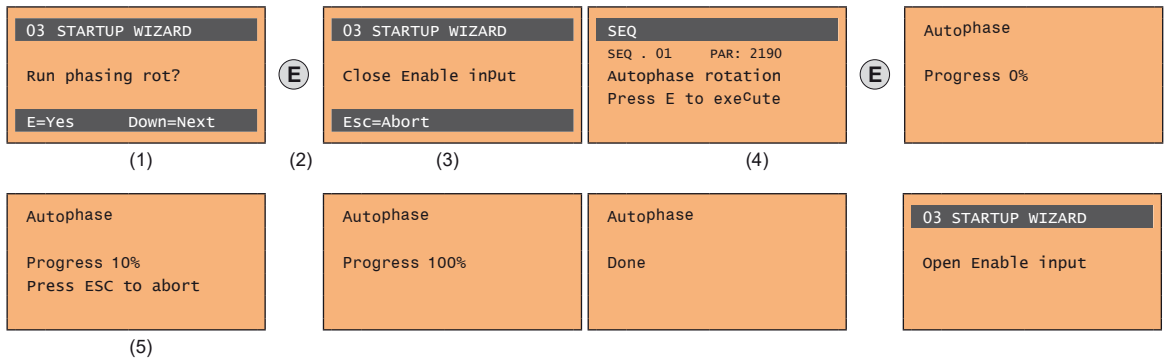

Step 6B - Encoder phasing with still motor

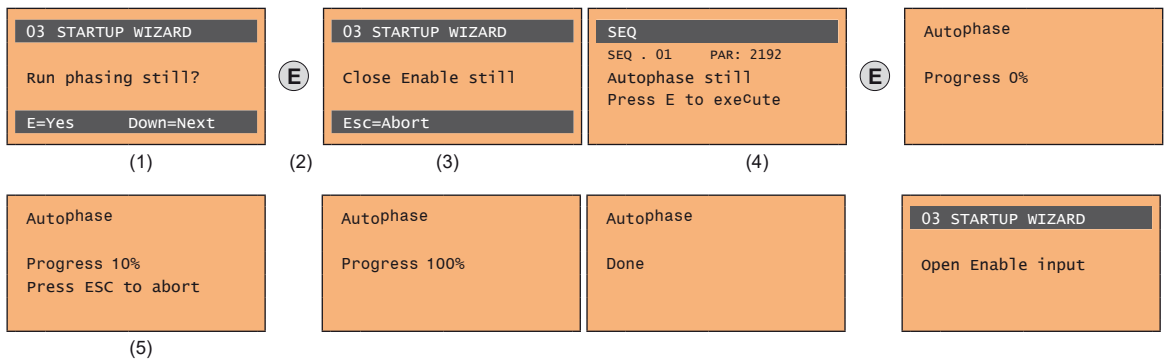

- (1) Press the **E** key to proceed to the autotune procedure.
- (2) Press the **E** key to start the autotune procedure.
- (3) Enable the drive by connecting terminal 9 on the I/O card (Enable) to terminal 12 (+24 V). To abort this operation, press the **ESC** key.
- (4) Once the drive is enabled the autophase procedure starts. This may take a few minutes, depending on the type of motor being used.
- (5) At the end of the procedure the following screen is displayed. After opening the Enable contact, proceed to step 7.

Step 7 - Setting speed parameters

Setting the maximum speed reference value: this defines the maximum motor speed value (in rpm) that can be reached with each single reference signal (analog or digital).
 Setting of the threshold above which the [23] Overspeed alarm is enabled.

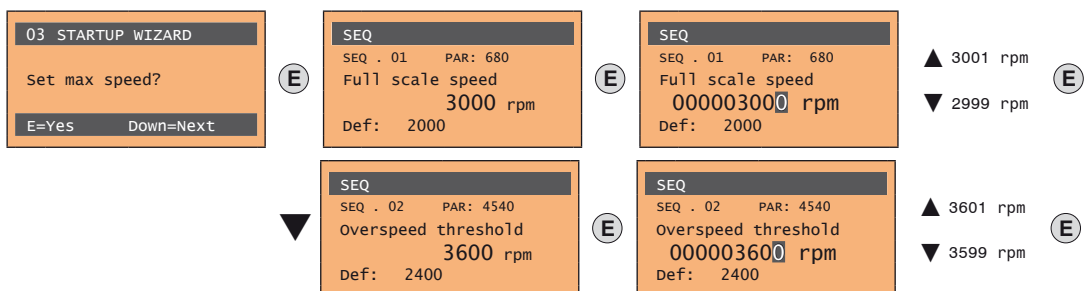

Proceed to the next step.

Note!

The factory (default) setting depends on the size of the drive that is connected. These values refer to the ADP200-2110-...

Step 8 - Motor overload setting

Enabling of the motor overload control, setting of the motor overload value (the value is expressed as a percentage of **Rated current** PAR 2002 * **Motor service factor** PAR 3206 and setting of the motor overload duration in seconds).

03 STARTUP WIZARD Set motor overload? E=Yes Down=Next	SEQ SEQ . 01 PAR: 3200 Motor ovld enable OFF	SEQ SEQ . 01 PAR: 3200 Motor ovld enable OFF	▲ ON ▼ ON
	SEQ SEQ . 02 PAR: 3202 Motor ovld factor 150.0 % Def: 150.0	SEQ SEQ . 02 PAR: 3202 Motor ovld factor 0000150.0 % Def: 150.0	▲ 151.0 % ▼ 149.0 %
	SEQ SEQ . 03 PAR: 3204 Motor ovld time 30.0 s Def: 30.0	SEQ SEQ . 03 PAR: 3204 Motor ovld time 0000030.0 s Def: 30.0	▲ 31.0 s ▼ 29.0 s

Proceed to the next step.

Step 9 – Braking resistor setting

External braking resistor: enabling of the overload control, setting of the resistance value and of the power that can be continuously dissipated.

03 STARTUP WIZARD Set braking res? E=Yes Down=Next	SEQ SEQ . 01 PAR: 3250 Bres control OFF	SEQ SEQ . 01 PAR: 3250 MotorOT probe OFF	▲ ON ▼ ON
	SEQ SEQ . 02 PAR: 3252 Bres value 49.9 ohm Def: 49.0	SEQ SEQ . 02 PAR: 3252 Bres value 0000049.0 ohm Def: 49.0	▲ 50.0 ohm ▼ 48.0 ohm
	SEQ SEQ . 03 PAR: 3254 Bres cont power 1.3 kw Def: 1.3	SEQ SEQ . 03 PAR: 3254 Bres cont power 0000001.3 kw Def: 1.3	▲ 2.3 kw ▼ 0.3 kw

Proceed to the next step.

Step 10 - Setting application parameters

For more details refer to PID-IMM Application manual.

03 STARTUP WIZARD Set application par? E=Yes Down=Next	SEQ SEQ . 01 PAR: 11004 Nominal pump speed 2400.0000 rpm Def: 2400.0000	SEQ SEQ . 01 PAR: 11004 Nominal pump speed 2400.0000 rpm Def: 2400.0000	▲ 2401.0000 rpm ▼ 2399.0000 rpm
	SEQ SEQ . 02 PAR: 11006 Nominal pump press 140.0000 bar Def: 140.0000	SEQ SEQ . 02 PAR: 11006 Nominal pump press 0140.0000 bar Def: 140.0000	▲ 141.0000 bar ▼ 139.0000 bar
	SEQ SEQ . 03 PAR: 11008 Full Scale Pres Sens 250.0000 bar Def: 250.0000	SEQ SEQ . 03 PAR: 11008 Full Scale Pres Sens 00250.0000 bar Def: 250.0000	▲ 251.0000 bar ▼ 239.0000 bar
	SEQ SEQ . 04 PAR: 11014 Auto Setup OFF	SEQ SEQ . 04 PAR: 11014 Auto Setup OFF	▲ on ▼ on

Step 11 – Analog input setting

Analog inputs (integrated and from optional expansion card): selection of the type of input (voltage or current) and self-tuning command for the relative analog inputs gain.

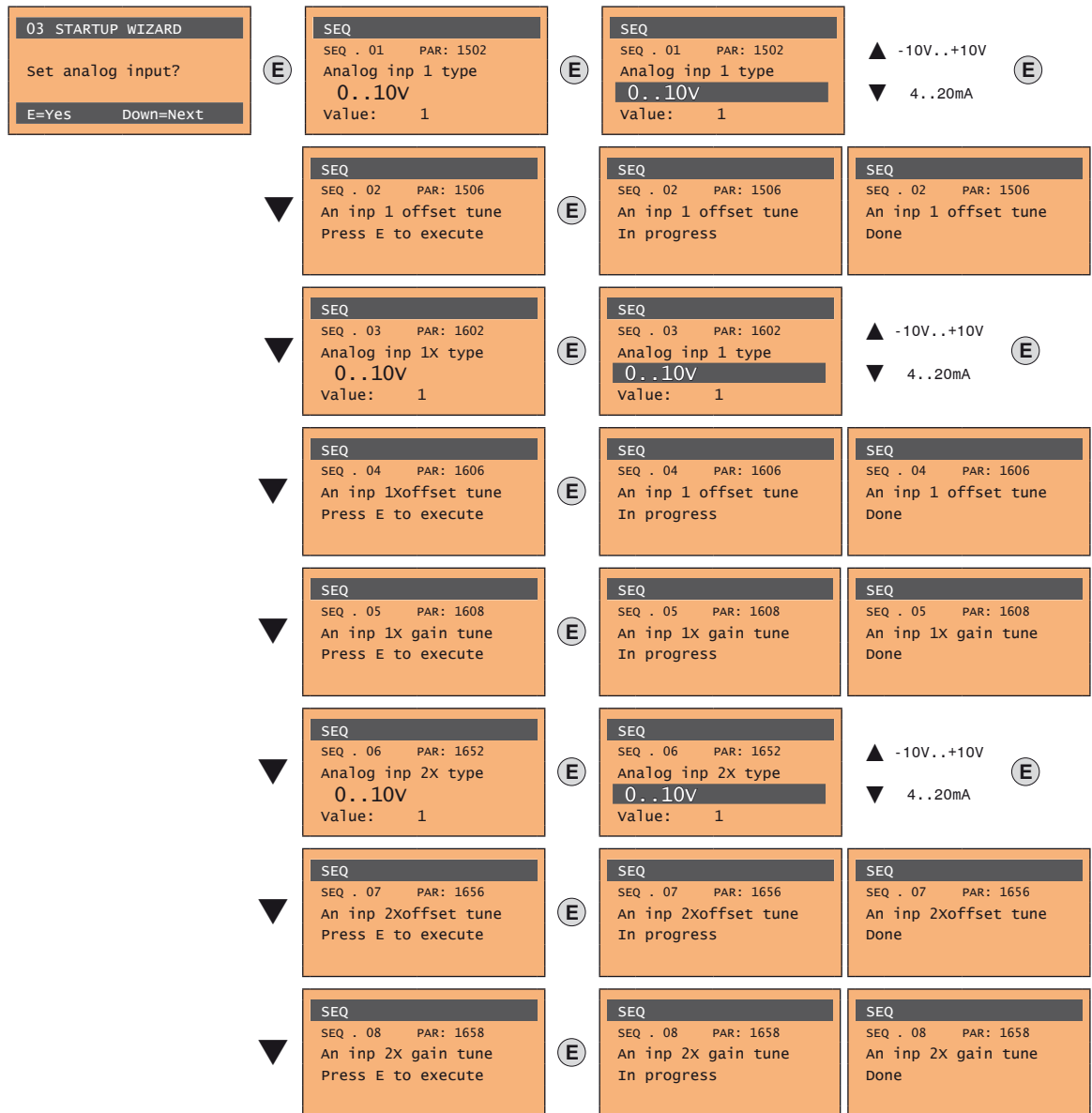

Proceed to the next step.

Step 12 - Save parameters

To save the new parameter settings, so that they are maintained also after power-off, proceed as follows:

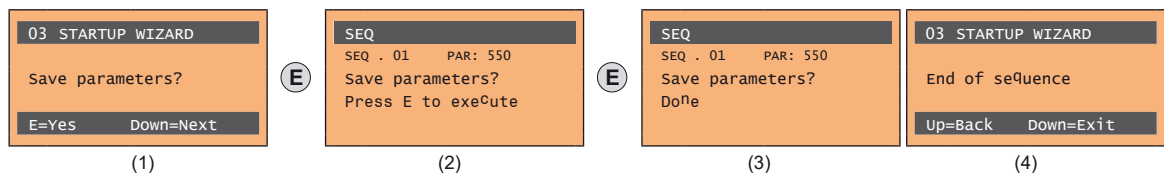

- (1) Press the **E** key to start the save parameters procedure.
- (2) Press "E" to confirm
- (3) End of procedure
- (4) When the parameters have been saved correctly the drive displays this screen to show that the startup wizard is complete.











10 - Troubleshooting













10.1 Alarms

Note !









To reset alarms, see paragraphs "8.2.6 Displaying and resetting Alarms" and "8.3.10 Alarms".

In the following table, the Code is visible only from serial line

Code	Error message shown on the display [on the integrated keypad]	Sub-code	Description
0	No alarm		Condition: No alarm present
1	Overvoltage [OV] 		Condition: DC link overvoltage alarm due to energy recovered from the motor. The voltage arriving at the drive power section is too high compared to the maximum threshold relating to the PAR 560 Mains voltage parameter setting. Solution: - Extend the deceleration ramp. - Use a braking resistor between terminals BR1 and BR2 to dissipate the recovered energy - Use the VDC Control function
2	Undervoltage [UV] 		Condition: DC link undervoltage alarm. The voltage arriving at the drive power section is too low compared to the minimum threshold relating to the 560 Mains voltage parameter setting due to: - the mains voltage being too low or overextended voltage drops. - poor cable connections (e.g. loose contactor terminals, inductance, filter, etc.). Solution: Check the connections.
3	Ground fault [GNDF] 		Condition: Ground short circuit alarm Solution: - Check drive and motor wiring. - Check that the motor is not grounded.
4	Overcurrent [OC] 		Condition: Instantaneous overcurrent protection intervention alarm. This may be due to the incorrect setting of current regulator parameters or a short circuit between phases or ground fault on the drive output. Solution: - Check the current regulator parameters (menu 17) - Check wiring towards the motor
5	Desaturation [DES] 		Condition: Instantaneous overcurrent in the IGBT bridge alarm. Solution: - Switch the drive off and then switch it on again. - If the alarm persists, contact the technical service centre.
6	MultiUndervolt [MUV] 		Condition: The number of attempted automatic restarts after the Undervoltage alarm has exceeded the set PAR 4650 UVRep attempts value in the PAR 4652 UVRep delay time. Solution: Too many Undervoltage alarms. Adopt the proposed solutions for the Undervoltage alarm.
7	MultiOvercurr [MOC] 		Condition: 2 attempted automatic restarts after the Overcurrent alarm within 30 seconds. If more than 30 seconds pass after the Overcurrent alarm was generated, the attempt counter is reset. Solution: Too many Overcurrent alarms. Adopt the proposed solutions for the Overcurrent alarm.
8	MultiDesat [MDES] 		Condition: 2 attempted at automatic restarts after the Desaturation alarm within 30 seconds. If more than 30 seconds pass after the Desaturation alarm was generated, the attempt counter is reset. Solution: Too many Desaturation alarms. Adopt the proposed solutions for the Desaturation alarm.
9	Heatsink OT [HOT] 		Condition: Heatsink temperature too high alarm Solution: - Verify the correct operation of the cooling fan. - Check that the heatsinks are not clogged - Check that the openings for the cabinet cooling air are not blocked.
10	HeatsinkS OTUT [HSOT] 		Condition: IGBT modules temperature too high or too low alarm Solution: - Verify the correct operation of the cooling fan. - Check that the heatsinks are not clogged - Check that the openings for the cabinet cooling air are not blocked.
11	Intakeair OT [IOT] 		Condition: Intake drive air temperature too high alarm. Solution: - Check correct fan operation - Check that panel cooling air openings are unobstructed. - Check temperature in electrical panel.
12	Motor OT [MOT] 		Condition: Motor overtemperature alarm. Possible causes: - Load cycle too heavy - The motor is installed in a place where the ambient temperature is too high - If the motor is provided with a blower: the fan is not working - If the motor is not provided with a blower: the load is too high at slow speeds. Cooling the fan on the motor shaft is not sufficient for this load cycle. - The motor is used at less than the rated frequency, causing additional magnetic losses. - Motor temperature probe not connected or incorrect setting of parameters 4530, 4538 and 4522.

Code	Error message shown on the display [on the integrated keypad]	Sub-code	Description
			Solution: - Change the processing cycle. - Use a cooling fan to cool the motor. - Check the connection of the motor temperature probe or the settings of parameters 4530, 4538 and 4522.
13	Drive overload [DOL]		Condition: Drive overload alarm. - The inverter output current has exceeded the allowed overload value. - The overload cycle has exceeded the allowed values.
			Solution: - Check that the load is not excessive. - Check that accelerations are not excessive. - Check that the overload cycle is within allowed limits.
14	Motor overload [MOL]		Condition: Motor overload alarm. The current absorbed during operation is greater than that specified on the motor data plate.
			Solution: - Reduce the motor load. - Increase the size of the motor.
15	Bres overload [BOL]		Condition: Braking resistor overload alarm. The current absorbed by the resistor is greater than the rated current. The overload threshold of the accumulator of the I ² t braking resistor thermal image has been exceeded. For standard external braking resistor the Max overload (factory set) is 1" service 10% (see Table 5.4.1 on ADP200 QS manual).
			Solution: - Check the size of the braking resistor. - Check the condition of the braking resistor Use braking resistor with higher energy value and change the parameters on 22.5 - FUNCTIONS/BRES OVERLOAD menu.
16	Phase loss [PHL]		Condition: Power phase loss alarm.
			Solution: Check the mains voltage and whether any protections upstream of the drive have been tripped.
17	Opt Bus fault [OPTB]		Condition: Error in the configuration stage or communication error.
		XXX0H-X	If the first digit to the left of "H" in the alarm sub-code is equal to 0, the error relates to a communication problem.
		XXXXH-X	If the first digit to the left of "H" in the alarm sub-code is other than 0, the error relates to a configuration problem.
			Solution: For configuration errors, check the configuration of the Bus communication, Bus type, Baudrate, address. parameter setting For communication errors verify wiring, resistance of terminations, interference immunity, timeout settings. For further details, please refer to the user guide for the specific bus.
18	Opt 1 IO fault [OPT1]		Condition: Error in the communication between Regulation and I/O expansion card in slot 1.
			Solution: Check that it has been inserted correctly, see Appendix section A.1.
19	Opt 2 IO fault [OPT2]		Condition: Error in the communication between Regulation and encoder expansion card in slot 2.
			Solution: Check that it has been inserted correctly, see Appendix section A.1.
20	Opt Enc fault [OPT E]		Condition: Error in the communication between Regulation and Encoder feedback card.
			Solution: Check that it has been inserted correctly, see Appendix section A.1.
21	External fault [EF]		Condition: External alarm present. A digital input has been programmed as an external alarm, but the +24V voltage is not available on the terminal.
			Solution: Check that the terminal screws are tight
22	Speed fbk loss [SFL]		Condition: Speed feedback loss alarm. The encoder is not connected, not connected properly or not powered: verify encoder operation by selecting the PAR 260 Motor speed parameter in the MONITOR menu.
			Solution: - Check encoder wiring for integrity. - Check that the encoder is connected to the power supply. - With the drive disabled, turn the motor clockwise (seen from the motor shaft side). A positive value must be displayed. - If the value does not change or values are indicated randomly, check the encoder power supply and cables. - If the value displayed is negative, invert the encoder connections. Change channel A+ and A- or B+ and B-. - Check that the encoder electronics are consistent with those of the relative expansion card. - Generated in case of an encoder fault. Each type of encoder generates a "Loss of feedback" alarm differently. See parameter 2172 SpdFbkLoss code for information about the cause of the alarm and chapter 10.2 Speed fbk loss [22] alarm
23	Overspeed [OS]		Condition: Motor overspeed alarm. The motor speed exceeds the limits set in the PAR 4540 parameter.
			Solution: - Limit the speed reference. - Check that the motor is not driven in overspeed during rotation.
24	Speed ref loss [SRL]		Condition: Speed reference loss alarm; occurs if the difference between the speed regulator reference and the actual motor speed is more than 100 rpm. This condition occurs because the drive is in the current limit condition. It is only available in the Flux Vect OL and Flux Vect CL mode (see PAR 4550).
			Solution: - Check the drive load conditions - Check the number of encoder impulses

Code	Error message shown on the display [on the integrated keypad]	Sub-code	Description
25	Emg_stop_alarm [EMGS] ENGS		Condition: Emergency stop alarm. The Stop key on the keypad was pressed with the PAR 1008 Stop key mode parameter set to EmgStop&Alarm . Active in remote control mode (PAR 1012=1) both by using "Terminals" command or "Digital" commands and, in local control mode (PAR 1012=0) by using "Terminals" command. Solution: Eliminate the reason for which the Stop key on the keypad was pressed and reset the drive.
26	Power down [PD] Pd		Condition: The drive was enabled with no supply voltage at the power section. Solution: Check the drive power supply
27-28-29	Not Used		
30	Motor pre OT [PROT] Prot		Condition: Motor overtemperature prealarm. % value of threshold compared to PAR 4532 MotorOT thr , Solution: Value set too low for duty cycle
31	Mot phase loss [PHLO] PHLO		Condition: Output phase loss. Solution: Check Drive/motor connection.
32	Not Used		
33 ... 40	Plc1 fault [PL01] ... Plc8 fault [PL08] PLC01 PLC08		Condition: Enabled application developed in the IEC 61131-3 environment has found the conditions for generating this specific alarm to be true. The meaning of the alarm depends on the type of application. For more information, refer to the documentation concerning the specific application.. XXXXH-X The XXXXH-X code indicates the reason for the error: make a note of this to discuss it with the service centre. Solution: Refer to the documentation concerning the enabled application.
41	Watchdog [WDT] Wdt		Condition: this condition can occur during operation when the watchdog micro protection is enabled; the alarm is included in the list of alarms and alarm log. After this alarm: - the drive automatically runs a reset - motor control is not available. XXXXH-X The XXXXH-X code indicates the reason for the error: make a note of this to discuss it with the service centre. Solution: If the alarm is the consequence of a change in the drive configuration (parameter setting, option installation, PLC application download) remove it. Turn the drive off and then on again.
42	Trap error [TRAP] TRAP		Condition: this condition can occur during operation when the trap micro protection is enabled; the alarm is included in the list of alarms and alarm log. After this alarm: - the drive automatically runs a reset - motor control is not available. XXXXH-X The XXXXH-X (SubHandler-Class) code indicates the reason for the error: make a note of this to discuss it with the service centre. Solution: If the alarm was a consequence of a variation to the drive configuration (parameter setting, installation of an option, downloading of a PLC application), remove it. Switch the drive off and then switch it on again.
43	System error [SYS] SYS		Condition: this condition can occur during operation when the operating system protection is enabled; the alarm is included in the list of alarms and alarm log. After this alarm: - the drive automatically runs a reset - motor control is not available. XXXXH-X The XXXXH-X (Error-Pid) code indicates the reason for the error: make a note of this to discuss it with the service centre. Solution: If the alarm was a consequence of a variation to the drive configuration (parameter setting, installation of an option, downloading of a PLC application), remove it. Switch the drive off and then switch it on again.
44	User error [USR] USR		Condition: this condition can occur during operation when the software protection is enabled; the alarm is included in the list of alarms and alarm log. After this alarm: - the drive automatically runs a reset - motor control is not available. XXXXH-X The XXXXH-X (Error-Pid) code indicates the reason for the error: make a note of this to discuss it with the service centre. Solution: If the alarm was a consequence of a variation to the drive configuration (parameter setting, installation of an option, downloading of a PLC application), remove it. Switch the drive off and then switch it on again.
45	Param error [PRR] PRR		Condition: An error occurs during the enabling of the parameter database saved in the Flash memory; one parameter value is out of range. XXXXH-X Code XXXXH indicates the number of the parameter (Hex) that has caused the error when the database is enabled. Solution: Set the parameter causing the error to a value within the range and run Save parameter . Switch the drive off and then switch it back on again. If the IPA of the parameter is not shown in the manual, contact the service centre.
46	Load default [LD] LD		Condition: this can occur during loading of the parameter database saved in the Flash memory it is normal if it appears in the following conditions: the first time the drive is switched on, when a new version of the firmware is downloaded, when the regulation is installed on a new size, when a new region is entered. If this message appears when the drive is already in use it means there has been a problem in the parameter database saved in the Flash memory. If this message is displayed the drive restores the default database, i.e. the one downloaded during production. 0001H-1 The database saved is not valid 0002H-2 The database saved is not compatible 0003H-3 The saved database refers to a different size and not to the current size 0004H-4 The saved database refers to a different region and not to the current region

Code	Error message shown on the display [on the integrated keypad]	Sub-code	Description
			Solution: Set the parameters to the desired value and execute Save parameters
47	Plc cfg error [PLCE] 		Condition: this can occur during loading of the MDPLC application The Mdplc application present on the drive is not run.
		0004H-4	The application that has been downloaded has a different Crc on the DataBlock and Function table.
		0065H-101	The application that has been downloaded has an invalid identification code (Info).
		0066H-102	The application that has been downloaded uses an incorrect task number (Info).
		0067H-103	The application that has been downloaded has an incorrect software configuration.
		0068H-104	The application that has been downloaded has a different Crc on the DataBlock and Function table.
		0069H-105	A Trap error or System error has occurred. The drive has automatically executed a Power-up operation. Application not executed. See the Alarm List for more information about an error that has occurred.
		006AH-106	The application that has been downloaded has an invalid identification code (Task).
		006BH-107	The application that has been downloaded uses an incorrect task number (Task).
		006CH-108	The application that has been downloaded has an incorrect Crc (Tables + Code)
			Solution: Remove the MDPLC application or download a correct MDPLC application.
48	Init_LdPlcPar [LDP] 		Condition: this can occur during loading of the parameter database saved in the Flash memory of the MDPLC application it is normal if it appears the first time the drive is switched on, after downloading a new application. If this message appears when the drive is already in use it means there has been a problem in the parameter database saved in the Flash memory. If this message appears the drive automatically runs the Load default PAR 580 command.
		0001H-1	The database saved is not valid
			Solution: Set the parameters to the desired value and run Save parameter .
49	Key failed [KEY] 		Condition: this can occur at drive power-on if the wrong enabling key is entered for a given firmware function
		0001H-1	Incorrect PLC key. PLC application not available.
			Solution: Contact WEG to request the key to enable the desired firmware function.
50	Encoder error [ENC] 		Condition: this condition may occur when the drive is powered during encoder setup each time parameter 552 Regulation mode is set.
		100H-256	Cause: An error occurred during setup; the information received from the encoder is not reliable. If the encoder is used for feedback the Speed fbk loss [22] alarm is also generated. Solution: Take the recommended action for the Speed fbk loss [22] alarm.
		200H-512	Cause: The firmware on the optional encoder card is incompatible with that on the regulation card. The information received from the encoder is not reliable Solution: Contact WEG in order to update the firmware on the optional encoder card.
51	Opt cfg change [OCFG] 		Condition: this may occur when powering the drive if an expansion card has been removed or replaced or the incorrect enable key is inserted for a given firmware function.
		0064H-100	Card removed from slot 1.
		0014H-20	Card removed from slot 2
		0003H-3	Card removed from slot 3
		0078H-120	Card removed from slot 1 and from slot 2
		0067H-103	Card removed from slot 1 and from slot 3.
		0017H-23	Card removed from slot 2 and from slot 3.
		007BH-123	Card removed from slot 1, from slot 2 and from slot 3
			Solution: Check the hardware configuration, then press ESC. Save the parameters (Save parameters , menu 04.01 par 550) to save the new hardware configuration.
52	Power config [PCFG] 		Condition: It can occur at the power-on during recognition size phase.
			Solution: Contact the WEG technical support centre.
53 ... 60	Plc9 fault [PL09] ... Plc16 fault [PL16] 		Condition: Enabled application developed in the IEC 61131-3 environment has found the conditions for generating this specific alarm to be true. The meaning of the alarm depends on the type of application. For more information, refer to the documentation concerning the specific application.
		XXXXH-X	The XXXXH-X code indicates the reason for the error: make a note of this to discuss it with the service centre.
			Solution: Refer to the documentation concerning the enabled application.
64	Fault code 64 [FC64] 		Condition: It can occur at drive disabling
			Solution: Contact the WEG technical support center

10.2 Speed fbk loss alarm according to the type of feedback

Note

For the correct interpretation of the cause of the alarm trigger, it is necessary to transform the hex code indicated in parameter 17.38 **SpdFbkLoss code**, PAR 2172, in the corresponding binary and verify in the encoder table that the active bits and related description are used.

Example with encoder Endat:

PAR 2172 = A0H (hex value)

In the table "Speed fbk loss [22] alarm with absolute encoder EnDat" A0 is not indicated in the value column.

A0 should be contemplated as a bitword with meaning A0 -> 10100000 -> bit 5 and bit 7. The following causes simultaneously occurs:

- Bit 5 = 20H Cause: the SSI signal interferences cause an error in the CKS or parity.

- Bit 7 = 80H Cause: The encoder has detected an incorrect operation and communicates it to the converter through the Error bit. Bits 16..31 present the type of incorrect encoder operation detected.

The value is displayed in hexadecimal format on the optional and standard keypad.

• Speed fbk loss [22] alarm with Resolver

Code	Name	Error description	Possible solution
0x00000001	D0 FAULT REGISTER	Configuration parity error	Reset Resolver card
0x00000002	D1 FAULT REGISTER	Phase error exceeds phase lock range	
0x00000004	D2 FAULT REGISTER	Velocity exceeds maximum tracking rate	
0x00000008	D3 FAULT REGISTER	Tracking error exceeds LOT (Loss of Signal) threshold	
0x00000010	D4 FAULT REGISTER	SIN/COS inputs exceed DOS (Degradation of signal) mismatch threshold	Check the connection of the Resolver input pins (SIN-,SIN+,COS-,COS+), check PAR 2128
0x00000020	D5 FAULT REGISTER	SIN/COS inputs exceed DOS (Degradation of signal) over range threshold	Check the connection of the Resolver input pins (SIN-,SIN+,COS-,COS+), check PAR 2126
0x00000040	D6 FAULT REGISTER	SIN/COS inputs below LOS (Loss of Signal) threshold	Check the connection of the Resolver input pins (SIN-,SIN+,COS-,COS+), check PAR 2124
0x00000080	D7 FAULT REGISTER	SIN/COS inputs clipped	Check if any of the Resolver input pins (SIN-,SIN+,COS-,COS+) are shorted with power input or ground of the resolver board

• Speed fbk loss [22] alarm with digital incremental encoder

Bit	Value	Name	Description
0	0x01	CHA	Cause: no impulses or disturbance on incremental channel A.
			Solution: Check the connection of the encoder-drive channel A, check the connection of the screen, check the encoder supply voltage, check parameter 2102 Encoder supply , check parameter 2104 Encoder input config .
1	0x02	CHB	Cause: no impulses or disturbance on incremental channel B.
			Solution: Check the connection of the encoder-drive channel B, check the connection of the screen, check the encoder supply voltage, check parameter 2102 Encoder supply , check parameter 2104 Encoder input config .
2	0x04	CHZ	Cause: no impulses or disturbance on incremental channel Z.
			Solution: Check the connection of the encoder-drive channel Z, check the connection of the screen, check the encoder supply voltage, check parameter 2102 Encoder supply , check parameter 2104 Encoder input config , check parameter 2110 Encoder signal check

• Speed fbk loss [22] alarm with sinusoidal incremental encoder

Bit	Value	Name	Description
3	0x08	MOD_INCR	Cause: voltage level not correct or disturbance on signals of incremental channels A-B.
			Solution: Check the connection of the encoder-drive channels A-B, check the connection of the screen, check the encoder supply voltage, check parameter 2102 Encoder supply , check parameter 2108 Encoder signal Vpp .

• Speed fbk loss [22] alarm with SinCos encoder

Bit	Value	Name	Description
3	0x08	MOD_INCR	Cause: voltage level not correct or disturbance on signals of incremental channels A-B.
			Solution: Check the connection of the the encoder-drive channels A-B, check the connection of the screen, check the encoder supply voltage, check parameter 2102 Encoder supply , check parameter 2108 Encoder signal Vpp .
4	0x10	MOD_ABS	Cause: voltage level not correct or disturbance on signals of absolute SinCos channels.
			Solution: Check the connection of the the encoder-drive channels A-B, check the connection of the screen, check the encoder supply voltage, check parameter 2102 Encoder supply , check parameter 2108 Encoder signal Vpp .

- **Speed fbk loss [22] alarm with SSI absolute encoder**

Bit	Value	Name	Description
3	0x08	MOD_INCR	Cause: voltage level not correct or disturbance on signals of incremental channels A-B.
			Solution: Check the connection of the the encoder-drive channels A-B, check the connection of the screen, check the encoder supply voltage, check parameter 2102 Encoder supply , check parameter 2108 Encoder signal Vpp .
5	0x20	CRC_CKS_P	Cause: SSI signals not present or disturbed.
			Solution: Check the connection of the clock and encoder-drive data, check the connection of the screen, check the encoder supply voltage, check parameter 2102 Encoder supply , check parameter 2112 Encoder SSI bits .
8	0x100	Setup error	Cause: An error occurred during setup.
			Solution: Check the connection of the clock and encoder-drive data, check the connection of the screen, check the encoder supply voltage, check parameter 2102 Encoder supply , check parameter 2112 Encoder SSI bits .

- **Speed fbk loss [22] alarm with EnDat absolute encoder**

Bit	Value	Name	Description
3	0x08	MOD_INCR	Cause: voltage level not correct or disturbance on signals of incremental channels A-B.
			Solution: Check the connection of the the encoder-drive channels A-B, check the connection of the screen, check the encoder supply voltage, check parameter 2102 Encoder supply , check parameter 2108 Encoder signal Vpp .
5	0x20	CRC_CKS_P	Cause: SSI signals not present or disturbed cause an error on CRC.
			Solution: Check the connection of the clock and encoder-drive data, check the connection of the screen, check the encoder supply voltage, check parameter 2102 Encoder supply .
8	0x100	Setup error	Cause: An error occurred during setup.
			Solution: Check the connection of the clock and encoder-drive data, check the connection of the screen, check the encoder supply voltage, check parameter 2102 Encoder supply .

The following conditions occur while resetting the encoder following **Speed fbk loss [22]** activation

Bit	Value	Name	Description																																				
6	0x40	ACK_TMO	Cause: SSI signals not present or disturbed cause an error on CRC.																																				
			Solution: Check the connection of the clock and encoder-drive data, check the connection of the screen, check the encoder supply voltage, check parameter 2102 Encoder supply .																																				
7	0x80	DT1_ERR	Cause: Encoder has detected malfunction and signals this to the drive via bit DT1. Bits 16..31 contain the type of malfunction detected by the encoder.																																				
			Solution: See the encoder manufacturer's technical guide.																																				
16.31			<table border="1"> <thead> <tr> <th>Bit</th> <th></th> <th>=0</th> <th>=1</th> </tr> </thead> <tbody> <tr> <td>0</td> <td>Light source</td> <td>OK</td> <td>Failure (1)</td> </tr> <tr> <td>1</td> <td>Signal amplitude</td> <td>OK</td> <td>Erroneous (1)</td> </tr> <tr> <td>2</td> <td>Position value</td> <td>OK</td> <td>Erroneous (1)</td> </tr> <tr> <td>3</td> <td>Over voltage</td> <td>NO</td> <td>Yes (1)</td> </tr> <tr> <td>4</td> <td>Under voltage</td> <td>NO</td> <td>Under voltage supply (1)</td> </tr> <tr> <td>5</td> <td>Over current</td> <td>NO</td> <td>Yes (1)</td> </tr> <tr> <td>6</td> <td>Battery</td> <td>OK</td> <td>Change the battery (2)</td> </tr> <tr> <td>7..15</td> <td></td> <td></td> <td></td> </tr> </tbody> </table>	Bit		=0	=1	0	Light source	OK	Failure (1)	1	Signal amplitude	OK	Erroneous (1)	2	Position value	OK	Erroneous (1)	3	Over voltage	NO	Yes (1)	4	Under voltage	NO	Under voltage supply (1)	5	Over current	NO	Yes (1)	6	Battery	OK	Change the battery (2)	7..15			
			Bit		=0	=1																																	
			0	Light source	OK	Failure (1)																																	
			1	Signal amplitude	OK	Erroneous (1)																																	
			2	Position value	OK	Erroneous (1)																																	
			3	Over voltage	NO	Yes (1)																																	
			4	Under voltage	NO	Under voltage supply (1)																																	
			5	Over current	NO	Yes (1)																																	
			6	Battery	OK	Change the battery (2)																																	
			7..15																																				
(1) Can also be set after the power supply is switched off or on.																																							
(2) Only for battery-buffered encoders																																							

- **Speed fbk loss [22] alarm with Hiperface absolute encoder**

Bit	Value	Name	Description
3	0x08		Cause: voltage level not correct or disturbance on signals of incremental channels A-B.
			Solution: Check the connection of the the encoder-drive channels A-B, check the connection of the screen, check the encoder supply voltage, check parameter 2102 Encoder supply , check parameter 2108 Encoder signal Vpp .
5	0x20		Cause: disturbed SSI signals cause a CKS error or Parity
			Solution: Check the connection of the clock and encoder-drive data, check the connection of the screen, check the encoder supply voltage, check parameter 2102 Encoder supply .
6	0x40		Cause: Encoder does not recognise the command that has been sent to it and replies with ACK. The SSI signals not present cause a TMO error.
			Solution: Check the connection of the clock and encoder-drive data, check the connection of the screen, check the encoder supply voltage, check parameter 2102 Encoder supply .
8	0x100		Cause: An error occurred during setup.

Bit	Value	Name	Description
			Solution: Check the connection of the clock and encoder-drive data, check the connection of the screen, check the encoder supply voltage, check parameter 2102 Encoder supply .

The following conditions occur while resetting the encoder following **Speed fbk loss** [22] activation.

Bit	Value	Name	Description																																																												
7	0x80	DT1_ERR	Cause: Encoder has detected malfunction and signals this to the drive via Error bit. Bits 16..31 contain the type of malfunction detected by the encoder. Solution: See the encoder manufacturer's technical guide.																																																												
16.31			<table border="1"> <thead> <tr> <th>Type</th> <th>Code</th> <th>Description</th> </tr> </thead> <tbody> <tr> <td>Transmission</td> <td>09h</td> <td>Transmitted parity bit is incorrect</td> </tr> <tr> <td></td> <td>0AH</td> <td>Checksum of transmitted data is wrong</td> </tr> <tr> <td></td> <td>0BH</td> <td>Incorrect command code</td> </tr> <tr> <td></td> <td>0CH</td> <td>Wrong number of transmitted data</td> </tr> <tr> <td></td> <td>0DH</td> <td>Illegal transmitted command argument</td> </tr> <tr> <td></td> <td>0FH</td> <td>Wrong access authorization specified</td> </tr> <tr> <td></td> <td>0EH</td> <td>Selected field has READ ONLY status</td> </tr> <tr> <td></td> <td>10H</td> <td>Data field (re) definition not executable due to field size</td> </tr> <tr> <td></td> <td>11H</td> <td>Specified address is not available in selected field</td> </tr> <tr> <td></td> <td>12H</td> <td>Selected field does not yet exist</td> </tr> <tr> <td></td> <td>00H</td> <td>No encoder error, no error message</td> </tr> <tr> <td></td> <td>03H</td> <td>Data field operations disabled</td> </tr> <tr> <td></td> <td>04H</td> <td>Analog monitoring inoperative</td> </tr> <tr> <td></td> <td>08H</td> <td>Counting register overflow</td> </tr> <tr> <td></td> <td>01H</td> <td>Encoder analog signals are unreliable</td> </tr> <tr> <td></td> <td>02H</td> <td>Wrong synchronisation or offset</td> </tr> <tr> <td></td> <td>05H-07H</td> <td>Encoder-internal hardware fault, no operation possible</td> </tr> <tr> <td></td> <td>1CH-1DH</td> <td>Error in sampling, no operation possible</td> </tr> <tr> <td></td> <td>1EH</td> <td>Permissible operation temperature is exceeded</td> </tr> </tbody> </table>	Type	Code	Description	Transmission	09h	Transmitted parity bit is incorrect		0AH	Checksum of transmitted data is wrong		0BH	Incorrect command code		0CH	Wrong number of transmitted data		0DH	Illegal transmitted command argument		0FH	Wrong access authorization specified		0EH	Selected field has READ ONLY status		10H	Data field (re) definition not executable due to field size		11H	Specified address is not available in selected field		12H	Selected field does not yet exist		00H	No encoder error, no error message		03H	Data field operations disabled		04H	Analog monitoring inoperative		08H	Counting register overflow		01H	Encoder analog signals are unreliable		02H	Wrong synchronisation or offset		05H-07H	Encoder-internal hardware fault, no operation possible		1CH-1DH	Error in sampling, no operation possible		1EH	Permissible operation temperature is exceeded
Type	Code	Description																																																													
Transmission	09h	Transmitted parity bit is incorrect																																																													
	0AH	Checksum of transmitted data is wrong																																																													
	0BH	Incorrect command code																																																													
	0CH	Wrong number of transmitted data																																																													
	0DH	Illegal transmitted command argument																																																													
	0FH	Wrong access authorization specified																																																													
	0EH	Selected field has READ ONLY status																																																													
	10H	Data field (re) definition not executable due to field size																																																													
	11H	Specified address is not available in selected field																																																													
	12H	Selected field does not yet exist																																																													
	00H	No encoder error, no error message																																																													
	03H	Data field operations disabled																																																													
	04H	Analog monitoring inoperative																																																													
	08H	Counting register overflow																																																													
	01H	Encoder analog signals are unreliable																																																													
	02H	Wrong synchronisation or offset																																																													
	05H-07H	Encoder-internal hardware fault, no operation possible																																																													
	1CH-1DH	Error in sampling, no operation possible																																																													
	1EH	Permissible operation temperature is exceeded																																																													

10.2.1 Reset Speed fbk loss alarm

The reasons for activating the **Speed fbk loss** alarm and the information acquired by the encoder are shown in parameter 2172 **SpdFbkLoss code**.

If no card has been installed the **Speed fbk loss** [22] alarm is generated and no cause is displayed in parameter 2172 **SpdFbkLoss code**. Several causes may be present at the same time.

If no card is recognised, the system runs a routine that always returns **Speed fbk loss** [22] active without specifying a cause.

10.2.2 Encoder error alarm





Setup is performed each time the drive is turned on, regardless of the regulation mode that has been selected. If an error is detected during setup the **Encoder error** alarm is generated with the following codes:







Bit	Value	Name	Description
8	0x100	Setup error	Cause: An error occurred during setup. When this has been signalled the information obtained from the encoder is not reliable. Solution: Take the action recommended for Speed fbk loss [22] alarm according to the type of encoder.
9	0x200	Compatibility error	Cause: Firmware on option card incompatible with firmware on regulation card. When this has been signalled the information obtained from the encoder is not reliable. Solution: Contact WEG in order to update the firmware on the optional card.











10.3 Messages



Note !

For more information see **chapter 8.7**.

Index	Error message shown on the display [on the integrated keypad]	Sub-code	Description
1	Load default param [LDEF] 	Condition: may occur during loading of the parameter database saved in flash normally appears in the following conditions: at initial power-on when a new firmware version is downloaded, when the regulation is installed on a new size, when the region is changed. If this message is displayed when the drive is already operating, this means that a problem has occurred in the parameter database saved in Flash. If this message is displayed, the drive automatically performs the Load default command.	
		0001H-1	The database saved is not valid
		0002H-2	The database saved is not compatible
		0003H-3	The database saved refers to a different size from the current size
		0004H-4	The database saved refers to a different region from the current region
Solution: Set the parameters to the value required and perform Save parameter			
2 3 4	Option detect slot 1 [OPT1]  Option detect slot 2 [OPT2]  Option detect slot 3 [OPT3] 	Condition: when the drive is turned on it recognises the presence of an optional card. One of the messages is shown on the display for a few seconds	
		0H-0	None
		0004H-4	CAN
		0008H-8	Enc 1 (EXP-DE-I1R1F2-ADL)
		0108H-264	Enc 2 (EXP-SE-I1R1F2-ADL)
		0208H-520	Enc 3 (EXP-SESC- I1R1F2-ADL)
		0308H-776	Enc 4 (EXP-EN/SSI- I1R1F2-ADL)
		0408H-1032	Enc 5 (EXP-HIP- I1R1F2-ADL)
		0508H-1288	Enc 6 (EXP-RES-I1-ADP/ EXP-RES-I1R1-ADP)
		0101H-257	I/O 1 (EXP-IO-D4-ADL)
		0501H-1281	I/O 2 (EXP-IO-D8R4-ADL)
		0901H-2305	I/O 3 (EXP-IO-D16R4-ADL)
		0F01H-3841	I/O 4 (EXP-IO-D12A2R4-ADL)
		1301H-4865	I/O 5 (EXP-IO-D8A4R4-ADL)
		1501H-5377	I/O 6 (EXP-IO-D5R3-F-ADL)
		1F01H-7937	I/O 7 (EXP-IO-D10A3R2-ADP)
		2301H-8961	I/O 8 (EXP-IO-D8A4R2-ADP)
		2701H-9985	I/O 9 (EXP-IO-D8A4R2-SM-ADP)
		00FFH-255	Unknown
		Solution:	
5	Autotune (motor) [SLFT] 	Condition: this may occur during the Autotune procedure	
		0	No error
		1	The commands are not configured in Local mode.
			Solution: Execute the requested configuration
		2	The Commands local sel parameter has not been configured from the keypad
			Solution: Execute the requested configuration
		3	The motor plate data parameters have changed but the Take parameters command, PAR 2020, has not been executed
			Solution: Execute the Take parameters command.
		4	The motor is not connected
			Solution: Connect the motor
		5	While running self-tuning the ESC key was pressed or the enable contact was opened or an alarm occurred. The Autotune command was sent with the drive in the alarm condition
			Solution: Eliminate the reason for the alarm, remove the reason for the opening of the enable contact, reset alarms.
		6	A setting performed by the Autotune function produced a parameter value outside the min or max range.
			Solution: Check the motor plate data or drive and motor sizes have been combined incorrectly.
		7	The Autotune command was sent without being enabled.
Solution: Close the enable contact before sending the Autotune command			
8	Internal calculation error concerning IGBT control		
	Solution: Perform autotuning once more, if the problem persists, contact the WEG technical support centre.		
9	The drive has measured a stator resistance value exceeding the set limit.		
	Solution: contact the WEG technical support centre.		
10	The drive has measured a stator resistance value below the set limit.		
	Solution: contact the WEG technical support centre.		
11-12	Measurement of DTL internal compensation voltage outside accepted range.		
	Solution: check connection between drive and motor. If correct, the drive is faulty, contact the WEG technical support centre.		
13-14	Measurement of DTS internal voltage outside accepted range.		
	Solution: check connection between drive and motor. If correct, the drive is faulty, contact the WEG technical support centre.		

Index	Error message shown on the display [on the integrated keypad]	Sub-code	Description
		15 - 16 - 17	LS leakage inductance value outside accepted range. Solution: Perform autotuning once more, if the problem persists, contact the WEG technical support centre.
		18-19	Measurement of Im magnetising current outside accepted range. Solution: Perform autotuning once more, if the problem persists, contact the WEG technical support centre.
		20-21	Measurement of Rr rotor resistor outside accepted range. Solution: Perform autotuning once more, if the problem persists, contact the WEG technical support centre.
		30	The Enable was not given or removed in time during the phasing procedure. Solution: Repeat the phasing procedure and check the connection of the enable signals.
		Solution: If the message appears with a value other than 0, follow the instructions supplied for each particular case and repeat Autotune . This should be performed using the wizard function available from the keypad (STARTUP WIZARD) and the Tool software on the PC. Pay attention to all motor plate data parameters, especially: - Rated speed, Motor rated speed in rpm. - Rated frequency, Motor rated frequency in Hz - Pole pairs, Motor pole pairs Take care to set the Rated speed parameter to the synchronous speed. If the problem persists even after following the instructions supplied, confirm the values of the motor plate data parameters, execute the Take parameters command but not Autotune .	
6	Power config [PC] 	Condition: may occur during recognition of power cards. If this message is displayed, it is not possible to drive the motor. 0020H-32 The power card is configured for a drive that is incompatible with the regulation card 0021H-33 The configuration of the power card is not compatible with the regulation card 0017H-23 The configuration required is not available on the power card Solution: Download the correct configuration on the power card	
7	Save par failed [FAIL] 	Condition: during transfer of the parameters from the drive to the memory of the keypad 0H-0 Communication error 0023H-35 System error, the memory is insufficient 0024H-36 System error, memory is not valid Solution:	
8	Load par failed [FAIL] 	Condition: during transfer of the parameters from the memory of the keypad to the drive 0H-0 Communication error 0024H-36 System error, the memory is insufficient 0025H-37 The data saved on the keypad are not valid. No parameter is transferred from the keypad to the drive	
9	Load par incomplete [LPNC] 	0026H-38 Incompatible drive series. No parameter is transferred from the keypad to the drive 0027H-39 Incompatible software version. All the parameters present in the memory of the keypad have been transferred to the drive. The set of parameters transferred refers to a drive with a different firmware version; therefore, certain parameters may not be updated. 0028H-40 Incompatible drive size. All the parameters present in the memory of the keypad (excluding those that depend on the size of the drive), have been transferred to the drive. The parameters that depend on size maintain their original value. 0029H-41 Error during saving of parameters on the drive. All the parameters present in the memory of the keypad have been transferred to the drive. The transfer of one or more parameters has caused an "out of range" error, or one or more parameters does not exist. At the end of transfer, one or more parameters may not have been updated. 002AH-42 PLC application release and version not compatible. All parameters in the keypad memory have been transferred to the drive. The transferred set of parameters relates to a drive with a PLC application in which the version and release of the application are different. As a result some of the PLC application parameters may not be updated. 002BH-43 PLC application not compatible. All the parameters in the keypad memory except those relating to the PLC application have been transferred to the drive. The transferred set of parameters relates to a drive with a different PLC application. As a result none of the PLC application parameters are updated. Solution: Recover a set of parameters from a compatible drive (model and size)	
10	Options config error [OPTC] 	Condition: may occur at drive start-up, during recognition of the optional cards installed 0001H-1 Non-permissible optional card in slot 1 0002H-2 Non-permissible optional card in slot 2 0004H-4 0010H-16 Conflict slot 1 with slot 2 0020H-32 0040H-64 Solution: Remove the optional cards from the incorrect slots and insert them in the correct slots	
11	Load def plc [LDPL] 	Condition: may occur during loading of the parameter database saved in the Flash of the Mdplc application Normally appears at initial power-on after downloading a new application. If this message is displayed when the drive is already operating, this means that a problem has occurred in the parameter database saved in Flash. If this message appears the drive restores the default database, i.e. the one that was downloaded. 0001H-1 The database saved is not valid Solution: Set the parameters to the value required and perform Save parameter	

Index	Error message shown on the display [on the integrated keypad]	Sub-code	Description
12	Plc cfg error [PLCE] 		Condition: may occur during loading of the Mdplc application The Mdplc application present on the drive is not run.
		0004H-4	The application downloaded has a different Crc on DataBlock and Function table
		0065H-101	The application downloaded has an invalid identifier (Info)
		0066H-102	The application downloaded has an incorrect task number (Info)
		0067H-103	The application downloaded has an incorrect software configuration
		0068H-104	The application downloaded has a different Crc on DataBlock and Function table
		0069H-105	A Trap error or System error has occurred. The drive automatically performs a Power-up operation. The application is not run. See in Alarm List for further information regarding the error occurred
		006AH-106	The application downloaded has an incorrect identifier (Task)
		006BH-107	The application downloaded has an incorrect task number (Task)
		006CH-108	The application downloaded has an incorrect Crc (Tables + Code)
			Solution: Remove the Mdplc application or download a correct Mdplc application
13	Plc 1 [PLC1] 		Reserved messages and dedicated to the PLC application. See the application manual.
14	Plc 2 [PLC2] 		
15	Plc 3 [PLC3] 		
16	Plc 4 [PLC4] 		
17	Opt bus fault [OPTB] 		Condition: this may occur when the drive is turned on, during fieldbus card setup. Error during configuration or communication error.
		XXXXH-X	If the first digit to the left of "H" in the alarm sub-code is 0, the error regards a communication problem.
		XXXXH-X	If the first digit to the left of "H" in the alarm sub-code is other than 0, the error regards a configuration problem.
			Solution: For configuration errors, check the configuration of the bus communication, type of bus, baudrate, address, parameter setting For communication errors, check wiring, termination resistors, disturbance immunity, timeout settings. For further details, please refer to the user guide for the specific bus.
18	Wrong key [KEYF] 		Condition: this may occur when powering the drive, if the incorrect enable key is inserted for a given firmware function.
		0001H-1	Incorrect PLC key. PLC application not available.
			Solution: Ask WEG to supply the correct key to enable the desired firmware function.
19	Key expiring [KEYE] 		Condition: this may occur at drive power-on if the incorrect enabling key was inserted for a given firmware function. At this stage the firmware function can still be used freely, but this time limit is about to expire
		XXXXH-X	Number of hours for which the function can still be used freely.
			Solution: Ask WEG for the correct key to enable the desired firmware function.
20	Parameter error [PE] 		Condition: An error occurs during the enabling of the parameter database saved in flash; one parameter value is out of range.
		XXXXH-X	Code 0001H-1 indicates that one or more parameter have value out of range.
			Solution: Press the esc key and go inside Alarm log. Inside alarm Log there is Param error with a hex code of IPA parameter causing the error. Set the parameter that has caused the error to the correct value within the range and run Save parameters . Switch the drive off and then switch it back on again. If the IPA of the parameter is not shown in the manual, contact the service centre.
21	Encoder error [ENCE] 		Condition: this condition may occur when the drive is powered during encoder setup each time parameter 552 Regulation mode is set.
		100H-256	Cause: An error occurred during setup; the information received from the encoder is not reliable. If the encoder is used for feedback the Speed fbk loss alarm is also generated. Solution: Take the recommended action for the Speed fbk loss alarm.
		200H-512	Cause: The firmware on the optional encoder card is incompatible with that on the regulation card. The information received from the encoder is not reliable Solution: Contact WEG in order to update the firmware on the optional encoder card.
22	Options cfg changed [OCFG] 		Condition: this may occur when powering the drive if an expansion card has been removed or replaced or the incorrect enable key is inserted for a given firmware function.
		0064H-100	Card removed from slot 1
		0014H-20	Card removed from slot 2
		0003H-3	Card removed from slot 3
		0078H-120	Card removed from slot 1 and from slot 2
		0067H-103	Card removed from slot 1 and from slot 3
		0017H-23	Card removed from slot 2 and from slot 3
		007BH-123	Card removed from slot 1, from slot 2 and from slot 3
			Solution: Check the hardware configuration, then press ESC. Save the parameters (Save parameters , menu 04.01 par 550) to save the new hardware configuration.

Index	Error message shown on the display [on the integrated keypad]	Sub-code	Description		
23	Autotune (phasing) [SLFP] 	0	No error		
		1	The commands are not configured in Local mode. Solution: Execute the requested configuration		
		2	The Commands local sel parameter has not been configured from the keypad Solution: Execute the requested configuration		
		3	The motor plate data parameters have changed but the Take parameters command, PAR 2020, has not been executed Solution: Execute the Take parameters command.		
		4	The motor is not connected Solution: Connect the motor		
		5	While running self-tuning the ESC key was pressed or the enable contact was opened or an alarm occurred. The Autotune command was sent with the drive in the alarm condition Solution: Eliminate the reason for the alarm, remove the reason for the opening of the enable contact, reset alarms.		
		6	A setting performed by the Autotune function produced a parameter value outside the min or max range. Solution: Check the motor plate data or drive and motor sizes have been combined incorrectly.		
		7	The Autotune command was sent without being enabled. Solution: Close the enable contact before sending the Autotune command		
		40	The encoder card in use cannot manage automatic phasing. Solution: Use the appropriate encoder card		
		41	Incorrect Incremental encoder impulse count Solution: Check the electric signals of the incremental encoder. Check the value of the encoder impulse parameter		
		42	Incorrect absolute encoder impulse count Solution: Check the electric signals of the absolute encoder. Check the configuration of the absolute encoder		
		43	Incorrect incremental encoder impulse count or incorrect absolute encoder impulse count probably caused by an incorrect value of the pole pairs parameter or a load applied to the motor. Solution: Check the value of the pole pairs parameter, check whether a load is applied		
		44	Incorrect incremental encoder impulse count probably caused by the incorrect value of the encoder impulse parameter. Solution: Check the electric signals of the incremental encoder. Check the value of the encoder impulse parameter.		
		45	Incorrect absolute encoder impulse count Solution: Check the electric signals of the absolute encoder. Check the configuration of the absolute encoder.		
		46	Incremental encoder impulse count sign inverted with respect to the absolute encoder impulse count. Solution: Invert the A+ and A- signal of the incremental encoder.		
		47	Incremental encoder impulse count sign inverted with respect to the absolute encoder impulse count. Solution: Invert the A+ and A- signal of the absolute encoder.		
		48	Incorrect phase sequence. (Message not signalled) Solution: The automatic procedure has modified the setting of the Encoder direction parameter. No other action is required		
		49	During automatic phasing a communication channel is activated between the drive and encoder. An error has occurred on this communication channel. Solution: Repeat the procedure.		
					Solution: If the message has a value other than 0 follow the instructions provided for each case and repeat automatic phasing.
		27	SD card error [FAIL] 	Condition: this condition may occur when sending data from the drive to the SD card or from the SD card to the drive. It could be due to a memory card that is incompatible or not present.	
0000H-0	Communication error Solution: Check the memory card being used				
28	Fw update failed [FAIL] 	Condition: When updating the firmware, check whether the file is in the wrong format or corrupt. Solution: try again with a correct file.			

Note!

For any messages that are displayed but not included in this list, reference should be made to the manual for the application used by the drive.

A.1 - Inserting expansion cards

- **Slot 1:** dedicated to I/O cards (EXP-IO-...-ADP)
- **Slot 2:** dedicated to encoder expansion cards (EXP-RES-ADP, EXP-DE-ADL, etc.)

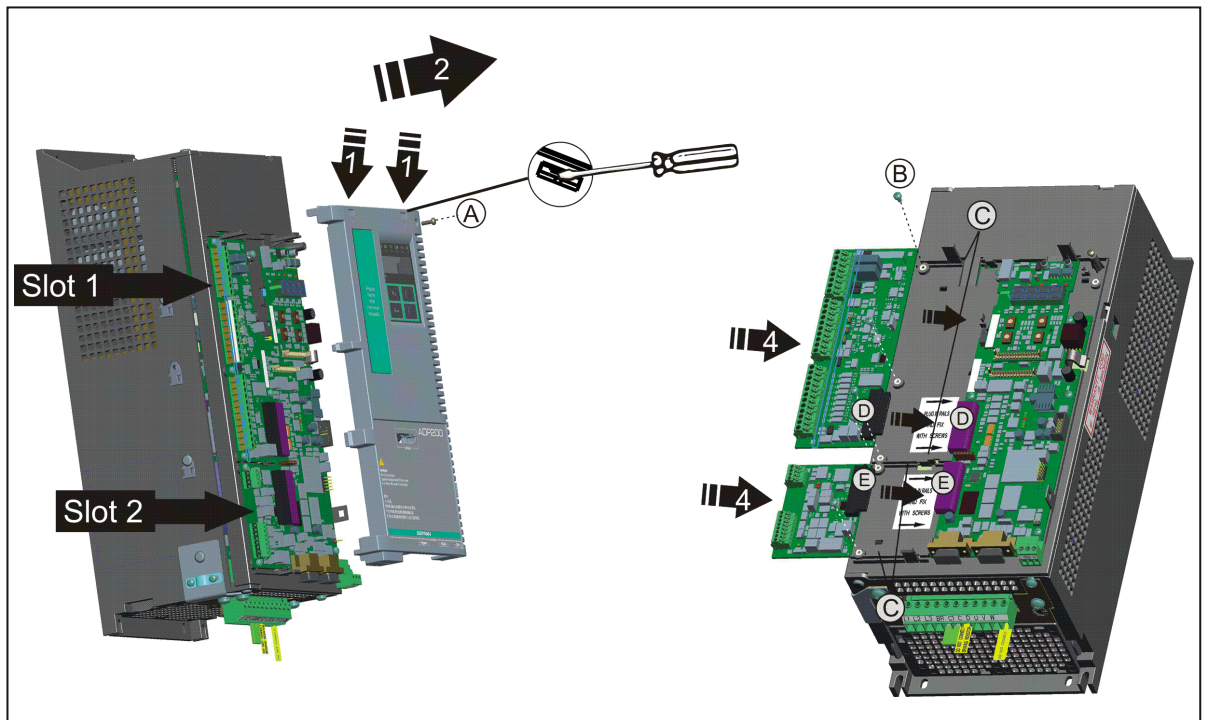

1. Remove the top cover: unscrew and remove the screw (A), insert a screwdriver into the holes at the top of the plastic card cover and push gently
2. Raise the cover as shown in the figure.
3. *To replace an expansion card, loosen the screws (B) and remove the card to be replaced.*
- 4A. Insert the EXP-IO-...-ADP card in the guide bars (C) of Slot 1 until the male terminal (D) is fully inserted in the female terminal (D) of the regulation card.
- 4B. Insert the Encoder card in the guide bars (C) of Slot 2 until the male terminal (E) is fully inserted in the female terminal (E) of the regulation card.
5. Tighten the screws (C) provided with the card.

Note!

.....
In case of replacing of an I/O or encoder expansion card with another card of different type, see the configuration procedure on ADP200 Functions description and parameters list manual, 4 – DRIVE CONFIG menu, PAR 6150 **EXP card type recog.**
.....

A.2 - I/O Card

- **EXP-IO-D8A4R2-ADP**

6 digital inputs (DI) + 1 Enable input (EN-HW) + 2 digital outputs (DO) + 3 analog inputs (AI) + 1 analog output (AO) + 2 relay outputs (RO) + 1 motor protection input (MO), Screw terminals.

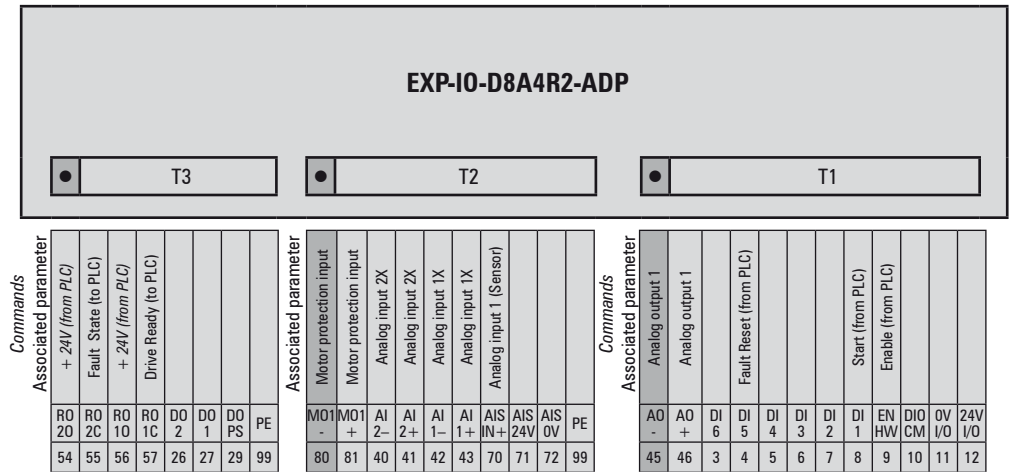

- **EXP-IO-D8A4R2-SM-ADP**

6 digital inputs (DI) + 1 Enable input (EN-HW) + 2 digital outputs (DO) + 3 analog inputs (AI) + 1 analog output (AO) + 2 relay outputs (RO) + 1 motor protection input (MO), Spring-cage terminals.

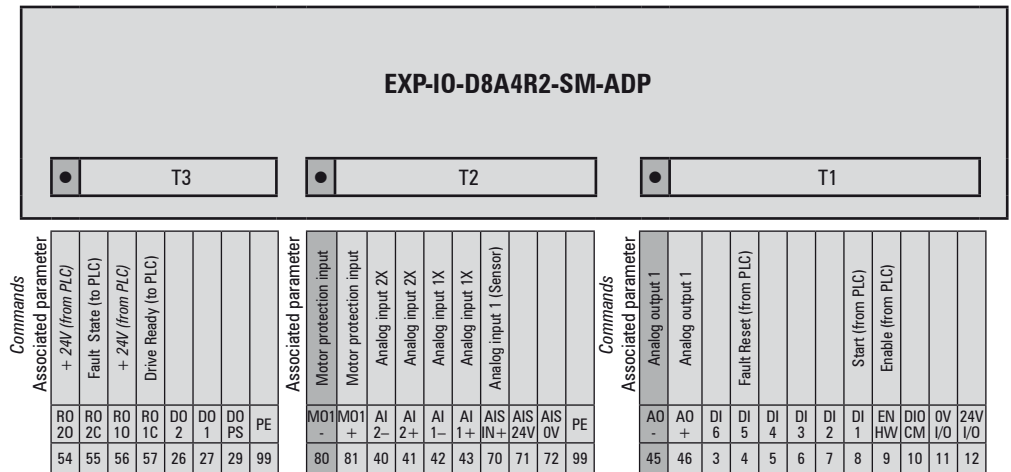

A.2.1 Input/Output features

24V DC power supply	
Tolerance	± 10%
Maximum output current	150 mA
Isolation	1 KV
External supply (*)	1A / 24V ± 10%

Note!

(*) Only for ADP200-...-24 models (24 Vdc external power supply included), see chapter "2.4 Product identification".

- **Digital inputs (DI) and enable hardware input (EN-HW)**

Description	Features
Type	24 V PNP / NPN
Operating voltage	0 V to + 24 V (+ 30 V max)
Load	5 mA @ +24 V - R _L = 4.7 kΩ
Thresholds	V _{IC} < 5 V - V _{IH} > 15 V
Isolation	Yes - Functional (> 1 kV)

- **Digital outputs (DO)**

Description	Features
Type	24V PNP / NPN
Operating voltage	0V to + 24V (+ 30V max)
Load	20mA @ +24V - R _L = 1,2 kΩ (40mA max)
Thresholds	V _{OL} < 1V - V _{OH} > V _{AL} -1
Isolation	Yes - Functional (> 1 kV)

- **Relay outputs (RO)**

Description	Features
Type	NO Relay (single contact)
Operating voltage	250 VAC / - 30 VDC / 2 A
Load	50 mA @ + 10 V
Isolation	Yes - 4 kV

- **Analog inputs (AI)**

Description	Features
Type	Voltage differential
Input voltage	± 10 V (± 12.5 V full scale)
Input R	10 kΩ
Resolution	12 Bits (11 + sign)
Precision	1% of full scale
Isolation	NO

Description	Features
Type	Current differential
Input current	0 (4) mA to 20 mA
Input R	500 Ω
Resolution	12 Bits (11 + sign)
Precision	1% of full scale
Isolation	NO

(*) Select input V/I (V=OFF, I=ON)

- **Selection of Voltage/Current at analog inputs / output and Pressure sensor**

In addition to programming the parameter (PAR 1602 - 1652 - 1898) the position of switches P3-P4-P5 on the I/O card must also be checked.

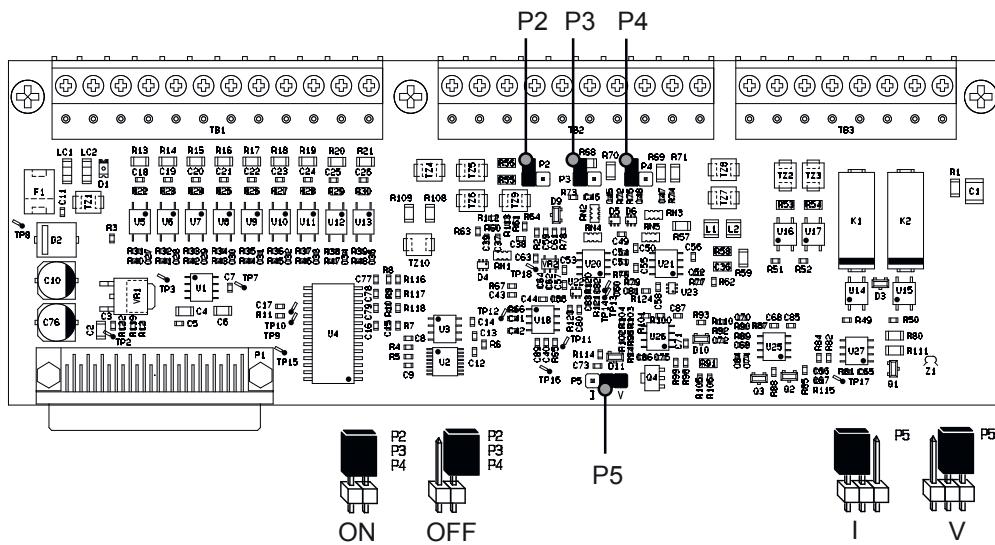

Jumper (I/O card)				Parameter combination	
P2	AIS : Pressure sensor input	ON = I	OFF = V	1502	Analog inp 1 type
P3	AI1: Analog input	ON = I	OFF = V	1602	Analog inp 1X type
P4	AI2: Analog input	ON = I	OFF = V	1652	Analog inp 2X type
P5	AO: Analog output	See figure		1898	Analog out 2X type

- **Analog output (AO)**

Description	Features
Type	Single-ended in voltage
Output voltage	-10V to 10V o 0,1 to 10V (HW Release IO card =D) -10V to 10V o 0,1 to 10V o ±10V (HW Rel. IO card = G)
Load	5 mA @ ± 10 V - R _L = 2.2 kΩ
Resolution	12 Bits
Precision	1% of full scale
Isolation	NO
Description	Features
Type	Single-ended in current (only output 2)
Output current	0 (4) mA to 20 mA
R load	500 Ω
Resolution	12 Bits
Precision	1% of full scale
Isolation	NO

- **Pressure sensor input (AIS)**

Description	Features
Type	Voltage differential
Input voltage	0 to 10 V or 0.1 to 10.1 V (3 wires)
Input R	10 kΩ
Resolution	12 Bits
Precision	1% of full scale
Isolation	NO
Description	Features
Type	Current differential
Input current	0 (4) mA to 20 mA
Input R	500 Ω
Resolution	12 Bits
Precision	1% of full scale
Isolation	NO

- **Motor temperature sensor (MOT)**

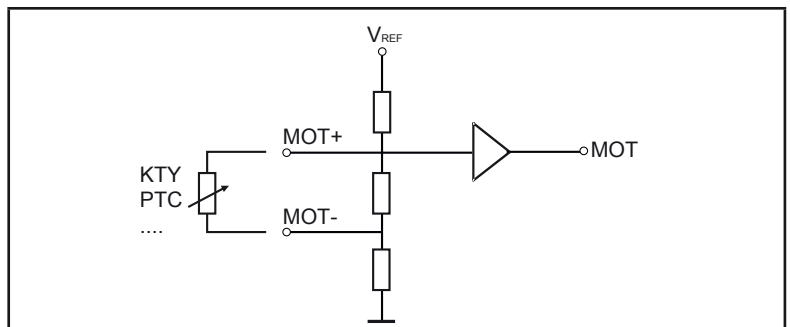

A.3 Encoders and encoder expansion cards

A.3.1 Encoders

Encoders provide motor speed and position feedback.

The regulation algorithms in the ADP200 drive are capable of controlling permanent magnet synchronous (brushless) motors. With brushless motors the regulation algorithm needs an encoder that also allows the absolute motor position to be verified.



.....
The standard ADP200 drive supports resolver encoders managed via the standard encoder card. The type of encoder that is connected must be selected via software: PAR 2132 Encoder 1 mode (menu 15 - ENCODER CONFIG).

Selecting the transformation ratio via jumper.

.....

The drive ADP200 supports different types of encoders, each managed by a specific expansion card. The card is automatically recognised at startup.

Possible configurations are summarised in the table:

Encoder type	Card	PAR 532, Slot2 card type	Brushless	
			Flux Vector CL	PAR 552 – Regulation mode
Resolver	EXP-RES-I1-ADP EXP-RES-I1-S-ADP (EXP-RES-I1R1-ADP)	Enc 6	Default	
Incremental Digital	EXP-DE-I1R1F2-ADL	Enc 1	Possible	
Incremental sinusoidal	EXP-SE-I1R1F2-ADL	Enc 2	Possible	
Incremental sinusoidal + absolute SinCos	EXP-SESC-I1R1F2-ADL	Enc 3	Recommended	
Incremental sinusoidal + Absolute Endat/SSI	EXP-EN/SSI-I1R1F2-ADL	Enc 4	Recommended	
Incremental sinusoidal + Hiperface absolute	EXP-HIP-I1R1F2-ADL	Enc 5	Recommended	

Encoders must be fitted to the motor shaft using anti-backlash couplings.

For electrical connections always use good quality cables with shielded twisted pairs, according to the procedures and specifications described in the following paragraphs.

The configuration parameters for each encoder can be found in the ENCODER CONFIG.

In the event of an encoder malfunction the drive generates the **Speed fbk loss** alarm and the cause of the malfunction is shown in parameter 2172 **SpdFbkLoss code**.

If the encoder is not used by the regulation algorithm the drive still manages the encoder position reading but does not generate an alarm in case of malfunctioning.

A.3.2 Phasing

In order for the ADP200 Brushless regulation algorithm to function correctly, it is necessary to know the position of the rotor with respect to the stator power phases. Therefore the 0° position provided by the absolute encoder must be known with respect to the position of a motor pole and the encoder count direction must match the motor power phases.

This is called phasing. Phasing can be performed manually, directly by means of the mechanical encoder assembly position on the motor shaft and on the phases, or using the automatic procedures available in the drive.

Phasing must always be repeated whenever:

- the encoder assembly position is changed
- the phase sequence of the motor power supply connection is changed
- the encoder incremental signal connection is changed
- the encoder absolute signal connection is changed
- the value of the PAR 2008 **Pole pairs** parameter is changed
- the value of the PAR 2100 **Encoder 1 pulses** parameter is changed
- the drive is replaced (alternatively, download parameters taken from previous drive)

There are two different procedures that can be launched by writing two different parameters:

- PAR 2190 **Autophase rotation** -> rotation phasing:
this procedure must be performed with the motor free to turn and with no load applied.
- PAR 2192 **Autophase still** -> static phasing:
this procedure must be performed with the motor still and brake applied.

Rotation phasing

This procedure is based on the possibility of moving the motor, by a maximum angle of two pole pairs, to find correct encoder phasing, cross-check the available encoder and motor data and, if the encoder count direction does not match the phase sequence of the motor power supply, correct it by automatically modifying PAR 2130 **Encoder 1 direction**.

Note!

~~~~~  
In the case described above, a positive speed reference could generate a rotation in reverse with respect to that defined as positive for the encoder (usually clockwise), while still ensuring good motor control.  
~~~~~

The encoder direction defined as positive can be stored as the positive reference direction by inverting two motor power phases and repeating the rotation phasing procedure.

If the procedure is terminated without any errors, code 0 is shown on the keypad, otherwise if any differences have been detected that cannot be corrected by the drive, one of the codes listed in Autotune (phasing), [see chapter 10.3 Messages](#), is shown.

Possible faults:

- faults in electric signals not detected with a "**Speed fbk loss [22]**" alarm
- error in the PAR 2008 **Pole pairs** parameter setting
- error in the PAR 2100 **Encoder 1 pulses** parameter setting.

Static phasing

Using this method, in which the motor cannot move, the encoder and motor data cannot be cross-checked to verify the matching of parameters or count direction.

This condition must therefore be checked before launching the procedure.

A.3.3 Encoder cards

Note

The encoder power supply must be adequate considering the cable length and the absorption rates as shown in table (1) at the end of this chapter.

EXP-RES-I1-ADP

Resolver Encoder (RES).

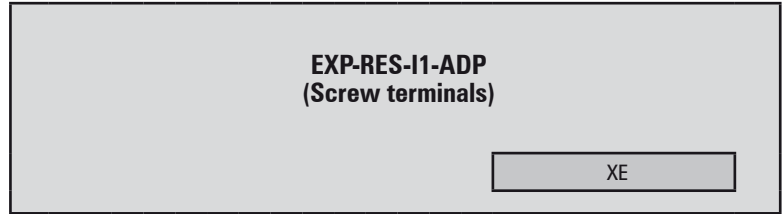

EXC-	EXC+	COS-	COS+	SIN-	SIN+		
8	9	10	11	12	13	14	15

- Channels _____ Exc+ Exc-, Cos+ Cos-, Sin+ Sin-
- No. of Poles _____ 1 - 5
- Max speed _____ 7500 rpm
- Excitation Voltage _____ Automatic setting (5.6V rms max, default 2.3 Vrms)
- Current _____ 50mA rms max
- Resolver excitation frequency _____ 2...10KHz (selectable through drives parameter / step of 250Hz, default 5 kHz)
- Transformation Ratio _____ 0.2...1.0 (selected by jumper, see table below. Default 0.5)
- Resolution _____ Equivalent of 16 bits max in one revolution of electrical resolver turn (selectable through parameters: 10-12-14-16)
- Output impedance for the resolver excitation _____ >20Ω
- Resolver Excitation power supply _____ Internal 5V
- Resolver input _____ sinusoidal differential
- Resolver input voltage _____ 1.1 Vrms typ – 1.4 Vrms max
- Resolver input impedance _____ 3kΩ
- Cable length _____ max 50m, shielded coupled plus a total external shield.

RESOLVER ENCODER (RES)

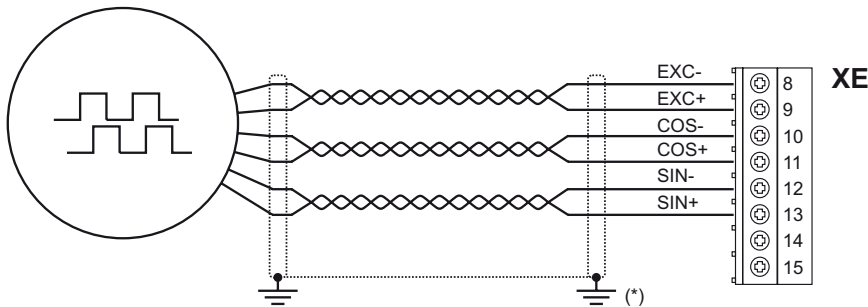

(* Connection of shielding, see figure 7.2.4

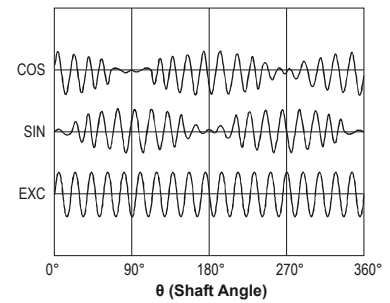

Electrical resolver representation

Resolver T ratio setting

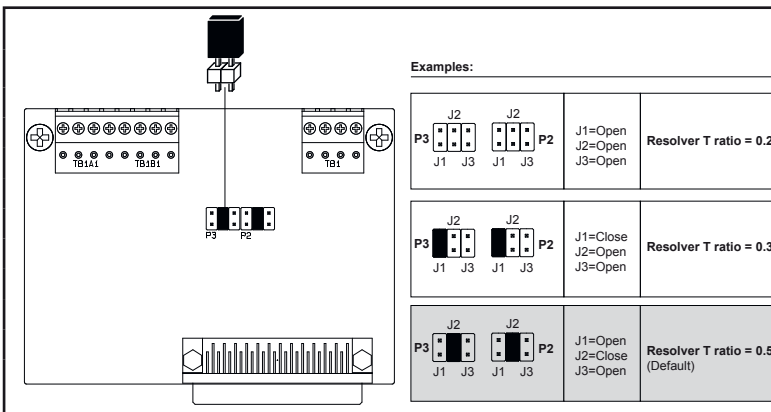

Resolver T ratio [K]	Jumpers P2 / P3			EXC		SIN / COS	
	J1	J2	J3	[Vpp]	[Vrms]	[Vpp]	[Vrms]
0.2	open	open	open	19.3	6.8	3.8	1.3
0.3	close	open	open	13.2	4.7	3.9	1.4
0.4	open	close	open	7.8	2.8	3.1	1.1
0.5	open	close	open	7.8	2.8	3.9	1.4
0.6	close	close	open	6.5	2.3	3.9	1.4
0.7	close	close	open	6.5	2.3	4.6	1.6
0.8	open	open	close	3.9	1.4	3.1	1.1
0.9	open	open	close	3.9	1.4	3.5	1.2
1.0	open	open	close	3.9	1.4	3.9	1.4

Voltage levels measured on the terminals.
The indicated levels are typical with a tolerance of ±10%.

EXP-RES-I1-S-ADP

Resolver Encoder (RES).

EXP-RES-I1-S-ADP
(Spring-cage terminals)

XE

EXC-	EXC+	COS-	COS+	SIN-	SIN+
8	9	10	11	12	13

Channels _____	Exc+ Exc-, Cos+ Cos-, Sin+ Sin-
No. of Poles _____	1 - 5
Max speed _____	7500 rpm
Excitation Voltage _____	Automatic setting (5.6V rms max, default 2.3 Vrms)
Current _____	50mA rms max
Resolver excitation frequency _____	2...10KHz (selectable through drives parameter / step of 250Hz, default 5 kHz)
Transformation Ratio _____	0.2...1.0 (selected by jumper, see table below. Default 0.5)
Resolution _____	Equivalent of 16 bits max in one revolution of electrical resolver turn (selectable through parameters: 10-12-14-16)
Output impedance for the resolver excitation _____	> 20Ω
Resolver Excitation power supply _____	Internal 5V
Resolver input _____	sinusoidal differential
Resolver input voltage _____	1.1 Vrms typ – 1.4 Vrms max
Resolver input impedance _____	3kΩ
Cable length _____	max 50m, shielded coupled plus a total external shield.
Terminals _____	Spring-cage and metal guide for terminal insertion.

RESOLVER ENCODER (RES)

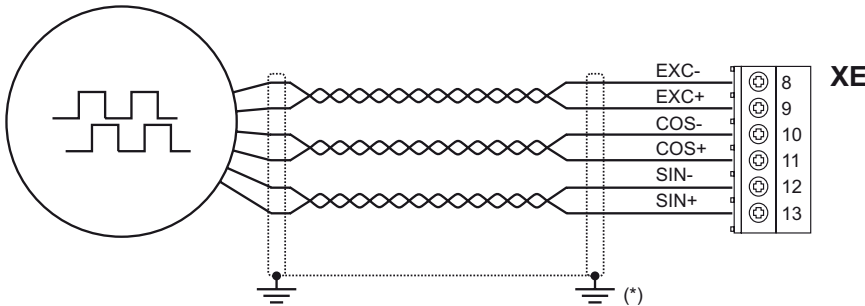

(*) Connection of shielding, see figure 7.2.4

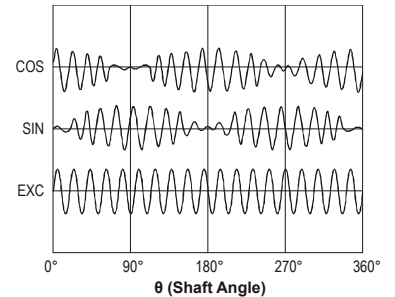

Electrical resolver representation

Resolver T ratio setting

Examples:

	Resolver T ratio = 0.2
	Resolver T ratio = 0.3
	Resolver T ratio = 0.5 (Default)

Resolver T ratio [K]	Jumpers P2 / P3			EXC		SIN / COS	
	J1	J2	J3	[Vpp]	[Vrms]	[Vpp]	[Vrms]
0.2	open	open	open	19.3	6.8	3.8	1.3
0.3	close	open	open	13.2	4.7	3.9	1.4
0.4	open	close	open	7.8	2.8	3.1	1.1
0.5	open	close	open	7.8	2.8	3.9	1.4
0.6	close	close	open	6.5	2.3	3.9	1.4
0.7	close	close	open	6.5	2.3	4.6	1.6
0.8	open	open	close	3.9	1.4	3.1	1.1
0.9	open	open	close	3.9	1.4	3.5	1.2
1.0	open	open	close	3.9	1.4	3.9	1.4

Voltage levels measured on the terminals.
The indicated levels are typical with a tolerance of ±10%.

EXP-RES-I1R1-ADP

Resolver Encoder (RES) + Repetition.

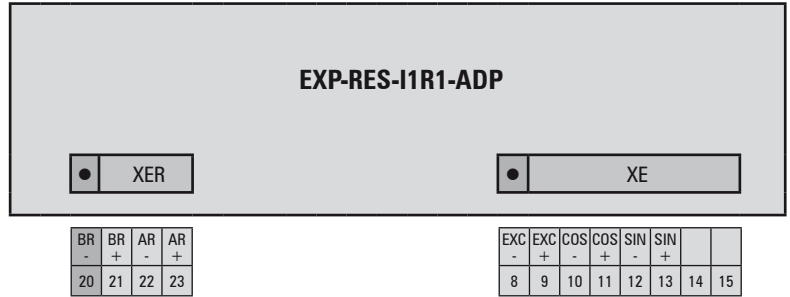

- Channels _____ Exc+ Exc-, Cos+ Cos-, Sin+ Sin-
- No. of Poles _____ 1 - 5
- Max speed _____ 7500 rpm
- Excitation Voltage _____ Automatic setting (5,6V rms max, default 2.3 Vrms)
- Current _____ 50mA rms max
- Resolver excitation frequency _____ 2...10KHz (selectable through drives parameter / step of 250Hz, default 5 kHz)
- Transformation Ratio _____ 0.2...1.0 (selected by jumper. See table (1), end of this chapter, default 0.5)
- Resolution _____ Equivalent of 16 bits max in one revolution of electrical resolver turn (selectable through parameters: 10-12-14-16)
- Output impedance for the resolver excitation _____ >20Ω
- Resolver Excitation power supply _____ Internal 5V
- Resolver input _____ sinusoidal differential
- Resolver input voltage _____ 1.1 Vrms typ – 1.4 Vrms max
- Resolver input impedance _____ 3kΩ
- Cable length _____ max 50m, shielded coupled plus a total external shield.

RESOLVER ENCODER (RES)

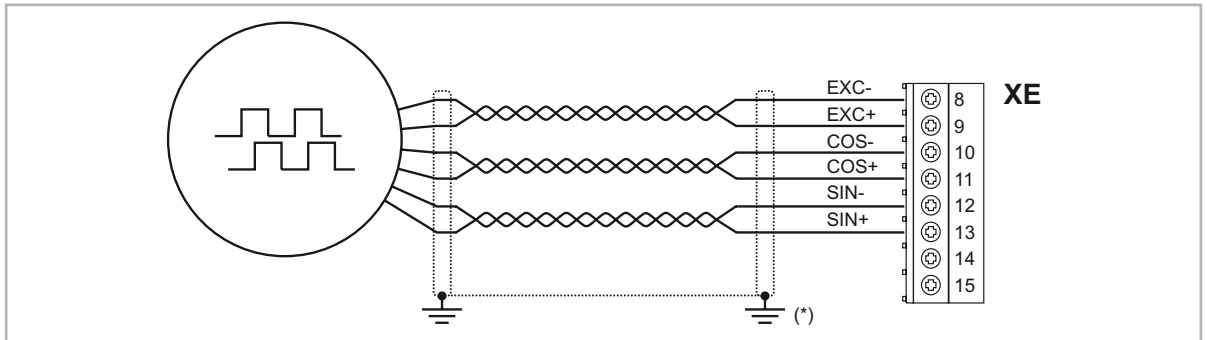

(*) Connection of shielding, see figure 7.2.4

Note!

Repeat Encoder see end of this chapter.

EXP-DE-I1R1F2-ADL

Digital Incremental Encoder.

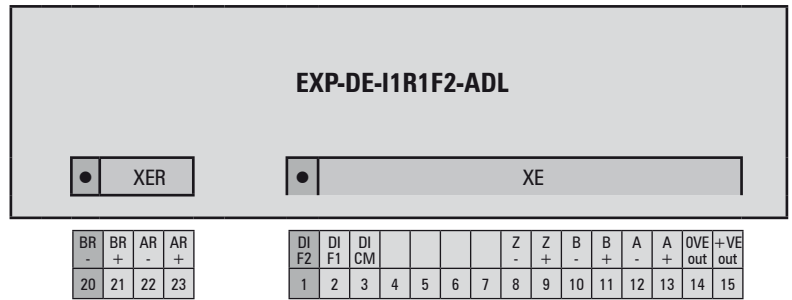

(TTL Line-driver)

Channels _____	A+ A-, B+ B-, Z+ Z-, differential line drivers, optoisolated.
Max frequency _____	200 kHz (check the number of encoder impulses according to the maximum speed)
Number of impulses _____	min 128, max 16384 (default 1024)
Electrical interface _____	TTL (ref. GND) Ulow ≤ 0.5 V Uhigh ≥ 2.5 V
Load capacity _____	10 mA @ 5.5 V (Zin 365Ω)
Programmable internal power supply _____	min +5.2 V, max +6.0 V (default + 5.2 V) – I _{max} 150 mA.
Cable length _____	See table (1) max 50m

INCREMENTAL DIGITAL ENCODER (DE) PUSH-PULL/LINE DRIVER

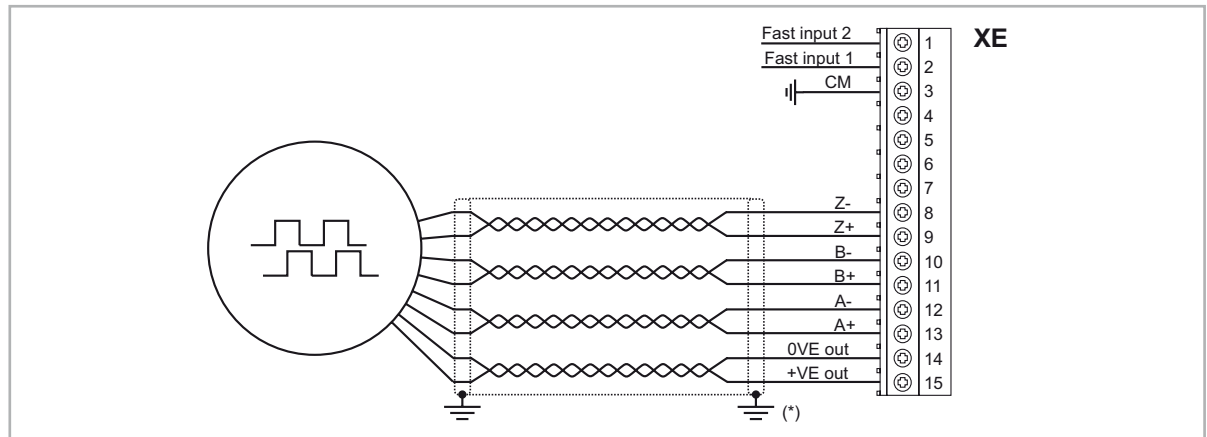

(*) Connection of shielding, see figure 7.2.4

(TTL/HTL push-pull)

Channels _____	A/B/Z, complementary push-pull, optoisolated.
Max frequency _____	100 kHz (check the number of encoder impulses according to the maximum speed)
Number of impulses _____	min 128, max 16384 (default 1024)
Electrical interface _____	HTL Ulow ≤ 3.0 V Uhigh ≥ V _{enc} - 3.0 V
Load capacity _____	7 mA @ 20.0 V (Zin 2635Ω)
V max Digital Inputs (*) _____	HTL = 27V max. TTL = 7V max
Programmable internal power supply _____	min +6.0 V, max +20.0 V (default + 6.0 V) – I _{max} 150 mA.
Cable length _____	See table(1) max 50m

(*) with external supply.

INCREMENTAL DIGITAL ENCODER (DE) SINGLE ENDED NPN O.C.

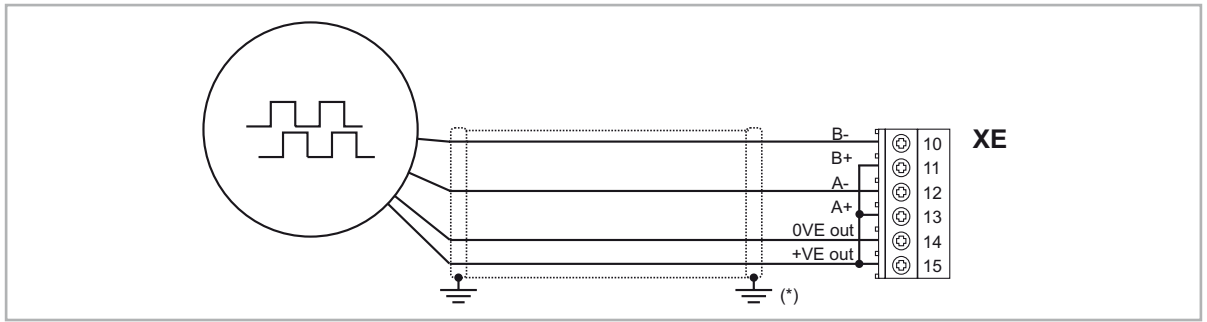

INCREMENTAL DIGITAL ENCODER (DE) SINGLE ENDED PNP O.C.

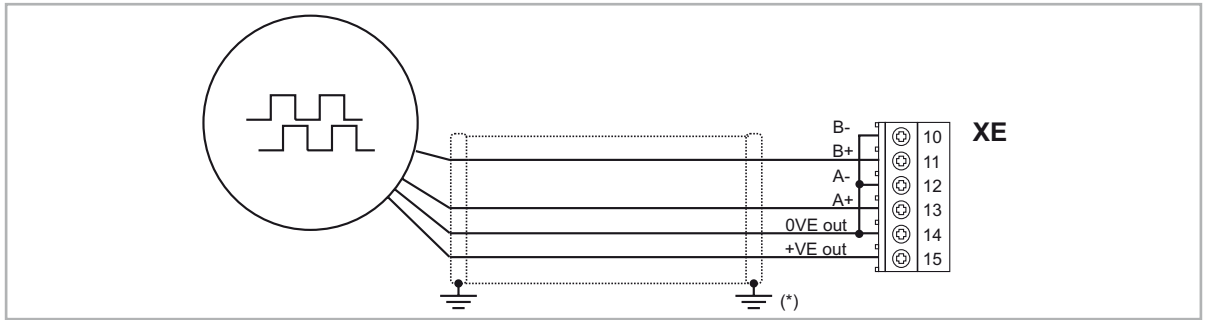

(*) Connection of shielding, see figure 7.2.4

EXP-SE-I1R1F2-ADL

Incremental Sinusoidal Encoder (SE).

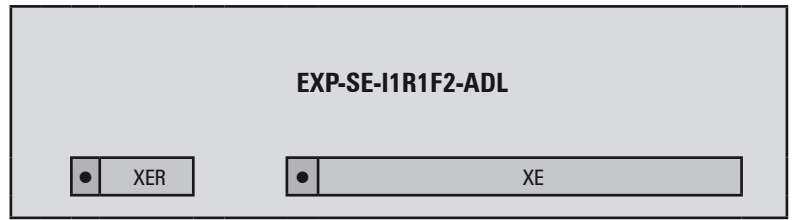

BR	BR	AR	AR
-	+	-	+
20	21	22	23

DI	DI	DI					Z	Z	B	B	A	A	0VE	+VE
F2	F1	CM					-	+	-	+	-	+	out	out
1	2	3	4	5	6	7	8	9	10	11	12	13	14	15

Channels _____ A+ A-, B+ B-, Z+ Z-, differential.
 Management of loss of encoder signals
 Max frequency _____ 200 kHz (check the number of encoder impulses according to the maximum speed)
 Number of impulses _____ min 128, max 16384 (default 1024)
 Electrical interface _____ Channels A/B $0,8V \leq V_{pp} \leq 1,2V$ (typ. 1,0V) – Channel Z $0,2V \leq V_{pp} \geq 0,8V$
 Load capacity _____ 8mA @ 1.0Vpp (Zin 120Ω)
 Programmable internal power supply _____ min +5.2 V, max +6.0 V (default + 5.2 V) – I_{max} 150 mA.
 Cable length _____ See table (1)
 _____ max 50m

INCREMENTAL SINUSOIDAL ENCODER (SE)

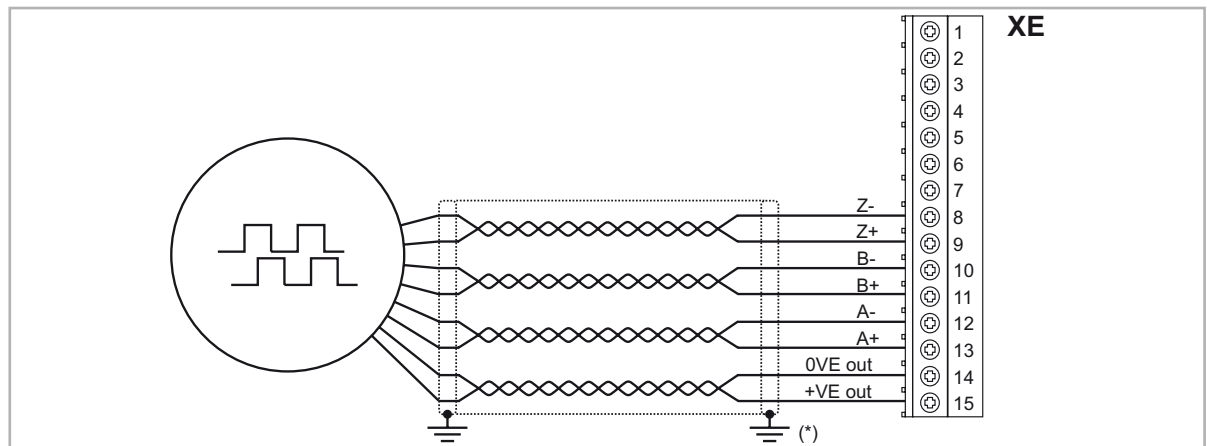

(*) Connection of shielding, see figure 7.2.4

EXP-SESC-I1R1F2-ADL

Incremental Sinusoidal Encoder + absolute SinCos (SESC).

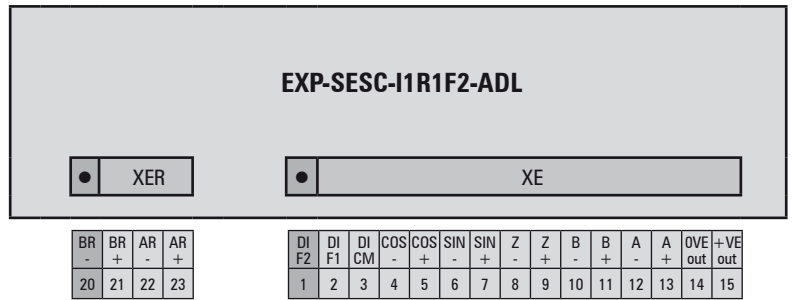

- Channels _____ A+ A-, B+ B-, Z+ Z-, Cos+ Cos-, Sin+ Sin-, differential
 Management of loss of encoder signals.
- Max frequency _____ 200 kHz (check the number of encoder impulses according to the maximum speed)
- Number of impulses _____ min 128, max 16384 (default 1024)
- Electrical interface _____ Channels A/B/Sin/Cos $0.6\text{ V} \leq V_{pp} \leq 1.2\text{ V}$ (typ. 1.0 V) – Channel I $0.2\text{ V} \leq V_{pp} \leq 0.8\text{ V}$
- Load capacity _____ Channels A/B/I 8 mA @ 1.0 Vpp (Zin 120Ω)
 Channels Sin/Cos 1 mA @ 1.0 Vpp (Zin 1kΩ)
- Programmable internal power supply _____ min +5.2 V, max +6.0 V (default + 5.2 V) – I_{max} 150 mA.
- Cable length _____ See table (1)
 max 50m

INCREMENTAL SINUSOIDAL ENCODER + ABSOLUTE SINCOS (SESC)

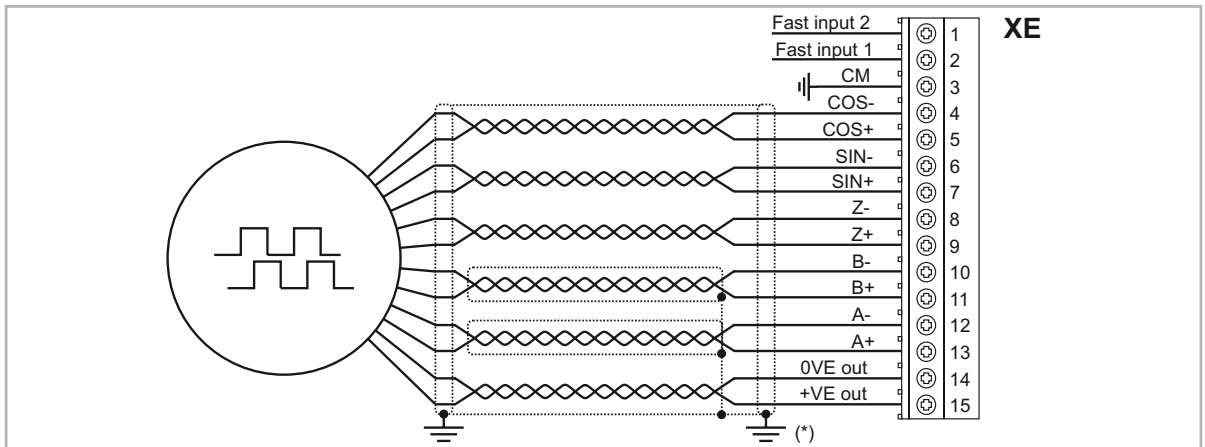

(*) Connection of shielding, see figure 7.2.4

EXP-EN/SSI-I1R1F2-ADL

Incremental sinusoidal + Absolute EnDat/SSI (EN/SSI).

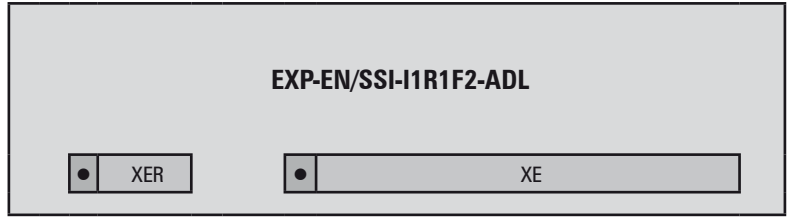

BR -	BR +	AR -	AR +
20	21	22	23

DI F2	DI F1	DI CM	DT -	DT +	CK -	CK +	Z -	Z +	B -	B +	A -	A +	0VE out	+VE out
1	2	3	4	5	6	7	8	9	10	11	12	13	14	15

- Channels _____ A+ A-, B+ B-, differential
Management of loss of encoder signals.
- Max frequency _____ 200 kHz (check the number of encoder impulses according to the maximum speed)
- Number of impulses _____ min 128, max 16384 (automatic recognition at initialisation)
- Electrical interface _____ $0.6\text{ V} \leq V_{pp} \leq 1.2\text{ V}$ (typ. 1.0 V)
- Load capacity _____ 8 mA @ 1.0 Vpp (Zin 120Ω)
- Programmable internal power supply _____ min +5.2 V, max +6.0 V (default + 5.2 V) – I_{max} 150 mA.
See table (1)
- Cable length _____ max 50m (see encoder cable length section)

- Absolute channels _____ CK+ CK-, DT+ DT- differential, RS-485
Management of loss of encoder signals.
- Interface _____ EnDat: 2.1/2.2 single/multi-turn (command set managed only compatible with 2.1)
SSI: Standard Sick/Stegman single/multi-turn
- Max frequency _____ EnDat: 1 MHz with delay compensation (not programmable)
SSI: 400 KHz (not programmable)
- Number of bits _____ EnDat: max 32 bit/turn* max 32bit/turn (automatic recognition at initialisation)
SSI: 13-25 bits (default 25)

Incremental sinusoidal + Absolute EnDat/SSI (EN/SSI)

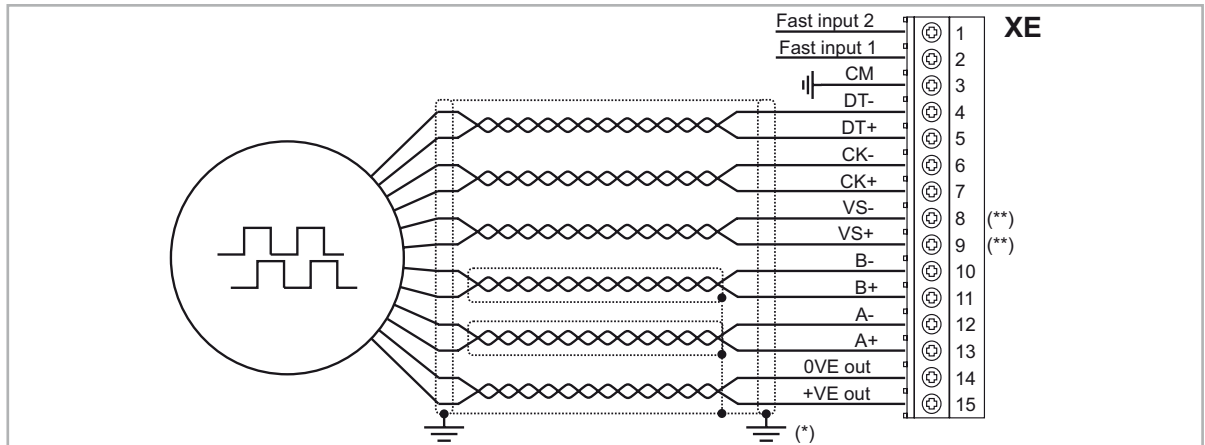

(*) Connection of shielding, see figure 7.2.4
(**) VS+ / VS- : optional (encoder supply feedback)

EXP-HIP-I1R1F2-ADL

Incremental Sinusoidal Encoder + Hiperface absolute (HIP)

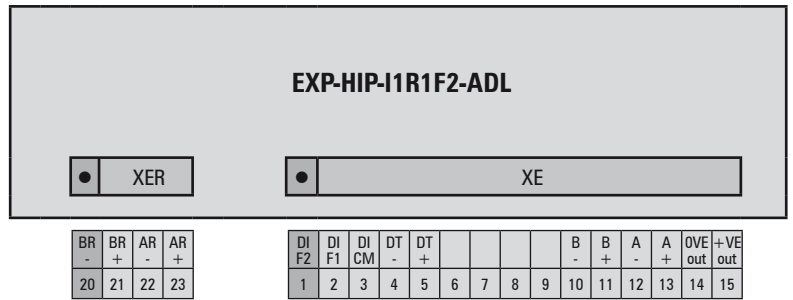

- Incremental channels _____ A+ A-, B+ B-, differential
 Management of loss of encoder signals.
- Max frequency _____ 200 kHz (check the number of encoder impulses according to the maximum speed)
- Number of impulses _____ min 128, max 16384 (automatic recognition at initialisation)
- Electrical interface _____ $0,8V \leq V_{pp} \leq 1,2V$ (typ. 1,0V)
- Load capacity _____ 8mA @ 1.0Vpp (Zin 120Ω)
- Programmable internal power supply _____ +7.0V / +8,0V / +12.0V
- Cable length _____ See table (1)
 max 50m
- Absolute channels _____ DT+ DT- differential, RS-485
 Management of loss of encoder signals.
- Interface _____ Standard Sick/Stegman single/multi-turn
- Max frequency _____ 9600baud (not programmable)
- Number of bits _____ max 32 bit/turn* max 32bit/turn (automatic recognition at initialisation)

INCREMENTAL SINUSOIDAL ENCODER + ABSOLUT HIPERFACE (HIP)

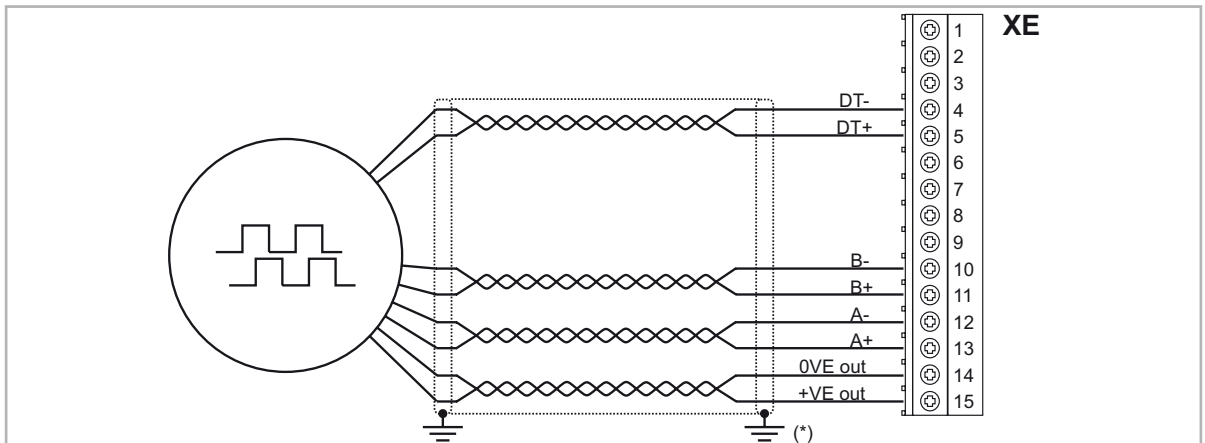

(*) Connection of shielding, see figure 7.2.4

Repeat Encoder RE (TTL/HTL line-driver)

Encoder expansion cards have an incremental encoder output with TTL/HTL Line Driver levels (according to the main encoder supply) to be used to repeat the servomotor feedback device. This function is performed via HW and an encoder output can be repeated with a programmable divider. The encoder output signals are available on the XER connector:

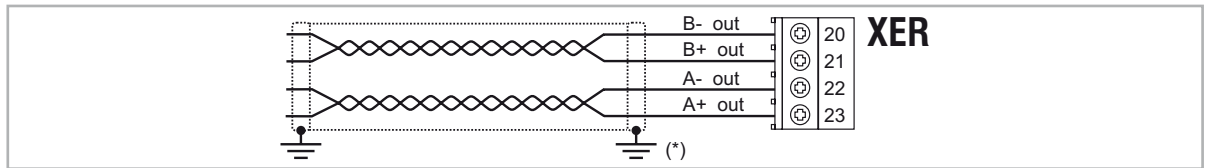

(*) Connection of shielding, see figure 7.2.4

Channels _____	A+ A-, B+ B-, differential line drivers, optoisolated.
Max frequency _____	200 kHz
Number of impulses _____	1/1-1/2-1/4-1/8 repeat (default 1/1)
Electrical interface _____	TTL (ref. GND) Ulow ≤ 0.5 V Uhigh ≥ 2.5 V HTL Ulow ≤ 3.0 V Uhigh ≥ Venc - 3.0 V (only with DE encoder)
Load capacity _____	TTL 20mA @ 5,5V (Zin 120Ω) for each channel HTL 50mA max. for each channel .
Power supply _____	Venc (encoder signals are repeated on the same value of the primary encoder), the supply value for the repeat is always that set for the primary encoder.
Cable length _____	max 50m

- (1) The internal power supply of the encoder can be selected from the keypad (ENCODER CONFIG menu, parameter **Encoder 1 supply** (PAR 2102) to balance the loss of voltage due to the length of the encoder cable and load current, minimum step 0.1 V

Internal power supply of the encoder			
Encoder option type	Def	Min	Max
Enc 1	5.2 V	5.2 V	20.0 V
Enc 2	5.2 V	5.2 V	6.0 V
Enc 3	5.2 V	5.2 V	6.0 V
Enc 4	5.2 V	5.2 V	10.0 V
Enc 5	8.0 V	7.0 V	12.0 V
Enc 6	(*)	-	-

(*) The encoder repetition of Resolver expansion card is always TTL.

QS + Quick Start Manual

Series: ADP200

Revision: 1.6

Date: 15-12-2022

Code: 1S9PQSEN

WEG Automation Europe S.r.l.

Via Giosuè Carducci, 24

21040 Gerenzano (VA) · Italy