

# CFW11 - VARIABLE SPEED DRIVE

High productivity and performance for your business





STATUS

USB



VECTRUE INVERTER

CFW-11

WEG

Run e LOC 1800rpm

1800 rpm

17.1 A

60.0 Hz

08:12 | Menu

Buttons: Stop (red O), Jog (blue JOG), Loc Rem (blue LOC/REM), Run (green I), Stop (grey square), Forward (grey triangle), Reverse (grey inverted triangle), Stop (grey circle with C), Stop (grey square with -).

 **WARNING / ATENCION / ATENÇÃO**

- REMOVE TERMINAL COVER ONLY 10MIN. AFTER POWER HAS BEEN DISCONNECTED.
- READ THE INSTRUCTION MANUAL.
- SOLAMENTE RETIRE LA TAPA FRONTAL LUEGO DE 10 MIN. DE DESENERGIZADO EL EQUIPO.
- VER MANUAL DE INSTRUCCIONES.
- SOMENTE REMOVA A TAPA APÓS 10 MINUTOS DE DESENERGIZADO O EQUIPO.

# CFW11

## Variable Speed Drive

### Table of Contents

Introduction	04
Benefits	05
Unique WEG Technology	06
Human-Machine Interface	08
Built-in SoftPLC on the Standard Product	10
WPS - WEG Programming Suite	11
Resources	12
Applications	14
Coding	16
Specifications	18
Accessories	24
Optional Items	28
Dimensions and Weights	29
Mechanical Assembly / Panel Mounting	30
Block Diagram	31
Technical Data	33



# CFW11

## Variable Speed Drive for Industrial Systems

### HIGH PRODUCTIVITY AND PERFORMANCE FOR YOUR BUSINESS

The CFW11 is a **high-tech** variable speed drive designed to drive and control three-phase induction motors and WEG WMagnet permanent-magnet motors. It has excellent static and dynamic performance, and highly-precise torque, speed and position control. It can be used in a wide range of applications due to its high overload capacity.

Developed for exclusive use in industrial or professional applications, the CFW11 inverter provides energy savings and greater productivity and quality for the processes where it is used.

#### Power Ranges<sup>1)</sup>

- 1.5 to 2.2 kW - 2 to 3 HP / 200-240 V ac - Single-phase
- 1.1 to 55 kW - 2 to 75 HP / 200-240 V ac - Three-phase
- 1.5 to 630 kW - 2 to 970 HP / 380-480 V ac - Three-phase
- 1.5 to 560 kW - 2 to 850 HP / 500-600 V ac - Three-phase
- 2.2 to 630 kW - 3 to 850 HP / 600-690 V ac - Three-phase

#### Normal Duty (ND)

- 110% for 60 seconds every 10 minutes
- 150% for 3 seconds every 10 minutes

#### Heavy Duty (HD)

- 150% for 60 seconds every 10 minutes
- 200% for 3 seconds every 10 minutes

#### Certifications



*Note: for higher powers, contact WEG Automation or refer to the AFW11M catalog (Drive with Modular Variable Speed Drive).*



## Benefits



### Innovative and Easy to Use

The CFW11 has many useful and convenient functions for the customers, especially because of its simple installation and operation. The CFW11 has been designed based on the plug-and-play technology, which allows a simple and quick installation of the inverter and its accessories. The HMI has a navigation and programming system with soft keys. You can access the parameters sequentially or through parameter groups. The HMI also offers the oriented start-up function that guides the user along the programming.

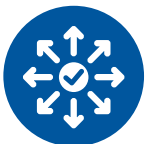

### Flexibility

The CFW11 is adaptable to the customer's needs through a wide range of easy-to-install accessories. In addition, the standard version comes with SoftPLC, allowing the customers to create their own applications using the WLP (Ladder Programming) software application.



### Connectivity

Communication protocols: Modbus-RTU, Modbus-TCP, Profibus-DP-V1, DeviceNet, CANopen, EtherNet/IP, EtherCAT, PROFINET-IO and BACnet.



## Unique WEG Technology

### Vectrue Technology®

#### Several Control Modes

- Scalar V/F linear or adjustable: motor speed control with slip compensation
- VVW - Voltage Vector WEG - voltage vector control: motor speed control with automatic adjustment to the load and grid variations
- Vector sensorless (without encoder) - induction motors: vector torque and speed control with excellent dynamic response, even at low speeds
- Vector with encoder: the encoder module makes the interfaces between the CFW11 and the motor, providing closed-loop position and speed control with excellent accuracy and dynamic response over the entire speed range (even when the motor is stopped)
- Vector WMagnet sensorless (without encoder) and with encoder: vector control with excellent dynamic response for WEG WMagnet motors over the entire speed range

### Optimal Braking®

In applications involving high-inertia loads with reduced deceleration times, a large amount of energy returns from the motor to the variable speed drive. To withstand such energy, the variable speed drive needs to dissipate it through resistors, which generally occupy a large space and are expensive. As an alternative for the braking resistors, the CFW11 has a special braking method in vector control mode known as Optimal Braking®. This innovation provides a high-performance braking torque, eliminating the need for braking resistors. The following chart shows the advantages of the optimal braking in comparison with other braking methods, thus ensuring an optimized, low-cost solution for braking applications.

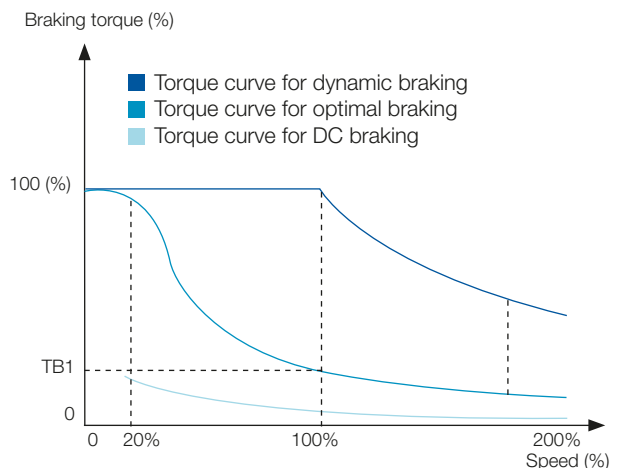

Typical braking torque x speed graph for a 10 HP / 7.5 kW motor driven by a CFW11



#### Optimal Flux®

- Technology for motors driven by variable speed drive in applications with constant torque characteristics
- Rated torque at low speeds, eliminating the need for forced ventilation or motor oversizing
- Reduced space and costs for the application
- Improved motor and inverter set performance (an exclusive WEG solution)
- The Optimal Flux function works when the high efficiency WEG motor + CFW11 configuration is used

#### WMagnet Drive System®

##### CFW11 Variable Speed Drive combined with WEG WMagnet Permanent Magnet Motor

The WMagnet system (WMagnet motor + CFW11) has the highest efficiency level of the market. It is the perfect combination for applications requiring speed variation, low noise level and reduced size. In the Sensorless mode, the WMagnet system can perform torque control at zero speed without the need for forced ventilation.

- Control methods: closed-loop (vector with encoder) and sensorless vector control



## Keypad

The keypad of the CFW11 has been developed to make the interaction with the user simple and fast, providing excellent visibility.

### Interface Tools

- Graphic display with backlight
- Soft Keys for easy operation
- Real time clock (RTC)
- Copy Function
- Plug-in (allows hot swapping)
- Language selection
- Remote keypad



Left soft key: function defined by the text on the display

Selection of direction of rotation

Local/Remote

Right soft key: function defined by the text on the display

Keys to scroll the menus and parameters and to change the content of the parameters

Start key

Stop key

JOG key

### Remote Keypad

The standard keypad is detachable and can be installed on panel doors or machine consoles with IP56 protection rating.



### Backup Parameters

The backup parameter group allows transferring the CFW11 parameters to the keypad or to the flash memory module (available in the standard product) and vice versa. During the CFW11 operation, the modified parameters are automatically saved to the flash memory module.

### Function Group

The HMI displays parameter groups in individual folders, and each of them shows specific settings. For example: I/O setting, auto-tuning procedure, basic parameters, etc.

### Selectable Languages

The user can choose the HMI language: Portuguese, English, Spanish, German or French.

### Changed Parameters

It displays only the parameters that have been programmed differently from the factory default.



The HMI can be configured to display up to four variables simultaneously, in three different modes.

### Status Indication

- Run
- Ready
- Configuration
- Auto-tuning
- Last alarm
- Inverter disabled by fault and fault number

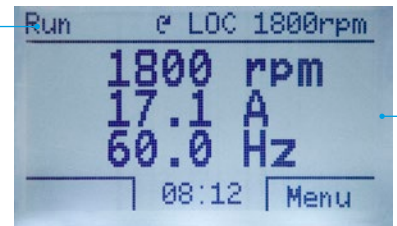

### Local/Remote Indication

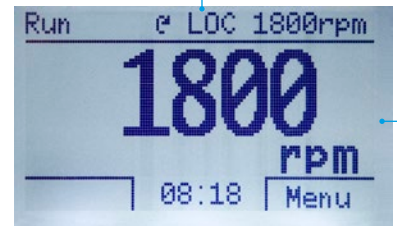

### Direction of Rotation Indication

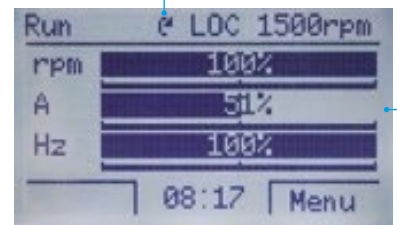

### Basic Application

The Basic Application parameter group contains the basic parameters, whose settings are required in most applications.

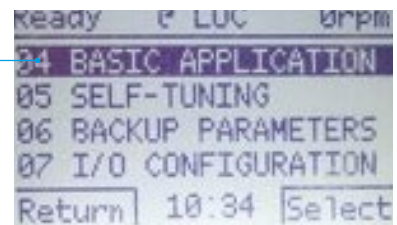

### Fault History

It displays the parameters with the last ten faults, informing the day, month, year and hour of the events.

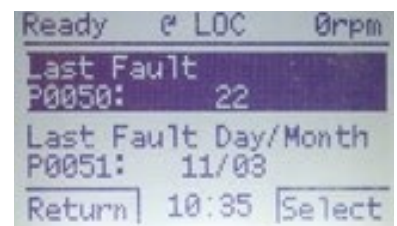

### Reading Parameters

It displays only the inverter monitoring parameters.

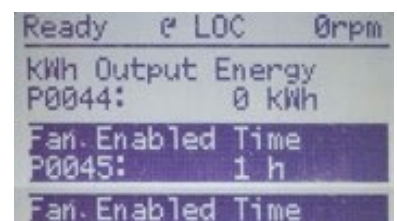

## SoftPLC - Built-In on the Standard Product

Adds the functionality of a PLC to the CFW11, allowing the creation of special applications. The WLP software and the SoftPLC functionality are a smart and simple way to make your CFW11, motor and application work together.

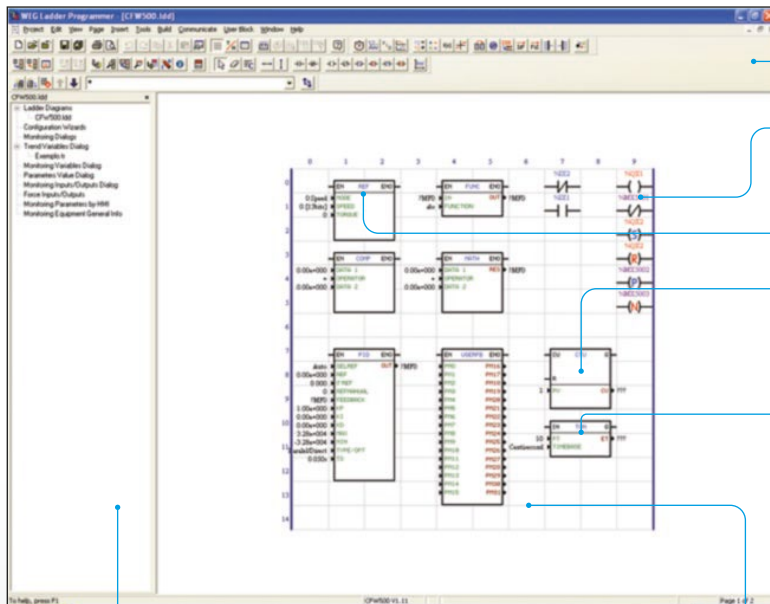

Easy programming: Ladder

Contacts and coils

Speed reference

Comparators and math functions

Counters and timers

Available on the website [www.weg.net](http://www.weg.net)

User block protected by password

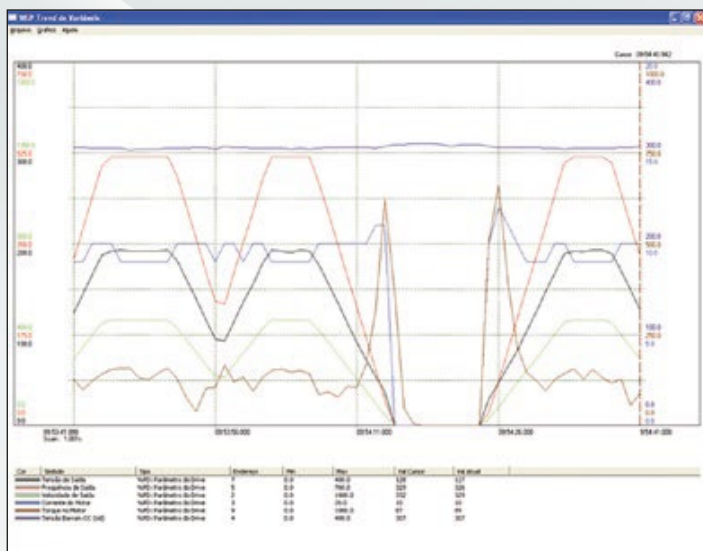

### Trend Function

- Parameter/variable online graphic monitoring
- Configurable in up to six channels



# WPS - WEG Programming Suite

Application to program, control and monitor WEG variable speed drive.



## Trace Function

- It registers the CFW11 variables with activation by events (e.g., alarm, fault, overvoltage), storing the data on the inverter memory, which then can be viewed in the form of graphs.



USB connection

Friendly environment

Available on the website [www.weg.net](http://www.weg.net)

## Resources

### Safety Stop Function - Safe Torque Off (STO)

Enabling the safety stop function assures to stop the driven motor and/or prevents it from being accidentally started which could be an important component of a machine and process safety system.

The STO function can be used in category 3 / PL d applications according to the EN ISO13849-1 standard and SIL 2 according to the IEC62061 and IEC61508 standards.

This is an optional feature and available in versions with the STO function.

### Built-in DC Link Inductor

It allows the inverter to be installed in any network (without minimum impedance restrictions).

Typical power factor (PF) for rated condition:

- 0.94 for models with three-phase power supply
- 0.70 for models with single-phase power supply
- 0.70 for models with single-phase/three-phase power supply

Displacement factor > 0.98

### DC Link Inductor Reduces Harmonic Distortion

The CFW11 inverters (up to frame G) are equipped with a DC link inductor to mitigate harmonics, providing compliance with the requirements of IEC 61000 parts 3-2 and 3-12, related to the injection of harmonics into the line. For frame H, it is mandatory to add line reactance.

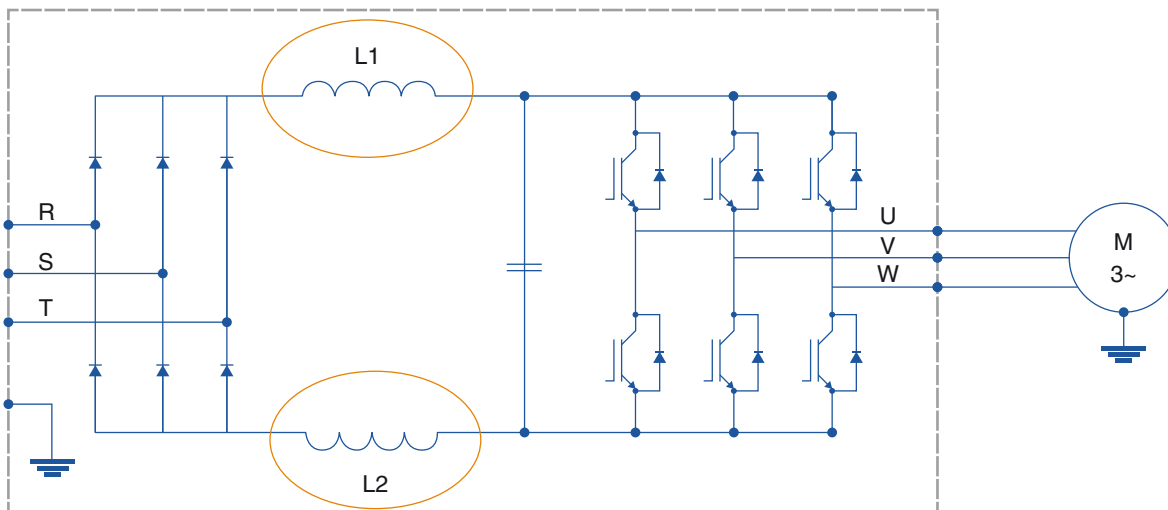

*Note: in frames A to G, no additional line reactor is required.*

### Dynamic Braking

Braking IGBT (chopper) can be offered built-in or with external module (DBW03/DBW04).

### Conformal Coating

Application of a special varnish on the CFW11 electronic boards to extend the service life, protecting against dust, moisture and corrosive chemicals.

Class 3C2 protection is standard for the entire CFW11 line and in compliance with IEC 60721-3-3. Also available in the Extra-Coating version, class 3C3, as an optional item.



### Monitoring of Motor Temperatures

Monitoring of the motor temperature readings (PTC, Pt-100, KTY84), providing thermal protection for the motor (accessory required).

### Single DC Busbar

Usually used in multimotor systems, this configuration is a great solution for energy savings and reduced installation costs, since the individual rectifier bridges of the inverters are replaced by a single rectifier bridge. Each variable speed drive is then fed with direct current through its DC power terminals.

This solution allows the power on the DC link to be shared by the inverters connected to it, thus optimizing the energy consumption.

Standard frames A to E and H of the CFW11 in the standard version and sizes F and G in the special hardware version (DC) can be connected to a DC bus system (refer to the User's Manual for further information).

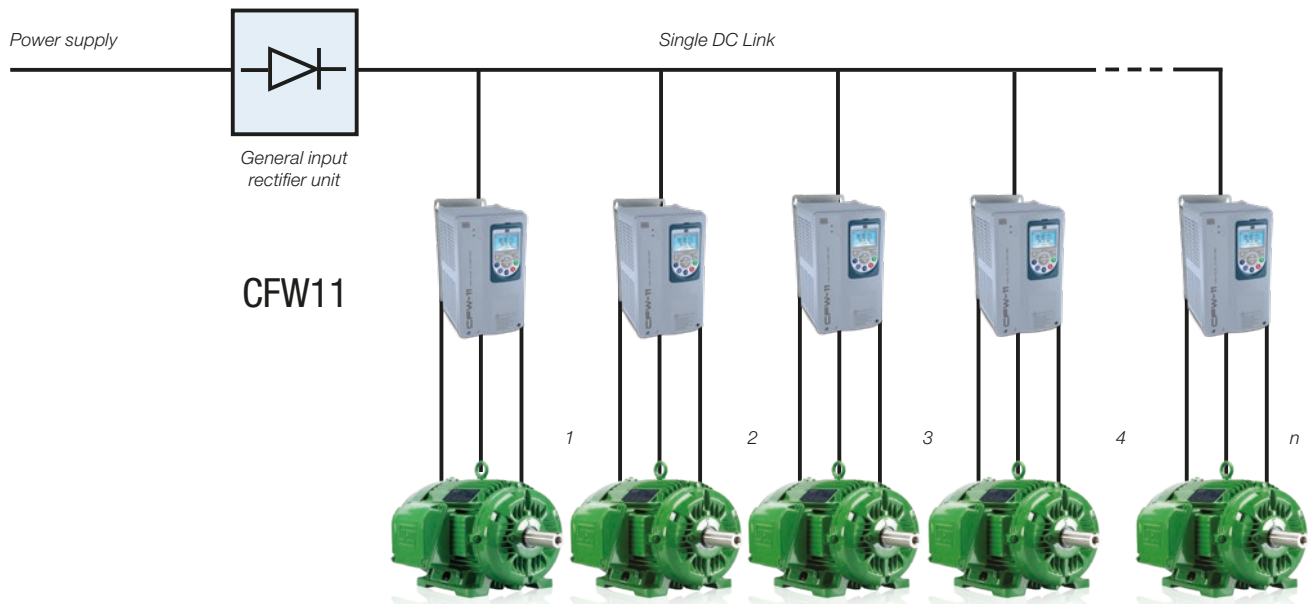

*Note: a pre-charge circuit must be added to each of the variable speed drive.*

### Intelligent Thermal Management

- Monitoring of the heatsink and internal air temperatures on the electronic boards, providing full protection for the IGBTs and CFW11 as a whole
- The heatsink fan is turned on and off automatically, depending on the temperature of the power modules
- The speed and running time of the fans are monitored and indicated in parameters
- The fan can be easily removed for cleaning or replacement

### Operating Temperature

Ambient temperature up to 60 °C for frames A to D (except IP55 models) and up to 55 °C for frames E, F, G and H, with current derating (refer to the User's Manual).



## Applications

Thanks to its wide range of functions, high overload capacity, easy setup, installation and operation, in addition to offering the panel-mounted versions (AFW11, APW11 and modular AFW11M/W), the CFW11 is the ideal variable speed drive for different applications, in different industry sectors.

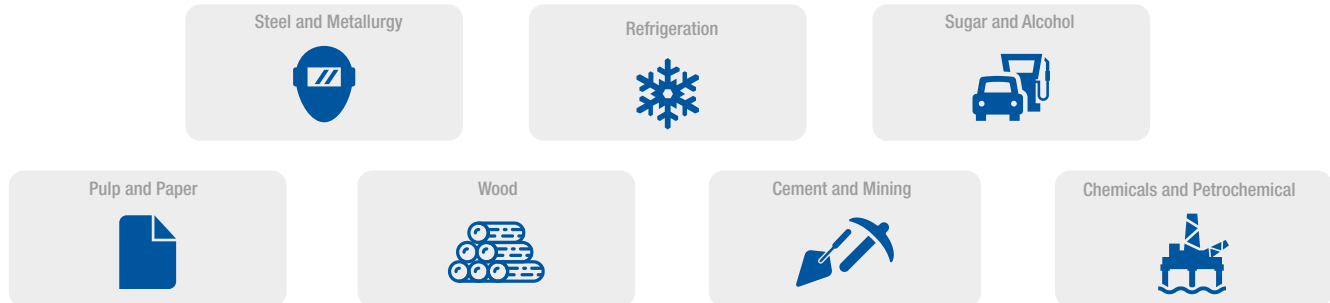

The CFW11 has also been developed for applications where safety is an essential requirement, because, in addition to the built-in protections and alarms, it has a safety stop function according to EN ISO 13849-1 and IEC 62061/IEC 61508 and TÜV Rheinland certification.



### Pumps and Fans

Reduction of the electric energy consumption, precise control of process variables (pressure, flow, temperature) with PID regulator, maintenance and safety alarm indication.



### Compressors

Reduction of the electric energy consumption, higher efficiency and demand control, lower starting current, prevention of mechanical wear.



### Multipump Control

It maintains constant pipe line pressure, regardless of oscillations in the flow demand.



### Load Lifting

The vector mode ensures precise stop and speed control even at low speeds.



### Machines and Processes in General

Copy and download of parameters via keypad or built-in flash memory, free software applications, excellent cost-benefit and simple operation.



### Mills and Centrifuges

The wide power range of the CFW11 line, combined with the possibility of connection to a single DC link, allows the DC link energy to be shared by the inverters connected to it, thus optimizing the energy consumption in the system.



### Equipment in Steel and Metallurgy

Ideal for applications requiring extremely reliable and robust drives with high overload capacity (HD-sized models).



### Conveyor Belts

Due to its programming flexibility and hardware configuration, the CFW11 makes adjusting applications where synchronism is essential quite simple.



### HVAC-R

The SoftPLC function incorporated to the standard product allows the use of two PID controllers simultaneously. Such feature is ideal for HVAC-R applications.

# Coding<sup>1)</sup>

- 1
- 2
- 3
- 4
- 5
- 6
- 7

**1 - WEG CFW11 variable speed drive**  
**2 - Rated output current for normal duty (ND)**

Power Supply	Single-phase (S)	Single-phase or Three-phase (B)	Three-phase (T)						
Voltage	200-240 V ac	200-240 V ac	200-240 V ac	380-480 V ac		500-600 V ac		660-690 V ac	
Current	0006 = 6 A 0007 = 7 A 0010 = 10 A	0006 = 6 A 0007 = 7 A	0007 = 7 A	0003 = 3 A	0180 = 180 A	0002 = 2,9 A	0107 = 107 A	0002 = 2,9 A	0107 = 100 A
			0010 = 10 A	0005 = 5 A	0211 = 211 A	0004 = 4,2 A	0125 = 125 A	0004 = 4,2 A	0125 = 108 A
			0013 = 13 A	0007 = 7 A	0242 = 242 A	0007 = 7 A	0150 = 150 A	0007 = 7 A	0150 = 130 A
			0016 = 16 A	0010 = 10 A	0312 = 312 A	0010 = 10 A	0170 = 170 A	0010 = 8,5 A	0170 = 147 A
			0024 = 24 A	0013 = 13 A	0370 = 370 A	0012 = 12 A	0216 = 216 A	0012 = 11 A	0216 = 195 A
			0028 = 28 A	0017 = 17 A	0477 = 477 A	0017 = 17 A	0289 = 289 A	0017 = 15 A	0289 = 259 A
			0033 = 33 A	0024 = 24 A	0515 = 515 A	0022 = 22 A	0315 = 315 A	0022 = 20 A	0315 = 259 A
			0045 = 45 A	0031 = 31 A	0601 = 601 A	0027 = 27 A	0365 = 365 A	0027 = 24 A	0365 = 312 A
			0054 = 54 A	0038 = 38 A	0720 = 720 A	0032 = 32 A	0435 = 435 A	0032 = 30 A	0435 = 365 A
			0070 = 70 A	0045 = 45 A	0760 = 760 A	0044 = 44 A	0472 = 472 A	0044 = 35 A	0472 = 427 A
			0086 = 86 A	0058 = 58 A	0795 = 795 A	0053 = 53 A	0584 = 584 A	0053 = 46 A	0584 = 478 A
			0105 = 105 A	0070 = 70 A	0877 = 877 A	0063 = 63 A	0625 = 625 A	0063 = 54 A	0625 = 518 A
			0142 = 142 A	0088 = 88 A	1062 = 1062 A	0080 = 80 A	0758 = 758 A	0080 = 73 A	0758 = 628 A
0180 = 180 A	0105 = 105 A	1141 = 1141 A		0804 = 804 A		0804 = 703 A			
0211 = 211 A	0142 = 142 A								

**3 - Number of phases**

S	Single-phase
B	Single-phase or three-phase
T	Three-phase

**6 - Degree of protection**

Blank	Standard (according to the table below)
21	IP21
N1	NEMA1
55	IP55

**4 - Voltage**

2	200-240 V: for frames A, B, C and D 220-230 V: for frame E and F
4	380-480 V
5	500-600 V
6	660-690 V

Frame	Degree of protection	Special DC hardware
A	IP21	No
B	IP21	No
C	IP21	No
D	NEMA1 / IP20	No
E	IP20	No
F	IP20	No
	IP00	Yes
G	IP20	No
	IP00	Yes
H	IP20	No

**5 - Optional accessories**

S	Factory default model
0	Product with optional items

Note: 1) Other configurations available upon request.





**8** ---

**9** ---

**10** ---

**11** ---

**12** ---

**13** ---

**14** ---

**7 - HMI**

Blank	With operating interface (HMI) included
0	No operating interface (HMI) - with blank cover

**8 - Braking**

Blank	200-480 V	Frames A, B, C and D: Built-in brake IGBT. Frames E, F and G: Brake IGBT not incorporated.
	500-600 V	Frame B: Built-in brake IGBT. Frames F and G: Brake IGBT not incorporated (use DBW03 - see accessories). Frame H: Brake IGBT not incorporated (use DBW04 - see accessories).
	500-690 V	Frames D and E: Built-in brake IGBT. Frames F and G: Brake IGBT not incorporated.
DB	200-480 V	Frame E: Built-in brake IGBT.
	500-690 V	Frames D and E: Brake IGBT already built-in (no need to include "DB" in the smart code).
NB	500-690 V	Brake IGBT not included in frames B, C, D and E.
	200-480 V	Frames A, B, C, D and E: not available without brake IGBT.

**9 - RFI filter**

Blank	200-480 V	Frames A, B, C and D: without RFI filter. Frames E, F, G and H with built-in RFI filter.
	500-600 V	Frame B: built-in RFI filter.
	500-690 V	Frames D, E, F, G and H: built-in RFI filter.
FA	200-480 V	Frames A, B, C and D: built-in RFI filter.
	500-690 V	Any frame: already built-in (no need for FA in the smart code).
NF	200-480 V	Frames A, B, C and D: standard without RFI filter (no need for NF in the smart code).
	500-600 V	Frame B: without RFI filter.
	500-690 V	Frame D: without RFI filter.

**10 - Safety stop: Safe Torque Off (STO)**

Blank	Not built-in
Y	Built-in STO module included. 500-690 V any size: built-in

**11 - External power supply of the electronics at 24 V dc**

Blank	Factory default model
W	With external power supply of the electronics at 24 V dc

**12 - Special hardware**

Blank	Factory default model
H	Special hardware included
DC	Power supply via DC link (without rectifier bridge)
DS	With built-in switch disconnecter (IP55 models only)

**13 - Special software**

Blank	Factory default model
Sx	Special software included

**14 - End-of-coding indicator digit**

Z	End-of-code indicator
---	-----------------------



# Specification

## IP2x version

CFW11 variable speed drive					Maximum applicable motor <sup>1)</sup>									
Reference	Power supply (V)		Frame size	Braking IGBT	Rated output current (A)		Normal duty (ND)			Heavy duty (HD)				
							IEC		UL	IEC		UL		
							50 Hz	60 Hz	60 Hz	50 Hz	60 Hz	60 Hz		
							230 V ac	220 V ac	230 V ac	230 V ac	220 V ac	230 V ac		
ND	HD	kW	HP	HP	kW	HP	HP							
CFW110006S20FAZ	Single-phase	200-240 V ac	A	Built-in	6.0	5.0	1.5	2.0	1.5	1.1	1.5	1.0		
CFW110007S20FAZ					7.0	7.0	1.5	2.0	2.0	1.5	2.0	2.0		
CFW110010S2SZ					10	10	2.2	3.0	3.0	2.2	3.0	3.0		
CFW110006B2SZ	Single-phase or three-phase	200-240 V ac	A		6.0	5.0	1.5	2.0	1.5	1.1	1.5	1.0		
CFW110007B2SZ					7.0	7.0	1.5	2.0	2.0	1.5	2.0	2.0		
CFW110007T2SZ	Three-phase	200-240 V ac	A		7.0	5.5	1.5	2.0	2.0	1.1	1.5	1.0		
CFW110010T2SZ					10	8.0	2.2	3.0	3.0	1.5	2.0	2.0		
CFW110013T2SZ					13	11	3.0	4.0	3.0	3	3.0	3.0		
CFW110016T2SZ					16	13	4.0	5.0	5.0	3	4.0	3.0		
CFW110024T2SZ					24	20	5.5	7.5	7.5	5.5	6.0	5.0		
CFW110028T2SZ			B		28	24	7.5	10	10	5.5	7.5	7.5		
CFW110033T2SZ					33.5	28	9.2	12.5	10	7.5	10	10		
CFW110045T2SZ					45	36	11	15	15	9.2	12.5	10		
CFW110054T2SZ					54	45	15	20	20	11	15	15		
CFW110070T2SZ					70	56	22	25	25	15	20	20		
CFW110086T2SZ			D		86	70	22	30	30	22	25	25		
CFW110105T2SZ					105	86	30	40	40	22	30	30		
CFW110142T20DBZ					142	115	45	50	50	30	40	40		
CFW110180T20DBZ					180	142	55	75	60	45	50	50		
CFW110211T20DBZ					211	180	55	75	75	55	75	60		
CFW110142T2SZ			E		142	115	45	50	50	30	40	40		
CFW110180T2SZ					180	142	55	75	60	45	50	50		
CFW110211T2SZ					211	180	55	75	75	55	75	60		
							Not built-in	180	142	55	75	60	45	50
							211	180	55	75	75	55	75	60

Notes: 1) Motor powers are referential values valid for WEG W22 IE2 three-phase, 4-pole, 50 or 60 Hz induction motors. The proper size must be determined according to the motor rated current, which must be lower than or equal to the inverter rated output current.  
 ND = Normal Duty (normal overload = 110% of the rated current for one minute or 150% of the rated current for 3 seconds; one overload every 10 minutes).  
 HD = Heavy Duty (heavy overload = 150% of the rated current for one minute or 200% of the rated current for 3 seconds; one overload every 10 minutes).

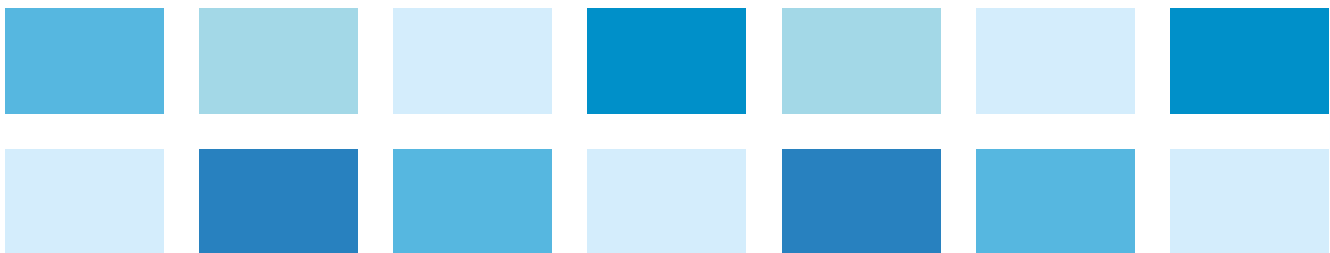

IP2x version

CFW11 variable speed drive					Maximum applicable motor <sup>1)</sup>											
Reference	Power supply (V)	Frame size	Braking IGBT	Rated output current (A)		Normal duty (ND)					Heavy duty (HD)					
						IEC		IEC		UL	IEC		IEC		UL	
				60 Hz	60 Hz	50 Hz	60 Hz	60 Hz	60 Hz	60 Hz	60 Hz	50 Hz	60 Hz	60 Hz		
				380 V ac	380 V ac	415 V ac	460 V ac	460 V ac	380 V ac	380 V ac	415 V ac	460 V ac	460 V ac			
ND	HD	kW	HP	kW	HP	HP	kW	HP	kW	HP	HP	HP				
CFW110003T4SZ	Three-phase	380-480 V ac	A	Built-in	3.6	3.6	1.5	2.0	1.5	2.0	2.0	1.5	2.0	1.5	2.0	2.0
CFW110005T4SZ					5.0	5.0	2.2	3.0	2.2	3.0	3.0	2.2	3.0	2.2	3.0	3.0
CFW110007T4SZ					7.0	5.5	3.0	4.0	3.0	5.0	3.0	2.2	3.0	2.2	3.0	3.0
CFW110010T4SZ					10	10	4.5	6.0	4.0	7.5	5.0	4.5	6.0	4.0	7.5	5.0
CFW110013T4SZ					13.5	11	5.5	7.5	5.5	10	7.5	4.5	6.0	5.5	7.5	7.5
CFW110017T4SZ					17	13.5	7.5	10	9.2	10	10	5.5	7.5	5.5	10	7.5
CFW110024T4SZ					24	19	11	15	11	20	15	9.2	12.5	9.2	15	10
CFW110031T4SZ					31	25	15	20	15	25	20	11	15	11	20	15
CFW110038T4SZ					38	33	18.5	25	18.5	30	25	15	20	15	25	20
CFW110045T4SZ					45	38	22	30	22	30	30	18.5	25	18.5	30	25
CFW110058T4SZ					58.5	47	30	40	30	50	40	22	30	22	30	30
CFW110070T4SZ					70.5	61	37	50	37	60	50	30	40	30	50	40
CFW110088T4SZ					88	73	45	60	45	75	60	37	50	37	60	50
CFW110105T40DBZ					105	88	55	75	55	75	75	45	60	45	75	60
CFW110142T40DBZ					142	115	75	100	75	100	100	55	75	55	100	75
CFW110180T40DBZ			180	142	90	125	90	150	150	75	100	75	100	100		
CFW110211T40DBZ			211	180	110	150	110	150	150	90	125	90	150	150		
CFW110105T4SZ			105	88	55	75	55	75	75	45	60	45	75	60		
CFW110142T4SZ			142	115	75	100	75	100	100	55	75	55	100	75		
CFW110180T4SZ			180	142	90	125	90	150	150	75	100	75	100	100		
CFW110211T4SZ			211	180	110	150	110	180	150	90	125	90	150	150		
CFW110242T4SZ			242	211	110	150	132	200	200	110	150	110	150	150		
CFW110312T4SZ			312	242	150	200	160	270	250	110	150	132	200	200		
CFW110370T4SZ			370	312	200	270	200	300	300	150	200	160	250	250		
CFW110477T4SZ			477	370	260	350	260	350	400	200	270	200	300	300		
CFW110515T4SZ			515	477	260	350	300	450	400	220	300	280	400	400		
CFW110601T4SZ			601	515	300	400	355	500	500	260	350	300	450	400		
CFW110720T4SZ			720	560	370	500	400	610	600	300	400	315	500	400		
CFW110760T4SZ			760	600	400	550	450	680	600	300	400	330	550	500		
CFW110795T4SZ			795	637	400	550	450	680	600	330	450	355	550	500		
CFW110877T4SZ			877	715	480	650	500	750	700	370	500	400	610	500		
CFW111062T4SZ			1,062	855	560	750	560	850	900	440	600	500	750	700		
CFW111141T4SZ	1,141	943	590	800	630	970	1,000	515	700	560	750	800				

Notes: 1) Motor powers are referential values valid for WEG W22 IE2 or HGF three-phase, 4-pole, 50 or 60 Hz induction motors. The proper size must be determined according to the motor rated current, which must be lower than or equal to the inverter rated output current.  
 ND = Normal Duty (normal overload = 110% of the rated current for one minute or 150% of the rated current for 3 seconds; one overload every 10 minutes).  
 HD = Heavy Duty (heavy overload = 150% of the rated current for one minute or 200% of the rated current for 3 seconds; one overload every 10 minutes).

# Specification

## IP2x version

CFW11 variable speed drive						Maximum applicable motor <sup>1)</sup>						
Reference	Power supply (V)		Frame size	Braking IGBT	Rated output current (A)		Normal duty (ND)			Heavy duty (HD)		
							IEC		UL	IEC		UL
							50 Hz	60 Hz	60 Hz	50 Hz	60 Hz	60 Hz
							525 V ac	575 V ac	575 V ac	525 V ac	575 V ac	575 V ac
ND	HD	kW	HP	HP	kW	HP	HP					
CFW110002T50NFYZ	Three-phase	500-600 V ac	B	Built-in	2.9	2.7	1.5	2.0	2.0	1.5	2.0	2.0
CFW110004T50NFYZ					4.2	3.8	2.2	3.0	3.0	2.2	3.0	2.0
CFW110007T50NFYZ					7.0	6.5	4.0	5.0	5.0	4.0	5.0	5.0
CFW110010T50NFYZ					10	9.0	5.5	7.5	7.5	5.5	7.5	7.5
CFW110012T50NFYZ					12	10	7.5	10	10	5.5	7.5	7.5
CFW110017T50NFYZ					17	17	11	15	15	11	15	15
CFW110022T50NFYZ					22	19	15	20	20	11	20	15
CFW110027T50NFYZ					27	22	18.5	25	25	15	20	20
CFW110032T50NFYZ					32	27	22	30	30	18.5	25	25
CFW110044T50NFYZ					44	36	30	40	40	22	30	30
CFW110053T60YZ					53	44	37	50	50	30	40	40
CFW110063T60YZ					63	53	45	60	60	37	50	50
CFW110080T60YZ			80	66	55	75	75	45	75	60		
CFW110107T60YZ			107	90	75	100	100	55	100	75		
CFW110125T60YZ			125	107	90	125	125	75	100	100		
CFW110150T60YZ			150	122	110	150	150	90	125	100		
CFW110170T60YZ			170	150	110	175	150	110	150	150		
CFW110216T60YZ			216	180	160	200	250	132	175	150		
CFW110289T60YZ			289	240	200	300	300	160	250	250		
CFW110315T60YZ			315	289	220	350	300	200	300	300		
CFW110365T60YZ			365	315	260	380	350	220	350	300		
CFW110435T60YZ			435	357	300	450	450	260	380	350		
CFW110472T60YZ			472	418	330	500	500	300	430	450		
CFW110584T60YZ			584	504	400	600	600	370	550	500		
CFW110625T60YZ	625	540	450	650	700	370	550	600				
CFW110758T60YZ	758	614	560	750	800	450	680	600				
CFW110804T60YZ	804	682	560	850	900	500	750	700				

Notes: 1) Motor powers are referential values valid for WEG W22 IE2 or HGF three-phase, 4-pole, 50 or 60 Hz induction motors. The proper size must be determined according to the motor rated current, which must be lower than or equal to the inverter rated output current.

ND = Normal Duty (normal overload = 110% of the rated current for one minute or 150% of the rated current for 3 seconds; one overload every 10 minutes).  
 HD = Heavy Duty (heavy overload = 150% of the rated current for one minute or 200% of the rated current for 3 seconds; one overload every 10 minutes).

**IP2x version**

CFW11 variable speed drive						Maximum applicable motor <sup>1)</sup>						
Reference	Power supply (V)		Frame size	Braking IGBT	Rated output current (A)		Normal duty (ND)			Heavy duty (HD)		
							IEC		UL	IEC		UL
							50 Hz	60 Hz	60 Hz	50 Hz	60 Hz	60 Hz
							660 V ac	690 V ac	660 V ac	660 V ac	690 V ac	660 V ac
ND	HD	kW	HP	HP	kW	HP	HP					
CFW110002T60NFYZ	Three-phase	500-690 V ac	D	Built-in	2.9	2.7	2.2	3.0	3.0	1.5	3.0	2.0
CFW110004T60NFYZ					4.2	3.8	3.0	4.0	4.0	2.2	4.0	4.0
CFW110007T60NFYZ					7.0	6.5	5.5	7.5	7.5	4.0	7.5	6.0
CFW110010T60NFYZ					8.5	7.0	5.5	10	10	5.5	7.5	7.5
CFW110012T60NFYZ					11	9.0	9.2	12.5	12.5	7.5	10	10
CFW110017T60NFYZ					15	13	11	15	15	11	15	15
CFW110022T60NFYZ					20	17	15	25	20	15	20	15
CFW110027T60NFYZ					24	20	18.5	30	25	15	25	20
CFW110032T60NFYZ					30	24	22	30	30	18.5	30	25
CFW110044T60NFYZ					35	30	30	40	40	22	30	30
CFW110053T60YZ					46	39	37	60	60	30	50	40
CFW110063T60YZ					54	46	45	60	60	37	60	50
CFW110080T60YZ			73	61	55	75	75	55	75	75		
CFW110107T60YZ			100	85	90	125	125	75	100	100		
CFW110125T60YZ			108	95	90	125	125	75	125	100		
CFW110150T60YZ			130	108	110	150	125	90	125	125		
CFW110170T60YZ			147	127	132	180	175	110	150	150		
CFW110216T60YZ			195	165	185	250	200	132	200	200		
CFW110289T60YZ			259	225	200	300	250	185	250	200		
CFW110315T60YZ			259	225	220	300	300	200	300	270		
CFW110365T60YZ			312	259	280	400	350	220	300	300		
CFW110435T60YZ			365	312	315	450	450	280	400	350		
CFW110472T60YZ			427	365	400	500	550	355	400	400		
CFW110584T60YZ			478	410	450	610	600	370	550	500		
CFW110625T60YZ			518	447	500	680	650	400	550	550		
CFW110758T60YZ			628	518	560	750	800	500	680	650		
CFW110804T60YZ			703	594	630	850	900	560	750	750		

Notes: 1) Motor powers are referential values valid for WEG W22 IE2 or HGF three-phase, 4-pole, 50 or 60 Hz induction motors. The proper size must be determined according to the motor rated current, which must be lower than or equal to the inverter rated output current.  
 ND = Normal Duty (normal overload = 110% of the rated current for one minute or 150% of the rated current for 3 seconds; one overload every 10 minutes).  
 HD = Heavy Duty (heavy overload = 150% of the rated current for one minute or 200% of the rated current for 3 seconds; one overload every 10 minutes).

## Specification

### IP55/NEMA type 12 version

This version of the inverter can be installed in environments with high humidity, rain, exposed to sun and dust, without the need for panels. The inverter cooling method ensures maximum overload capacity and performance.

- Chemical Industry
- Petrochemical Industry
- Food Industry

They use the same communication and I/O accessories as IP20/21 inverters.

Also available in the version with built-in switch disconnecter for a fast and safe isolation of the power line.



### IP55 version

CFW11 variable speed drive						Maximum applicable motor <sup>1)</sup>										
Reference	Power supply (V)		Frame size	Braking IGBT	Rated output current (A)		Normal duty (ND)			Heavy duty (HD)						
							IEC		UL	IEC		UL				
							50 Hz	60 Hz	60 Hz	50 Hz	60 Hz	60 Hz				
							230 V ac	220 V ac	230 V ac	230 V ac	220 V ac	230 V ac				
ND	HD	kW	HP	HP	kW	HP	HP									
CFW110006S2055FAZ	Single-phase	200-240 V ac	B	Built-in	6.0	5.0	1.5	2.0	1.5	1.1	1.5	1.0				
CFW110007S2055FAZ					7.0	7.0	1.5	2.0	2.0	1.5	2.0	2.0				
CFW110010S2055Z					10	10	2.2	3.0	3.0	2.2	3.0	3.0				
CFW110006B2055Z	Single-phase or three-phase	200-240 V ac			6.0	5.0	1.5	2.0	1.5	1.1	1.5	1.0				
CFW110007B2055Z					7.0	7.0	1.5	2.0	2.0	1.5	2.0	2.0				
CFW110007T2055Z	Three-phase	200-240 V ac			7.0	5.5	1.5	2.0	2.0	1.1	1.5	1.0				
CFW110010T2055Z					10	8.0	2.2	3.0	3.0	1.5	2.0	2.0				
CFW110013T2055Z					13	11	3.0	4.0	3.0	3	3.0	3.0				
CFW110016T2055Z					16	13	4.0	5.0	5.0	3	4.0	3.0				
CFW110024T2055Z					24	20	5.5	7.5	7.5	5.5	6.0	5.0				
CFW110028T2055Z					28	24	7.5	10	10	5.5	7.5	7.5				
CFW110033T2055Z					33.5	28	9.2	12.5	10	7.5	10	10				
CFW110045T2055Z					45	36	11	15	15	9.2	12.5	10				
CFW110054T2055Z					54	45	15	20	20	11	15	15				
CFW110070T2055Z					70	56	22	25	25	15	20	20				
CFW110086T2055Z					86	70	22	30	30	22	25	25				
CFW110105T2055Z					105	86	30	40	40	22	30	30				
CFW110142T2055DBZ	C	200-240 V ac			Built-in	142	115	45	50	50	30	40	40			
CFW110180T2055DBZ			180	142		55	75	60	45	50	50					
CFW110211T2055DBZ			211	180		55	75	75	55	75	60					
CFW110142T2055Z	D		200-240 V ac	Built-in		142	115	45	50	50	30	40	40			
CFW110180T2055Z						180	142	55	75	60	45	50	50			
CFW110211T2055Z						211	180	55	75	75	55	75	60			
CFW110142T2055Z						E	200-240 V ac	Not built-in	142	115	45	50	50	30	40	40
CFW110180T2055Z									180	142	55	75	60	45	50	50
CFW110211T2055Z									211	180	55	75	75	55	75	60

Notes: 1) Motor powers are referential values valid for WEG W22 IE2 three-phase, 4-pole, 50 or 60 Hz induction motors. The proper size must be determined according to the motor rated current, which must be lower than or equal to the inverter rated output current.  
 ND = Normal Duty (normal overload = 110% of the rated current for one minute or 150% of the rated current for 3 seconds; one overload every 10 minutes).  
 HD = Heavy Duty (heavy overload = 150% of the rated current for one minute or 200% of the rated current for 3 seconds; one overload every 10 minutes).

IP55 version

CFW11 variable speed drive					Maximum applicable motor <sup>1)</sup>														
Reference	Power supply (V)		Frame size	Braking IGBT	Rated output current (A)		Normal duty (ND)					Heavy duty (HD)							
							IEC		IEC		UL	IEC		IEC		UL			
							60 Hz	60 Hz	50 Hz	60 Hz	60 Hz	60 Hz	60 Hz	50 Hz	60 Hz	60 Hz			
					380 V ac	380 V ac	415 V ac	460 V ac	460 V ac	380 V ac	380 V ac	415 V ac	460 V ac	460 V ac					
ND	HD	kW	HP	kW	HP	HP	kW	HP	kW	HP	HP	kW	HP	HP					
CFW110003T4055Z	Three-phase	380-480 V ac	B	Built-in	3.6	3.6	1.5	2.0	1.5	2.0	2.0	1.5	2.0	1.5	2.0	2.0			
CFW110005T4055Z					5.0	5.0	2.2	3.0	2.2	3.0	3.0	2.2	3.0	2.2	3.0	2.2	3.0	3.0	
CFW110007T4055Z					7.0	5.5	3.0	4.0	3.0	5.0	3.0	2.2	3.0	2.2	3.0	2.2	3.0	3.0	
CFW110010T4055Z					10	10	4.5	6.0	4.0	7.5	5.0	4.5	6.0	4.0	7.5	5.0	4.5	6.0	5.0
CFW110013T4055Z					13.5	11	5.5	7.5	5.5	10	7.5	4.5	6.0	5.5	7.5	5.5	7.5	7.5	
CFW110017T4055Z					17	13.5	7.5	10	9.2	10	10	5.5	7.5	5.5	10	7.5	5.5	10	7.5
CFW110024T4055Z					24	19	11	15	11	20	15	9.2	12.5	9.2	15	10	9.2	15	10
CFW110031T4055Z					31	25	15	20	15	25	20	11	15	11	20	15	11	20	15
CFW110038T4055Z					38	33	18.5	25	18.5	30	25	15	20	15	25	20	15	25	20
CFW110045T4055Z					45	38	22	30	22	30	30	18.5	25	18.5	30	25	18.5	30	25
CFW110058T4055Z			58.5		47	30	40	30	50	40	22	30	22	30	30	22	30	30	
CFW110070T4055Z			70.5		61	37	50	37	60	50	30	40	30	50	40	30	50	40	
CFW110088T4055Z			88		73	45	60	45	75	60	37	50	37	60	50	37	60	50	
CFW110105T4055DBZ			105		88	55	75	55	75	75	45	60	45	75	60	45	75	60	
CFW110142T4055DBZ			142		115	75	100	75	100	100	55	75	55	100	75	55	100	75	
CFW110180T4055DBZ			180		142	90	125	90	150	150	75	100	75	100	100	75	100	100	
CFW110211T4055DBZ			211		180	110	150	110	150	150	90	125	90	150	150	90	150	150	
CFW110105T4055Z			105		88	55	75	55	75	75	45	60	45	75	60	45	75	60	
CFW110142T4055Z			142		115	75	100	75	100	100	55	75	55	100	75	55	100	75	
CFW110180T4055Z			180		142	90	125	90	150	150	75	100	75	100	100	75	100	100	
CFW110211T4055Z	211	180	110	150	110	180	150	90	125	90	150	150	90	150	150				

Notes: 1) Motor powers are referential values valid for WEG W22 IE2 three-phase, 4-pole, 50 or 60 Hz induction motors. The proper size must be determined according to the motor rated current, which must be lower than or equal to the inverter rated output current.  
 ND = Normal Duty (normal overload = 110% of the rated current for one minute or 150% of the rated current for 3 seconds; one overload every 10 minutes).  
 HD = Heavy Duty (heavy overload = 150% of the rated current for one minute or 200% of the rated current for 3 seconds; one overload every 10 minutes).



## Accessories

	Name	Description	Slot	Image
I/O expansion	IOA-01	1 14-bit voltage or current analog input 2 digital inputs 2 14-bits voltage or current analog outputs 2 open collector digital outputs	1	
	IOB-01	2 isolated 12-bit analog inputs 2 digital inputs 2 14-bits voltage or current analog outputs 2 open collector digital outputs	1	
	IOC-01	8 digital inputs 4 digital outputs (use with SoftPLC)	1	
	IOC-02	8 digital inputs 8 open collector digital outputs (use with SoftPLC)	1	
	IOC-03	8 digital inputs 7 open collector external 24 V dc digital outputs (use with SoftPLC)	1	
Temperature transducers	IOE-01	5 PTC temperature sensor inputs	1	
	IOE-02	5 Pt-100 temperature sensor inputs	1	
	IOE-03	5 KTY84 temperature sensor inputs	1	
Encoder interface	ENC-01	Incremental encoder module 5 to 12 V dc (built-in power supply) 100 kHz With encoder signal repeater (external power supply required)	2	
	ENC-02	Incremental encoder module 5 to 12 V dc (built-in power supply) 100 kHz	2	

### Blank Cover - HMID - 01<sup>1)</sup>

Blank cover to replace the standard HMI when not used.

*Note: 1) This optional item must be installed at the factory and the orders must specify the desired option in the product coding (page 16).*



### Frame for Remote HMI - RHMIF-01

Frame to install the HMI on panel door or machine consoles. IP56 protection rating.





	Reference	Description	Slot	Image
Communication	RS485-01	RS485 serial communication module (Modbus-RTU)	3	
	RS232-01	RS232 serial communication module (Modbus-RTU)	3	
	CAN/RS485-01	CAN/RS485 interface module (CANopen, DeviceNet, Modbus-RTU and BACnet)	3	
	CAN-01	CAN interface module (CANopen and DeviceNet)	3	
	PROFIBUS DP-01	Profibus-DP-V1 interface module	3	
	ETHERCAT-05	EtherCAT interface module	4	
	PROFDP-05	Profibus-DP-V1 module (Anybus-CC)	4	
	DEVICENET-05	DeviceNet module (Anybus-CC)	4	
	RS232-05	RS232 interface module (passive) (Modbus-RTU)	4	
	RS485-05	RS485 interface module (passive) (Modbus-RTU)	4	
	MODBUSTCP-05	Interface module Modbus-TCP - 1 port	4	
		Interface module Modbus-TCP - 2 ports	4	
	PROFINETIO-05	PROFINET IO interface module (Anybus-CC) - 1 port	4	
		PROFINET IO interface module (Anybus-CC) - 2 ports	4	
ETHERNETIP-05	EtherNet/IP interface module - 1 port	4		
	EtherNet/IP interface module - 2 ports	4		
PLC Functions	PLC11-01	Module with PLC functions (see page 26)	1, 2 and 3	
	PLC11-02	Module with PLC functions (see page 26)		

## Accessories

### PLC11

The PLC11 accessory provides the CFW11 with PLC functionalities, such as network master, speed reference generator and motion control functions.

It has two versions: PLC11-01 and PLC11-02 (see the differences below). In many applications, these accessories enable the CFW11 to replace an external PLC, reducing costs.

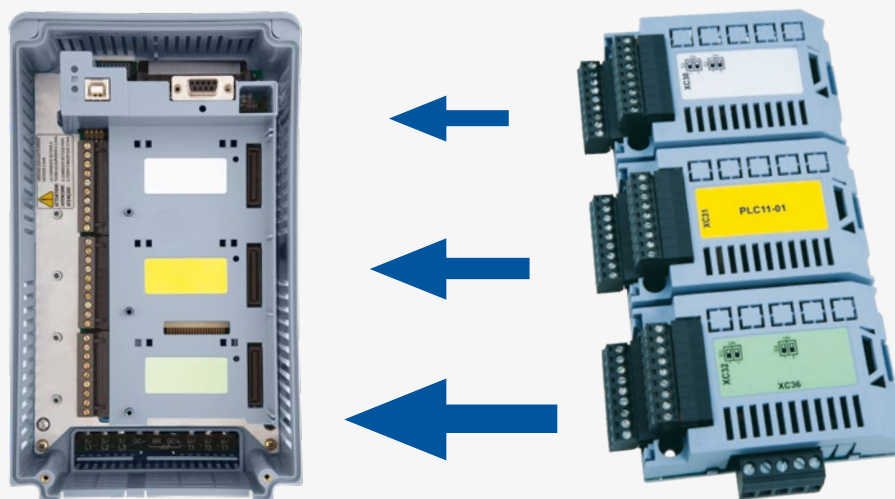

Installation of the PLC module in the CFW11

PLC11 module

### Resources

- Motion control with trapezoidal “S” profiles (absolute and relative)
- Search for the machine home position (homing)
- Ladder programming through the WLP software with timers, counters, coils and contacts
- RS485 serial interface with Modbus-RTU protocol
- 100 configurable parameters available to the user through the HMI or WLP
- Master/Slave function (electronic gearbox)
- CAN interface for CANopen and DeviceNet protocols
- Modbus-RTU Master and CANopen Master, which enables the CFW11 to control up to 25 slave devices
- WLP/WSCAN software: network programming and configuration software in the same environment

### Technical Data

- Digital inputs
- Digital outputs
- Relay output
- RS485 interface
- Encoder interface inputs
- CANopen interface
- Analog outputs

### PLC11-01

- 9 bi-directional inputs 24 V
- 3 bi-directional open collector outputs: 24 V dc, 500 mA
- 3 outputs for NO contacts: 250 V ac, 3 A
- 2 incremental encoder inputs 5...12 V dc, 500 mA (built-in power supply)
- 1 RS485 port (Modbus-RTU available)
- 1 CAN port (CANopen available)
- 1 differential input: -10...+ 10V dc / 0...20 mA, 14 bits
- 2 analog outputs: -10...+10 V dc / 0...20 mA, 12 bits

### PLC11-02

- 4 isolated bi-directional inputs 24 V
- 3 bi-directional open collector outputs: 24 V dc, 500 mA
- 1 output for NO contacts: 250 V ac, 3 A
- 2 incremental encoder inputs 5...12 V dc, 500 mA (built-in power supply)
- 1 RS485 port (Modbus-RTU available)
- 1 CAN port (CANopen and DeviceNet available)

### Power Cable Shield Kit

The CFW11 has a kit to simplify the connection of the motor cable shield to the ground, allowing a low impedance connection for high frequencies.

Name	Description
PCSA-01	Power cable shield kit for frame A
PCSB-01	Power cable shield kit for frame B
PCSC-01	Power cable shield kit for frame C
PCSD-01	Power cable shield kit for frame D
PCSE-01	Power cable shield kit for frame E

- Notes: 1) The PCSD-01, PCSE-01 power cable shield kit is supplied together with inverters with RFI filter installed at the factory. E.g.: CFW11 0007 T 2 O FA Z.  
 2) In frames D and E, the power cable shield kit is factory default, even for inverters without built-in RFI filter.  
 3) Not available for frames F, G and H.



### Cabinets

Standards	Classification	Frames						
		A	B	C	D	E	F and G	H
IEC	IP20	-	-	-	X	X	X	X
	IP21	X	X	X	KIP21D-01	-	-	-
NEMA	Type 1	KN1A-01	KN1B-01	KN1C-01	X	KN1E-01/ KN1E-02	KN1F-01/ KN1G-01	-

Note: (X) Default  
 (-) Not available

Default	Accessory	Composition
NEMA Type 1	KN1A-01	Conduit kit for frame A
	KN1B-01	Conduit kit for frame B
	KN1C-01	Conduit kit for frame C
	KN1E-01	Top cover frame E models 105 and 142
	KN1E-02	Top cover + conduit kit frame E models 180 and 211
	KN1F-01	Conduit kit for frame F
	KN1G-01	Conduit kit for frame G
IEC	KIP21A-01	Top cover kit frame A
	KIP21B-01	Top cover kit frame B
	KIP21C-01	Top cover kit frame C
	KIP21D-01	Top cover kit frame D

Note: In the KN1X-01 conduit kit (frames A, B and C), the power cable shield is also supplied.



### DBW03 and DBW04 Dynamic Braking Module

The DBW03 and DBW04 braking modules can be used in applications involving high-inertia loads that require fast deceleration, dissipating the braking energy through an external resistor and keeping the voltage level on the DC link within the limits. The DBW braking modules have been developed to allow dynamic braking in F, G and H size inverters.

Model of the braking module		
Inverters frame F and G	DBW03 0380 D 3848SZ	DBW03 0250 D 5069SZ
Inverters frame H	DBW04 0380 D 3848SZ	DBW04 0250 D 5069SZ
Effective braking current	380 A	250 A
Minimum resistor	1,8 Ω	2,6 Ω
Auxiliary power supply for fan	220 V ac ±5% - 250 mA	



## Optional items

### Safe Torque Off (STO) Module

Category 3/PLd and SIL CL2, according to EN ISO 61800-5-2, EN ISO 13849-1, IEC 62061 and IEC 61508 Parts 1-7 and IEC 60204-1.

When the function is activated, the PWM pulses are blocked. Since torque is not applied to the motor, it is ensured that it remains still, providing safety to the system.

### Control External Power Supply at 24 V dc<sup>1)</sup>

Used with communication networks (Profibus-DP, DeviceNet, EtherNet/IP, etc.) so that the control circuit and interface to the communication network still work, even with the removal of the electric power (AC power supply).

### RFI Suppressor Filter<sup>1)</sup> (Compliant with EN 61800-3 and EN 55011)

CFW11 Models with built-in RFI filter, when properly installed, meet the requirements of the EMC Directive 2004/108/EC, as they attenuate high frequency noise (> 150 kHz) generated by the variable speed drive and injected in the power line.

Example: CFW11 0007 T 2 O FA Z.

For frames A to D, the RFI filter is optional. For frames E, F, G and H, the RFI filter is included as standard item.

Note: 1) Those optional items must be installed at the factory and the orders must specify the desired option in the product coding (page 16).



## Dimensions and Weights

### Standard Version



Frame	Dimensions mm			Weight kg		
	Height (H)	Width (W)	Depth (D)	200-240 V ac	380-480 V ac	500-690 V ac
A	270	145	227	6.3	6.3	-
B	316	190	227	9.1	10.4	9.1
C	405	220	293	17.9	20.5	19.6
D	550	300	305	31.4	32.6	34
E	675	335.2	358.2	65	65	64
F	1,234	430	360	-	140	168
G	1,264	535	426	-	215	258
H	1,414	686	420.8	-	220	213

### IP55/NEMA12 version



Frame	Dimensions mm				Weight kg
	Height (H)	Width (W)	Depth (D1)	Depth (D2)	
B	529	273	237	279	17.0
C	670	307	306	348	30.0
D	754	375	301.3	339	49.0
E	1,000	430	388,8	419	65.0

D1 = Depth of the models without built-in switch disconnecter.  
 D2 = Depth of the models with built-in switch disconnecter.

## Mechanical Assembly

### Standard Installation

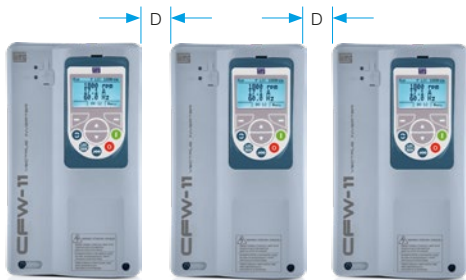

### Side-by-Side Installation



Frame	Minimum mounting distance with top cover			
	A mm	B mm	C mm	D mm
A	25	25	10	30
B	40	45	10	30
C	110	130	10	30
D	110	130	10	30
E	150	250	20	80
F, G and H	150	250	20	80

Notes: When a variable speed drive is mounted over another, use the distance A + B and divert the hot air from the inverter.

For frames A, B and C: it is possible to mount the inverters side by side, without lateral spacing. In this case, the top cover should be removed.

## Mechanical Installation and Panel Mounting

### Surface Mounting

Frame	Protection rating	a2	b2	c2
		mm	mm	M
A	IP2X	115	250	M5
B	IP2X	150	300	M5
	IP55	200	505	M8
C	IP2X	150	375	M6
	IP55	200	642	M8
D	IP2X	200	525	M8
	IP55	250	725	M8
E	IP2X	200	650	M8
	IP55	150	970	M8
F	IP2X	150	1,200	M10
G	IP2X	200	1,225	M10
H	IP2X	175	1,350	M10

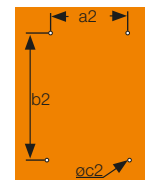

Frames A, B, C and D (IP2X and IP55) and E (IP2X)

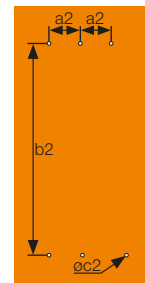

Frames E (IP55), F, G and H

### Flange Mounting

Frame	a3	b3	c3	d3	e3
	mm	mm	M	mm	mm
A	130	240	M5	135	225
B	175	285	M5	179	271
C	195	365	M6	205	345
D	275	517	M8	285	485
E	275	640	M8	315	615
F	350	1,185	M10	391	1,146
G	400	1,220	M10	495	1,182
H	595	1,345	M10	647	1,307

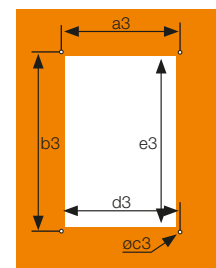

Notes: For frames A to D, the area of the inverter outside the panel has IP54 protection rating.

For frames E (models 180T2, 211T2, 180T4 and 211T4), F and G, the area of the inverter outside the panel has IP54 protection rating (hardware version H1).

For frame H, the area of the inverter outside the panel has IP20 protection rating.

# Block Diagram - Frames A to G

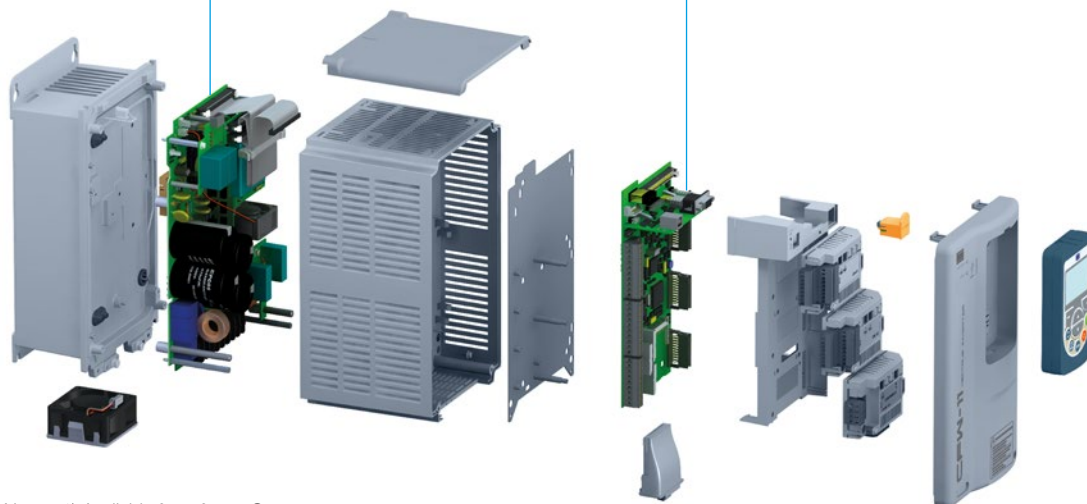
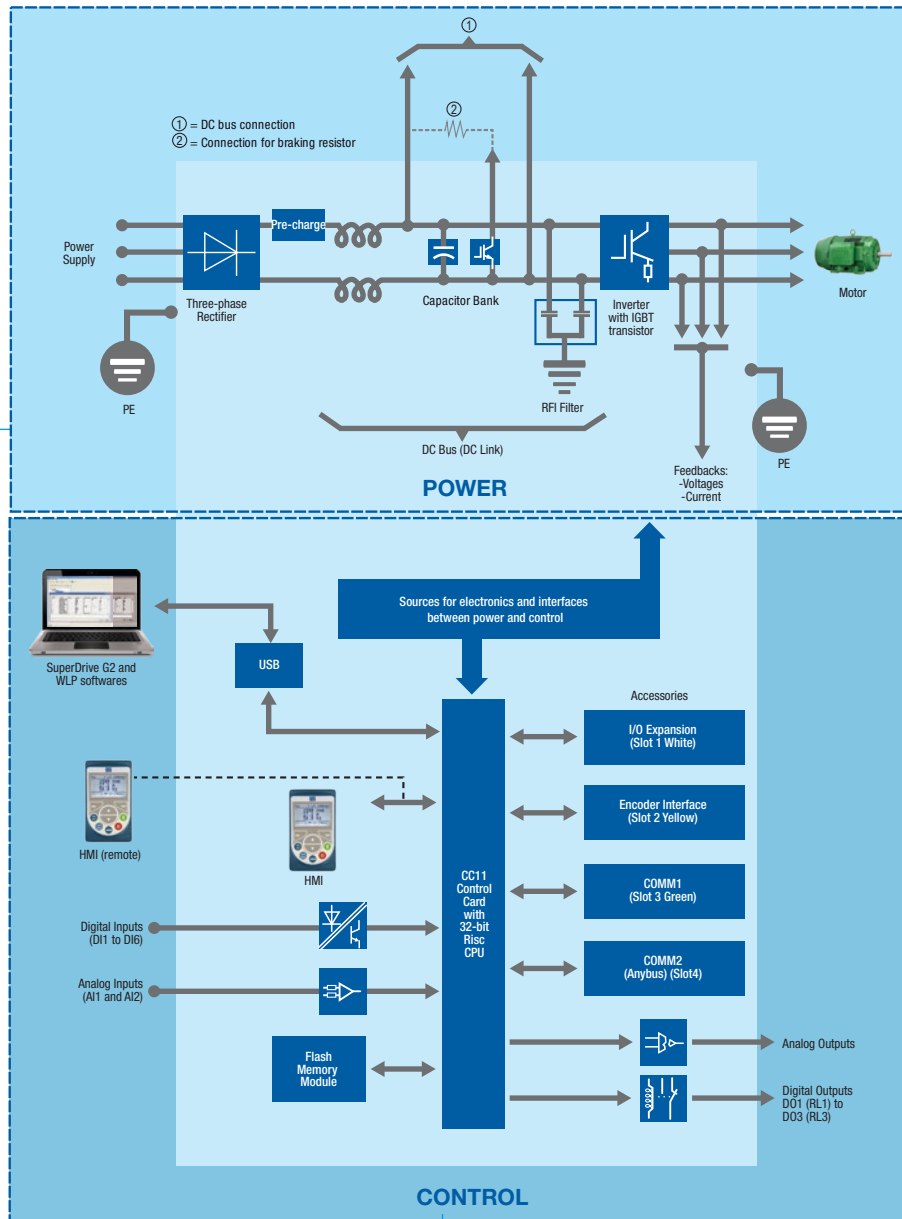

Notes: 1) Available from frame G.  
 2) Brake IGBT available in frames A to D and E (in versions with built-in brake IGBT). In frames F, G and H, it is necessary to use a dynamic braking module (external accessory).  
 3) Standard RFI filter for sizes E, F, G and H.  
 For further information, refer to the user's manual.

# Block Diagram - Frame H

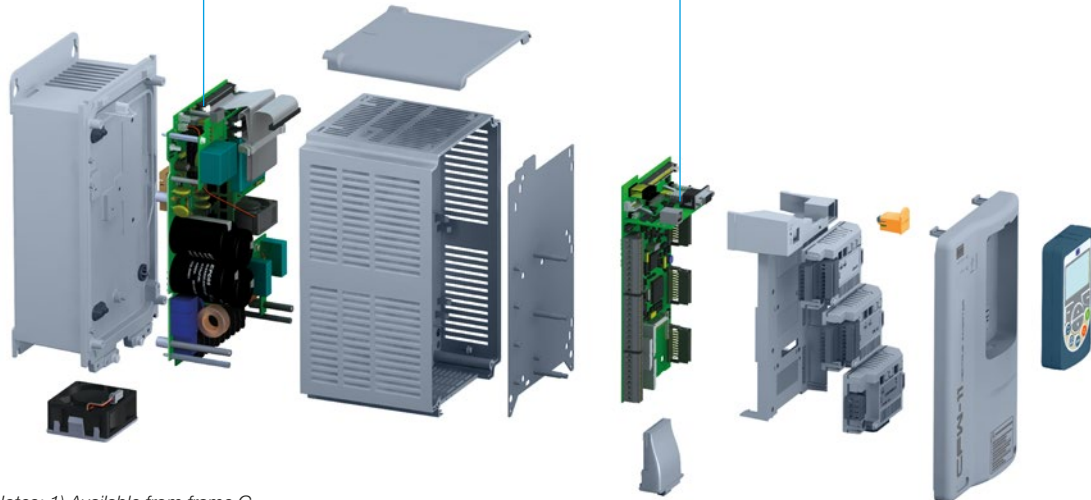
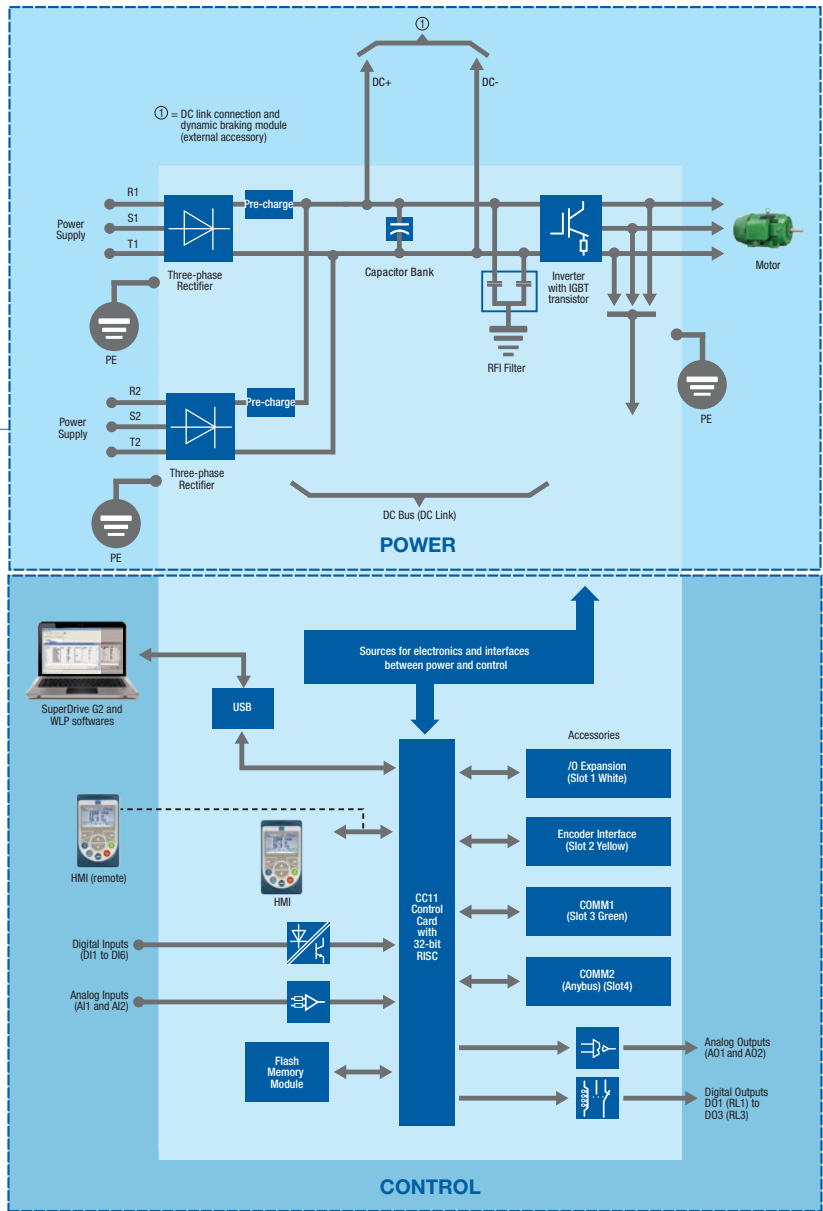

Notes: 1) Available from frame G.  
 2) Brake IGBT available in frames A to D and E (in versions with built-in brake IGBT). In frames F, G and H, it is necessary to use a dynamic braking module (external accessory).  
 3) Standard RFI filter for sizes E, F, G and H.  
 For further information, refer to the user's manual.



# Technical Data

Power supply and power range		
Voltage and power range	Single-phase	220-240 V ac (+10%, -15%) (2 to 3 HP) 1.5 to 2.2 kW
	Three-phase	220-240 V ac (+10%, -15%) (2 to 75 HP) 1.5 to 55 kW
		380-480 V ac (+10%, -15%) (2 to 850 HP) 1.5 to 630 kW
		500-600 V ac (+10%, -15%) (2 to 850 HP) 1.5 to 630 kW
		660-690 V ac (+10%, -15%) (3 to 850 HP) 2.2 to 630 kW
Frequency		50/60 Hz (+/-2%: 48 to 63 Hz)
Typical input power factor		0.94 for models with three-phase input in the rated condition 0.70 for models with single-phase input in the rated condition
Cos φ (displacement factor)		Above 0.98
Efficiency		Above 0.97

Inverter output		
Voltage range	Three-phase, 0 V up to the supply voltage	
Frequency range	0 to 3.4x rated motor frequency <sup>1)</sup>	
Switching frequency	Standard: 5 kHz (frames A, B, C, D); 2.5 kHz (frame E); 2 kHz (frames F, G and H) Available options 2.5 / 5 / 10 kHz	
Overload	Normal Duty (ND):	110% for 1 min every 10 min
		150% for 3 s every 10 min
	Heavy overload duty (HD):	150% for 1 min every 10 min
		200% for 3 s every 10 min
Time (ramps)	Acceleration	0 to 999s
	Deceleration	0 to 999s

Environment		
Operating temperature	Frame A...D IP20, IP21 and UL type 1 (NEMA1)	-10...60 °C (above 50 °C, current derating is necessary)
	Frame E IP20, IP21 and UL type 1 (NEMA1)	-10...55 °C (above 45 °C, current derating is necessary)
	All models of Frame F and G, IP20 except for 720T4 and 760T4	
	Models 720T4 and 760T4 (Frame G) and all Frame H	-10...55 °C (above 40 °C, current derating is necessary)
	Frame B...E IP55 / UL type 12 (NEMA 12)	-10...50 °C (above 40 °C, current derating is necessary)
Humidity		5 to 95% non-condensing
Altitude		Up to 1,000 m - rated conditions From 1000 m to 4000 m with current derating (1% for each 100 m above 1000 m) From 2000 to 4000 m - current derating of 1.1% for each 100 m above 2000 m

Note: 1) This maximum value may change according to the control mode and switching frequency. The maximum allowable speed is 18,000 rpm.

Protection rating	
IP21	Standard for frames A, B, C. For frame D the top cover kit should be added. Option not available for frames E, F, G and H.
IP20	Standard for frames D, E, F, G and H. In frames A, B and C, the top cover must be removed.
NEMA1	Standard for frame D. Optional for frames A, B, C, E, F, and G.
IP55/NEMA12	Optional for frames B, C, D and E.

Braking methods	
Dynamic braking	Available with built-in IGBT braking or external module (DBW03 or DBW04)
	External braking resistor (not supplied)
Optimal braking	No braking resistor required
DC braking	Direct current applied to the motor

Performance			
Speed control	V/F	Regulation: 1% of the rated speed Speed variation range: 1:20	
		Voltage vector (VW)	Regulation: 1% of the rated speed Speed variation range: 1:30
	Sensorless vector	Regulation: 0.5% of the rated speed Speed variation range: 1:100	
		Vector with encoder (assynchronous or permanente magmet motor)	Regulation: ±0.01% of the rated speed with 14-bit analog input (IOA) Regulation: ±0.01% of the rated speed with digital reference (keyboard, serial fieldbus, electronic potentiometer, multispeed) Regulation: ±0.05 % of the rated speed with 12-bit analog input
	Torque control	Vector with encoder (assynchronous motor and permanente magmet motor) or sensorless (permanente magmet motor)	Range: 10 to 180% Regulation: ±5% of the rated torque
		Sensorless vector (assynchronous motor)	Range: 20 to 180% Regulation: ±10% of the rated torque (above 3 Hz)

Inputs and outputs (I/Os) in the standard product		
Inputs	Digital	6 isolated inputs, 24 V dc, programmable functions
	Analog	2 isolated differential inputs by the differential amplifier, programmable functions
		Resolution AI1: 12 bits AI2: 11 bits + signal
		Signals: 0 to 10 V dc, 0 to 20 mA or 4 to 20 mA
		Impedance 400 kΩ for 0 to 10 V dc signal 500 Ω for 0 to 20 mA or 4 to 20 mA signal
Outputs	Relay	3 relay outputs with NO/NC contacts, 240 V ac / 2 A, programmable functions
	Analog	2 isolated outputs, programmable functions
		Resolution: 11 bits
		Load: 0 to 10 V: RL ≥ 10 kΩ 0 to 20 mA or 4 to 20 mA: RL < 500 Ω
Power supply available to the user		24 V dc + -20%, 500 mA

## Technical Data

Communication	
Profibus-DP	PROFIBUS-DP-01 (slot 3) PROFD-05 (slot 4)
DeviceNet	CAN/RS485-01 (slot 3)
	CAN-01 (slot 3)
	DEVICENET-05 (slot 4)
EtherCAT	ETHERCAT-05 (slot 4)
	Special Ve 65.84 firmware required
CANopen	CAN/RS485-01 (slot 3)
	CAN-01 (slot 3)
CANopen and Modbus-RTU master/slave	PLC11-01 and PLC11-02 (slots 1, 2 and 3)
EtherNet/IP	1 port: ETHERNETIP-05
	2 ports: ETHERNETIP-2P-05 (slot 4)
Modbus-TCP	1 port: MODBUSTCP-05
	2 ports: MODBUSTCP-2P-05 (slot 4)
PROFINET IO	2 ports: PROFINETIO-05 (slot 4)
BACnet	CAN/RS485-01 (slot 3)
	Special Ve 5.3X firmware required.
Modbus-RTU (RS485)	RS485-01 (slot 3)
	CAN/RS485-01 (slot 3)
	RS485-05 (slot 4)
Modbus-RTU (RS232)	RS232-01 e RS232-02 (slot 3)
	RS232-05 (slot 4)
USB	Built-in the standard product
	Communication with SuperDrive G2 software
	Communication with WLP software used for programming and monitoring the SoftPLC function and PLC11

Safety standards
Safety standards
UL 840: Insulation coordination including clearances and creepage distances for electrical equipment
EN 61800-5-1: Safety requirements electrical, thermal and energy
EN 50178: Electronic equipment for use in power installations
EN 60204-1: Safety of machinery. Electrical equipment of machines. Part 1: General requirements. Note: In order to have a machine in accordance with this standard, the manufacturer of the machine is responsible for installing an emergency stop device and a device for disconnection from the power line.
EN 60146 (IEC 146): Semiconductor converters
EN 61800-2: Adjustable speed electrical power drive systems - Part 2: General requirements - rating specifications for low voltage adjustable frequency a.c. power drive systems

Mechanical construction standards
EN 60529 - Degrees of protection provided by enclosures (IP Code)
UL 50 - Enclosures for electrical equipment
IEC60721-3-3 - Classification of environmental conditions - part 3: classification of groups of environmental parameters and their severities - section 3: stationary use at weatherprotected locations Level: 3M4

Protections
Overcurrent/short circuit
Under/overvoltage on the power circuit
Phase loss
Overtemperature on the inverter (IGBTs, rectifier and internal air on the electronic boards)
Motor overtemperature
Overload on the braking resistor
Overload on the IGBTs
Motor overload
External Fault/Alarm
Fault on the CPU or memory
Phase-ground short circuit in the output
Fault of the heatsink fan
Motor overspeed
<i>Incorrect encoder connection</i>

Electromagnetic compatibility standards (EMC)
EN 61800-3 - Adjustable speed electrical power drive systems Part 3: EMC product standard including specific test methods
EN 55011 - Limits and methods of measurement of radio disturbance characteristics of industrial, scientific and medical (ISM) radio-frequency equipment
CISPR 11 - Industrial, scientific and medical (ISM) radio-frequency equipment Electromagnetic disturbance characteristics Limits and methods of measurement
EN 61000-4-2 - Electromagnetic Compatibility Standards (EMC) Part 4: Testing and measurement techniques - Section 2: Electrostatic discharge immunity test
EN 61000-4-3 - Electromagnetic Compatibility Standards (EMC) Part 4: Testing and measurement techniques - Section 3: Radiated, radiofrequency, electromagnetic field immunity test
EN 61000-4-4 - Electromagnetic Compatibility Standards (EMC) Part 4: Testing and measurement techniques - Section 4: Electrical fast transient / burst immunity test
EN 61000-4-5 - Electromagnetic Compatibility Standards (EMC) Part 4: Testing and measurement techniques - Section 5: Surge immunity test
EN 61000-4-6 - Electromagnetic Compatibility Standards (EMC) Part 4: Testing and measurement techniques - Section 6: Immunity to conducted disturbances, induced by radio-frequency fields
EN 61000-4-11 - Testing and measurement techniques - Voltage dips, short interruptions and voltage variations immunity tests

**Global presence** is essential,  
as much as understanding your needs.

### Global Presence

With more than 30.000 employees worldwide, WEG is one of the largest electric motors, electronic equipments and systems manufacturers. We are constantly expanding our portfolio of products and services with expertise and market knowledge. We create integrated and customized solutions ranging from innovative products to complete after-sales service.

WEG's know-how guarantees our **Variable Speed Drive** is the right choice for your application and business, assuring safety, efficiency and reliability.



**Availability** is to have a global support network



**Partnership** is to create solutions that suit your needs



**Competitive edge** is to unite technology and innovation

## Know More

High performance and reliable products to improve your production process.

Excellence is to provide a whole solution in industrial automation that improves our customers productivity.



Visit:

[www.weg.net](http://www.weg.net)



[youtube.com/wegvideos](https://youtube.com/wegvideos)

For WEG's worldwide  
operations visit our website



[www.weg.net](http://www.weg.net)



**AUTOMATION**

 +55 47 3276.4000

 [automacao@weg.net](mailto:automacao@weg.net)

 Jaraguá do Sul - SC - Brazil

Cod: 50019076 | Rev: 27 | Date (m/a): 08/2021.

The values shown are subject to change without prior notice.

The information contained is reference values.