

Servo Drive

SCA06

Programming Manual

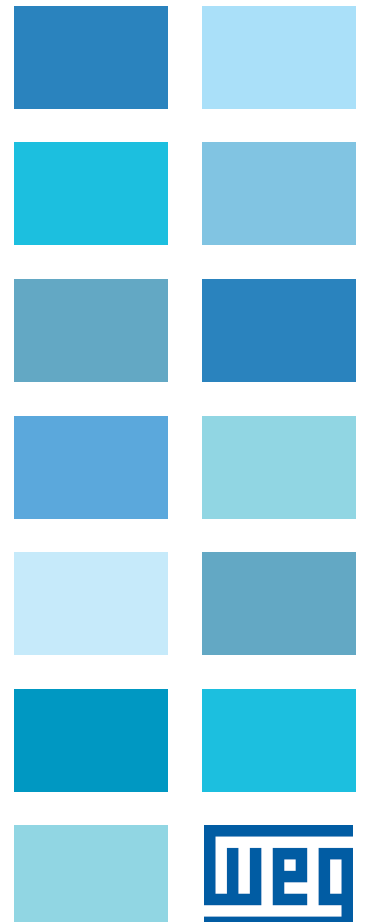



Programming Manual

Series: SCA06

Language: English

Document: 10002087836 / 03

Software Version: V2.1X

Publication Date: 02/2019

The information below describes the reviews made in this manual.

Version	Review	Description
V1.2X	R00	First edition
V1.4X	R01	General revision
V1.4X	R02	General revision
V2.1X	R03	General revision

1 SAFETY INSTRUCTIONS	1-1
1.1 SAFETY WARNINGS IN THIS MANUAL	1-1
1.2 SAFETY WARNINGS ON THE PRODUCT	1-1
1.3 PRELIMINARY RECOMMENDATIONS	1-2
2 GENERAL INFORMATION.....	2-1
2.1 ABOUT THE MANUAL	2-1
2.1.1 Terms and Definitions Used in the Manual.....	2-1
2.1.2 Numerical Representation	2-2
2.1.3 Symbols for Describing Properties of the Parameters	2-2
3 ABOUT THE SCA06	3-1
4 HMI.....	4-1
4.1 KEYS	4-1
4.2 EXAMPLES OF THE HMI SCREENS.....	4-2
5 FAULTS AND ALARMS.....	5-1
6 PROGRAMMING AND OPERATION.....	6-1
7 LADDER	7-1
8 PARAMETER STRUCTURE.....	8-1
9 READING PARAMETERS.....	9-1
10 CONFIGURATION AND CONTROL PARAMETERS	10-1
10.1 GENERAL CONFIGURATIONS.....	10-1
10.2 ANALOG INPUT	10-13
10.3 ANALOG OUTPUTS	10-16
10.4 DIGITAL INPUTS AND OUTPUTS.....	10-18
10.5 ENCODER SIMULATOR	10-23
10.6 POWER FAN	10-25
10.7 MOTOR POSITION SENSOR.....	10-25
11 MOTOR/CURRENT CONTROL PARAMETERS	11-1
12 SPECIAL FUNCTIONS	12-1
12.1 ABSOLUTE POSITION	12-1
12.2 STANDARD FAST COUNTER.....	12-2
12.3 STOP FUNCTION	12-9
12.4 LIMIT SWITCH FUNCTION	12-10
12.5 TRACE FUNCTION	12-10
12.6 SELF-TUNING FUNCTION	12-16
13 SERIAL COMMUNICATION PARAMETERS.....	13-1
14 CAN NETWORK PARAMETERS	14-1

15 PROFIBUS PROTOCOL PARAMETERS	15-1
16 ETHERNET NETWORK PARAMETERS.....	16-1
17 ETHERCAT NETWORK PARAMETERS	17-1
18 LADDER PARAMETERS.....	18-1
19 USER’S PARAMETERS	19-1
20 POSITIONER FUNCTION	20-1
20.1 THE AVAILABLE MOTIONS ARE:	20-1
20.1.1 Relative Positioning:	20-1
20.1.2 Absolute Positioning.....	20-2
20.1.3 Drive in Speed Control.....	20-2
20.1.4 Drive in Iq control (Torque).....	20-3
20.1.5 Position Follower	20-3
20.1.6 Speed Follower	20-3
20.1.7 Search Zero Machine Positive Direction.....	20-4
20.1.8 Search Zero Machine Negative Direction	20-4
20.1.9 Jog Function	20-4
20.2 DESCRIPTION OF THE PARAMETERS	20-5
20.3 EXAMPLES.....	20-18

1 SAFETY INSTRUCTIONS

This manual, together with the User's Manual, contains information necessary for the correct use of the SCA06 servo drive.

It was developed to be used by people with proper technical training or qualification to operate this kind of equipment.

This manual presents all the functions and parameters of the SCA06, but it is not intended to explain every possible application of the SCA06. WEG will not take any liabilities for applications not described in this manual.

This product is not intended for applications whose purpose is to ensure physical integrity and/or life of people, or for any other application in which a fault of the SCA06 may create a situation of risk to the physical integrity and/or life of people. The engineer who applies the SCA06 must provide ways to ensure the safety of the installation even in case of a failure of the servo drive.

1.1 SAFETY WARNINGS IN THIS MANUAL

In this manual, the following safety warnings are used:

**DANGER!**

The procedures recommended in this warning have the purpose of protecting the user against death, serious injuries and considerable material damage.

**DANGER!**

Les procédures concernées par cet avertissement sont destinées à protéger l'utilisateur contre des dangers mortels, des blessures et des détériorations matérielles importantes.

**ATTENTION!**

The not following of the procedures recommended in this warning can lead to material damages.

**NOTE!**

The text aims at providing important information for the full understanding and proper operation of the product.

1.2 SAFETY WARNINGS ON THE PRODUCT

The following symbols are fixed to the product, as a safety warning:



High voltages present.



Component parts sensitive to electrostatic discharges.
Do not touch them.



Mandatory connection to the protection grounding (PE).



Connection of the shield to the grounding.

1.3 PRELIMINARY RECOMMENDATIONS

**DANGER!**

Only trained personnel, with proper qualifications, and familiar with the SCA06 servo drive and associated machinery shall plan and implement the installation, starting, operation, and maintenance of this equipment.

The personnel shall follow all the safety instructions described in this manual and/or defined by the local regulations.

Failure to comply with the safety instructions may result in death, serious injury, and equipment damage.

**DANGER!**

Seulement personnes avec la qualification adéquate et familiarisation avec le SCA06 et équipements associés doivent planifier ou implémenter l'installation, mise en marche, operation et entretien de cet équipement.

Cettes personnes doivent suivre toutes les instructions de sécurités indiquées dans ce manuel, et/ou définies par normes locales.

L'inobservance des instructions de sécurité peut résulter en risque de vie et/ou dommages de cet équipement.

**NOTE!**

For the purposes of this manual, qualified personnel are those trained in order to be able to:

1. Install, ground, power up and operate the SCA06 in accordance with this manual and the safety legal procedures in force.
2. Use the protective equipment according to the relevant standards.
3. Give first aid.

**DANGER!**

Always disconnect the main power supply before touching any electrical device associated with the servo drive.

Several components may remain charged with high voltage and/or in movement (fans), even after the AC power supply has been disconnected or turned off.

Wait at least 10 minutes to guarantee the fully discharge of capacitors.

Always connect the equipment frame to the ground protection (PE).

**DANGER!**

Débranchez toujours l'alimentation principale avant d'entrer en contact avec un appareil électrique associé au Entraînement d'asservissement. Plusieurs composants peuvent rester chargés à un potentiel électrique élevé et/ou être en mouvement (ventilateurs), même après la déconnexion ou la coupure de l'alimentation en courant alternatif.

Attendez au moins 10 minutes que les condensateurs se déchargent complètement.

Raccordez toujours la masse de l'appareil à une terre protectrice (PE).

**ATTENTION!**

The electronic boards have components sensitive to electrostatic discharges. Do not touch directly the components or connectors. If necessary, first touch the grounded metallic frame or use proper grounding strap.

**Do not carry out any applied potential test on the servo drive!
If necessary, contact WEG.**

**NOTE!**

Servo drive may interfere in other electronic equipment. Follow the recommended procedures to minimize those effects.

**NOTE!**

Read the programming manual and the user's manual completely before installing or operating the servo drive.

**NOTE!**

The reproduction of the information in this manual, in whole or in part, is permitted provided that the source is cited.

2 GENERAL INFORMATION

2.1 ABOUT THE MANUAL

This manual provides the necessary information to configure all the functions and parameters of the SCA06 servo drive. This manual must be used together with the user's manual of the SCA06.

For further details about the installation, how to perform the commissioning, technical characteristics and how to identify and correct the most common problems of the SCA06 servo drive, refer to the user's manual.

For information about other functions, accessories and operating conditions, refer to the accessory manuals, CANopen communication manual and the online Help included in the WLP/WPS.

The accessory manuals are provided with them. However, all manuals are available for download on WEG website - www.weg.net.

2.1.1 Terms and Definitions Used in the Manual

Amp, A: Ampere.

DC Link: intermediary circuit of the servo drive; voltage in direct current obtained by rectifying the alternate power supply voltage or through an external source; it supplies the output inverter bridge formed by the IGBTs.

U, V and W arm: set of two IGBTs of the servo drive output phases U, V and W.

°C: degrees Celsius.

AC: alternate current.

DC: direct current.

Pre-Charge Circuit: it loads the capacitors of the DC link with limited current, greater current peaks at the energizing of the servo drive.

FMC: flash memory card that allows storing backups of the user's program and parameters.

CRC: cyclic Redundancy Check. Code generated to ensure data integrity.

Heatsink: metal part designed to dissipate the heat produced by semiconductors of power.

EEPROM: non-volatile memory that stores the parameters and password values.

Shaft: the drive shaft related to the servomotor connected to the servo drive.

Switching Frequency: commutating frequency of the IGBTs of the inverter bridge, normally expressed in kHz.

HMI: Human Machine Interface; device that allows controlling the servomotor, and viewing and changing the parameters of the servo drive. The HMI features keys for the command of the servomotor, browsing keys and LED display.

Hz: hertz.

IGBT: insulated Gate Bipolar Transistor - basic component part of the output inverter bridge. It works as an electronic switch in the saturated (closed switch) and cut-off (open switch) modes.

Braking IGBT: it works as a switch to turn on the braking resistor. It is automatically controlled by the DC link level.

Iq: it is the part of the current, in rms Amperes, which generates the motor torque.

kHz: kilohertz = 1000 hertz.

Ladder: programming language used to make the user's program (software application). This term is also used to address the user's program (software application) that can run in the SCA06 and the operating mode in which this program controls the shaft.

mA: milliampere = 0.001 ampere.

MC: movement Control: All the blocks that imply shaft movement.

FLASH Memory: non-volatile memory that may be electrically written and erased.

RAM Memory: Random Access Memory. Characterized for being volatile, that is, it loses the data when the servo drive is shut down.

Min: minute.

ms: millisecond = 0.001 second.

N.m: newton meter; unit of torque.

PE: Protective Earth.

PTC: resistor whose resistance value in ohms increases proportionally to the temperature; used as temperature sensor in servomotors.

PWM: Pulse Width Modulation - modulation by pulse width; pulsed voltage that feeds the servomotor.

Rectifier: input circuit of the servo drive that transform the input AC voltage into DC. It is formed by high-power diodes.

RMS: Root Mean Square - effective value.

RPM: revolutions per minute.

STO: Safe Torque Off; special safety function of the servo drive.

s: second.

USB: Universal Serial Bus - type of serial communication interface designed to operate according to the plug-and-play concept.

V: volts.

Ω: ohms.

2.1.2 Numerical Representation

The decimal numbers are represented by means of digits without suffix. Hexadecimal numbers are represented with the letter "h" after the number.

2.1.3 Symbols for Describing Properties of the Parameters

RO Read only parameter.

RW Reading and writing parameter.

DD Parameter can only be changed with the servo drive disabled.

PP Parameter value is only valid after pressing the P key.

AC Parameter visible on the HMI only when the correspondent accessory is connected.

3 ABOUT THE SCA06

The SCA06 servo drive is a high-performance product which allows controlling the speed, torque and position of three-phase, alternate-current servomotors. The main characteristic of this product is the high performance and high precision of movement control of the servomotor due to the operation in closed loop by means of the position feedback given by a sensor inside the servomotor.

The SCA06 features independent control supply and power supply, allowing, for instance, that the product communication networks keep on working normally even if the power circuit must be turned off for some reason.

The use of braking resistors provides greatly reduced braking times, optimizing the processes that require high performance.

Several special functions are available, such as programming in ladder with positioning blocks which provides extreme flexibility and integration to the drive.

The SCA06 can be used in different applications with many options of cables, both for simple applications and complex applications like handling, environments with oil, etc.

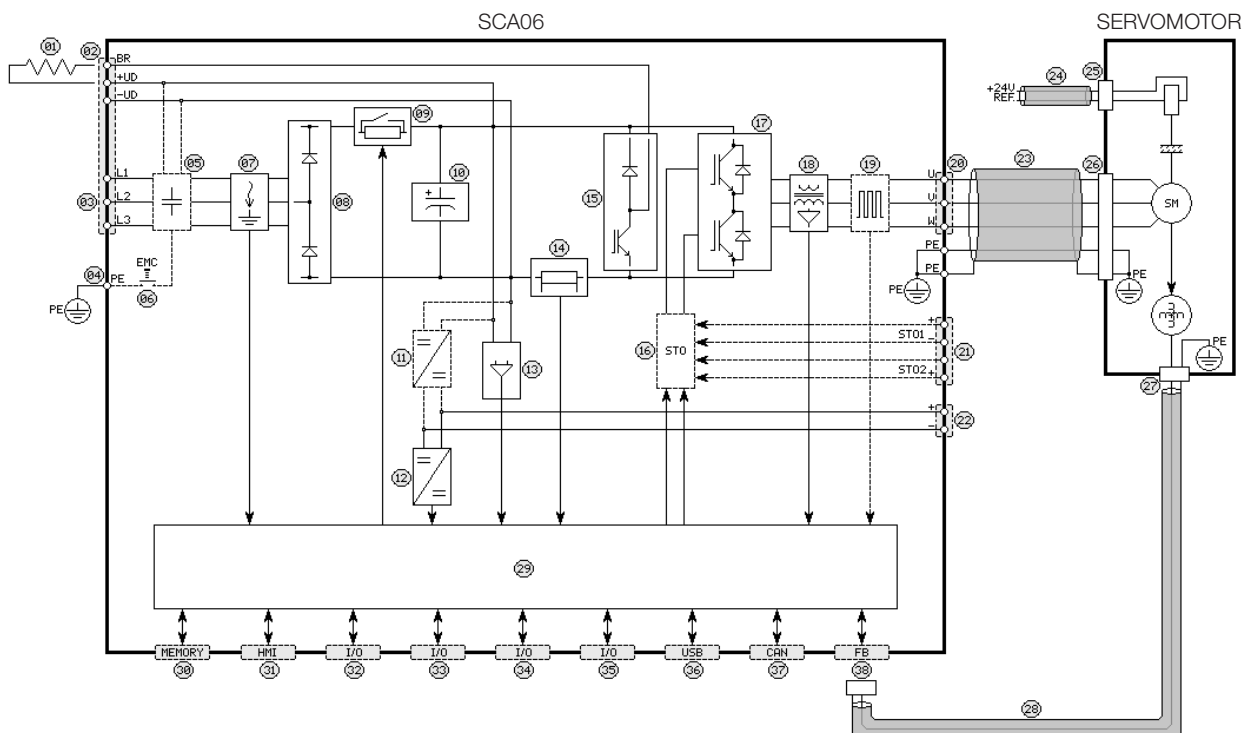

- | | |
|---------------------------------|--|
| 1 - Braking resistor | 20 - Output connector for servomotor (X8) |
| 2 - Power supply connector (X9) | 21 - STO control connector (X7) |
| 3 - Power supply | 22 - Control power supply connector (X5) |
| 4 - Servo drive grounding | 23 - Servomotor power cable |
| 5 - RFI filter board (optional) | 24 - Control cable of the servomotor brake |
| 6 - RFI filter disconnection | 25 - Control connector of the servomotor brake |
| 7 - Ground fault detection | 26 - Servomotor power connector |
| 8 - Rectifier | 27 - Servomotor feedback connector |
| 9 - Pre-load | 28 - Servomotor feedback cable |
| 10 - DC link | 29 - Control card |
| 11 - Internal source (optional) | 30 - Flash memory card |
| 12 - Switched source | 31 - Human machine interface (HMI) |
| 13 - Voltage feedback | 31 - Connector for accessory 1 (Slot 1) |
| 14 - Overcurrent protection | 31 - Connector for accessory 2 (Slot 2) |
| 15 - Braking chopper | 34 - Connector for accessory 3 (Slot 3) |
| 16 - Safety card STO (optional) | 35 - Input/output connector (X1) |
| 17 - IGBT bridge | 36 - USB communication network (X3) |
| 18 - Current feedback | 37 - CAN communication network (X4) |
| 19 - Pulses feedback (optional) | 38 - Position feedback connector (X2) |

Figure 3.1: SCA06 block diagram

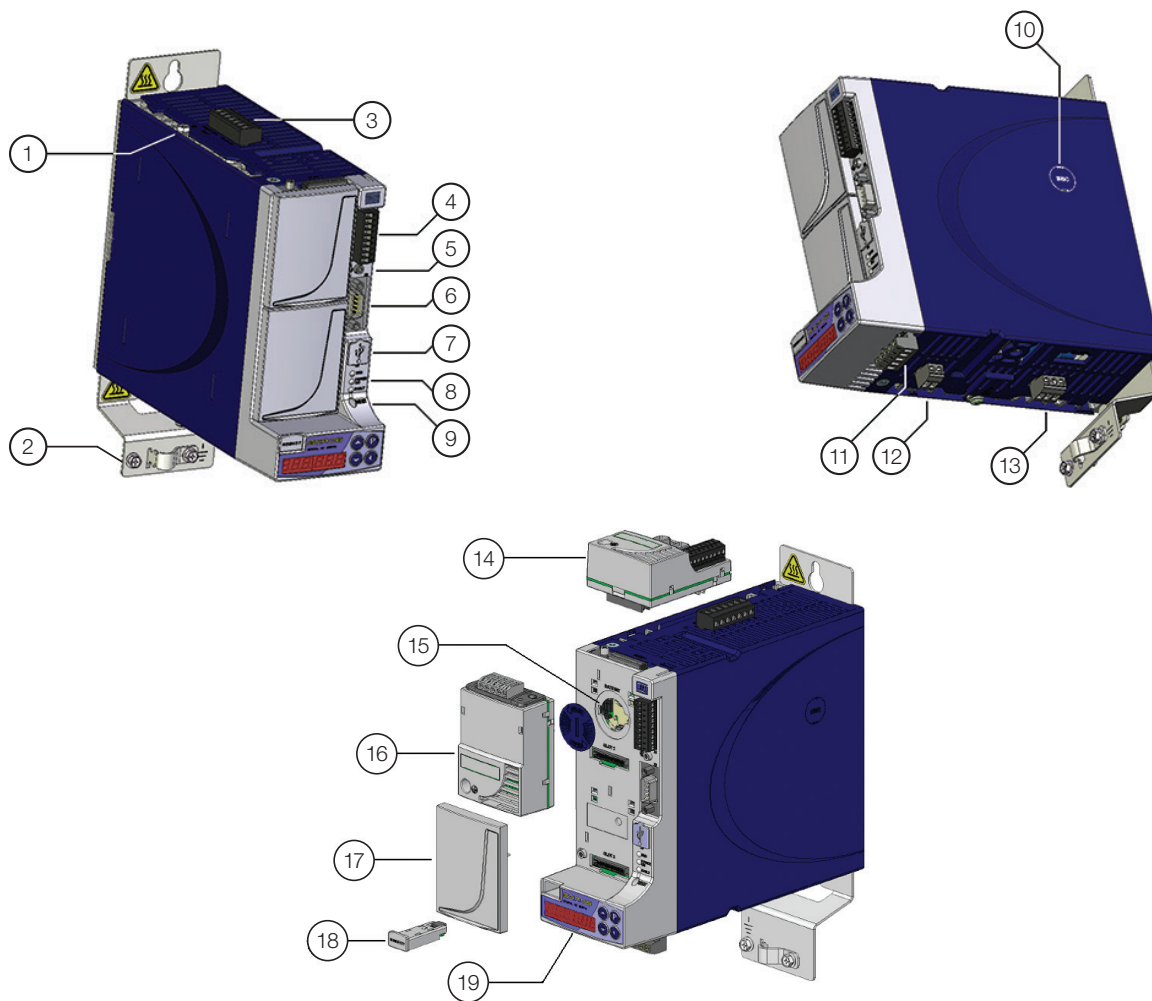

- | | |
|--|---|
| 1 - Servo drive grounding (PE) | 10 - RFI filter disconnection |
| 2 - Servomotor grounding (PE) | 11 - CAN network (X4) |
| 3 - Power supply (X9) | 12 - Electronics supply (X5) |
| 4 - Standard I/Os (X1) | 13 - Servomotor connection (X8) |
| 5 - Shield grounding for analog input signal cable | 14 - Module for accessories (sold separately) |
| 6 - Position feedback (X2) | 15 - Battery |
| 7 - USB network (X3) | 16 - Module for accessories (sold separately) |
| 8 - Status LEDs | 17 - Blind cover |
| 9 - Reset | 18 - Flash memory card (FMC) |
| | 19 - Human-Machine Interface (HMI) |

Figure 3.2: SCA06 servo drive

X1		Description	Function	Specification
1	C		Relay digital output 1	Ton/off: 3 ms Average useful life: 100,000 oper V _{máx} : 240 Vac 200 Vdc I _{máx} .: 0.25 A @ 240 Vac 0.50 A @ 125 Vac 2.00 A @ 30 Vcc
2	NA			
3	DI1		Optocoupled digital input 1	High level: ≥ 18 V Low level: ≤ 3 V Max. voltage: 30 V Input current: 3.7 mA @ 24 Vdc Maximum frequency: 500 kHz Maximum delay time: 0.5 μ s
4	DI2			
5	COM 1,2		Optocoupled digital input 2	
6	DI3		Optocoupled digital input 3	High level: ≥ 18 V Low level: ≤ 3 V Max. voltage: 30 V Input current: 11 mA @ 24 Vdc Maximum delay time Leading edge = 10 μ s Leading edge = 50 μ s
7	COM 3			
8	AI1 +		Differential analog input 1	Signal: -10 to +10 V Resolution: 12 bits V _{max} : ± 14 V Impedance: 400 k Ω
9	AI1 -			

Figure 3.3: Connector X1 = digital inputs, analog and relay output

4 HMI

Through the HMI, it is possible to control the servo drive, view and set all of its parameters. It features a LED display with six digits of seven segments and four keys with the increment, decrement PROG and SHIFT functions.

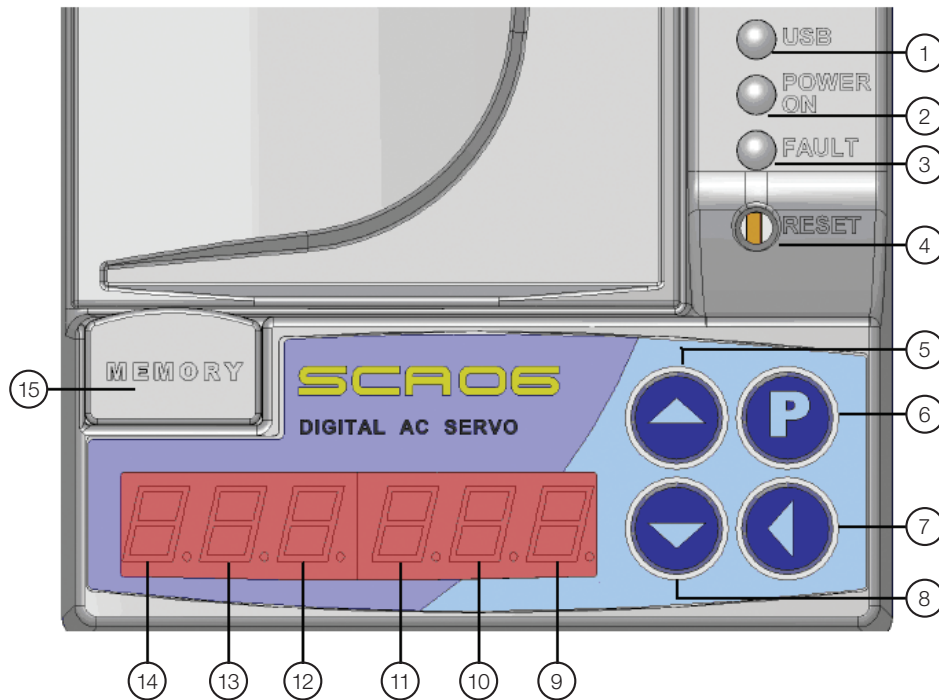

- | | |
|---|------------------------------|
| 1 - Indication LED of USB communication | 9 - Digit 1 |
| 2 - Indication LED of power supply ON | 10 - Digit 2 |
| 3 - Indication LED of fault | 11 - Digit 3 |
| 4 - Reset key | 12 - Digit 4 |
| 5 - Increment key | 13 - Digit 5 |
| 6 - PROG key | 14 - Digit 6 |
| 7 - SHIFT key | 15 - Flash memory card (FMC) |
| 8 - Decrement key | |

Figure 4.1: HMI Illustration

4.1 KEYS

The servo drive is not detachable and features four keys whose function is described below.



PROG: Key used to change the mode of the parameters and/or validate the modified values. When the parameters are in the search mode, pressing the P key will change them to the view or modification mode, depending on the selected parameter. Some parameters, whose property is PP (Press P), have their value modified only after pressing the P key.

For parameters that may be modified online, the servo drive starts using the new adjusted value immediately and those parameters have only two modes: the search mode (which presents the letter P and then the parameter number) and the modification mode (which presents the content of the selected parameter, allowing the modification).

The parameters that must not be modified online can have three modes: the two mentioned above and an intermediate one, the view mode, which only displays the content of the parameter without allowing any modification. In this case, the modified value (already in the modification mode) is only used by the servo drive after the P key is pressed, returning to the search mode.

Pressing the P key in the parameters that are not "Only Reading", the value contained in the parameter is automatically recorded in the non-volatile memory of the servo drive and remains recorded until new change, except when the parameter P00664 = 0.



DECREMENT: Key used to navigate in a decreasing way through the parameters, or decrease the content of the respective parameter when in the modification mode.



INCREASE: Key used to navigate in an incrementing way through the parameters, or increase the content of the respective parameter when in the modification mode.



SHIFT: When the key is pressed in the View mode, the parameter returns to the Search mode, displaying the parameter number. When pressed in the View mode, it allows the user to move the digit he wishes to change and it will show flashing on the HMI, indicating that it is the selected digit. For example: P00105 in the Modification mode: HMI displays the value 00200 with the digit 1 (value 0) flashing. The user wishes to modify the 5th digit. In order to do so, the user must press the SHIFT key four times; then the digit 5 (value 0) will start flashing indicating that, when pressing the increment or decrement key, its value will be modified.

Reset Located above the HMI keys, this key is accessed by using a small screwdriver or similar tool. Its effect is the same as turning the control off and back on, that is, whenever it is pressed, the software of the servo drive will reinitialize.

General Notes:

- To modify the value of a parameter, it is necessary first to adjust P00000 = Password Value, except when the option “Disable Password” is activated (P00200 = 0). The default password value is P00000 = 00005. Otherwise, it will only be possible to view the parameters, but not to modify them.
- The password to access the parameters can be changed by the user, if a value different from 5 is desired (for further details, see description of parameter P00200).

If the user forgets the programmed password, it is possible a reset to the default password. In order to do so, the user must keep pressing the PROG and DECREMENT keys simultaneously during the drive reset. Thus, the password becomes 5 again (default value).

- To initialize the drive, without enabling the user's program, it is necessary to keep pressing the keys SHIFT and INCREMENT simultaneously during the initialization or reset of the drive.

4.2 EXAMPLES OF THE HMI SCREENS

The HMI of the SCA06 can display several different screens, depending on the mode it is. When in the search mode, for example, the HMI displays the letter P in digit 6 followed by the corresponding parameter number, as shown in [Figure 4.2 on page 4-2](#).



Figure 4.2: HMI screen in the search mode

After pressing the P key once when HMI is in the Search mode, it goes to the View mode, showing the user the parameter value. [Figure 4.3 on page 4-2](#) shows an example of the HMI screen in View mode.



Figure 4.3: HMI screen in the view mode

The HMI screen in the Change mode (mode that allows the user to change the parameter value) is similar to the figure shown below, with the difference that in the Change mode the digit 1 keeps flashing showing the user that this is the digit that will be changed by pressing the increment or decrement key, as shown in [Figure 4.4 on page 4-3](#). When you press the SHIFT key, the digit that is flashing changes to the next digit on the right.



Figure 4.4: HMI Screen in the change mode

Other possible screens on the HMI of the SCA06 are those that inform the user of a special condition, such as an occurrence of an alarm or fault, loading factory default, download of the application and backup of the parameters on the memory card.

[Figure 4.5 on page 4-3](#) shows the HMI screen when an alarm occurred.



Figure 4.5: HMI screen when an alarm occurred

When a fault occurs, the HMI screen displays a characteristic similar to that displayed when an alarm occurs, with the difference that instead of displaying the letter "A" in digit 6, it displays the letter "F", as shown in [Figure 4.6 on page 4-3](#).



Figure 4.6: HMI screen when a fault occurred

If it is selected the option to perform backup of the parameters on the memory card or the option to load on servo drive the parameter values stored on the memory card, while the data transference is taking place, the HMI screen will display the letter "b" in low case flashing in digit 1. [Figure 4.7 on page 4-3](#) shows the HMI performing the backup of the parameters on the memory card.



Figure 4.7: HMI screen when you select the option to perform backup of the control parameters to the flash memory card or vice versa

When the download of the application or configuration of the user's parameters is performed via WLP/WPS to the servo drive, the HMI screen will display the letter "d" in low case flashing in digit 1, as shown in [Figure 4.8 on page 4-3](#).



Figure 4.8: HMI screen when downloading the WLP/WPS to the control

The other screen option listed above is when the option to load the default factory values is selected, which displays the letter "P" flashing in digit 1, as shown in [Figure 4.9 on page 4-4](#).



Figure 4.9: HMI screen when the option to load the default factory values is selected

When selecting the option that, in addition to loading the default factory values, also allows deleting the entire content of the flash memory card, the HMI displays two consecutive screens. The first one shows the letter "P" flashing in digit 1, as shown in Figure 4.9 on page 4-4 and then it will display the letter "E" flashing, also in digit 1, as shown in Figure 4.10 on page 4-4.



Figure 4.10: HMI screen when you select the option to erase the content of the memory card

When you select the option to execute the self-tuning, the message displayed on HMI will be "Auto0X", where X is the current phase of execution of the self-tuning, and it may range from 0 to 8, as shown in Figure 4.11 on page 4-4.



Figure 4.11: HMI screen during the execution of the self-tuning - phase 02

At the end of the self-tuning, the HMI will display the message "End", as illustrated in Figure 4.12 on page 4-4.



Figure 4.12: HMI screen at the end of the self-tuning

Another possible HMI screen is when the safety function STO is activated. When that happens, the display will show the message "Sto" (Safety Torque Off), as shown in Figure 4.13 on page 4-4.



Figure 4.13: HMI screen when activating the safety function STO

5 FAULTS AND ALARMS

The problem detection structure in the servo drive is based on the fault and alarm indication.

In case of fault, the IGBTs will be locked and the servomotor will stop by inertia, besides the fault indication on the display and on the fault led. The alarm works as a warning for the user of critical conditions that are occurring and which may cause a fault if the situation is not corrected.

When an alarm occurs, it will be indicated on the HMI and stored in the current alarm parameter, blocking the occurrence of new alarms until the current alarm condition stops existing (but it will not block the occurrence of faults).

The fault indication has a similar behavior, with the difference that to release the occurrence of news faults, it is required to reset the existent fault.

A list with the alarm numbers and fault numbers, along with a brief description and the possible causes for those errors, is presented in [Table 5.1 on page 5-1](#).

Table 5.1: Description of the alarms and faults and possible causes

Alarm/Fault	Description	Possible Causes
A00004	Battery voltage out of the acceptable limit.	<ul style="list-style-type: none"> ■ Low battery (low voltage level). ■ Poor connection of the battery.
A00015	Servomotor overload (only when P00230 = 1), the drive went into current limitation.	<ul style="list-style-type: none"> ■ Overload on the shaft. ■ High inertia.
A00052	Alarm when trying to activate MC block in Single mode when another block is already in execution.	<ul style="list-style-type: none"> ■ Attempt to execute MC block with Buffer Mode set to SINGLE, when another MC block is already being executed.
A00078	Error in the command to execute new movement.	<ul style="list-style-type: none"> ■ Internal fault.
A00101	Signal of fraction of revolution incompatible with the signal of number of revolution.	<ul style="list-style-type: none"> ■ Positive value in the number of revolutions (P00513, P00128 or P00130) and negative in the fraction of revolution of the corresponding user (P00512, P00127 or P00129) or vice-versa.
A00104	Error in the reading of the EEPROM.	<ul style="list-style-type: none"> ■ Defect on the non-volatile memory. ■ Internal error in the communication with the EEPROM.
A00105	Error in the writing of the EEPROM.	<ul style="list-style-type: none"> ■ Defect on the non-volatile memory. ■ Internal error in the communication with the EEPROM.
A00107	Overflow of the stack that stores the parameters to be recorded on the EEPROM.	<ul style="list-style-type: none"> ■ Defect on the non-volatile memory. ■ Internal error in the communication with the EEPROM.
A00120	Conflict of Enabling/Disabling of the servodrive.	<ul style="list-style-type: none"> ■ More than a device programmed to enable or disable the servo drive.
A00122	Attempt of writing on only-read parameter.	<ul style="list-style-type: none"> ■ Attempt of writing on only-read parameter.
A00124	Warning that the motor is enabled.	<ul style="list-style-type: none"> ■ Attempt to modify the parameter that requires that the motor be disabled.
A00125	Inexistent parameter.	<ul style="list-style-type: none"> ■ Attempt to access some parameter that does not exist.
A00126	Value outside limits.	<ul style="list-style-type: none"> ■ Attempt to write a value out of the adjustable range on some parameter.
A00127	Initial value of the parameter out of the limits.	<ul style="list-style-type: none"> ■ Error in the reading of the EEPROM. ■ Value stored incorrectly on the EEPROM.
A00128	Serial Watchdog.	<ul style="list-style-type: none"> ■ Time to receive telegrams exceeded.
A00133	CAN interface without supply.	<ul style="list-style-type: none"> ■ Some protocol that uses the CAN interface is enabled, but this interface is not powered.
A00134	CAN interface: Bus Off.	<ul style="list-style-type: none"> ■ Devices connected to the CAN network with different baud rates. ■ Fault of termination resistors. ■ Short circuit, poor contact or changed wiring between the connecting cables. ■ Cable is too long for the selected transmission rate. ■ Improper grounding of the device or net.
A00135	CAN interface: Node Guarding/Heartbeat error.	<ul style="list-style-type: none"> ■ CANopen communication specific error. ■ For further information refer to the CANopen communication manual.
A00136 / F00036	Alarm indicates that the DeviceNet network master is in idle mode.	<ul style="list-style-type: none"> ■ Set the switch that controls the master operation of the master for Run or the corresponding bit on the configuration word of the master software. If further information is needed, refer to the documentation of the master used.

Alarm/Fault	Description	Possible Causes
A00137 / F00037	Alarm that indicates that one or more DeviceNet connections timed out.	<ul style="list-style-type: none"> Check the network master status. Check network installation, broken cable or fault/poor contact on the connections with the network.
A00138	Profibus DP Interface in clear mode.	<ul style="list-style-type: none"> Network master status is not in run mode (RUN).
A00139	Profibus DP Interface offline.	<ul style="list-style-type: none"> Network master is not configured. Short circuit or poor contact in the communication cables. Changed or inverted cables. Termination resistor with wrong values. Incorrect network installation.
A00140	Profibus DP interface access error.	<ul style="list-style-type: none"> Profibus DP module is incorrectly fitted. Hardware errors due to improper handling or installation of the accessory, for example, may cause this error. If possible, carry out tests by replacing the communication accessory.
A00141	Encoder 1 Input error.	<ul style="list-style-type: none"> One of the encoder 1 input differential signals is not connected.
A00142	Encoder 2 input error.	<ul style="list-style-type: none"> One of the encoder 2 input differential signals is not connected.
A00145	Error in the access to the interface of the EtherCAT accessory.	<ul style="list-style-type: none"> It indicates error in the data exchange between the SCA06 servo drive and the EtherCAT accessory.
A00146	Communication error during operation data exchange via EtherCAT.	<ul style="list-style-type: none"> It indicates error in the communication between the slave and the EtherCAT master.
A00147 / F00047	Indicates communication failure between the slave and the network controller.	<ul style="list-style-type: none"> Verify that the network master is correctly configured and operating normally. Check for short circuit or bad contact in communication cables. Check the network installation in general - cable routing, grounding.
A00148 / F00048	Indicates failure to exchange data between the SCA06 servo inverter and the Ethernet accessory.	<ul style="list-style-type: none"> Check that the accessory is connected correctly. Check if the firmware version of the device supports the Ethernet accessory. Hardware errors resulting, for example, from improper handling or installation of the accessory may cause this error. If possible perform tests by replacing the communication accessory.
A00150	Power heatsink overheating.	<ul style="list-style-type: none"> High output current. Internal fan blocked or defective. Ambient temperature around the servo drive too high. Heatsink dirty or blocked.
A00152	High temperature of internal air.	<ul style="list-style-type: none"> High ambient temperature. Internal fan blocked or defective. Ambient temperature around the servo drive too high.
A00171	Power fan overload.	<ul style="list-style-type: none"> Dirt or foreign body decreasing the power fan speed.
A00172	Power fan stuck or defective.	<ul style="list-style-type: none"> Dirt or foreign body making the power fan stop.
A00174	Electronics fan partial obstruction.	<ul style="list-style-type: none"> Dirt or foreign body decreasing the fan speed.
A00175	Electronics fan blocked.	<ul style="list-style-type: none"> Dirt or foreign body making the fan stop.
A00210	Error in accessory EAN1.	<ul style="list-style-type: none"> Defect in the internal circuitry of the accessory EAN1.
A00214	Fault on the drive of the encoder simulator.	<ul style="list-style-type: none"> Encoder simulator with no power supply or power supply out of the specified range.
A00350	CAN especial1 timeout error.	<ul style="list-style-type: none"> Communication error between master and the SCA06 for CAN especial1 protocol.
A00708	Alarm indicating that the PLC application is not running.	<ul style="list-style-type: none"> Invalid ladder application. No ladder application. PLC application has been stopped and Supervisory PLC parameter is programmed to generate alarm.
A00826	Wrong ladder application CRC.	<ul style="list-style-type: none"> Internal flash memory defect. Fault in the download of the application. Application incompatible with the installed firmware.
A00830	Flash memory card empty.	<ul style="list-style-type: none"> Flash memory card with no backup or application saved.
A00834	Memory card disconnected.	<ul style="list-style-type: none"> Memory card missing. Fault in the internal circuit of the card. Memory card is poorly connected.
A00950 to A00999	Alarm generated by the Ladder.	<ul style="list-style-type: none"> Execution of the USERERR block in the Ladder.
A01088	HMI communication error.	<ul style="list-style-type: none"> Internal communication error with the HMI.
A01101	FPGA project update. Driver reset required.	<ul style="list-style-type: none"> FPGA project was updated via USB.
A01102	Attempt to update the FPGA with high voltage of the DC link.	<ul style="list-style-type: none"> Power turned on while attempting to update the FPGA project.

Alarm/Fault	Description	Possible Causes
F00001	DC Link overvoltage.	<ul style="list-style-type: none"> ■ High power supply voltage. ■ Load with too high inertia. ■ Too short deceleration time. ■ Fault of the braking resistor.
F00002	DC Link undervoltage with drive enabled.	<ul style="list-style-type: none"> ■ Low supply voltage. ■ Phase fault in the input. ■ Fault in the pre-charge circuit.
F00003	24-V supply with voltage level out of the range specified (20 Vdc to 30 Vdc).	<ul style="list-style-type: none"> ■ External 24-V supply with too high or too low voltage. ■ Excessive ripple on the supply, exceeding the specified limits.
F00005	Overload on the servomotor.	<ul style="list-style-type: none"> ■ Load on the shaft too high. ■ High inertia.
F00006	External fault.	<ul style="list-style-type: none"> ■ Wiring in the digital inputs (programmed for external fault) open. ■ External error occurred.
F00008	External feedback loss.	<ul style="list-style-type: none"> ■ External encoder with problems in the mechanical or electrical connection. ■ Parameters P00210 or P00211 incorrectly set. ■ Parameter P00214 set with low value.
F00010	Fault on the connection of the drive to the motor.	<ul style="list-style-type: none"> ■ Motor cable not connected or poorly connected. ■ Defective motor cable or connector. ■ Defective motor.
F00011	Ground fault.	<ul style="list-style-type: none"> ■ Short circuit to the ground in one or more output phases. ■ Motor cable capacitance to the ground too high, causing current peaks in the output. ■ Fault in the motor internal insulation.
F00025	Accessory in inappropriate slot.	<ul style="list-style-type: none"> ■ Accessory connected to a slot not intended for the accessory.
F00027	Without jumper card.	<ul style="list-style-type: none"> ■ Jumper card missing in the power. ■ Card poorly connected.
F00028	Serial Watchdog.	<ul style="list-style-type: none"> ■ Time of sending the telegram exceeded.
F00032	Resolver Cable disconnected, or overtemperature on the servomotor.	<ul style="list-style-type: none"> ■ Resolver cable is defective, poorly connected or not installed. ■ Thermal overload on the servomotor (load excess, improper operation cycle, improper current limit, etc.).
F00033	CAN interface with without supply.	<ul style="list-style-type: none"> ■ Some protocol that uses the CAN interface is enabled, but this interface is not powered.
F00034	CAN interface: Bus off.	<ul style="list-style-type: none"> ■ Devices connected to the CAN network with different baud rates. ■ Fault of termination resistors. ■ Short circuit, poor contact or changed wiring between the connecting cables. ■ Cable is too long for the selected transmission rate. ■ Improper grounding of the device or net.
F00035	CAN interface: Node Guarding/Heartbeat error.	<ul style="list-style-type: none"> ■ CANopen communication specific error. ■ For further information refer to the CANopen communication manual.
F00038	Profibus DP Interface in clear mode.	<ul style="list-style-type: none"> ■ Network master status is not in run mode (RUN).
F00039	Profibus DP interface offline.	<ul style="list-style-type: none"> ■ Network master is not configured. ■ Short circuit or poor contact in the communication cables. ■ Changed or inverted cables. ■ Termination resistor with wrong values. ■ Incorrect network installation.
F00040	Profibus DP interface access error.	<ul style="list-style-type: none"> ■ Profibus DP module is incorrectly fitted. ■ Hardware errors due to improper handling or installation of the accessory, for example, may cause this error. If possible, carry out tests by replacing the communication accessory.
F00041	Encoder 1 Input error.	<ul style="list-style-type: none"> ■ One of the encoder 1 differential input signals is not connected.
F00042	Encoder 2 input error.	<ul style="list-style-type: none"> ■ One of the encoder 2 differential input signals is not connected.
F00045	Error in the access to the interface of the EtherCAT accessory.	<ul style="list-style-type: none"> ■ It indicates fault in the data exchange between the SCA06 servo drive and the EtherCAT accessory.
F00046	Communication error during operation data exchange via EtherCAT.	<ul style="list-style-type: none"> ■ It indicates fault in the communication between the slave and the EtherCAT master.

Alarm/Fault	Description	Possible Causes
F00049	Error of stop lag greater than the maximum configured in P01031 (check error only at the end of positioning).	<ul style="list-style-type: none"> ■ Ramps programmed with values that the motor cannot follow. ■ Low position gain and/or speed. ■ Type of motor incorrectly programmed (P00385). ■ $I_{dynamic}/I_{rated}$ relationship (P00136) too low. ■ Mechanics stuck.
F00050	Error of following lag greater than the maximum configured in P01032 (check error during all the travel).	<ul style="list-style-type: none"> ■ Ramps programmed with values that the motor cannot follow. ■ Low position gain and/or speed. ■ Type of motor incorrectly programmed (P00385). ■ $I_{dynamic}/I_{rated}$ relationship (P00136) too low. ■ Mechanics stuck.
F00058	Master reference missing.	<ul style="list-style-type: none"> ■ Synchronism master is deactivated. ■ Interruption in the receipt of the master reference.
F00070	Overcurrent fault in the output detected by hardware.	<ul style="list-style-type: none"> ■ Short circuit between motor phases. ■ Defect in the servo drive. ■ Servomotor overcurrent due to the parameterization.
F00071	Overcurrent fault in the output detected by software.	<ul style="list-style-type: none"> ■ Short circuit between motor phases. ■ Defect in the servo drive. ■ Servomotor overcurrent due to parameterization.
F00076	Improper braking resistor.	<ul style="list-style-type: none"> ■ Improper value for the drive in use (improper value of the resistance, power or resistor energy). ■ For further details, refer to the description of parameter P00154.
F00077	Braking resistor overload.	<ul style="list-style-type: none"> ■ Inappropriate value of resistor. ■ Fast deceleration. ■ For more details, see description of parameter P00155.
F00078	Error in command to execute movement.	<ul style="list-style-type: none"> ■ Internal firmware error. ■ Processor operating in an abnormal operating condition.
F00084	Hardware identification fault.	<ul style="list-style-type: none"> ■ Defect of the Internal circuit of the control card.
F00151	Overtemperature on the heatsink.	<ul style="list-style-type: none"> ■ High output current. ■ Blocked or defective internal fan. ■ Ambient temperature around the servo drive too high. ■ Dirty or blocked heatsink.
F00153	High temperature of internal air.	<ul style="list-style-type: none"> ■ High ambient temperature. ■ Blocked or defective internal fan. ■ Ambient temperature around the servo drive too high.
F00160	STO safety function fault.	<ul style="list-style-type: none"> ■ SSC optional card defect. ■ One of the safety signals missing.
F00212	Current below 3.5 mA (if accessory EAN1 is used and option P00239 = 1 is selected).	<ul style="list-style-type: none"> ■ Current signal missing, probably caused by a broken wire.
F00250	CAN especial1 timeout error.	<ul style="list-style-type: none"> ■ Communication error between master and the SCA06 for CAN especial1 protocol.
F00709	Failure indicates that the PLC application is not running.	<ul style="list-style-type: none"> ■ Invalid ladder application. ■ No ladder application. ■ PLC application has been stopped and PLC Supervision parameter is programmed to generate fault.
F00824	Error in the writing of the flash memory card.	<ul style="list-style-type: none"> ■ Memory card is poorly connected. ■ Internal defect on the memory card.
F00825	Error in the writing of the internal flash memory.	<ul style="list-style-type: none"> ■ Internal defect on the control card.
F00827	Error on the memory card CRC.	<ul style="list-style-type: none"> ■ File contained on the flash memory card is not compatible or corrupted.
F00829	Application exceed the programmed execution time.	<ul style="list-style-type: none"> ■ Application execution time is longer than the time set in parameter P01021.
F00950 to F00999	Fault generated by the Ladder block.	<ul style="list-style-type: none"> ■ Execution of the USERERR block on the ladder.
F01100	Initialization internal fault.	<ul style="list-style-type: none"> ■ Defect on the internal circuit of the control card.
F01105	Defect on the internal circuit of the control card.	<ul style="list-style-type: none"> ■ Defect on the internal circuit of the control card.
F01110	Firmware internal error.	<ul style="list-style-type: none"> ■ Processor operating in an abnormal operating condition.
F01112	Error on the CRC of the firmware, calculated on the Bootloader.	<ul style="list-style-type: none"> ■ Firmware file is corrupted. ■ Problem on the processor flash memory.
F01113	Firmware identification error, calculated on the Bootloader.	<ul style="list-style-type: none"> ■ Firmware file is corrupted. ■ Problem on the processor flash memory.
F01114	Firmware size error, calculated on the Bootloader.	<ul style="list-style-type: none"> ■ Firmware file is corrupted. ■ Problem on the processor flash memory.
F01115	Waiting for the firmware download.	<ul style="list-style-type: none"> ■ Firmware updating process interrupted.
F01120	Fault on the memory writing of the retentive variables.	<ul style="list-style-type: none"> ■ Defective servo drive. ■ Motor or motor ambient too hot.

Alarm/Fault	Description	Possible Causes
F01202	Motor encoder overtemperature.	<ul style="list-style-type: none"> ■ This fault only occurs when the motor position feedback device is an encoder and not a resolver. ■ Motor or motor ambient too hot.
F01205	Motor encoder signals not connected.	<ul style="list-style-type: none"> ■ This fault only occurs when the motor position feedback device is an encoder and not a resolver. ■ Defective motor encoder cable.
F01207	Motor encoder value invalid.	<ul style="list-style-type: none"> ■ This fault only occurs when the motor position feedback device is an encoder and not a resolver. ■ Defective motor encoder cable. ■ Defective motor encoder.
F01210	EES1 accessory not connected.	<ul style="list-style-type: none"> ■ This fault only occurs when the motor position feedback device is an encoder and not a resolver. ■ EES1 accessory is not connected or defective.
F01218	Fault in the reading/writing of the motor encoder memory.	<ul style="list-style-type: none"> ■ This fault only occurs when the motor position feedback device is an encoder and not a resolver. ■ Defective motor encoder.
F01220	Motor encoder fault.	<ul style="list-style-type: none"> ■ This fault only occurs when the motor position feedback device is an encoder and not a resolver. ■ Defective motor encoder.
F01221	Fault in the communication with the motor encoder.	<ul style="list-style-type: none"> ■ This fault only occurs when the motor position feedback device is an encoder and not a resolver. ■ Defective motor encoder cable. ■ Defective motor encoder. ■ Defective EES1 accessory.
F01224	Motor encoder reading/writing timeout.	<ul style="list-style-type: none"> ■ This fault only occurs when the motor position feedback device is an encoder and not a resolver. ■ Defective motor encoder cable. ■ Defective motor encoder. ■ Defective EES1 accessory.
F01232	Motor overtemperature.	<ul style="list-style-type: none"> ■ This fault only occurs when the motor position feedback device is an encoder and not a resolver. ■ Motor overload or motor ambient too hot.
F01245	Accessory EES2 not connected.	<ul style="list-style-type: none"> ■ This fault only occurs when the motor position feedback device is an EnDat encoder. ■ EES2 accessory not connected or defective.
F01246	Motor encoder fault.	<ul style="list-style-type: none"> ■ This fault only occurs when the motor position feedback device is an EnDat encoder. ■ Defect motor encoder. ■ Defect in the EES2 accessory.
F01247	Motor encoder fault.	<ul style="list-style-type: none"> ■ This fault only occurs when the motor position feedback device is an EnDat encoder. ■ Defect motor encoder. ■ Defect in the EES2 accessory.

6 PROGRAMMING AND OPERATION

The SCA06, besides its basic function of servo drive, features two additional functions: PLC and Positioner accessible via programming in ladder language on a personal computer by using the appropriate WEG programming software, available for download on the WEG website: www.weg.net.

The servo drive can be controlled by an external device (such as a CNC, for instance) via analog/digital inputs/outputs or via network (CANopen network, for instance). It may also operate independently by using its PLC/Positioner functions via ladder programming.

The way of operation of the servo drive is defined primarily by parameter P00202:

1. Control via external device using analog/digital I/Os: program P00202 in 1 or 2 according to application (torque or speed control).
2. Control via ladder programming of the SCA06: program P00202 in 4 (torque, speed and position control).
3. Control via external device using CANopen network: program P00202 in 5 (torque, speed and position control).

In the first case, it is also necessary to program the parameters referring to the Analog/Digital I/Os according to the application. In the second case, a Ladder program made on a PC (using the appropriate WEG software) that will execute the necessary functions for the application must be loaded on the servo drive. And finally, in the third case, it is necessary to program the CANopen network parameters.

Even if parameter P00202 is not programmed in option 4, it is possible to execute a ladder program on the SCA06; however, in this case, the ladder will not control the shaft, but execute other auxiliary functions, such as logic, etc. By the same token, if parameter P00202 is not programmed in option 5, the CANopen network can still be used, but just cannot control the shaft.

The SCA06 has control nets of current (torque and flux), speed and position. The current control net is always used and its parameterization is necessary to program the model of WEG servomotor on parameter P00385; thus, all the parameters of this net are programmed according to the selected servomotor model. The speed and position nets may be used or not. If used, it is necessary to program their parameters.

7 LADDER

It is a feature that incorporates the functions of a PLC and Positioner to the SCA06, allowing the execution of complex interlocking programs that use the digital inputs and outputs of the SCA06 and its accessories.

Among the many functions available, we can point out from simple contacts and coils up to functions that use floating point, such as addition, subtraction, multiplication, division, trigonometric functions, square root, etc.

Other important functions are PID blocks, high-pass and low-pass filters, saturation, comparison, all in floating point.

In addition to the functions mentioned above, the ladder offers blocks to control position, motor torque and speed, and also offers blocks for synchronism in speed and position through the fast digital inputs (DI1 and DI2), CANopen network and encoder input.

For the Ladder to control the motor, o operating mode (P00202) must be programmed with option 4 (ladder). Regardless the operating mode (P00202), the ladder application will be executed according to Command of the PLC (P01020).

Using the Force Input/Output function, it is possible to change the status of the digital inputs/outputs and the value of the analog inputs no matter what ladder application is in operation.

To drive the digital outputs through the ladder, the respective functions must be programmed to the ladder, for example, the digital output 1 P00280 must be programmed in option 8 (ladder).

The information of each block is available in the manual or online help of the WLP/WPS programming software.

For the development and monitoring of the ladder application, the WLP software (WEG Ladder Programmer or WPS software ((WEG Programming Suite), available for download on the WEG website: www.weg.net) according to the servo drive firmware version (P0023). The transfer and monitoring of the application will be conducted through the USB interface of the servo drive or using some accessory of serial communication. The WLP/WPS provides online help with information about all blocks.

The user can interact with all the functions through the 200 programmable parameters (P01050 to P01249) that can be directly accessed via HMI of the servo drive and, through the programming software, can be customized with limits of values, decimal places, with or without signal, ignore password, only read and view on the HMI.

Some system markers are provided in order to simplify the use of some functions of the SCA06; for example, the double system marker %SD16010, which informs the position stored by the transition of WLP or variable POSITION_STORED_DI1 the WPS, which informs the position stored by transition from digital input DI1.

Available markers in the WLP:

Tag	Typo	Function
%SX3064	Bit	Blinker 2 Hz
%SX3066	Bit	Pulso Stop/Run
%SX3068	Bit	Always 0
%SX3070	Bit	Always 0
%SW3404	Word	Scan cycles elapsed
%SW3406	Word	Real shaft status
%SW3408	Word	Virtual shaft status
%SF3500	Float	Real shaft speed
%SF3502	Float	Virtual shaft speed
%SF3504	Float	Motor current
%SD3600	Double	Real shaft position
%SD3602	Double	Virtual shaft position
%SD3604	Double	Value of the fast counter
%SD3606	Double	Value of counter 1
%SD3608	Double	Value of counter 2
%SD3610	Double	Position stored by transition DI1
%SD3612	Double	Position stored by transition DI2
%SD3614	Double	Position stored by transition DI3
%SD3616	Double	Fast counter transition DI3
%SD3618	Double	Encoder counter stored by transition Z1
%SD3620	Double	Encoder counter stored by transition Z2

Available markers in the WPS:

Tag	Type	Function
FREQ_2Hz	BOOL	Oscillator 2Hz
PULSE_1SCAN	BOOL	Pulse during the first scan cycle
FALSE	BOOL	Always 0
TRUE	BOOL	Always 1
ELAPSED_SCAN_CYCLES	WORD	Scan cycles elapsed
MOTOR_CURRENT	REAL	Motor current
REAL_AXIS_STATUS	WORD	Effective axis status
REAL_AXIS_VELOCITY	REAL	Effective axis speed
REAL_AXIS_POSITION	LREAL	Effective axis position
VIRTUAL_AXIS_STATUS	WORD	Virtual axis status
VIRTUAL_AXIS_VELOCITY	REAL	Virtual axis speed
VIRTUAL_AXIS_POSITION	LREAL	Virtual axis position
POSITION_STORED_DI1	LREAL	Position stored by DI1transition
POSITION_STORED_DI2	LREAL	Position stored by DI2 transition
POSITION_STORED_DI3	LREAL	Position stored by DI3 transition
BUILT_IN_COUNTER	DINT	Default counter value
BUILT_IN_COUNTER_STORED_DI3	DINT	Default counter value stored in DI3 transition
ENC1_COUNTER	DINT	Value of the encoder 1 counter
ENC2_COUNTER	DINT	Value of the encoder 2 counter
ENC_COUNTER_STORED_Z1	DINT	Encoder counter stored by Z1 transition
ENC_COUNTER_STORED_Z2	DINT	Encoder counter stored by Z2 transition

8 PARAMETER STRUCTURE

The parameters are grouped according to their function. All the parameters are divided into nine groups, according to [Table 8.1 on page 8-1](#).

Table 8.1: Parameter groups

Parameter Group	Range	Parameters or Contained Groups
READING PARAMETERS	P00000 - P00098	Ready-only parameters
GENERAL SETTING PARAMETERS	P00099 - P00352	Parameter for selecting the type of control, fault reset, speed controller gains, I/Os, etc
MOTOR PARAMETERS	P00385 - P00421	Parameters relating to the motor characteristics
SPECIAL FUNCTION PARAMETERS	P00500 - P00582	Parameter group that configures special functions executed by servo drive
SERIAL COMMUNICATION PARAMETERS	P00650 - P00667	Parameters relating to serial communication
CAN NETWORK PARAMETERS	P00700 - P00706	Parameters related to CAN network
PROFIBUS PROTOCOL PARAMETERS	P00740 - P00999	Parameters related to Profibus
ETHERCAT NETWORK PARAMETERS	P00850 - P00859	Parameters regarding functions relating to the EtherCAT network
LADDER PARAMETERS	P01000 - P01032	Parameters relating to the use of the Ladder programming
USER'S PARAMETERS	P01050 - P01249	Parameter group whose function the user has complete freedom to define (via Ladder program)

9 READING PARAMETERS

This chapter introduces the read-only parameters, which can be viewed on the display but cannot be changed by the user. The exception of this chapter is parameter P00000, which can be changed by the user, according to the description.

A more detailed description of each parameter is given below.

P00000 - Access to the Parameters

Range:	0 to 9999	Factory Setting:
Properties:	RW - Reading and Writing	

Description:

This parameter allows the access to change the content of the other parameters. To change the content of the parameters, it is necessary to enter the correct password in P00000. Otherwise, the parameter content can only be viewed. With values set according to factory default, it is necessary to set P00000 = 00005 so as to change the parameter content, that is, the value of the password is equal to 5.

Table 9.1: Servo drive Status

P00000	Function
5	Default password: releases the access to change/view the content of all parameters
6 (*)	Allows viewing only the parameters that have values different from the default values
10 (*)	Allows viewing only the user's parameters

(*) The values of special passwords will only be valid if P00200 = 1.

Note: The value P00000 = 900 is reserved and must not be used.

P00002 - Motor Speed

Range:	-9999 to 9999	Factory Setting:
Properties:	RO - Read Only	

Description:

It indicates the real speed value of the servomotor in rpm, except when programmed to receive external position / speed feedback (see description of P00209). In case of external feedback, the speed shown in P00002 will be the external feedback.

P00003 - Motor Current

Range:	-999.9 to 999.9	Factory Setting:
Properties:	RO - Read Only	

Description:

It indicates the output Iq current value, in amperes rms, of the servo drive.

P00004 - DC Link Voltage

Range:	0 to 999	Factory Setting:
Properties:	RO - Read Only	

Description:

It indicates the actual voltage on the DC Link in volts (V).

P00006 - Servo drive Status

Range:	0 to 6	Factory Setting:
Properties:	RO - Read Only	

Description:

It indicates the actual status of the servo drive according to [Table 9.2 on page 9-2](#).

Table 9.2: Servo drive status

P00006	Servo Drive Status
0	Disabled with no errors with DC link OK
1	Servo ready: Enabled with no error with DC link OK
2	Fault: Servo with fault
3	Power turned off/powering up: DC link voltage has not reached minimum limit yet
4	Self-tuning
5	Stop active: Enabled with no error with DC link OK and stop function active (It can be caused by fault alarm on the communication according to programming of P00662)
6	STO active: Safety function "Safe Torque Off" active

P00008 - Status DI1 to DI3

Range:	Dig 1 = DI1 Dig 2 = DI2 Dig 3 = DI3	Factory Setting:
Properties:	RO - Read Only	

Description:

It indicates on the HMI the status of the default digital inputs DI1 to DI3. Example: If DI1 and DI3 are enabled and DI2 disabled, the indication on the HMI will be 000101, as shown in [Figure 9.1 on page 9-2](#).



Figure 9.1: Example of status of DI1 to DI3

Table 9.3: Indication of the DIs: DI1 to DI3

Digit 1	DI1
Digit 2	DI2
Digit 3	DI3

P00009 - Status DI101 to DI106

Range:	Dig 1 = DI101 Dig 2 = DI102 Dig 3 = DI103 Dig 4 = DI104 Dig 5 = DI105 Dig 6 = DI106	Factory Setting:
Properties:	RO - Read Only AC - Accessories	

Description:

It indicates on the HMI the status of the digital inputs DI101 to DI106 (slot 1).

Table 9.4: Indication of the DIs: DI101 to DI106

Digit 1	DI101
Digit 2	DI102
Digit 3	DI103
Digit 4	DI104
Digit 5	DI105
Digit 6	DI106

P00010 - Status DI107 to DI112

Range:	Dig 1 = DI107 Dig 2 = DI108 Dig 3 = DI109 Dig 4 = DI110 Dig 5 = DI111 Dig 6 = DI112	Factory Setting:
Properties:	RO - Read Only AC - Accessories	

Description:

It indicates on the HMI the status of the digital inputs DI107 to DI112 (slot 1).

Table 9.5: Indication of the DIs: DI107 to DI112

Digit 1	DI107
Digit 2	DI108
Digit 3	DI109
Digit 4	DI110
Digit 5	DI111
Digit 6	DI112

P00011 - Status DI201 to DI206

Range:	Dig 1 = DI201 Dig 2 = DI202 Dig 3 = DI203 Dig 4 = DI204 Dig 5 = DI205 Dig 6 = DI206	Factory Setting:
Properties:	RO - Read Only AC - Accessories	

Description:

It indicates on the HMI the status of the digital inputs DI201 to DI206 (slot 2).

Table 9.6: Indication of the DIs: DI201 to DI206

Digit 1	DI201
Digit 2	DI202
Digit 3	DI203
Digit 4	DI204
Digit 5	DI205
Digit 6	DI206

P00012 - Status DI207 to DI212

Range:	Dig 1 = DI207 Dig 2 = DI208 Dig 3 = DI209 Dig 4 = DI210 Dig 5 = DI211 Dig 6 = DI212	Factory Setting:
Properties:	RO - Read Only AC - Accessories	

Description:

It indicates on the HMI the status of the digital inputs DI207 to DI212 (slot 2).

Table 9.7: Indication of the DIs: DI207 to DI212

Digit 1	DI207
Digit 2	DI208
Digit 3	DI209
Digit 4	DI210
Digit 5	DI211
Digit 6	DI212

P00013 - Status DI301 to DI306

9

Range:	Dig 1 = DI301 Dig 2 = DI302 Dig 3 = DI303 Dig 4 = DI304 Dig 5 = DI305 Dig 6 = DI306	Factory Setting:
Properties:	RO - Read Only AC - Accessories	

Description:

It indicates on the HMI the status of the digital inputs DI301 to DI306 (slot 3).

Table 9.8: Indication of the DIs: DI301 to DI306

Digit 1	DI301
Digit 2	DI302
Digit 3	DI303
Digit 4	DI304
Digit 5	DI305
Digit 6	DI306

P00014 - Status DI307 to DI312

Range:	Dig 1 = DI307 Dig 2 = DI308 Dig 3 = DI309 Dig 4 = DI310 Dig 5 = DI311 Dig 6 = DI312	Factory Setting:
Properties:	RO - Read Only AC - Accessories	

Description:

It indicates on the HMI the status of the digital inputs DI307 to DI312 (slot 3).

Table 9.9: Indication of the DIs: DI307 to DI312

Digit 1	DI307
Digit 2	DI308
Digit 3	DI309
Digit 4	DI310
Digit 5	DI311
Digit 6	DI312

P00015 - Status DO1

Range:	Dig 1 = DO1	Factory Setting:
Properties:	RO - Read Only	

Description:

It indicates on the HMI the status of the default digital output DO1.

Table 9.10: Indication of DO1

Digit 1	DO1
---------	-----

P00016 - Status DO101 to DO106

Range:	Dig 1 = DO101 Dig 2 = DO102 Dig 3 = DO103 Dig 4 = DO104 Dig 5 = DO105 Dig 6 = DO106	Factory Setting:
Properties:	RO - Read Only AC - Accessorys	

Description:

It indicates on the HMI the status of the digital outputs DO101 to DO106 (slot 1). Example: If DO101, DO102 and DO103 are enabled and the others not enabled, the indication on the HMI will be 000111, as shown in [Figure 9.2 on page 9-5](#).



Figure 9.2: Example of DO1 to DO5 status

Table 9.11: Indication of the DOs: DO101 to DO106

Digit 1	DO101
Digit 2	DO102
Digit 3	DO103
Digit 4	DO104
Digit 5	DO105
Digit 6	DO106

P00017 - Status DO201 to D0206

Range:	Dig 1 = DO201 Dig 2 = DO202 Dig 3 = DO203 Dig 4 = DO204 Dig 5 = D0205 Dig 6 = D0206	Factory Setting:
Properties:	RO - Read Only AC - Accessories	

Description:

It indicates on the HMI the status of the digital outputs DO201 to DO206 (slot 2).

Table 9.12: Indication of the DOs: DO201 to DO206

Digit 1	DO201
Digit 2	DO202
Digit 3	DO203
Digit 4	DO204
Digit 5	DO205
Digit 6	DO206

P00018 - Status DO301 to DO306

9

Range:	Dig 1 = DO301 Dig 2 = DO302 Dig 3 = DO303 Dig 4 = DO304 Dig 5 = DO305 Dig 6 = DO306	Factory Setting:
Properties:	RO - Read Only AC - Accessories	

Description:

It indicates on the HMI the status of the digital outputs DO301 to DO306 (slot 3).

Table 9.13: Indication of the DOs: DO301 to DO306

Digit 1	DO301
Digit 2	DO302
Digit 3	DO303
Digit 4	DO304
Digit 5	DO305
Digit 6	DO306

P00021 - Internal Air Temperature

P00022 - Heatsink Temperature

Range:	0 to 1000	Factory Setting:
Properties:	RO - Read Only	

Description:

These parameters present, in degrees Celsius, the temperature of the internal air and of the heatsink respectively.

P00023 - Firmware Version

Range:	0.00 to 655.35	Factory Setting:
Properties:	RO - Read Only	

Description:

It indicates the firmware version installed on the flash memory of the microcontroller located on the control card.

P00024 - Version of the Firmware Update Module

Range:	0.00 to 655.35	Factory Setting:
Properties:	RO - Read Only	

Description:

It indicates the version of the firmware update module contained on FLASH memory of the microcontroller located on the control card.

P00025 - FPGA Project Version

Range:	0.00 to 655.35	Factory Setting:
Properties:	RO - Read Only	

Description:

It indicates the FPGA project version located on the control card.

P00030 - Present Alarm

P00035- Present Fault

Range:	0 to 2000	Factory Setting:
Properties:	RO - Read Only	

Description:

It indicates the alarm (P00030) and fault (P00035) number that may occasionally be present on the servo drive. [Figure 9.3 on page 9-7](#) shows an example of present alarm (P00030) identification.



Figure 9.3: Indication of present alarm on P00030

Both the indication of present alarm and present fault remain on the HMI until any key is pressed. When this occurs, the message disappears from the display, which does not mean that the servo drive has no alarms or faults. The alarm only stops occurring when the situation that caused it is no longer happening. For example: The alarm that indicates high temperature of the internal air is displayed on the HMI. After pressing an HMI key, the alarm message disappears, but when entering the parameter that indicates present alarm, it keeps indicating the overtemperature alarm code. This parameter indication P00030 disappears only when the internal air temperature decrease to the point that the alarm is unnecessary.

For faults, the messages also disappear when any key of the HMI is pressed, but the message is only reset when the servo drive is reset (via hardware, digital inputs, parameter, etc).

Reading Parameters

P00031 - Last Alarm

P00036 - Last Fault

P00040 - Second Fault

P00044 - Third Fault

Range: 0 to 2000

Factory Setting:

Properties: RO - Read Only

Description:

It indicates the codes of the last alarm (P00031) occurrence and from the last to the third fault (P00036, P00040 and P00044).

The fault registration system is as follow: Fxxxxx → P00036 → P00040 → P00044.

Example: The last fault occurred was fault 2 on January, 28, 2009 at 03:30 pm. The following figures illustrate how the messages related to last fault appear on the HMI.



Figure 9.4: Example: last fault indicated on P00036

P00032 - Last Alarm Day. Month

P00037 - Last Fault Day. Month

P00041 - Second Fault Day. Month

P00045 - Third Fault Day. Month

Range: 00.00 to 31.12

Factory Setting:

Properties: RO - Read Only

Description:

It indicates the day and month of the occurrence of the last alarm and of the last to the third fault.



Figure 9.5: Example: day.month of the last fault (P00037)

P00033 - Last Alarm Year

P00038 - Last Fault Year

P00042 - Second Fault Year

P00046 - Third Fault Year
Range: 0 to 4096

Factory Setting:
Properties: RO - Read Only

Description:

It indicates the year of the occurrence of the last alarm and of the last to the third fault.

Figure 9.6: Example: year of the last fault (P00038)
P00034 - Last Alarm Hour. Min
P00039 - Last Fault Hour. Min
P00043 - Second Fault Hour. Min
P00047 - Third Fault Hour. Min
Range: 00.00 to 23.59

Factory Setting:
Properties: RO - Read Only

Description:

It indicates the hour and the minute of the occurrence of the last alarm and of the last to the third fault.

Figure 9.7: Example: hour.min of the last fault (P00039)

Note: If no fault and/or alarm have occurred, the parameters related to faults and alarm display the value 00000. As alarm and faults occur, the parameters receive the corresponding values. For example: Only two faults have occurred on the servo drive since it was put into operation: fault 2, on January 28 at 3:30 pm and fault 33 on February 04 at 10:27 am. The fault parameters will be set as follows:

- Present fault - P00035 = 00000.
- Last fault - P00036 = 00033.
- Day. Month last fault - P00037 = 004.02.
- Year last fault - P00038 = 02009.
- Hour. Min last fault - P00039 = 010.27.
- Second fault - P00040 = 00002.
- Day. Month second fault - P00041 = 028.01.
- Year second fault - P00038 = 02009.

Reading Parameters

- Hour. Min second fault - P00039 = 015.30.
- Third fault - P00036 = 00000.
- Day. Month third fault - P00037 = 00000.
- Year third fault - P00038 = 00000.
- Hour. Min third fault - P00039 = 00000.

P00048 - Present Lag Error

Range: 0 to 65535

Factory Setting:

Properties: RO - Read Only

Description:

It indicates the present lag error value, in number of pulses. If the Lag is greater that 65535 (4 revolutions) the parameter saturates at this value.

P00050 - Position of Sensor Axis

Range: 0 to 16383

Factory Setting:

Properties: RO - Read Only

Description:

It indicates the current position of the shaft in relation to the Absolute Zero position of the shaft read by the sensor.

A complete revolution, i.e., 360° corresponds to 16384 pulses. The corresponding angle is obtained with the following formula:

$$\theta = \frac{N_{Pulses} \cdot 360}{16384}$$

Where:

N_{Pulses} : Number of pulses.

θ : Angle in degrees.

Example: The HMI indicates 8000 pulses. In order to obtain the equivalent angle, use the equation above:

$$\theta = \frac{8000 \cdot 360}{16384}$$

$$\theta = 175.78^\circ$$

Below are some illustrative values:

Table 9.14: Illustrative values for shaft position (angle x pulses)

Angle	Pulses	Angle	Pulses	Angle	Pulses	Angle	Pulses
0°	0	105°	4779	210°	9557	315°	14336
15°	682	120°	5461	225°	10240	330°	15019
30°	1365	135°	6144	240°	10923	345°	15701
45°	2048	150°	6827	255°	11605	360°	0
60°	2731	165°	7509	270°	12288		
75°	3413	180°	8192	285°	12971		
90°	4096	195°	8875	300°	13653		

P00051 - Number of Revolutions of Sensor

Range:	-32768 to 32767	Factory Setting:	-
Properties:	RO - Read Only		

Description:

Indicates the instantaneous position of the motor sensor (number of revolutions). This parameter is updated only when the motor feedback device used is a multi-turn encoder. The range of values that this parameter indicates is directly related to the number of absolute turns of the sensor. For an absolute sensor of 4096 turns, this parameter indicates -2048 to 2047.

P00052 - Angular Position: Fraction of the User's Reference Revolution

Range:	-16383 to 16383	Factory Setting:	
Properties:	RO - Read Only		

Description:

It indicates the shaft current position (the fraction of revolution). This fraction of revolution is given in pulses, where 16384 pulses correspond to 1 complete revolution. See examples in [Table 9.15 on page 9-11](#).

The user can initialize this parameter with the desired value. For further information see description of the parameters P00490 to P00493.

In case of external feedback, the position displayed on P00052 will be that of the external feedback (see programming of parameter P00209).

P00053 - Angular Position: Number of User's Reference Revolutions

Range:	-32768 to 32767	Factory Setting:	
Properties:	RO - Read Only		

Description:

It indicates the shaft current position (number of revolutions). See examples in [Table 9.15 on page 9-11](#).

The user can initialize this parameter with the desired value. For further information see description of parameters P00490 to P00493.

In case of external feedback, the position displayed on P00053 will be that of the external feedback (see programming of parameter P00209).

Table 9.15: Illustrative values for the user's position - revolutions and fraction of revolution

Angle	-720°	-540°	-360°	-180°	-90°	0°	90°	180°	360°	540°	720°
P00053	-2	-1	-1	0	0	0	0	0	1	1	2
P00052	0	-8192	0	-8192	-4096	0	4096	8192	0	8192	0

P00056 - Value of the Standard fast Counter: Low Part

Range:	0 to 65535	Factory Setting:	
Properties:	RO - Read Only		

Description:

It indicates the value of the low portion (16 LSB) of the default fast counter.

P00057 - Value of the standard fast counter: High Part

Range:	0 to 65535	Factory Setting:
Properties:	RO - Read Only	

Description:

It indicates the value of the high portion (16 LSB) of the default fast counter.

P00058 - Value of fast counter 1: Low Part

Range:	0 to 65535	Factory Setting:
Properties:	RO - Read Only AC - Accessory	

Description:

It indicates the value of the low portion (16 LSB) of the fast counter 1.

P00059 - Value of fast counter 1: High Part

Range:	0 to 65535	Factory Setting:
Properties:	RO - Read Only AC - Accessory	

Description:

It indicates the value of the high portion (16 LSB) of the fast counter 1.

P00060 - Value of fast counter 2: Low Part

Range:	0 to 65535	Factory Setting:
Properties:	RO - Read Only AC - Accessory	

Description:

It indicates the value of the low portion (16 LSB) of the fast counter 2.

P00061 - Value of fast counter 2: High Part

Range:	0 to 65535	Factory Setting:
Properties:	RO - Read Only AC - Accessory	

Description:

It indicates the value of the high portion (16 MSB) of the fast counter 2.

P00062 - Standard Fast Counter Speed

Range:	-32768 to 32767	Factory Setting:
Properties:	RO - Read Only AC - Accessory	

Description:

It indicates the standard fast counter speed according to the number of pulses per revolution set in parameter P00506.

P00063 - Fast Counter 1 Speed

Range:	-32768 to 32767	Factory Setting:
Properties:	RO - Read Only AC - Accessory	

Description:

It indicates the fast counter 1 speed according to the number of pulses per revolution set in parameter P00516.

P00064 - Fast Counter 2 Speed

Range:	-32768 to 32767	Factory Setting:
Properties:	RO - Read Only AC - Accessory	

Description:

It indicates the fast counter 2 speed according to the number of pulses per revolution set in parameter P00526.

P00066 - Value of AI1

P00067 - Value of AI2

Range:	-8192 to 8191	Factory Setting:
Properties:	RO – Read Only (AI1 and AI2) AC – Accessory (AI2)	

Description:

This parameter indicates the value of the analog inputs AI1 and AI2. The values displayed on these parameters are already multiplied by the gain (P00233/ P00238), added of the offset (P00235/ P00240) and filtered (P00236/ P00241). This indication depends on the programmed function (P00232/ P00237).

P00232/P00237 = 2 (speed reference): For a gain equal to 1,000, a voltage of 10 V on the analog input is equivalent to the rated speed (P00402) of the selected motor. The corresponding value in RPM in this case is shown on parameter P00121, and P00066 will indicate the value in internal scale of speed: 18750 rpm = 8192. P00066 = Motor speed * 8192 / 18750.

Example: When selecting a motor of 3000 rpm and configuring a gain of 1,000, the corresponding value for a voltage of 10 V on the analog input is 3000 rpm, displayed on parameter P00121. The value shown on P00066 = 01310.

For other configurations: For a gain equal to 1,000, the adjustable range of this parameter varies from -8192 to +8191, representing a value on the input of -10 V to +10 V.

The reading of the analog inputs is only active if some function is programmed.

P00070 - CAN Controller Status

Range: 0 to 6

Factory Setting:

Properties: RO - Read Only

Description:

It indicates the CAN controller status, responsible for sending and receiving CAN telegrams. Possible status is indicated according to [Table 9.16 on page 9-14](#).

Table 9.16: CAN controller status

P00070	CAN Controller Status
0	Disabled
1	Reserved
2	Enable with no errors
3	Warning
4	Error Passive
5	Bus Power off
6	No power supply

P00071 - Number of CAN Telegrams Received

Range: 0 to 65535

Factory Setting:

Properties: RO - Read Only

Description:

It indicates the number of CAN telegrams correctly received by the servo drive. This number goes back to zero automatically after the powering up, reset or when the maximum limit is exceeded.

P00072 - Number of CAN Telegrams Transmitted

Range: 0 to 65535

Factory Setting:

Properties: RO - Read Only

Description:

It indicates the number of CAN telegrams correctly transmitted by the servo drive. This number goes back to zero automatically after the powering up, reset or when the maximum limit is exceeded.

P00073 - Numbers of Bus off Errors Occurred

Range: 0 to 65535

Factory Setting:

Properties: RO - Read Only

Description:

It indicates the number of bus off errors occurred with the servo drive. This number goes back to zero automatically after the powering up, reset or when the maximum limit is exceeded.

P00074 - Number of CAN Telegrams Missed

Range: 0 to 65535

Factory Setting:

Properties: RO - Read Only

Description:

It indicates the number of CAN telegrams missed by the servo drive. This number goes back to zero automatically after the powering up, reset or when the maximum limit is exceeded.

P00075 - CANopen Network Status

Range:	0 to 5	Factory Setting:
Properties:	RO - Read Only	

Description:

It indicates the CANopen communication status, informing if the protocol was initialized correctly and the status of the guarding service of the slave.

Table 9.17: CANopen communication status

P00075	CANopen Network Status	Note
0	Disabled	The CANopen protocol was not programmed on P00700 and is disabled
1	Reserved	-
2	CANopen enabled	The CANopen protocol was correctly initialized
3	Node Guarding	The node guarding service was initialized by the master and is operating correctly
4	Node guarding error	Timeout in the node guarding service
5	Heartbeat error	Timeout in the heartbeat service

Note: Refer to the CANopen communication manual for a detailed description of the protocol.

P00076 - CANopen Node Status

Range:	0 to 4	Factory Setting:
Properties:	RO - Read Only	

Description:

Each device in the CANopen network has an associated state. It is possible to see the present status of the servo drive through this parameter.

Table 9.18: CANopen Node Status

P00076	CANopen Network Status	Note
0	Not initialized	The CANopen protocol was not programmed on P00700 and is disabled
1	Initialization	CANopen protocol initialization
2	Stopped	In this status, the data transfer between master and slave is not possible
3	Operational	All the communication services are available in this status
4	Pre-Operational	Only some of the CANopen communication services are available in this status

Note: Refer to the CANopen communication manual for a detailed description of the protocol.

P00077 - DeviceNet Network Status

Range:	0 = Offline 1 = Online, Not Connected 2 = Online, Connected 3 = Connection Expired 4 = Link Failure 5 = Auto-Baud	Factory Setting: -
Properties:	RO - Read Only	

Description:

It indicates the DeviceNet network status. The table below presents a brief description of those statuses.

Status	Description
Offline	Without power supply or not online Communication cannot be established.
Online, Not Connected	Device online, but not connected. Slave has successfully completed the Mac ID verification procedure. This means that the configured baud rate is correct (or was correctly detected in case of use of auto-baud) and that there are no other nodes on the network with the same address. However, at this stage, there is no communication with the master.
Online, Connected	Device operating and in normal conditions Master allocated a set of I/O type connections with the slave. In this stage, data exchange by means of I/O type connections effectively occurs.
Connection Timed Out	One or more I/O type connections timed out.
Link Failure	It indicates that the slave cannot enter the network, because of addressing problems or due to the occurrence of bus off. Check that the configured address is not being used by another device, if the chosen baud rate is correct or if there are installation problems.
Autobaud	Equipment running routine of the autobaud mechanism.

P00078 - DeviceNet Master Status

Range:	0 = Run 1 = Idle	Factory Setting:
Properties:	RO - Read Only	

Description:

It indicates the DeviceNet network status. This can be in operation mode (Run) or in configuration mode (Idle).

When in Run, reading and writing telegrams are normally processed and updated by the master. When in Idle, only reading telegrams of the slaves are updated by the master. The writing, in this case, is disabled.

When the communication is disabled this parameter does not represent the actual status of the master.

9

P00080 - Virtual Shaft Speed

Range:	-999.9 to 999.9	Factory Setting:
Properties:	RO - Read Only	

Description:

It indicates the speed value of the Virtual Shaft.

P00082 - Virtual Shaft Angle Position: Fraction of revolution

Range:	-16383 to 16383	Factory Setting:
Properties:	RO - Read Only	

Description:

It indicates the virtual shaft current position (the fraction of revolution). This fraction of revolution is given in pulses, where 16384 pulses correspond to 1 complete revolution.

P00083 - Virtual Shaft Angle Position: Number of revolutions

Range:	-32768 to 32767	Factory Setting:
Properties:	RO - Read Only	

Description:

It indicates the virtual shaft current position (number of revolutions).

P00084 - Day of the Week

Range:	0 to 6	Factory Setting:
Properties:	RO - Read Only	

Description:

This parameter is related to the real time clock available on the SCA06. It displays the day of the week according to [Table 9.19 on page 9-17](#).

Table 9.19: Days of the week

P00193	Days of the Week
0	Sunday
1	Monday
2	Tuesday
3	Wednesday
4	Thursday
5	Friday
6	Saturday

P00085 - Day of the Month

Range:	1 to 31	Factory Setting:
Properties:	RO - Read Only	

Description:

This parameter is related to the real time clock available on the SCA06. It displays the day of the month programmed on the RTC.

P00086 - Month

Range:	0 to 12	Factory Setting:
Properties:	RO - Read Only	

Description:

This parameter is related to the real time clock available on the SCA06. It displays the month programmed on the RTC.

P00087 - Year

Range:	0 to 4095	Factory Setting:
Properties:	RO - Read Only	

Description:

This parameter is related to the real time clock available on the SCA06. It displays the year programmed on the RTC.

P00088 - Hour

Range:	0 to 23	Factory Setting:
Properties:	RO - Read Only	

Description:

This parameter is related to the real time clock available on the SCA06. It displays the hour programmed on the RTC.

P00089 - Minutes

Range: 0 to 59 **Factory Setting:**

Properties: RO - Read Only

Description:

This parameter is related to the real time clock available on the SCA06. It displays the minutes programmed on the RTC.

P00090 - Seconds

Range: 0 to 59 **Factory Setting:**

Properties: RO - Read Only

Description:

This parameter is related to the real time clock available on the SCA06. It displays the seconds programmed on the RTC.

P00091 - Identification of Slot 1

P00092 - Identification of Slot 2

P00093 - Identification of Slot 3

Range: 0 to 65535 **Factory Setting:**

Properties: RO - Read Only

Description:

It indicates which accessory is connected to slot 1, slot 2 and slot 3 respectively. The [Table 9.20 on page 9-18](#) presents the corresponding code for each accessory and relevant information about them.

Table 9.20: Identification of the Accessories

Accessory	Identification Code	Note
No accessories	00000	-
EAN1	00016	It can be connected only to slot 3
EAN2	00032	It can be connected to any slot ⁽¹⁾
EIO1	00512	It can be connected to any slot
EEN1	00064	It can be connected to any slot ⁽¹⁾
EEN2	01024	It can be connected to any slot ⁽¹⁾
EES1	00128	It can be connected to any slot ⁽¹⁾
EES2	00192	It can be connected to any slot ⁽¹⁾
ECO1	04096	It can be connected to slot 1 or slot 2 ⁽¹⁾
ECO3	16384	It can be connected only to slot 2
ECO4	02048	It can be connected only to slot 2
ECO5	00257	It can be connected only to slot 2
ECO6	00258	It can be connected only to slot 2
ECO7	00259	It can be connected only to slot 2

⁽¹⁾ Although the accessory can be connected to more than one slot, only one accessory of this model can be connected to the SCA06.

P00095 - Identification of the Optional Cards

Range:	0 to 1000	Factory Setting:
Properties:	RO - Read Only	

Description:

It indicates which optional cards are connected to the servo drive. Each digit corresponds to an optional items and the value of the digit varies between 0 (not connected) and 1 (connected), except the one corresponding to the SSC card, which can vary from 0 (not connected), 1 (connected) and 2 (auxiliary card not connected).

Table 9.21: Status of the optional cards

P00095	Status of the Optional Card
0000	No optional cards connected
0001	SAS (Servo Auxiliary Supply)
0010	SSC (Servo Safety Card)
0020	SSC Error - No auxiliary card (jumper card)
0100	Reserved
1000	SEB (Servo EMI Card)

Example: The SAS and SSC cards are connected. The content of parameter P00095 will indicate 00011, as shown in the [Figure 9.8 on page 9-19](#).



Figure 9.8: Status of the optional cards

Note: For further information about the optional cards, refer to the user’s manual.

P00097 - Servo drive Rated Current

Range:	0.0 to 999.9	Factory Setting:
Properties:	RO - Read Only	

Description:

It indicates the servo drive rated current.

P00098 - Servo drive Rated Voltage

Range:	2 and 3	Factory Setting:
Properties:	RO - Read Only	

Description:

It indicates the rated input voltage of the servo drive.

Table 9.22: Rated Line Voltage

P00098	Servo Drive Rated Voltage
2	220 V
3	380 V

10 CONFIGURATION AND CONTROL PARAMETERS

In this group are parameters related to the motor control, besides the selection of the control type that will be used, backups on the flash memory card, password setting and the like.

10.1 GENERAL CONFIGURATIONS

P00099 - Enabling

Range:	0 to 2	Factory Setting: 0
Properties:	RW - Reading and Writing	

Description:

Parameter responsible for enabling the motor. The enabling of the motor can come from different sources (such as CAN, ladder, DIs), but is not recommended to enable it through two or more sources simultaneously. If that occurs, the alarm A00120 will show on the HMI.

It is important to note that when choosing the desired method to enable the drive, parameter P00202 must be configured so as to allow the enabling of the shaft by the chosen source.

Table 10.1: Enabling

P00099	Enabling
0	Not enabled
1	Enable
2	Enable without salving parameter

P00100 - Acceleration Ramp (Speed Mode)

Range:	0 to 32767	Factory Setting: 0
Properties:	RW - Reading and Writing	

Description:

It defines the time of the acceleration ramp used in the speed operating mode (P0202=2). The value set is in ms / krpm.

Example: If P00100 = 200 and the drive is stopped, receiving a speed reference of 500 rpm, the motor will accelerate for 100 ms before reaching the 500 rpm (provided that it has enough torque in relation to the load in order to be able to follow the ramp).

P00101 - Deceleration Ramp (Speed Mode)

Range:	0 to 32767	Factory Setting: 0
Properties:	RW - Reading and Writing	

Description:

It defines the time of the deceleration ramp used in the speed operating mode (P0202 = 2). The value set is in ms / krpm.

Example: If P00100 = 200 and the drive is spinning at 1500 rpm, receiving a speed reference of 0 rpm, the motor will decelerate for 300 ms before it stops (provided that it has enough torque in relation to the load in order to be able to follow the ramp).

P00105 - STOP Function Ramp

Range:	1 to 32767	Factory Setting:	200
Properties:	RW - Reading and Writing		

Description:

It defines the time of the deceleration ramp used in the STOP function. The programmed value is in ms / krpm.

Example: If P00105 = 500 and the drive is spinning at 2000 rpm, when you activate the STOP function, it will take the drive 1 s to stop (provided it has enough torque in relation to the load so it can follow the ramp).

P00111 - Direction of Rotation

Range:	0 and 1	Factory Setting:	0
Properties:	RW - Reading and Writing		

Description:

It defines the direction of rotation of the servomotor shaft, inverting the direction of rotation programmed, according to [Table 10.2 on page 10-2](#).

Table 10.2: Direction of rotation

P00111	Reference	Direction of Rotation
0	Positive	Clockwise
	Negative	Counterclockwise
1	Positive	Counterclockwise
	Negative	Clockwise

10

To verify the direction of rotation, observe the servomotor shaft from its drive end.

P00119 - Current Reference

Range:	-3276.8 to 3276.7	Factory Setting:	0
Properties:	RW - Reading and Writing		

Description:

The value of this parameter will be used as current reference when the servo drive is operating in torque mode.

Note: If the analog input is programmed for current reference, parameter P00119 becomes a read-only parameter and it will display the current reference value imposed by the analog input.

P00121 - Speed Reference

Range:	-9999 to 9999	Factory Setting:	0
Properties:	RW - Reading and Writing		

Description:

The value of this parameter is used for speed reference when the servo drive is operating in the speed mode.

When the reference changes the signal (positive to negative or vice-versa), the direction of rotation is inverted.

The value of P00121 is maintained at the last programmed value, even if the servo drive is disabled or powered down.

Note: If the analog input is programmed for speed reference, parameter P00121 becomes a read-only parameter and it will display the speed reference value imposed by the analog input.

P00126 - Enabling of the Position Limits

Range:	0 and 1	Factory Setting:	0
Properties:	RW - Reading and Writing		

Description:

When this parameter is set (P00126 = 1), the position limits programmed in parameters P00127 to P00130 are enabled and start to define the limitation value for the position.

Note: Parameter P00126 enables only the position limits (revolution and fraction of revolution). The other limits are always enabled.

When the position limit is reached, the servo drive will not go any further, and the lag error may occur (see P01031/P01032). When the Lag error occurs, the shaft will be disabled and the motor will stop by inertia.

Parameters P00127 and P00128, such as P00129 and P00130, must have the same signal (if they are different from zero). If there is a signal incompatibility, an alarm (A00101) will be generated and the values will not be loaded, seeing that this alarm can also be generated by signal incompatibility in parameters P00492 and P00493.

P00127 - Lower Position Limit - Fraction of revolutions

Range:	-16383 to 16383	Factory Setting:	-16383
Properties:	RW - Reading and Writing		

Description:

It defines the lower limit value of the fraction of revolutions when parameter P00126 = 1.

P00128 - Lower Position Limit - Number of revolutions

Range:	-32768 to 32767	Factory Setting:	-32768
Properties:	RW - Reading and Writing		

Description:

It defines the lower limit value of the number of revolutions when parameter P00126 = 1.

P00129 - Upper Position Limit - Fraction of revolutions

Range:	-16383 to 16383	Factory Setting:	16383
Properties:	RW - Reading and Writing		

Description:

It defines the upper limit value of the fraction of revolutions when parameter P00126 = 1.

P00130 - Upper Position Limit - Number of revolutions

Range:	-32768 to 32767	Factory Setting:	32768
Properties:	RW - Reading and Writing		

Description:

It defines the upper limit value of number of revolutions when parameter P00126 = 1.

P00131 - Negative Current Limit

Range:	-140.0 to 0	Factory Setting:	-140.0
Properties:	RW - Reading and Writing		

Description:
It defines the value of the negative current limit. This limit is valid for any of the operating modes of the servo drive.

P00132 - Positive Current Limit

Range:	0 to 140.0	Factory Setting:	140.0
Properties:	RW - Reading and Writing		

Description:
It defines the value of the positive current limit. This limit is valid for any of the operating modes of the servo drive.

P00133 - Negative Speed Limit

Range:	-9999 to 0	Factory Setting:	-9999
Properties:	RW - Reading and Writing		

Description:
It defines the value of the negative speed limit. This limit is valid when the servo drive is operating in the speed or positioning mode.

P00134 - Positive Speed Limit

Range:	0 to 9999	Factory Setting:	9999
Properties:	RW - Reading and Writing		

Description:
It defines the value of the positive speed limit. This limit is valid when the servo drive is operating in the speed or positioning mode.

P00136 - $I_{dynamic}/I_{rated}$ Ratio

Range:	0 to 400	Factory Setting:	300
Properties:	RW - Reading and Writing		

Description:
It determines which percentage the servomotor current can reach in dynamic duty.

In relation to the servomotor, the maximum value of the dynamic current that it can reach is 400 % of its own rated current. The dynamic current must be limited to this value so as to avoid a possible de-magnetizing of the servomotor magnets. The value programmed on P00136 refers to the value of parameter P00401 (motor rated current).

Example: $I_{dynamic} = P00401 \times P00136/100$.

When the programmed value represents a dynamic current greater than the dynamic current of the servo drive, its value will be limited by the value of the dynamic current of the servo drive.

P00154 - Braking Resistor

Range:	0 to 1000	Factory Setting:	0
Properties:	PP - Press P to validate		

Description:
It determines the value of the resistor used on servomotor braking. For each servo drive model, it is recommended a minimum value for the braking resistor, according to [Table 10.3 on page 10-5](#).

Table 10.3: Indication of the minimum values for the braking resistor

Model	Minimum Braking Resistor (P00154)
5 A - 220 V	30 Ω
8 A - 220 V	15 Ω
24 A - 220 V	10 Ω
5.3 A - 380 V	60 Ω
14 A - 380 V	30 Ω

In order to disable the braking resistor, configure parameter P00154 = 0.

P00155 - Average Power of the Braking Resistor

Range:	0 to 10000	Factory Setting:	200
Properties:	PP - Press P to validate		

Description:
This parameter refers to the average power of the braking resistor used. This information is provided by the resistor manufacturer.

When P00155 = 0, the braking resistor is disabled.

P00156 - Maximum Energy of the Braking Resistor

Range:	0 to 10000	Factory Setting:	2200
Properties:	PP - Press P to validate		

Description:
It defines the maximum energy value supported by the braking resistor. This information is provided by the resistor manufacturer.

P00159 - Proportional Gain of the Position Controller (Kp)

Range:	0 to 32767	Factory Setting:	50
Properties:	PP - Press P to validate		

P00161 - Proportional Gain of the do Speed Controller (Kp)

Range:	0 to 3276.7	Factory Setting:	25.0
---------------	-------------	-------------------------	------

P00162 - Integral Gain of the Speed Controller (Ki)

Range:	0 to 327.67	Factory Setting:	1.50
---------------	-------------	-------------------------	------

P00163 - Derivative Gain of the Speed Controller (Kd)

Range:	0 to 32767	Factory Setting:	0
Properties:	RW - Reading and Writing		

Description:

The gains of the PID controller can be manually adjusted so as to optimize the dynamic speed response, and the gain of the P controller to optimize the dynamic position response. Increase those gains to make the response faster. If the speed starts to oscillate, it is necessary to lower the gains.

P00170 - Enables Feedforward iq (torque)

Range:	0 and 1	Factory Setting:	0
Properties:	RW - Reading and Writing		

Description:

It must be used in the ladder control mode only (P00202 = 4).

It is used to reduce the following lag and the overshoot at the stop.

10

P00170 = 1 enables the iq current feedforward (current which produces torque). At the input of the current regulator, an iq current feedforward is added according to the equation:

$$Iq \text{ feedforward } i_q = \text{acceleration} * (J_m (P00418) + J_I (P00421)) / k_t (P00417).$$

The Jm and kt parameters are automatically set when the motor model is selected in P00385.

The best way to set the JI (P00421) is to use the trace function, select channel 1 option for value 10 (iq) and channel 2 option for value 25 (iq feedforward), and set P00421 so that the iq values and iq feedforward will be the same during the deceleration ramp.

P00184 - DC Link Undervoltage Filter

Range:	40 to 200	Factory Setting:	100
Properties:	PP - Press P to validate		

Description:

Filter on the DC link voltage reading for DC link undervoltage fault.

P00192 - Update the RTC Values

Range:	0 and 1	Factory Setting:	0
Properties:	RW - Reading and Writing		

Description:

On the positive transition of the parameter, the RTC values are updated with the values defined on the corresponding parameters below.

P00193 - Day of the Week

Range:	0 to 6	Factory Setting:	0
Properties:	PP - Press P to validate		

Description:

It defines the day of the week, according to the [Table 10.4 on page 10-7](#), which will be updated on the RTC when there is a positive transition on P00192.

Table 10.4: Days of the week

P00193	Day of the Week
0	Sunday
1	Monday
2	Tuesday
3	Wednesday
4	Thursday
5	Friday
6	Saturday

P00194 - Day

Range:	1 to 31	Factory Setting:	1
---------------	---------	-------------------------	---

P00195 - Month

Range:	1 to 12	Factory Setting:	1
---------------	---------	-------------------------	---

P00196 - Year

Range:	0 to 4095	Factory Setting:	2011
---------------	-----------	-------------------------	------

P00197 - Hour

Range:	0 to 23	Factory Setting:	0
---------------	---------	-------------------------	---

P00198 - Minutes

Range:	0 to 59	Factory Setting:	0
---------------	---------	-------------------------	---

P00199 - Seconds

Range:	0 to 59	Factory Setting:	0
Properties:	PP - Press P to validate		

Description:

These parameters define the values for date and time that will be loaded to the real time clock at the positive transition of parameter P00192.

P00200 - Password

Range:	0 to 2	Factory Setting:	1
Properties:	RW - Reading and Writing		

Description:

It sets the password status, configuring it as active or inactive, and allowing its modification. See [Table 10.5 on page 10-8](#) below for details of each option.

Table 10.5: Options of parameter P00200

P00200	Type of Action
0	Inactive password - it allows changing the parameter content regardless P00000
1	Active password - it only allows changing the parameter content when P00000 is equal to the password value
2	Change password - it allows the user to change the password value

The password to access the parameters can be changed by the user if a value different from 5 (standard value) is desired. To make this change, set P00200 = 2 and write the new password value on P00000. Once the key PROG is pressed to go back to the view mode (show P00000 again), the value of P00200 changes automatically to 1 and the new password becomes valid.

If the user forgets the programmed password, it is possible to reset it to the default password. In order to do so, the user must keep pressing the PROG and DECREMENT keys simultaneously during the drive reset. Thus, the password becomes 5 again (default value).

P00202 - Operation Mode

10

Range:	1 to 6	Factory Setting:	2
Properties:	PP - Press P to validate		

Description:

It defines the operation mode of the servo drive, that is, which variable to be controlled: Torque, Speed or if the control will be done via Positioner Function, Ladder, CANopen, DeviceNet, EtherCAT, Profibus or Ethernet.

For further details of the Positioner Function, refer to [Chapter 20 POSITIONER FUNCTION on page 20-1](#).

Table 10.6: Selection of the operating mode

P00202	Operation Mode
1	Torque Mode
2	Speed Mode
3	Control via positioner function (torque, speed or position)
4	Control via Ladder (torque, speed or position)
5	Control via CANopen/DeviceNet/EtherCAT network (torque, speed or position)
6	Control via Profibus DP/Ethernet interface (torque, speed or position)



NOTE!

When the Positioner Function Operation Mode is selected (P00202 = 3), the Ladder application installed is not executed and the User Parameters (P01050 - P01249) are used by the Positioner Function.

P00203 - Backup to the Flash Memory Card

Range:	0 and 1	Factory Setting:	1
Properties:	RW - Reading and Writing		

Description:

It defines if the backup to the flash memory card must be done at the initialization.

Note: When the servo drive is energized and the memory card is present, parameter P00203 is checked. If it is equal to 1, the current content of the parameters is saved on the memory card. During the backup of the parameters to the card, the HMI will display the letter “b” flashing in digit 1. If the card is not connected and the option P00203 = 1, the corresponding alarm will be displayed on the HMI.

Table 10.7: Backup to the flash card

P00203	Backup to the Flash Card
0	It disables the backup at the initialization
1	It enables the backup at the initialization

P00204 - Load Parameters

Range:	0 to 13	Factory Setting:	0
Properties:	PP - Press P to validate		

Description:

It allows saving the current parameters of the servo drive to the flash memory card or, otherwise, loading the parameters with the content of this card. It also allows loading all the parameters with their respective factory default values. The [Table 10.8 on page 10-9](#) details the actions of each option.

Table 10.8: Options of parameter P00204

P00204	Options
0	Disabled
1 - 4	No function
5	It loads factory default values on the parameters
6	SCA06 → FMC: It transfers the current content of the servo drive parameters to the flash memory card
7	FMC → SCA06: it transfers the content of the parameters on the flash memory card to the control card of the SCA06
8 - 11	No function
12	It erases the user’s program
13	It loads the factory default to the parameters, erases the application software, erases all the flash memory card and cleans all parameters relating to alarms and faults occurred

For the function load factory default (P00204 = 5), the factory default values will be loaded to the writing parameters and the HMI will not be available for operation, just displaying the letter P flashing in digit 1.

The backup/ download to the flash memory card function allows saving the servo drive parameter contents to the flash memory card (FMC) or vice-versa, and it can be used to transfer the parameter contents of one servo drive to another, provided that the firmware version is compatible.

If options 6 or 7 are set, the HMI is not available for operation, just displaying the letter “b” (backup) flashing in digit 1 while the function is being executed.

Option 12 erases the user’s program from the internal flash memory.

When you select the option P00204 = 00013, first the factory default values will be loaded to the parameters, and the HMI will be displaying the letter P flashing in digit 1. Then the user’s application is erased from the internal flash memory of the processor and from the FMC, as well as the configurations of the user’s parameters and configurations of the CANopen network, if those files were saved. At the moment the files are being erased, the HMI will display the letter E (Erasing) flashing in digit 1. After erasing all the content of the flash memory card, the parameters relating to alarms and faults occurred will also be deleted.

P00209 - Position and Speed Feedback Source

Range:	0 to 6	Factory Setting:	0
Properties:	RW - Reading and Writing		

Description:

It selects the source of the position and speed feedback for servo drive, according to [Table 10.9 on page 10-10](#).

Table 10.9: Options for source of position and speed feedback

P00209	Options
0	Position and speed feedback by the motor internal Sensor
1	External position and speed feedback by the Default counter - Fast inputs
2	External position and speed feedback by the Counter 1 - Encoder 1 input
3	External position and speed feedback by the Counter 2 - Encoder 2 input
4	External feedback only of position by the Default counter - Fast inputs
5	External feedback only of position by the Counter 1 - Encoder 1 input
6	External feedback only of position by the Counter 2 - Encoder 2 input

Normally options 4, 5 and 6 result in a more stable control than options 1, 2 and 3.

In options 1, 2 and 3 all parameters and markers regarding speed refer to the encoder; for instance, P00002 indicates the speed of the encoder and not of the motor, P00121 is the speed reference for the encoder and not for the motor, etc. Therefore, for a correct operation, the encoder number of pulses per revolution (P00506, P00516 or P00526) must be properly set.

In options 4, 5 and 6, the speed reading parameters refer to the motor (for example, P0002 indicates the motor speed) and the speed reference markers and parameters refer to the encoder (for example, P00121 is the speed reference for the encoder and not for the motor). The correct setting of parameters P00210 and P00211 is essential.

10

P00210 - Reduction of the External Feedback: Numerator

Range:	1 to 32767	Factory Setting:	1
Properties:	RW - Reading and Writing		

Description:

Number of revolutions of the external feedback (encoder) at the reduction.

Numerator of the mechanical reduction present between the external feedback and the motor shaft.

This parameter is used in the speed calculations together with P00211, and for protection against external feedback loss (together with P00214); in this case, the Numerator / Denominator ratio is used to compare the encoder speed referenced to the motor shaft with the internal sensor speed of the motor.

P00211 - Reduction of the External Feedback: Denominator

Range:	1 to 32767	Factory Setting:	1
Properties:	RW - Reading and Writing		

Description:

Number of motor revolutions at the reduction.

Denominator of the mechanical reduction existing between the external feedback and the motor shaft. See P00210.

P00213 - Direction of Rotation of the External Feedback

Range:	0 and 1	Factory Setting:	0
Properties:	RW - Reading and Writing		

Description:

It selects the direction of the external feedback, which must be equal to that of the motor sensor. If the external feedback is inverted in relation to the motor, this parameter must be set to 1.

P00214 - Protection Against Loss of External Feedback

Range:	0 to 9999	Factory Setting:	1000
Properties:	RW - Reading and Writing		

Description:

It is the value of the maximum difference allowed between the encoder speed (already with the necessary ratios) and the motor shaft speed.

Due to the low precision of this parameter, it must be used only as a protection in case of there is a loss of external feedback. It cannot be used for detection of following lag error, for example.

P00216 - Switching Frequency of the PWM

Range:	0 to 4	Factory Setting:	2
Properties:	RW - Reading and Writing		

Description:

It determines the switching frequency of the servo drive PWM according to the [Table 10.10 on page 10-11](#):

Table 10.10: Switching frequency

P00216	Options
0	Reserved
1	Reserved
2	10 kHz
3	Reserved
4	Reserved

P00217 - Single-Phase/Three-Phase Power Supply

Range:	0 and 1	Factory Setting:	1
Properties:	RW - Reading and Writing		

Description:

It selects the type of power supply for the servo drive.

Note: The single-phase supply is only valid for servo drives of 5 A and 220 V. When set for single-phase supply, it starts operating as a servo drive of 4 A.

Table 10.11: Single-Phase/Three-Phase Power Supply

P00217	Options
0	Single phase
1	Three phase

P00219 - Fault Reset

Range:	0 and 1	Factory Setting:	0
Properties:	RW - Reading and Writing		

Description:
It resets the faults when there is rising edge on the parameter.

The fault reset function is also available via digital input. It is important to note that when the fault reset option is selected in some of the digital inputs, the writing in the parameter will no longer execute the function.

Table 10.12: Fault reset

P00219	Options
0	Disabled
1	Disabled
0 → 1	Fault reset

P00221 - Vbat Alarm

Range:	0 and 1	Factory Setting:	0
Properties:	RW - Reading and Writing		

Description:
If parameter P00221 = 1, it enables the battery alarm and this alarm will occur in case the battery voltage level is below 2.3 V. If P00221 = 0, this alarm will not occur, regardless the battery voltage.

Table 10.13: Vbat Alarm

P00221	Options
0	Disable alarm
1	Enable alarm

10



ATTENTION!
When the battery voltage level below 2.3 V occurs, it is recommended to replace the battery. To change the battery, the servo drive control module must be energized in order to prevent the loss of the retentive markers. Refer to the user’s manual for more details about battery replacement.

P00230 - I x t Protection Option

Range:	0 and 1	Factory Setting:	0
Properties:	RW - Reading and Writing		

Description:
The servo drive stands a current above the rated current for a certain period of time, after which the I x t protection actuates. This period is determined by the formula I x t, where I is the real current minus the servo drive rated current, and t is the time that this current is above the rated current, according to [Figure 10.1 on page 10-13](#).

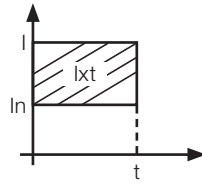

Figure 10.1: Graph of the I x t function

The I x t protection actuation length depends on the servo drive model and on how much the real current is above the rated current, according to [Table 10.14 on page 10-13](#).

Table 10.14: I x t Values

Model	Actuation Length of the I x t Protection ⁽¹⁾	Example
4 A	$t = \frac{12}{I - I_n}$	Stands 8 A for 3 seconds
5 A	$t = \frac{15}{I - I_n}$	It stands 8 A for 5 seconds
8 A	$t = \frac{24}{I - I_n}$	It stands 16 A for 3 seconds
16 A	$t = \frac{48}{I - I_n}$	It stands 32 A for 3 seconds
24 A	$t = \frac{72}{I - I_n}$	It stands 48 A for 3 seconds
5,3 A	$t = \frac{8.1}{I - I_n}$	It stands 8 A for 3 seconds
14 A	$t = \frac{42}{I - I_n}$	Suporta 28 A durante 3 segundos

(1) This formula is only valid for currents above the rated current value.

The way the I x t protection acts depends on the setting of parameter P00230, according to [Table 10.15 on page 10-13](#).

Table 10.15: Option I x t

P00230	Actuation of I x t Protection
0	It generates F00005 after the actuation time elapsed
1	It limits $I = I_{rat}^{(2)}$ and generates alarm after actuation time elapsed

(2) In this setting (P00230 = 1), alarm A00015 occurs instead of fault F00005. To increase the output current again (perform an acceleration, for example), first it must be decreased, so that the current rms value becomes smaller. Using this option can imply longer acceleration times.

10.2 ANALOG INPUT

In the standard configuration of the SCA06, there is only one analog input (AI1) available, and, as an optional item, another input (AI2) can be added, in a total of two analog inputs. With those inputs it is possible, for example, to use an external speed or position reference. The details for those configurations are described in the parameters below.

P00232 - Function of the Analog Input AI1

Range:	0 to 4	Factory Setting: 0
Properties:	RW - Reading and Writing	

Description:

It defines the function of analog input AI1, according to [Table 10.16 on page 10-14](#).

Table 10.16: Function options for analog inputs

P00232	Function of AI1	Scale (considering gain = 1.000)
0	Disabled	-
1	Current reference (torque)	Mod. 5/8 - 220 V: 10 V = 14.1 Arms Mod. 8/16 - 220 V: 10 V = 23.5 Arms Mod. 16/32 - 220 V: 10 V = 70.7 Arms Mod. 24/48 - 220 V: 10 V = 70.7 Arms Mod. 5.3/8 - 380 V: 10 V = 14.1 Arms Mod. 14/28 - 380 V: 10 V = 35.3 Arms Mod. 30/60 - 380 V: 10 V = 90.1 Arms
2	Speed reference	10 V = P00402
3	Current limit (torque)	The same as option 1
4	Enabled ⁽¹⁾	-

(1) When the option 4 is selected in the function of the analog input, its reading will be done and displayed on the corresponding view parameter. Besides, this value will be available for using via Ladder, for example.

Examples of use of the analog input as speed reference:

- Considering a motor of 2000 rpm, with a gain value P00233 = 0.500 and a voltage at the analog input of 5 V, the speed reference will be:

$$\text{Speed}_{\text{ref}} = \frac{V_{\text{in_analog}} * P00402 * P00233}{10 \text{ V}} = \frac{5 * 2000 * 0.500}{10} = 500 \text{ rpm}$$

- Considering a motor of 6000 rpm, with gain value P00233 = 1.000 and a voltage at the analog input of 7.5 V, the reference speed will be:

$$\text{Speed}_{\text{ref}} = \frac{V_{\text{in_analog}} * P00402 * P00233}{10 \text{ V}} = \frac{7.5 * 6000 * 1.000}{10} = 4500 \text{ rpm}$$

10

P00233 - Gain of the Analog Input AI1

Range:	-32.768 to 32.767	Factory Setting: 1.000
Properties:	RW - Reading and Writing	

Description:

Gain of the analog input AI1. See Figure 10.2 on page 10-14.

The signal at the analog input is multiplied by the gain. The resulting value is added to the offset. The final value is passed through a low-pass filter and, after that it will be available for the control (Ref.).

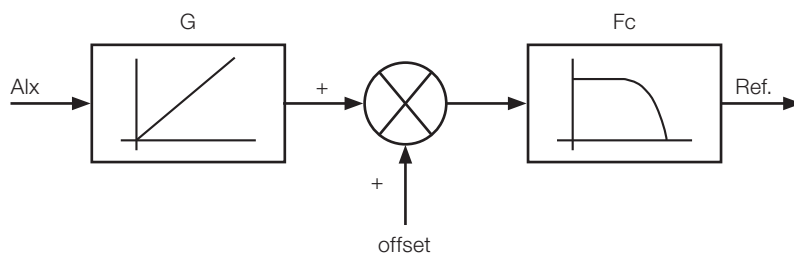

Figure 10.2: Block diagram of the analog inputs

P00235 - Offset of the Analog Input AI1

Range:	-32768 to 32767	Factory Setting:	0
Properties:	RW - Reading and Writing		

Description:

Offset of the analog input AI1. See [Figure 10.2 on page 10-14](#).

When the analog input is programmed for speed reference, P00235 = 00001 corresponds to 0.01 rpm.

In the other cases, P00235 = 00001 corresponds to 0.001 V.

P00236 - Filter of the Analog Input AI1

Range:	0 to 4000	Factory Setting:	150
Properties:	RW - Reading and Writing		

Description:

The adjusted value corresponds to the cut-off frequency in Hz, used for the 1st order filtering of the signal read on the analog input AI1. See [Figure 10.2 on page 10-14](#).

P00237 - Function of the Analog Input AI2

Range:	0 to 4	Factory Setting:	0
Properties:	RW - Reading and Writing AC - Accessory		

Description:

It defines the function of the analog input AI2, according to [Table 10.16 on page 10-14](#).

P00238 - Gain of the Analog Input AI2

Range:	-32.768 to 32.767	Factory Setting:	1.000
Properties:	RW - Reading and Writing AC - Accessory		

Description:

Gain of the analog input AI2. See [Figure 10.2 on page 10-14](#).

P00239 - Signal type of the Analog Input AI2

Range:	0 and 1	Factory Setting:	0
Properties:	RW - Reading and Writing AC - Accessory		

Description:

Signal type of the Analog input AI2.

Table 10.17: Signal type of the analog input AI2

P00239	Signal of the Analog Input
0	(-10 to 10) V / (0 to 20) mA ⁽¹⁾
1	(4 to 20) mA ⁽¹⁾

⁽¹⁾ The accessory must be configured for the current mode. For further details, refer to the Installation, Configuration and Operation Guide of the EAN1.

P00240 - Offset of the Analog Input AI2

Range:	-32768 to 32767	Factory Setting:	0
Properties:	RW - Reading and Writing AC - Accessory		

Description:
Offset of the analog input AI2. See [Figure 10.2 on page 10-14](#).

When the analog input is programmed for speed reference, P00240 = 00001 corresponds to 0.01 rpm.
In the other cases, P00240 = 00001 corresponds to 0.001 V.

P00241 - Filter of the Analog Input AI2

Range:	0 to 4000	Factory Setting:	150
Properties:	RW - Reading and Writing AC - Accessory		

Description:
The adjusted value corresponds to the cut-off frequency in Hz, used for the 1st order filtering of the signal read on the analog input AI2. See [Figure 10.2 on page 10-14](#).

10.3 ANALOG OUTPUTS

10

In the default configuration of the SCA06, analog outputs are not available. But an accessory (EAN2) is available, providing 12-bit voltage analog outputs from -10 V to +10 V.

P00251 - Function of the Analog Output AO1

P00255 - Function of the Analog Output AO2

Range:	0 to 4	Factory Setting:	0
Properties:	RW - Reading and Writing AC - Accessory		

Description:
DI defines the function of the analog outputs AO1 and AO2, according to [Table 10.18 on page 10-17](#).

Table 10.18: Function options for analog outputs

P00251-P00255	Function
0	0 V
1	Analog input 1
2	Analog Input 2
3	Written by the ladder
4	Reserved
5	Filtered acceleration
6	Speed
7	Filtered speed
8	Shaft mechanical position
9	Shaft electrical position
10	Iq (torque current)
11	Id
12	Vq
13	Vd
14	Reserved
15	Iv
16	Iw
17	Vu
18	Vv
19	Vw
20	Vlink
21	Filtered Vlink
22	Iq reference (torque current)
23	Reserved
24	Speed reference
25	Iq feedforward (torque current)
26	Reserved
27	Generated trajectory: Jerke (real shaft)
28	Generated trajectory: acceleration (real shaft)
29	Generated trajectory: speed (real shaft)
30	Generated trajectory: position (real shaft)
31	Reserved
32	Lag error
33	Reserved
34	Generated trajectory: Jerke (virtual shaft)
35	Generated trajectory: acceleration (virtual shaft)
36	Generated trajectory: speed (virtual shaft)
37	Generated trajectory: position (virtual shaft)
38	Reserved
39	Default counter value
40	Counter 1 value
41	Counter 2 value
42	Default counter speed
43	Counter 1 speed
44	Counter 2 speed
45	Resolver speed
46	Status word
47 - 49	Reserved
50	10 V

P00252 - Gain of the Analog Output AO1

P00256 - Gain of the Analog Output AO2

Range:	-32.768 to 32.767	Factory Setting: 1.000
Properties:	RW - Reading and Writing AC - Accessory	

Description:
Analog output gain.

The signal to be fed at the analog output is multiplied by the gain and then the offset is added to this result.

P00253 - Offset of the Analog Output AO1

P00257 - Offset of the Analog Output AO2

Range:	-32768 to 32767	Factory Setting:	0
Properties:	RW - Reading and Writing AC - Accessory		

Description:
Analog output offset.

The signal to be fed at the analog output is multiplied by the gain and then the offset is added to this result.

10.4 DIGITAL INPUTS AND OUTPUTS

To use the digital inputs and outputs, the servo drive SCA06 features three digital inputs and one 1 output in its standard version, seeing that this number can be expanded up to 39 inputs and 19 outputs by adding the respective accessories.

A more detailed explanation of the parameters corresponding to those digital inputs and outputs is given below.

P00270 - Default Filter DIs

Range:	0 to 3276.7	Factory Setting:	0
Properties:	RW - Reading and Writing		

Description:
A value greater than zero in this parameter make the default digital inputs be filtered. The filter value is given in ms (milliseconds).

Note: This filter is only effective in the functions performed by the software (such as enabling, stop function, etc.). The filter has no effect on the functions performed by the hardware (fast counter and storage of position/counter).

P00271 - Filter of the DIs of Slot 1

P00272 - Filter of the DIs of Slot 2

P00273 - Filter of the DIs of Slot 3

Range:	0 to 3276.7	Factory Setting:	0
Properties:	PP - Press P to validate		

Description:
A value greater than zero in these parameters make the digital inputs of the accessories connected to slots 1, 2 and 3, respectively, be filtered. The filter value is the multiplication of the parameter by the PLC scan cycle (configured in parameter P01021). For example: If P01021 = 5.0 ms and P00271 = 2, the digital inputs of the accessory connected to slot 1 will be filtered in 10 ms.

P00277 - Hysteresis for Nx (H)

Range:	0 to 9999	Factory Setting:	0
Properties:	RW - Reading and Writing		

Description:
Defines the lower and the upper values of the hysteresis for Nx.

P00278 - Keypad Speed Reference (Nx)

Range:	0 to 9999	Factory Setting:	0
Properties:	RW - Reading and Writing		

Description:

Reference point where functions $N > N_x$ and $N < N_x$ (options 12 and 13) work.

P00279 - Keypad Current Reference (Tx)

Range:	0.0 to 3276.7	Factory Setting:	0
Properties:	RW - Reading and Writing		

Description:

Reference point where functions $T > T_x$ and $T < T_x$ (options 12 and 13) work.

P00280 - Function of Digital Output DO1 (default)

Range:	0 to 16	Factory Setting:	0
Properties:	PP - Press P to validate		

Description:

Through this parameter you can select the function for the digital output according to [Table 10.19 on page 10-19](#).

Table 10.19: Options for programming the parameters of the digital outputs P00280 to P00298

P00280	Function	Note
0	Disabled	Digital output at low level
1	Enable/Disable	See P00099
2	Stop Function	When stop is activated, the output is in high level
3	Reserved	
4	Reserved	
5	Servo Ready	Output activated when the servo is enabled and with no errors
6	No Fault	Output remains activated while there are not faults
7	Reserved	
8	Written by Ladder	Output used by Ladder program
9	Written by CAN	Output activated by CAN network
10	Reserved	
11	Output Activated	Output always high level
12	$N > N_x$	The digital output is activated when $N > (N_x + H)$ and deactivated when $N < (N_x - H)$
13	$N < N_x$	The digital output is activated when $N < (N_x - H)$ and deactivated when $N > (N_x + H)$
14	$N = N^*$	The digital output is activated when $N = N^*$ and deactivated when $N \neq N^*$
15	$T > T_x$	The digital output is activated when $T > T_x$ and deactivated when $T < T_x$
16	$T < T_x$	The digital output is activated when $T < T_x$ and deactivated when $T > T_x$

Notation:

H = speed hysteresis (P00277).

N = motor speed (P00002).

N_x = speed reference point (P00278).

N^* = speed reference (P00121).

T = motor current (P00003).

T_x = current reference point (P00279).

P00281 - Function of the Digital Output DO101 (Accessory Slot1)

P00282 - Function of the Digital Output DO102 (Accessory Slot1)

P00283 - Function of the Digital Output DO103 (Accessory Slot1)

P00284 - Function of the Digital Output DO104 (Accessory Slot1)

P00285 - Function of the Digital Output DO105 (Accessory Slot1)

P00286 - Function of the Digital Output DO106 (Accessory Slot1)

P00287 - Function of the Digital Output DO201 (Accessory Slot2)

P00288 - Function of the Digital Output DO202 (Accessory Slot2)

P00289 - Function of the Digital Output DO203 (Accessory Slot2)

P00290 - Function of the Digital Output DO204 (Accessory Slot2)

P00291 - Function of the Digital Output DO205 (Accessory Slot2)

P00292 - Function of the Digital Output DO206 (Accessory Slot2)

P00293 - Function of the Digital Output DO301 (Accessory Slot3)

P00294 - Function of the Digital Output DO302 (Accessory Slot3)

P00295 - Function of the Digital Output DO303 (Accessory Slot3)

P00296 - Function of the Digital Output DO304 (Accessory Slot3)

P00297 - Function of the Digital Output DO305 (Accessory Slot3)

P00298 - Function of the Digital Output DO306 (Accessory Slot3)

Range: 0 to 16

Factory Setting: 0

Properties: PP - Press P to validate
AC - Accessory

Description:

Through this parameter you can select the function of the digital outputs according to [Table 10.19 on page 10-19](#).



ATTENTION!

When performing the reset, the status of the digital outputs of the accessories will not change. That is, if the DO101 is active, even during the reset this output will remain active.

P00300 - Function of the Digital Input DI1 (default)

P00301 - Function of the Digital Input DI2 (default)

P00302 - Function of the Digital Input DI3 (default)

Range:	0 to 20	Factory Setting:	0
Properties:	PP - Press P to validate		

Description:

Through those parameters you can select the desired function for the digital inputs according to [Table 10.20 on page 10-21](#). Those digital inputs have different hardware allowing the execution of the special functions, besides the other functions.

Table 10.20: Options for programming the parameters of the digital input P00300 to P00338

P00300 to P00338	Function	Note
0	No function	
1 ⁽¹⁾	Enabling	Closed = Enable Open = Disable Write to P00099 = 2 (See P00099)
2 ⁽¹⁾	Stop function high active	Closed = Stop shaft Open = Release shaft
3 ⁽¹⁾	Stop function low active	Closed = Release shaft Open = Stop shaft
4	Standard fast counter Only P00300 and P00301	See P00500 Available only at Inputs 1 and 2
5	Reset the standard fast counter Only for P00302	Resets the pulse counter when DI3 = 1 Available only at Input 3
6	Clean fault	Clean the fault when leading edge occurs at DIx Write on P00219 (See P00219)
7	Direction of rotation	When programmed, inverts the direction of rotation of the servomotor
8	Stores position ⁽²⁾ - rising edge Only P00300, P00301 and P00302	Stores the position when rising edge occurs at DIx Available only at Inputs 1, 2 and 3
9	Stores position ⁽²⁾ - falling edge Only P00300, P00301 and P00302	Stores the position when falling edge occurs at DIx
10	Stores standard counter ⁽²⁾ - rising edge Only P00302	Stores the counter value when rising edge occurs at DI3 Available only at Input 3
11	Stores standard counter ⁽²⁾ - Falling edge Only P00302	Stores the counter value when falling edge occurs at DI3 Available only at Input 3
12 ⁽¹⁾	Limit switch clockwise high active ⁽³⁾	Closed = Active Opened = Disabled Current doing wr_ref = 0
13 ⁽¹⁾	Limit switch clockwise low active ⁽³⁾	Closed = Disabled Opened = Active Current doing wr_ref = 0
14 ⁽¹⁾	Limit switch counterclockwise high active ⁽³⁾	Closed = Active Opened = Disabled Current doing wr_ref = 0
15 ⁽¹⁾	Limit switch counterclockwise low active ⁽³⁾	Closed = Disabled Opened = Active Current doing wr_ref = 0
16 - 17	Reserved	
18	Stores position and standard counter ⁽²⁾ - rising edge Only P00302	Stores the value of the position and of the counter when rising edge occurs at DI3 Available only at Input 3
19	Stores position and standard counter ⁽²⁾ - falling edge Only P00302	Stores the value of the position and of the counter when falling edge occurs at DI3 Available only at Input 3
20	External fault	Open = Generates external fault Closed = Does not generate fault

(1) Only one DI can be programmed for the related function.

(2) The values of position and of the standard counter are stored on parameters P01003 to P01015, depending on the selected function.

(3) Limit switch function is not available when the control is operating in torque mode.

P00303 - Function of the Digital Input DI101 (Accessory Slot1)

P00304 - Function of the Digital Input DI102 (Accessory Slot1)

P00305 - Function of the Digital Input DI103 (Accessory Slot1)

P00306 - Function of the Digital Input DI104 (Accessory Slot1)

P00307 - Function of the Digital Input DI105 (Accessory Slot1)

P00308 - Function of the Digital Input DI106 (Accessory Slot1)

P00309 - Function of the Digital Input DI107 (Accessory Slot1)

P00310 - Function of the Digital Input DI108 (Accessory Slot1)

P00311 - Function of the Digital Input DI109 (Accessory Slot1)

P00312 - Function of the Digital Input DI110 (Accessory Slot1)

P00313 - Function of the Digital Input DI111 (Accessory Slot1)

P00314 - Function of the Digital Input DI112 (Accessory Slot1)

P00315 - Function of the Digital Input DI201 (Accessory Slot2)

P00316 - Function of the Digital Input DI202 (Accessory Slot2)

P00317 - Function of the Digital Input DI203 (Accessory Slot2)

P00318 - Function of the Digital Input DI204 (Accessory Slot2)

P00319 - Function of the Digital Input DI205 (Accessory Slot2)

P00320 - Function of the Digital Input DI206 (Accessory Slot2)

P00321 - Function of the Digital Input DI207 (Accessory Slot2)

P00322 - Function of the Digital Input DI208 (Accessory Slot2)

P00323 - Function of the Digital Input DI209 (Accessory Slot2)

P00324 - Function of the Digital Input DI210 (Accessory Slot2)

P00325 - Function of the Digital Input DI211 (Accessory Slot2)

P00326 - Function of the Digital Input DI212 (Accessory Slot2)

P00327 - Function of the Digital Input DI301 (Accessory Slot3)

P00328 - Function of the Digital Input DI302 (Accessory Slot3)

P00329 - Function of the Digital Input DI303 (Accessory Slot3)

P00330 - Function of the Digital Input DI304 (Accessory Slot3)

P00331 - Function of the Digital Input DI305 (Accessory Slot3)

P00332 - Function of the Digital Input DI306 (Accessory Slot3)

P00333 - Function of the Digital Input DI307 (Accessory Slot3)

P00334 - Function of the Digital Input DI308 (Accessory Slot3)

P00335 - Function of the Digital Input DI309 (Accessory Slot3)

P00336 - Function of the Digital Input DI310 (Accessory Slot3)

P00337 - Function of the Digital Input DI311 (Accessory Slot3)

P00338 - Function of the Digital Input DI312 (Accessory Slot3)

Range:	0 to 20	Factory Setting: 0
Properties:	PP - Press P to validate AC - Accessory	

Description:

Through these parameters you can select the desired function for the digital input according to [Table 10.20 on page 10-21](#).

10.5 ENCODER SIMULATOR

By using the appropriate accessory, the servo drive simulates an encoder coupled to the servomotor shaft. In order to configure the encoder simulator, there are some parameters that must be set.

P00340 - Number of Pulses of the Encoder Simulator

Range:	0 to 4096	Factory Setting: 1024
Properties:	PP - Press P to validate AC - Accessory	

Description:

It defines the number of pulses per revolution provided by the servo drive at the encoder simulator output.

Note: The maximum number of pulses varies with the speed:
 4096 pulses for speeds up to 3000 rpm.
 1024 pulses for speeds above 3000 rpm.

P00341 - Null Pulse Position

Range:	1 to 4096	Factory Setting:	1
Properties:	PP - Press P to validate AC - Accessory		

Description:

It defines the null pulse position (N) at the encoder simulator output.

Note: The maximum value must be equal to the number of pulses programmed (P00340).

P00342 - Select Sequence

Range:	0 and 1	Factory Setting:	0
Properties:	PP - Press P to validate AC - Accessory		

Description:

It defines the pulse sequence at the encoder simulator output.

Table 10.21: Pulse sequence for the encoder simulator

P00342	Pulse Sequence
0	A to B Sequence
1	B to A Sequence

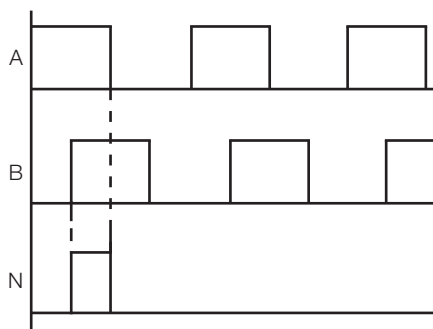

Figure 10.3: A → B pulse sequence

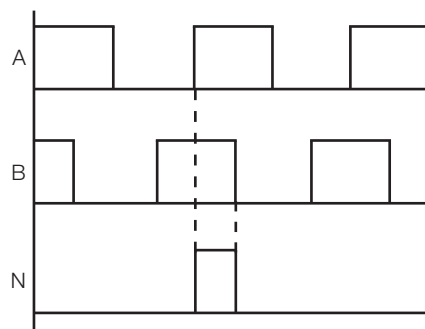

Figure 10.4: B → A pulse sequence

P00344 - Enable the Generation of the Output Driver Alarm of the Encoder Simulator

Range:	0 to 32767	Factory Setting:	10
Properties:	AC - Accessory		

Description:

A value greater than zero in this parameter generates alarm A0214. This alarm occurs in the following conditions:

- Encoder simulator not supplied.
- Supply of the encoder simulator out of the specified range.
- Overload/short circuit at the encoder simulator output.

The value set in the parameter is the time in ms that the servo drive waits until it starts to monitor this fault. This time is useful when the encoder simulator is supplied after the servo drive, and for the time the encoder simulator was not supplied, the generation of this alarm is not desired.

10.6 POWER FAN

P00352 - Power Fan Control

Range:	0 and 1	Factory Setting: 0
Properties:	RW - Reading and Writing	

Description:

It defines the control used to drive the power fan, allowing the user to chose between software fan control (only when it reaches a certain temperature) or continuously enabled.

Table 10.22: Power fan control

P00352	Fan Control
0	Control by temperature
1	Turn on fan

10.7 MOTOR POSITION SENSOR

P00360 - Position Sensor Installed on the Motor

Range:	0 to 5	Factory Setting: 0
Properties:	PP - Press P to validate	

Description:

If the position sensor installed on the motor is not the resolver, this parameter must be configured according to the sensor installed.

Table 10.23: Position sensor installed on the motor

P00360	Sensor
0	Revolver
1	Encoder Hiperface® DSL
2	Encoder EnDat
3	Reserved
4	Reserved
5	Reserved

P00361 - Encoder Module Version

Range:	0.00 to 655.35	Factory Setting: -
Properties:	RO - Read Only AC - Accessory	

Description:

Indicates the version of the encoder module.

P00362 - Number of Turns of the Encoder

Range:	0 to 65535	Factory Setting: 0
Properties:	RO - Read Only AC - Accessory	

Description:

This parameter indicates the number of revolutions of the motor encoder connected to the encoder input accessory in case the encoder is of the multi-turn type.

This parameter is only used when the motor feedback device is not the resolver.

P00363 - Encoder Resolution

Range:	0 to 26	Factory Setting:	0
Properties:	RO - Read Only AC - Accessory		

Description:
 This parameter indicates the resolution of the motor encoder connected to the encoder input accessory.
 This parameter is only used when the motor feedback device is not the resolver.

P00365 - Encoder Temperature

Range:	-32767 to 32767	Factory Setting:	0
Properties:	RO - Read Only AC - Accessory		

Description:
 This parameter indicates the temperature of the motor encoder connected to the encoder input accessory.
 This parameter is only used when the motor feedback device is not the resolver.

P00368 - Encoder Maintenance Password

Range:	0 to 65535	Factory Setting:	0
Properties:	RW - Reading and Writing AC - Accessory		

Description:
 This parameter allows modifying the settings regarding the motor encoder connected to the encoder input accessory, which are exclusively used for maintenance.
 This parameter is only used when the motor feedback device is not the resolver.

P00369 - Electrical Position of the Motor Shaft

Range:	0 to 65535	Factory Setting:	0
Properties:	RO - Read Only		

Description:
 This parameter indicates the electric position of the motor shaft supplied by the position feedback device connected to it.

P00370 - Reserved

Range:	Reserved	Factory Setting:	Reserved
Properties:			

P00371 - Reserved

Range:	Reserved	Factory Setting:	Reserved
Properties:			

P00372 - Reserved

Range:	Reserved	Factory Setting:	Reserved
Properties:			

P00373 - Reserved

Range:	Reserved	Factory Setting:	Reserved
Properties:			

P00374 - Align Motor Shaft

Range:	-32767 to 32767	Factory Setting:	0
Properties:	RW - Reading and Writing		

Description:

This parameter allows aligning the motor shaft and it is exclusively used for maintenance.

P00375 - Reserved

Range:	Reserved	Factory Setting:	Reserved
Properties:			

P00376 - Reserved

Range:	Reserved	Factory Setting:	Reserved
Properties:			

P00377 - Encoder Cable Fail Filter

Range:	0 to 32767	Factory Setting:	0
Properties:	RW - Reading and Writing AC - Accessory		

Description:

Number of times encoder cable failure can occur before fault F01205 is generated.

P00378 - Encoder Cable Fail Counter

Range:	0 to 65535	Factory Setting:	-
Properties:	RO - Read Only AC - Accessory		

Description:

Indicates the number of encoder cable failures that occurred.

P00379 - Reserved

Range:	Reserved	Factory Setting:	Reserved
Properties:			

P00380 - Reserved

Range:	Reserved	Factory Setting:	Reserved
Properties:			

P00381 - Reserved

Range:	Reserved	Factory Setting:	Reserved
Properties:			

P00382 - Reserved

Range:	Reserved	Factory Setting:	Reserved
Properties:			

P00383 - Reserved

Range:	Reserved	Factory Setting:	Reserved
Properties:			

P00384 - Reserved

Range:	Reserved	Factory Setting:	Reserved
Properties:			

11 MOTOR/CURRENT CONTROL PARAMETERS

In this parameter group are information and characteristics related to the motor and to its current control, such as gains, speed and rated current, etc.

P00385 - Servomotor Model

Range:	0 to 99	Factory Setting:	24
Properties:	PP - Press P to validate		

Description

It selects the servomotor model that is connected to the servo drive, according to [Table 11.1 on page 11-1](#) and loads the corresponding values on parameters P00392 to P00424.

Table 11.1: Selection of the servomotor model

P00385	Servomotor Model - (220 V to 230 V)	P00385	Servomotor Model - (380 V to 480 V)
0	No model selected	50	Reserved
1	Reserved	51	Reserved
2	Reserved	52	Reserved
3	SWA 562-2,5-20	53	Reserved
4	SWA 562-3,8-20	54	Reserved
5	SWA 562-6,1-20	55	SWA 564-6,1-20
6	SWA 562-8,0-20	56	SWA 564-8,0-20
7	SWA 712-9,3-20	57	SWA 714-9,3-20
8	SWA 712-13-20	58	SWA 714-13-20
9	SWA 712-15-20	59	SWA 714-15-20
10	SWA 712-19-20	60	SWA 714-19-20
11	SWA 712-22-20	61	SWA 714-22-20
12	SWA 712-25-20	62	SWA 714-25-20
13	Reserved	63	Reserved
14	Reserved	64	Reserved
15	Reserved	65	SWA 714-40-20
16	SWA 712-13-25	66	Reserved
17	Reserved	67	Reserved
18	Reserved	68	SWA 1004-50-28
19	SWA 402-0,8-30	69	Reserved
20	SWA 402-1,6-30	70	Reserved
21	SWA 402-2,6-30	71	Reserved
22	SWA 562-2,5-30	72	SWA 564-2,5-30
23	SWA 562-4,0-30	73	SWA 564-4,0-30
24	SWA 562-6,1-30	74	SWA 564-6,1-30
25	SWA 562-7,0-30	75	SWA 564-7,0-30
26	SWA 712-9,3-30	76	SWA 714-9,3-30
27	SWA 712-13-30	77	SWA 714-13-30
28	SWA 712-15-30	78	SWA 714-15-30
29	SWA 712-19-30	79	SWA 714-19-30
30	Reserved	80	Reserved
31	Reserved	81	SWA 714-26,5-30
32	Reserved	82	SWA 714-34-30
33	Reserved	83	Reserved
34	Reserved	84	Reserved
35	Reserved	85	Reserved
36	Reserved	86	Reserved
37	SWA 402-1,6-60	87	Reserved
38	SWA 402-2,6-60	88	SWA 404-2,6-60
39	SWA 562-2,5-60	89	SWA 564-2,5-60
40	SWA 562-3,6-60	90	SWA 564-3,6-60
41	SWA 562-5,5-60	91	SWA 564-5,5-60
42	SWA 562-6,5-60	92	SWA 564-6,5-60
43	Reserved	93	Reserved
44	Reserved	94	Reserved
45	Reserved	95	Reserved
46	Reserved	96	Reserved
47	Reserved	97	Reserved
48	Reserved	98	Reserved
49	Reserved	99	Reserved

Note: When P00385 = 0, parameters P00392 to P00421 are not loaded, remaining the value previously set.

P00390- Filter of the Iq Reference (Fc in Hz)

Range:	0 to 4000	Factory Setting:	4000
Properties:	RW - Reading and Writing		

Description

Cut-off frequency of the low-pass filter applied to torque reference (Iq). If this parameter is set to 0, this filter is not applied.

P00392 ⁽³⁾ - Proportional Gain of the Iq Current PID (Kp)

Range:	0 to 32767	Factory Setting:	1343
---------------	------------	-------------------------	------

P00393 ⁽³⁾ - Integral Gain of the Iq Current PID (Ki)

Range:	0 to 32767	Factory Setting:	75
---------------	------------	-------------------------	----

P00395 ⁽³⁾ - Proportional Gain of the Id Current PID (Kp)

Range:	0 to 32767	Factory Setting:	1959
---------------	------------	-------------------------	------

P00396 ⁽³⁾ - Integral Gain of the Id Current PID (Ki)

Range:	0 to 32767	Factory Setting:	597
---------------	------------	-------------------------	-----

Properties: RW - Reading and Writing

Description

These gains are related to the current PID control.

P00398 ⁽³⁾ - Phase Compensation with wr

Range:	-32768 to 32767	Factory Setting:	8192
---------------	-----------------	-------------------------	------

Properties: RW - Reading and Writing

Description

It is a compensation for the phase delay due to speed.

P00399 ⁽³⁾ - Resolver Offset

Range:	0 to 32767	Factory Setting:	0
---------------	------------	-------------------------	---

Properties: RW - Reading and Writing

Description

It compensates occasional differences between the zero position of the resolver and the zero position of the servomotor.

P00401 ⁽³⁾ - Motor Rated Current

Range:	0.0 to 999.9	Factory Setting:	8.5
Properties:	RW - Reading and Writing		

Description

This parameter shows the value of the motor rated current in Arms.

P00402 ⁽³⁾ - Motor Rated Speed

Range:	0 to 9999	Factory Setting:	3000
Properties:	RW - Reading and Writing		

Description

It shows the motor rated speed in rpm.

P00407 ⁽³⁾ - p/2: Number of Pairs of Poles of the Motor

Range:	0 to 16	Factory Setting:	4
Properties:	RW - Reading and Writing		

Description

It defines the number of pairs of poles of the servomotor being used (number of poles / 2).

P00409 ⁽³⁾ - Stator Line Resistance of the Motor (Rs in Ω)

Range:	0.000 to 32.767	Factory Setting:	1.200
---------------	-----------------	-------------------------	-------

P00414 ⁽³⁾ - Line Inductance of the Motor Shaft (Lq in mH)

Range:	0.00 to 327.67	Factory Setting:	7.09
---------------	----------------	-------------------------	------

P00415 ⁽³⁾ - Line Inductance of the Motor Shaft (Ld in mH)

Range:	0.00 to 327.67	Factory Setting:	5.98
---------------	----------------	-------------------------	------

P00416 ⁽³⁾ - Voltage Constant Generated by the Motor (ke in Vrms/Krpm)

Range:	0.00 to 3276.7	Factory Setting:	51.2
---------------	----------------	-------------------------	------

P00417 ⁽²⁾ - Torque Constant (kt in Nm/A)

Range:	0.000 to 32.767	Factory Setting:	0.718
---------------	-----------------	-------------------------	-------

P00418 ⁽³⁾ - Inertia of Servomotor Shaft (J in g.m²)

Range:	0.000 to 32.767	Factory Setting:	0.497
---------------	-----------------	-------------------------	-------

Properties:	RW - Reading and Writing
--------------------	--------------------------

Description

Parameters relating to electrical and mechanical characteristics of the motor.

P00421- Inertia of the Coupled Load (J in g.m²)

Range:	0.00 to 327.67	Factory Setting:	0.0
---------------	----------------	-------------------------	-----

Properties:	RW - Reading and Writing
--------------------	--------------------------

Description

Estimated inertia of the system reflected on the motor shaft. This value is estimated during the self-tuning and serves only as a reference. It must not be used as project information; for this purpose, use the inertia calculated on the mechanical project. This parameter is used in the feedforward iq (see P00170).

P00422- Reserved Parameter

P00423- Reserved Parameter

P00424- Reserved Parameter

P00426- Reserved Parameter

P00427- Reserved Parameter

P00428- Reserved Parameter

Range:	Reserved	Factory Setting:	Reserved
---------------	----------	-------------------------	----------

Properties:	
--------------------	--

Description

Reserved parameter.

⁽³⁾ Parameters referenced receive the values corresponding to the motor set on parameter P00385. When P00385 = 0, these parameters remained unchanged.

12 SPECIAL FUNCTIONS

The following parameters are related to special functions, such as fast counters (standard and encoder inputs), user's reference position, STOP function, etc. Through the following parameters, you can configure the selected special function to operate as desired.

12.1 ABSOLUTE POSITION

It is possible to define the values for the user's absolute reference position using the parameters listed below. In parameters P00492 and P00493, you define the value for the fraction of revolution and the number of revolutions that compose the absolute position. Parameter P00490 is responsible for loading these preset values on parameters P00052 and P00053 respectively.

P00490 - Load Absolute Position

Range:	0 and 1	Factory Setting:	0
Properties:	RW - Reading and Writing		

Description

On the rising edge of this parameter, the parameters regarding the absolute position P00052 and P00053 receive the values programmed on P00492 and P00493 respectively.

P00492 - Fraction of Revolution Defined by the User

Range:	-16383 to 16383	Factory Setting:	0
Properties:	RW - Reading and Writing		

Description

It defines the value for the reference fraction of revolution defined by the user according to Table 12.1. In order to load the defined value, see P00490.

P00493 - Number of Revolutions Defined by the User

Range:	-32768 to 32767	Factory Setting:	0
Properties:	RW - Reading and Writing		

Description

It defines the value for the reference fraction of revolution defined by the user according to [Table 12.1 on page 12-1](#). In order to load the defined value, see P00490.

Table 12.1: Illustrative values for the user's position - revolutions and fraction of revolution

Angle	-720°	-540°	-360°	-180°	-90°	0°	90°	180°	360°	540°	720°
P00052	-2	-1	-1	0	0	0	0	0	1	1	2
P00053	0	-8192	0	-8192	-4096	0	4096	8192	0	8192	0

Note: Parameters P00492 and P00493 must have the same signal (if they are different from zero). If there is a signal incompatibility when trying to load these parameters for the user's reference, alarm A00101 will occur and the values will not be loaded. This alarm can also be caused by signal incompatibility on parameters P00127, P00128, P00129 and P00130.

12.2 STANDARD FAST COUNTER

The servo drive SCA06 provides three digital inputs in its standard version, and two of them (input DI1 and DI2) can be used as fast counters, according to the programming of P00300 and P00301. Parameters P00056 and P00057 show the counter value. DI3 (P00302) can be programmed to store the counter value at the positive or negative transition of the DI. The stored value is shown on parameters P01014 and P01015.

These three digital inputs feature special hardware to capture transitions quickly. The rising and falling time of the standard DIs can be observed in [Figure 3.3 on page 3-3](#).

P00500 - Count Mode - Standard Fast Counter

Range:	0 to 4	Factory Setting:	0
Properties:	RW - Reading and Writing		

Description

This parameter defines which count type will be used, according to [Table 12.2 on page 12-2](#).

Table 12.2: Count mode

P00500	Count Mode	Description
0	Disabled	-
1	Quadrature	Counts pulses A and B in quadrature (see Table 12.1 on page 12-1)
2	Pulse and direction	Channel A receives the pulses and B the direction (see Figure 12.2 on page 12-3)
3	Pulse A+ / Pulse B-	When it receives pulses in A, it increments the counter. When it receives pulses in B, it decrements the counter (see Figure 12.3 on page 12-3)
4	Pulse A+	Counts just pulses A (see Figure 12.4 on page 12-3)

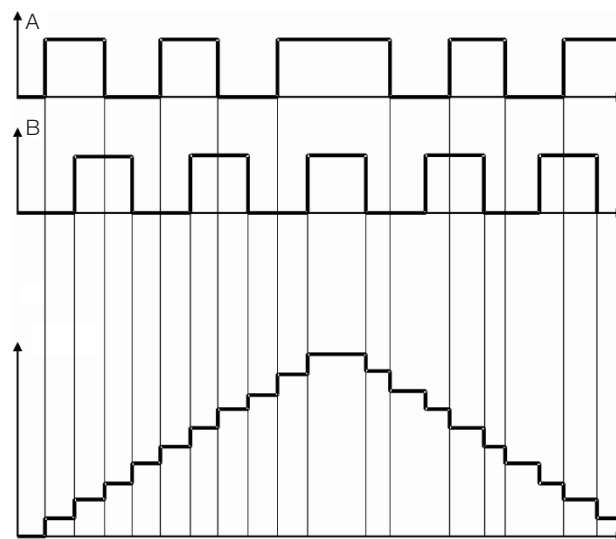

Figure 12.1: Count in quadrature mode. Pulse A and Pulse B (upper wave forms) and counter Output (lower wave form)

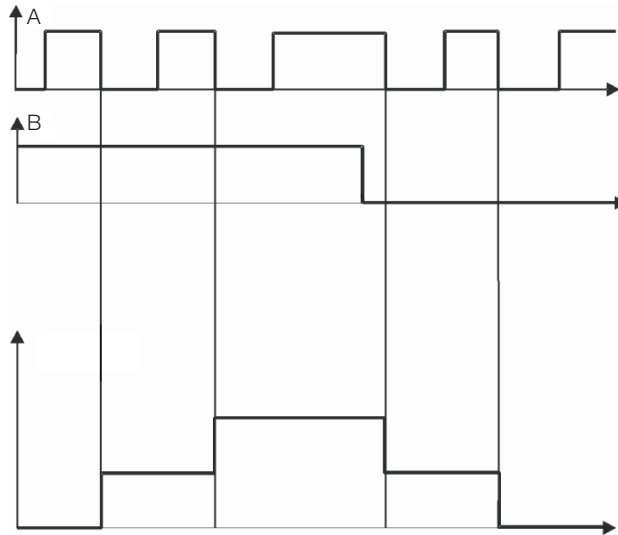

Figure 12.2: Count mode - Pulse and direction. Pulse A and Pulse B (upper wave forms) and counter Output (lower wave form)

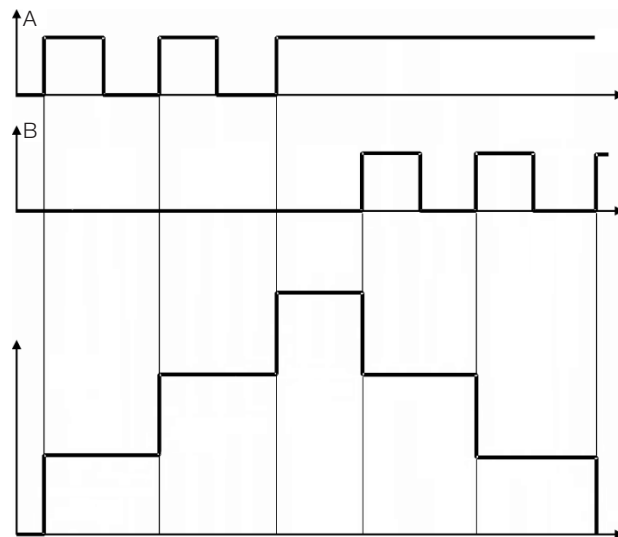

Figure 12.3: Count mode - Pulse A increments, Pulse B decrements. Pulse A and Pulse B (upper wave forms) and counter Output (lower wave form)

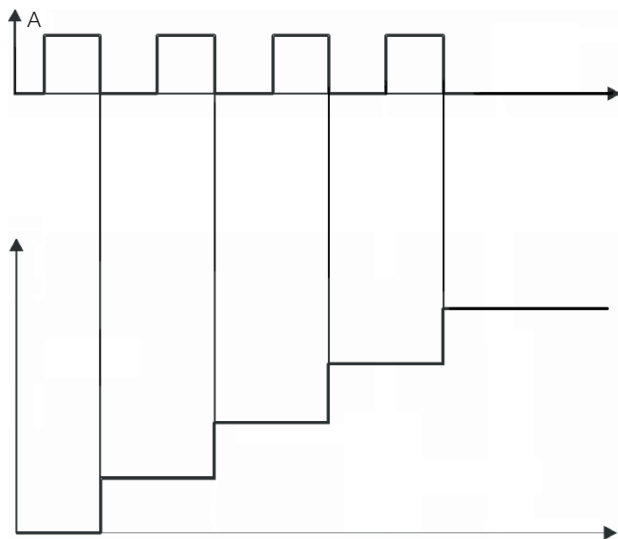

Figure 12.4: Count mode - Pulse A increments. Pulse A (upper wave forms) and counter Output (lower wave form)

P00502 - Load value on the Standard Fast Counter

Range:	0 and 1	Factory Setting:	0
Properties:	RW - Reading and Writing		

Description

On the rising edge of this parameter, the counter will receive the values programmed on parameters P00503 and P00504. See parameters P00056 and P00057.



ATTENTION!

When the counter is being used by the MC_GearIn or MC_GearInPos block, the counter value must not be updated, under the risk of sudden displacement of the motor.

P00503 - Value of the Standard Fast Counter - Low Significant Bits

Range:	0 to 65535	Factory Setting:	0
Properties:	RW - Reading and Writing		

Description

Value corresponding to the 16 least significant bits to be sent to the counter on the rising edge of parameter P00502. See parameter P00056 and P00057.

P00504 - Valued of the Standard Fast Counter - High Significant Bits

Range:	0 to 65535	Factory Setting:	0
Properties:	RW - Reading and Writing		

Description

Value corresponding to the 16 most significant bits to be sent to counter on the rising edge of parameter P00502. See parameter P00056 and P00057.

12

P00506 - Number of Pulses/Revolution of the Standard Fast Counter

Range:	1 to 65535	Factory Setting:	1024
Properties:	RW - Reading and Writing		

Description

Value corresponding to the number of pulse per revolution of the standard counter.

P00507 - Counter Speed Filter (Fc in Hz)

Range:	1 to 4000	Factory Setting:	500
Properties:	RW - Reading and Writing		

Description

Cut-off frequency for the low-pass filter of the speed estimator of the fast counter. When the MC_GearIn and MC_GearInPos ladder blocks are used with the master programmed for the fast input (fast counter), the estimate speed used by these blocks is filtered by this filter. The higher this frequency, the lower the lag error (following) and the higher the noise sound.

P00508 - Speed Calculation Period of the Standard Counter (in ms)

Range:	0.1 to 100.0	Factory Setting:	1.0
Properties:	RW - Reading and Writing		

Description

Period during which the position differential is done to calculate the counter speed.

P00510 - Count Mode - Fast Counter 1

Range:	0 to 3	Factory Setting:	0
Properties:	RW - Reading and Writing AC - Accessory		

Description

This parameter defines which count type will be used by the fast counter 1, according to [Table 12.3 on page 12-5](#).

Table 12.3: Count mode

P00510	Count Mode	Description
0	Disabled	-
1	Quadrature	Counts pulses A and B in quadrature (see Figure 12.1 on page 12-2)
2	Pulse and direction	Channel A receives the pulses and B the direction (see Figure 12.2 on page 12-3)
3	Pulse A+ / Pulse B-	When it receives pulses in A, it increments the counter. When it receives pulses in B, it decrements the counter (see Figure 12.3 on page 12-3)

P00511 - Null Pulse Options Z1 - Fast Counter 1

Range:	0 to 5	Factory Setting:	0
Properties:	RW - Reading and Writing AC - Accessory		

Description

This parameter defines what action will be executed when a null pulse occurs on Encoder Input 1, according to [Table 12.4 on page 12-5](#). The stored values will be displayed on parameters P01016 and P01017.

Table 12.4: Null pulse options

P00511	Null Pulse Options
0	Disabled
1	Resets counter
2	Stores counter 1 on the leading edge of Z1
3	Stores counter 1 on falling edge of Z1
4	Stores counter 2 on the leading edge of Z1
5	Stores counter 2 on falling edge of Z1

P00512 - Load Value on Fast Counter 1

Range:	0 and 1	Factory Setting:	0
Properties:	RW - Reading and Writing AC - Accessory		

Description

On the leading edge of this parameter, the fast counter 1 will receive the values programmed on parameters P00513 and P00514. See parameters P00058 and P00059.



ATTENTION!

When the counter is being used by the MC_GearIn or MC_GearInPos block, the counter value must not be updated, under the risk of sudden displacement of the motor.

P00513 - Value of Fast Counter 1 - Low Significant Bits

Range:	0 to 65535	Factory Setting:	0
Properties:	RW - Reading and Writing AC - Accessory		

Description

Value corresponding to the 16 least significant bits to be sent to the fast counter 1 on the rising edge of parameter P00512. See parameter P00058 and P00059.

P00514 - Value of Fast Counter 1 - High Significant Bits

Range:	0 to 65535	Factory Setting:	0
Properties:	RW - Reading and Writing AC - Accessory		

Description

Value corresponding to the 16 most significant bits to be sent to the fast counter 1 on the rising edge of parameter P00512. See parameter P00058 and P00059.

P00516 - Number of Pulses/Revolution of the Fast Counter 1

Range:	0 to 65535	Factory Setting:	1024
Properties:	RW - Reading and Writing AC - Accessory		

Description

Value corresponding to the number of pulses per revolution of the fast counter 1.

P00517 - Speed Filter of Fast Counter 1 (Fc in Hz)

Range:	1 to 4000	Factory Setting:	500
Properties:	RW - Reading and Writing AC - Accessory		

Description

Value corresponding to the speed filter of fast counter 1. See P00507.

P00518 - Speed Calculation Period of Fast Counter 1 (in ms)

Range:	0.1 to 100.0	Factory Setting:	1.0
Properties:	RW - Reading and Writing AC - Accessory		

Description

Period during which the position differential is done to calculate the counter speed.

P00519 - Enable Error Relative to Encoder Input 1

Range:	0 to 2	Factory Setting:	0
Properties:	RW - Reading and Writing AC - Accessory		

Description

It enables the generation of alarm or fault if there is no signal on one of the differential channels of the encoder input 1.

The options to enable the error are described on [Table 12.5 on page 12-7](#).

Table 12.5: Error Options

P00519	Error Options
0	Disabled
1	Generates Alarm
2	Generates Fault



ATTENTION!

The error must only be enabled when there are differential signals on inputs A1, B1 and Z1.

P00520 - Count Mode - Fast Counter 2

Range:	0 to 3	Factory Setting:	0
Properties:	RW - Reading and Writing AC - Accessory		

Description

This parameter defines which count type will be used by the fast counter 2, according to [Table 12.3 on page 12-5](#).

P00521 - Null Pulse Options Z2 - Fast Counter 2

Range:	0 = Disabled 1 = Counter Reset 2 = Load Counter 2 by Z2 Rising Edge 3 = Load Counter 2 by Z2 Falling Edge 4 = Load Counter 1 by Z2 Rising Edge 5 = Load Counter 1 by Z2 Falling Edge	Factory Setting:	0
Properties:	RW - Reading and Writing AC - Accessory		

Description

This parameter defines what action will be executed when a null pulse occurs on encoder input 2. The stored values will be displayed on parameters P01018 and P01019.

P00522 - Load Value on Fast Counter 2

Range:	0 and 1	Factory Setting:	0
Properties:	RW - Reading and Writing AC - Accessory		

Description

On the leading edge of this parameter, the fast counter 2 will receive the values programmed on parameters P00523 and P00524. See parameters P00060 and P00061.



ATTENTION!

When the counter is being used by the MC_GearIn or MC_GearInPos block, the counter value must not be updated, under the risk of sudden displacement of the motor.

P00523 - Value of Fast Counter 2 - Low Significant Bits

Range:	0 to 65535	Factory Setting:	0
Properties:	RW - Reading and Writing AC - Accessory		

Description

Value corresponding to the 16 least significant bits to be sent to the fast counter 2 on the rising edge of parameter P00522. See parameter P00060 and P00061.

P00524 - Value of Fast Counter 2 - High Significant Bits

Range:	0 to 65535	Factory Setting:	0
Properties:	RW - Reading and Writing AC - Accessory		

Description

Value corresponding to the 16 most significant bits to be sent to the fast counter 2 on the rising edge of parameter P00522. See parameter P00060 and P00061.

P00526 - Number of Pulses/Revolution of the Fast Counter 2

Range:	0 to 65535	Factory Setting:	1024
Properties:	RW - Reading and Writing AC - Accessory		

Description

Value corresponding to the number of pulses per revolution of the fast counter 2.

P00527 - Speed Filter of Fast Counter 2 (Fc in Hz)

Range:	1 to 4000	Factory Setting:	500
Properties:	RW - Reading and Writing AC - Accessory		

Description

Value corresponding to the speed filter of fast counter 2. See P00507.

P00528 - Speed Calculation Period of Fast Counter 2 (in ms)

Range:	0.1 to 100.0	Factory Setting:	1.0
Properties:	RW - Reading and Writing AC - Accessory		

Description

Period during which the position differential is done to calculate the counter speed.

P00529 - Enable Error Relative to Encoder Input 2

Range:	0 to 2	Factory Setting:	0
Properties:	RW - Reading and Writing AC - Accessory		

Description

It enables the generation of alarm or fault if there is no signal on one of the differential channels of the encoder input 2.

The options to enable the error are described on [Table 12.5 on page 12-7](#).



ATTENTION!
The error must only be enabled when there are differential signals on inputs A2, B2 and Z2.

12.3 STOP FUNCTION

The digital inputs can be programmed for the STOP function, which aims at performing an emergency stop. This function is available in the torque, speed, Ladder, CANopen and Profibus modes (see P00202). If the servo drive is programmed to operate in Ladder mode, when the STOP function is activated, all the movement blocks are canceled.

The STOP function can be activated by an edge or level, according to the option of parameter P00531. The option of STOP function activated by edge must only be used when the control mode is via Ladder (P00202 = 4).

P00531 - STOP Function: Level or Edge

Range:	0 and 1	Factory Setting:	0
Properties:	RW - Reading and Writing		

Description

It configures the activation mode of the STOP function, according to options of [Table 12.6 on page 12-9](#).

Table 12.6: STOP Function

P00531	STOP function
0	Activation of the STOP function by level
1	Activation of the STOP function by edge (only when P00202 = 4)

The STOP function programmed for edge activation (rising or falling, according to the programmed function on the corresponding DI) works as follows: When an edge occurs on the input programmed for the STOP function, the servomotor will decelerate following the ramp programmed on P00105 until it reaches zero speed and it will cancel all movement blocks.

If the STOP function by level is programmed, when the programmed level is detected, the servomotor will decelerate following the ramp programmed on P00105 until it reaches the zero speed. Even if just a small pulse occurs, when configured level is detected, the servomotor will follow the ramp until it reaches the zero speed.

When operating in Ladder mode, all the movement blocks will be canceled and any movement can only be activated again if the corresponding digital input is not at the programmed level to activate the STOP.

When executing the control by the drive (P00202 = 1 or P00202 = 2), while the digital input is at the programmed level, the shaft will remain still. At the moment in which the function is disabled, the servomotor goes to the reference speed or torque without following any ramp.

During the execution of the STOP function, even if the Lag exceeds the programmed value, the lag error will not occur.

If the STOP function is activated by the communication error (see parameter P00662), in order to release the STOP, you must perform a fault reset or disable the servo drive.

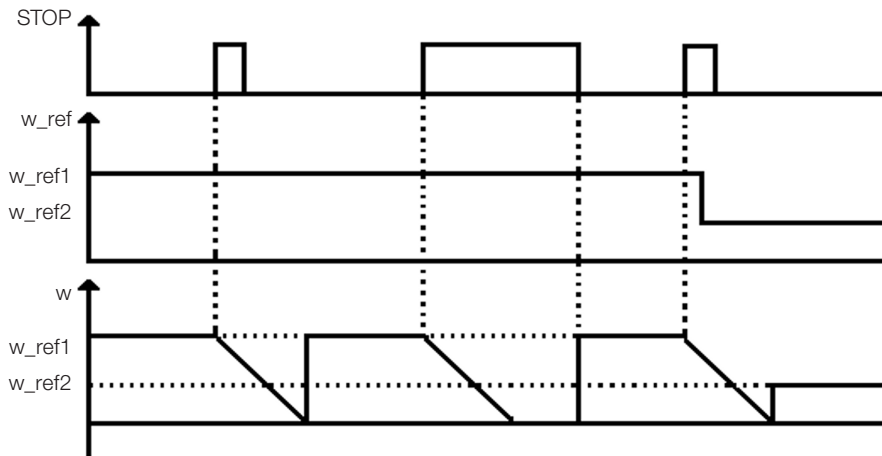

Figure 12.5: Example of STOP function activated by level

12.4 LIMIT SWITCH FUNCTION

The objective of the limit switch function is to limit the execution of the servomotor movement when the configured digital input is activated. This function is available in the speed, Ladder and CANopen modes (See P00202).

The limit switch function is activated by level of the programmed digital input. It is possible to choose if the limit switch function will limit the positioning clockwise or counterclockwise, and also if the level that will activate this function will be high or low on the corresponding digital input.

The limit switch function limits the movement, forcing the speed reference to zero when it tries to move the servomotor towards the active limitation. Since this actuation is related to the speed, there might be a speed offset toward the active limitation due to the settings of speed gains.

12.5 TRACE FUNCTION

12

The trace function is used to register up to 6 (six) variables of interest of the SCA06 (such as current, voltage, speed, etc.) when a certain event occurs in the system. Since it triggers the storage of the variables, this event in the system is called trigger and the user can define up to three trigger conditions and the logic to be used in it (logic AND or OR).

The stored variables can be seen as graphs by using the SuperDrive G2 software running on a PC connected via USB or serial to the SCA06.

Below are the parameters related to the trace function.

P00550 - Trigger Fource 1

P00553 - Trigger Fource 2

Range:	0 to 48	Factory Setting:	0
Properties:	RW - Reading and Writing		

Description

It selects which variable will be used as trigger source for the Trace function. [Table 12.7 on page 12-11](#) presents the options for trigger source.

Table 12.7: Trigger Source

P00550/P00553	Trigger Source
0	Disabled
1	Analog Input 1
2	Analog Input 2
3 - 5	Reserved
6	Speed
7	Number of Revolutions
8	Fraction of Revolutions
9	Electrical Position
10	Iq
11	Id
12	Vq
13	Vd
14	Reserved
15	Iv
16	Iw
17	Vu
18	Vv
19	Vw
20	Vlink
21	Reserved
22	Iq reference
23	Id Reference
24	Speed Reference
25 - 26	Reserved
27	Jerke reference - Real shaft
28	Acceleration reference - Real shaft
29	Speed reference - Real shaft
30	Position reference (number of revolutions) - Real shaft
31	Position reference (fraction of revolution) - Real shaft
32	Lag Error
33	Reserved
34	Jerke reference - Virtual shaft
35	Acceleration reference - Virtual shaft
36	Speed reference - Virtual shaft
37	Position reference (number of revolutions) - Virtual shaft
38	Position reference (fraction of revolution) - Virtual shaft
39	Standard counter
40	Counter 1
41	Counter 2
42	Standard counter speed
43	Counter 1 Speed
44	Counter 2 Speed
45	Reserved
46	Status Word
47 - 48	Reserved

P00551 - Trigger Value 1
P00554 - Trigger Value 2
Range: -32768 to 32767

Factory Setting: 0

Properties: RW - Reading and Writing

Description

It defines the comparison value for the variable selected on P00550/P00553.

Note: The parameters relating to the trigger do not have decimal places; however, when the trigger source chosen is current or current reference (options 10, 11, 15, 16, 22, 23, 28 and 35), the user must enter the value considering the decimal place. For example: Select the current Iq as trigger source and the comparison value chosen is 1.5 A. Therefore: P00550 = 10 (Iq) and P00551 = 15 (1.5 A).

P00552 - Trigger Condition 1

P00555 - Trigger Condition 2

Range: 0 and 1 **Factory Setting:** 0

Properties: RW - Reading and Writing

Description

It selects which condition will start the signal collection, according to [Table 12.8 on page 12-12](#).

Table 12.8: Trigger Condition

P00552/P00555	Trigger Condition
0	Greater or equal to the reference value
1	Smaller or equal to the reference value

P00556 - Trigger Source 3

Range: 0 to 1049 **Factory Setting:** 0

Properties: RW - Reading and Writing

Description

It selects one of the SCA06 parameters to be used as trigger source 3.

P00557 - Trigger Value 3

Range: -32768 to 32767 **Factory Setting:** 0

Properties: RW - Reading and Writing

Description

It defines the comparison value for the parameter selected on P00556.

Note: The parameter relating to the value of trigger 3 does not have decimal places; however, when the parameter chosen to be source of trigger 3 contains decimal places, the user must enter the value considering the decimal place. For example: Select parameter P01001 (Scan Time) as trigger source and the comparison value chosen is 1.0 ms. Therefore: P00556 = 1001 and P00557 = 10 (1.0 ms).

P00558 - Trigger Condition 3

Range: 0 and 1 **Factory Setting:** 0

Properties: RW - Reading and Writing

Description

It selects which condition will start the signal collection, according to [Table 12.8 on page 12-12](#).

P00559 - Pre - Trigger

Range: 0 to 100 **Factory Setting:** 0

Properties: RW - Reading and Writing

Description

It defines the percentage of data that will be recorded before the occurrence of the trigger.

For example, if 75 % (P00559 = 75) is configured, the signal displayed will be 75 % of the signal stored before the trigger, and the other 25 % after the trigger.

P00560 - Logic Between the Triggers

Range:	0 and 1	Factory Setting:	0
Properties:	RW - Reading and Writing		

Description

It selects which logic will be used so that the trigger can occur. The available options for the trigger logic are described in [Table 12.9 on page 12-13](#).

Table 12.9: Logic between the triggers

P00560	Logic Between the Triggers
0	OR Logic
1	AND Logic

Example: Assuming that the programmed parameters for the trigger are the ones described below:

Trigger Parameters 1	Trigger Parameters 2	Trigger Parameters 3
P00550 = 6 (Speed)	P00553 = 10 (Iq)	P00556 = 0004 (P00004 Vlink)
P00551 = 1000	P00554 = 15	P00557 = 300
P00552 = 0	P00555 = 0	P00558 = 0

If the logic OR is selected, any of the conditions that occurs will trip the trigger, that is, if the speed goes above 1000 rpm, or if the Iq current goes above 1.5 A or if parameter P00004 (Link voltage) goes above 300 V, the trigger will occur.

If the logic AND is selected, it will be necessary that all the selected trigger conditions be satisfied for the trigger event to be tripped. That is, in at the same it will be necessary that the speed be above 1000 rpm and that the current Iq be above 1.5 A and that the parameter P00004 (link voltage) be above 300 V so that the trigger can occur.

P00561 - CH1: Channel 1 of the Trace

P00562 - CH2: Channel 2 of the Trace

P00563 - CH3: Channel 3 of the Trace

P00564 - CH4: Channel 4 of the Trace

P00565 - CH5: Channel 5 of the Trace

Range:	0 to 50	Factory Setting:	0
Properties:	RW - Reading and Writing		

Description

It selects which signals will be recorded on channels 1 to 5 of the trace function. The options for the trace channels can be seen in [Table 12.10 on page 12-14](#).

Table 12.10: Options of the trace channels

P00561 to P00565	Options
0	Disable
1	Analog Input 1
2	Analog Input 2
3 - 5	Reserved
6	Speed
7	Filtered Speed
8	Mec. Position
9	Elect. Position
10	Iq
11	Id
12	Vq
13	Vd
14	Reserved
15	Iv
16	Iw
17	Vu
18	Vv
19	Vw
20	V link DC
21	Reserved
22	Iq Reference
23	Id Reference
24	Speed Reference
25	Iq Feedforward
26	Reserved
27	Jerke Reference (real shaft)
28	Accel. Reference (real shaft)
29	Speed Reference (real shaft)
30	Position Reference (real shaft)
31	Reserved
32	Lag Error
33	Reserved
34	Jerke Reference (virtual shaft)
35	Accel. Reference (virtual shaft)
36	Speed Reference (virtual shaft)
37	Position Reference (virtual shaft)
38	Reserved
39	Value of the standard counter
40	Value of the counter 1
41	Value of the counter 2
42	Speed of the standard counter
43	Speed of the counter 1
44	Speed of the counter 2
45	Resolver Speed
46	Status Word
47 - 50	Reserved

P00566 - CH6: Channel 6 of the Trace

Range:	0 to 1249	Factory Setting:	0
Properties:	RW - Reading and Writing		

Description

It selects which parameter will be recorded on channel 6 of the trace function. On channel 6, it is only possible to view parameters.

P00568 - Force Trigger

Range:	0 and 1	Factory Setting:	0
Properties:	RW - Reading and Writing		

Description

At the positive transition of this parameter the trigger event occurs, regardless any other condition selected on parameters P00550 to P00560.

P00569 - Sampling Period

Range:	1 to 1000	Factory Setting:	1
Properties:	RW - Reading and Writing		

Description

It defines the sampling period of the trace function as a multiple of 100 μ s.

For example: If you set P00569 = 3, the sampling period of the trace function will be of 300 μ s.

P00571 - Start Trace

Range:	0 and 1	Factory Setting:	0
Properties:	RW - Reading and Writing		

Description

At the positive transition of this parameter, the waiting for the trigger of the trace function starts.

When P00571 = 0, the trace function returns to the OFF status, enabling the user to start a new collection.

P00576 - Trace Function Status

Range:	0 to 3	Factory Setting:	0
Properties:	RO - Reading Only		

Description

It indicates the current status of trace function according to [Table 12.11 on page 12-15](#).

Table 12.11: Trace Function Status

P00561 to P00565	Options
0	Disabled
1	Waiting
2	Trigger occurred
3	Concluded

P00577 - Indication of the total Trace Time

Range:	0.000 to 32.767	Factory Setting:	0
Properties:	RO - Reading Only		

Description

It indicates the total time to stores all the active channels of the trace function.

Example of Trace Function - In order to view the behavior of the Speed, Mechanical Position and Iq signals, at the moment in which the motor speed reaches a minimum value of 1000 rpm, considering a sampling period of 200 µs and with a pre-trigger of 40 %, the following configuration is done to use Trace function:

- P00550 = 6 (Trigger source = speed).
- P00551 = 1000 (Comparison value of the trigger = 1000 rpm).
- P00552 = 0 (Trigger condition = greater than or equal to the comparison value).
- P00559 = 40 (Pre-trigger = 40 %).
- P00561 = 6 (Tracer Channel 1 = Speed).
- P00562 = 8 (Trace Channel 2 = Mechanical Position).
- P00563 = 10 (Trace Channel 3 = Iq).
- P00569 = 2 (Sampling period = 200 µs).
- P00571 = 1 (Starts Trace).

On the rising edge of parameter P00571, the configured signals will start to be stored, waiting for the occurrence of the programmed event for the trigger (in this case Speed >= 1000 rpm). After the event occurs, the signals are available to the user, seeing that part of the available signal was stored before the event and the other part after the event, as programmed on P00559. In this example, 40 % of the signal shown was stored before the event and the other 60 % after the event of the trigger.

12.6 SELF-TUNING FUNCTION

P00580 - Activate Self-tuning

Range:	0 and 1	Factory Setting:	0
Properties:	RW - Reading and Writing		

Description

At the transition of 0 to 1, it activates the self-tuning routine (the drive must be enabled), which adjusts the kp and ki gains of the speed loop (P00161 and P00162) and estimates the system inertia reflected on the motor shaft (P00421). Before activating the self-tuning, the servomotor model must be set on P00385.

For the correct adjustment of the gains and inertia estimation, the servomotor must be coupled to the load.

During the execution of self-tuning, the HMI will display the message “AutoOX”, where X is the number of phase of the self-tuning and it goes from 0 to 8.

At the end of self-tuning, the message “End” is shown on the display signaling the end of self-tuning routine. If this message is not shown, the self-tuning has not finished and the gains were not properly saved or adjusted.

The “STOP”, “Limit Switch” and “Disabling” functions abort the self-tuning.

It is recommended to disable the user’s program (P01020 = 0) before executing the self-tuning so as to avoid the occurrence of the application watchdog fault (F00829).



ATTENTION!

When the self-tuning is activated, the servomotor will spin with high torque at varying speeds, including moments of high speed in the direction programmed on P00582. At some moments, strong vibration of the shaft may occur.

P00582 - Direction of Rotation of the Self-tuning

Range:	0 to 2	Factory Setting:	1
Properties:	RW - Reading and Writing		

Description

It determines in what direction the self-tuning will spin during its execution, according to [Table 12.12 on page 12-17](#).

Table 12.12: Direction of rotation of the Self-tuning

P00582	Options
0	No rotation
1	Clockwise (looking at the shaft from the drive end of the servomotor)
2	Counterclockwise (looking at shaft from the drive end of the servomotor)

13 SERIAL COMMUNICATION PARAMETERS

In order to enable the serial communication of the servo drive with other devices, it is necessary to configure some basic parameters, such as: servo drive address, serial baud rate, selection of the protocol to be used, etc.

For the serial parameters to be accessible to the user, it is necessary that accessory ECO1 be connected to slot 1 or slot 2.



NOTE!

For a full description of the operation of the servo drive SCA06 serial communication, refer to the serial communication manual.

P00650 - Servo drive Address on the Serial Communication 1 - RS-232

P00656 - Servo drive Address on the Serial Communication 2 - RS-485

Range:	1 to 247	Factory Setting: 1
Properties:	RW - Reading and Writing AC - Accessory	

Description

It sets the servo drive address for serial communication.

NOTE: WegTP Protocol → Address range from 1 to 30.
ModBus Protocol → Address range from 1 to 247.

P00652 - Serial Bit Rate 1 - RS-232

P00658 - Serial Bit Rate 2 - RS-485

Range:	0 to 11	Factory Setting: 1
Properties:	RW - Reading and Writing AC - Accessory	

Description

It selects the bit rate of the serial communication according to the [Table 13.1 on page 13-1](#).

Table 13.1: Selection of the Bit Rate for serial communication

P00652 / P00658	Bit Rate
0	4800 bits/s
1	9600 bits/s
2	14400 bits/s
3	19200 bits/s
4	24000 bits/s
5	28800 bits/s
6	33600 bits/s
7	38400 bits/s
8	43200 bits/s
9	48000 bits/s
10	52800 bits/s
11	57600 bits/s

P00653 - Serial Configuration 1 - RS-232

P00659 - Serial Configuration 2 - RS-485

Range:	0 to 11	Factory Setting: 3
Properties:	RW - Reading and Writing AC - Accessory	

Description

It selects one of the options to configure the serial according to the number of data bits, stop bit and parity.

Table 13.2: Serial Configuration

P00653 / P00659	Data Bits	Parity	Stop Bit
0	8	No parity	1
1	8	Even parity	1
2	8	Odd parity	1
3	8	No parity	2
4	8	Even parity	2
5	8	Odd parity	2
6	7	No parity	1
7	7	Even parity	1
8	7	Odd parity	1
9	7	No parity	2
10	7	Even parity	2
11	7	Odd parity	2

P00654 - Select Serial Protocol 1 - RS-232

P00660 - Select Serial Protocol 2 - RS-485

Range:	0 to 2	Factory Setting: 2
Properties:	RW - Reading and Writing AC - Accessory	

Description

It selects the protocol to be used for serial communication.

Table 13.3: Serial Protocol

P00654 / P00660	Serial Protocol
0	WEGBus
1	WegTP
2	ModBus

P00662 - Action for Communication Error

Range:	0 to 3	Factory Setting: 0
Properties:	RW - Reading and Writing	

Description

It allows selecting which action the servo drive must take in case of error during communication.

13

Table 13.4: Action for communication error

P00662	Description	Note
0	Just indicate alarm	It only shows the alarm code on the servo drive HMI
1	Cause fault	It causes a fault and the servo drive will only return operating if the fault is reset
2	Cause alarm and stop	It shows the alarm code on the servo drive HMI and activates the STOP function: The servo drive will decelerate until stopping and lock the motor keeping the speed reference at zero. The servo drive will only exit the STOP status after the fault is reset or the servo drive is disabled
3	Cause alarm and disable	It shows the alarm code on the servo drive HMI and disables it

Note: Communication errors can be different according to the protocol used. Refer to the specific communication manual for the product used.

P00663 - Timeout for Communication

Range:	0.0 to 999.0	Factory Setting:	0.0
Properties:	RW - Reading and Writing AC - Accessory		

Description

It allows setting a period of time (in seconds) to detect communication error via serial interface. In case the inverter does not receive valid telegrams for a period longer than that set in this parameter, it will be assumed a communication error occurred, the alarm A00128 will be displayed on the HMI (or fault F00028, depending on the setting on P00662) and the action programmed on P00662 will be executed.

After energized, the servo drive will start counting this time from the first valid telegram received. The value 0.0 disables this function.

P00664 - Saves Parameters in Non-Volatile Memory

Range:	0 and 1	Factory Setting:	1
Properties:	RW - Reading and Writing		

Description

It allows selecting if the writing of parameters via serial must save the content of the parameters in non-volatile memory (EEPROM).

When the ModBus protocol is used, only this parameter determines whether the parameters written via serial will be saved or not on the non-volatile memory. However, when the WegTP protocol is used, note that the information about whether saving the parameter on the EEPROM or not is located on the code byte of the telegram. In order to save them on non-volatile memory via WegTP, it is necessary that the two pieces of information, the code byte of the telegram and parameter P00664, be true.

Note: This kind of memory has a limit number of writings (100,000 times). Depending on the application, this limit may be exceeded in case some parameters are written cyclically via serial (speed reference, torque, etc.). In those cases, it may be desired, during the operation of the servo drive, that the writing via serial save the content of the parameters on non-volatile memory so as not to exceed the limit of writings on the servo drive.

This parameter is not applicable when the writing is done using the USB interface.

Table 13.5: Select save parameter on non-volatile memory

P00664	Function
0	Does not save parameters on non-volatile memory
1	Saves parameters on non-volatile memory

P00667 - Remapping of the Serial Access to the Parameters

Range:	0 and 1	Factory Setting:	0
Properties:	RW - Reading and Writing		

Description

Property verified when some parameter is written and read via serial. It selects whether the readings or writings via serial on parameters will be done on the corresponding parameters or remapped on volatile Word markers.

Table 13.6: Remapping of parameters

P00667	Function
0	Reads and writes normally the content of the corresponding parameter
1	Reads and writes the content on volatile Word markers from the MW13000

Example: Being this parameter P00667 = 1, when writing via serial on parameter P00105 = 30, this value will be stored on the Word marker 13105 ($MW_{initial} + Parameter_number \Rightarrow 13000 + 105$). Therefore, MW13105 = 30.

The same way, if P00667 = 1, when attempting to read parameter P00200, the content read will correspond to the value stored on Word marker 13200.

Note: Once P00667 = 1, it cannot be changed via serial. Because in the attempt to write on parameter P00667, you will be writing on Word marker P13667.

14 CAN NETWORK PARAMETERS

The CANopen communication protocol is an open protocol which enables a fast and reliable communication among the devices present on the network.



NOTE!

For a full description of the operation of the SCA06 servo drive on CANopen network, refer to the CANopen communication manual.



NOTE!

For a full description of the operation of the SCA06 servo drive on DeviceNet network, refer to the DeviceNet communication manual.

P00700 - CAN Protocol

Range:	0 = Disabled 1 = CANopen 2 = DeviceNet 3 = CANespecial 1	Factory Setting: 2
Properties:	RW - Reading and Writing	

Description

It allows selecting the desired protocol for the CAN interface. If this parameter is changed, the change will only take effect if the CAN interface has no power supply or after the equipment is turned off and then turned back on.

Table 14.1: CAN Protocol

P00700	Description	Note
0	Disabled	Protocols disabled
1	CANopen	The servo drive starts operating as slave of the CANopen network
2	Reserved	-
3	CAN especial1	The servo drive starts operating as slave of the CAN network with a non-standard protocol

P00701 - CAN Address

Range:	0 to 127	Factory Setting: 63
Properties:	RW - Reading and Writing	

Description

It allows selecting the servo drive address on the CAN network.

P00702 - Baud Rate

Range:	0 to 6	Factory Setting: 0
Properties:	RW - Reading and Writing	

Description

It defines the baud rate used by the CAN interface.

Table 14.2: Baud Rate

P00702	Baud rate
0	1 Mbit/s
1	800 Kbits/s
2	500 Kbits/s
3	250 Kbits/s
4	125 Kbits/s
5	100 Kbits/s
6	50 Kbits/s

P00703 - Bus off Reset

Range:	0 and 1	Factory Setting:	0
Properties:	RW - Reading and Writing		

Description

It defines what action will be taken by the servo drive in case of bus off fault on the CAN interface.

Table 14.3: Bus off rest

P00703	Description	Note
0	Manual	In case of fault, the servo drive will only leave this condition if the device is reset
1	Automatic	The servo drive must restart the communication automatically, without requiring a reset

P00704 - Follow

Range:	0 to 3	Factory Setting:	0
Properties:	RW - Reading and Writing		

Description

It enables the Follow function. It defines whether the SCA06 will be follow master or slave.

Table 14.4: Follow options

P00704	Follow	Note
0	Disabled	-
1	Real follow master	Sends follow telegrams containing position and speed of the real shaft
2	Virtual follow master	Sends follow telegrams containing position and speed of the virtual shaft
3	Follow slave	Receives the follow telegrams following the master position and speed

P00705 - Follow COB ID

Range:	385 to 511	Factory Setting:	385
Properties:	RW - Reading and Writing		

Description

It defined the COB ID (Communication Object Identifier) of the follow PDO.

P00706 - Follow Period

Range:	0.2 to 5.0	Factory Setting:	0.2
Properties:	RW - Reading and Writing		

Description

It defines the follow period.

P00710 – I/O DeviceNet Instances

Range:	0 = ODVA Basic Speed (2 words)	Factory Setting: 0
	1 = ODVA Extended Speed (2 words)	
	2 = ODVA Extended Speed/Torque (3 words)	
	3 = FactorySpec 2W (2 words)	
	4 = FactorySpec 3W (3 words)	
	5 = FactorySpec 4W (4 words)	
	6 = FactorySpec 5W (5 words)	
	7 = FactorySpec 6W (6 words)	
	8 = FactorySpec 7W (7 words)	
	9 = FactorySpec 8W (8 words)	
	10 = FactorySpec Fab 9W (9 words)	
	11 = FactorySpec 10W (10 words)	
	12 = FactorySpec 11W (11 words)	
	13 = FactorySpec 12W (12 words)	
	14 = FactorySpec 13W (13 words)	
	15 = FactorySpec 14W (14 words)	
Properties:	RW - Reading and Writing	

Description

It allows selecting the Assembly class instance used for the exchange of I/O data with the network master.

The servo drive SCA06 has fifteen options of settings. Three of them follow the standard defined on the AC/DC Drive Profile of the ODVA. The others represent specific words of the servo drive SCA06. The tables below detail each of these control and monitoring words.

NOTE! In case this parameter is changed, it will only be valid after the device is turned off and then turned back on.

0 = Data format for the ODVA Basic Speed instances (2 words):

Called Basic Speed, these instances represent the simplest operation interface of a device according to the AC/DC Device Profile. The data mapping is shown below.

Table 14.5: Monitoring (Input)

Instance	Byte	Bit 7	Bit 6	Bit 5	Bit 4	Bit 3	Bit 2	Bit 1	Bit 0
70	0						Running1		Faulted
	1	-							
	2	Speed actual (low byte)							
	3	Speed actual (high byte)							

Table 14.6: Control (Output)

Instance	Byte	Bit 7	Bit 6	Bit 5	Bit 4	Bit 3	Bit 2	Bit 1	Bit 0
20	0						Fault Reset		Run Fwd
	1	-							
	2	Speed reference (low byte)							
	3	Speed reference (high byte)							

1 = Data format for the ODVA Extended Speed instances (2 words):

Called Extended Speed, these instances represent a more improved operation interface of the equipment that follows the AC/DC Device Profile. The data mapping is shown below.

Table 14.7: Monitoring (Input)

Instance	Byte	Bit 7	Bit 6	Bit 5	Bit 4	Bit 3	Bit 2	Bit 1	Bit 0
71	0	At Reference	Ref. from Net	Ctrl from Net	Ready	Running2 (Rev)	Running1 (Fwd)	Warning	Faulted
	1	Drive status							
	2	Speed actual (low byte)							
	3	Speed actual (high byte)							

Table 14.8: Control (Output)

Instance	Byte	Bit 7	Bit 6	Bit 5	Bit 4	Bit 3	Bit 2	Bit 1	Bit 0
21	0		NetRef	NetCtrl			Fault Reset	Run Rev	Run Fwd
	1	-							
	2	Speed reference (low byte)							
	3	Speed reference (high byte)							

2 = Data format for the ODVA Extended Torque instances (3 words):

Called Extended Torque, these instances represent an interface very similar to the Extended Speed, the only difference being the possibility to send the torque limit. The data mapping is shown below.

Table 14.9: Monitoring (Input)

Instance	Byte	Bit 7	Bit 6	Bit 5	Bit 4	Bit 3	Bit 2	Bit 1	Bit 0
71	0	At Reference	Ref. from Net	Ctrl from Net	Ready	Running2 (Rev)	Running1 (Fwd)	Warning	Faulted
	1	Drive status							
	2	Speed actual (low byte)							
	3	Speed actual (high byte)							
	4	Torque actual (low byte)							
	5	Torque actual (high byte)							

Table 14.10: Control (Output)

Instance	Byte	Bit 7	Bit 6	Bit 5	Bit 4	Bit 3	Bit 2	Bit 1	Bit 0
21	0		NetRef	NetCtrl			Fault Reset	Run Rev	Run Fwd
	1	-							
	2	Speed reference (low byte)							
	3	Speed reference (high byte)							
	4	Torque limit (low byte)							
	5	Torque limit (high byte)							

The [Table 14.11](#) on page 14-5 presents the meaning of the data for the instances 20/70, 21/71 and 23/73.

Table 14.11: Description of the monitoring bits - ODVA

Bits (byte 0)	Values
Bit 0 Faulted	0: Inverter is not in fault state 1: Some fault registered by the inverter Note: The number of the fault can be read through parameter P00035 - Current Fault
Bit 1 Warning	0: Inverter is not in an alarm state 1: Some alarm registered by the inverter Note: The number of the alarm can be read by means of parameter P00030 - Current Alarm
Bit 2 Running1 (Fwd)	0: The motor is not running forward 1: The motor is running forward
Bit 3 Running2 (Rev)	0: The motor is not running in the reverse direction 1: The motor is running in the reverse direction
Bit 4 Ready	0: The inverter is not ready to operate 1: The inverter is ready to operate (Ready, Enabled or Stopping status)
Bit 5 Ctrl from Net	0: Drive locally controlled 1: Drive remotely controlled
Bit 6 Ref. from Net	0: Speed reference is not being sent via DeviceNet 1: Indicates speed reference being sent via DeviceNet
Bit 7 At Reference	0: The inverter has not reached the programmed speed yet 1: The inverter has reached the programmed speed

Byte 1 indicates the status of the drive:

- 0 = Non Existing.
- 1 = Startup.
- 2 = Not_Ready.
- 3 = Ready.
- 4 = Enabled.
- 5 = Stopping.
- 6 = Fault_Stop.
- 7 = Faulted.
- Bytes 2 (low) and 3 (high) represent the effective speed of the motor in RPM.
- Bytes 4 (low) and 5 (high) represent the effective value of the motor current, proportional to the torque.

Table 14.12: Description of the control bits - ODVA

Bits (byte 0)	Values
Bit 0 Run Fwd	0: The motor stops 1: The motor runs forward
Bit 1 Run Rev	0: The motor stops 1: The motor runs reverse
Bit 2 Fault Reset	0: Not used 1: If in fault condition, it resets the inverter
Bits 3 and 4	Reserved
Bit 5 NetCtrl	0: Local mode is selected 1: Remote mode is selected
Bit 6 NetRef	0: Speed reference is not being sent via network 1: Speed reference being sent via network
Bit 7	Reserved

- Bytes 2 (low) and 3 (high) represent the speed reference of the motor in RPM.
- Bytes 4 (low) and 5 (high) represent the limit of the effective motor current, proportional to the torque. This value is written in parameters P00131 and P00132, negative and positive current limit respectively.

3 = Data format for the Manufacturer Specific instances 2W (2 words):

4 = Data format for the Manufacturer Specific instances 3W (3 words):

5 = Data format for the Manufacturer Specific instances 4W (4 words):

6 = Data format for the Manufacturer Specific instances 5W (5 words):

7 = Data format for the Manufacturer Specific instances 6W (6 words):

8 = Data format for the Manufacturer Specific instances 7W (7 words):

9 = Data format for the Manufacturer Specific instances 8W (8 words):

10 = Data format for the Manufacturer Specific instances 9W (9 words):

11 = Data format for the Manufacturer Specific instances 10 (10 words):

12 = Data format for the Manufacturer Specific instances 11W (11 words):

13 = Data format for the Manufacturer Specific instances 12W (12 words):

14 = Data format for the Manufacturer Specific instances 13W (13 words):

15 = Data format for the Manufacturer Specific instances 14W (14 words):

Called Manufacturer Specific, those instances represent the simplest operating interface of the equipment according to the SCA06 servo drive profile. The data mapping is shown below. Besides the control and status words, speed reference and effective value, it is possible to program up to 24 parameters of the equipment itself for reading and/or writing via network by means of parameters P00711 to P00734.

Table 14.13: Programming of the I/O words - Monitoring (Input)

Programmable Fixed	Instance	16-bit words	Function	Opção do P00710
	150	#1	Status Word (P00736)	
	#2	Present current/speed (*)		
	#3	Reading DeviceNet #3		
	#4	Reading DeviceNet #4		
	#5	Reading DeviceNet #5		
	⋮	⋮		
	#14	Reading DeviceNet #14		

Table 14.14: Programming of the I/O words - Control (Output)

Programmable Fixed	Instance	16-bit words	Function	Opção do P00710
	100	#1	Control Word (P00735)	
	#2	Current/speed reference (*)		
	#3	Writing DeviceNet #3		
	#4	Writing DeviceNet #4		
	#5	Writing DeviceNet #5		
	⋮	⋮		
	#14	Writing DeviceNet #14		

(*) The content of this word is defined according to the operation mode set in bits 8 to 10 in the control word (P00735):

- Speed mode: the speed reference and the motor speed are informed in RPM.
- Torque mode: the current reference (proportional to the torque) and the motor current are informed according to the scale of P00003.

P00711 - DeviceNet Read Word #3

P00712 - DeviceNet Read Word #4

P00713 - DeviceNet Read Word #5

P00714 - DeviceNet Read Word #6

P00715 - DeviceNet Read Word #7

P00716 - DeviceNet Read Word #8

P00717 - DeviceNet Read Word #9

P00718 - DeviceNet Read Word #10

P00719 - DeviceNet Read Word #11

P00720 - DeviceNet Read Word #12

P00721 - DeviceNet Read Word #13

P00722 - DeviceNet Read Word #14

Range:	0 to 1249	Factory Setting:	0
Properties:	RW - Reading and Writing		

Description

Those parameters allow programming the content of the input words 3 to 14 (input: slave sends to master). By using those parameters, it is possible to program the number of another parameter whose content must become available in the input area of the network master.

For example, if you wish to read from the drive the motor current in amps, value 3 must be set in some of the parameters, because parameter P00003 is the parameter that contains such information. Remember, the value read from any parameter is represented by a 16-bit word. Even if the parameter has decimal resolution, the value is transmitted without the indication of the decimal places. For example, if the parameter P00003 has the value 4.7 A, the value supplied via network will be 47.

These parameters are used only if the drive is programmed in parameter P00710 to use option 3 to 15. According to the selected option, up to 14 words are provided for the network master to read.

NOTE! The value 0 (zero) disables the writing on the word. The number of input words, however, always remains equal to the setting of parameter P00710.

P00723 - DeviceNet Write Word #3

P00724 - DeviceNet Write Word #4

P00725 - DeviceNet Write Word #5

P00726 - DeviceNet Write Word #6

P00727 - DeviceNet Write Word #7

P00728 - DeviceNet Write Word #8

P00729 - DeviceNet Write Word #9

P00730 - DeviceNet Write Word #10

P00731 - DeviceNet Write Word #11

P00732 - DeviceNet Write Word #12

P00733 - DeviceNet Write Word #13

P00734 - DeviceNet Write Word #14

Range:	0 to 1249	Factory Setting:	0
Properties:	RW - Reading and Writing		

Description

Those parameters allow programming the content of the output words 3 to 14 (output: master sends to slave). By using those parameters, it is possible to program the number of another parameter whose content must become available in the output area of the network master.

For example, if you wish to write on the drive the acceleration ramp, value 100 must be set in some of the parameters, because parameter P00100 is the parameter where this information is programmed. Remember that the written value of any parameter is represented with a 16-bit word. Even if the parameter has decimal resolution, the value is transmitted without the indication of the decimal places. For example, if you wish to set parameter P00100 to 5.0s, the value written via network must be 50.

These parameters are used only if the drive is programmed in parameter P00710 to use options 3 to 15. According to the selected option, 14 words are provided for the network master to write.

The first two output words are fixed.



NOTE!

The value 0 (zero) disables the writing on the word. The number of input words, however, always remains equal to the setting of parameter P00710.

P00735 - Control Word

Range:	0 to 65535	Factory Setting:	-
Properties:	RW - Reading and Writing		

Description

Command word of the drive via DeviceNet interface. This parameter can only be changed via CANopen/DeviceNet/Profibus DP interface. For the other sources (HMI, etc.), it behaves as a read-only parameter.

For the commands written on this parameter to be executed, it is necessary that the equipment be programmed to be controlled via DeviceNet. This programming is done via parameter P00202.

Each bit of this word represents a command that can be executed on the product.

Table 14.15: Control bits

Bits	15 to 11	10 to 8	7	6	5 to 3	2	1	0
Function	Reserved	Operation Mode	Fault Reset	Drive Reset	Reserved	Speed Direction	STOP	Enable

Table 14.16: Description of the control bits

Bits	Values
Bit 0 Enable	0: Disables the drive 1: Enables the drive
Bit 1 STOP	0: Does not execute the STOP function 1: Executes the STOP function
Bit 2 Speed Direction	0: Forward 1: Reverse
Bit 3 to 5	Reserved
Bit 6 Drive Reset	0: Not used 1: Resets the drive
Bit 7 Fault Reset	0: Not used 1: If in fault state, resets the fault
Bit 8 to 10 Operation Mode	1: Torque mode 2: Speed mode
Bits 11 to 15	Reserved

P00736 - Status Word

Range:	0 to 15	Factory Setting:	-
Properties:	RO - Read Only		

Description

Allows monitoring the drive status. Each bit represents a state:

Table 14.17: Status bits

Bits	15 to 11	10 to 8	7	6	5 to 3	2	1	0
Function	Reserved	Operation mode	Fault	Reached Ref.	Reserved	Speed direction	STOP	Enabled

Table 14.18: Description of the status bits

Bits	Values
Bit 0 Enable	0: Drive is not enabled 1: Drive is enabled
Bit 1 STOP	0: Not used 1: Executing the STOP function
Bit 2 Speed direction	0: Forward 1: Reverse
Bit 3 to 5	Reserved
Bit 6 Reached Ref.	0: Reference value not reached 1: Reference value reached
Bit 7 Fault	0: No fault on the drive 1: Fault on the drive
Bit 8 to 10 Operation Mode	1: Torque mode 2: speed mode
Bits 11 to 15	Reserved

15 PROFIBUS PROTOCOL PARAMETERS

The Profibus DP protocol defines a series of functions for data communication between the masters and slaves. The group of functions can be divided into different functional levels in the following versions:

- DP-V0: first version of the protocol, which defines mainly the functions to perform the cyclic data exchange between the master and slave.
- DP-V1: extension of the functions defined in the first version, especially, it defines how to perform the acyclic data exchange between the master and slave in addition to the cyclic data.
- DP-V2: it defines a set of advanced functions, such as communication between slaves and isochronous communication mode.

The SCA06 servo drive supports services of the versions DP-V0 and DP-V1 of the protocol.

P00740 - Profibus Communication Status

Range:	0 to 6	Factory Setting:	0
Properties:	RO - Read Only AC - Accessory		

Description

It allows identifying if the Profibus DP interface board is properly installed, besides indicating the status of communication with the network master.

Table 15.1: Values of the Profibus communication status

P00740	Follow	Note
0	Disabled	Profibus interface is not installed on the equipment
1	Initialization error of the Profibus interface	Some problem was identified during the initialization of the Profibus interface
2	Offline	Profibus interface is installed and correctly configured, but there is no cyclic communication with the network master
3	Error on the configuration data	The data received on the I/O configuration telegram are not in accordance with the configurations made for the drive through parameter P0922
4	Error on the parameterization data	The data received on the parameterization telegram do not feature valid format/values for the drive
5	Clear mode	During the data exchange with the master, the drive received a command to go into clear mode
6	Online	I/O data exchange between the drive and the Profibus DP network master being successfully executed

P00741 - Profibus Data Profile

Range:	0 and 1	Factory Setting:	1
Properties:	RW - Reading and Writing AC - Accessory		

Description

It allows selecting the data profile for the control words, speed reference, status and speed of the motor during the data exchange of I/O with the network master.

Table 15.2: Profibus data profile

P00741	Profibus Data Profile
0	PROFIdrive
1	Manufacturer

P00742 - Profibus Read Word #5

P00743 - Profibus Read Word #6

P00744 - Profibus Read Word #7

P00745 - Profibus Read Word #8

P00746 - Profibus Read Word #9

P00747 - Profibus Read Word #10

P00748 - Profibus Read Word #11

P00749 - Profibus Read Word #12

P00750 - Profibus Read Word #13

P00751 - Profibus Read Word #14

P00752 - Profibus Read Word #15

P00753 - Profibus Read Word #16

Range: 0 to 1249

Factory Setting: 0

Properties: RW - Reading and Writing
AC - Accessory

Description

Those parameters allow programming the content of input words 5 to 16 (input: slave sends to master). By using those parameters, it is possible to program the number of another parameter whose content must become available in the input area of the network master.

P00754 - Profibus Write Word #5

P00755 - Profibus Write Word #6

P00756 - Profibus Write Word #7

P00757 - Profibus Write Word #8

P00758 - Profibus Write Word #9

P00759 - Profibus Write Word #10

P00760 - Profibus Write Word #11

P00761 - Profibus Write Word #12

P00762 - Profibus Write Word #13

P00763 - Profibus Write Word #14

P00764 - Profibus Write Word #15

P00765 - Profibus Write Word #16

Range:	0 to 1249	Factory Setting:	0
Properties:	RW - Reading and Writing AC - Accessory		

Description

Those parameters allow programming the content of output words 5 to 16 (output: master sends to slave). By using those parameters, it is possible to program the number of another parameter whose content must become available in the output area of the network master.

P00918 - Profibus Address

Range:	1 to 126	Factory Setting:	1
Properties:	RW - Reading and Writing AC - Accessory		

Description

It allows programming the servo drive address on the Profibus DP network. It is necessary that each network device have an address different from one another.

ATTENTION!

In case this parameter is modified, the slave will only take on the new address when it is not communicating cyclic data with the master.

P00922 - Selection of the Configuration Telegram

Range:	2 to 16	Factory Setting:	2
Properties:	RW - Reading and Writing AC - Accessory		

Description

It allows selecting which configuration telegram will be used by the device during the initialization of the Profibus DP network. This telegram defines the format and quantity of input/output data communicated with the network master.

Table 15.3: Profibus data profile

P00922	Description
2	Standard telegram 1 (2 words of I/O)
3	Telegram 103 (3 words of I/O)
4	Telegram 104 (4 words of I/O)
5	Telegram 105 (5 words of I/O)
6	Telegram 106 (6 words of I/O)
7	Telegram 107 (7 words of I/O)
8	Telegram 108 (8 words of I/O)
9	Telegram 109 (9 words of I/O)
10	Telegram 110 (10 words of I/O)
11	Telegram 111 (11 words of I/O)
12	Telegram 112 (12 words of I/O)
13	Telegram 113 (13 words of I/O)
14	Telegram 114 (14 words of I/O)
15	Telegram 115 (15 words of I/O)
16	Telegram 116 (16 words of I/O)

P00944 - Fault Message Counter

Range:	0 to 65535	Factory Setting:	0
Properties:	RO - Read Only AC - Accessory		

Description

Specific parameter of the Profibus DP communication, defined by the PROFIdrive standard, for indication of number of faults occurred on the drive. In case there are any indications of faults on the device, this counter will be incremented. For the SCA06 servo drive, only one fault is registered at a time and, therefore, this counter has the maximum value of 1. The value 0 (zero) indicates the drive is not in the fault status. The parameter is zeroed with the fault reset.

P00947 - Fault Number

Range:	0 to 65535	Factory Setting:	0
Properties:	RO - Read Only AC - Accessory		

Description

Specific parameter of the Profibus DP communication, defined by the PROFIdrive standard, for indication of the fault occurred on the SCA06 servo drive. If any fault occurs on the device, this parameter will contain the code of the fault. The value 0 (zero) indicates the drive is not in the fault status.

P00963 - Profibus Baud Rate

Range:	0 to 11	Factory Setting:	0
Properties:	RO - Read Only AC - Accessory		

Description

Specific parameter of the Profibus DP communication, defined by the PROFIdrive standard, to indicate the baud rate detected by the Profibus DP interface, as per [Table 15.4 on page 15-4](#).

Table 15.4: Profibus baud rate

P00963	Description
0	9.6 Kbits/s
1	19.2 Kbits/s
2	93.75 Kbits/s
3	187.5 Kbits/s
4	500 Kbits/s
5	Not detected
6	1500 Kbits/s
7	3000 Kbits/s
8	6000 Kbits/s
9	12000 Kbits/s
10	Reserved
11	45.45 Kbits/s

P00964 - Drive Identification

Range:	0 to 65535	Factory Setting:	0
Properties:	RO - Read Only AC - Accessory		

Description

Specific parameter of the Profibus DP communication, defined by the PROFIdrive standard, for indication of information on the drive. This parameter has five sub-indices with information on the drive, but the sub-indices 1 to 4 are only accessible by using the acyclic access to parameters defined by the PROFIdrive profile. Other interfaces only access the sub-index).

- Sub-index 0: Manufacturer = 367.
- Sub-index 1: Drive Unit Type = 8.
- Sub-index 2: Version (software) = firmware version of the equipment (P00023).
- Sub-index 3: Firmware Date (year) = year of the development of the firmware in the yyyy format.
- Sub-index 4: Firmware Date (Day/month) = day and month of development of the firmware, in the dmmm format.

P00965 - Identification of the PROFIdrive Profile

Range:	0 to 65535	Factory Setting:	0
Properties:	RO - Read Only AC - Accessory		

Description

Specific parameter of the Profibus DP communication, defined by the PROFIdrive standard, for indication of the profile and version of the profile used by the drive. For the SCA06 servo drive, this parameter has a fixed value that can be divided into two bytes (high and low significant bits of the 16-bit word), where each byte has the following values:

- Byte 1 (MSB): Profile number = 3 (PROFIdrive).
- Byte 2 (LSB): Profile version = 41 (PROFIdrive Profile Version 4.1).

The value shown on parameter 809, which represents the decimal value linking the two bytes.

P00967 - PROFIdrive Control Word

Range:	0 to 65535	Factory Setting:	0
Properties:	RW - Reading and Writing AC - Accessory		

Description

Specific parameter of the Profibus DP communication, defined by the PROFIdrive standard, with the drive command word via Profibus DP interface when the selected data profile on P00741 is PROFIdrive. This parameter can only be changed via Profibus DP interface. For the other sources (HMI, serial, etc), it behaves as a read-only parameter.

For the commands written on this parameter to be executed, it is necessary that the drive be programmed to be controlled via Profibus DP on parameter P00202.

The functions specified on this word follow what is defined by the PROFIdrive specification. Each bit of this word represents a command that can be executed on the servo drive.

Table 15.5: PROFdrive command word

Bits	15 - 11	10	9	8	7	6	5	4	3	2	1	0
Function	Reserved	Control By PLC	Reserved	JOG 1 ON	Fault Acknowledge	Enable Setpoint	Reserved	Enable Ramp Generator	Enable Operation	No Quick Stop	No Coast Stop	ON/Off

Table 15.6: Functions for the bits of parameter P00967

P00967	Function	Description
Bit 0	On/Off	0: OFF -> If enabled, disables the drive 1: ON -> Allows enabling the drive
Bit 1	Coast stop	0: Coast Stop -> Disables the drive 1: No Coast Stop -> Allows enabling the drive
Bit 2	Quick stop	0: If enabled, executes quick stop command and disables the drive 1: Allows enabling the drive
Bit 3	Enable operation	0: Disables the drive 1: Enables the drive
Bit 4	Enable ramp generator	Not used for the SCA06
Bit 5	Reserved	-
Bit 6	Enable setpoint	0: Zeroes the speed reference value 1: Uses the speed reference value received by the Profibus DP network
Bit 7	Fault acknowledge	0: No function 1: If in fault status, resets the fault
Bit 8	Jog 1 On	Not used for the SCA06
Bit 9	Reserved	-
Bit 10	Control by PLC	Not used for the SCA06
Bits 11 to 15	Reserved	-

P00968 - PROFdrive Status Word

Range:	0 to 65535	Factory Setting: 0
Properties:	RO - Read Only AC - Accessory	

Description

Specific parameter of the Profibus DP communication, defined by the PROFdrive standard, with drive status word via Profibus DP interface when the selected data profile on P00741 is PROFdrive. The functions specified on this word follow what is defined by the PROFdrive specification. Each bit of this word represents a status.

Table 15.7: PROFdrive command word

Bits	15 - 10	9	8	7	6	5	4	3	2	1	0
Function	Reserved	Control Requested	Reserved	Warning Present	Switching On Inhibited	Quick Stop Not Active	Coast Stop Not Active	Fault Present	Operation Enabled	Ready to Operated	Ready to Switch On

Table 15.8: Functions for the bits of parameter P00968

P00968	Function	Description
Bit 0	Ready to Switch On	0: Drive cannot be enabled 1: Drive can be enabled (without safety stop)
Bit 1	Ready to Operate	0: Commands received from the master do not allow operation of the equipment 1: Commands received from the master allow operation of the equipment
Bit 2	Operation Enabled	0: Drive disabled 1: Drive enabled, can receive command to release the ramp
Bit 3	Fault Present	0: No fault on the drive 1: Drive in fault status
Bit 4	Coast Stop Not Active	0: Disables drive 1: Drive enabled
Bit 5	Quick Stop Not Active	0: Drive with quick stop command 1: No quick stop on the drive (STOP function)
Bit 6	Switching On Inhibited	Not used for the SCA06
Bit 7	Warning Present	0: No alarms 1: Drive with some active alarm
Bit 8	Reserved	-
Bit 9	Control Requested	0: Drive operating in the local mode 1: Drive operating with control via Profibus DP network
Bit 10 to 15	Reserved	-

16 ETHERNET NETWORK PARAMETERS

This chapter describes the SCA06 servo drive parameters that are directly related to Ethernet Communication.



NOTE!

For a full description of the operation of the SCA06 servo drive on Ethernet network, refer to the Ethernet communication manual.

P00800 – Ethernet Module Identification

Range:	0 = Not Identified 1 = Modbus TCP 2 = EtherNet/IP 3 = PROFINET IO	Factory Setting:
Properties:	RO - Read Only AC - Accessory	

Description:

It allows identifying the Ethernet module type connected to the equipment.

Table 16.1: P00800 indications

Indication	Description
0 = Not Identified	Module not connected / not identified
1 = Modbus TCP	Ethernet module for communication with Modbus TCP protocol
2 = EtherNet/IP	Ethernet module for communication with EtherNet/IP protocol
3 = PROFINET IO	Ethernet module for communication with PROFINET IO protocol

P00801 – Ethernet Communication Status

Range:	0 = Setup 1 = Init 2 = Wait Comm 3 = Idle 4 = Data Active 5 = Error 6 = Reserved 7 = Exception 8 = Access Error	Factory Setting:
Properties:	RO - Read Only AC - Accessory	

Description:

It allows identifying the Ethernet communication status.

Table 16.2: P00801 indications

Indication	Description
0 = Setup	Module identified, waiting configuration data (automatic)
1 = Init	Module performing interface initialization procedure (automatic)
2 = Wait Comm	Initialization finished, but no communication with master
3 = Idle	Communication with master established, but in Idle mode or Program mode
4 = Data Active	Communication with master established and performing normal I/O data handling. "Online"
5 = Error	Communication error detected
6 = Reserved	Reserved
7 = Exception	Major fault detected by the Ethernet interface. Requires interface reinitialization
8 = Access error	Major fault detected between device and Ethernet interface. Requires interface reinitialization

P00803 – Ethernet Baud Rate

Range:	0 = Auto 1 = 10 Mbit/s, half duplex 2 = 10 Mbit/s, full duplex 3 = 100 Mbit/s, half duplex 4 = 100 Mbit/s, full duplex	Factory Setting: 0
Properties:	RW - Reading and Writing AC - Accessory	

Description:

It allows to set the desired baud rate for the Ethernet interface.

NOTE!

- For the changes in this parameter be effective, the equipment must be powered off and on again, or an update must be performed by P00849.
- For PROFINET interface, the baud is locked to 100 Mbit/s as required by the protocol.

P00806 – Modbus TCP Watchdog

Range:	0.0 to 65.5 s	Factory Setting: 0.0
Properties:	RW - Reading and Writing AC - Accessory	

Description:

It allows programming a time limit for the detection of Ethernet offline error, for Modbus TCP protocol. If the SCA06 remains without receiving valid telegrams longer than the time programmed in this parameter, it will be considered that a communication error has occurred, the alarm A00147 will be showed on the HMI and the option programmed in P00662 will be executed.

After being powered up, the SCA06 starts counting this time from the first received valid telegram. The value 0.0 disables this function.

NOTE!

For the changes in this parameter be effective, the equipment must be powered off and on again, or an update must be performed by P00849.

P00810 – IP Address Configuration

Range:	0 = Parameters 1 = DHCP	Factory Setting: 1
Properties:	RW - Reading and Writing AC - Accessory	

Description:

It allows to choose how to set the IP address for the Ethernet modules.

Table 16.3: P00810 options

Option	Description
0 = Parameters	The settings for IP address, sub-net mask and gateway shall be done by means of parameters P00811 to P00819
1 = DHCP	Enables DHCP function. A DHCP server should set the IP address, sub-net mask and gateway through network

NOTE! For the changes in this parameter be effective, the equipment must be powered off and on again, or an update must be performed by P00849.

P00811 – IP Address 1

P00812 – IP Address 2

P00813 – IP Address 3

P00814 – IP Address 4

Range:	0 to 255	Factory Setting:	192.168.0.10
Properties:	RW - Reading and Writing AC - Accessory		

Description:

If P00810 = 0 (parameters), these parameters allow you to program the IP address of the Ethernet module. For other option of P00810, these parameters have no function.

Each parameter programs one octet of the IP address, where the P00811 is the most significant octet. The programmed IP address, then, has the format “P00811.P00812.P00813.P00814”.

NOTE! For the changes in this parameter be effective, the equipment must be powered off and on again, or an update must be performed by P00849.

P00815 – Subnet CIDR

Range:	1 to 31	Factory Setting:	24
Properties:	RW - Reading and Writing AC - Accessory		

Description:

If P00810 = 0 (parameters), this parameters allow you to program the sub-net mask for the Ethernet module. The subnet mask can usually be programmed using a notation with 4 octets separated by dots, or CIDR notation, in which the value is the number of bits with value “1” in the subnet mask. For other option of P00810, this parameter has no function.

The Table 16.4 on page 16-4 shows the allowed values for the CIDR notation and equivalent dot notation for the subnet mask:

Table 16.4: P00815 options

CIDR	Sub-net Mask	CIDR	Sub-net Mask
1	128.0.0.0	17	255.255.128.0
2	192.0.0.0	18	255.255.192.0
3	224.0.0.0	19	255.255.224.0
4	240.0.0.0	20	255.255.240.0
5	248.0.0.0	21	255.255.248.0
6	252.0.0.0	22	255.255.252.0
7	254.0.0.0	23	255.255.254.0
8	255.0.0.0	24	255.255.255.0
9	255.128.0.0	25	255.255. 255.128
10	255.192.0.0	26	255.255. 255.192
11	255.224.0.0	27	255.255. 255.224
12	255.240.0.0	28	255.255. 255.240
13	255.248.0.0	29	255.255. 255.248
14	255.252.0.0	30	255.255. 255.252
15	255.254.0.0	31	255.255. 255.254
16	255.255.0.0		



NOTE!

For the changes in this parameter be effective, the equipment must be powered off and on again, or an update must be performed by P00849.

P00816 – Gateway 1

P00817 – Gateway 2

P00818 – Gateway 3

P00819 – Gateway 4

Range:	0 to 255	Factory Setting:	0.0.0.0
Properties:	RW - Reading and Writing AC - Accessory		

Description:

If P00810 = 0 (parameters), these parameters allow you to program the IP address of the default gateway for the Ethernet modules. For other option of P00810, these parameters have no function.

Each parameter programs one octet of the gateway address, where the P00816 is the most significant octet. The programmed gateway IP address, then, has the format “P00816.P00817.P00818.P00819”.



NOTE!

For the changes in this parameter be effective, the equipment must be powered off and on again, or an update must be performed by P00849.

P00820 – Ethernet Read Word #5

P00821 – Ethernet Read Word #6

P00822 – Ethernet Read Word #7

P00823 – Ethernet Read Word #8

P00824 – Ethernet Read Word #9

P00825 – Ethernet Read Word #10

P00826 – Ethernet Read Word #11

P00827 – Ethernet Read Word #12

P00828 – Ethernet Read Word #13

P00829 – Ethernet Read Word #14

P00830 – Ethernet Read Word #15

P00831 – Ethernet Read Word #16

Range:	0 to 9999	Factory Setting: 0
Properties:	RW - Reading and Writing AC - Accessory	

Description:

These parameters allow programming the number of read words (inputs: slave → master), as well as the content of each word.

The first four read words are pre-defined, representing the value of the status word, motor speed, torque current and present control mode (refer to Ethernet user's manual), and are always sent to the network master. The words #5 to #16 can be programmed by the user. By using these parameters it is possible to program the number of another parameter whose content must be made available at the network master input area. If, for instance, one wants to read from the SCA06 servo drive the motor current in Amps, one must program the value 3 in one of these parameters, because the parameter P00003 is the one that contains this information. It is worthwhile to remind that the value read from any parameter is represented with a 16 bit word. Even if the parameter has decimal resolution, the value is transmitted without the indication of the decimal places. E.g., if the parameter P00003 has the value 4.7 A, the value supplied via the network will be 47.

The number of read words is defined by programming zero in the last parameter required for communication. Besides the four predefined words, it will also be added to the input area the words programmed in these parameters if the contents programmed for these parameters is different from zero. The first parameter set to zero disables the use of itself and the other parameters in the sequence. For example, if you set P00820 = 0, only four predefined read words (state, speed, torque current and present control mode) will be communicated with the master.

Table 16.5: Read words programming

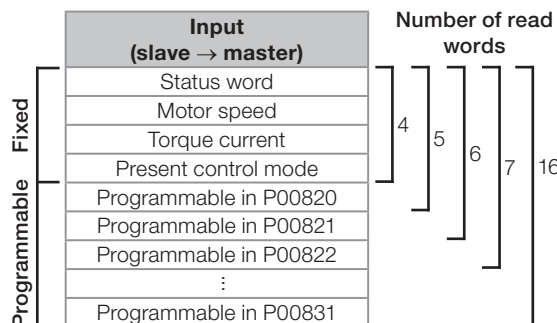

The same number of words programmed into the equipment must be programmed in the master when configuring the network.

For Modbus TCP communication, these parameters have no function, since the communication does not occur based on reading data, but by directly accessing the parameters of the product.



NOTE!

For the changes in this parameter be effective, the equipment must be powered off and on again, or an update must be performed by P00849.

P00835 – Ethernet Write Word #5

P00836 – Ethernet Write Word #6

P00837 – Ethernet Write Word #7

P00838 – Ethernet Write Word #8

P00839 – Ethernet Write Word #9

P00840 – Ethernet Write Word #10

P00841 – Ethernet Write Word #11

P00842 – Ethernet Write Word #12

P00843 – Ethernet Write Word #13

P00844 – Ethernet Write Word #14

P00845 – Ethernet Write Word #15

P00846 – Ethernet Write Word #16

Range:	0 to 9999	Factory Setting:	0
Properties:	RW - Reading and Writing AC - Accessory		

Description:

These parameters allow programming the number of write words (outputs: master → slave), as well as the contents of each word.

The first four write words are pre-defined, representing the value of the control word, speed reference, torque reference and control mode (refer to Ethernet user's manual), and are always received from the network master. The words #5 to #16 can be programmed by the user. By using these parameters it is possible to program the number of another parameter whose content must be made available at the network master output area. If, for instance, one wants to write to the SCA06 servo drive the ramp for STOP function, one must program the value 105 in one of these parameters, because the parameter P00105 is the one to program this information. It is worthwhile to remind that the value written from any parameter is represented with a 16 bit word. Even if the parameter has decimal resolution, the value is transmitted without the indication of the decimal places. E.g., if the parameter P00105 has the value 5.0 s, the value supplied via the network will be 50.

The number of write words is defined by programming zero in the last parameter required for communication. Besides the four predefined words, it will also be added to the output area the words programmed in these parameters if the contents programmed for these parameters is different from zero. The first parameter set to zero disables the use of itself and the other parameters in the sequence. For example, if you set P00835 = 0, only four predefined write words (control, speed reference, torque reference and control mode) will be communicated with the master.

Table 16.6: Write words programming

		Output (mestre -> escravo)	Number of write words			
Fixed		Control word	4	5	6	7
		Speed reference				
		Torque reference				
		Control mode				
Programmable		Programmable in P00835	16			
		Programmable in P00836				
		Programmable in P00837				
		⋮				
		Programmable in P00846				

The same number of words programmed into the equipment must be programmed in the master when configuring the network.

For Modbus TCP communication, these parameters have no function, since the communication does not occur based on reading data, but by directly accessing the parameters of the product.

NOTA! For the changes in this parameter be effective, the equipment must be powered off and on again, or an update must be performed by P00849.

P00849 – Update Ethernet Configuration

Range:	0 = Normal Operation 1 = Update configuration	Factory Setting: 0
Properties:	RW - Reading and Writing AC - Accessory	

Description:

It allows you to force a reset of the Ethernet interface, to update the settings made in the device parameters. When setting this parameter to “1”, the Ethernet interface is restarted, resulting in loss of communication during this process. After the process is complete, the parameter switch automatically to “0”.

17 ETHERCAT NETWORK PARAMETERS

The EtherCAT communication protocol is an open protocol based on Ethernet for fast data exchange between devices of the network, enabling functions such as control of different variables by means of the network.

NOTE! For a full description of the operation of the SCA06 servo drive on EtherCAT network, refer to the EtherCAT communication manual.

P00850 - EtherCAT Software Revision

Range:	0 to 65535	Factory Setting: 0
Properties:	RO - Read Only ECAT - EtherCAT Accessory	

Description

The EtherCAT accessory has a processor responsible for executing the communication routines and exchange data with the SCA06 servo drive. This parameter identifies the version of the firmware used in this accessory.

P00851 - EtherCAT Accessory Status

Range:	0 to 4	Factory Setting: 0
Properties:	RO - Read Only ECAT - EtherCAT Accessory	

Description

It indicates the EtherCAT interface status regarding the data exchange between the master and the SCA06 servo drive.

Table 17.1: Indications of parameter P0851

P00851	Description	Note
0	Inactive	Interface not installed or not recognized by the device
1	Access error	Error in the EtherCAT module initialization process
2	Watchdog error	Fault on the watchdog mechanism between the EtherCAT module and the equipment, which checks if the data update between both is being successfully executed
3	Offline	EtherCAT module operating properly, but without cyclic data exchange with the network master
4	Online	EtherCAT module operating properly, and with cyclic data exchange with the network master

P00852 - EtherCAT Link Status

Range:	0 to 65535	Factory Setting: 0
Properties:	RO - Read Only ECAT - EtherCAT Accessory	

Description

Parameter which supplies information about the communication status for each Ethernet port available on the module. It uses a binary field, where each bit represents a distinct piece of information:

Table 17.2: EtherCAT Link Status

P00852	Description	Note
0	Reserved	
1	Reserved	
2	Reserved	
3	Reserved	
4	Link 1 Connected	0: Port 1 without link 1: Port 1 with link
5	Link 2 Connected	0: Port 2 without link 1: Port 2 with link
6	Reserved	
7	Reserved	
8	P1: Communication Active	0: Without data loop at port 1 1: Data loop at port 1 active for response return to the master
9	P1: Loop closed	0: Without communication at port 1 1: With data communication at port 1
10	P2: Communication Active	0: Without data loop at port 2 1: Data loop at port 2 active for response return to the master
11	P2: Loop closed	0: Without communication at port 2 1: With data communication at port 2
12	Reserved	
13	Reserved	
14	Reserved	
15	Reserved	

P00853 - EtherCAT Slave Status

Range:	0 to 8	Factory Setting: 0
Properties:	RO - Read Only ECAT - EtherCAT Accessory	

Description

It indicates the slave status according to the EtherCAT status machine.

Table 17.3: EtherCAT Slave Status

P00853	Description	Note
0	Inactive	Interface inactive
1	Initialization	EtherCAT slave in the initialization status waiting for configurations and commands from the master to enable data exchange via mailbox
2	Pre-Operational	Successful initialization waiting for commands from the master to configure the communication and start the cyclic data exchange
3	Reserved	
4	Safe-Operational	Master executes cyclic reading of the data from the slave, without writing data update
5	Reserved	
6	Reserved	
7	Reserved	
8	Operational	It executes cyclic reading and writing data update via network

P00854 - Reserved

Range:	Reserved	Factory Setting: Reserved
Properties:	ECAT - EtherCAT Accessory	

P00855 - EtherCAT TxPDO Configuration

Range:	0 to 65535	Factory Setting:	0
Properties:	RO - Read Only ECAT - EtherCAT Accessory		

Description

It indicates the transmission PDO rate selected for communication on the device. The equipment provides four transmission PDOs responsible for sending data to the master, but only one can be active for communication. Each TxPDO has a different default mapping, but the master can also change the mapping of the PDOs as desired.

P00856- EtherCAT TxPDO Data Size

Range:	0 to 32	Factory Setting:	0
Properties:	RO - Read Only ECAT - EtherCAT Accessory		

Description

It indicates the data size, in bytes, transmitted to the master via TxPDO. The number of bytes is formed by adding the size of each object mapped on the TxPDO, and it is only updated when the master starts the cyclic data communication with the device.

P00857 - EtherCAT RxPDO Configuration

Range:	0 to 65535	Factory Setting:	0
Properties:	RO - Read Only ECAT - EtherCAT Accessory		

Description

It indicates the reception PDO rate selected for communication on the device. The equipment provides four reception PDOs responsible for receiving data from the master, but only one can be active for communication. Each RxPDO has a different default mapping, but the master can also change the mapping of the PDOs as desired.

P00858 - EtherCAT RxPDO Data Size

Range:	0 to 32	Factory Setting:	0
Properties:	RO - Read Only ECAT - EtherCAT Accessory		

Description

It indicates the data size, in bytes, received from the master via RxPDO. The number of bytes is formed by adding the size of each object mapped on the RxPDO, and it is only updated when the master starts the cyclic data communication with the device.

P00859 - EtherCAT Data Update

Range:	0 to 10000	Factory Setting:	0
Properties:	RO - Read Only ECAT - EtherCAT Accessory		

Description

Once in the operating status, the master must send telegrams to update the operating data at regular intervals. This parameter indicates the time between the two last data updates, enabling to monitor the period for the execution of this function.

18 LADDER PARAMETERS

This parameter group, called Ladder Parameters, add important PLC (Programmable Logic Controller) functions to the servo drive, enabling the execution of complex interlocking programs which may be accessed by the user's program.

Among the several functions available, we can point out from simple coil contacts to functions that use floating points, such as addition, subtraction, multiplication, division, trigonometric functions, square root, etc.

Other important functions are the PID blocks, pass-high and pass-low filters, saturation, comparison, all of them at floating point.

Besides the functions mentioned above, the PLC also offers blocks to control motor speed and position, which are positionings with trapezoidal profile, positionings with S profile, generation of speed reference with trapezoidal acceleration ramp, etc.

The user can interact with all the functions through the 200 programmable parameters (grouped in the group "User's Parameter"), which can be accessed directly on the servo drive HMI and, through the WLP (Weg Ladder Programmer) or WPS (Weg Programming Suite), can be customized with user's texts and units.

Through the new ModBus functions, it is possible to execute advanced functions of on-line monitoring on the WLP/WPS software.

P01000 - PLC Status

Range:	0 to 5	Factory Setting:
Properties:	RO - Read Only	

Description

It allows the user to view the program status.

Table 18.1: PLC Status

P01000	PLC Status	Note
0	No program	There are no programs installed
1	Saving Program	Receiving or sending files for WLP/WPS
2	Copy Memory Card	It occurs when the backup is being done to the flash memory card
3	Invalid Program	User's program incompatible
4	Program Stopped	There is a valid program on the memory, but the option "Stop Program" is selected (P01020 = 0)
5	Program Running	User's program is running

P01001 - Scan Time

Range:	0.0 to 6553.5	Factory Setting:
Properties:	RO - Read Only	

Description

It allows the user to monitor the scan cycle time of the program in milliseconds.

P01003 - Fraction of Revolution by DI1

Range:	-16383 to 16383	Factory Setting:
Properties:	RO - Read Only	

Description

It indicates the value of fraction of revolution at the moment an edge occurred on DI1 (leading edge or falling edge, according to the programming in P00300).

P01004 - Number of Revolutions by DI1

Range: -32768 to 32767

**Factory
Setting:**

Properties: RO - Read Only

Description

It indicates the number of revolutions at the moment an edge occurred on DI1 (rising edge or falling edge, according to the programming in P00300).

P01007 - Fraction of Revolution by the DI2

Range: -16383 to 16383

**Factory
Setting:**

Properties: RO - Read Only

Description

It indicates the value of fraction of revolution at the moment an edge occurred on DI2 (rising edge or falling edge, according to the programming in P00301).

P01008 - Number of Revolutions by DI2

Range: -32768 to 32767

**Factory
Setting:**

Properties: RO - Read Only

Description

It indicates the number of revolutions at the moment an edge occurred on DI2 (rising edge or falling edge, according to the programming in P00301).

P01011 - Fraction of Revolution by the DI3

Range: -16383 to 16383

**Factory
Setting:**

Properties: RO - Read Only

Description

It indicates the value of fraction of revolution at the moment an edge occurred on DI3 (rising edge or falling edge, according to the programming in P00302).

P01012 - Number of Revolutions by DI3

Range: -32768 to 32767

**Factory
Setting:**

Properties: RO - Read Only

Description

It indicates the number of revolutions at the moment an edge occurred on DI3 (rising edge or falling edge, according to the programming in P00302).

P01014 - Value of the Low Counter by DI3

Range: 0 to 65535

**Factory
Setting:**

Properties: RO - Read Only

Description

It indicates the value of the least significant bits of the counter at the moment an edge occurred on DI3 (leading edge or falling edge, according to the programming in P00302).

P01015 - Value of the High Counter by DI3

Range:	0 to 65535	Factory Setting:
Properties:	RO - Read Only	

Description

It indicates the value of most significant bits of the counter at the moment an edge occurred on DI3 (leading edge or falling edge, according to the programming in P00302).

P01016 - Value Stored by the Null Pulse Z1 (Counter 1 or Counter 2) - Least significant bits

Range:	0 to 65535	Factory Setting:
Properties:	RO - Read Only	

Description

It indicates the value of the least significant bits of counter stored (counter 1 or counter 2) at the moment an edge occurred on pulse Z1. The option to store the counter 1 or counter 2, as well as whether this parameter will occur on the rising or falling edge of the null pulse, is set by parameter P00511.

P01017 - Value Stored by the Null Pulse Z1 (Counter 1 or Counter 2) - Most significant bits

Range:	0 to 65535	Factory Setting:
Properties:	RO - Read Only	

Description

It indicates the value of the most significant bits of counter stored (counter 1 or counter 2) at the moment an edge occurred on pulse Z1. The option to store the counter 1 or counter 2, as well as whether this parameter will occur on the rising or falling edge of the null pulse Z1, is set by parameter P00511.

P01018 - Value Stored by the Null Pulse Z2 (Counter 1 or Counter 2) - Least significant bits

Range:	0 to 65535	Factory Setting:
Properties:	RO - Read Only	

Description

It indicates the value of the least significant bits of counter stored (counter 1 or counter 2) at the moment an edge occurred on pulse Z2. The option to store the counter 1 or counter 2, as well as whether this parameter will occur on the rising or falling edge of the null pulse Z1, is set by parameter P00521.

P01019 - Value Stored by the Null Pulse Z2 (Counter 1 or Counter 2) - Most significant bits

Range:	0 to 65535	Factory Setting:
Properties:	RO - Read Only	

Description

It indicates the value of the most significant bits of counter stored (counter 1 or counter 2) at the moment an edge occurred on pulse Z2. The option to store the counter 1 or counter 2, as well as whether this parameter will occur on the rising or falling edge of the null pulse Z1, is set by parameter P00521.

P01020 - PLC Command

Range: 0 and 1

Factory Setting: 1

Properties: PP - Press P to validate

Description

It allows the user to stop the application installed or make it be executed, according to [Table 18.2 on page 18-4](#).

Table 18.2: PLC command

P01020	PLC Command
0	For program
1	Runs the program

Note: If you keep the SHIFT and INCREMENT keys pressed during the initialization of the drive, the user's application will not be executed. For the application to be executed again, the drive must be reinitialized.

P01021 - Scan Time

Range: 0.5 to 200.0

Factory Setting: 5.0

Properties: PP - Press P to validate

Description

It allows the user to configure an execution period of the ladder application in milliseconds.

P01022 - PLC Watchdog

Range: 0 to 5

Factory Setting: 0

Properties: PP - Press P to validate

Description

Number of times in a row that the scan time of the ladder application (P01001) can reach or exceed the programmed scan period (P01021) without producing the watchdog fault.

Example: If the PLC **Watchdog** (P01022) is set with value 3, that means that if the scan time (P01001) exceeds or reaches 4 times in a row the application scan time (P01021), the watchdog fault will occur (F00829), as shown in [Figure 18.1 on page 18-4](#).

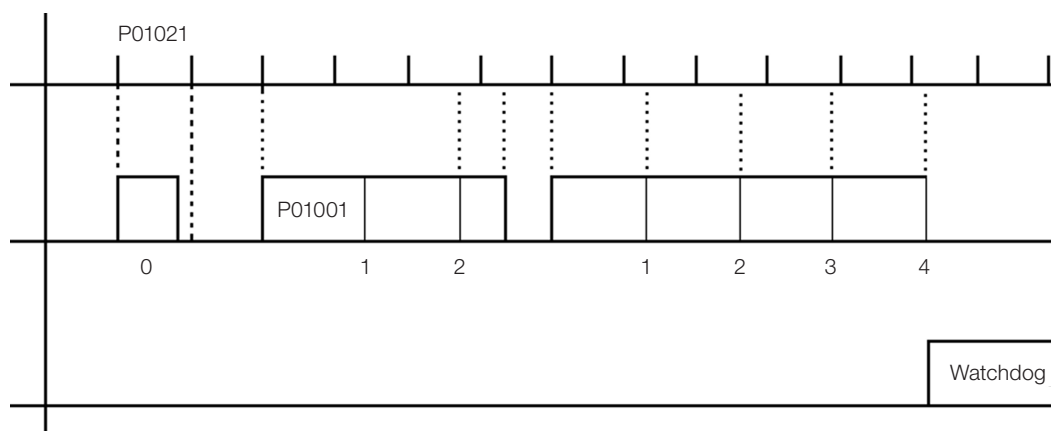

Figure 18.1: Example of the PLC watchdog

P01023 - Type of Control at Power-On

Range:	2 and 3	Factory Setting:	3
Properties:	RW - Reading and Writing		

Description

It selects the type of control to be used at the ladder initialization, as shown in [Table 18.3 on page 18-5](#). This parameter is only valid when P00202 = 4.

Table 18.3: Control options at the ladder initialization

P01023	Control Options
2	Speed mode
3	Position mode

P001024 - PLC Supervision

Range:	0 to 2	Factory Setting:	0
Properties:	PP - Press P to validate		

Description

Configures the drive action when the PLC program is not running.

Table 18.4: Action selection

P01024	Action
0	Inactive
1	Cause Alarm A00708
2	Cause Fault F00709

P01027 - Zero Retentive Markers

Range:	0 and 1	Factory Setting:	0
Properties:	PP - Press P to validate		

Description

It allows the user to zero the retentive markers used in the user's program.

Table 18.5: Zero retentive marker option

P01027	Zero Markers
0	Disabled
1	Zero marker

P01028 - Load Ladder

Range:	0 to 3	Factory Setting:	0
Properties:	PP - Press P to validate		

Description

It allows the user to load the ladder application or to configure the user's parameters contained on the flash memory card.

Table 18.6: Options of P01028

P01028	Load Ladder
0	Disabled
1	Load application
2	Load configuration of parameters
3	Load CANopen configuration

Note: When parameter P01028 takes on some value different from zero, when executing the command, the HMI will display letter “b” flashing on digit 1.

P01031 - Maximum Stop Lag Error

Range:	0 to 16383	Factory Setting:	0
Properties:	RW - Reading and Writing		

Description

It indicates the maximum error value accepted when stopping the execution of a positioning, while a new positioning is not started. This error is the maximum difference between the reference position and the final position in number of pulses.

Whenever the servo drive is with the position loop active and no point-to-point movement is being performed, this Lag will be under monitoring.

In case of continuous movements, such as MC_CamIn and MC_GearInPos, it is recommended to program just the Maximum Following Lag Error.

Note: 16384 pulses correspond to one revolution.
When P01031 = 0 or the Stop function is activated, the stop lag error will not occur.

P01032 - Maximum Following Lag Error

Range:	0 to 16383	Factory Setting:	0
Properties:	RW - Reading and Writing		

Description

It indicates the maximum value accepted when executing a positioning, that is, the maximum difference between the reference position and the actual position during positioning in number of pulses.

Whenever the servo drive is with the position loop active, this Lag will be under monitoring.

Note: 16384 pulses correspond to one revolution.
When P01032 = 0 or the Stop function is activated, the following lag error will not occur.

19 USER'S PARAMETERS

There is a range of parameters on the SCA06 reserved for user's parameters, where the definition of the function of each parameter will be configured on the Ladder program.

P01050 to P01249 - User's Parameter

Range:	-32768 to 32767	Factory Setting:	0
Properties:	RW - Reading and Writing		

Description

Parameters of general use of the user.

20 POSITIONER FUNCTION

The positioner function (P00202 = 3) allows programming via user parameters 10 sequences of axis motion functions to be activated via digital inputs or via parameters.

The programming is performed using cycles (up to 10 cycles), and each cycle may contain a sequence of up to 5 motions. These sequences are programmed in P01101 to P01150. Up to 10 different motions can be programmed on parameters P01151 to P01230. It is possible to program a digital input (or parameter) to activate a given cycle. When you select the option to activate the cycle by the edge of the digital input, for example, at each edge a motion of the chosen cycle will be executed, respecting the programmed order. [Section 20.3 EXAMPLES on page 20-18](#) describes in more details the configuration parameters.

20.1 THE AVAILABLE MOTIONS ARE:

20.1.1 Relative Positioning:

It moves to a position relative to the current position. The length of the displacement is defined by the sum of the number of turns P0118X ⁽⁴⁾ and the fraction of turn P0117X ⁽⁵⁾. The displacement is performed with the speed, acceleration, deceleration, and jerk programmed in P0119X ⁽⁶⁾, P0120X ⁽⁷⁾, P0121X ⁽⁸⁾ and P0122X ⁽⁹⁾, as shown in [Figure 20.1 on page 20-1](#) below. If jerk different from zero (S curve) is used, the deceleration will be equal to the value programmed in the acceleration.

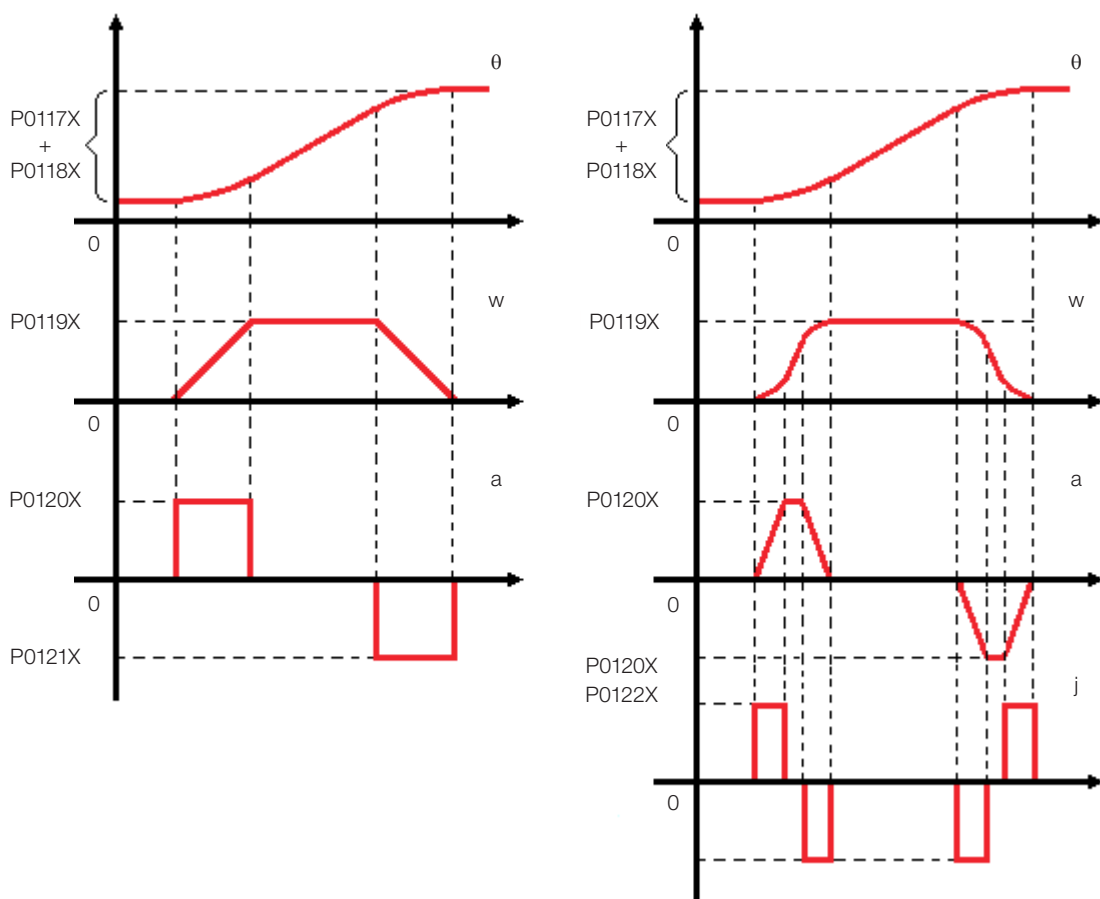

Figure 20.1: Graph of position, speed, acceleration, and jerk respectively during a relative positioning without jerk (on the left) and with jerk (on the right). Note that in the case with jerk, the acceleration and deceleration are determined by the same parameter, and they are consequently the same

- (4) P0118X: P01181 until P01190.
- (5) P0117X: P01171 until P01180.
- (6) P0119X: P01190 until P01200.
- (7) P0120X: P01201 until P01210.
- (8) P0121X: P01211 until P01220.
- (9) P0122X: P01221 until P01230.

20.1.2 Absolute Positioning

It moves the axis to an absolute target position. This target position is equal to the sum of the number of turns (P0118X ⁽¹⁰⁾) and the fraction of turn (P0117X ⁽¹¹⁾). The positioning is performed with the speed, acceleration, deceleration and jerk set in P0119X ⁽¹²⁾, P0120X ⁽¹³⁾, P0121X ⁽¹⁴⁾ and P0122X ⁽¹⁵⁾ as indicated in Figure 20.2 on page 20-2. If jerk different from zero (S curve) is used, the deceleration will be the same value set in the acceleration.

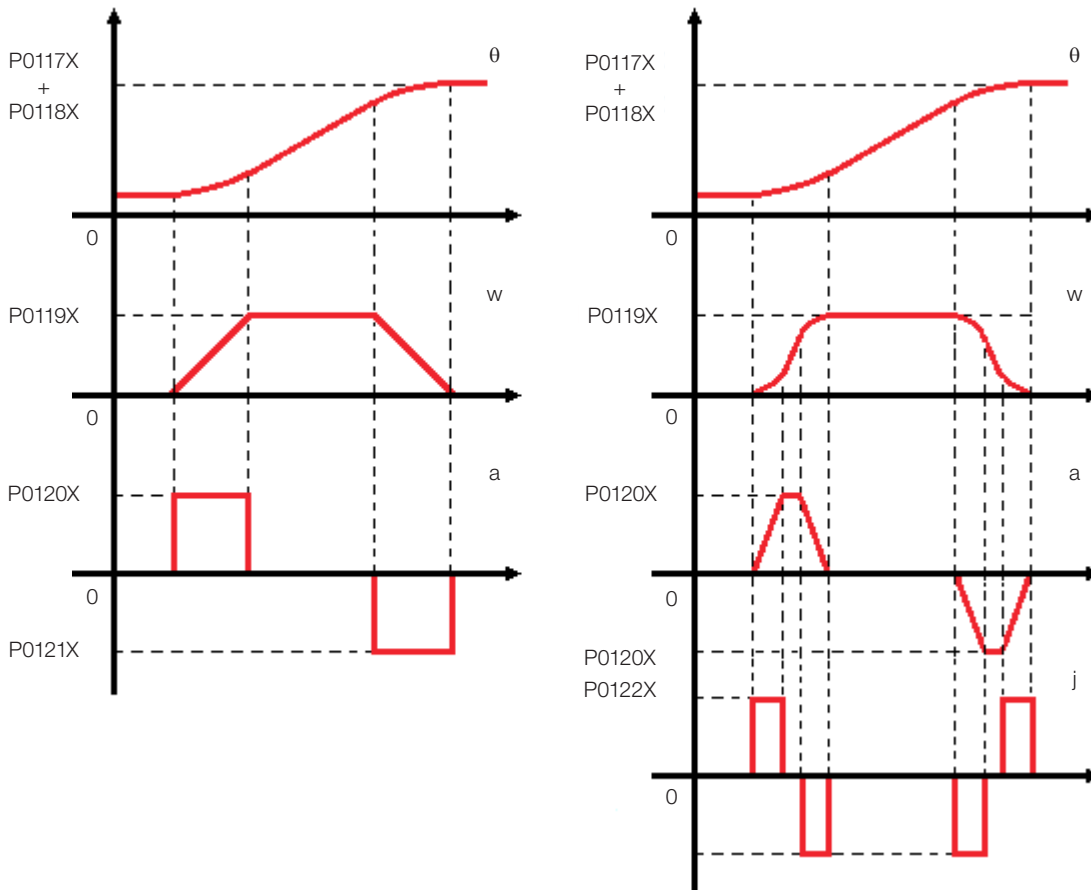

Figure 20.2: Graph of position, speed, acceleration, and jerk respectively during an absolute positioning without jerk (on the left) and with jerk (on right). Note that in the case with jerk, the acceleration and deceleration are determined by the same parameter, and they are consequently the same

20.1.3 Drive in Speed Control

It accelerates or decelerates (depending on the current speed and target speed), with the value set in P0120X ⁽¹⁵⁾ and P0121X ⁽¹⁶⁾ respectively until reaching the speed set in P0119X ⁽¹⁷⁾, and then it keeps such speed until another motion is driven. If jerk value (set in P0122X ⁽¹⁸⁾) is used, the acceleration/deceleration will respect this jerk, as shown in Figure 20.3 on page 20-3.

- (10) P0118X: P01181 until P01190.
- (11) P0117X: P01171 until P01180.
- (12) P0119X: P01191 until P01200.
- (13) P0120X: P01201 until P01210.
- (14) P0121X: P01211 until P01220.
- (15) P0122X: P01221 until P01230
- (16) P0120X: P01201 until P01210.
- (17) P0121X: P01211 until P01220.
- (18) P0119X: P01191 until P01200.
- (19) P0122X: P01221 até P01230.

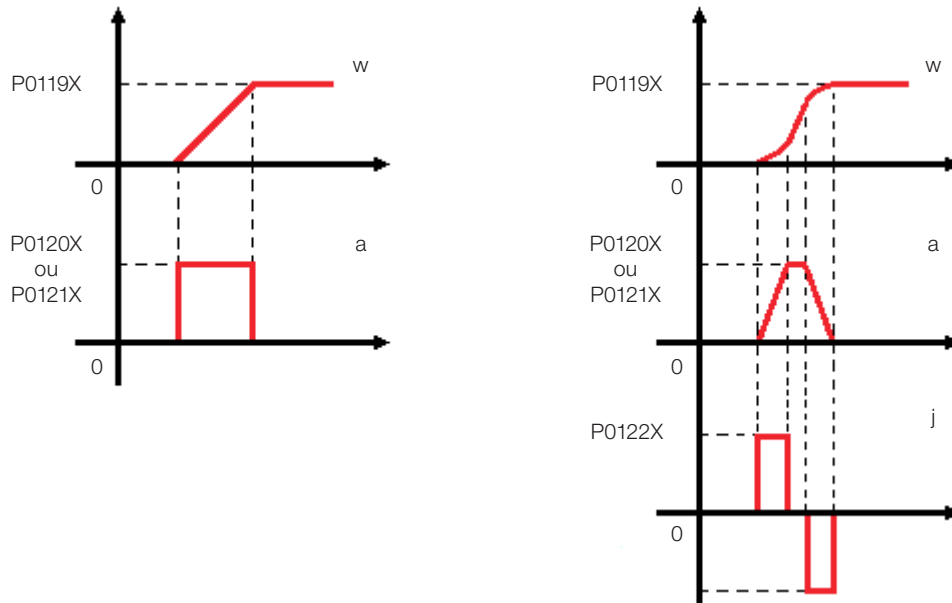

Figure 20.3: Graphic of speed, acceleration, and jerk respectively, during a drive in speed control: without jerk (on the left) and with jerk (on the right)

20.1.4 Drive in Iq control (Torque)

It applies a current value i_q (set in P0119X) on the axis, which is proportional to the torque, and then it maintains this current until another motion is driven. The current rise follows the ramp set in parameter P0120X until reaching the target value as shown in Figure 20.4 on page 20-3.

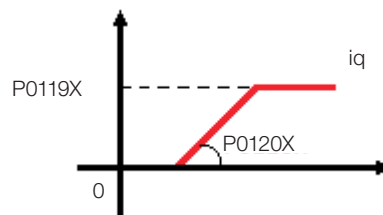

Figure 20.4: i_q current graph (proportional to the torque) during a drive in Iq control

20.1.5 Position Follower

It makes the synchronism in position between the axis and the master set in P01074 (fast drive Inputs, CANopen Network, Encoder Input 1 or Encoder Input 2). This synchronism takes place with a master-slave ratio as defined by the numerator/denominator ratio (P0118X ⁽²⁰⁾/P0117X ⁽²¹⁾).

Until the slave axis reaches the speed of the master axis (multiplied by the master-slave ratio), an acceleration or deceleration motion is performed as set in parameters P0120X ⁽²²⁾ and P0121X ⁽²³⁾.

The direction of the motion will depend on the signal of the Numerator of the master-slave ratio (P0118X). If the Numerator is greater than zero, the motion will be in the same direction as the master axis, and if it is smaller than zero, the motion will be in the opposite direction of the master axis.

The synchronism remains until another motion is driven.

20.1.6 Speed Follower

It performs the synchronism in speed between the axis and the master set in P01074 (fast drive Inputs, CANopen Network, Encoder Input 1 or Encoder Input 2). This synchronism takes place with a master-slave ration defined by the ratio Numerator/Denominator ration (P0118X / P0117X).

Until the slave axis reaches the speed of the master axis (multiplied by the master-slave ratio), an acceleration or deceleration motion is performed as set in parameters P0120X and P0121X.

The direction of the motion will depend on the signal of the Numerator of the master-slave ratio (P0118X). If the Numerator is greater than zero, the motion will be in the same direction as the master axis, and if it is smaller than zero, the motion will be in the opposite direction of the master axis.

The synchronism remains until another motion is driven.

20.1.7 Search Zero Machine Positive Direction

It executes a procedure of search for zero machine for the positive speed direction. This procedure can be performed in two different ways: it only performs the search for the zero machine sensor (ZMS), or it performs the search for the zero machine followed by the search for the motor zero (Z) according to the setting of parameter P01075 (see Figure 20.5 on page 20-4). The zero machine sensor ZMS must be connected to a fast digital input (standard input 1, 2 or 3 of the SCA06), which must be set according to the type of edge that will actuate the sensor (rising edge or falling), as Table 20.1 on page 20-4. The Z position (motor zero) is an internal signal that does not require setting.

At the end of the search, the position where the drive stops is loaded with the value set in P0117X ⁽²⁴⁾ and P0118X ⁽²⁵⁾, that is, this position will be the zero position only if those parameters are zero.

20.1.8 Search Zero Machine Negative Direction

It performs the same motion as the previous item, only in the reverse speed direction.

Table 20.1: Parameterization to use the motions search zero machine positive and negative direction; in addition to the settings below, it is necessary to set the type of search in P01075 (0 = search ZMS + search Z, 1 = search ZMS only)

Direction of Search Zero P0115X	Active Edge of the ZMS P01076	Setting of Digital Inputs Connected to ZMS P00300, P00301 or P00302
10 - positive direction	0 - rising edge	8 - stores position and rising edge
10 - positive direction	1 - falling edge	9 - stores position falling edge
11 - negative direction	0 - rising edge	8 - stores position and rising edge
11 - negative direction	1 - falling edge	9 - stores position falling edge

- (20) P0118X: P01181 until P01190
- (21) P0119X: P01191 until P01200
- (22) P0120X: P01201 until P01210
- (23) P0121X: P01211 until P01220
- (24) P0117X: P01171 until P01180
- (25) P0118X: P01181 until P01190

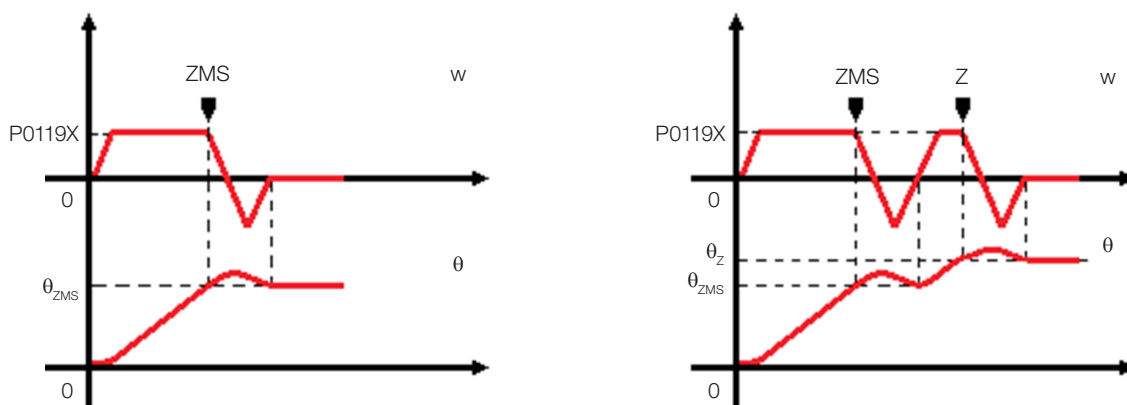

Figure 20.5: Graph representing machine search of zero machine in positive direction. On the left is the procedure of search ZMS only, and on the right is the procedure of search ZMS followed by search Z

20.1.9 Jog Function

It executes a motion in speed while the function is activated (via digital input or P01079). The activation of the Jog function will always be by level, i.e., the Jog function is active while the digital input or P01079 is activated. The

motion is executed with an acceleration or deceleration (depending on the current speed and target speed), with value set in P0120X ⁽²⁶⁾ and P0121X ⁽²⁷⁾ respectively until reaching the speed set in P0119X ⁽²⁸⁾, and then it keeps this speed until the jog function is deactivated. If a jerk value is used (set in P0122X ⁽²⁹⁾) the acceleration/deceleration will respect this jerk.

20.2 DESCRIPTION OF THE PARAMETERS

This item contains a more detailed description of each user parameter used by the Positioner Function.

P01070 – Select Slot

Range:	0 to 3	Factory Setting:	0
Properties:	RW - Reading and Writing		

Description

It selects the slot where the digital inputs to be used are, as described in [Table 20.2 on page 20-5](#).

Table 20.2: Option of P01070

Option	Description
0	The 3 standard digital inputs of the drive will be used to activate the motion cycles
1	The digital inputs of the accessory connected to slot 1 will be used to activate the motion cycles
2	The digital inputs of the accessory connected to slot 2 will be used to activate the motion cycles
3	The digital inputs of the accessory connected to slot 3 will be used to activate the motion cycles

P01071 – Reset Cycle

Range:	0 to 1	Factory Setting:	0
Properties:	RW - Reading and Writing		

Description

In the transition from 0 to 1 of this parameter, all the motion cycles are reset to the first motion.

(26) P0120X: P01201 until P01210.

(27) P0121X: P01211 until P01220.

(28) P0119X: P01191 until P01200.

(29) P0122X: P01221 until P01230.

P01072 – Maps parameters of the Move function of the SCA05 servo drive

Range:	0 to 1	Factory Setting:	0
Properties:	RW - Reading and Writing		

Description

When this parameter is set to 1, the position and speed references start to be mapped from the parameters used in the SCA05 (P0124 to P0133 and P0471 to P0490), and parameters P01171 to P01200 are not used. It must be used in conjunction with parameter P00667 = 1, and only when these references are written via serial.

P01074 – Master of the Following type Motion

Range:	0 to 4	Factory Setting:	0
Properties:	RW - Reading and Writing		

Description

It selects the source of the master to be followed by both position and speed following motion.

Table 20.3: Master source defined in parameter P01076

Option	Description
0	Not used
1	Drive fast inputs
2	CANopen Network
3	Encoder 1 Input (accessory required)
4	Encoder 2 Input (accessory required)

P01075 – Type of the Search of Machine Zero

Range:	0 to 1	Factory Setting:	0
Properties:	RW - Reading and Writing		

Description

See [Table 20.4 on page 20-6](#).

Table 20.4: Types of zero search set in parameter P01075

Option	Description
0	After finding the machine zero sensor, the drive will search for the zero of the position feedback sensor of the motor, and only then will it stop
1	The search for the zero of the position feedback sensor of the motor does not occur; the stop occurs in the machine sensor position

P01076 – Edge Type of the Search of Machine Zero

Range:	0 to 1	Factory Setting:	0
Properties:	RW - Reading and Writing		

Description

See [Table 20.5 on page 20-6](#).

Table 20.5: Master source defined in parameter P01074

Option	Description
0	The activation of the machine zero sensor occurs at the rising edge
1	The activation of the machine zero sensor occurs at the falling edge

P01077 – Selection of the Activation of the Cycles by Edge or Level

Range:	0 to 1	Factory Setting:	0
Properties:	RW - Reading and Writing		

Description

There are two options for selecting the activation of the cycles, according to [Table 20.6 on page 20-6](#).

If selected the option to activate the cycle by rising edge of the digital input (option P01077 = 0), it is necessary that the digital input signal remains at low level after the edge so as to allow the activation of a new motion by means of the edge of another digital input.

Table 20.6: Master source defined in parameter P01074

Option	Description
0	The activation of the cycle occurs at the rising edge of the digital input set (or of the P01080)
1	The activation of the cycle occurs at the level of the digital input set (or of the P01080); while it is at level 1, the cycle is continuously activated

P01078 – Cycle Activation Filters

Range:	0 to 32767 ms	Factory Setting:	0
Properties:	RW - Reading and Writing		

Description

The digital inputs set (or of the P01080) must remain activated longer than the time set in this parameter in order to activate the cycle.

P01079 – Activation of the Cycle by Parameter

Range:	0 to 1	Factory Setting:	0
Properties:	RW - Reading and Writing		

Description

When this parameter is set to 1, the cycle set in P01080 is activated.

P01080 – Sets Cycle Activated by Parameter P01079

Range:	-10 to 10	Factory Setting:	0
Properties:	RW - Reading and Writing		

Description

It defines which cycle will be activated when using parameter P01079.

P01081 – Sets Cycle Activated by Digital Input 01

P01082 – Sets Cycle Activated by Digital Input 02

P01083 – Sets Cycle Activated by Digital Input 03

P01084 – Sets Cycle Activated by Digital Input 04

P01085 – Sets Cycle Activated by Digital Input 05

P01086 – Sets Cycle Activated by Digital Input 06

P01087 – Sets Cycle Activated by Digital Input 07

P01088 – Sets Cycle Activated by Digital Input 08

P01089 – Sets Cycle Activated by Digital Input 09

P01090 – Sets Cycle Activated by Digital Input 10

Range:	-10 to 10	Factory Setting:	0
Properties:	RW - Reading and Writing		

Description

Sets which cycle will be activated by the digital inputs 1 to 10.

When setting a negative value, the cycle will be of the full type, i.e., when activating the input set once, all the motions of the cycle will be executed in sequence.

In case a positive value is set, at each activation of the digital input, only one motion of the cycle is executed. After reaching the last motion set, the cycle restarts from the first motion.

Example:

P01082 = 3.

It means that when activating digital input 2, cycle 3 will be activated.

P01091 – Position Reference (turn fraction) for Positioner Function in Digital Output

Range:	0 to 16383	Factory Setting:	0
Properties:	RW - Reading and Writing		

Description

It defines the turn fraction at which the digital output will be turned off before the end of the positioning in execution.

P01092 – Position Reference (number of turns) for Positioner Function in Digital Output

Range:	0 to 32767	Factory Setting:	0
Properties:	RW - Reading and Writing		

Description

It defines the number of turns at which the digital output will be turned off before the end of the positioning in execution.

Note: The function of the digital output (P00280 if P01070 = 0, P00281 if P01070 = 1, P00287 if P01070 = 2 and P00293 if P01070 = 3) must be set with option 8 (written by the ladder).

P01101 – First Motion of Cycle 01

P01102 – Second Motion of Cycle 01

P01103 – Third Motion of Cycle 01

P01104 – Fourth Motion of Cycle 01

P01105 – Fifth Motion of Cycle 01

Range:	0 to 10	Factory Setting:	0
Properties:	RW - Reading and Writing		

Description

It determines the motion sequence of cycle 1, when setting the first, second, third, fourth and fifth motions of this cycle. Zero indicates the end of the cycle.

Example 1:

- The following parameters were set as follows:
 - P01101 = 00002.
 - P01102 = 00004.
 - P01103 = 00000.
- With the setting above, when cycle 1 is activated, the following motion sequence is executed:
 - Motion 02.
 - Motion 04, and then the cycle is restarted.

Important, if the cycle has fewer than five motions, it must be set with end zero!

Example 2:

- The following parameters were set as follows:
 - P01101 = 00001.
 - P01102 = 00002.
 - P01103 = 00003.
 - P01104 = 00004.
 - P01105 = 00005.

- With the setting above, when cycle 1 is activated, the following motion sequence is executed:
 - Motion 01.
 - Motion 02.
 - Motion 03.
 - Motion 04.
 - Motion 05, and then the cycle is restarted.

P01106 – First Motion of Cycle 02

P01107 – Second Motion of Cycle 02

P01108 – Third Motion of Cycle 02

P01109 – Fourth Motion of Cycle 02

P01110 – Fifth Motion of Cycle 02

Range:	0 to 10	Factory Setting: 0
Properties:	RW - Reading and Writing	

Description

It determines the motion sequence of cycle 2, when setting the first, second, third, fourth and fifth motions of this cycle. Zero indicates the end of the cycle.

See examples in the description of parameters P01101 to P01105.

P01111 – First Motion of Cycle 03

P01112 – Second Motion of Cycle 03

P01113 – Third Motion of Cycle 03

P01114 – Fourth Motion of Cycle 03

P01115 – Fifth Motion of Cycle 03

Range:	0 to 10	Factory Setting: 0
Properties:	RW - Reading and Writing	

Description

It determines the motion sequence of cycle 3, when setting the first, second, third, fourth and fifth motions of this cycle. Zero indicates the end of the cycle.

See examples in the description of parameters P01101 to P01105.

P01116 – First Motion of Cycle 04

P01117 – Second Motion of Cycle 04

P01118 – Third Motion of Cycle 04

P01119 – Fourth Motion of Cycle 04

P01120 – Fifth Motion of Cycle 04

Range:	0 to 10	Factory Setting:	0
Properties:	RW - Reading and Writing		

Description

It determines the motion sequence of cycle 4, when setting the first, second, third, fourth and fifth motions of this cycle. Zero indicates the end of the cycle.

See examples in the description of parameters P01101 to P01105.

P01121 – First Motion of Cycle 05

P01122 – Second Motion of Cycle 05

P01123 – Third Motion of Cycle 05

P01124 – Fourth Motion of Cycle 05

P01125 – Fifth Motion of Cycle 05

Range:	0 to 10	Factory Setting:	0
Properties:	RW - Reading and Writing		

Description

It determines the motion sequence of cycle 5, when setting the first, second, third, fourth and fifth motions of this cycle. Zero indicates the end of the cycle.

See examples in the description of parameters P01101 to P01105.

P01126 – First Motion of Cycle 06

P01127 – Second Motion of Cycle 06

P01128 – Third Motion of Cycle 06

P01129 – Fourth Motion of Cycle 06

P01130 – Fifth Motion of Cycle 06

Range:	0 to 10	Factory Setting:	0
Properties:	RW - Reading and Writing		

Description

It determines the motion sequence of cycle 6, when setting the first, second, third, fourth and fifth motions of this cycle. Zero indicates the end of the cycle.

See examples in the description of parameters P01101 to P01105.

P01131 – First Motion of Cycle 07

P01132 – Second Motion of Cycle 07

P01133 – Third Motion of Cycle 07

P01134 – Fourth Motion of Cycle 07

P01135 – Fifth Motion of Cycle 07

Range:	0 to 10	Factory Setting:	0
Properties:	RW - Reading and Writing		

Description

It determines the motion sequence of cycle 7, when setting the first, second, third, fourth and fifth motions of this cycle. Zero indicates the end of the cycle.

See examples in the description of parameters P01101 to P01105.

P01136 – First Motion of Cycle 08

P01137 – Second Motion of Cycle 08

P01138 – Third Motion of Cycle 08

P01139 – Fourth Motion of Cycle 08

P01140 – Fifth Motion of Cycle 08

Range:	0 to 10	Factory Setting:	0
Properties:	RW - Reading and Writing		

Description

It determines the motion sequence of cycle 8, when setting the first, second, third, fourth and fifth motions of this cycle. Zero indicates the end of the cycle.

See examples in the description of parameters P01101 to P01105.

P01141 – First Motion of Cycle 09

P01142 – Second Motion of Cycle 09

P01143 – Third Motion of Cycle 09

P01144 – Fourth Motion of Cycle 09

P01145 – Fifth Motion of Cycle 09

Range:	0 to 10	Factory Setting:	0
Properties:	RW - Reading and Writing		

Description

It determines the motion sequence of cycle 9, when setting the first, second, third, fourth and fifth motions of this cycle. Zero indicates the end of the cycle.

See examples in the description of parameters P01101 to P01105.

P01146 – First Motion of Cycle 10

P01147 – Second Motion of Cycle 10

P01148 – Third Motion of Cycle 10

P01149 – Fourth Motion of Cycle 10

P01150 – Fifth Motion of Cycle 10

Range:	0 to 10	Factory Setting:	0
Properties:	RW - Reading and Writing		

Description

It determines the motion sequence of cycle 10, when setting the first, second, third, fourth and fifth motions of this cycle. Zero indicates the end of the cycle.

See examples in the description of parameters P01101 to P01105.

P01151 – Type of the Motion 01

P01152 – Type of the Motion 02

P01153 – Type of the Motion 03

P01154 – Type of the Motion 04

P01155 – Type of the Motion 05

P01156 – Type of the Motion 06

P01157 – Type of the Motion 07

P01158 – Type of the Motion 08

P01159 – Type of the Motion 09

P01160 – Type of the Motion 10

Range:	1 to 8	Factory Setting:	0
Properties:	RW - Reading and Writing		

Description

Through these parameters it can select the type of motion to be executed according to [Table 20.7 on page 20-13](#).

Table 20.7: Setting options of the Operation Mode parameters P01151 to P01160

P01151 to P01160	Type of Motion to be Performed
1	Drive in Iq control: commands a Iq current reference (which is proportional to the torque)
2	Drive in Speed Control: commands a speed reference
3 and 4	Relative Positioning: executes the displacement set in relation to the current position
5 and 6	Absolute Positioning: goes to the set position
7	Jog Function: commands a speed reference while the function is active
8	Position Follower: follows the position of the master set
9	Speed Follower: follows the speed of the master set
10	Search Zero Machine Positive Direction: performs a procedure of search zero in the positive direction
11	Search Zero Machine Negative Direction: performs a procedure of search zero in the negative direction

P01161 – Timer of Motion 01

P01162 – Timer of Motion 02

P01163 – Timer of Motion 03

P01164 – Timer of Motion 04

P01165 – Timer of Motion 05

P01166 – Timer of Motion 06

P01167 – Timer of Motion 07

P01168 – Timer of Motion 08

P01169 – Timer of Motion 09

P01170 – Timer of Motion 10

Range:	0 to 32767 ms	Factory Setting:	0
Properties:	RW - Reading and Writing		

Description

Sets the time elapsed between the activation of the motion by the digital input (or parameter P01080) and its execution. If the set value is zero, the movement will be executed immediately.

P01171 – Position Reference (fraction of turn) of Motion 01

P01172 – Position Reference (fraction of turn) of Motion 02

P01173 – Position Reference (fraction of turn) of Motion 03

P01174 – Position Reference (fraction of turn) of Motion 04

P01175 – Position Reference (fraction of turn) of Motion 05

P01176 – Position Reference (fraction of turn) of Motion 06

P01177 – Position Reference (fraction of turn) of Motion 07

P01178 – Position Reference (fraction of turn) of Motion 08

P01179 – Position Reference (fraction of turn) of Motion 09

P01180 – Position Reference (fraction of turn) of Motion 10

Range:	0 to 32767	Factory Setting: 0
Properties:	RW - Reading and Writing	

Description

According to the type of motion set, it executes the function described in [Table 20.8 on page 20-14](#).

Table 20.8: Function of the position reference set (fraction of revolution) in P01171 to P01180 according to the type of motion

Motion Type	Function of Parameters P01171 to P01180
1- Drive in Iq control	Not used
2- Drive in Speed Control	Not used
3 and 4- Relative Positioning	Fraction of turn of the displacement (1 turn = 16384)
5 and 6- Absolute Positioning	Fraction of turn of the target position (1 turn = 16384)
7- Jog Function	Not used
8- Position Follower	Denominator of the position Master-Slave ratio
9- Speed Follower	Denominator of the speed Master-Slave ratio
10- Search Zero Machine Positive Direction	Fraction of turn of the "machine zero" position (1 turn = 16384)
11- Search Zero Machine Negative Direction	Fraction of turn of the "machine zero" position (1 turn = 16384)

P01181 – Position Reference (number of turns) of Motion 01

P01182 – Position Reference (number of turns) of Motion 02

P01183 – Position Reference (number of turns) of Motion 03

P01184 – Position Reference (number of turns) of Motion 04

P01185 – Position Reference (number of turns) of Motion 05

P01186 – Position Reference (number of turns) of Motion 06

P01187 – Position Reference (number of turns) of Motion 07

P01188 – Position Reference (number of turns) of Motion 08

P01189 – Position Reference (number of turns) of Motion 09

P01190 – Position Reference (number of turns) of Motion 10

Range:	-32768 to 32767	Factory Setting: 0
Properties:	RW - Reading and Writing	

Description

According to the type of motion set, it executes the function described in [Table 20.9 on page 20-15](#).

Table 20.9: Function of the position reference set (number of turns) in P01181 to P01190 according to the type of motion

Motion Type	Function of Parameters P01181 to P01190
1- Drive in Iq control	Not used
2- Drive in Speed Control	Not used
3 and 4- Relative Positioning	Number of turns of the displacement
5 and 6- Absolute Positioning	Number of turns of the target position (1 turn = 16384)
7- Jog Function	Not used
8- Position Follower	Numerator of the position Master-Slave ratio (if negative, speed direction according to the master)
9- Speed Follower	Numerator of the position Master-Slave ration (if negative, speed direction opposite the master)
10- Search Zero Machine Positive Direction	Number of turns of the "machine zero" position (1 turn = 16384)
11- Search Zero Machine Negative Direction	Number of turns of the "machine zero" position (1 turn = 16384)

P01191 – Speed Reference/Iq of Motion 01

P01192 – Speed Reference/Iq of Motion 02

P01193 – Speed Reference/Iq of Motion 03

P01194 – Speed Reference/Iq of Motion 04

P01195 – Speed Reference/Iq of Motion 05

P01196 – Speed Reference/Iq of Motion 06

P01197 – Speed Reference/Iq of Motion 07

P01198 – Speed Reference/Iq of Motion 08

P01199 – Speed Reference/Iq of Motion 09

P01200 – Speed Reference/Iq of Motion 10

Range:	-32768 to 32767	Factory Setting: 0
Properties:	RW - Reading and Writing	

Description

According to the type of motion set, it executes function described in [Table 20.10 on page 20-15](#).

Table 20.10: Function of the speed reference/Iq set in P01191 to P01200 according to the type of motion

Motion type	Function of Parameters P01191 to P01200
1- Drive in Iq control	Applied Iq current (proportional to the torque) (1 = 0.1 amp)
2- Drive in Speed Control	Applied speed (rpm)
3 and 4- Relative Positioning	Maximum speed (rpm) at which the positioning will be performed, in case the speed value is negative, the positioning will be executed in the opposite direction in relation to the displacement set
5 and 6- Absolute Positioning	Maximum speed (rpm) at which the positioning will be performed, In case the speed value is negative, the positioning will be executed to the target position with inverted sign in relation to the programmed sign
7- Jog Function	Applied speed (rpm)
8- Position Follower	Not used
9- Speed Follower	Not used
10- Search Zero Machine Positive Direction	Speed (rpm) at which the zero search procedure ⁽¹⁾ will be performed
11- Search Zero Machine Negative Direction	Speed (rpm) at which the zero search procedure ⁽¹⁾ will be performed

⁽¹⁾ The value must be positive.

P01201 – Acceleration of Motion 01

P01202 – Acceleration of Motion 02

P01203 – Acceleration of Motion 03

P01204 – Acceleration of Motion 04

P01205 – Acceleration of Motion 05

P01206 – Acceleration of Motion 06

P01207 – Acceleration of Motion 07

P01208 – Acceleration of Motion 08

P01209 – Acceleration of Motion 09

P01210 – Acceleration of Motion 10

Range:	1 to 32767	Factory Setting:	0
Properties:	RW - Reading and Writing		

Description

According to the type of motion set, it executes the function described in [Table 20.11 on page 20-16](#).

Table 20.11: Function of acceleration set in P01201 to P01210 according to the type of motion

Motion Type	Function of Parameters P01201 to P01210
1- Drive in Iq control	Ramp used (Arms/s) to reach the Iq current set
2- Drive in Speed Control	Acceleration (rpm/s) used to reach the speed set
3 and 4- Relative Positioning	Acceleration (rpm/s) used to reach the maximum speed at which the positioning is performed
5 and 6- Absolute Positioning	Acceleration (rpm/s) used to reach the maximum speed at which the positioning is performed
7- Jog Function	Acceleration (rpm/s) used to reach the speed set
8- Position Follower	Acceleration (rpm/s) used to reach the master-slave synchronism
9- Speed Follower	Acceleration (rpm/s) used to reach the master-slave synchronism
10- Search Zero Machine Positive Direction	Not used
11- Search Zero Machine Negative Direction	Not used

P01211 – Deceleration of Motion 01

P01212 – Deceleration of Motion 02

P01213 – Deceleration of Motion 03

P01214 – Deceleration of Motion 04

P01215 – Deceleration of Motion 05

P01216 – Deceleration of Motion 06

P01217 – Deceleration of Motion 07

P01218 – Deceleration of Motion 08

P01219 – Deceleration of Motion 09

P01220 – Deceleration of Motion 10

Range: 1 to 32767 **Factory Setting:** 0

Properties: RW - Reading and Writing

Description

According to the type of motion set, it executes the function described in [Table 20.12 on page 20-17](#).

Table 20.12: Function of deceleration set in P01211 to P01220 according to the type of motion

Motion Type	Function of Parameters P01211 to P01220
1- Drive in Iq control	Not used
2- Drive in Speed Control	Deceleration (rpm/s) used in to reach the speed set
3 and 4- Relative Positioning	Deceleration (rpm/s) used at the stop of the positioning
5 and 6- Absolute Positioning	Deceleration (rpm/s) used at the stop of the positioning
7- Jog Function	Deceleration (rpm/s) used at the stop of the motion
8- Position Follower	Deceleration (rpm/s) used to reach the master-slave synchronism
9- Speed Follower	Deceleration (rpm/s) used to reach the master-slave synchronism
10- Search Zero Machine Positive Direction	Not used
11- Search Zero Machine Negative Direction	Not used

P01221 – Jerk of Motion 01

P01222 – Jerk of Motion 02

P01223 – Jerk of Motion 03

P01224 – Jerk of Motion 04

P01225 – Jerk of Motion 05

P01226 – Jerk of Motion 06

P01227 – Jerk of Motion 07

P01228 – Jerk of Motion 08

P01229 – Jerk of Motion 09

P01230 – Jerk of Motion 10

Range: 0 to 32767 **Factory Setting:** 0

Properties: RW - Reading and Writing

Description

According to the type of motion set, it executes the function described in [Table 20.13 on page 20-17](#).

Table 20.13: Function of the jerk set in P01221 to P01230 according to the type of motion

Motion Type	Function of Parameters P01221 to P01230
1- Drive in Iq control	Not used
2- Drive in Speed Control	Jerk (rpm/s ²) used to reach the acceleration/deceleration set
3 and 4- Relative Positioning	Jerk (rpm/s ²) used to reach the acceleration/deceleration set
5 and 6- Absolute Positioning	Jerk (rpm/s ²) used to reach the acceleration/deceleration set
7- Jog Function	Jerk (rpm/s ²) used to reach the acceleration/deceleration set
8- Position Follower	Not used
9- Speed Follower	Not used
10- Search Zero Machine Positive Direction	Not used
11- Search Zero Machine Negative Direction	Not used

20.3 EXAMPLES

Example 1:

The user needs a setting to make the SCA06 execute a referencing when a digital input is activated. This zero search will be performed in the negative direction, and it will be considered the rising edge of the ZMS. The position of the ZMS is considered to be the zero position. After the zero search is performed, the user wants the motor to go to the 1 turn position automatically (no new command).

When another digital input is activated, a first displacement to the 5.5 turn position must be performed, and when this same input is activated a second time, a displacement of return to position 1 is executed. The enabling of the drive will take place through parameter P00099.

Setting:

Cycle 1: It will make the referencing, which consists of two motions: one for zero search and another for the displacement up to 1 turn position 1. The drive will take place through digital input 3, and the zero sensor will be connected to digital input 2.

- Setting of cycle 1: (activated by the digital input 3).
 - P01075 = 1 (only the ZMS search is performed).
 - P01101 = 1 (first motion of the sequence of cycle 1 is motion 1).
 - P01102 = 2 (second motion of the sequence of cycle 1 is motion 2).
 - P01103 = 0 (end of the cycle).

Cycle 2: It will execute the machine normal motion, which consists of two motions: one forward and one reverse.

- Setting of cycle 2: (activated by digital input 1).
 - P01106 = 3 (first motion of the sequence of cycle 2 is motion 3).
 - P01107 = 4 (second motion of the sequence of cycle 2 is motion 4).
 - P01108 = 0 (end of the cycle).

Setting of the digital inputs:

ED1: activates the forward and reverse.
P01081 = 2 (activation cycle 2).

ED2: it will be connected to the zero machine sensor (ZMS).
P00301 = 8 (sets ED2 to be the ZMS input).
P01076 = 0 (sets the active edge of the ZMS as rising edge).

ED3: activates the referencing.
P01083 = -1 (activation cycle 1 completed, because the value is negative).

- **Motion 1:**
 - P01151 = 11 (search zero Machine in negative direction).
 - P01161 = 0 (does not wait, performs the motion immediately).
 - P01171 = 0 (see P01181).
 - P01181 = 0 (at the end of the procedure of search zero position, the position is reset).
 - P01191 = 100 (the zero search will take place with a speed of 100 rpm).

■ Motion 2:

- P01152 = 5 (absolute positioning).
- P01162 = 1000 (waits for 1 s before starting the motion).
- P01172 = 0 (see P01181).
- P01182 = 1 (advances up to the turn 1 position fraction of turn 0).
- P01192 = 200 (the positioning is performed with a speed of 200 rpm).
- P01202 = 1000 (the positioning is performed with an acceleration of 1000 rpm/s).
- P01212 = 1000 (the positioning is performed with a deceleration of 1000 rpm/s).
- P01222 = 0 (the positioning is without jerk).

■ Motion 3:

- P01153 = 5 (absolute positioning).
- P01163 = 0 (does not wait; performs the motion immediately).
- P01173 = 8192 (see P01181).
- P01183 = 5 (advances up to lap 5 position fraction of turn 8192 = 5.5 laps).
- P01193 = 3000 (the positioning is performed with a speed of 3000 rpm).
- P01203 = 10000 (the positioning is performed with an acceleration of 10000 rpm/s).
- P01213 = 10000 (the positioning is performed with a deceleration of 10000 rpm/s).
- P01223 = 100000 (the positioning is performed with a jerk of 100000 rpm/s²).

■ Motion 4:

- P01154 = 5 (absolute positioning).
- P01164 = 0 (does not wait; performs the motion immediately).
- P01174 = 0 (see P01181).
- P01184 = 1 (advances up to lap 1 position fraction of turn 0 = 1.0 laps).
- P01194 = 3000 (the positioning is performed with a speed of 3000 rpm).
- P01204 = 10000 (the positioning is performed with an acceleration of 10000 rpm/s).
- P01214 = 10000 (the positioning is performed with a deceleration of 10000 rpm/s).
- P01224 = 100000 (the positioning is performed with a jerk of 100000 rpm/s²).

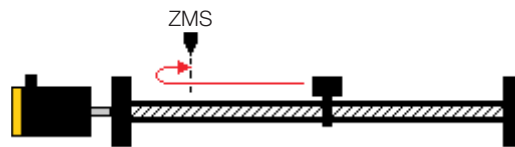

Figure 20.6: Cycle 1 – Motion 1: searches the ZMS

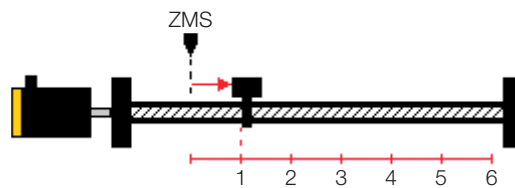

Figure 20.7: Cycle 1 – Motion 2: advances to lap 1 position

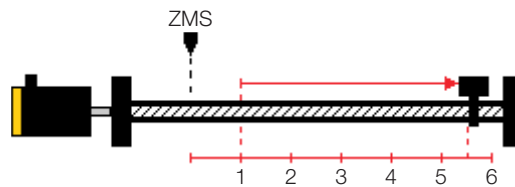

Figure 20.8: Cycle 2 – Motion 3: advances to lap 5.5 position

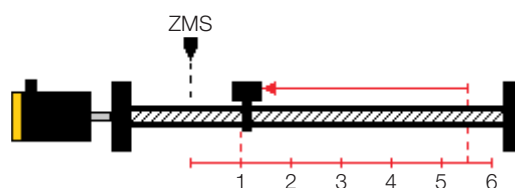

Figure 20.9: Cycle 2 – Motion 4: advances to lap 1 position

When digital input 3 (ED3) is activated only once, motions 1 and 2 are performed (due to the setting in complete cycle), and there is a 1-second wait between the motions.

When digital input 1 (EDI 1) is activated, motion 3 is executed; when it is activated again, motion 4 is executed; when it is activated again, motion 3 is repeated, and so on.

Example 2:

The user needs a setting to activate, via digital inputs, the following functions:

- Enable drive.
- Disable by external fault.
- Fault reset.
- Motion in speed.
- 2 recipes: each one with 2 forward displacement positionings.

In order to do so, we will use the EIO1 accessory connected to slot 2.

Setting:

Cycle 1: will perform the motion in speed. The activation will be by digital input ED204.

- Setting of cycle 1:
 - P01101 = 1 (first motion of the sequence of cycle 1 is motion 1).
 - P01102 = 2 (second motion of the sequence of cycle 1 is motion 2).
 - P01103 = 0 (end of the cycle).

Cycle 2: will perform recipe 1. The activation will be through digital input ED206.

- Setting of cycle 2:
 - P01106 = 3 (first motion of the sequence of cycle 2 is motion 3).
 - P01107 = 4 (second motion of the sequence of cycle 2 is motion 4).
 - P01108 = 0 (end of the cycle).

Cycle 3: will perform recipe 2. The activation will be through digital input ED207.

- Programação do ciclo 3:
 - P01111 = 5 (first motion of the sequence of cycle 3 is motion 5).
 - P01112 = 6 (second motion of the sequence of cycle 3 is motion 6).
 - P01113 = 0 (end of the cycle).

Setting of the digital inputs:

Selection of SLOT 2: P01070 = 2.

Activation by edge: P01077 = 0.

Filter of 1 ms for EDs: P01078 = 1.

- ED201:** enable drive.
P00315 = 1.
- ED202:** disable by external fault.
P00316 = 20.
- ED203:** faults reset.
P00317 = 6.
- ED204:** activate cycle 1.
P01084 = 1.
- ED206:** activate cycle 2.
P01086 = 2.
- ED207:** activate cycle 3.
P01087 = 3.

■ **Motion 1:**

- P01151 = 2 (drive in speed control).
- P01161 = 0 (does not wait; performs the motion immediately).
- P01191 = 50 (sets the motion speed, in this case 50 rpm).
- P01201 = 1000 (acceleration of 1000 rpm/s).
- P01211 = 1000 (deceleration of 1000 rpm/s).
- P01221 = 0 (without jerk).

■ **Motion 2:**

- P01152 = 3 (relative positioning).
- P01162 = 0 (does not wait; performs the motion immediately).
- P01172 = 4096 (see P01182).
- P01182 = 0 (performs a displacement of 1/4 lap, finishing the motion in speed).
- P01192 = 50 (the displacement is performed with a speed of 50 rpm).
- P01202 = 1000 (the displacement is performed with an acceleration of 1000 rpm/s).
- P01212 = 1000 (the displacement is performed with a deceleration of 1000 rpm/s).
- P01222 = 0 (the displacement is without jerk).

■ **Motion 3:**

- P01153 = 3 (relative positioning).
- P01163 = 0 (does not wait; performs the motion immediately).
- P01173 = 0 (see P01183).
- P01183 = 5 (performs a displacement of 5 laps; here, along with P01173, the value of this first motion of recipe 1 is set).
- P01193 = 3000 (the displacement is performed with a speed of 3000 rpm).
- P01203 = 10000 (the displacement is performed with an acceleration of 10000 rpm/s).
- P01213 = 10000 (the displacement is performed with a deceleration of 10000 rpm/s).
- P01223 = 0 (the displacement is without jerk).

■ **Motion 4:**

- P01154 = 3 (relative positioning).
- P01164 = 0 (does not wait; performs the motion immediately).
- P01174 = 0 (see P01184).
- P01184 = 10 (performs a displacement of 10 laps; here, along with P01174, the value of this second motion of the recipe 1 is set).
- P01194 = 3000 (the displacement is performed with a speed of 3000 rpm).
- P01204 = 10000 (the displacement is performed with an acceleration of 10000 rpm/s).
- P01214 = 10000 (the displacement is performed with a deceleration of 10000 rpm/s).
- P01224 = 0 (the displacement is without jerk).

■ Motion 5:

P01155 = 3 (relative positioning).

P01165 = 0 (does not wait; performs the motion immediately).

P01175 = 8192 (see P01185).

P01185 = 4 (performs a displacement of 4.5 laps; here, along with P01175, the value of this first motion of recipe 2 is set).

P01195 = 3000 (the displacement is performed with a speed of 3000 rpm).

P01205 = 10000 (the displacement is performed with an acceleration of 10000 rpm/s).

P01215 = 10000 (the displacement is performed with a deceleration of 10000 rpm/s).

P01225 = 0 (the displacement is without jerk).

■ Motion 6:

P01156 = 3 (relative positioning).

P01166 = 0 (does not wait; performs the motion immediately).

P01176 = 4096 (see P01186).

P01186 = 6 (performs a displacement of 6.25 laps; here, along with P01176, the value of this second motion of the recipe 2 is set).

P01196 = 3000 (the displacement is performed with a speed of 3000 rpm).

P01206 = 10000 (the displacement is performed with an acceleration of 10000 rpm/s).

P01216 = 10000 (the displacement is performed with a deceleration of 10000 rpm/s).

P01226 = 0 (the displacement is without jerk).

When the digital input ED204 is activated only once, the motor begins to spin at the speed set (motion 1), and when drive it is activated again, the motor stops (motion 2).

When the digital ED206 is activated only once, the first motion of the recipe 1 is executed, and when it is activated again, the second motion is executed.

When the digital ED207 is activated only once, the first motion of the recipe 2 is executed, and when it is activated again, the second motion is executed.