

SSW07

Soft Starter

- Tough
- Reliable
- Durable
- Quality

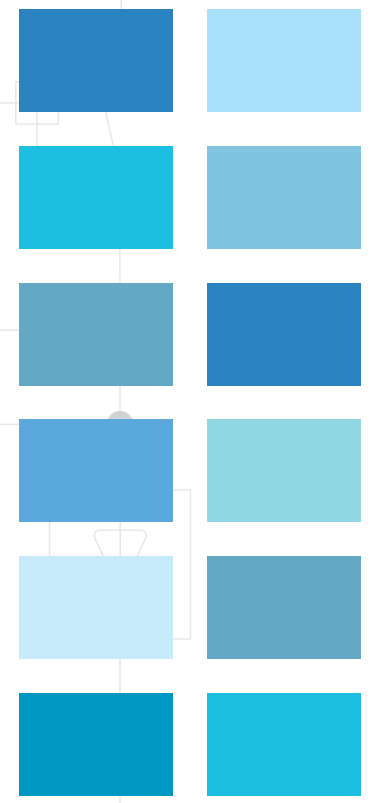
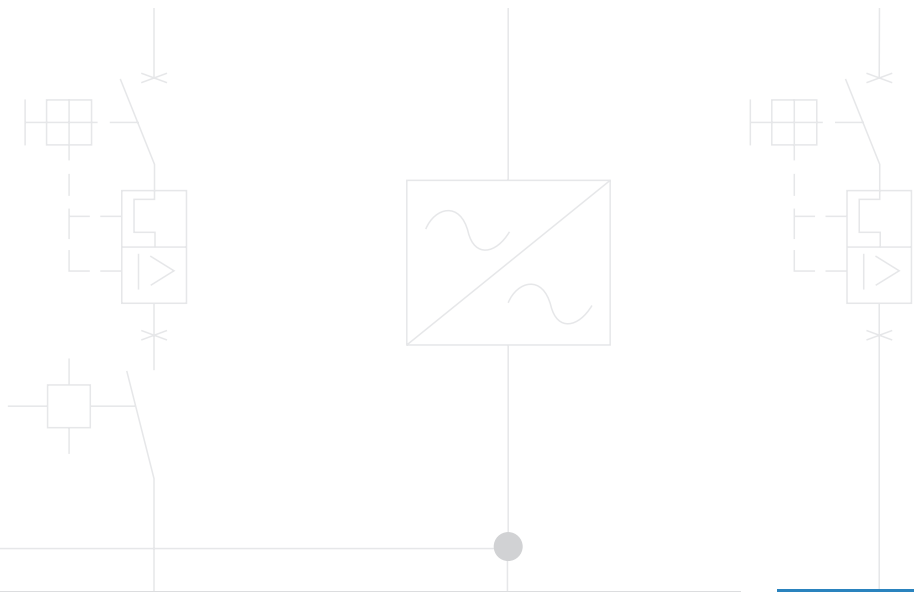

LED FAULT	LED READY	FAULT DESCRIPTION
1x	OFF	FREQUENCY RANGE
1a	ON	OVERTEMPERATURE
2x	OFF	UNDERVOLTAGE
2a	ON	START TIMEOUT
3a	OFF	BY-PASS OPEN
4a	OFF	OVERCURRENT BEFORE BY-PASS
5a	OFF	BY-PASS OVERCURRENT

M
USASSW07.11/2020

M
3



Soft Starters

SSW07

Soft Starters are static starting devices, designed for the acceleration, deceleration and protection of the three phase, electric induction motor through the control of the voltage applied to the motor. The SSW07, with DSP control (Digital Signal Processor), was designed to provide great performance on motor starts and stops with an excellent cost-benefit relationship. Because it is easy to set up, it simplifies start-up activities and daily operation. The SSW07 is compact, optimizing space in electric panels. The SSW07 incorporates all electric motor protection classification and adapts to customer needs through its easy-to-install optional accessories. Such as, a keypad, a communication interface or a motor PTC input.



Applications

- Chemical and Petrochemical
- Plastic and Rubber
- Pulp and Paper
- Sugar and Alcohol
- Beverages
- Cement and Mining
- Food and Ration
- Textile
- Metallurgy
- Ceramics
- Glass
- Refrigeration
- Wood
- Sanitation
- Conveyors

Standard Features

- Significant reduction in mechanical stresses of the coupling and transmission devices (gearboxes, pulleys, gears, conveyors, etc.) during start
- Increases motor and equipment lifetime due to the elimination of mechanical shock
- Easy operation, setup, maintenance & installation
- Operates in environments up to 55°C (without derate for all models)
- Integral, electronic motor protection
- Built-in electronic thermal relay
- Avoids the "Water Hammer" in pumps
- Limitation of voltage drop during start
- Universal voltage (220 to 575 Vac)
- Switched type power supply with EMC filter for the control electronics (110 to 240 Vac)
- Thermal monitoring of both motor and soft starter

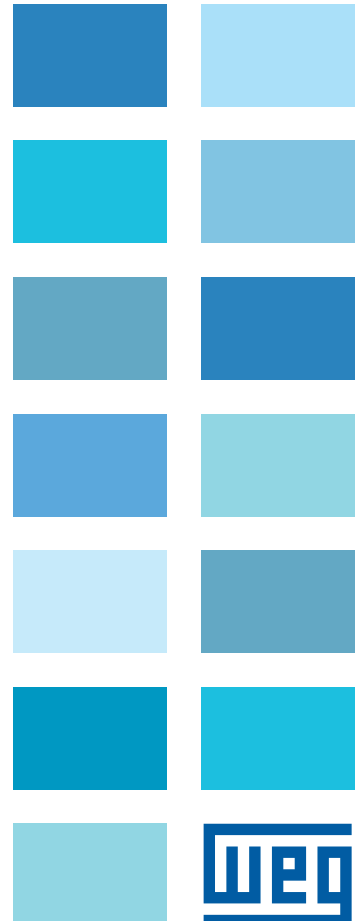



Soft Starters - SSW07

IP20 Frame Size 1 and 2, IP00 Frame Size 3

Protected Chassis Enclosure

Motor Voltage	Motor HP ¹	Starter Amps ²	Current Catalog Number ³	Future Catalog Number ³	Frame Size	Dimensions (in.) HxWxD	Approx. Weight (lbs.)
230 Vac	Input Power Supply: Three-Phase 230 Vac						
	5	17	SSW070017T5SZ	-	1	6.4 x 2.3 x 5.7	2.9
	7.5	24	SSW070024T5SZ	-	1	6.4 x 2.3 x 5.7	2.9
	10	30	SSW070030T5SZ	-	1	6.4 x 2.3 x 5.7	2.9
	15	45	SSW070045T5SZ	-	2	8.2 x 5.6 x 8.0	7.3
	25	61	SSW070061T5SZ	-	2	8.2 x 5.6 x 8.0	7.3
	30	85	SSW070085T5SZ	-	2	8.2 x 5.6 x 8.0	7.3
	50	130	SSW070130T5SZ	-	3	10.9 x 8.6 x 8.7	16.8
	60	171	SSW070171T5SZ	-	3	10.9 x 8.6 x 8.7	16.8
	75	200	SSW070200T5SZ	-	3	10.9 x 8.6 x 8.7	16.8
	100	255	SSW070255T5SZ	SSW070255T5SH1Z	4	13.0 x 9.0 x 9.6	28.2
	125	312	SSW070312T5SZ	SSW070312T5SH1Z	4	13.0 x 9.0 x 9.6	28.2
	150	365	SSW070365T5SZ	SSW070365T5SH1Z	4	13.0 x 9.0 x 9.6	28.2
	150	412	SSW070412T5SZ	SSW070412T5SH1Z	4	13.0 x 9.0 x 9.6	28.2
460 Vac	Input Power Supply: Three-Phase 460 Vac						
	10	17	SSW070017T5SZ	-	1	6.4 x 2.3 x 5.7	2.9
	15	24	SSW070024T5SZ	-	1	6.4 x 2.3 x 5.7	2.9
	20	30	SSW070030T5SZ	-	1	6.4 x 2.3 x 5.7	2.9
	30	45	SSW070045T5SZ	-	2	8.2 x 5.6 x 8.0	7.3
	40/50	61	SSW070061T5SZ	-	2	8.2 x 5.6 x 8.0	7.3
	75	85	SSW070085T5SZ	-	2	8.2 x 5.6 x 8.0	7.3
	100	130	SSW070130T5SZ	-	3	10.9 x 8.6 x 8.7	16.8
	125	171	SSW070171T5SZ	-	3	10.9 x 8.6 x 8.7	16.8
	150	200	SSW070200T5SZ	-	3	10.9 x 8.6 x 8.7	16.8
	200	255	SSW070255T5SZ	SSW070255T5SH1Z	4	13.0 x 9.0 x 9.6	28.2
	250	312	SSW070312T5SZ	SSW070312T5SH1Z	4	13.0 x 9.0 x 9.6	28.2
	300	365	SSW070365T5SZ	SSW070365T5SH1Z	4	13.0 x 9.0 x 9.6	28.2
	350	412	SSW070412T5SZ	SSW070412T5SH1Z	4	13.0 x 9.0 x 9.6	28.2
575 Vac	Input Power Supply: Three-Phase 575 Vac						
	15	17	SSW070017T5SZ	-	1	6.4 x 2.3 x 5.7	2.9
	20	24	SSW070024T5SZ	-	1	6.4 x 2.3 x 5.7	2.9
	30	30	SSW070030T5SZ	-	1	6.4 x 2.3 x 5.7	2.9
	40	45	SSW070045T5SZ	-	2	8.2 x 5.6 x 8.0	7.3
	60	61	SSW070061T5SZ	-	2	8.2 x 5.6 x 8.0	7.3
	75	85	SSW070085T5SZ	-	2	8.2 x 5.6 x 8.0	7.3
	125	130	SSW070130T5SZ	-	3	10.9 x 8.6 x 8.7	16.8
	175	171	SSW070171T5SZ	-	3	10.9 x 8.6 x 8.7	16.8
	200	200	SSW070200T5SZ	-	3	10.9 x 8.6 x 8.7	16.8
	250	255	SSW070255T5SZ	SSW070255T5SH1Z	4	13.0 x 9.0 x 9.6	28.2
	300	312	SSW070312T5SZ	SSW070312T5SH1Z	4	13.0 x 9.0 x 9.6	28.2
	350	365	SSW070365T5SZ	SSW070365T5SH1Z	4	13.0 x 9.0 x 9.6	28.2
	400	412	SSW070412T5SZ	SSW070412T5SH1Z	4	13.0 x 9.0 x 9.6	28.2

Notes:

- 1) "HP" rating based on FLA values from WEG W22, 2 and 4 pole, NEMA Premium motors.
- 2) Motor FLA may vary with speed and manufacturer. ALWAYS compare motor FLA to Nominal AMPS of starter.
- 3) The "Current Catalog Number" will be replaced by "Future Catalog Number" in Second half of 2021. The Product will remain the same.

Options and Accessories

Type	Catalog Number	Description	Approx. Weight (lbs.)
Keypad	SSW07-08-HMI-LOC	Local Keypad - Mounts on SSW07 Soft Starter	1.1
	SSW07-HMI-REM	Remote Keypad Kit - Includes HMI and Interface Module	3.1
	SSW07-HMI-REM-485	Remote Keypad Kit - Includes HMI RS485 Comm. Card	3.8
Remote Cable	CAB-RS-1	3.3 ft (1 meter) Remote Keypad Cable	0.5
	CAB-RS-2	6.6 ft (2 meter) Remote Keypad Cable	0.7
	SSW05-07-08-CRS-3M	9.9 ft (3 meter) Remote Keypad Cable	1.0
	SSW05-07-08-CRS-5M	16 ft (5 meter) Remote Keypad Cable	1.2
	CAB-RS-7.5	25 ft (7.5 meter) Remote Keypad Cable	1.5
	CAB-RS-10	33 ft (10 meter) Remote Keypad Cable	2.0
Communication	SSW07-08-KRS-232	RS-232 Communication Kit	1.6
	SSW07-08-KRS-485	RS-485 Communication Kit	1.6
	CAB-COMM-3	Cable for Communication RS232 (DB9-DB9) - 9.9ft. (3 meter)	1.1
	CAB-COMM-10	Cable for Communication RS232 (DB9-DB9) - 33 ft (10 meter)	2.0
	KFB-DN-SSW07	DeviceNet Communication Kit plus Remote HMI Connection	2.3
Kits	SSW0708900-KVT-2B ¹	Ventilation Kit M2 (Frame Size 2, 45 to 85A)	1.4
	SSW0708900-KVT-3C ¹	Ventilation Kit M3 (Frame Size 3, 130 to 200A)	1.4
	SSW07-08-KPTC-MTR	PTC Kit for motor	0.8
	SSW0708900-IP20-3C	IP20 Kit for M3 (Frame Size 3, 130 to 200A)	1.1
	SSW0708900-IP20-4D	IP20 Kit for M4 (Frame Size 4, 255 to 412A)	1.1
	KSDG2-SSW07	Superdrive G2 Kit (Includes KRS-232-SSW07, CAB-COMM-3, CD Software)	1.9

Notes:

1) M2 and M3 Ventilation Kit Cooling Fans require 120 Vac Single-Phase Power

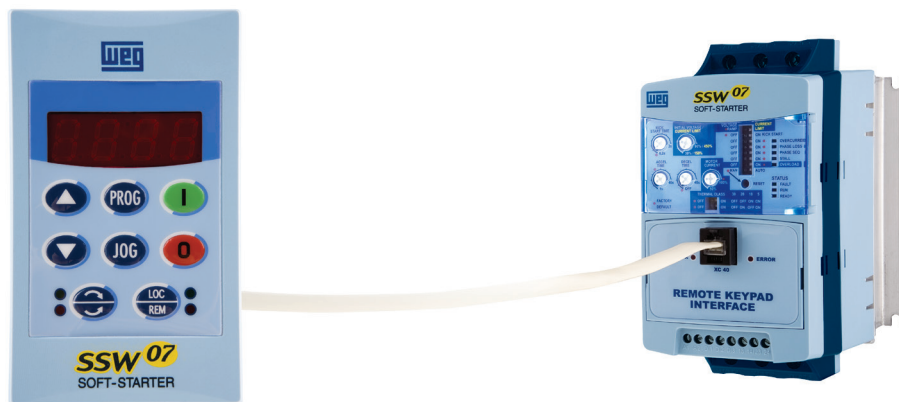

HMI-REMOTE-SSW07; REMOTE KEYPAD



Soft Starters SSW07



SSW07 – Programming Features

All programming necessary for starting any type of load is available through trimpots and dip-switch.

Voltage Ramp

Permits smooth acceleration and/or deceleration, through voltage ramps.

Current Limit

Current limit during the start according to the application requirements.

Voltage Kick Start

Enables an initial voltage boost which, provides initial starting torque.

This is necessary for starting high breakway torque loads.

Built in By Pass

Built-in by-pass minimizes power loss and heat dissipation in the thyristors, providing size reduction and contributing to energy saving. This is available in all models.

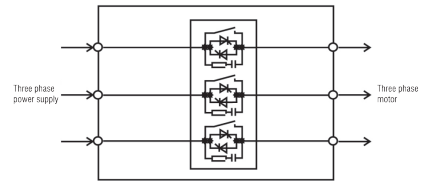
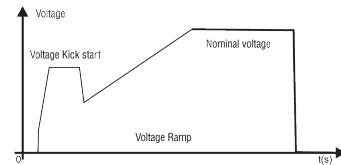
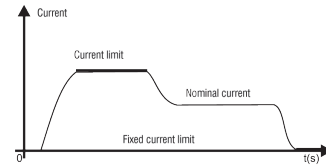
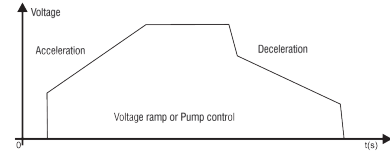

Starting Method Comparison

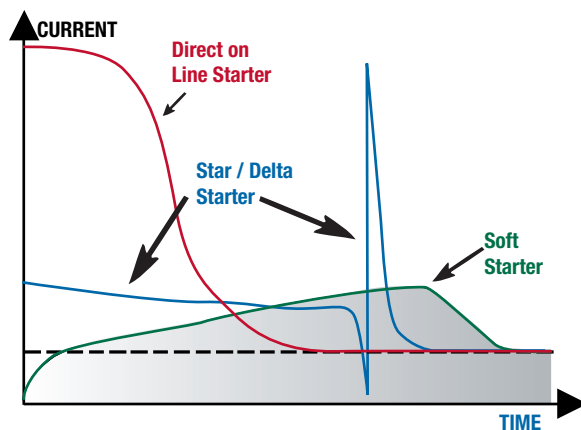

Typical Starters

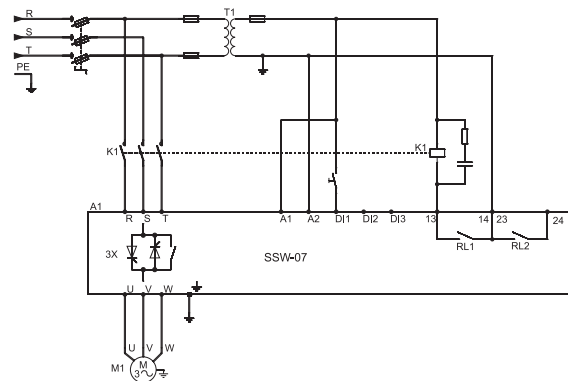

Dimensions and Weights

SSW07 Model	Height H mm(In)	Width L mm(In)	Depth.P mm(In)	A mm(In)	B mm(In)	C mm(In)	D mm(In)	Fixing screw	Weight kg (lb)	Enclosure
SSW070017 SSW070024 SSW070030	162 (6.38)	95 (3.74)	157 (6.18)	85 (3.35)	120 (4.72)	5 (0.2)	4 (0.16)	M4	1.3 (2.9)	IP20
SSW070045 SSW070061 SSW070085	208 (8.19)	144 (5.67)	203 (7.99)	132 (5.2)	148 (5.83)	6 (0.24)	3.4 (0.13)	M4	3.3 (7.28)	IP20
SSW070130 SSW070171 SSW070200	276 (10.9)	223 (8.78)	220 (8.66)	208 (8.19)	210 (8.27)	7.5 (0.3)	5 (0.2)	M5	7.6 (16.8)	IP00*
SSW070255 SSW070312 SSW070365 SSW070412	331 (13)	227 (8.94)	242 (9.53)	200 (7.87)	280 (11.0)	15 (0.59)	9 (0.35)	M8	11.5 (25.4)	IP00 *

Table 3.1 Data for installation with dimensions in mm (in)
*Option for IP20 Kit

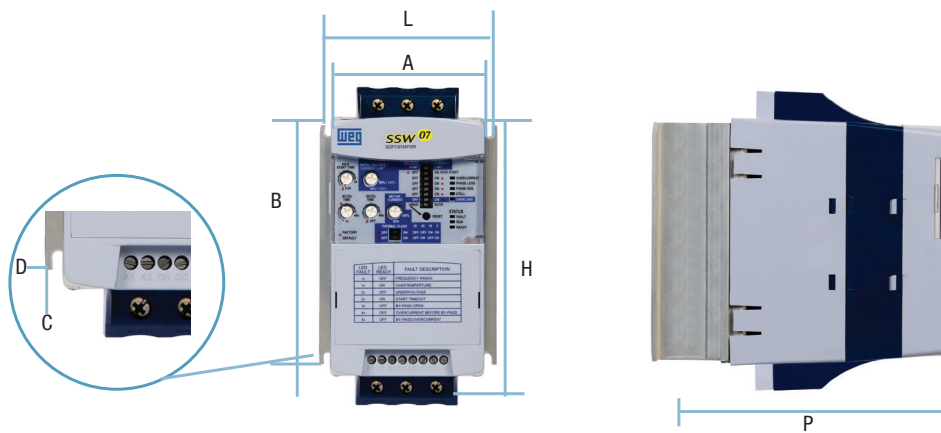

Soft Starters

SSW07

Accessories and Options

The SSW07 Soft Starters can be interconnected to “FieldBus” communication networks, through Modbus RTU protocol. Designed to integrate large industrial automation plants, the communication networks provide advantages in supervision, monitoring and control, over the Soft Starters. This provides high performance and great operating flexibility, which is demanded for complex or integrated system applications. For connection to modbus type communication networks, the SSW07 has an optional connector on the front of the product.

SSW07-08-HMI-LOC

The MMI with 7-segment LED display allows the operator to monitor the SSW07 from a distance. The keypad includes a “Copy” function, which permits the user to copy the parameters from one SSW07 to another, providing fast programming, reliability and repeatability in serial manufacturing machinery.



Plug-in type MMI in front of product.

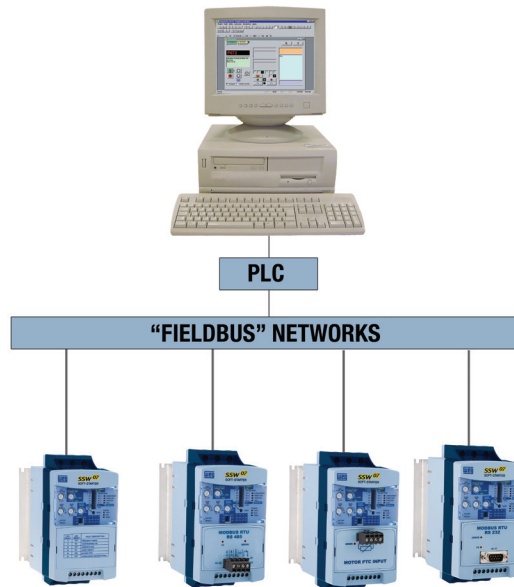

KSDG2-SSW07

Software in Windows platform, for SSW07 parameterization, command and monitoring.

- SSW07 automatic identification
- Reads SSW07 parameters
- Writes parameters in SSW07
- Edits online parameters in SSW07
- Edits offline parameters in PC
- Enables creation of all application documentation
- Easily accessible
- Enables programming, command and monitoring of the SSW07
- Supplied with a 10 ft RS-232 serial cable when the Superdrive G2 software is acquired
- Free version available at WEG's website www.weg.net



Soft Starters

SSW07

SSW07 – Accessories and Options

SSW07-HMI-REM

Remote HMI for placing in panel door or machinery console.

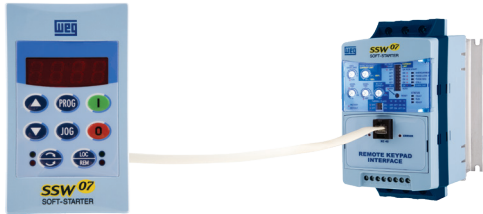

Cable for connecting MMI to SSW07.
Cable length: 1, 2, 3, 5, 7.5 and 10m.

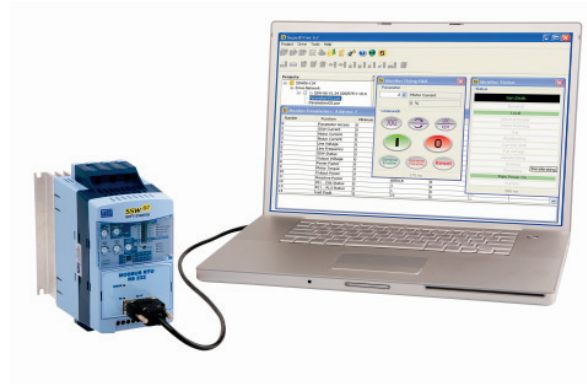

SSW05-07-08-CRS-3M

Cable for connecting RS-232.
Cable length in 3 and 10m.



COMMUNICATION MODULES

Modbus RTU connection.



SSW07-08-KPTC-MTR

Optional module for motor PTC connection.



SSW0708900-IP20-3C or SSW0708900-IP20-4D

For models from 45 A to 200 A. A ventilation kit is necessary for heavy duty starting cycle.

Soft Starters SSW07

Applications and Indications

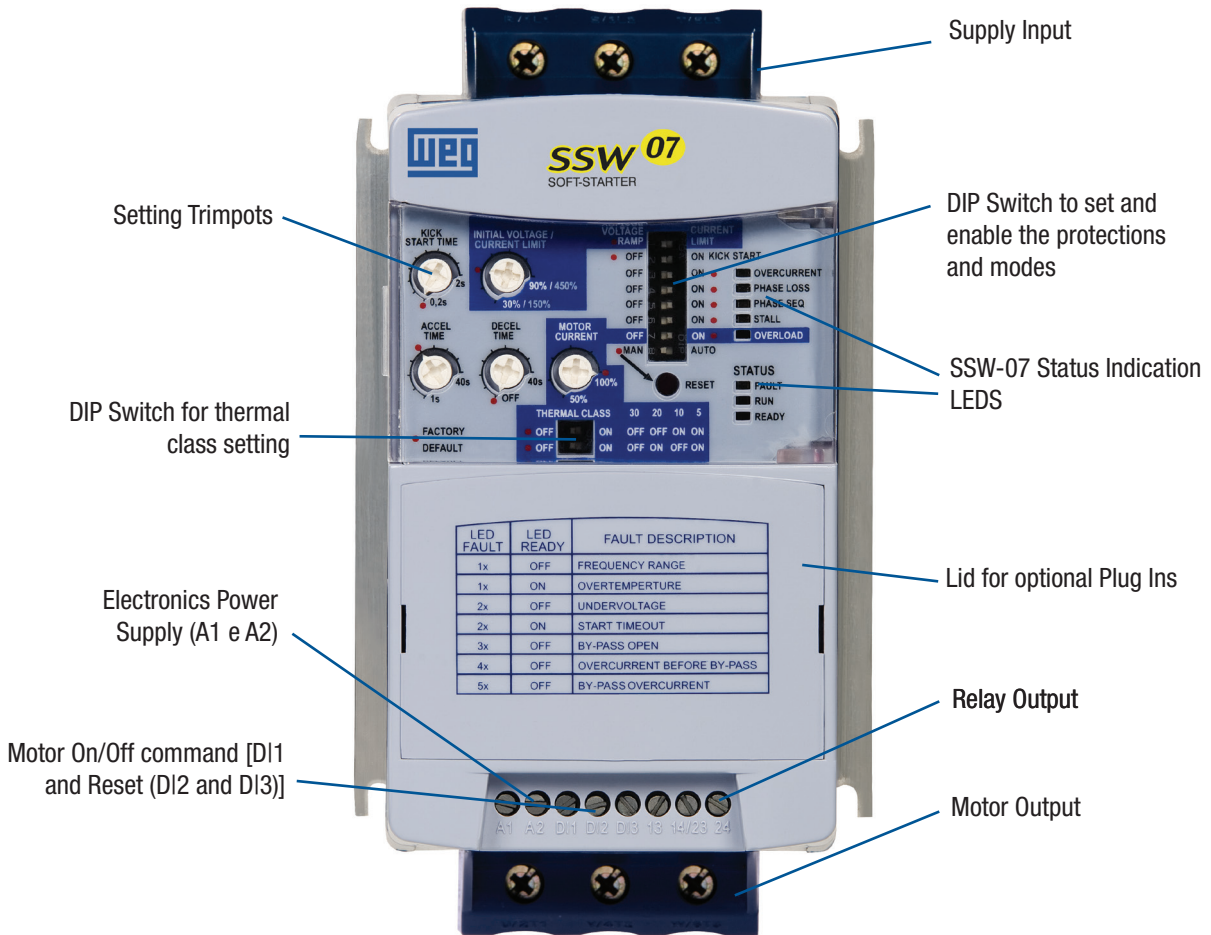

Soft Starters

SSW07

Technical Specifications

Power Supply	Power	220 to 575 Vac (-15% to +10%)		
	Control	For models from 17 A to 200 A: 110 to 240 Vac (-15 % to +10 %) For models from 255 A to 412 A with "H1" in Part Number: 110 to 130 Vac (-15 % to +10 %)		
	Frequency	50 to 60 Hz (+/- 10%), or 45 to 66 Hz		
Enclosure	Injected plastic	IP20 in models from 17 to 85 A		
		IP00 in models from 130 to 200 A (IP20 as option)		
Control	Control Method	Voltage variation over the load (three-phase induction motor)		
	CPU	DSP type microcontroller (Digital Signal Processor)		
	Types of Control	Voltage ramp		
Current limit				
Starting Cycle (1)	Normal	300% for 30 s, 10 starts per hour (every 6 minutes) ¹		
Inputs	Digital	3 isolated programmable inputs		
Outputs	Relay	12 relays with NO contacts, 240Vac, 1A, programmable functions		
Safety	Protections (Standard)	Overcurrent;	Locked Rotor	
		Overcurrent before By-pass	Excess starting time	
		Phase loss;	Over/Under Frequency	
		Inverted phase sequence;	By-pass contact open	
		Overtemperature in power heatsink;	Undervoltage in control supply	
		Motor Overload (class 5 to 30)		
	Protections (with Accessory)	Undercurrent	Programming error	
		Current imbalance	Serial communication error	
		Subcurrent before By-pass	MMI communication error	
		External defects	Overtemperature in motor PTC	
Functions	Standard	Voltage ramp (Initial voltage: 30% to 90%)		
		Current limitation (150% to 450% of SSW-07 rated current)		
		Starting time (1 to 40s)		
		Kick Start (Off - 0,2 to 2s)		
		Deceleration ramp (0 to 40s)		
		Motor and SSW-07 current relation (50% to 100%)		
		Faults auto-reset		
		Thermal memory auto-reset		
		Factory standard reset		
		Soft-starter built-in By-pass		

¹ For the 45 to 200 A currents using the ventilation kit.

Soft Starters

SSW07

Technical Specifications

Programming	Command	On, Off / Reset and Function Programming
	Additional Functions	Starting time up to 240s
		Deceleration time up to 240s
		Program enabling password
		Selection for Local / Remote operation
		COPY function (SSW-07 >>> MMI and MMI >>> SSW-07)
		Programmable rated voltage
	Supervision (Reading)	Motor current (%Soft-Starter In)
		Motor current (%motor In)
		Motor current (A)
		Current indication in each phase R-S-T
		Supply network frequency
		Apparent power supplied to load (kVA)
		Soft-Starter status
		Digital input and output status
Back up of 4 last errors		
Soft-Starter Software Version		
Heatsink temperature		
Motor thermal protection status		
Accessories and Options	Options	Plug-in type local MMI
		MMI remote Kit
		1,2,3,5,7.5 and 10m for remote MMI interconnection
		RS-232 communication kit
		SSW-07 interconnection cables>>> PC Serial (RS-232) 3 and 10m
		RS-485 communication kit
		Motor PTC kit
		Ventilation kit for size 2 (45 to 85 A)
		Ventilation kit for size 3 (130 to 200 A)
		IP20 kit for size 3 (130 to 200 A) and size 4 (255 to 412A)
Finishing	Color	Lid: Gray Ultra Mat
		Cabinet: Blue Ultra Mat
Conformities / Standards	Safety	UL 508 Standard- Industrial Control Equipment
	Low voltage	EN60947-4-2;LVD 2006/95/EC Standard – Low voltage Directive
	EMC	EMC 89/336/EEC Directive – Industrial Environment
	UL (USA) / cUL (Canada)	Underwriters Laboratories Inc. – USA
	CE (Europe)	Conformity test conducted by EPCOS
	C-Tick (Australia)	Australian Communication Authority
	GOST (Russia)	





**24/7 Technical
Support**

for Drives and Soft Starters

1-877-WEG-DRIV
(934-3748)

www.weg.net



WEG Electric Corp.
6655 Sugarloaf Parkway
Duluth, GA 30096
Phone: 1-800-ASK-4WEG
web: www.weg.net

Please contact your authorized distributor:

USASSW07.11.2020