

# YASKAWA

# FP605

INDUSTRIAL FAN AND PUMP DRIVE

IT'S PERSONAL



# EXCEEDING YOUR ENERGY EXPECTATIONS

Yaskawa has produced millions of drives to operate motors to meet exact system demands to reliably save energy. Yaskawa drives supply fresh air and water to countless people all over the world.

At Yaskawa, we strive to provide quality products and service that exceed the expectations of our customers. The FP605 is an easy to install and configure industrial fan and pump drive. The FP605 is used in countless applications, including centrifugal compressors, fans, pumps, and process control in industries such as material handling, food and beverage, chemical, rubber and plastics, textile and printing. The FP605 is a versatile industrial fan and pump drive that saves time and resources on installation and programming, while maximizing efficiency for peak energy savings and the return on your investment



**ENERGY SAVING**  
**AMAZING PERFORMANCE**  
**SIMPLE TO USE**  
**YASKAWA QUALITY**

## Industry Leading Quality and Reliability

### W. EDWARDS DEMING PRIZE

Yaskawa Electric Corporation - parent company of Yaskawa America - is the proud recipient of the W. Edward Deming Prize. We remain the only company in the world, in our industry, to have earned this high distinction



### IMPORTANCE

Yaskawa has taken the intensive steps necessary to incorporate a standard of quality into its world class manufacturing facilities that cannot be found anywhere else. It proves you can trust us to deliver products that will perform, people that will respond and the results you need from your automation systems.



## Variable Frequency Drives Reduce Energy Use

A typical fan or pump running at 50% speed will use less than 20% of the energy of a system using mechanical control methods.

The primary reason drives reduce energy and improve system efficiency is due to the elimination of throttling, which has been the traditional method of mechanically adjusting air or water flow in a system.

### RETURN OF INVESTMENT < 2 MONTHS

**406 MWh**  
Saved Annually

**\$67K**  
Saved Annually

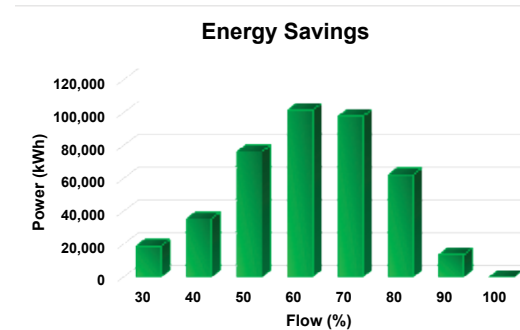

**150 ton**  
Annual Carbon Footprint Reduction

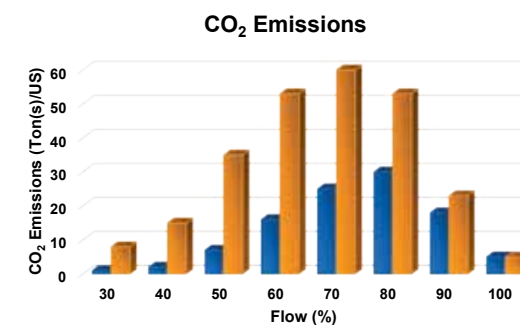

**20%**

USING A DRIVE TO REDUCE FAN OR PUMP SPEED TO 50% IN LOW DEMAND SITUATIONS WILL USE ONLY 20% OF THE ENERGY OF FULL SPEED OPERATION.

**50%**

DRIVES CAN REDUCE CARBON FOOTPRINT BY OVER 50% BY ALLOWING THE DRIVE TO OPERATE PER DEMAND.

**60%**

DRIVES CAN REDUCE ENERGY COSTS UP TO 60%.

**100%**

YASKAWA WILL COMMIT 100% TO PROVIDING YOU THE BEST QUALITY, SERVICE AND TRAINING POSSIBLE.

Calculations are based on a 100 HP single motor pump system comparing the energy savings of a drive versus a bypass valve controlled system using Yaskawa's Industrial Energy Savings Predictor software. The motor is operating on a pump curve for a variable torque controlled load and the local utility charge is \$0.167 per kWh (BLS.gov - average energy prices for the United States in September 2022).

**FP605 AC DRIVE**

# EASY, POWERFUL & RELIABLE



Offering world class Yaskawa quality, along with easy installation and high flexibility, the FP605 delivers a highly efficient and sustainable solution for your pump and fan motor control needs.

**FP605 BYPASS PACKAGES**

- 208 VAC: 1 to 100 HP
- 240 VAC: 1 to 100 HP
- 480 VAC: 1 to 250 HP

**FP605 DRIVES**

- IP20/UL Type 1**
- 240 VAC: 3 to 150 HP
  - 480 VAC: 3 to 600 HP

- IP55/UL Type 12**
- 240 VAC: 3 to 40 HP
  - 480 VAC: 3 to 100 HP

- IP55/UL Type 12 with Switch**
- 240 VAC: 3 to 40 HP
  - 480 VAC: 3 to 75 HP

**FP605 CONFIGURED PACKAGES**

- 208 VAC: 1 to 150 HP
- 240 VAC: 1 to 150 HP
- 480 VAC: 1 to 600 HP



**MAKING IT EASY**

**MAKING IT FLEXIBLE**

**MAKING IT SUSTAINABLE**

**WORLD CLASS DESIGN**

Every FP605 will run a motor before leaving our production floor!

No other manufacturer puts its products through as many tests, or as arduous a testing process, as Yaskawa. All printed circuit boards are functionally tested while under power. All Yaskawa products are 100% tested under full current. Yaskawa conducts its own product qualification testing in its ISO-certified test lab. Products are tested not only under normal spec conditions, but also for the following:

- Extreme temperature/humidity
- Vibration
- Package drop
- Input voltage tolerance
- Noise immunity
- Electrical insulation stress
- Under/over voltage protection
- Momentary power loss
- Output short circuit protection
- Overload protection
- Ground fault protection
- Input/output phase loss test
- Power on/off and start-up iterations

- Keyhole mounting and euro style terminals make for a fast and easy installation.
- Intuitive, easy-to-read keypad eliminates the need for manuals.
- Embedded Functional Safety minimizes system down-time.

- Standalone option to suit your needs, including IP20/Protected chassis, IP20/UL Type 1, and IP55/UL Type 12.
- UL Type 1, 12, and 3R configured and bypass packages with a variety of options.
- Connects to your favorite network seamlessly and easily, including EtherNet/IP, PROFINET, and Modbus TCP/IP.

- Embedded reactors on every model provides instant harmonic mitigation that's friendly to your power system and surrounding equipment. Most FP605 models have a 5% split DC link choke, providing more harmonic reduction than a typical 3% DC reactor.
- Conformal coated boards protect the drive from the application environment, extending product lifetime.
- Manufactured with eco-friendly materials.

# MAKING THE COMPLICATED SIMPLE

The FP605 keypad has all the features you need, intuitively, at your fingertips. Its simplicity is what makes it easy to commission.

## CHOICE OF PROTECTION RATINGS

The FP605 comes standard from the factory with a choice of IP20/UL Type 1, IP55/UL Type 12, and IP20/Protected Chassis. Up to 60°C ambient temperature operation with derating for IP20/UL Type 1 and IP20/Protected Chassis. Up to 50°C ambient temperature operation with derating for IP55/UL Type 12.

## SIDE-BY-SIDE

The FP605 is designed with a narrow footprint and most models can be mounted side-by-side with bottom entry wiring to maximize cabinet or wall space.

## PANEL MOUNTING

When mounted in a separate enclosure, heat management can be accomplished by removing detachable top and bottom covers on the drive or by "back side" mounting the standard drive with the heatsink external to a UL Type 1 or UL Type 12 enclosure.



## FLEXIBLE MOTOR CONTROL

- Induction and permanent magnet motors
- Synchronous reluctance (SynRM) motors
- 400 Hz output frequency

## ENHANCED PUMP CONTROL

The FP605 includes easy to set up intelligent pump control capable of advanced self-guided operation.

### Feature include:

- Easy sleep / wakeup PID setup
- No flow / deadhead protection
- Submersible motor thrust bearing control
- Automatic system restart
- Sleep boost
- Low and high pressure feedback detection
- Power loss utility start delay timer
- Loss of prime (LOP) / pump dry-run protection
- Pre-charge control (controlled pipe fill)
- Optional dual transducer feedback for redundancy
- Impeller de-scaling / de-ragging control

### Pump Status:

- System pressure setpoint
- Control operation status
- Pump motor output frequency
- Transducer feedback
- Drive status monitors
- Drive lifetime monitors



### BLUETOOTH®

Use the DriveWizard Mobile Application to manage FP605 drives and packages with optional Bluetooth keypad connectivity.

### Copy Function

Up to four sets of parameters can be stored and easily copied to additional drives.

### High-Contrast Display

Contrast control offers clear and readable full-text descriptions.

### Automatic Backup Function

Saves the drive's current parameter setting automatically. No user interaction required. After an incident, settings can be easily retrieved from the keypad.

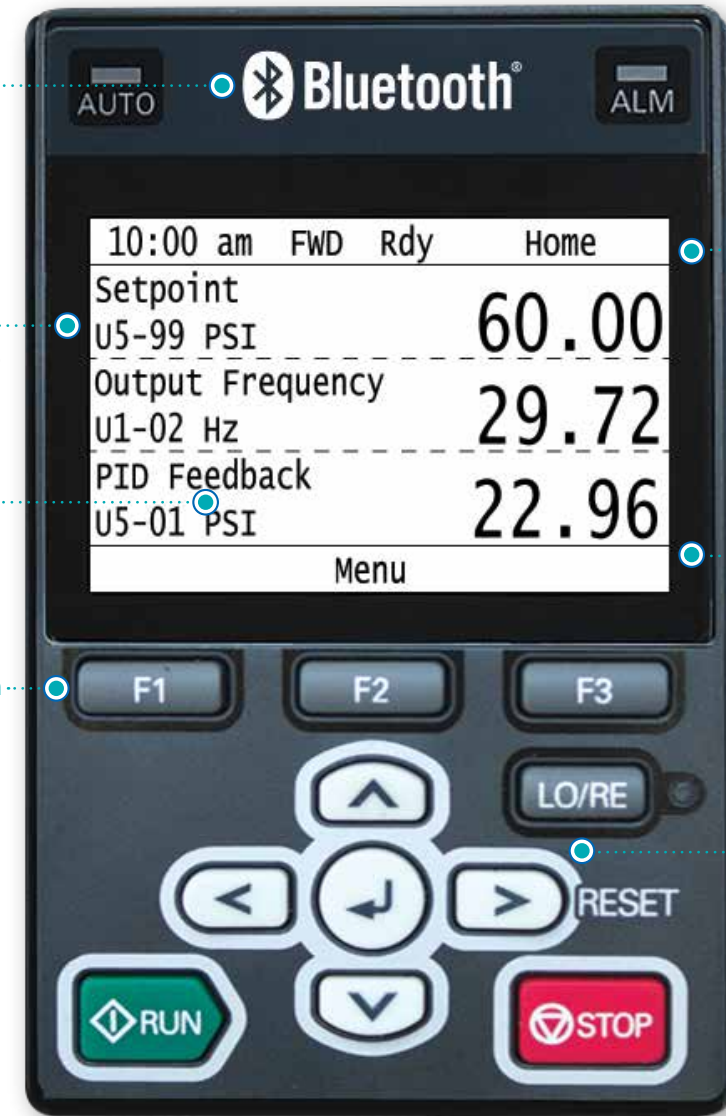

### Micro SD Slot

MicroSD storage for data logging of up to ten user-customizable drive monitors.

### Real-Time Clock

Real-time clock for time and date stamp of fault information.

### Advanced Keypad Navigation

Shortcuts, scrolling and function keys offer faster navigation.

*Bluetooth® and the Bluetooth logo are registered trademarks of Bluetooth SIG, Inc. USA.*



## NO POWER? NO PROBLEM!

The FP605 can be programmed without any power supply connected, even while the drive is still in the box. Simply plug into one of your PC's USB ports or any USB On-the-Go device (Android smartphone or tablet), start programming and enjoy the ease of commissioning.

# ADVANCED PUMP FEATURES

The FP605's advanced pump features allows for fast and easy setup to get you saving energy right away. The drive is programmed using pump terminology to ensure fast and easy set up. Pump protection features ensure maximum drive and pump life.

## PUMP SYSTEM

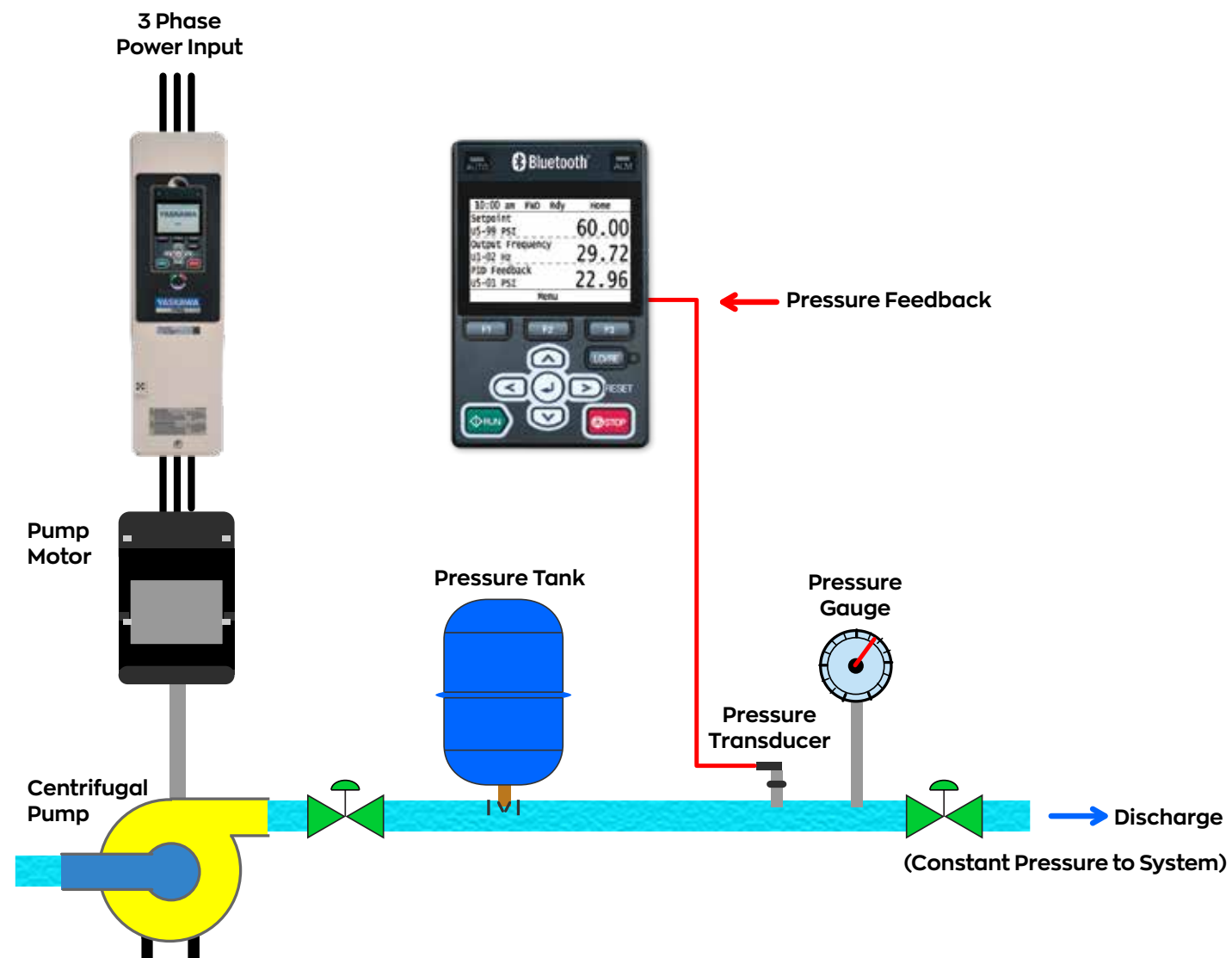

## SLEEP MODE MINIMUM FLOW PROTECTION

Protects and shuts down the pump at low speeds or in low flow conditions.

## NO FLOW / DEADHEAD PROTECTION

Detects changes in pressure and flow when the system has been closed off via mechanical valves or restrictions. If a system is not protected from this condition, the water within the pump can vaporize, building up excessive heat that can damage the pump and the discharge piping.

## SUBMERSIBLE MOTOR THRUST BEARING CONTROL

Protects the bearings of submersible pump motors by ensuring proper start-up speeds and times.

## AUTOMATIC SYSTEM RESTART

Programmable timers allow FP605 drives to automatically restart the system in Auto Mode for faults relating to brown outs, loss of power and pump specific faults.

## LOSS OF PRIME / PUMP DRY-RUN PROTECTION

Loss of prime protection is a feature protecting the pump and motor from damage caused by running the pump without water. If a pump were to lose prime and continue to operate without water moving through the pump, the pump would heat up, which would eventually damage the pump seal, motor, pipe manifold and related components.

## LOW- AND HIGH-PRESSURE FEEDBACK DETECTION

FP605 drives continuously monitor the system feedback device to provide a warning alarm or fault based on the programmed level.

## POWER LOSS UTILITY START DELAY TIMER

Used in conjunction with Automatic Restart, a programmable timer will delay starting to allow for multiple pumps to sequence start on loss of power. This function ensures that the power system is not stressed when utility power has returned and the pump system is automatically restarted.

## SLEEP BOOST

Intended for use with a pressure tank, the FP605 drive boosts the set pressure prior to shutdown, extending the pump's sleep time, reducing cycling and saving energy.

## PRE-CHARGE CONTROL (CONTROLLED PIPE FILL)

This programmable feature eliminates water hammer and extends system life by gradually filling a pipeline before normal full pressure and flow operation. Pump motor speed can be controlled with a system timer, level or pressure control device to indicate when normal operation may begin.

## SECONDARY TRANSDUCER BACKUP

This option used in drive only pump control allows for a secondary backup transducer to be automatically used if the main transducer has failed. The keypad text message will alert what feedback transducer is being used.



# CONSTANT SPEED LAG PUMP MULTIPLEXING

Optimize efficiency and control without the need for a drive on every pump. FP605's contactor-based multiplexing brings on backup pumps as demand increases. The FP605 maintains speed control of the primary pump to meet the exact demand, which maximizes efficiency and minimizes cost.

## MULTIPLEXING PUMP SYSTEM

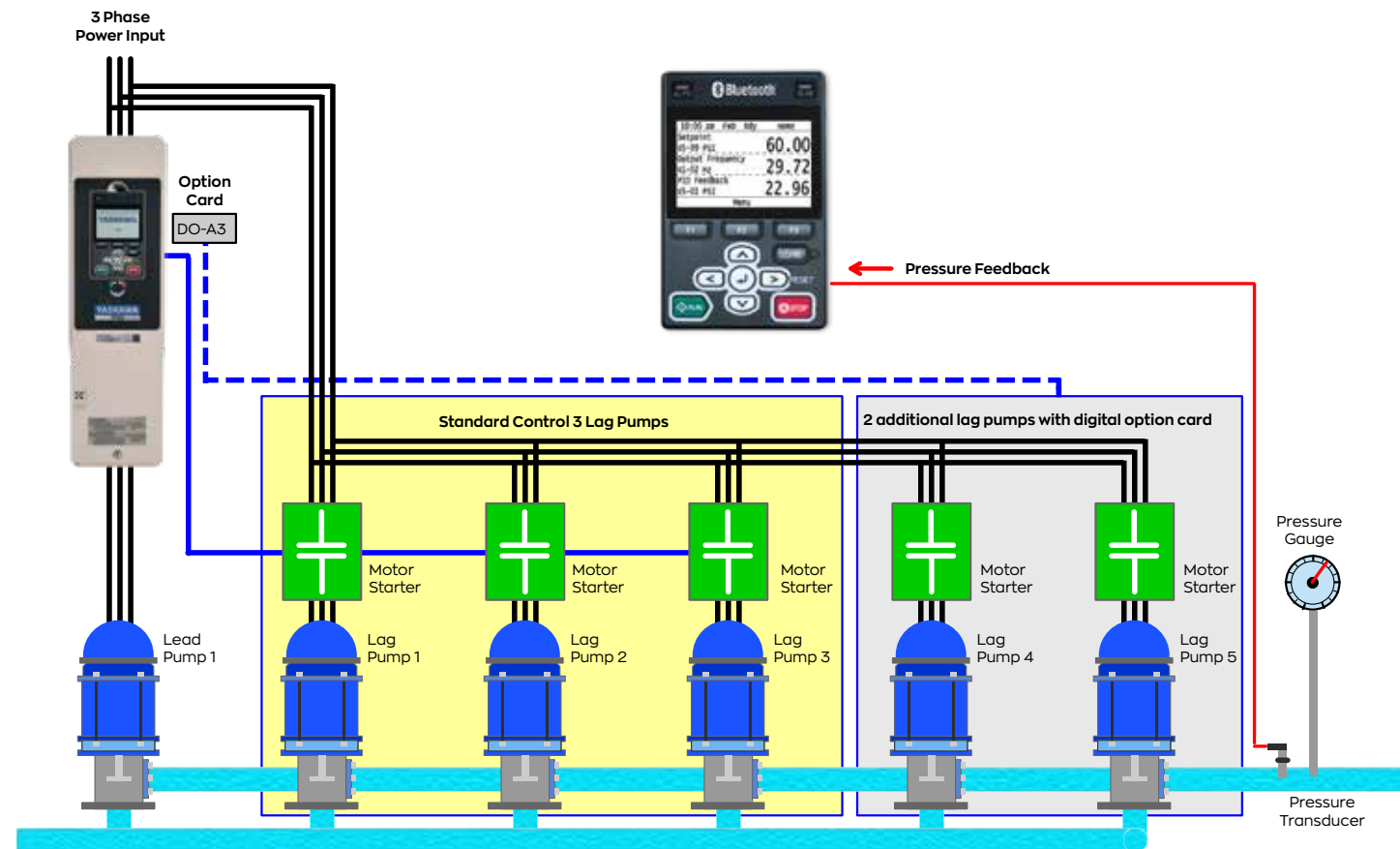

## BENEFITS OF MULTIPLEXING

- Automatically starts and stops up to five lag pumps based on the system demand, and will automatically stage and de-stage the booster pumps.
- Alternation of lag pumps to provide even wear.
- Allows a single lag pump to be selected during Pre-Charge (Pipe Fill) to reduce fill rate time.
- For large water consumers, acre-feet can be selected for water accumulation units.
- When the discharge pressure exceeds a high level setting, all running lag pumps will be quickly de-staged to prevent unsafe high pressure conditions.
- When using Pre-Charge, Lag Pump Staging and De-Staging functions, the drive's keypad will provide a message of time remaining before pre-charge is finished and/or time remaining before lag pumps are to stage and de-stage.

## SPEED REDUCTION "GO TO SPEED" AFTER LAG PUMP STAGING

Automatically sets the lead drive to operate at a lower fixed speed for a specified amount of time whenever a lag pump is staged on. This dampens the shock loading of a lag pump starting across the line to the system.

## SETPOINT BOOST AFTER DE-STAGING

Automatically boosts the auto setpoint pressure to a new specified incremental amount for a programmable time whenever a pump is de-staged. This allows the lead drive to accelerate more quickly to lessen the pressure drop on the system of a lag pump that is being de-staged.

## HARD CURRENT LIMIT

As the pump impeller wears over time, it changes the efficiency of the pump. In order to maintain a constant pressure or flow, the pump speed will increase, resulting in greater motor current. This can cause the drive to trip on nuisance motor overload. A hard current limit may be set to automatically limit speed to protect the drive and motor, while maintaining operation.

## BACK SPIN TIMER

After "Stop" command, the drive's Run Delay at Stop function will not allow restart until the timer expires, allowing the water column to flow back down the well.



**EFFORTLESS**

# NETWORK INTEGRATION

Connect to your network in less than 60 seconds. FP605 drives support all the major industrial communications and connection topologies (ring, star, line, etc.) to adapt to various factory automation networks. Reduce wiring when connecting to an upper level controller or PLC through available built-in protocols or dedicated communication options.

**CONFIGURATIONS**

RING



STAR



LINE



**COST EFFECTIVE INTEGRATION**



Reduce the number of option cards up to 80%. Only a single communication option card is required to network up to five drives via the RS-485 terminals.

**EMBEDDED +24 VDC INPUT ACCESS**

Network communication can be maintained during loss of main input power utilizing the +24 VDC input. An external +24 VDC supply also allows you the ability to program the drive without main power.



# MOTOR FLEXIBILITY

The FP605 precisely controls induction, permanent magnet, and synchronous reluctance motors providing versatility to run a variety of applications with just one drive.

**Motor Control Capability**

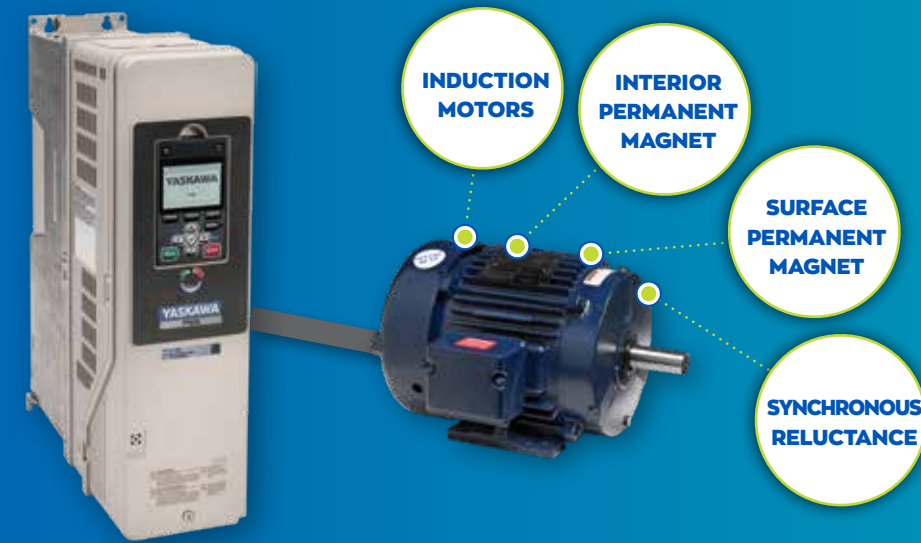

**ONE DRIVE FOR VARIOUS APPLICATIONS**

- 400 Hz output frequency

**ENERGY SAVINGS**

- Automatic energy efficiency optimizer with FP605 energy saving functions

**AUTOMATIC ENERGY EFFICIENCY OPTIMIZER**

Energy usage is automatically optimized with the unique energy savings functions of the FP605. These functions minimize energy consumption through varying load and speed ranges, achieving power optimization for energy cost reduction. Maximize your energy usage by optimizing your motor torque per amp.

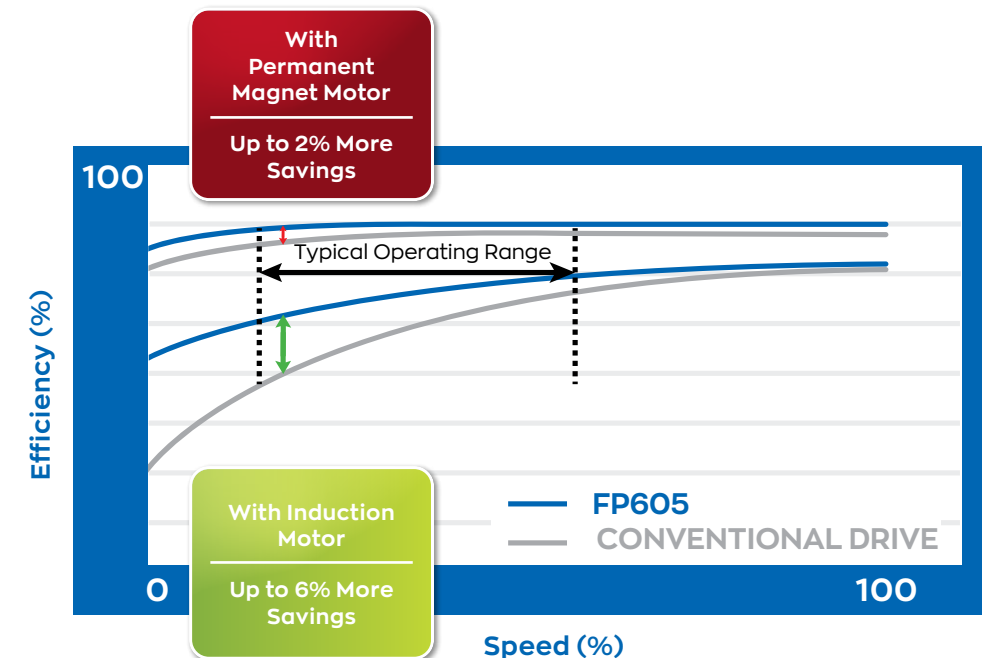

INTEGRATED FUNCTIONAL SAFETY

# PLAY IT SAFE

With the built-in dual channel STO (safe torque off, SIL3/PLe), the FP605 provides the right tools for easy machine integration of emergency stop functions, even when elevated levels of risk reduction are required.

TÜV Certified

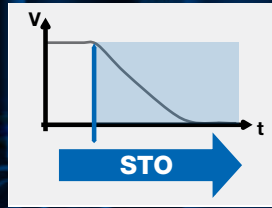

## SUSTAINABLE, CLEAN POWER CONVERSION

Whether your concern is efficiency, power quality, or non-hazardous material, Yaskawa products are here for the long haul and help contribute to a healthy and sustainable environment.



### INTEGRATED HARMONIC REDUCTION

Each and every FP605 has a built-in reactor to help suppress harmonics and meet your IEEE 519 compliance requirements. Most FP605 models have a 5% split DC link choke, providing more harmonic reduction than a typical 3% DC reactor.

Designed for 10 years of maintenance-free operation, the FP605 is built tough to withstand harsh and demanding conditions.

### WIDE AMBIENT TEMPERATURE RANGE

FP605 drives can be safely operated in ambient temperatures ranging from -10°C up to 60°C.

### COATED CIRCUIT BOARD PROTECTION

Coated PCBs as standard protect the electronics from dust or humidity, while ensuring reliable operation even in harsh environments (IEC 60723-3-3, 3C2, 3S2).



### ENVIRONMENTALLY FRIENDLY

Rest assured that Yaskawa complies with strict environmental standards relative to use of hazardous substances.

Products are certified to the RoHS 2 Directive (2011/65/EU), which permits very small levels of lead, mercury, cadmium and others substances..



# RUGGED



# SOFTWARE TOOLS

Whether you are monitoring, programming, estimating energy savings, or looking to meet harmonic standards, Yaskawa's FP605 has the tools to help get you going and stay going.

## DRIVEWIZARD® INDUSTRIAL

- Manage your parameters online or offline
- Create configurations offline, then later connect and download them to the FP605
- Connect via USB, and interface with the FP605 even without main power
- Monitor using a dashboard of dynamic variables
- Create reports for exporting and emailing



## PARAMETER COMPATIBILITY

DriveWizard® makes it simple to transition from previous generation drives to the FP605.



## DRIVEWIZARD® MOBILE WITH YASKAWA DRIVE CLOUD™



Start-up, adjust, and monitor Yaskawa's latest AC drives with your smartphone or tablet.

Use DriveWizard Mobile to backup, store, and retrieve your drive settings locally or to your personal Yaskawa Drive Cloud account. DriveWizard Mobile is the mobile app version of Yaskawa's DriveWizard PC tool.

Connect your mobile device with an optional Yaskawa Bluetooth keypad for a wireless experience. Alternatively, connect via USB, and interface with the latest generation of Yaskawa AC drives, even without main power! The drive is equipped with a female Type B Mini-USB port. Use a USB-OTG cable with a matching smartphone connector.

DriveWizard Mobile is available from the App Store and Google Play.



- DriveWizard® is a registered trademark of Yaskawa America, Inc.
- Bluetooth® is a registered trademark of Bluetooth SIG, Inc. USA.
- Google Play and the Google Play logo are trademarks of Google, LLC

- Apple and the Apple logo are trademarks of Apple, Inc. registered in multiple countries. The App Store is a service mark of Apple, Inc.
- IOS trademarks are used under the license of Cisco USA

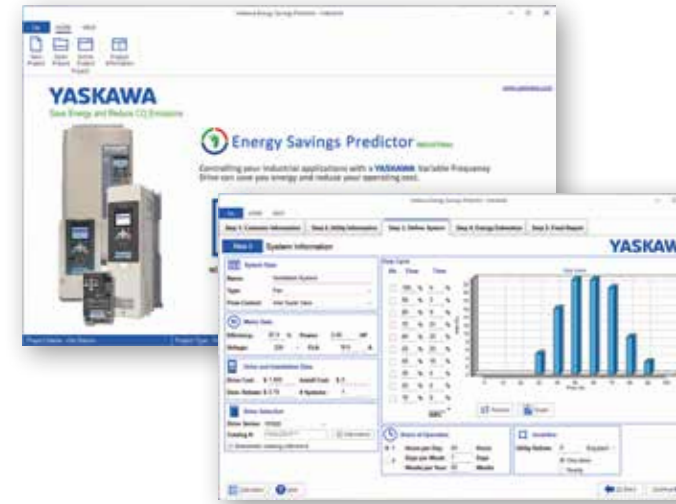

## ENERGY SAVINGS PREDICTOR

Predicts the amount of energy savings achievable when using Yaskawa drives instead of conventional control methods. The results can be viewed in graphical and text format with built-in functions to generate an energy prediction report, especially designed for consultants.

## HARMONICS ESTIMATOR

Estimates total harmonic distortion when using Yaskawa drives and references IEEE 519 to determine if the defined system meets the required standard. The results can be viewed in graphical and text format with built-in functions to generate a harmonics estimation report especially designed for consultants.



## PROGRAMMING SIMULATORS

Provide a realistic simulation of the programming and operation of an FP605. All major functions of the drives are simulated by these PC tools with the addition of I/O, trending, diagnostic operations. The software has an integrated automatic update function that allows for updating the actual program - when connected to the internet.

# FP605 PRODUCT PORTFOLIO

Quick lead times on cost effective drives and standard packages. Engineered solutions available to meet your custom requirements.

# RUGGED AND LONG-LASTING

Yaskawa applies the latest proven technology and processes, to assure we provide products you can trust.

## STANDALONE DRIVES

### IP20/UL TYPE 1

**Product Range**

- **240 VAC:** 3 to 150 HP
- **480 VAC:** 3 to 600 HP

*Note: 240 VAC models above 60 HP and 480 VAC models above 125 HP are IP20/Protected chassis and require an optional mounting kit to meet UL Type 1 standards.*



### IP55/UL TYPE 12

**Product Range**

- **240 VAC:** 3 to 40 HP
- **480 VAC:** 3 to 100 HP

480 VAC models with switch available up to 75 HP.



## FULLY-ENGINEERED PACKAGES

Both end users and OEM customers have come to rely on our custom product engineering capabilities. These products are based off of our standard configurations and made into a totally customized package.

**Engineered packages include:**

- Redundant drive packages
- 12- or 18-pulse configurations
- Soft start bypass packages
- Integrated harmonic filter packages
- Multiple motor configurations

UL Type 1, 12 or 3R enclosures available with custom engineering drawings/documentation.

## ENCLOSED BYPASS AND CONFIGURED PACKAGES

### UL TYPE 1 AND UL TYPE 12

**Standard Features:**

- 12-Gauge Steel
- Padlock Hasp
- Whole Door Gasket
- Integral ¼ Turn Door Latches
- Lifting Eye Bolts
- Removable Air Filter from Outside of Cabinet



**Product Range**

- **208 VAC:** 1 to 150 HP (Bypass: 100 HP)
- **240 VAC:** 1 to 150 HP (Bypass: 100 HP)
- **480 VAC:** 1 to 600 HP (Bypass: 250 HP)

### UL TYPE 3R

**Standard Features:**

- 12-Gauge Steel
- Padlock Hasp
- Whole Door Gasket
- Integral ¼ Turn Door Latches
- Brass Hinges
- Lifting Eye Bolts
- UL Type 3R Keypad Membrane
- Sun Reflective White Powder Coat Paint
- Stainless Steel Hardware



**Product Range**

- **208 VAC:** 5 to 150 HP (Bypass: 100 HP)
- **240 VAC:** 5 to 150 HP (Bypass: 100 HP)
- **480 VAC:** 5 to 600 HP (Bypass: 250 HP)

## TESTING AND CERTIFICATION

### PRODUCT TESTING

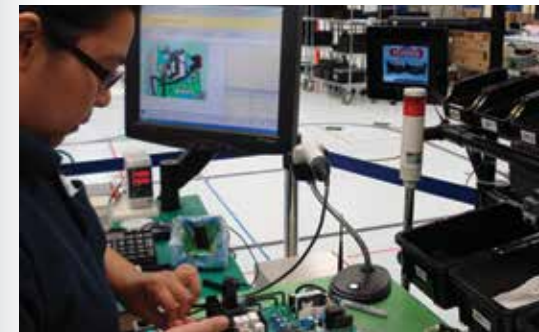

All Yaskawa products undergo rigorous testing during the design phase to ensure long life and problem-free operation.

- Maximum Temperature
- Maximum Load
- Maximum Voltage and Hi-Pot
- Electromagnetic Compatibility
- All packages UL rated and built to UL 508A (industrial control panel) standards

### PRODUCT CERTIFICATION

Designed to the most stringent electrothermal safety standards and certified with all major worldwide agencies.

- UL/cUL
- TUV
- CE
- EAC
- RCM
- KCC



## OPTIMIZED MOUNTING

### HEAT MANAGEMENT

FP605 standalone drives can be mounted without the need for an expensive additional enclosure or with an external heatsink to reduce package and cooling requirements.



*IP20/UL Type 1 drive with UL Type 12 backside flange*

### SIDE-BY-SIDE MOUNTING

The FP605 can be mounted side-by-side with bottom entry wiring to reduce cabinet size.



# FP605 AC DRIVE

## Catalog Code Designation

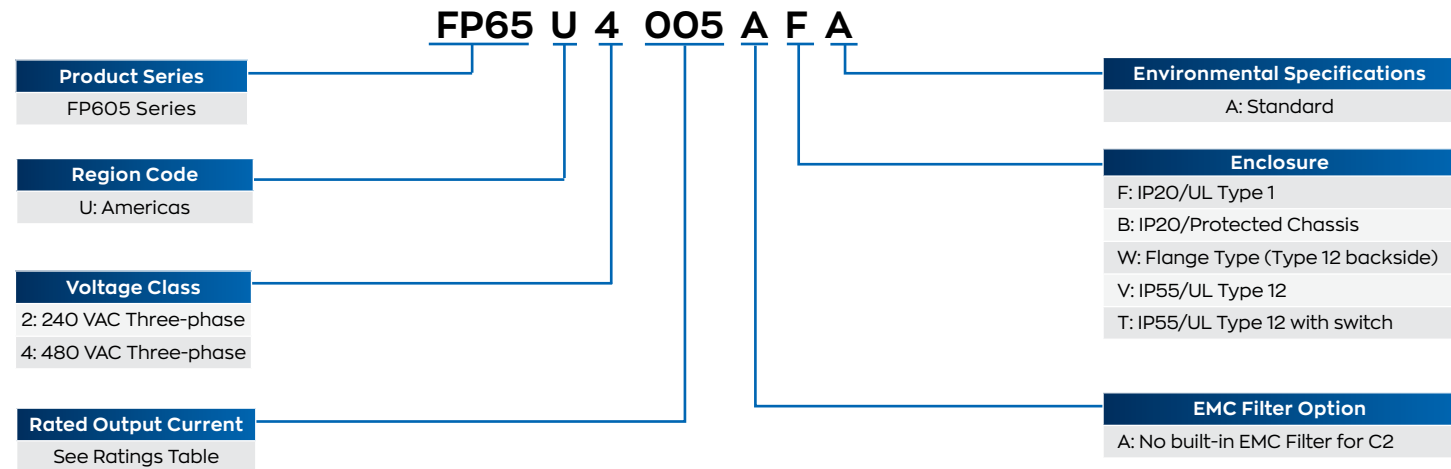

Note: Optional Bluetooth keypad (JVOP-KPLCC04MBB) ordered separately

## IP20/UL TYPE 1 RATINGS

Power Output Horsepower (HP)	240 V Models			480 V Models		
	Catalog Code FP65U □□□□□□□□	Current (A)	Frame	Catalog Code FP65U □□□□□□□□	Current (A)	Frame
3	2011AFA	10.6	1	4005AFA	4.8	1
5	2017AFA	16.7	1	4008AFA	7.6	1
7.5	2024AFA	24.2	2	4011AFA	11	1
10	2031AFA	30.8	2	4014AFA	14	1
15	2046AFA	46.2	3	4021AFA	21	2
20	2059AFA	59.4	3	4027AFA	27	2
25	2075AFA	74.8	4	4034AFA	34	2
30	2088AFA	88	4	4040AFA	40	3
40	2114AFA	114	4	4052AFA	52	3
50	2143AFA	143	6	4065AFA	65	3
60	2169AFA	169	6	4077AFA	77	4
75	-	-	-	4096AFA	96	4
100	-	-	-	4124AFA	124	4
125	-	-	-	4156AFA	156	6

Larger horsepower models available in a IP20/Protected chassis enclosure.

## APPROXIMATE DIMENSIONS

Frame Size	Height	Width	Depth
1	14.1	4.9	8.6
2	17.6	4.9	9.2
3	20.1	7.9	9.3
4	21.3	10.0	10.4
6	30.5	12.3	15.7

Dimensions shown in inches.

Information in these tables represents IP20/UL Type 1 enclosures. For other enclosure types and enclosure adaptors, please visit yaskawa.com.

## IP20/PROTECTED CHASSIS

Power Output Horsepower (HP)	240 V Models			480 V Models		
	Catalog Code FP65U □□□□□□□□	Current (A)	Frame	Catalog Code FP65U □□□□□□□□	Current (A)	Frame
75	2211ABA	211	9	-	-	-
100	2273ABA	273	9	-	-	-
125	2343ABA	343	10	-	-	-
150	2396ABA	396	10	4180ABA	180	9
200	-	-	-	4240ABA	240	9
250	-	-	-	4302ABA	302	9
300	-	-	-	4361ABA	361	10
350	-	-	-	4414ABA	414	10
400	-	-	-	4477ABA	477	11
450	-	-	-	4515ABA	515	11
500	-	-	-	4590ABA	590	11
600	-	-	-	4720ABA	720	11

## APPROXIMATE DIMENSIONS

Frame Size	Height	Width	Depth
9	27.6	12.3	16.5
10	31.5	17.3	18.6
11	44.9	20.1	18.9

Dimensions shown in inches

Information in these tables represents IP20/Protected Chassis enclosures. For other enclosure types and enclosure adaptors, please visit yaskawa.com.

## IP55/UL TYPE 12 RATINGS

Power Output Horsepower (HP)	240 V Models			480 V Models		
	Catalog Code FP65U □□□□□□□□	Current (A)	Frame	Catalog Code FP65U □□□□□□□□	Current (A)	Frame
3	2011AVA / 2011ATA	10.6	1	4005AVA / 4005ATA	4.8	1
5	2017AVA / 2017ATA	16.7	1	-	-	-
7.5	2024AVA / 2024ATA	24.2	2	4011AVA / 4011ATA	11	1
10	2031AVA / 2031ATA	30.8	2	4014AVA / 4014ATA	14	1
15	2046AVA / 2046ATA	46.2	3	4021AVA / 4021ATA	21	2
20	2059AVA / 2059ATA	59.4	3	4027AVA / 4027ATA	27	2
25	2075AVA / 2075ATA	74.8	4	4034AVA / 4034ATA	34	2
30	2088AVA / 2088ATA	88	4	4040AVA / 4040ATA	40	3
40	2114AVA / 2114ATA	114	4	4052AVA / 4052ATA	52	3
50	-	-	-	4065AVA / 4065ATA	65	3
60	-	-	-	4077AVA / 4077ATA	77	4
75	-	-	-	4096AVA / 4096ATA	96	4
100	-	-	-	4124AVA	124	4

The catalog code for IP55/UL Type 12 drives ends in AVA, while the catalog code for IP55/UL Type 12 with switch drives ends in ATA.

## APPROXIMATE DIMENSIONS

Enclosure Option V (without switch)			
Frame Size	Height	Width	Depth
1	14.1	4.9	9.0
2	17.6	4.9	9.6
3	20.1	7.9	9.7
4	21.3	10.0	10.7

Enclosure Option T (with switch)			
Frame Size	Height	Width	Depth
1	20.4	4.9	9.0
2	24.5	4.9	9.6
3	28.9	7.9	9.7
4	37.4	10.0	10.7

Dimensions shown in inches (mm).

Information in these tables represents IP55/UL Type 12 enclosures. For other enclosure types and enclosure adaptors, please visit yaskawa.com.



To view the FP605 drive connection diagram, please visit [https://www.yaskawa.com/fp605\\_ds](https://www.yaskawa.com/fp605_ds)

# SPECIFICATIONS

Item	Specifications
<b>Input Voltage</b>	Three-phase 200 to 240 VAC, 380 to 480 VAC, +10%/-15%, 50/60 Hz +/-5%
<b>Ambient Operating Temperature</b>	-10 to +50°C (IP20/Protected Chassis) -10 to +40°C (IP20/Type 1) Up to +60°C (with derate)
<b>Ambient Storage</b>	-20°C to +70°C (-4°F to 158°F)
<b>Overload Capacity</b>	110% for 60 sec., 140% for 2 sec., 175% instantaneous
<b>Output Frequency</b>	0 to 400 Hz
<b>Control Methods</b>	Open Loop V/f Open Loop Vector (PM motors only) EZ Open Loop Vector
<b>Motor Types</b>	Induction Permanent Magnet Synchronous Reluctance
<b>Environmental</b>	1,000 meters altitude, up to 4,000 meters with derating Class 3C2 and 3S2 operation for IP20/Type 1 & IP20/Protected Chassis 95% humidity, non-condensing
<b>Harmonics</b>	5% split choke built in both positive and negative DC bus leg as standard (3% DC link on positive BUS for IP20/Protective Chassis designs)
<b>Protective Design Types</b>	IP20/Type 1 IP55/Type 12 IP20/Protected Chassis
<b>Global Certifications</b>	UL, cUL, CE, RoHS 2, WEEE, TUV SUD
<b>Functional Safety</b>	Safe Torque Off, SIL3 according to IEC 62061, PLe according to ISO 13849-1
<b>Interface</b>	LCD keypad and Status Ring, Bluetooth® is optional
<b>Standard I/O</b>	(8) multi-function digital inputs (24Vdc) (3) multi-function analog inputs (0 +/- 10 VDC, 4-20 mA) (1) multi-function pulse inputs (2) Safe Torque Off inputs (2) fault relay output (form C) (2) multi-function relay outputs (form A) (2) multi-function analog output (0 +/- 10 VDC, 4-20mA)
<b>24 VDC Power</b>	External supply input to maintain communications without main power 150 mA output for customer use
<b>I/O Expansion</b>	(3) Analog Inputs -10 to +10V, 13 bit plus sign, 4 to 20mA (16) Digital Inputs (2) Analog Outputs (-10 to +10V, 11 bit magnitude) (8) Digital Outputs (6 transistor, 2 relay)
<b>Network Communication</b>	Standard: Modbus RTU, RS-485, 115 kbps Optional: EtherNet/IP™, DeviceNet, Modbus® TCP/IP, PROFINET, PROFIBUS-DP
<b>Software Support Tools</b>	DriveWizard® Industrial DriveWizard® Mobile Programming Simulator Energy Savings Predictor Harmonics Estimator

\* See manual for specific drive ratings

Modbus® is a registered trademark of Schneider Electric, licensed to the Modbus Organization, Inc.  
EtherNet/IP™ is a trademark of ODVA, Inc.



To learn more about the FP605 and see how it can make your day-to-day life easier, please visit <https://www.yaskawa.com/fp605>.

# OPTIONS

## MOUNTING ADAPTORS

Input	Catalog Code FP65U □□□□ <sup>*3</sup>	UL Type 1 Adaptors <sup>*1</sup>	Internal Fuses (Bussman FWH Series)  for Type 1 Adaptors <sup>*1,*2</sup>	External Heatsink Adaptors	
				UL Type 1	UL Type 12
208 to 240 V, 3-Phase	2011	N/A	N/A	ZPSA-600-EH1-FR1	ZPSD-600-EH12-FR1
	2017	N/A	N/A	ZPSA-600-EH1-FR1	ZPSD-600-EH12-FR1
	2024	N/A	N/A	ZPSA-600-EH1-FR2	ZPSD-600-EH12-FR2
	2031	N/A	N/A	ZPSA-600-EH1-FR2	ZPSD-600-EH12-FR2
	2046	N/A	N/A	ZPSA-600-EH1-FR3	ZPSD-600-EH12-FR3
	2059	N/A	N/A	ZPSA-600-EH1-FR3	ZPSD-600-EH12-FR3
	2075	N/A	N/A	ZPSA-600-EH1-FR3	ZPSD-600-EH12-FR3
	2088	N/A	N/A	ZPSA-600-EH1-FR4	ZPSD-600-EH12-FR4
	2114	N/A	N/A	ZPSA-600-EH1-FR4	ZPSD-600-EH12-FR4
	2143	N/A	N/A	Included as standard	N/A
	2169	N/A	N/A	Included as standard	N/A
	2211	900-192-121-009	N/A	Included as standard	N/A
	2273	900-192-121-009	N/A	Included as standard	N/A
	2343	900-192-121-010	N/A	Included as standard	N/A
2396	900-192-121-010	N/A	Included as standard	N/A	
480 V, 3-Phase	4005	N/A	N/A	ZPSA-600-EH1-FR1	ZPSD-600-EH12-FR1
	4008	N/A	N/A	ZPSA-600-EH1-FR1	ZPSD-600-EH12-FR1
	4011	N/A	N/A	ZPSA-600-EH1-FR1	ZPSD-600-EH12-FR1
	4014	N/A	N/A	ZPSA-600-EH1-FR1	ZPSD-600-EH12-FR1
	4021	N/A	N/A	ZPSA-600-EH1-FR2	ZPSD-600-EH12-FR2
	4027	N/A	N/A	ZPSA-600-EH1-FR2	ZPSD-600-EH12-FR2
	4034	N/A	N/A	ZPSA-600-EH1-FR2	ZPSD-600-EH12-FR2
	4040	N/A	N/A	ZPSA-600-EH1-FR2	ZPSD-600-EH12-FR2
	4052	N/A	N/A	ZPSA-600-EH1-FR3	ZPSD-600-EH12-FR3
	4065	N/A	N/A	ZPSA-600-EH1-FR3	ZPSD-600-EH12-FR3
	4077	N/A	N/A	ZPSA-600-EH1-FR4	ZPSD-600-EH12-FR4
	4096	N/A	N/A	ZPSA-600-EH1-FR4	ZPSD-600-EH12-FR4
	4124	N/A	N/A	ZPSA-600-EH1-FR4	ZPSD-600-EH12-FR4
	4156	N/A	N/A	Included as standard	N/A
	4180	N/A	N/A	Included as standard	N/A
	4240	900-192-121-009	N/A	Included as standard	N/A
4302	900-192-121-009	N/A	Included as standard	N/A	
4361	UUX001700	UFU000047	Included as standard	N/A	
4414	UUX001700	UFU000047	Included as standard	N/A	
4477	UUX001701	UFU000048	Included as standard	N/A	
4515	UUX001701	UFU000048	Included as standard	N/A	
4590	UUX001701	UFU000049	Included as standard	N/A	
4720	UUX001701	UFU000049	Included as standard	N/A	

\*1: Type 1 Adaptors for models 4361 and larger are input fuse ready. UL requires Bussman FWH series semiconductor fuses to be installed within the Type 1 Adapter on these models.

\*2: Fuses sold individually. Quantity 3 required per drive.

\*3: Mounting adaptor options applicable to FP65UxxxxAFA and FP65UxxxxABA models

## NETWORK COMMUNICATIONS

Part No.	Description
SI-EN3	EtherNet/IP
SI-EN3D	EtherNet/IP dual port
SI-EM3	Modbus/TCP
SI-EM3D	Modbus/TCP dual port
SI-EP3	PROFINET
SI-P3	PROFIBUS-DP
SI-N3	DeviceNet
SI-W3	LONWORKS
SI-B3	BACnet MSTP
SI-J3	APOGEE/METASYS
SI-S3	CANopen

## EXPANSION I/O

Part No.	Description
AI-A3	Analog Input (provides 3 additional inputs)
DI-A3	Digital Input (provides 16 additional inputs)
AO-A3	Analog Monitor (provides 2 additional outputs)
DO-A3	Digital Output (provides 8 additional outputs)

## KEYPADS

Part No.	Description
JVOP-KPLCA04MEB	Standard LCD Local/Remote Keypad
JVOP-KPLCC04MBB	LCD Keypad with Bluetooth

## REMOTE MOUNT ADAPTORS

Part No.	Description
900-192-933-001	Type 1 Keypad Panel Mount Kit A (brackets have tapped holes for use with screws)
900-192-933-002	Type 1 Keypad Panel Mount Kit B (brackets have untapped holes for use with panel studs)
900-239-230-001	Type 12 / 3R Keypad Panel Mount Kit
UUX001955	Type 1/12/3R/4X LCD Keypad Panel Mount Kit

## KEYPAD CABLES

Part No.	Description
UWR0051	Keypad Remote Cable - 1 m
UWR0052	Keypad Remote Cable - 3 m
UWR01258	USB Cable for PC to Drive Communication - 3 m

## ANDROID MOBILE DEVICE INTERFACE CABLES

Part No.	Description
UWR01516-B	USB On-The-Go micro-B (Android) to mini-B (drive) - 3 m
UWR01516-C	USB On-The-Go type C (Android) to mini-B (drive) - 3 m

# FP605 ENCLOSED CONFIGURED

FP605 drive packages with features and options to fit specific application needs.

## HOW TO SELECT AN FP605 ENCLOSED CONFIGURED PACKAGE

To construct a Enclosed Configured model number, find the base number for the required enclosure type, voltage, and current rating. Add the option code for each required option. Power options are preceded by 'P'; control options are preceded by 'T'.

Base Number		Power Options		Control Options		Special Options	
<b>F6C</b>	<b>1 A</b>	<b>040</b>	<b>P</b> □□□□	<b>T</b> □□□□	<b>S</b> □		
<b>Product Series</b>						<b>Special Options</b>	
FP605 Configured						B: Bluetooth Keypad	
<b>Enclosure</b>						<b>Control &amp; Communication Options (T)</b>	
1: UL Type 1						W: Custom Nameplates	Select 1 or none
2: UL Type 12						D: EtherNet/IP dual port	Group 1 Select 1 or none <sup>*3</sup>
3: UL Type 3R						G: DeviceNet	
						H: PROFIBUS	
						J: BACnet	
						L: LonWorks Serial Communications	
<b>Voltage Class</b>						Q: Modbus TCP/IP dual port	Group 2 Select 1 or none <sup>*3</sup>
D: 208 V						E: Digital Output	
A: 240 V						N: Analog Output	
B: 480 V						6: Start & Stop Push Buttons	Select 1 or none
<b>Current</b>						7: Run (Green) & Stop (Red) Pilot Lights	Select 1 or none
Rated Amps: (Example: "040" = 40 A)						8: Fault Pilot Light (Red)	Select 1 or none
						Y: Hand/Off/Auto Switch	Select 1 or none
						Z: Speed Pot	
						9: Speed Pot & HOA Switch	
						K: Control Transformer +200 VA	Select 1 or none
						M: Keypad Viewing Window <sup>*1</sup>	Select 1 or none
<b>Power Options (P)</b>							
E: Lockable Circuit Breaker <sup>*4,*5</sup>							Select 1 or none
C: Lockable Circuit Breaker (65 kA SCCR panel rating) <sup>*4,*5</sup>							
M: Lockable Circuit Breaker (100 kA SCCR panel rating) <sup>*4,*5</sup>							
D: Lockable Disconnect switch							
F: Input Fuses <sup>*4,*5</sup>							Select 1 or none
R: Input Reactor 3% <sup>*2</sup>							Select 1 or none
H: Output Reactor 3% <sup>*2,*6</sup>							Select 1 or none
3: Space Heater <sup>*1</sup>							Select 1 or none
4: 50 °C Ambient <sup>*1</sup>							Select 1 or none
8: Motor Output Terminal Block <sup>*6</sup>							Select 1 or none

<sup>\*1:</sup> Type 3R packages only.

<sup>\*2:</sup> Option H may be substituted for option R for 208 V packages up to 150 HP, 240 V package up to 150 HP, and 480 V packages up to 600 HP.

<sup>\*3:</sup> The FP605 supports two option cards. The output option cards will be installed on the drive control board. A package may consist of one network option selected from Group 1 and one option selected from Group 2. If a network option is not selected, then both Group 2 options (N & E) may be selected.

<sup>\*4:</sup> Power option E, C, M, or F is required for models: F6C1B361 - F6C1B720, F6C2B361 - F6C2B720.

<sup>\*5:</sup> Option F is not allowed with options E, C, or M for the following package models because input fusing is automatically included: F6C1B180 - F6C1B720, F6C2B180 - F6C2B720.

<sup>\*6:</sup> Option P8 is not allowed with Option PH for the following package models because the motor output terminal block is automatically included: F6C1D143 - F6C1D273, F6C1A130 - F6C1A248, F6C1B156 - F6C1B240.



Floor and Wall Mount Packages

## FEATURES

- PID control with selectable engineering units
- Independent PID control for use with external device
- Advanced easy sleep functionality
- 24 VDC, 150 mA power supply
- Input and output status condition
- Emergency LC Override
- Built-in Modbus RTU communications

## OPTIONS

- Lockable main input disconnect switch
- Circuit breaker: 65 kA or 100 kA
- Input fuses
- Line/Load Reactor<sup>\*2</sup>
- Space Heater<sup>\*1</sup>
- 50°C Ambient<sup>\*1</sup>
- Motor Output Terminal Block
- Custom nameplate
- Door mounted speed potentiometer
- Door mounted Start/Stop Push Buttons
- Door mounted Run (Green), Stop (Red), Fault (Red) pilot lights
- Door mounted Hand/Off/Auto (HOA) Switch
- 200 VA transformer
- Keypad viewing window
- Network communications (EtherNet/IP, Modbus TCP/IP, DeviceNet, PROFIBUS)

## Models and Ratings

### 208 VAC MODELS

Base No. : F6C□□□□□		004	007	010	016	024	030	046	059	074		
Rated Output Current (A)		4.6	7.5	10.6	16.7	24.2	30.8	46.2	59.4	74.8		
Nominal HP		1	2	3	5	7.5	10	15	20	25		
Physical Size	UL Type 1	F6C1D□□□□	Height	25.9	25.9	25.9	25.9	33.9	33.9	37.1	37.1	42.1
			Width	15.7	15.7	15.7	15.7	18.7	18.7	20.8	20.8	25.6
			Depth	15.6	15.6	15.6	15.6	17.6	17.6	18.5	18.5	18.8
			Weight	90	90	91	92	124	133	166	170	221
	UL Type 12	F6C2D□□□□	Height	27.1	27.1	27.1	27.1	34.1	34.1	37.3	37.3	43.6
			Width	18.3	18.3	18.3	18.3	19.3	19.3	24.5	24.5	26.3
			Depth	18.8	18.8	18.8	18.8	18.9	18.9	19	19	21.4
			Weight	96	96	97	99	128	137	184	188	258
	UL Type 3R	F6C3D□□□□	Height	*	*	*	39.2	39.2	39.2	44.2	44.2	49.2
			Width	*	*	*	18.6	18.6	18.6	20.6	20.6	26.6
			Depth	*	*	*	18.2	18.2	18.2	20.2	20.2	22.2
			Weight	*	*	*	152	156	164	188	194	287

\* Contact factory

Base No. : F6C□□□□□		088	114	143	169	211	273	343	396		
Rated Output Current (A)		88	114	143	169	211	273	343	396		
Nominal HP		30	40	50	60	75	100	125	150		
Physical Size	UL Type 1	F6C1D□□□□	Height	42.1	42.1	53.1	53.1	53.1	53.1	87.0	87.0
			Width	25.6	25.6	33.7	33.7	33.7	33.7	42.0	42.0
			Depth	18.8	18.8	20.5	20.5	20.5	20.5	33.5	33.5
			Weight	228	240	422	432	449	515	996	1002
	UL Type 12	F6C2D□□□□	Height	43.6	43.6	55	55	55	55	85.4	85.4
			Width	26.3	26.3	33.3	33.3	33.3	33.3	41.3	41.3
			Depth	21.4	21.4	26.3	26.3	26.3	26.3	34.4	34.4
			Weight	261	273	475	480	477	544	698	800
	UL Type 3R	F6C3D□□□□	Height	49.2	49.2	61.2	61.2	93.5	93.5	93.5	93.5
			Width	26.6	26.6	38.6	38.6	43.6	43.6	43.6	43.6
			Depth	22.2	22.2	25.2	25.2	48.6	48.6	48.6	48.6
			Weight	293	305	548	557	1041	1092	1000	1100

## FP605 ENCLOSED CONFIGURED

### Models and Ratings

#### 240 VAC MODELS

Base No. : F6C□A□□□			004	006	009	015	022	028	042	054	068	
Rated Output Current (A)			4.2	6.8	9.6	15.2	22	28	42	54	68	
Nominal HP			1	2	3	5	7.5	10	15	20	25	
Physical Size	UL Type 1	F6C1A□□□	Height	25.9	25.9	25.9	25.9	33.9	33.9	37.1	37.1	42.1
			Width	15.7	15.7	15.7	15.7	18.7	18.7	20.8	20.8	25.6
			Depth	15.6	15.6	15.6	15.6	17.6	17.6	18.5	18.5	18.8
			Weight	91	91	91	92	124	128	161	169	220
	UL Type 12	F6C2A□□□	Height	27.1	27.1	27.1	27.1	34.1	34.1	37.3	37.3	43.6
			Width	18.3	18.3	18.3	18.3	19.3	19.3	24.5	24.5	26.3
			Depth	18.8	18.8	18.8	18.8	18.9	18.9	19.0	19.0	21.4
			Weight	97	99	98	98	125	132	179	187	256
	UL Type 3R	F6C3A□□□	Height	*	*	*	39.2	39.2	39.2	44.2	44.2	49.2
			Width	*	*	*	18.2	18.2	18.2	20.2	20.2	26.6
			Depth	*	*	*	19.1	19.1	19.1	21.1	21.1	22.2
			Weight	*	*	*	150	156	159	184	193	285

\* Contact factory

Base No. : F6C□A□□□			080	104	130	154	192	248	343	396	
Rated Output Current (A)			80	104	130	154	192	248	312	360	
Nominal HP			30	40	50	60	75	100	125	150	
Physical Size	UL Type 1	F6A1A□□□	Height	42.1	42.1	53.1	53.1	53.1	53.1	87.0	87.0
			Width	25.6	25.6	33.7	33.7	33.7	33.7	42.0	42.0
			Depth	18.8	18.8	20.5	20.5	20.5	20.5	33.5	33.5
			Weight	225	236	412	431	447	469	992	999
	UL Type 12	F6C2A□□□	Height	43.6	43.6	55.0	55.0	55.0	55.0	85.4	85.4
			Width	26.3	26.3	33.3	33.3	33.3	33.3	41.3	41.3
			Depth	21.4	21.4	26.3	26.3	26.3	26.3	34.4	34.4
			Weight	257	268	464	479	476	500	698	800
	UL Type 3R	F6C3A□□□	Height	49.2	49.2	61.2	61.2	93.5	93.5	93.5	93.5
			Width	26.6	26.6	38.6	38.6	43.6	43.6	43.6	43.6
			Depth	22.2	22.2	25.2	25.2	48.6	48.6	48.6	48.6
			Weight	287	300	535	555	1014	1049	1000	1100

### Models and Ratings

#### 480 VAC MODELS

Base No. : F6C□B□□□			002	003	004	007	011	014	021	027	034	040	052	065	077	
Rated Output Current (A)			2.1	3.4	4.8	7.6	11	14	21	27	34	40	52	65	77	
Nominal HP			1	2	3	5	7.5	10	15	20	25	30	40	50	60	
Physical Size	UL Type 1	F6C1B□□□	Height	25.9	25.9	25.9	25.9	25.9	25.9	33.9	33.9	33.9	37.1	37.1	37.1	42.1
			Width	15.7	15.7	15.7	15.7	15.7	15.7	18.7	18.7	18.7	20.8	20.8	20.8	25.6
			Depth	15.6	15.6	15.6	15.6	15.6	15.6	17.6	17.6	17.6	18.5	18.5	18.5	18.8
			Weight	91	91	91	92	93	99	131	133	139	163	175	183	237
	UL Type 12	F6C2B□□□	Height	27.1	27.1	27.1	27.1	27.1	27.1	34.1	34.1	34.1	37.3	37.3	37.3	43.6
			Width	18.3	18.3	18.3	18.3	18.3	18.3	19.3	19.3	19.3	24.5	24.5	24.5	26.3
			Depth	18.8	18.8	18.8	18.8	18.8	18.8	18.9	18.9	18.9	19.0	19.0	19.0	21.4
			Weight	100	100	100	100	100	111	137	138	145	181	193	200	272
	UL Type 3R	F6C3B□□□	Height	*	*	*	39.2	39.2	39.2	39.2	39.2	39.2	44.2	44.2	44.2	49.2
			Width	*	*	*	18.6	18.6	18.6	18.6	18.6	18.6	20.6	20.6	20.6	26.6
			Depth	*	*	*	18.2	18.2	18.2	18.2	18.2	18.2	20.2	20.2	20.2	22.2
			Weight	*	*	*	155	155	159	163	165	171	185	198	205	300

\* Contact factory

Base No. : F6C□B□□□			096	124	156	180	240	302	361	414	477	515	590	720	
Rated Output Current (A)			96	124	156	180	240	302	361	414	477	515	590	720	
Nominal HP			75	100	125	150	200	250	300	350	400	450	500	600	
Physical Size	UL Type 1	F6C1B□□□	Height	42.1	42.1	53.1	53.1	53.1	87.0	87.0	87.0	87.1	87.1	87.1	87.1
			Width	25.6	25.6	33.7	33.7	33.7	42.0	42.0	42.0	66.3	66.3	66.3	66.3
			Depth	18.8	18.8	20.5	20.5	20.5	33.5	33.5	33.5	33.2	33.2	33.2	33.2
			Weight	245	264	439	463	490	980	1010	1065	1511	1566	1630	1630
	UL Type 12	F6C2B□□□	Height	43.6	43.6	55.0	55.0	55.0	85.4	85.4	85.4	87.1	87.1	87.1	87.1
			Width	26.3	26.3	33.3	33.3	33.3	41.3	41.3	41.3	66.3	66.3	66.3	66.3
			Depth	21.4	21.4	26.3	26.3	26.3	34.4	34.4	34.4	33.2	33.2	33.2	33.2
			Weight	276	295	490	494	522	929	873	932	1384	1441	1494	1520
	UL Type 3R	F6C3B□□□	Height	49.2	49.2	61.2	93.5	93.5	93.5	93.5	93.5	93.5	93.5	93.5	93.5
			Width	26.6	26.6	38.6	43.6	43.6	43.6	43.6	43.6	43.6	43.6	43.6	43.6
			Depth	22.2	22.2	25.2	48.6	48.6	48.6	48.6	48.6	48.6	48.6	48.6	48.6
			Weight	308	334	566	1026	1070	1189	1150	1175	1400	1500	1550	1575

# FP605 ENCLOSED BYPASS

FP605 drive packages with features and options to fit specific application needs

## HOW TO SELECT AN FP605 ENCLOSED BYPASS PACKAGE

To construct an Enclosed Bypass model number, find the base number for the required enclosure type, voltage, and current rating. Add the option code for each required option. Power options are preceded by 'P', control options are preceded by 'T'.

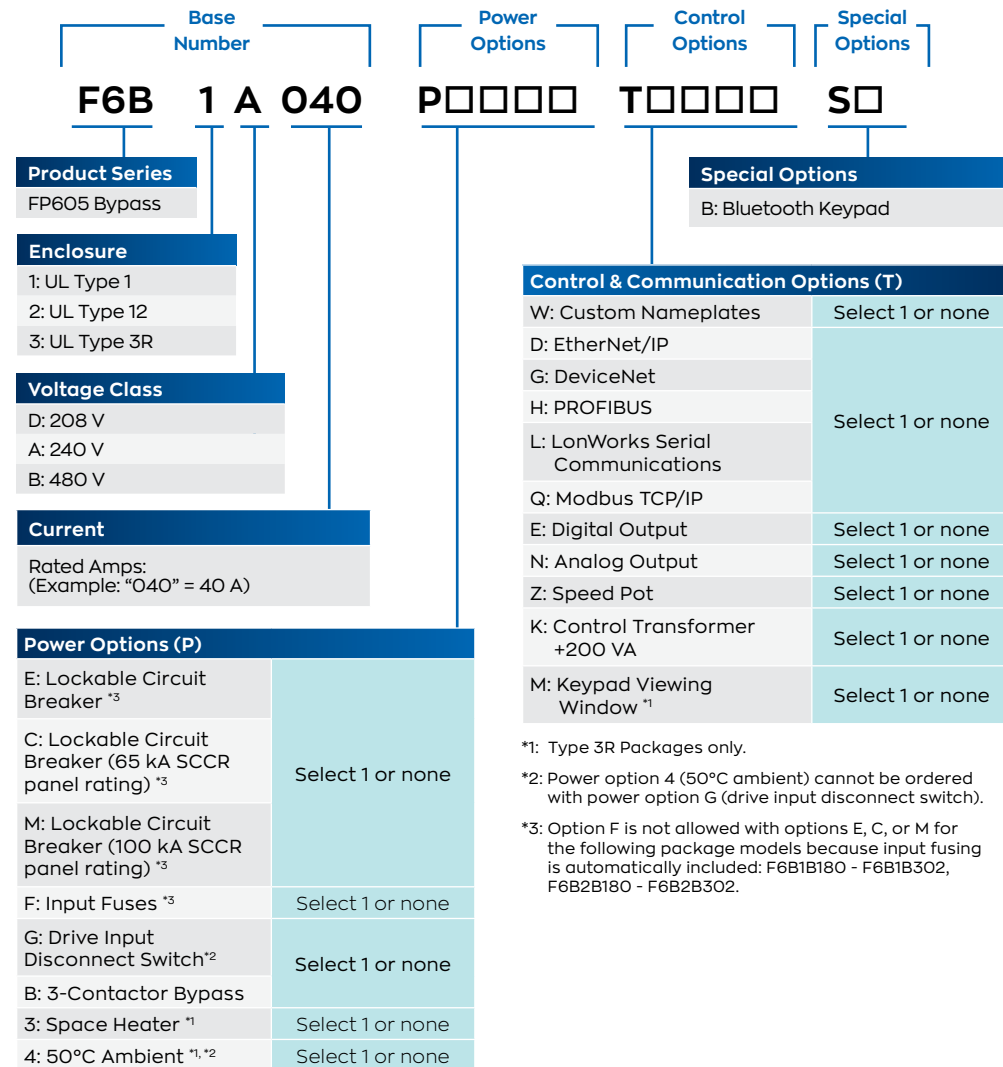

Floor and Wall Mount Packages

## FEATURES

- Two-contactor bypass
- Non-fused disconnect
- HOA keypad
- Standard digital inputs
  - Run
  - Safety
  - BAS interlock
  - Auto transfer to bypass
  - Emergency override
- (4) Form C programmable relays
- Built-in communications
  - BACnet
  - APOGEE
  - Metasys
  - Modbus

## OPTIONS

- Circuit breaker: 65 kAIC or 100 kAIC
- Drive input disconnect switch
- Three-contactor bypass
- Input fusing
- Space heater\*1
- 50°C Ambient\*1
- Custom nameplate
- Additional digital/analog outputs
- Keypad viewing window\*1
- Door-mounted speed potentiometer
- 200 VA control transformer
- Network communications (EtherNet/IP, Modbus TCP/IP, DeviceNet, PROFIBUS)

## Models and Ratings

### 208 VAC MODELS

Base No. : F6B□□□□		004	007	010	016	024	030	046	059		
Rated Output Current (A)		4.6	7.5	10.6	16.7	24.2	30.8	46.2	59.4		
Nominal HP		1	2	3	5	7.5	10	15	20		
Physical Size	UL Type 1	F6B1D□□□	Height	25.9	25.9	25.9	25.9	33.9	33.9	37.1	37.1
			Width	15.7	15.7	15.7	15.7	18.7	18.7	20.7	20.7
			Depth	15.6	15.6	15.6	15.6	17.6	17.6	18.5	18.5
			Weight	93	93	93	93	125	128	159	163
	UL Type 12	F6B2D□□□	Height	27.1	27.1	27.1	27.1	34.1	34.1	37.3	37.3
			Width	18.3	18.3	18.3	18.3	19.3	19.3	24.5	24.5
			Depth	18.8	18.8	18.8	18.8	18.9	18.9	19.0	19.0
			Weight	104	104	104	104	137	140	186	190
	UL Type 3R	F6B3D□□□	Height	*	*	*	39.2	39.2	39.2	44.2	44.2
			Width	*	*	*	18.6	18.6	18.6	20.6	20.6
			Depth	*	*	*	18.2	18.2	18.2	20.2	20.2
			Weight	*	*	*	150	155	157	176	182

\* Contact factory

Base No. : F6B□□□□		074	088	114	143	169	211	273		
Rated Output Current (A)		74.8	88	114	143	169	211	273		
Nominal HP		25	30	40	50	60	75	100		
Physical Size	UL Type 1	F6B1D□□□	Height	42.1	42.1	42.1	53.1	53.1	87	87
			Width	25.6	25.6	25.6	33.7	33.7	42	42
			Depth	18.8	18.8	18.8	20.5	20.5	33.5	33.5
			Weight	224	233	248	419	434	832	859
	UL Type 12	F6B2D□□□	Height	43.6	43.6	43.6	55.0	55.0	85.4	85.4
			Width	26.3	26.3	26.3	33.3	33.3	41.3	41.3
			Depth	21.4	21.4	21.4	26.3	26.3	34.4	34.4
			Weight	265	270	288	480	490	832	851
	UL Type 3R	F6B3D□□□	Height	49.2	49.2	49.2	61.2	61.2	93.5	93.5
			Width	26.6	26.6	26.6	38.6	38.6	43.6	43.6
			Depth	22.2	22.2	22.2	25.2	25.2	48.6	48.6
			Weight	284	289	300	554	567	1039	1054

## FP605 ENCLOSED BYPASS

### Models and Ratings

#### 240 VAC MODELS

Base No. : F6B□A□□□			004	006	009	015	022	028	042	054
Rated Output Current (A)			4.2	6.8	9.6	15.2	22	28	42	54
Nominal HP			1	2	3	5	7.5	10	15	20
Physical Size	UL Type 1 F6B1A□□□	Height	25.9	25.9	25.9	25.9	33.9	33.9	37.1	37.1
		Width	15.7	15.7	15.7	15.7	18.7	18.7	20.7	20.7
		Depth	15.6	15.6	15.6	15.6	17.6	17.6	18.5	18.5
		Weight	93	93	93	93	125	128	159	163
	UL Type 12 F6B2A□□□	Height	27.1	27.1	27.1	27.1	34.1	34.1	37.3	37.3
		Width	18.3	18.3	18.3	18.3	19.3	19.3	24.5	24.5
		Depth	18.8	18.8	18.8	18.8	18.9	18.9	19.0	19.0
		Weight	104	104	104	104	137	140	186	190
	UL Type 3R F6B3A□□□	Height	*	*	*	39.2	39.2	39.2	44.2	44.2
		Width	*	*	*	18.6	18.6	18.6	20.6	20.6
		Depth	*	*	*	18.2	18.2	18.2	20.2	20.2
		Weight	*	*	*	150	154	156	176	181

\* Contact factory

Base No. : F6B□A□□□			068	080	104	130	154	192	248
Rated Output Current (A)			68	80	104	130	154	192	248
Nominal HP			25	30	40	50	60	75	100
Physical Size	UL Type 1 F6B1A□□□	Height	42.1	42.1	42.1	53.1	53.1	87.0	87.0
		Width	25.6	25.6	25.6	33.7	33.7	42.0	42.0
		Depth	18.8	18.8	18.8	20.5	20.5	33.5	33.5
		Weight	224	228	243	414	430	803	859
	UL Type 12 F6B2A□□□	Height	43.6	43.6	43.6	55.0	55.0	85.4	85.4
		Width	26.3	26.3	26.3	33.3	33.3	41.3	41.3
		Depth	21.4	21.4	21.4	26.3	26.3	34.4	34.4
		Weight	265	270	288	480	490	832	851
	UL Type 3R F6B3A□□□	Height	49.2	49.2	49.2	61.2	61.2	93.5	93.5
		Width	26.6	26.6	26.6	38.6	38.6	43.6	43.6
		Depth	22.2	22.2	22.2	25.2	25.2	48.6	48.6
		Weight	285	285	304	545	563	1019	1055

### Models and Ratings

#### 480 VAC MODELS

Base No. : F6B□B□□□			002	003	004	007	011	014	021	027	034	040
Rated Output Current (A)			2.1	3.4	4.8	7.6	11	14	21	27	34	40
Nominal HP			1	2	3	5	7.5	10	15	20	25	30
Physical Size	UL Type 1 F6B1B□□□	Height	25.9	25.9	25.9	25.9	25.9	25.9	33.9	33.9	33.9	37.1
		Width	15.7	15.7	15.7	15.7	15.7	15.7	18.7	18.7	18.7	20.7
		Depth	15.6	15.6	15.6	15.6	15.6	15.6	17.6	17.6	17.6	18.5
		Weight	93	93	93	94	94	94	125	129	137	162
	UL Type 12 F6B2B□□□	Height	27.1	27.1	27.1	27.1	27.1	27.1	34.1	34.1	34.1	37.3
		Width	18.3	18.3	18.3	18.3	18.3	18.3	19.3	19.3	19.3	24.5
		Depth	18.8	18.8	18.8	18.8	18.8	18.8	18.9	18.9	18.9	19.0
		Weight	106	106	106	106	113	113	139	142	150	187
	UL Type 3R F6B3B□□□	Height	*	*	*	39.2	39.2	39.2	39.2	39.2	39.2	44.2
		Width	*	*	*	18.6	18.6	18.6	18.6	18.6	18.6	20.6
		Depth	*	*	*	18.2	18.2	18.2	18.2	18.2	18.2	20.2
		Weight	*	*	*	152	152	152	155	158	164	178

\* Contact factory

Base No. : F6B□B□□□			052	065	077	096	124	156	180	240	302
Rated Output Current (A)			52	65	77	96	124	156	180	240	302
Nominal HP			40	50	60	75	100	125	150	200	250
Physical Size	UL Type 1 F6B1B□□□	Height	37.1	37.1	42.1	42.1	42.1	53.1	87.0	87.0	87.0
		Width	20.7	20.7	25.6	25.6	25.6	33.7	42.0	42.0	42.0
		Depth	18.5	18.5	18.8	18.8	18.8	20.5	33.5	33.5	33.5
		Weight	168	179	233	247	263	431	803	857	964
	UL Type 12 F6B2B□□□	Height	37.3	37.3	43.6	43.6	43.6	55.0	85.4	85.4	85.4
		Width	24.5	24.5	26.3	26.3	26.3	33.3	41.3	41.3	41.3
		Depth	19.0	19.0	21.4	21.4	21.4	26.3	34.4	34.4	34.4
		Weight	195	204	339	355	372	491	807	849	936
	UL Type 3R F6B3B□□□	Height	44.2	44.2	49.2	49.2	49.2	61.2	93.5	93.5	93.5
		Width	20.6	20.6	26.6	26.6	26.6	38.6	43.6	43.6	43.6
		Depth	20.2	20.2	22.2	22.2	22.2	25.2	48.6	48.6	48.6
		Weight	185	200	290	307	320	567	1014	1057	1163



# BYPASS SCHEMATIC

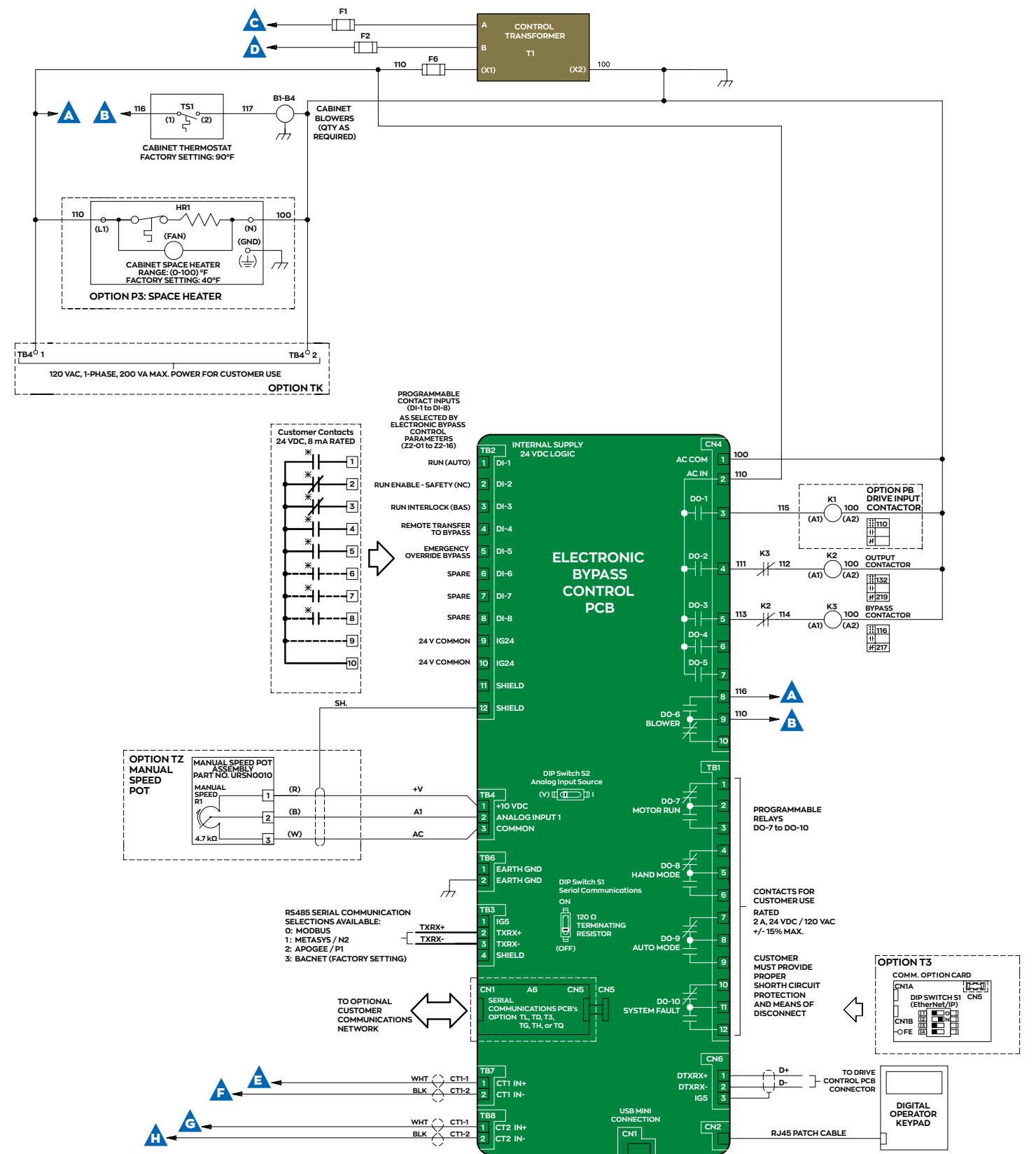
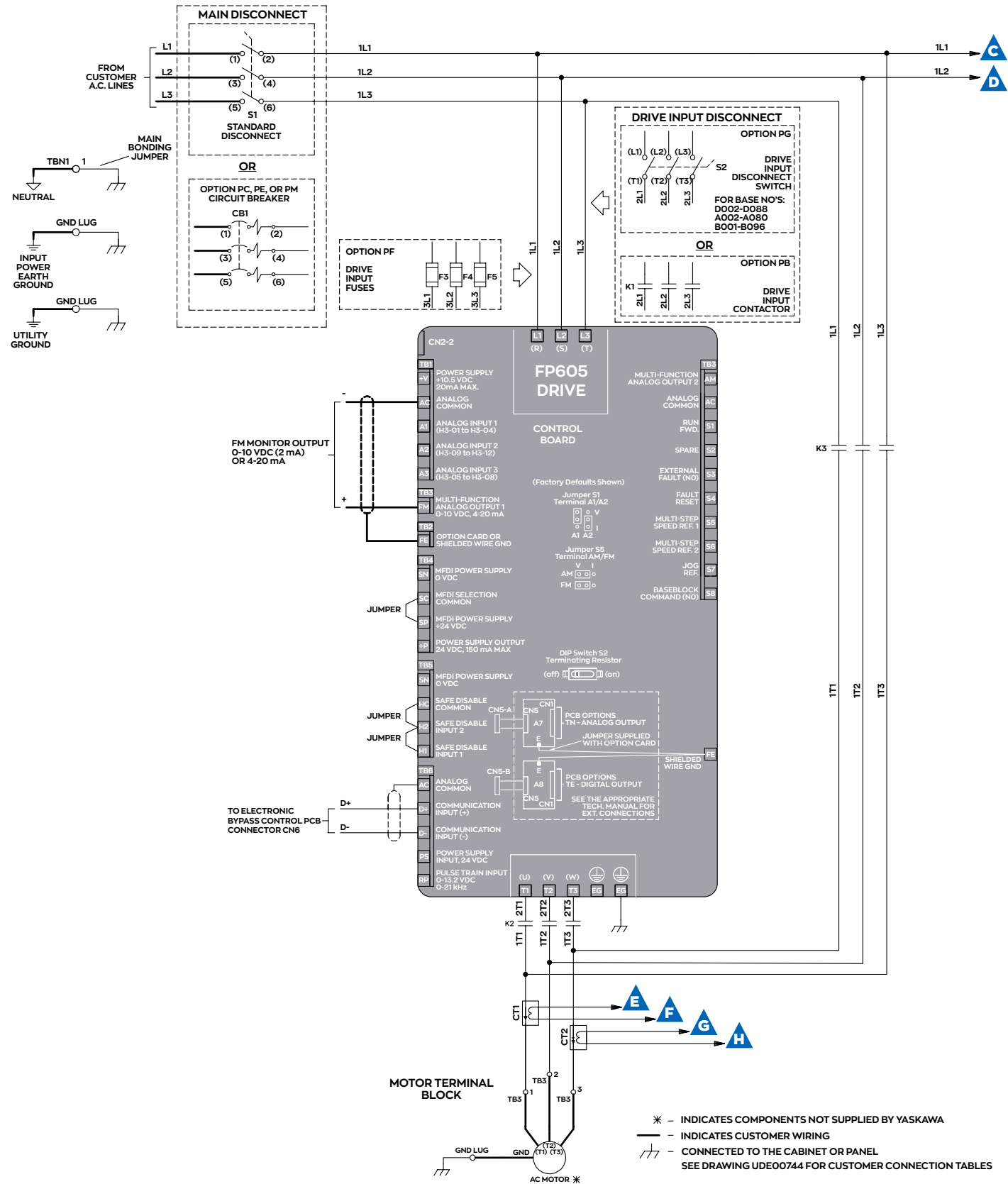

# ENGINEERING & SUPPORT

## ENGINEERING CAPABILITY

Yaskawa has the engineering capability to design and build UL508A control panels to meet any customer needs. Fan array control panels, redundant drive panels, and multi-pulse arrangements with a wide range of accessories and options can be quoted and delivered in minimal time. Let Yaskawa deliver per your specific needs.

## TECHNICAL TRAINING

Both standard and customized courses are available with hands-on activities and demonstrations. Instruction is offered at Yaskawa locations as well as traveling road schools, and is supplemented by live web classes and e-Learning modules / videos to provide the right level of training to fit your needs. Trainers are degreed engineers with extensive industry experience who train over 3,000 customers worldwide each year, with thousands more viewing learning modules online.



Engineered Panel



Traveling Road Show Van

# YASKAWA SOLUTION CENTER

The Yaskawa Solution Center is a web portal for learning about all things Yaskawa. More specifically, it is designed to help customers get specific support for their product questions and needs.

We recognize that our customers may not want to get help only by phone. That's why we created the Yaskawa Solution Center, an online tool to readily find resources for things like:

- Step-by-step instructions, including video tutorials
- Help configuring a product for a new application
- Starting up a product for the first time
- Transitioning from an older legacy product to a current one

This information is delivered via technical documents and manuals, video, and authored content based on real case scenarios in real time.

The Solutions Center also includes a crowd-sourcing feature. By allowing all visitors to provide feedback on anything they find on the site, we can improve, correct and add content. Even Yaskawa sales associates continuously submit feedback to content based on what they see and learn in the field. The site is literally updated in real time!

All of this collaboration between Yaskawa associates, distributors, OEMs and end-users makes the Solution Center more and more valuable to our customers every day.



Crowd-Sourcing Feature  
Content is continuously added and updated in real time.

## WORLDWIDE CUSTOMER SUPPORT

Yaskawa offers worldwide support with application assistance, start up, maintenance, troubleshooting and repair, as well as internet tools and telephone support. Sales and service offices are located around the world.

**SUPPORT AVAILABLE**

**24/7/365**

In the Americas, telephone assistance is available 24/7/365 at 1-800-YASKAWA (927-5292). Our phone support group is product certified to assist you with current and legacy drive requirements.

Yaskawa's Field Service personnel and local Authorized Service Providers can provide on-site start-up assistance, troubleshooting, and repair. Same day exchange units or fast turnaround repairs are available.



The Customer Relationship Management Institute has honored Yaskawa with the NorthFace ScoreBoard Award nine years running for excellence in technical support.

VISIT [HTTPS://SOLUTIONCENTER.YASKAWA.COM/](https://solutioncenter.yaskawa.com/)

Bridging the gap between what you are trying to do and the technical information you need to accomplish it.

**Videos**  
Easy-to-use and follow instructional videos.

**User Manuals**  
Online access to instructions on how to install, operate and troubleshoot.

**Technical Documents**  
Complete library of parts and specs for our products.



YASKAWA.COM



Yaskawa is the leading global manufacturer of low and medium voltage variable frequency drives, servo systems, machine controllers and industrial robots. Our standard products, as well as tailor-made solutions, are well known and have a high reputation for outstanding quality and reliability.

**YASKAWA**

**Yaskawa America, Inc.** | Drives & Motion Division

1-800-YASKAWA | Email: [info@yaskawa.com](mailto:info@yaskawa.com) | [yaskawa.com](http://yaskawa.com)

Document No. BL.FP605.01 | 06/29/2023 | © 2022 Yaskawa America, Inc.