ABB DRIVES FOR HVAC

ACH480 HVAC control program

Firmware manual



Related documents are listed on page [15](#).



Table of contents

**ACH480
HVAC control program**

Firmware manual

1. Introduction to the manual

2. Start-up, control with I/O and ID run

3. Control panel

4. Settings, I/O and diagnostics on the control panel

5. Default I/O configuration

6. Program features

7. Fault tracing

8. Modbus RTU control through the embedded fieldbus interface (EFB)

9. BACnet MS/TP control through the embedded fieldbus interface (EFB)

10. N2 control through the embedded fieldbus interface (EFB)

11. Fieldbus control through a fieldbus adapter

12. Control chain diagrams

13. Parameters

14. Additional parameter data



Table of contents

1. Introduction to the manual

Contents of this chapter	13
Applicability	13
Safety instructions	13
Target audience	13
Purpose of the manual	14
Contents of this manual	14
Related documents	15
Cybersecurity disclaimer	19

2. Start-up, control with I/O and ID run

Contents of this chapter	21
How to start up the drive	22
How to start up the drive using the First start assistant on the Hand-Off-Auto control panel	22
How to control the drive through the I/O interface	32
How to perform the ID run	33
ID run procedure	34

3. Control panel

Contents of this chapter	41
Removing and reinstalling the control panel	41
Layout of the control panel	42
Layout of the control panel display	43
Home view displays	46
IPC additional Home view displays	48
Keys	49
Key shortcuts	50

4. Settings, I/O and diagnostics on the control panel

Contents of this chapter	53
Primary settings	54
HVAC quick setup	55
Assistants	56
Start, stop, reference	58
Motor	61
Pump features	63
PID control	65
Multipump control	67
Ramps	71
Limits	72
Communication	73



6 Table of contents

Override	77
Fault functions	78
Security	79
Advanced functions	80
Clock, region, display	82
Reset to defaults	84
I/O menu	86
Diagnostics menu	88
System info menu	90
Energy efficiency menu	91
Backups menu	93
Options menu	93

5. Default I/O configuration

Contents of this chapter	95
Selecting default configurations	95
HVAC default	97
PID control, single motor	99

6. Program features

What this chapter contains	101
Local control vs. external control	101
Local control	102
External control	102
Operating modes of the drive	105
Drive configuration and programming	106
Configuring via default configurations	106
Configuring via menus	106
Configuring via parameters	106
Adaptive programming	107
Control interfaces	110
Programmable analog inputs	110
Programmable analog outputs	110
Programmable digital inputs and outputs	110
Programmable frequency input and output	110
Programmable relay outputs	110
Programmable I/O extensions	111
Fieldbus control	111
Pump and fan control features	112
Intelligent pump control (IPC)	112
IPC master autochange	116
Application example: IPC system with three drives and three pumps	119
Single pump and fan control (PFC/SPFC)	124
Application example 1: Supply fan, Basic speed follower	132
Application example 2: Supply fan, basic speed follower with interlock and status	133
Application example 3: Supply fan, speed follower complete integration	135
Application example 4: Supply fan, PID control	137
Application example 5: Cooling tower fan, speed follower	139
Application example 6: Cooling tower, PID	141



Application example 7: Chilled water pump	144
Application example 8: Condenser water pump	146
Soft pipe fill	147
Sensorless flow calculation	148
Dry pump protection	151
Automatic fault resets	152
External events	153
Constant speeds/frequencies	153
Critical speeds/frequencies	153
Timed functions	155
Ramps	156
Overview	156
Functionality	156
Application examples	159
Process PID control	160
Limits	163
Limits overview	163
Application examples	163
Override	164
Overview	164
Activating the Override mode	164
Reference for Override frequency	165
Override mode features	165
Application example 1: Override for single Override frequency control	168
Application example 2: Override for PID control	171
Interlocks	174
Overview	174
Configuration	174
Wiring connections	175
Functionality	175
Application examples of interlocks	175
Run permissives	178
Overview	178
Configuration	178
Wiring connections	178
Functionality	179
Application example 1: Damper end switch	180
Application example 2: Valve opening	180
Motor control	181
Frequency control mode	181
Scalar motor control	181
Speed control mode	182
Vector motor control	182
Motor types	183
Motor identification	183
U/f ratio	183
Flux braking	184
Start methods – DC magnetization	185
Switching frequency	187
Motor thermal protection	188
Motor overload protection	193



8 Table of contents

Speed control performance figures	195
Floating point control (Motor potentiometer)	195
DC voltage control	198
Overvoltage control	198
Undervoltage control (power loss ride-through)	198
Voltage control and trip limits	199
Brake chopper	202
Supervisory	203
Signal supervision	203
Application example 1: Dirty filter	203
Application example 2: High current	203
User load curve	204
Energy efficiency	206
Energy optimization	206
Energy saving calculators	206
Load analyzer	207
User parameter sets	208
System safety and protections	209
Fixed/Standard protections	209
Programmable protection functions	209
Emergency stop	210
Diagnostics	212
Diagnostics menu	212
Miscellaneous	213
Backup and restore	213
Data storage parameters	214
Parameter checksum calculation	214
User lock	215
Sine filter support	216
AI dead band	216

7. Fault tracing

What this chapter contains	219
Safety	219
Indications	219
Warnings and faults	219
Pure events	220
Editable messages	220
Warning/fault history	220
Event log	220
Viewing warning/fault information	220
QR code generation for mobile service application	221
Warning messages	222
Fault messages	235

8. Modbus RTU control through the embedded fieldbus interface (EFB)

What this chapter contains	249
System overview	249
	250



Connecting the drive to the fieldbus	250
Setting up the embedded fieldbus interface	251
Setting the drive control parameters	252
Basics of the embedded fieldbus interface	254
Control word and Status word	255
References	255
Actual values	255
Data input/outputs	255
Register addressing	255
About the control profiles	257
Control Word	258
Control Word for the ABB Drives profile	258
Control Word for the DCU Profile	259
Status Word	262
Status Word for the ABB Drives profile	262
Status Word for the DCU Profile	263
State transition diagrams	265
State transition diagram for the ABB Drives profile	265
References	268
References for the ABB Drives profile and DCU Profile	268
Actual values	269
Actual values for the ABB Drives profile and DCU Profile	269
Modbus holding register addresses	270
Modbus holding register addresses for the ABB Drives profile and DCU Profile	270
Modbus function codes	271
Exception codes	272
Coils (0xxxx reference set)	273
Discrete inputs (1xxxx reference set)	275
Error code registers (holding registers 400090...400100)	277

9. BACnet MS/TP control through the embedded fieldbus interface (EFB)

Contents of this chapter	279
BACnet overview	279
Hardware installation	279
Connecting devices to a BACnet MS/TP EIA-485 network	279
Starting up BACnet communication through the Primary settings menu	280
Starting up fieldbus communication with parameters	284
Activating drive control functions	285
Drive control	285
Communication fault	289
Drive feedback	289
Parameter setting example	292
Frequency control	292
BACnet protocol implementation conformance statement	293
Product description:	293
BACnet standardized device profile (Annex L):	293
List all BACnet interoperability building blocks supported (Annex K):	293
Segmentation capability:	294
Standard object types supported:	294



Data link layer options:	294
Device address binding:	294
Networking options:	294
Network security options:	295
Character sets supported:	295
Object/Property support matrix	296
Device object instance summary	296
Binary input object instance summary	297
Binary output object instance summary	298
Binary value object instance summary	298
Analog input object instance summary	300
Analog output object instance summary	300
Analog value object instance summary	301
Multistate value object instance summary	305
Loop object instance summary	307

10. N2 control through the embedded fieldbus interface (EFB)

Contents of this chapter	309
N2 overview	309
Supported features	310
Metasys integration	311
Drive device type	312
Hardware installation	312
Connecting devices to a N2 EIA-485 network	312
N2 analog input objects	313
N2 binary input objects	314
N2 analog output objects	315
N2 binary output objects	317
DDL file for NCU	318

11. Fieldbus control through a fieldbus adapter

What this chapter contains	323
System overview	323
Basics of the fieldbus control interface	325
Control word and Status word	325
References	326
Actual values	327
Contents of the fieldbus Control word (ABB Drives profile)	328
Contents of the fieldbus Status word (ABB Drives profile)	329
The state diagram	330
Setting up the drive for fieldbus control	331
Parameter setting example: FPBA (PROFIBUS DP) with ABB Drives profile	332
Parameter setting example: FPBA (PROFIBUS DP) with PROFIdrive profile	334
Automatic drive configuration for fieldbus control	336

12. Control chain diagrams

Contents of this chapter	339
Frequency reference selection	340



Frequency reference modification	341
Speed reference source selection I	342
Speed reference source selection II	343
Speed reference ramping and shaping	344
Speed error calculation	345
Speed feedback	346
Speed controller	347
Torque limitation	348
PID flow calculation	349
PID setpoint compensation	350
Process PID setpoint and feedback source selection	351
Process PID controller	352
External PID setpoint and feedback source selection	353
External PID controller	354
Direction lock	355
Override	356

13. Parameters

What this chapter contains	357
Terms and abbreviations	358
Summary of parameter groups	359
Parameter listing	361
01 Actual values	361
03 Input references	364
04 Warnings and faults	365
05 Diagnostics	367
06 Control and status words	370
07 System info	377
10 Standard DI, RO	379
11 Standard DIO, FI, FO	390
12 Standard AI	398
13 Standard AO	404
15 I/O extension module	410
19 Operation mode	419
20 Start/stop/direction	421
21 Start/stop mode	430
22 Speed reference selection	439
23 Speed reference ramp	449
24 Speed reference conditioning	452
25 Speed control	453
28 Frequency reference chain	457
30 Limits	467
31 Fault functions	475
32 Supervision	485
34 Timed functions	496
35 Motor thermal protection	504
36 Load analyzer	514
37 User load curve	517
40 Process PID set 1	521
41 Process PID set 2	537



<i>43 Brake chopper</i>	540
<i>45 Energy efficiency</i>	542
<i>46 Monitoring/scaling settings</i>	546
<i>47 Data storage</i>	549
<i>49 Panel port communication</i>	551
<i>50 Fieldbus adapter (FBA)</i>	552
<i>51 FBA A settings</i>	556
<i>52 FBA A data in</i>	557
<i>53 FBA A data out</i>	558
<i>58 Embedded fieldbus</i>	558
<i>70 Override</i>	567
<i>71 External PID1</i>	572
<i>76 Multipump configuration</i>	575
<i>77 Multipump maintenance and monitoring</i>	586
<i>80 Flow calculation</i>	588
<i>81 Sensor settings</i>	593
<i>82 Pump protections</i>	595
<i>84 Advanced damper control</i>	598
<i>95 HW configuration</i>	604
<i>96 System</i>	607
<i>97 Motor control</i>	618
<i>98 User motor parameters</i>	621
<i>99 Motor data</i>	623
Differences in the default values between 50 Hz and 60 Hz supply frequency settings	629
Parameters supported by Modbus legacy compatibility	630

14. Additional parameter data

What this chapter contains	633
Terms and abbreviations	633
Fieldbus addresses	634
Parameter groups 1...9	635
Parameter groups 10...99	639

Further information

Product and service inquiries	675
Product training	675
Providing feedback on ABB Drives manuals	675
Document library on the Internet	675

1

Introduction to the manual

Contents of this chapter

The chapter describes applicability, target audience and purpose of this manual. It also describes the contents of this manual and refers to a list of related manuals for more information.

Applicability

The manual applies to the ACH480 HVAC control program (version 2.12, firmware AHVDA).

To check the firmware version of the control program in use, see system information (select **Menu > System info > Drive**) or parameter [07.05 Firmware version](#) on the control panel.

Safety instructions

Follow all safety instructions.

- Read the **complete safety instructions** in the *Hardware manual* of the drive before you install, commission, or use the drive.
- Read the **firmware function-specific warnings and notes** before changing parameter values. These warnings and notes are included in the parameter descriptions presented in chapter [Parameters](#) on page [219](#).

Target audience

The reader is expected to know the fundamentals of electricity, wiring, electrical components and electrical schematic symbols.

The manual is written for readers worldwide. Both SI and imperial units are shown. Special US instructions for installations in the United States are given.

Purpose of the manual

This manual provides information needed for designing, commissioning, or operating the drive system.

Contents of this manual

This manual consists of the following chapters:

- [Introduction to the manual](#) (this chapter) describes applicability, target audience, purpose and contents of this manual. At the end, it lists terms and abbreviations.
 - [Start-up, control with I/O and ID run](#) (page 21) describes how to start up the drive as well as how to start, change the direction of the motor rotation and adjust the motor speed through the I/O interface.
 - [Control panel](#) (page 41) contains instructions for removing and reinstalling the assistant control panel and briefly describes its display, keys, key shortcuts and home view displays.
 - [Settings, I/O and diagnostics on the control panel](#) (page 53) describes the simplified settings and diagnostic functions provided on the assistant control panel.
 - [Default I/O configuration](#) (page 95) contains the connection diagram of the HVAC default configuration together with a connection diagram. The predefined default configuration will save the user time when configuring the drive.
 - [Program features](#) (page 101) describes program features with lists of related user settings, actual signals, and fault and warning messages.
 - [Modbus RTU control through the embedded fieldbus interface \(EFB\)](#) (page 249) describes the communication to and from a fieldbus network using the drive embedded fieldbus interface with the Modbus RTU protocol.
 - [BACnet MS/TP control through the embedded fieldbus interface \(EFB\)](#) (page 279) describes the communication to and from a fieldbus network using the drive embedded fieldbus interface with the BACnet MS/TP protocol.
 - [N2 control through the embedded fieldbus interface \(EFB\)](#) (page 309) describes the communication to and from a fieldbus network using the drive embedded fieldbus interface with the N2 protocol.
 - [Fieldbus control through a fieldbus adapter](#) (page 323) describes the communication to and from a fieldbus network using an optional fieldbus adapter module.
 - [Fault tracing](#) (page 219) lists the warning and fault messages with possible causes and remedies.
 - [Control chain diagrams](#) (page 339) describes the parameter structure within the drive.
-

- [Parameters](#) (page 219) describes the parameters used to program the drive.
- [Additional parameter data](#) (page 633) contains further information on the parameters.
- [Further information](#) (inside of the back cover, page 675) describes how to make product and service inquiries, get information on product training, provide feedback on ABB Drives manuals and find documents on the Internet.

Related documents

You can find manuals and other product documents in PDF format on the Internet. See section [Document library on the Internet](#) on the inside of the back cover. For manuals not available in the Document library, contact your local ABB representative.

Drive manuals and guides	Code (English)
<i>Safety instructions</i>	3AXD50000037978
<i>ACH480 HVAC control program firmware manual</i>	3AXD50000247134
<i>ACH480 hardware manual</i>	3AXD50000245949
<i>ACH480 drives quick installation and start-up guide</i>	3AXD50000247141
<i>Adaptive programming Application Guide</i>	3AXD50000028574
<i>ACS-AP-I, -S, -W and ACH-AP-H, -W Assistant control panels user's manual</i>	3AUA0000085685
Option manuals and guides	
<i>DPMP-01 control panel mounting platform kit installation guide</i>	3AUA0000100140
<i>DPMP-02/03 mounting platform for control panels</i>	3AUA0000136205
<i>FBIP-21 BACnet/IP adapter module user's manual</i>	3AXD50000028468
<i>FCAN-01 CANopen adapter module user's manual</i>	3AFE68615500
<i>FCNA-01 ControlNet adapter module user's manual</i>	3AUA0000141650
<i>FDNA-01 DeviceNet Adapter User's Manual</i>	3AFE68573360
<i>FECA-01 EtherCAT adapter module user's manual</i>	3AUA0000068940
<i>FEIP-21 EtherNet/IP fieldbus adapter module User's manual</i>	3AXD50000158621
<i>FENA-01/-11/-21 Ethernet adapter module user's manual</i>	3AUA0000093568
<i>FEPL-02 Ethernet POWERLINK adapter module user's manual</i>	3AUA0000123527
<i>FMBT-21 Modbus/TCP Adapter Module User's Manual</i>	3AXD50000158607
<i>FPBA-01 PROFIBUS DP adapter module user's manual</i>	3AFE68573271
<i>FPNQ-21 PROFINET IO fieldbus adapter module user's manual</i>	3AXD50000158614
<i>FSCA-01 RS-485 adapter module user's manual</i>	3AUA0000109533
Tool and maintenance manuals and guides	
<i>Drive composer start-up and maintenance PC tool user's manual</i>	3AUA0000094606
<i>Capacitor reforming instructions</i>	3BFE64059629

<i>NETA-21 remote monitoring tool user's manual</i>	3AJA0000096939
<i>NETA-21 remote monitoring tool installation and start-up guide</i>	3AJA0000096881

The code below opens online listings of the manuals applicable to the product.



[ACH480-01 manuals](#)

Categorization by frame (size)

The ACH480 is manufactured in several frames (frame sizes), which are denoted as RN, where N is an integer. Some information which only concern certain frames are marked with the symbol of the frame (RN).

The frame is marked on the type designation label attached to the drive, see chapter *Operation principle and hardware description*, section *Type designation label* in the *Hardware manual* of the drive.

Terms and abbreviations

Term/abbreviation	Explanation
ACx-AP-x	Assistant control panel, advanced operator keypad for communication with the drive. The ACH480 supports the Hand-Off-Auto control panels ACH-AP-H and ACH-AP-W (with a Bluetooth interface)
AI	Analog input; interface for analog input signals
AO	Analog output; interface for analog output signals
BAPO-01	Side option module for external power supply 24V.
BACnet™	BACnet™ is a registered trademark of American Society of Heating, Refrigerating and Air-Conditioning Engineers (ASHRAE).
BAS	Building automation system
BIO-01	Frontal I/O extension. Can be used simultaneously with a fieldbus adapter module.
BMS	Building management system
Brake chopper	Conducts the surplus energy from the intermediate circuit of the drive to the brake resistor when necessary. The chopper operates when the DC link voltage exceeds a certain maximum limit. The voltage rise is typically caused by deceleration (braking) of a high inertia motor.
Brake resistor	Dissipates the drive surplus braking energy conducted by the brake chopper to heat. Essential part of the brake circuit. See chapter <i>Brake chopper</i> in the <i>Hardware manual</i> of the drive.
BREL-01	Optional side-mounted relay output extension module
Control board	Circuit board in which the control program runs.
CCA-01	Cold configuration adapter
CDPI-02	Communication adapter module
CRC	Cyclic redundancy check. The IPC checks the parameter group validity in terms of CRC.
DC link	DC circuit between rectifier and inverter
DC link capacitors	Energy storage which stabilizes the intermediate circuit DC voltage
DI	Digital input; interface for digital input signals
DO	Digital output; interface for digital output signals
DPMP-01	Mounting platform for ACx-AP control panel (flange mounting)
DPMP-02/03	Mounting platform for ACx-AP control panel (surface mounting)
Drive	Frequency converter for controlling AC motors
EFB	Embedded fieldbus
FBA	Fieldbus adapter
FBIP-21	Optional BACnet/IP adapter module
FCAN-01	Optional CANopen adapter module
FCNA-01	ControlNet adapter module
FDNA-01	Optional DeviceNet adapter module

Term/abbreviation	Explanation
FECA-01	Optional EtherCAT adapter module
FEIP-21	Optional Ethernet/IP adapter module
FENA-21	Optional Ethernet adapter module for EtherNet/IP, Modbus TCP and PROFINET IO protocols
FEPL-02	Optional Ethernet POWERLINK adapter module
FMBT-21	Optional Modbus/TCP adapter module
FPBA-01	Optional PROFIBUS DP adapter module
FPNO-21	Optional PROFINET adapter module
Frame (size)	Refers to drive physical size, for example, R1 and R2. The type designation label attached to the drive shows the frame of the drive, see chapter <i>Operation principle and hardware description</i> , section <i>Type designation label</i> in the <i>Hardware manual</i> of the drive.
FSCA-01	Optional RSA-485 adapter module
ID run	Motor identification run. During the identification run, the drive will identify the characteristics of the motor for optimum motor control.
IGBT	Insulated gate bipolar transistor
Intermediate circuit	See DC link .
Inverter	Converts direct current and voltage to alternating current and voltage.
I/O	Input/Output
IPC	Intelligent pump control
LONWORKS®	LONWORKS® (local operating network) is a networking platform specifically created to address the needs of control applications.
LSW	Least significant word
NETA-21	Remote monitoring tool
Network control	With fieldbus protocols based on the Common Industrial Protocol (CIP™), such as DeviceNet and Ethernet/IP, denotes the control of the drive using the Net Ctrl and Net Ref objects of the ODVA AC/DC Drive Profile. For more information, see www.odva.org , and the following manuals: <ul style="list-style-type: none"> • <i>FDNA-01 DeviceNet adapter module user's manual</i> (3AFE68573360 [English]), and • <i>FENA-01/-11/-21 Ethernet adapter module user's manual</i> (3AUA0000093568 [English]) • <i>FEIP-21 Ethernet/IP adapter module user's manual</i> (3AXD50000158621 [English]).
Parameter	User-adjustable operation instruction to the drive, or signal measured or calculated by the drive
PFC	Single pump and fan control. One drive controls multiple pumps or fans with motors.
PID controller	Proportional-integral-derivative controller, also known as closed loop controller. Drive speed control is based on PID algorithm.
PLC	Programmable logic controller

Term/abbreviation	Explanation
PROFIBUS, PROFIBUS DP, PROFINET IO	Registered trademarks of PI - PROFIBUS & PROFINET International
PTC	Positive temperature coefficient, thermistor whose resistance is dependent on temperature.
R1, R2 ... R4	<i>Frame (size)</i>
RIIO-01	Frontal standard I/O extension. Can not be used simultaneously with a fieldbus adapter
RO	Relay output; interface for a digital output signal. Implemented with a relay.
Rectifier	Converts alternating current and voltage to direct current and voltage.
SPFC	Soft pump and fan control. One drive controls multiple pumps or fans with motors.
STO	Safe torque off. See chapter <i>The Safe torque off function</i> in the <i>Hardware manual</i> of the drive.

Cybersecurity disclaimer

This product is designed to be connected to and to communicate information and data via a network interface. It is Customer's sole responsibility to provide and continuously ensure a secure connection between the product and Customer network or any other network (as the case may be). Customer shall establish and maintain any appropriate measures (such as but not limited to the installation of firewalls, application of authentication measures, encryption of data, installation of anti-virus programs, etc) to protect the product, the network, its system and the interface against any kind of security breaches, unauthorized access, interference, intrusion, leakage and/or theft of data or information. ABB and its affiliates are not liable for damages and/or losses related to such security breaches, any unauthorized access, interference, intrusion, leakage and/or theft of data or information.

2

Start-up, control with I/O and ID run











Contents of this chapter











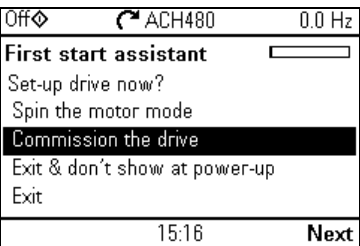

The chapter describes how to:

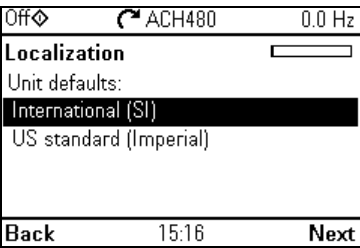
- perform the start-up
- start, stop, change the direction of the motor rotation and adjust the speed of the motor through the I/O interface
- perform an Identification run (ID run) for the drive.

How to start up the drive

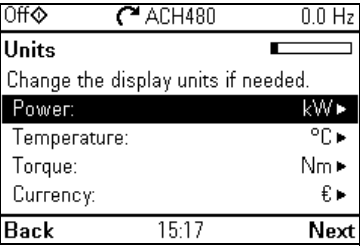
2 ■ How to start up the drive using the First start assistant on the Hand-Off-Auto control panel

Safety	
<p> Do not start-up the drive unless you are a qualified electrician. Read and obey the instructions in chapter <i>Safety instructions</i> at the beginning of the <i>Hardware manual</i> of the drive. Ignoring the instructions can cause physical injury or death, or damage to the equipment.</p>	
<input type="checkbox"/>	Check the installation. See chapter <i>Installation checklist</i> in the <i>Hardware manual</i> of the drive.
<input type="checkbox"/>	<p> Make sure there is no active start on (DI1 in factory settings, that is, HVAC default). The drive will start up automatically at power-up if the external run command is on and the drive is in the external control mode.</p> <p>Check that the starting of the motor does not cause any danger.</p> <p>De-couple the driven machine if</p> <ul style="list-style-type: none"> • there is a risk of damage in case of an incorrect direction of rotation, or • a Normal ID run is required during the drive start-up, when the load torque is higher than 20% or the machinery is not able to withstand the nominal torque transient during the ID run.
Hints on using the assistant control panel	
<p>The two commands at the bottom of the display (Options and Menu in the figure on the right), show the functions of the two softkeys  and  located below the display. The commands assigned to the softkeys vary depending on the context.</p> <p>Use keys , ,  and  to move the cursor and/or change values depending on the active view.</p> <p>Key  shows a context-sensitive help page.</p> <p>For more information, see <i>ACx-AP-x assistant control panels user's manual</i> (3AUA0000085685 [English]).</p>	
1 – First start assistant guided settings: Language, motor nominal values, and date and time	
<input type="checkbox"/>	Have the motor name plate data at hand. Power up the drive.

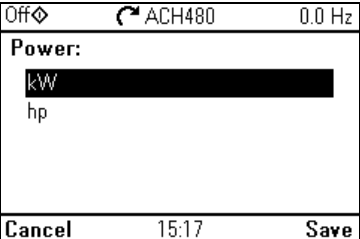
<input type="checkbox"/>	<p>The First start assistant guides you through the first start-up.</p> <p>The assistant begins automatically. Wait until the control panel enters the view shown on the right.</p> <p>Select the language you want to use by highlighting it (if not already highlighted) and pressing  (OK).</p> <p>Note: After you have selected the language, it takes a few minutes to download the language file to the control panel.</p>	 <p>English Deutsch Suomi Français Italiano Nederlands Svenska</p> <p>OK ▶</p>
<input type="checkbox"/>	<p>Select Commission the drive and press  (Next).</p>	 <p>Off ◊ ACH480 0.0 Hz</p> <p>First start assistant</p> <p>Set-up drive now? </p> <p>Spin the motor mode</p> <p>Commission the drive</p> <p>Exit & don't show at power-up</p> <p>Exit</p> <p>15:16 Next</p>
<input type="checkbox"/>	<p>Select the localization you want to use and press  (Next).</p>	 <p>Off ◊ ACH480 0.0 Hz</p> <p>Localization</p> <p>Unit defaults:</p> <p>International (SI)</p> <p>US standard (Imperial)</p> <p>Back 15:16 Next</p>
<input type="checkbox"/>	<p>Change the units shown on the control panel if needed.</p> <ul style="list-style-type: none"> Go to the edit view of a selected row by pressing . Scroll the view with  and . <p>Go to the next view by pressing  (Next).</p>	 <p>Off ◊ ACH480 0.0 Hz</p> <p>Units</p> <p>Change the display units if needed.</p> <p>Power: kW ▶</p> <p>Temperature: °C ▶</p> <p>Torque: Nm ▶</p> <p>Currency: € ▶</p> <p>Back 15:17 Next</p>
<input type="checkbox"/>	<p>To select a value in an edit view:</p> <ul style="list-style-type: none"> Use  and  to select the value. <p>Press  (Save) to accept the new setting, or press  (Cancel) to go back to the previous view without making changes.</p>	 <p>Off ◊ ACH480 0.0 Hz</p> <p>Power:</p> <p>kW</p> <p>hp</p> <p>Cancel 15:17 Save</p>

<p><input type="checkbox"/> Set the date and time as well as date and time display formats.</p> <ul style="list-style-type: none"> Go to the edit view of a selected row by pressing . Scroll the view with and . <p>Go to the next view by pressing (Next).</p>	<p>Off ACH480 0.0 Hz</p> <p>Date & time </p> <p>Please enter the current date and time.</p> <p>Date 24.02.2017 </p> <p>Time 15:17:50 </p> <p>Show date as day.month.year </p> <p>Show time as 24-hour </p> <p>Back 15:17 Next</p>
<p><input type="checkbox"/> Choose Single motor or Multiple motors.</p> <ul style="list-style-type: none"> Use and to select the value. Go to the next view by pressing (Select), or press (Back) to go back to the previous view without making changes. 	<p>Auto ACH480 0.0 Hz</p> <p>Motor configuration </p> <p>Is this a single or multiple motor application?</p> <p>Single motor </p> <p>Multiple motors</p> <p>Back Select</p>
<p><input type="checkbox"/> (This screen appears only if you selected <i>Multiple motors</i> previously.)</p> <p>Select the number of motors connected to the drive (from 2 to 18).</p> <ul style="list-style-type: none"> Use and to change the value. Go to the next view by pressing (Next), or press (Back) to go back to the previous view without making changes. 	<p>Auto ACH480 0.0 Hz</p> <p>Multi-motor set-up </p> <p>Enter the number of motors for the multi-motor calculation:</p> <p>Number of identical motors: 2 </p> <p>Back Next</p>

Refer to the motor nameplate for the following nominal value settings of the motor. Enter the values exactly as shown on the motor nameplate.

Example of a nameplate of an induction (asynchronous) motor:

ABB Motors CE

3 ~ motor M2AA 200 MLA 4













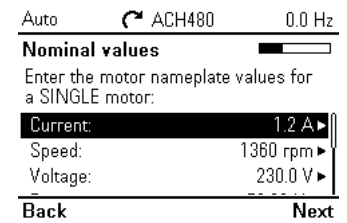

IEC 200 ML 55



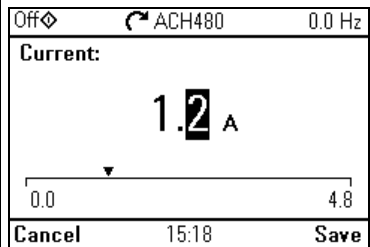





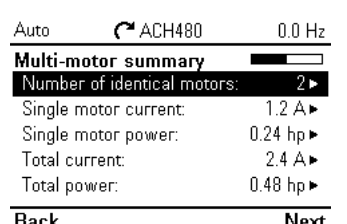







No		Ins.cl. F		IP 55			
V	Hz	kW	r/min	A	cos φ	I _A /I _N	t _E /s
690 Y	50	30	1475	32.5	0.83		
400 D	50	30	1475	56	0.83		
660 Y	50	30	1470	34	0.83		
380 D	50	30	1470	59	0.83		
415 D	50	30	1475	54	0.83		
440 D	60	35	1770	59	0.83		



Cat. no 3GAA 202 001 - ADA

6312/C3 6210/C3 180 kg

IEC 34-1

<input type="checkbox"/>	<ul style="list-style-type: none"> The default nominal values are shown. Values are predefined on the basis of the drive size but you should verify that they correspond to the motor. Go to the edit view of a selected row by pressing . Scroll the view with  and . For a single motor drive, enter the correct nominal values for a single motor. Start with the motor type. For a multi-motor drive, the motor type, control mode and rotation direction entries are not shown. A single motor current value is limited to the maximum drive current rating divided by the number of motors. Motor nominal $\cos \Phi$ and nominal torque values are optional. 	
<input type="checkbox"/>	<p>To change a value in an edit view:</p> <ul style="list-style-type: none"> Use  and  to move the cursor left and right. Use  and  to change the value. <p>Press  (Save) to accept the new setting, or press  (Cancel) to go back to the previous view without making changes.</p>	
<input type="checkbox"/>	<p>(This screen appears only if you selected <i>Multiple motors</i> previously.)</p> <p>This screen shows a summary of the multiple motor data. You can still change the <i>Number of identical motors</i>, <i>Single motor current</i> and <i>Single motor power</i> values on this screen.</p> <p>You cannot change the <i>Total current</i> and <i>Total power</i> values. The system calculates these values from the <i>Number of identical motors</i>, <i>Single motor current</i> and <i>Single motor values</i>.</p> <ul style="list-style-type: none"> Use  and  to move the cursor up and down. Use  and  to change the value. Go to the next view by pressing  (Next), or press  (Back) to go back to the previous view without making changes. 	

<input type="checkbox"/>	<p>(This screen appears only if you selected <i>Multiple motors</i> previously.)</p> <p>This screen shows a summary of automatically configured parameters. You cannot change the values.</p> <ul style="list-style-type: none"> Go to the next view by pressing  (Next), or press  (Back) to go back to the previous view without making changes. 	<p>Auto  ACH480 0.0 Hz</p> <p>Multi-motor configuration </p> <p>The following parameters are automatically configured after completing multi-motor set-up:</p> <p>Start mode: Constant time</p> <p>Energy optimizer: Disabled</p> <p>U/F ratio: Linear</p> <p>Back Next</p>
<input type="checkbox"/>	<p>This step is optional, and requires rotating the motor(s). Do not do this if it could cause any risk, or if the mechanical set-up does not allow it.</p> <p>To do the direction test, select Spin the motor(s) and press  (Next).</p>	<p>Off  ACH480 0.0 Hz</p> <p>Direction test? </p> <p>Spin the motor(s) to check direction?</p> <p>Spin the motor(s)</p> <p>Not now</p> <p>Back Next</p>
<input type="checkbox"/>	<p>Press the Hand key  on the control panel to start the drive.</p>	<p>Off  ACH480 5.0 Hz</p> <p>Press Hand </p> <p>Warning: Until set-up is done, safeties are not active and each motor speed is 5 Hz.</p> <p>Press Hand now to spin the motor(s), then check the direction of rotation.</p> <p>Back</p>
<input type="checkbox"/>	<p>Check the direction of the motor(s).</p> <p>If it is forward, select Yes, each motor is spinning forward and press  (Next) to continue.</p> <p>If the direction is not forward, select No, fix direction and press  (Next) to continue.</p>	<p>Hand  ACH480 5.0 Hz</p> <p>Is this forward? </p> <p>Selecting "No, fix direction" tells the drive to change direction, and labels the new direction "forward".</p> <p>Yes, each motor is spinning forward</p> <p>No, fix direction</p> <p>Next</p>
<input type="checkbox"/>	<p>The first start is now complete and the drive is ready for use.</p> <p>Press  (Done) to enter the Home view.</p>	<p>Off  ACH480 0.0 Hz</p> <p>First start complete</p> <p>The drive is ready to run the motor. Press "Hand" to start the motor. To continue commissioning go to Menu > Primary settings.</p> <p style="text-align: center;">15:19 Done</p>

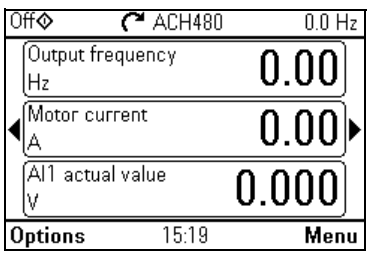
□	<p>The Home view 1 monitoring the values of the selected signals is shown on the control panel. There are eight different Home view displays. Home view 1 is the default Home view. You can browse them with keys  and . See section Home view displays on page 46.</p>	
	2	

2 – Completion of commissioning

You can complete the commissioning in five different ways:

2

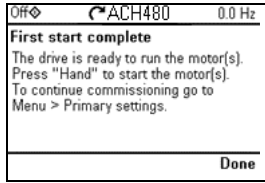

1

Run & set reference on the control panel

Drive is now ready to be run in the Hand mode.
 Press the Hand key  on the control panel to start the motor.
 Set the reference on the control panel.

2

Assistant commissioning

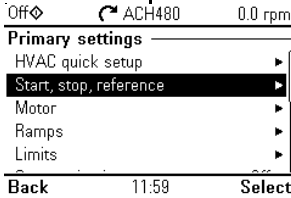

Complete the following two assistants.
 Ramps, limits, interlock, run permissive

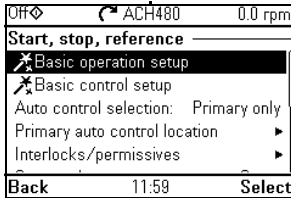

Start/stop, reference and scaling

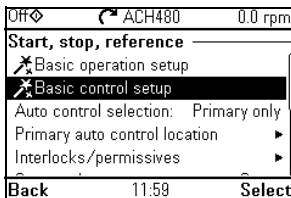

3

HVAC quick setup commissioning

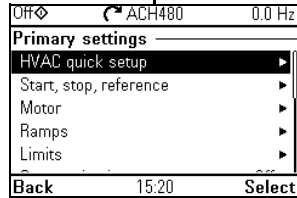

Go through the items on the menu

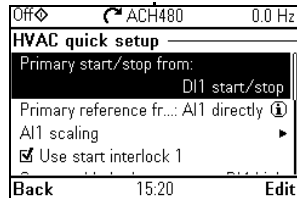

Options 4 and 5:

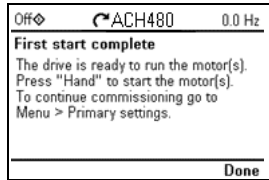

4

Commissioning with Primary settings

Set the start/stop and reference

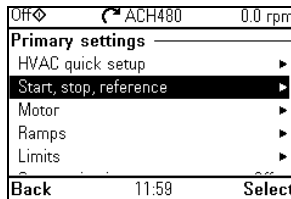

Set the motor data

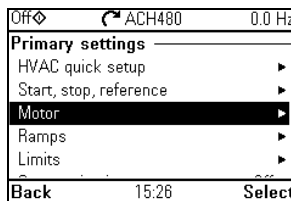

Set the ramps

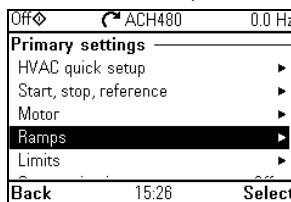

Set the limits

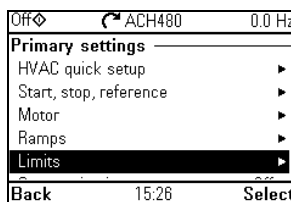

Continue with further adjustments, see section [Primary settings](#) on page 54.

5



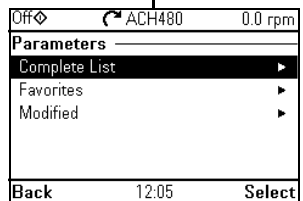
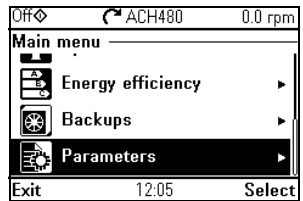



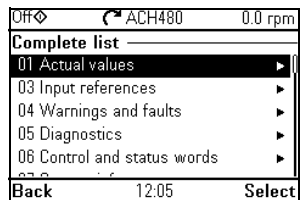



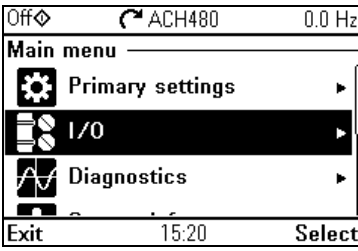





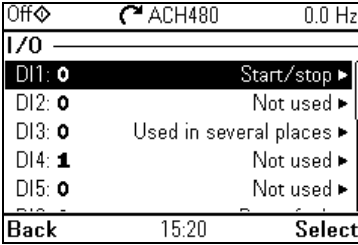

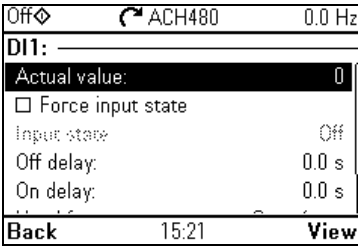

Commissioning with parameters. For advanced users only.





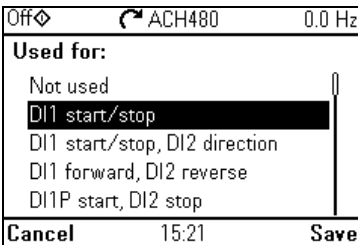

See chapter [Parameters](#) on page 357.

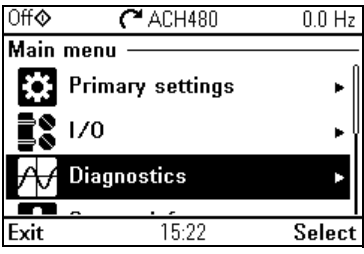

3 – Additional settings in the Primary settings menu – I/O menu

<p><input type="checkbox"/> After the additional adjustments, make sure that the actual I/O wiring matches the I/O use in the control program.</p> <p>In the Main menu, select a I/O and press  (Select) to enter the I/O menu.</p>	 <p>Off  ACH480 0.0 Hz</p> <p>Main menu</p> <ul style="list-style-type: none">  Primary settings ▶  I/O ▶  Diagnostics ▶ <p>Exit 15:20 Select</p>
<p><input type="checkbox"/> Select a the connection you want to check and press  (Select) (or ).</p>	 <p>Off  ACH480 0.0 Hz</p> <p>I/O</p> <ul style="list-style-type: none"> DI1: 0 Start/stop ▶ DI2: 0 Not used ▶ DI3: 0 Used in several places ▶ DI4: 1 Not used ▶ DI5: 0 Not used ▶ <p>Back 15:20 Select</p>
<p><input type="checkbox"/> To view the details of a parameter that cannot be adjusted via the I/O menu, press  (View).</p>	 <p>Off  ACH480 0.0 Hz</p> <p>DI1:</p> <p>Actual value: 0</p> <p><input type="checkbox"/> Force input state</p> <p>Input state Off</p> <p>Off delay: 0.0 s</p> <p>On delay: 0.0 s</p> <p>Back 15:21 View</p>
<p><input type="checkbox"/> To adjust the value of a parameter, press  (Edit), adjust the value using , ,  and  keys and press  (Save). Note that the actual wiring must match the new value.</p> <p>Go back to the Main menu by pressing  (Back) repeatedly.</p>	 <p>Off  ACH480 0.0 Hz</p> <p>DI1:</p> <p><input type="checkbox"/> Force input state</p> <p>Input state Off</p> <p>Off delay: 0.0 s</p> <p>On delay: 0.0 s</p> <p>Used for: Start/stop</p> <p>Back 15:21 Edit</p>  <p>Off  ACH480 0.0 Hz</p> <p>Used for:</p> <ul style="list-style-type: none"> Not used DI1 start/stop DI1 start/stop, DI2 direction DI1 forward, DI2 reverse DI1P start, DI2 stop <p>Cancel 15:21 Save</p>

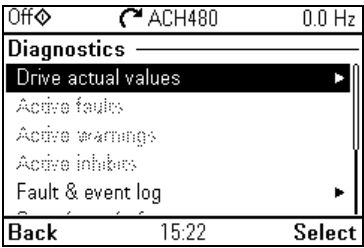
4 – Diagnostics menu	
<p><input type="checkbox"/> After making the additional adjustments and checking the I/O connections, use the Diagnostics menu to make sure that the setup is functioning correctly.</p> <p>In the Main menu, select Diagnostics and press  (Select) (or ).</p>	 <p>The screenshot shows the 'Main menu' with the following options: 'Primary settings', 'I/O', 'Diagnostics' (highlighted), and 'Exit'. The top status bar shows 'Off', 'ACH480', and '0.0 Hz'. The bottom bar shows 'Exit', '15:22', and 'Select'.</p>
<p><input type="checkbox"/> Select the diagnostics item you want to view and press  (Select).</p> <p>Return to the Diagnostics menu by pressing  (Back).</p>	 <p>The screenshot shows the 'Diagnostics' menu with the following options: 'Drive actual values' (highlighted), 'Active faults', 'Active warnings', 'Active inhibits', and 'Fault & event log'. The top status bar is the same as the previous screenshot. The bottom bar shows 'Back', '15:22', and 'Select'.</p>

How to control the drive through the I/O interface

The table below describes how to operate the drive through the digital and analog inputs when:

2

- the motor start-up is performed, and
- the default parameter settings of the HVAC default configurations are in use.

Preliminary settings	
<p>If you need to change the direction of rotation, check that limits allow reverse direction. Check parameter group 30 Limits and make sure that the minimum limit has a negative value and the maximum limit has a positive value.</p> <p>Note: Default settings only allow forward direction.</p> <p>Make sure that the control connections are wired according to the connection diagram given for the HVAC default.</p> <p>Make sure that the drive is in external control. To switch to external control, press key Auto.</p>	<p>See section HVAC default on page 97.</p> <p>In external control, the control panel display shows text Auto at the top left.</p>
Starting and controlling the speed of the motor	
<p>Start by switching digital input DI1 on.</p> <p>The arrow starts rotating. It is dotted until the setpoint is reached.</p> <p>Regulate the drive output frequency (motor speed) by adjusting voltage of analog input AI.</p> <p>Note: If the drive will not start, check that the start interlock 1 (parameter 20.41) is active (1). For the HVAC default, the start interlock 1 is connected to DI4 by default.</p>	
Stopping the motor	
<p>Switch digital input DI1 off. The arrow stops rotating.</p>	

How to perform the ID run

The drive automatically estimates motor characteristics using *Standstill* ID run when the drive is started for the first time in vector control and after any motor parameter (group *99 Motor data*) is changed. This is valid when

- parameter *99.13 ID run requested* selection is *Standstill* and
- parameter *99.04 Motor control mode* selection is *Vector*.

In most applications there is no need to perform a separate ID run. The ID run should be selected manually if:

- vector control mode is used (parameter *99.04 Motor control mode* is set to *Vector*), and
- permanent magnet motor (PM) is used (parameter *99.03 Motor type* is set to *Permanent magnet motor*), or
- synchronous reluctance motor (SynRM) is used (parameter *99.03 Motor type* is set to *SynRM*), or
- drive operates near zero speed references, or
- operation at torque range above the motor nominal torque, over a wide speed range is needed.

Do the ID run with the ID run assistant by selecting **Menu > Primary settings > Motor > ID run** (see page 34) or with parameter *99.13 ID run requested* (see page 38).

Note: If motor parameters (*99 Motor data*) are changed after the ID run, it must be repeated.

Note: If you have already parameterized your application using the scalar motor control mode (*99.04 Motor control mode* is set to *Scalar*) and you need to change motor control mode to *Vector*,

- change the control mode to vector with the **Control mode** assistant (go to **Menu > Primary settings > Motor > Control mode**) and follow the instructions. The ID run assistant then guides you through the ID run.







or







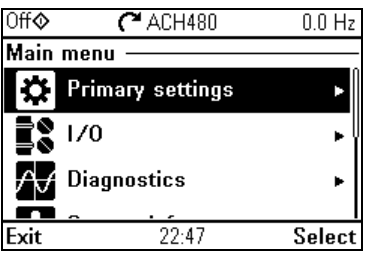

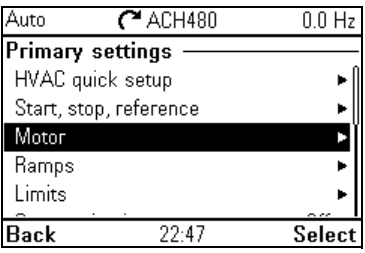



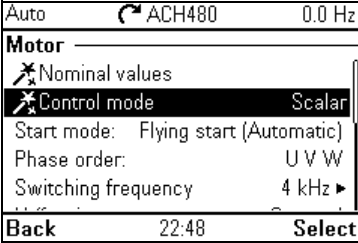



- set parameter *99.04 Motor control mode* to *Vector*, and
 - for I/O controlled drive, check parameters in groups *22 Speed reference selection*, *23 Speed reference ramp*, *12 Standard AI*, *30 Limits* and *46 Monitoring/scaling settings*.

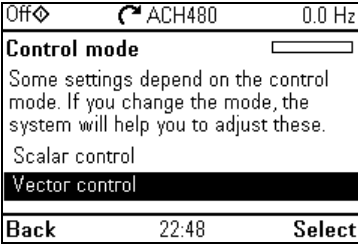

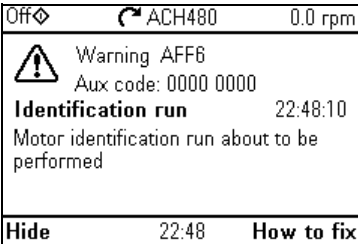

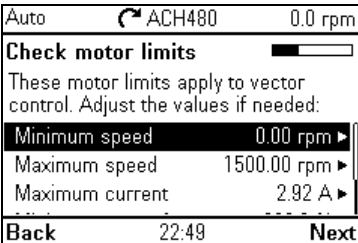

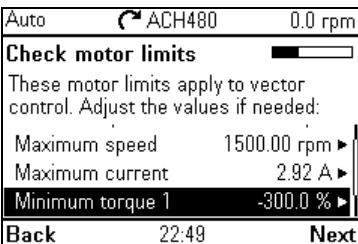



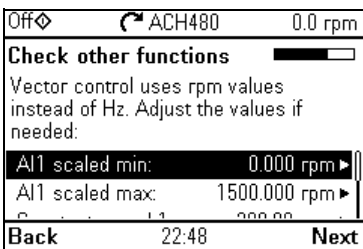



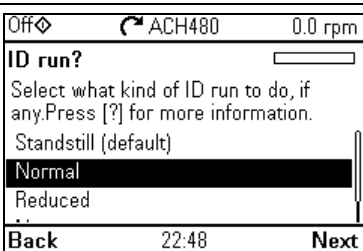

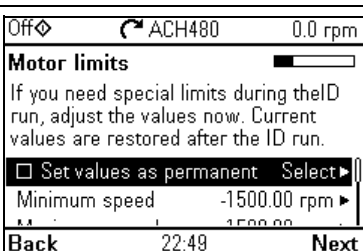

■ ID run procedure

With the ID run assistant

2

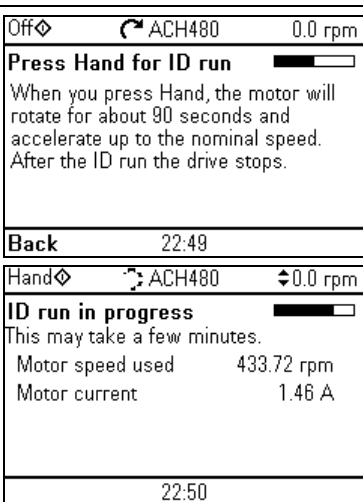
Pre-check	
<div style="display: flex; align-items: center;">  <p>WARNING! The motor will run at up to approximately 50...80% of the nominal speed during the ID run. The motor will rotate in the forward direction. Make sure that it is safe to run the motor before performing the ID run!</p> </div>	
<ul style="list-style-type: none"> <input type="checkbox"/> De-couple the motor from the driven equipment <input type="checkbox"/> Check that the values of the motor data parameters are equivalent to those on the motor nameplate. <input type="checkbox"/> Check that the STO circuit is closed. <p>The assistant will ask if you want to use temporary motor limits. They must meet the following conditions:</p> <ul style="list-style-type: none"> <input type="checkbox"/> Minimum speed ≤ 0 rpm <input type="checkbox"/> Maximum speed = motor rated speed (Normal ID run procedure needs the motor to be run at 100% speed.) <input type="checkbox"/> Maximum current $> I_{HD}$ <input type="checkbox"/> Maximum torque $> 50\%$ <p><input type="checkbox"/> Make sure that the control panel is in the Off mode control (text Off shown at the top left). Press the Off key  to switch to the Off mode.</p>	
ID run	
<ul style="list-style-type: none"> <input type="checkbox"/> Go to the Main menu by pressing  (Menu) in the Home view. Select Primary settings and press  (Select) (or ). 	 <p>The screenshot shows the 'Main menu' with 'Primary settings' highlighted. Other options include 'I/O' and 'Diagnostics'. The top status bar shows 'Off', 'ACH480', and '0.0 Hz'. The bottom bar shows 'Exit', '22:47', and 'Select'.</p>
<ul style="list-style-type: none"> <input type="checkbox"/> Select Motor and press  (Select) (or ). 	 <p>The screenshot shows the 'Primary settings' menu with 'Motor' highlighted. Other options include 'HVAC quick setup', 'Start, stop, reference', 'Ramps', and 'Limits'. The top status bar shows 'Auto', 'ACH480', and '0.0 Hz'. The bottom bar shows 'Back', '22:47', and 'Select'.</p>





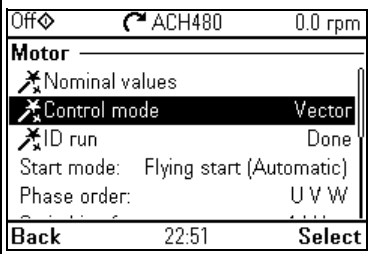

<input type="checkbox"/>	<p>If the control modes is scalar, select Control mode and press  (Select) (or ) and continue to the next step.</p>	 <p>Auto  ACH480 0.0 Hz</p> <p>Motor</p> <p> Nominal values</p> <p> Control mode Scalar</p> <p>Start mode: Flying start (Automatic)</p> <p>Phase order: U V W</p> <p>Switching frequency 4 kHz ▶</p> <p>Back 22:48 Select</p>
<input type="checkbox"/>	<p>Select Vector control and press  (Select) (or )</p>	 <p>Off  ACH480 0.0 Hz</p> <p>Control mode</p> <p>Some settings depend on the control mode. If you change the mode, the system will help you to adjust these.</p> <p>Scalar control</p> <p>Vector control</p> <p>Back 22:48 Select</p>
<input type="checkbox"/>	<p>Warning message Identification run is shown. Press  (Hide) to continue.</p>	 <p>Off  ACH480 0.0 rpm</p> <p> Warning AFF6 Aux code: 0000 0000</p> <p>Identification run 22:48:10</p> <p>Motor identification run about to be performed</p> <p>Hide 22:48 How to fix</p>
<input type="checkbox"/>	<p>Check the motor speed limits. The following must be true:</p> <ul style="list-style-type: none"> • Minimum speed ≤ 0 rpm • Maximum speed = motor rated speed. 	 <p>Auto  ACH480 0.0 rpm</p> <p>Check motor limits</p> <p>These motor limits apply to vector control. Adjust the values if needed:</p> <p>Minimum speed 0.00 rpm ▶</p> <p>Maximum speed 1500.00 rpm ▶</p> <p>Maximum current 2.92 A ▶</p> <p>Back 22:49 Next</p>
<input type="checkbox"/>	<p>Check the motor current as well as torque limits. The following must be true:</p> <ul style="list-style-type: none"> • Maximum current $> I_{HD}$ • Maximum torque $> 50\%$. <p>Press  (Next).</p>	 <p>Auto  ACH480 0.0 rpm</p> <p>Check motor limits</p> <p>These motor limits apply to vector control. Adjust the values if needed:</p> <p>Maximum speed 1500.00 rpm ▶</p> <p>Maximum current 2.92 A ▶</p> <p>Minimum torque 1 -300.0 % ▶</p> <p>Back 22:49 Next</p>







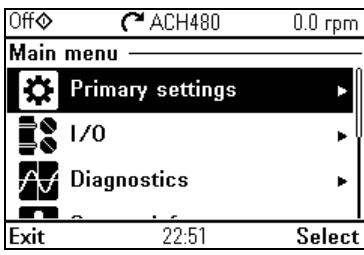

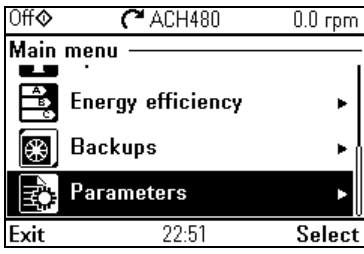



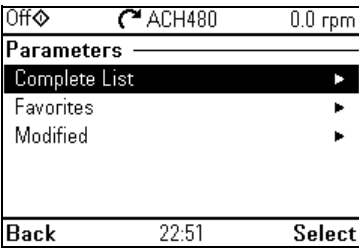





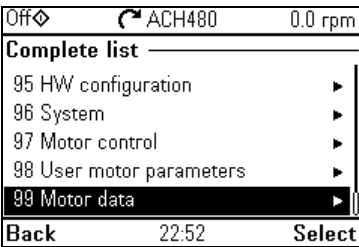

<input type="checkbox"/>	<p>Check AI1 scaling, see parameters 12.19 AI1 scaled at AI1 min and 12.20 AI1 scaled at AI1 max. Press  (Next).</p>	 <p>Off  ACH480 0.0 rpm</p> <p>Check other functions </p> <p>Vector control uses rpm values instead of Hz. Adjust the values if needed:</p> <p>AI1 scaled min: 0.000 rpm ▶</p> <p>AI1 scaled max: 1500.000 rpm ▶</p> <p>Back 22:48 Next</p>
<input type="checkbox"/>	<p>Select the type of ID run (see parameter 99.13 ID run requested) to be performed and press  (Next).</p>	 <p>Off  ACH480 0.0 rpm</p> <p>ID run? </p> <p>Select what kind of ID run to do, if any. Press [?] for more information. Standstill (default)</p> <p>Normal </p> <p>Reduced</p> <p>Back 22:48 Next</p>
<input type="checkbox"/>	<p>Check the motor limits shown on the control panel. If you need other limits during the ID run you can enter them here. The originals limits will be restored after the ID run, unless you select Set values as permanent. Press  (Next).</p>	 <p>Off  ACH480 0.0 rpm</p> <p>Motor limits </p> <p>If you need special limits during the ID run, adjust the values now. Current values are restored after the ID run.</p> <p><input type="checkbox"/> Set values as permanent </p> <p>Minimum speed -1500.00 rpm ▶</p> <p>Back 22:48 Next</p>
<input type="checkbox"/>	<p>Press the Hand key () to start the ID run. In general, it is recommended not to press any control panel keys during the ID run. However, you can stop the ID run at any time by pressing the Off key ().</p> <p>During the ID run a progress view is shown.</p> <p>After the ID run is completed, text ID run done is shown. The LED stops blinking.</p> <p>If the ID run fails, fault FF61 ID run is shown. See chapter Fault tracing on page 219 for more information.</p>	 <p>Off  ACH480 0.0 rpm</p> <p>Press Hand for ID run </p> <p>When you press Hand, the motor will rotate for about 90 seconds and accelerate up to the nominal speed. After the ID run the drive stops.</p> <p>Back 22:48</p> <p>Hand  ACH480 0.0 rpm</p> <p>ID run in progress </p> <p>This may take a few minutes.</p> <p>Motor speed used 433.72 rpm</p> <p>Motor current 1.46 A</p> <p>22:50</p>

<input type="checkbox"/>	After the ID run is completed, text Done is shown on row ID run .	 <p>The screenshot shows a motor control interface. At the top, it displays 'Off' with a diamond symbol, 'ACH480', and '0.0 rpm'. Below this is a 'Motor' section with a list of items: 'Nominal values', 'Control mode' (highlighted in black with 'Vector' to its right), 'ID run' (with 'Done' to its right), 'Start mode: Flying start (Automatic)', and 'Phase order: U V W'. At the bottom, there are 'Back' and 'Select' buttons, with '22:51' displayed between them.</p>
--------------------------	---	---

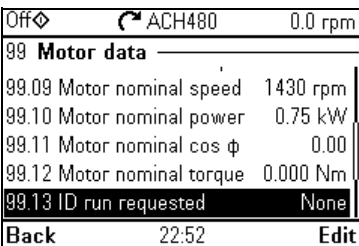

With parameter **99.13 ID run requested**

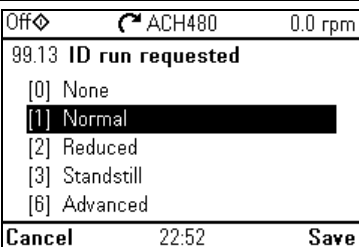
2

Pre-check	
<div style="display: flex; align-items: center;">  <p>WARNING! The motor will run at up to approximately 50...80% of the nominal speed during the ID run. The motor will rotate in the forward direction. Make sure that it is safe to run the motor before performing the ID run!</p> </div>	
<ul style="list-style-type: none"> <input type="checkbox"/> De-couple the motor from the driven equipment <input type="checkbox"/> Check that the values of the motor data parameters are equivalent to those on the motor nameplate. <input type="checkbox"/> Check that the STO circuit is closed. <p>If parameter values (from group <i>10 Standard DI, RO</i> to group <i>99 Motor data</i>) are changed before the ID run, check that the new settings meet the following conditions:</p> <ul style="list-style-type: none"> <input type="checkbox"/> <i>30.11 Minimum speed</i> ≤ 0 rpm <input type="checkbox"/> <i>30.12 Maximum speed</i> = motor rated speed (Normal ID run procedure needs the motor to be run at 100% speed.) <input type="checkbox"/> <i>30.17 Maximum current</i> > I_{HD} <input type="checkbox"/> <i>30.20 Maximum torque 1</i> > 50% or <i>30.24 Maximum torque 2</i> > 50%, depending on which torque limit set is in use according to parameter <i>30.18 Torq lim sel</i>. <p>Check that signals</p> <ul style="list-style-type: none"> <input type="checkbox"/> run permissive (parameter <i>20.40 Run permissive</i>) is active <input type="checkbox"/> Make sure that the control panel is in the Off mode control (text Off shown at the top left). Press the Off key  to switch to the Off mode. 	
ID run	
<ul style="list-style-type: none"> <input type="checkbox"/> Go to the Main menu by pressing  (Menu) in the Home view. Press . 	 <p>The screenshot shows the 'Main menu' with the following options: 'Primary settings', 'I/O', and 'Diagnostics'. The 'Primary settings' option is highlighted with a black background and white text. At the bottom of the screen, it says 'Exit 22:51 Select'.</p>
<ul style="list-style-type: none"> <input type="checkbox"/> Select Parameters and press  (Select) (or ). 	 <p>The screenshot shows the 'Main menu' with the following options: 'Energy efficiency', 'Backups', and 'Parameters'. The 'Parameters' option is highlighted with a black background and white text. At the bottom of the screen, it says 'Exit 22:51 Select'.</p>

<input type="checkbox"/>	Select Complete list and press  (Select) (or ).	 <p>Off  ACH480 0.0 rpm</p> <p>Parameters</p> <p>Complete List ▶</p> <p>Favorites ▶</p> <p>Modified ▶</p> <p>Back 22:51 Select</p>
<input type="checkbox"/>	Scroll the page with  and  , and select parameter group 99 Motor data and press  (Select) (or ).	 <p>Off  ACH480 0.0 rpm</p> <p>Complete list</p> <p>95 HW configuration ▶</p> <p>96 System ▶</p> <p>97 Motor control ▶</p> <p>98 User motor parameters ▶</p> <p>99 Motor data ▶</p> <p>Back 22:52 Select</p>
<input type="checkbox"/>	Scroll the page with  and  , and select parameter 99.13 ID run requested and press  (Select) (or ).	 <p>Off  ACH480 0.0 rpm</p> <p>99 Motor data</p> <p>99.09 Motor nominal speed 1430 rpm</p> <p>99.10 Motor nominal power 0.75 kW</p> <p>99.11 Motor nominal cos φ 0.00</p> <p>99.12 Motor nominal torque 0.000 Nm</p> <p>99.13 ID run requested None</p> <p>Back 22:52 Edit</p>
<input type="checkbox"/>	Select the ID run type (see parameter 99.13 ID run requested) and press  (Save) (or ).	 <p>Off  ACH480 0.0 rpm</p> <p>99.13 ID run requested</p> <p>[0] None</p> <p>[1] Normal</p> <p>[2] Reduced</p> <p>[3] Standstill</p> <p>[6] Advanced</p> <p>Cancel 22:52 Save</p>

□ Control panel LED starts blinking green to indicate an active warning ([AFF6](#)).

The [AFF6](#) warning view is shown when no key has been pressed for one minute. Pressing  (**How to fix**) shows text informing that the ID run will be done at the next start. You can hide the warning view by pressing  (**Hide**).

Press the Hand key () to start the ID run.

In general, it is recommended not to press any control panel keys during the ID run. However, you can stop the ID run at any time by pressing the Off key ().

During the ID run the arrow is rotating at the top.

After the ID run is completed, text **ID run done** is shown. The LED stops blinking.

If the ID run fails, fault [FF61 ID run](#) is shown. See chapter [Fault tracing](#) on page 219 for more information.

Off	ACH480	0.0 rpm
	Warning AFF6 Aux code: 0000 0000	
Identification run		22:52:29
Motor identification run about to be performed		
Hide	22:52	How to fix
Hand	ACH480	0.0 rpm
99 Motor data		
99.09	Motor nominal speed	1430 rpm
99.10	Motor nominal power	0.75 kW
99.11	Motor nominal cos φ	0.00
99.12	Motor nominal torque	0.000 Nm
99.13	ID run requested	Normal
Back	22:52	Edit

3

3

Control panel

Contents of this chapter

This chapter contains instructions for removing and reinstalling the assistant control panel ACH-AP-H or ACH-AP-W and briefly describes its display, keys and key shortcuts. For more information, see *ACx-AP-x assistant control panels user's manual* (3AUA0000085685 [English]).

Removing and reinstalling the control panel

To remove the control panel, press the retaining clip at the top (1a) and pull it forward from the top edge (1b).

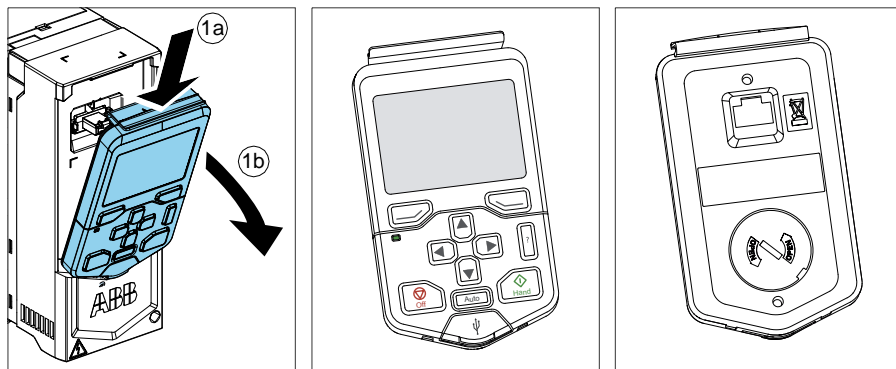

To reinstall the control panel, put the bottom of the container in position (1a), press the retaining clip at the top (1b) and push the control panel in at the top edge (1c).

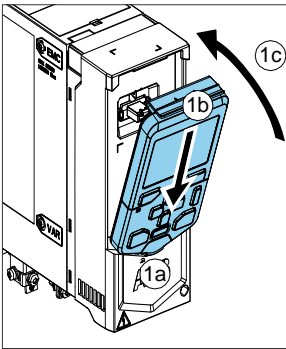

3

Layout of the control panel

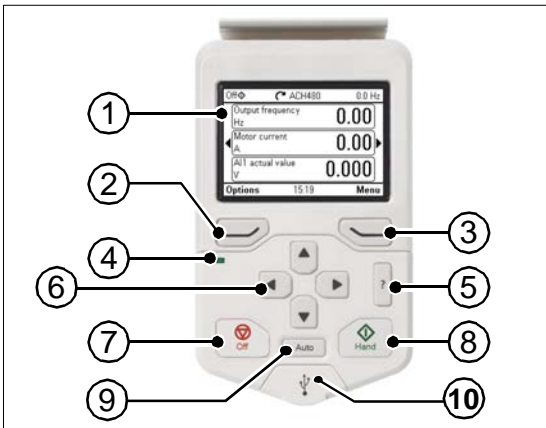

1	Layout of the control panel display
2	Left softkey
3	Right softkey
4	Status LED, see chapter <i>Maintenance and hardware diagnostics</i> , section <i>LEDs</i> in the <i>Hardware manual of the drive</i> .
5	Help

6	The arrow keys
7	Off (see Hand , Off and Auto)
8	Hand (see Hand , Off and Auto)
9	Auto (see Hand , Off and Auto)
10	USB connector

Layout of the control panel display

In most views, the following elements are shown on the display:

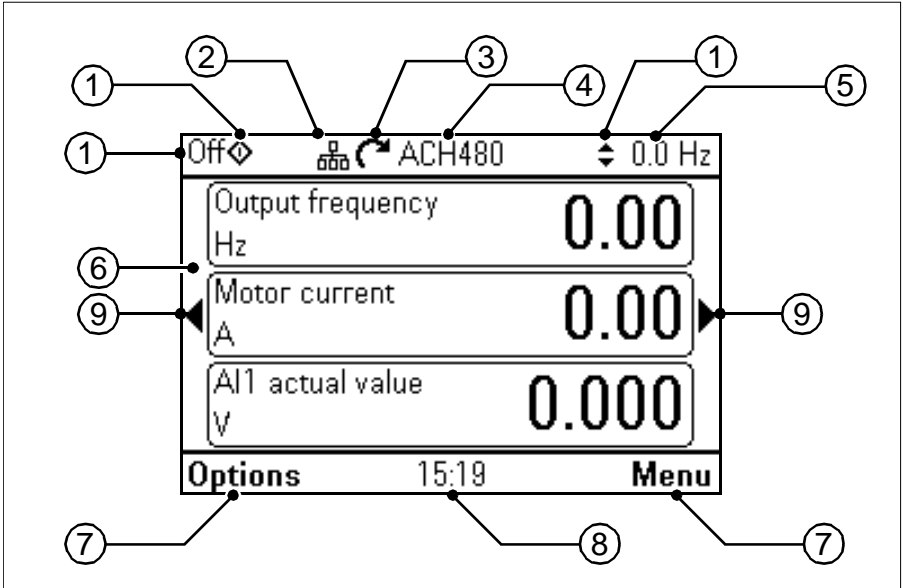





1. **Control location and related icons:** Indicates how the drive is controlled:

- **No text:** The drive is in local control, but controlled from another device. The icons in the top pane indicate which actions are allowed:

Text/icons	Starting from this control panel	Stopping from this control panel	Giving reference from this control panel
	Not allowed	Not allowed	Not allowed

- **Local:** The drive is in local control, and controlled from this control panel. The icons in the top pane indicate which actions are allowed:









Text/icons	Starting from this control panel	Stopping from this control panel	Giving reference from this control panel
Off  	Allowed	Drive is stopped	Not allowed
Hand  	Allowed	Allowed	Allowed



- **External** The drive is in external control, ie, controlled through I/O or fieldbus. The icons in the top pane indicate which actions are allowed with the control panel:

Text/icons	Starting from this control panel	Stopping from this control panel	Giving reference from this control panel
Auto	Allowed ¹⁾	Allowed ¹⁾	Not allowed
Auto 	Not allowed	Allowed	Allowed

¹⁾ This action can be Not allowed by changing parameters [19.18 HAND/OFF disable source](#) and [19.19 HAND/OFF disable action](#).

2. **Panel bus:** Indicates that there are more than one drive connected to this panel. To switch to another drive, go to **Options > Select drive**.
3. **Status icon:** Indicates the status of the drive and the motor. The direction of the arrow indicates forward (clockwise) or reverse (counter-clockwise) rotation.

Status icon	Animation	Drive status
	-	Stopped
	-	Stopped, start inhibited
	Blinking	Stopped, start command given but start inhibited. See Menu > Diagnostics on the control panel
	Blinking	Faulted
	Blinking	Running, at reference, but the reference value is 0
	Rotating	Running, not at reference
	Rotating	Running, at reference
	-	Pre-heating (motor heating) active
	-	PID sleep mode active

4. **Drive name:** If a name has been given, it is displayed in the top pane. By default, it is "ACH480". You can change the name on the control panel by selecting **Menu > Primary settings > Clock, region, display** (see page [82](#)).
5. **Reference value:** Speed, frequency, etc. is shown with its unit. For information on changing the reference value in the **Primary settings** menu (see page [63](#)).
6. **Content area:** The actual content of the view is displayed in this area. The content varies from view to view. The example view on page [43](#) is the main view of the control panel which is called the Home view.
7. **Softkey selections:** Displays the functions of the softkeys ( and ) in a given context.

8. **Clock:** The clock displays the current time. You can change the time and time format on the control panel by selecting **Menu > Primary settings > Clock, region, display** (see page [82](#)).
9. **Side arrows:** When side arrows are visible, you can browse other Home views with the arrow keys ([◀](#) and [▶](#)).

You can adjust the display contrast and back light functionality on the control panel by selecting **Menu > Primary settings > Clock, region, display** (see page [82](#)).

Home view displays

There are eight different Home view displays. In addition, there are six preconfigured IPC Home views (see section [IPC additional Home view displays](#) on page 48).

Home view 1 is the default Home view. You can browse them with the arrow keys (◀ and ▶). To edit Home views, press the Option softkey (⏏), see section [Options menu](#) on page 93.

3

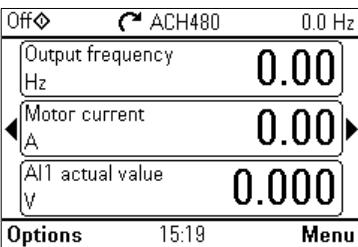
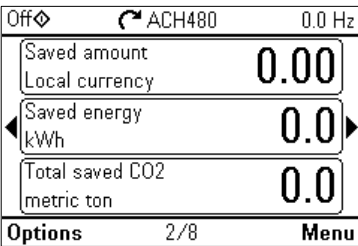
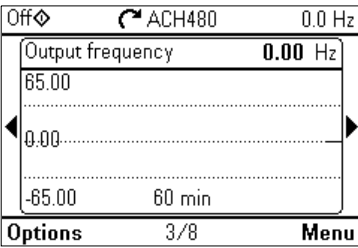
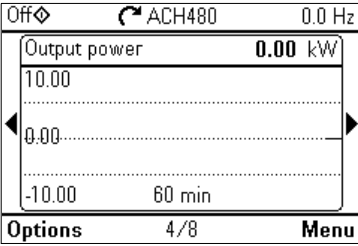
<p>Home view 1 (default Home view):</p> <ul style="list-style-type: none"> • Output frequency (Hz): Parameter 01.06 Output frequency • Motor current (A): Parameter 01.07 Motor current • AI1 actual value (V or mA): Parameter 12.11 AI1 actual value 	
<p>Home view 2:</p> <ul style="list-style-type: none"> • Saved amount (Local currency): Parameter 45.07 Saved amount • Saved energy (kWh): Parameter 45.04 Saved energy • Total saved CO2 (metric ton): 45.09 CO2 reduction in tons 	
<p>Home view 3:</p> <ul style="list-style-type: none"> • Output frequency shown as a graphical representation during the last 60 minutes: Parameter 01.06 Output frequency 	
<p>Home view 4:</p> <ul style="list-style-type: none"> • Output power shown as a graphical representation during the last 60 minutes: Parameter 01.14 Output power 	

<p>Home view 5:</p> <ul style="list-style-type: none"> Control board temperature (°C): Parameter 05.10 Control board temperature Inverter temperature (%): Parameter 05.11 Inverter temperature DC voltage (V): Parameter 01.11 DC voltage 	<p>Off ACH480 0.0 Hz</p> <p>Control board temperature 43 °C</p> <p>Inverter temperature 22.7 %</p> <p>DC voltage 618.17 V</p> <p>Options 5/8 Menu</p>
<p>Home view 6:</p> <ul style="list-style-type: none"> On-time counter (days): Parameter 05.01 On-time counter Run-time counter (days): Parameter 05.02 Run-time counter 	<p>Off ACH480 0.0 Hz</p> <p>On-time counter 0 days</p> <p>Run-time counter 0 days</p> <p>Options 6/8 Menu</p>
<p>Home view 7:</p> <ul style="list-style-type: none"> DI delayed status, that is, status of DI6...DI1 (DI1 is bit 0, the rightmost bit): Parameter 10.02 DI delayed status RO status, that is, status of RO3...RO1 (RO1 is bit 0, the rightmost bit): Parameter 10.21 RO status Communication diagnostics: Parameter 58.07 Communication diagnostics 	<p>Off ACH480 0.0 Hz</p> <p>DI delayed status 0000 1000</p> <p>RO status 0100</p> <p>Communication diagnostics 0000 1101 1000 0000</p> <p>Options 7/8 Menu</p>
<p>Home view 8:</p> <ul style="list-style-type: none"> Process PID setpoint actual (PID unit 1): Parameter 40.03 Process PID setpoint actual Process PID feedback actual (PID unit 1): Parameter 40.02 Process PID feedback actual Output frequency (Hz): Parameter 01.06 Output frequency 	<p>Off ACH480 0.0 Hz</p> <p>Process PID setpoint a... 0.00 PID unit 1</p> <p>Process PID feedback ... 0.00 PID unit 1</p> <p>Output frequency 0.00 Hz</p> <p>Options 8/8 Menu</p>

■ IPC additional Home view displays

There are six preconfigured IPC Home views. You can browse them with the arrow keys (◀) and (▶). To edit Home views, press the Option softkey (⏏), see section [Options menu](#) on page 93.

<p>3</p> <p>IPC Home view 1 (default IPC Home view):</p> <ul style="list-style-type: none"> • Output frequency (Hz): Parameter 01.06 Output frequency • Process feedback (bar): Parameter 40.02 Process PID feedback actual • Multipump system status: Parameter 76.02 Multipump system status 	
<p>IPC Home view 2:</p> <ul style="list-style-type: none"> • Multipump node number: Parameter 76.22 Multipump node number • IPC synchronization checksum: Parameter 76.105 IPC synchronization checksum • IPC online pumps: Parameter 76.01 PFC status 	
<p>IPC Home view 3:</p> <ul style="list-style-type: none"> • Pump 1 running time: Parameter 77.11 Pump/fan 1 running time • Pump 2 running time: Parameter 77.12 Pump/fan 2 running time • Pump 3 running time: Parameter 77.13 Pump/fan 3 running time 	
<p>IPC Home view 4:</p> <ul style="list-style-type: none"> • Pump 4 running time: Parameter 77.14 Pump/fan 4 running time • Pump 5 running time: Parameter 77.15 Pump/fan 5 running time • Pump 6 running time: Parameter 77.16 Pump/fan 6 running time 	

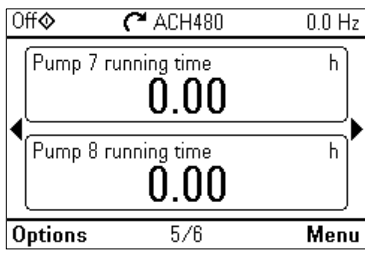
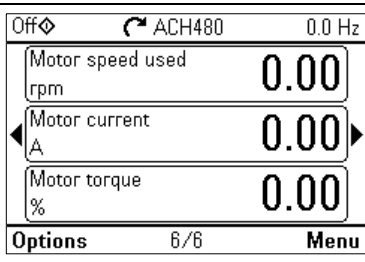
<p>IPC Home view 5:</p> <ul style="list-style-type: none"> • Pump 7 running time: Parameter 77.17 Pump 7 running time • Pump 8 running time: Parameter 77.18 Pump 8 running time 	 <p>Off ◊ ACH480 0.0 Hz</p> <p>Pump 7 running time h 0.00</p> <p>Pump 8 running time h 0.00</p> <p>Options 5/6 Menu</p>
<p>IPC Home view 6:</p> <ul style="list-style-type: none"> • Output frequency (Hz): Parameter 01.06 Output frequency • Motor current (A): Parameter 01.07 Motor current • Motor torque (%): Parameter 01.10 Motor torque 	 <p>Off ◊ ACH480 0.0 Hz</p> <p>Motor speed used rpm 0.00</p> <p>Motor current A 0.00</p> <p>Motor torque % 0.00</p> <p>Options 6/6 Menu</p>

Keys

The keys of the control panel are described below.



Left softkey

The left softkey (☞) is usually used for exiting and canceling. Its function in a given situation is shown by the softkey selection in the bottom left corner of the display.







Holding ☞ down exits each view in turn until you are back in the Home view. This function does not work in special screens.

Right softkey

The right softkey (☛) is usually used for selecting, accepting and confirming. The function of the right softkey in a given situation is shown by the softkey selection in the bottom right corner of the display.

The arrow keys

The up and down arrow keys (⬆ and ⬇) are used to highlight selections in menus and selection lists, to scroll up and down on text pages, and to adjust values when, for example, setting the time, entering a passcode or changing a parameter value.

The left and right arrow keys ( and ) are used to move the cursor left and right in parameter editing and to move forward and backward in assistants. In menus,  and  function the same way as  and , respectively.

Help

The help key () opens a help page. The help page is context-sensitive, in other words, the content of the page is relevant to the menu or view in question.

3

Hand, Off and Auto

The ACH480 can be in local or external control. The local control has two modes: Hand and Off. See also the diagram in section [Local control vs. external control](#) on page 101.

Hand key ():

- In local control / Off mode: Starts the drive. The drive will switch to the Hand mode.
- In external control: Switches the drive to local control / Hand mode, keeping it running.

Off key ():















- Stops the drive and switches to the Off mode.



Auto key ():

- In local control: The drive will switch to external control.

Key shortcuts

The table below lists key shortcuts and combinations. Simultaneous key presses are indicated by the plus sign (+).

Shortcut	Available in	Effect
 +  + 	any view	Save a screenshot. Up to fifteen images may be stored in the control panel memory. To transfer images to PC, connect the assistant control panel to PC with a USB cable and the panel will mount itself as an MTP (media transfer protocol) device. Pictures are stored in the screen shots folder. For more instructions, see <i>ACx-AP-x assistant control panels user's manual</i> (3AUA0000085685 [English]).
 +  ,  + 	any view	Adjust backlight brightness.
 +  ,  + 	any view	Adjust display contrast.
 or 	Home view	Adjust reference.
 + 	parameter edit views	Revert an editable parameter to its default value.

Shortcut	Available in	Effect
 + 	view showing a list of selections for a parameter	Show/hide selection index numbers.
 (keep down)	any view	Return to the Home view by pressing down the key until the Home view is shown.

4

Settings, I/O and diagnostics on the control panel

4

Contents of this chapter

This chapter provides detailed information about the **Primary settings**, **I/O**, **Diagnostics**, **System info**, **Energy efficiency** and **Backups** menus using the control panel.

To get to these menus from the Home view, first select **Menu** to go the **Main** menu, and in the **Main** menu, select the menu you want.

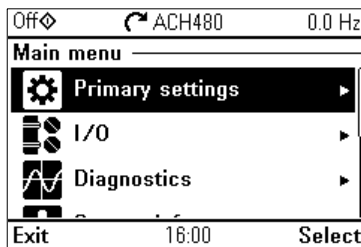
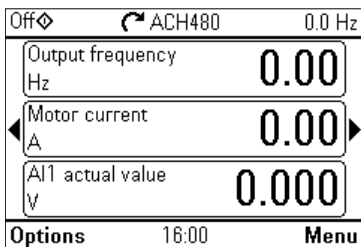

Primary settings

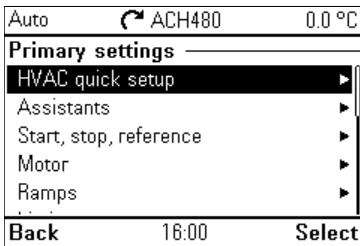

4

To go the **Primary settings** menu from the Home view, select **Menu > Primary settings**.

After using the guided settings with the first start assistant, you may want to select another default configuration by selecting **Start, stop, reference > Basic operations set-up** and **Start, stop, reference > Basic control set-up** and following the set-up assistants to configure process and control settings.

- The **Primary settings** menu enables you to adjust and define additional settings used in the drive.

With the **Primary settings** menu, you can also adjust settings related to the motor, fieldbus communication, PID, override, fault functions, advanced functions and clock, region and display. In addition, you can reset the fault and event logs, control panel Home view, parameters not related to hardware, fieldbus settings, motor data and ID run results, all parameters, end user texts as well as reset everything to factory defaults.

Note that the **Primary settings** menu enables you to program the majority of the drive functionality or features: more advanced configuration is done via the parameters: Select **Menu > Parameters**. For more information on the different parameters, see chapter [Parameters](#) on page 357.

In the **Setting** menu, the  symbol indicates multiple connected signals/parameters.

The  symbol indicates that the setting provides an assistant when modifying the parameters. When using an assistant make sure that all the set values are saved by completing the assistant.

To get more information on **Primary settings** menu items, press the  key to open the help page.

The sections below provide detailed information about the contents of the different submenus available in the **Primary settings** menu.

■ HVAC quick setup

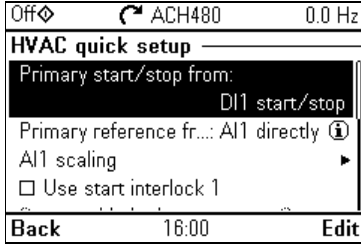

4

Use the **HVAC quick setup** submenu to go through the most important settings (basic setup and basic operation) at start-up if you do not want to do it with the assistants.

The table below provides detailed information about the available setting items in the HVAC quick setup submenu.

Menu item	Description	Corresponding parameter
Primary start/stop from:	Set where the start and stop comes in the Auto mode.	
Primary reference from:	Set where the reference comes in the Auto mode.	
AI scaling	Set the scaling of AI inputs.	
Use safety/start interlock 1	Selected/Unselected	20.47 Start interlock 1 text
Start enabled when:	Start enabled when: DIx high	20.41 Start interlock 1
Use run permissive	Selected/Unselected	20.46 Run permissive text
Run enabled when:	Run enabled when: DIx high	20.40 Run permissive
Minimum speed: Maximum speed: Minimum frequency: Maximum frequency:		30.11 Minimum speed 30.12 Maximum speed 30.13 Minimum frequency 30.14 Maximum frequency
Acceleration time:		23.12 Acceleration time 1 28.72 Freq acceleration time 1
Deceleration time:		23.13 Deceleration time 1 28.73 Freq deceleration time 1

Menu item	Description	Corresponding parameter
Motor nominal values	Enter the motor's nominal values from the motor's nameplate.	99.03 Motor type ... 99.12 Motor nominal torque
Start mode:	Set the motor start function for the current motor control mode (vector mode or scalar mode).	When in vector mode: 21.01 Start mode When in scalar mode: 21.19 Scalar start mode
Stop mode:	Set the way the motor is stopped when a stop command is received.	21.03 Stop mode
Date & time	Set the time and date, and their formats.	
Drive name	Set the name for the drive.	
Communication	Set up and view communication through the embedded fieldbus or fieldbus adapter. See section Communication (page 73).	Parameter groups: 50 Fieldbus adapter (FBA) 58 Embedded fieldbus

4

Assistants

Auto	ACH480	0.0 °C
Primary settings		
HVAC quick setup ▶		
Assistants ▶		
Start, stop, reference ▶		
Motor ▶		
Ramps ▶		
Back	16:00	Select

Off	ACH480	0.0 Hz
Assistants		
First start assistant		
Basic operation setup		
Basic control setup		
Nominal values		
ID run Not done		
Back	16:00	Select

Off	ACH480	0.0 Hz
Assistants		
PID assistant		
Security ▶		
Control mode Scalar		
Pumping mode: Off		
Synchronization settings		
Back	16:00	Select

The **Assistants** submenu includes a variety of assistants that can be used to configure the drive.

The table below provides detailed information about the available setting items in the **Assistants** submenu.

Menu item	Description	Corresponding parameter
First start assistant	Runs the same First start assistant that is used to commission the drive.	

Menu item	Description	Corresponding parameter
Basic operation setup	Ramps Limits Start interlock signal Run permissive signal Naming the drive	
Basic control setup	<u>Direct control via I/O (HVAC default configuration)</u> <ul style="list-style-type: none"> Reference (AI1) scaling <u>Direct control via fieldbus comm.</u> <ul style="list-style-type: none"> BACnet MS/TP Modbus RTU <u>PID control, single motor</u> <ul style="list-style-type: none"> Feedback (AI2) scaling Setpoint source Constant setpoint 	
Nominal values	Enter the motor's nominal values from the motor's nameplate. Configure a multi-motor set-up. Selects whether to use scalar or vector control mode. For information on scalar control mode, see section Scalar motor control on page 181. For information on vector control mode, see section Vector motor control on page 182	99.03 Motor type ... 99.12 Motor nominal torque
ID run	Perform the Identification run described in section How to perform the ID run (page 33).	99.13 ID run requested
PID assistant	Configures secondary control location to use PID control. <u>Feedback:</u> AI2. Adjust the scaling of AI2 signal for feedback, if required. <u>Setpoint:</u> Select a constant value, control panel or AI1. If you selected AI2, adjust the scaling of AI1 signal for setpoint. <u>Start/stop:</u> DI	
Security	See section Security (page 79).	
Control mode	Selects whether to use scalar or vector control mode. For information on scalar control mode, see section Scalar motor control on page 181. For information on vector control mode, see section Vector motor control on page 182.	99.04 Motor control mode

Menu item	Description	Corresponding parameter
⌘ Pumping mode	Selects the pumping mode. See section Multipump control on page 67. <ul style="list-style-type: none"> • Off • Intelligent pump control (IPC) • Level control (filling) (LC) • Level control (emptying) (LC) • Single pump control (PC) • Soft pump control (SPC) Note that here PC means PFC and SPC means SPFC.	76.21 Multipump configuration
⌘ Synchronization settings	Runs the Synchronization settings assistant.	96.20 Time sync primary source
⌘ Set HQ curve points	Runs the assistant for HQ performance curve for flow calculation. Note: This menu item is only visible if the parameter 80.13 value has been set to HQ curve .	80.13 Flow feedback function
⌘ Set PQ curve points	Runs the assistant for PQ performance curve for flow calculation. Note: This menu item is only visible if the parameter 80.13 value has been set to PQ curve .	80.13 Flow feedback function

■ Start, stop, reference

Off	ACH480	0.0 Hz
Start, stop, reference		
⌘ Basic operation setup		
⌘ Basic control setup		
Auto control selection: Primary only		
Primary auto control location ▶		
Interlocks/permissives ▶		
Back	16:01	Select

Use the **Start, stop, reference** submenu to set up start/stop commands, reference, and related features, such as constant speeds or run permissions.

The table below provides detailed information about the available setting items in the **Start, stop, reference** submenu.

Menu item	Description	Corresponding parameter
⌘ Basic operation setup	Ramps Limits Start interlock signal Run permissive signal Naming the drive	

Menu item	Description	Corresponding parameter
Basic control setup	<p><u>Direct control via I/O (HVAC default configuration)</u></p> <ul style="list-style-type: none"> Reference (AI1) scaling <p><u>Direct control via fieldbus comm.</u></p> <ul style="list-style-type: none"> BACnet MS/TP Modbus RTU <p><u>PID control, single motor</u></p> <ul style="list-style-type: none"> Feedback (AI2) scaling Setpoint source Constant setpoint 	
Primary auto control location	Settings for the primary remote control location, Ext1. Enabling Ext or 1 gives a second set of start/stop/reference sources for remote control.	<p>12.17 AI1 min</p> <p>12.18 AI1 max</p>
Secondary auto control location	Settings for the secondary remote control location, Ext2. These settings include reference source, start, stop, direction and command sources for Ext2. By default, Ext2 is set to Off .	<p>19.11 Ext1/Ext2 selection</p> <p>28.15 Ext2 frequency ref1 or</p> <p>22.18 Ext2 speed ref1</p> <p>12.17 AI1 min</p> <p>12.18 AI1 max</p> <p>12.27 AI2 min</p> <p>12.28 AI2 max</p> <p>20.06 Ext2 commands</p> <p>20.08 Ext2 in1 source</p> <p>20.09 Ext2 in2 source</p> <p>20.10 Ext2 in3 source</p>
Interlocks/permissives	Settings to prevent the drive from running or starting when a specific digital input is low. You can enter a custom text to use instead of "Run permissive", "Use safety/start interlock 1", "Use safety/start interlock 2", "Use safety/start interlock 3" and "Use safety/start interlock 4". See section Interlocks on page 174.	<p>20.40 Run permissive</p> <p>20.41 Start interlock 1</p> <p>20.42 Start interlock 2</p> <p>20.43 Start interlock 3</p> <p>20.44 Start interlock 4</p> <p>20.45 Start interlock stop mode</p>
Stop mode:	Sets how the drive stops the motor: with ramp or coast stop.	21.03 Stop mode

Menu item	Description	Corresponding parameter
Pump and fan control	<p>Selects PFC or SPFC control.</p> <p>Note that in the Pumping mode menu (Primary settings -> Assistants -> or Primary settings -> Pump features -> Multipump control ->), PFC is called PC and SPFC is called SPC.</p> <p>Configures the PFC/SPFC I/O.</p> <p>Configures PFC/SPFC control.</p> <p>Configures Autochange.</p> <p>See section <i>Single pump and fan control (PFC/SPFC)</i> on page 124.</p>	<p>76.21 Multipump configuration</p> <p>76.25 Number of motors</p> <p>76.27 Max number of motors allowed</p> <p>76.59 PFC contactor delay</p> <p>10.24 RO1 source</p> <p>10.27 RO2 source</p> <p>10.30 RO3 source</p> <p>15.07 RO4 source</p> <p>15.10 RO5 source</p> <p>15.13 RO6 source</p> <p>76.81 PFC 1 interlock</p> <p>76.82 PFC 2 interlock</p> <p>76.83 PFC 3 interlock</p> <p>76.84 PFC 4 interlock</p> <p>76.85 PFC 5 interlock</p> <p>76.86 PFC 6 interlock</p> <p>76.30 Start point 1</p> <p>76.31 Start point 2</p> <p>76.32 Start point 3</p> <p>76.33 Start point 4</p> <p>76.34 Start point 5</p> <p>76.41 Stop point 1</p> <p>76.42 Stop point 2</p> <p>76.43 Stop point 3</p> <p>76.44 Stop point 4</p> <p>76.45 Stop point 5</p> <p>76.55 Start delay</p> <p>76.56 Stop delay</p> <p>76.70 PFC Autochange</p> <p>76.71 PFC Autochange interval</p> <p>76.72 Maximum wear imbalance</p> <p>76.73 Autochange level</p>
Constant speeds / Constant frequencies	<p>These settings are for using a constant value as the reference. By default, constant freq/speed 1 is activated by DI3</p> <p>See section <i>Constant speeds/frequencies</i> on page 153.</p>	<p>28.21 Constant frequency function or 22.21 Constant speed function</p> <p>28.26 Constant frequency 1</p> <p>28.27 Constant frequency 2</p> <p>28.28 Constant frequency 3</p> <p>22.26 Constant speed 1</p> <p>22.27 Constant speed 2</p> <p>22.28 Constant speed 3</p>

Menu item	Description	Corresponding parameter
Start mode:	Sets how the drive starts the motor. <ul style="list-style-type: none"> • Constant time pre-magnetization • • • Ramp start (normal) • Flying start (automatic) • Automatic 	21.01 Start mode 21.02 Magnetization time
Start delay:	Sets how the drive starts the motor.	21.22 Start delay
Critical speeds/frequencies	Prevents running in critical ranges (speeds or frequencies). See section Critical speeds/frequencies on page 153.	Vector control: 22.51 Critical speed function 22.52 Critical speed 1 low 22.53 Critical speed 1 high 22.54 Critical speed 2 low 22.55 Critical speed 2 high 22.56 Critical speed 3 low 22.57 Critical speed 3 high Scalar control: 28.51 Critical frequency function... 28.57 Critical frequency 3 high

Motor

Off	ACH480	0.0 Hz
Motor		
Nominal values		
Control mode	Scalar	
Start mode:	Flying start (Automatic)	
Phase order:	U V W	
Switching frequency	4 kHz	
Back	16:01	Select

Off	ACH480	0.4 rpm
Motor		
Nominal values		
Control mode	Vector	
ID run	Done	
Start mode:	Flying start (Automatic)	
Phase order:	U V W	
Back	16:01	Select

Use the **Motor** submenu to adjust motor-related settings, such as nominal values, control mode or thermal protection.

Note that settings that are visible depend on other selections, for example, vector or scalar control mode, used motor type or selected start mode.

Three assistants are available: Control mode, Nominal value and ID run (for vector control mode only).

The table below provides detailed information about the available setting items in the **Motor** submenu.

Menu item	Description	Corresponding parameter
✖ Nominal values	Enter the motor's nominal values from the motor's nameplate. Configure a multi-motor set-up.	99.03 Motor type ... 99.12 Motor nominal torque
✖ Control mode	Selects whether to use scalar or vector control mode. For information on scalar control mode, see section Scalar motor control on page 181. For information on vector control mode, see section Vector motor control on page 182.	99.04 Motor control mode
Start mode:	Sets how the drive starts the motor (for example, pre-magnetize or not). <ul style="list-style-type: none"> • Fast • Constant time pre-magnetizationAutomatic • Ramp start (normal) • • Flying start (automatic) 	21 Start/stop mode 21.02 Magnetization time
Phase order:	If the forward direction of the motor is wrong, change this setting to fix the direction instead of changing the phase order on the motor cable.	99.16 Motor phase order
Switching frequency	Sets the target and lowest allowed switching frequencies. For more information, see section Switching frequency on page 187.	97.01 Switching frequency reference 97.02 Minimum switching frequency
U/f ratio:	The form of voltage to frequency ratio below field weakening point. For more information, see section U/f ratio on page 183.	97.20 U/F ratio
IR compensation:	Sets how much to boost voltage at zero speed. Increase this for higher break-away torque. For more information, see section IR compensation for scalar motor control on page 181.	97.13 IR compensation
Pre-heating	Settings for motor preheating. The drive can prevent condensation in a stopped motor by feeding it a fixed current (% of motor nominal current). Use in humid or cold conditions to prevent condensation. For more information, see section Start methods – DC magnetization on page 185.	21.14 Pre-heating input source 21.16 Pre-heating current

Menu item	Description	Corresponding parameter
Thermal protection estimated	The settings in this submenu are meant to protect the motor from overheating by automatically triggering a fault or warning above a certain temperature. By default, motor thermal estimate protection is on. We recommend checking the values for the protection to function properly. For more information, see section Motor thermal protection on page 188.	35 Motor thermal protection
Thermal protection measured	The settings in this submenu are meant to protect the motor with a thermal measurement from overheating by automatically triggering a fault or warning above a certain temperature. For more information, see section Motor thermal protection on page 188.	35 Motor thermal protection
Stall protection	The settings in this submenu are meant to protect the motor in a stall situation. You can adjust the supervision limits (current, frequency and time) and choose how the drive reacts to a motor stall condition. For more information, see section Stall protection (parameters 31.24...31.28) on page 210.	31.24 Stall function 31.25 Stall current limit 31.26 Stall speed limit 31.27 Stall frequency limit 31.28 Stall time

Pump features

Off	ACH480	0.0 Hz
Pump features		
Dry pump protection		▶
Flow calculation	0.00 m ³ /h	▶
Soft pipe fill		▶
Multipump control	Off	▶
Back	16:01	Select

Use the **Pump features** submenu to adjust pump-related settings, such as pump protection functionalities or soft pipe fill.

The table below provides detailed information about the available setting items in the **Pump features** submenu.

Menu item	Description	Corresponding parameter
Dry pump protection	Configures settings for dry run protection. Dry run protection function ensures that the water pump is not running without water and protects the pump from damaging.	82.20 Dry run protection 82.21 Dry run source

Menu item	Description	Corresponding parameter
Flow calculation	Configures the settings for sensor based or sensorless flow calculation functionality. Flow calculation measures the amount of water flowing based on the sensor feedback or without sensor based on the pump curve data.	80.12 Flow feedback 2 source 80.13 Flow feedback function 80.14 Flow feedback multiplier 80.15 Maximum flow 80.16 Minimum flow 80.17 Maximum flow protection 80.18 Minimum flow protection 80.19 Flow check delay 81.10 Inlet pressure source 81.11 Outlet pressure source 82.30 Outlet minimum pressure protection 82.31 Outlet minimum pressure warning level 82.35 Outlet maximum pressure protection 82.37 Outlet maximum pressure warning level 82.40 Inlet minimum pressure protection 82.41 Inlet minimum pressure warning level 82.45 Pressure check delay
Soft pipe fill	Configures settings for filling the pipeline with a gentle approach. This helps to avoid sudden pressure peaks and reduces the risk of water hammer which can cause damage to the water pipes.	40.14 Set 1 setpoint scaling 40.28 Set 1 setpoint increase time 40.29 Set 1 setpoint decrease time 82.25 Soft pipe fill supervision
Multipump control	See section Multipump control on page 67.	

PID control

Off	ACH480	0.0 Hz
PID control		
*PID assistant		
<input checked="" type="checkbox"/> Use PID control		
Activate PID control f...: Always acti...		
Start/stop/dir from: Not selected		
Unit: PID unit 1		
Back	16:01	Select

The **PID** submenu contains settings and actual values for the process PID controller. PID is only used in remote control.

See also section [Process PID control](#) on page 160.

The table below provides detailed information about the available setting items in the **PID** submenu.

Menu item	Description	Corresponding parameter
*PID assistant	Configures secondary control location to use PID control. <u>Feedback</u> : AI2. Adjust the scaling of AI2 signal for feedback, if required. <u>Setpoint</u> : Select a constant value, control panel or AI1. If you selected AI2, adjust the scaling of AI1 signal for setpoint. <u>Start/stop</u> : DI	
Use PID control:	Select if PID control is used or not.	40.07 Process PID operation mode
Activate PID control from	Sets where the drive gets the signal to switch between control locations (Ext1 and Ext2)	19.11 Ext1/Ext2 selection
Start/stop/dir from:	Selects the source for start, stop and direction.	20.01 Ext1 commands 20.02 Ext1 start trigger type 20.03 Ext1 in1 source 20.04 Ext1 in2 source 20.05 Ext1 in3 source 20.06 Ext2 commands 20.07 Ext2 start trigger type 20.08 Ext2 in1 source 20.09 Ext2 in2 source 20.10 Ext2 in3 source
Unit:	PID unit 1 (PID customer unit). Sets the text shown as the unit for setpoint, feedback and deviation.	
PID status:	View process PID status.	40.06 Process PID status word

Menu item	Description	Corresponding parameter
Feedback:	View or configure process PID feedback, ie, the measured value.	40.02 Process PID feedback actual 40.08 Set 1 feedback 1 source 40.11 Set 1 feedback filter time
Setpoint:	View or configure the process PID setpoint, ie, the target process value. You can also use a constant setpoint value instead of (or in addition to) an external setpoint source. When a constant setpoint is active, it overrides the normal setpoint.	40.03 Process PID setpoint actual 40.16 Set 1 setpoint 1 source 40.26 Set 1 setpoint min 40.27 Set 1 setpoint max
Tuning	The Tuning submenu contains settings for gain, integration time and derivation time. <ol style="list-style-type: none">1. Make sure it is safe to start the motor and run the actual process.2. Start the motor in remote control.3. Change setpoint by a small amount.4. Watch how feedback reacts.5. Adjust gain/integration/derivation.6. Repeat steps 3-5 until feedback reacts as desired.	40.04 Process PID deviation actual 40.32 Set 1 gain 40.33 Set 1 integration time 40.34 Set 1 derivation time 40.35 Set 1 derivation filter time
Increase output:	Select whether deviation means “feedback minus setpoint” or “setpoint minus feedback”: <ul style="list-style-type: none">• Feedback < Setpoint: Drive increases motor speed when feedback signal is below setpoint. Examples: Supply fan or pump.• Feedback > Setpoint: Drive increases motor speed when feedback signal is greater than setpoint. Example: Cooling tower.	40.31 Set 1 deviation inversion
Output	View the process PID output or set its range.	40.01 Process PID output actual 40.36 Set 1 output min 40.37 Set 1 output max
Sleep function	The sleep function can be used to save energy by stopping the motor during low demand. By default, sleep function is disabled. If enabled, the motor automatically stops when demand is low, and starts again when deviation grows too large. This saves energy when rotating the motor at low speeds would be useless. See section Sleep and boost functions for process PID control on page 160.	40.43 Set 1 sleep level 40.44 Set 1 sleep delay 40.45 Set 1 sleep boost time 40.46 Set 1 sleep boost step 40.47 Set 1 wake-up deviation 40.48 Set 1 wake-up delay

Multipump control

Auto	ACH480	0.0 °C
Multipump control		
Pumping mode:		Off
Back	16:05	Select

Auto	ACH480	0.0 °C
Pumping mode		
Select pumping mode to use:		
Off		
Intelligent pump control (IPC)		
Single pump control		
Soft pump control		
Back	16:05	Next

Auto	ACH480	0.0 °C
I2I configuration		
Select the intelligent pump control communication via:		
EFB		
FBA (FMBA-01)		
Back	16:05	Next

Auto	ACH480	0.0 °C
Settings for this pump		
Drive name	ACH480	
Node number:	1	
<input checked="" type="checkbox"/> Can be master		
Prefer this pump:	Medium	
Back	16:05	Edit

Auto	ACH480	0.0 °C
Pump node number		
Set node number for this drive:		
Node number:	1	
Back	16:05	Next

Auto	ACH480	0.0 °C
Multipump control		
Pumping mode:		IPC
Multipump comms (I2I) link:		EFB
Settings for this pump		▶
Shared settings		▶
Back	16:05	Select

Auto	ACH480	0.0 °C
Shared settings		
Synchronization settings		
Total number of pumps:	1	
Always run at least:	1 pumps	
Never run more than:	1 pumps	
Transition smoothing	▶	
Back	16:05	Select

Auto	ACH480	0.0 °C
Multipump control		
Pumping mode:		PC
Configure pump control I/O		▶
Configure pump control		▶
Configure Autochange		Not selected ▶
Back	16:07	Select

Auto	ACH480	0.0 °C
Multipump control		
Pumping mode:		SPC
Configure pump control I/O		▶
Configure pump control		▶
Configure Autochange		Not selected ▶
Back	16:07	Select

Auto	ACH480	0.0 °C
Configure pump control I/O		
Number of motors:		6
Contactor delay:		0.50 s
Configure RO:s		▶
Configure interlocks		▶
Check I/O configuration		▶
Back	16:07	Edit

Auto	ACH480	0.0 °C
Configure pump control		
PC start, stop, reference		▶
Configure Process PID		▶
Aux motors started at:		48.00 Hz
Aux motors stopped at:		25.00 Hz
Start delay:		10.00 s
Back	16:07	Select

Auto	ACH480	0.0 °C
Configure Autochange		
Autochange triggered by:		Not selected
Autochange allowed below:		100.0 %
Back	16:07	Edit

Multipump (IPC, intelligent pump control) systems allows up to 8 drives to be connected to each other. This menu contains programming assistants for load sharing, balancing the run time between the pumps and keeping each pump running optimally.

If the active pumps cannot meet the demand, the system automatically starts or stops pumps one by one. Pump order can be set by the efficiency class of each pump (e.g. pumps with high efficiency are primarily used) or in order to balance the runtime (pumps which run the least, start first). This saves energy and extends the pump life time.

See also section [Pump and fan control features](#) on page 112.

The table below provides detailed information about the available setting items in the **Multipump control** submenu.

Menu item	Description	Corresponding parameter
✖ Pumping mode	<p>Selects the pumping mode.</p> <ul style="list-style-type: none"> • Off • Intelligent pump control (IPC) • Single pump control (PC) • Soft pump control (SPC) <p>Note that here PC means PFC and SPC means SPFC.</p>	76.21 Multipump configuration
<p><i>For intelligent pump control (IPC):</i> Pump node number</p>	Node number:	76.22 Multipump node number
<p><i>For intelligent pump control (IPC):</i> I2I configuration / Multipump comms (I2I) link</p>	Selects if EFB or FMBA-01 via FBA is used for communication.	76.24 IPC communication port
<p><i>For intelligent pump control (IPC):</i> Settings for this pump</p>	<p>Drive name</p> <p>Node number</p> <p>Can be master</p> <p>Prefer this pump</p>	<p>76.22 Multipump node number</p> <p>76.23 Master enable</p> <p>76.77 Pump priority</p>
<p><i>For intelligent pump control (IPC):</i> Shared settings</p>	<p>✖ Synchronization settings</p> <p>Total number of pumps</p> <p>Efficient speed</p> <p>Always run at least: 1 pumps (<i>for IPC</i>)</p> <p>Never run more than: 8 pumps (<i>for IPC</i>)</p>	<p>76.25 Number of motors</p> <p>76.26 Min number of motors allowed</p> <p>76.27 Max number of motors allowed</p>

Menu item	Description	Corresponding parameter
<p><i>For intelligent pump control (IPC):</i> Shared settings</p>	<p>Start/stop speeds (<i>for IPC</i>)</p> <p>Start 2nd pump at:</p> <p>...</p> <p>Start xth pump at: (as an example $x = 4 =$ Total number of pumps)</p> <p>Stop xth pump at:</p> <p>...</p> <p>Stop 1st pump at:</p> <p>Transition smoothing (<i>for IPC</i>)</p> <p>Ignore demand spikes under</p> <p>Ignore demand dips under</p> <p>Autochange</p> <p>Autochange triggered by: Even wear</p> <p>Maximum wear imbalance: 10.00 h</p> <p>Maximum stationary time: 0.0 h</p> <p>Autochange only below: 45 Hz (<i>for IPC</i>)</p> <p>PID control (<i>for IPC</i>)</p> <p>See PID control submenu on page 65.</p>	<p>76.30 Start point 1</p> <p>...</p> <p>76.36 Start point 7</p> <p>76.41 Stop point 1</p> <p>...</p> <p>76.47 Stop point 7</p> <p>...</p> <p>76.55 Start delay</p> <p>76.56 Stop delay</p> <p>...</p> <p>76.70 PFC Autochange</p> <p>76.72 Maximum wear imbalance</p> <p>76.76 Max stationary time</p> <p>76.73 Autochange level</p>
<p><i>For single pump control (PC):</i> Configure pump control I/O</p>	<p>Number of motors:</p> <p>Include drive motor</p> <p>Contactor delay</p> <p>Configure RO:s</p> <p>PC2 is controlled by:</p> <p>...</p> <p>PC6 is controlled by:</p> <p>Configure interlocks</p> <p>PC1 is interlocked by:</p> <p>...</p> <p>PC6 is interlocked by</p> <p>Check I/O configuration</p> <p>See I/O menu on page 86.</p>	<p>76.25 Number of motors</p> <p>76.59 PFC contactor delay</p> <p>10.24 RO1 source</p> <p>10.27 RO2 source</p> <p>10.30 RO3 source</p> <p>15.07 RO4 source</p> <p>15.10 RO5 source</p> <p>15.13 RO6 source</p> <p>...</p> <p>76.81 PFC 1 interlock</p> <p>76.82 PFC 2 interlock</p> <p>76.83 PFC 3 interlock</p> <p>76.84 PFC 4 interlock</p> <p>76.85 PFC 5 interlock</p> <p>76.86 PFC 6 interlock</p>
<p><i>For soft pump control (SPC):</i> Configure pump control</p>	<p>PC Start, stop, reference</p> <p>Secondary auto control location</p> <p>Start/stop from:</p> <p>Reference from:</p> <p>Configure Process PID:</p> <p>See PID control submenu on page 65.</p> <p>Aux motors started at:</p> <p>Aux motors stopped at:</p> <p>Start delay:</p> <p>Stop delay:</p>	<p>76.55 Start delay</p> <p>76.56 Stop delay</p>

Menu item	Description	Corresponding parameter
For single pump control (PC) and for soft pump control (SPC): Configure Autochange	Autochange triggered by: Fixed interval: (for fixed interval) Maximum wear imbalance: (for even wear) Autochange allowed below:	76.70 PFC Autochange 76.71 PFC Autochange interval 76.72 Maximum wear imbalance

Ramps

Off	ACH480	0.0 Hz
Ramps		
Acceleration time:	30.000 s	
Deceleration time:	30.000 s	
Stop mode:	Coast	
Ramp time target frequency:	50.00 Hz	
<input type="checkbox"/> Use two ramp sets		
Back	16:01	Edit

4

Use the **Ramps** submenu to set up acceleration and deceleration settings.

See also section [Ramps](#) on page 156.

Note: To set ramps, you also have to specify parameter [46.01 Speed scaling](#) (in speed control mode) or [46.02 Frequency scaling](#) (in frequency control mode).

The table below provides detailed information about the available setting items in the **Ramps** submenu.

Menu item	Description	Corresponding parameter
Acceleration time:	This is the time between standstill and “scaling speed” when using the default ramps (set 1).	23.12 Acceleration time 1 28.72 Freq acceleration time 1
Deceleration time:	This is the time between standstill and “scaling speed” when using the default ramps (set 1).	23.13 Deceleration time 1 28.73 Freq deceleration time 1
Stop mode:	Sets how the drive stops the motor.	21.03 Stop mode
Ramp time target frequency:	Sets the maximum frequency for acceleration = the initial frequency for deceleration. For scalar control mode.	46.02 Frequency scaling
Ramp time target speed:	Sets the maximum speed for acceleration = the initial speed for deceleration. For vector control mode	46.01 Speed scaling
Use two ramp sets	Sets the use of a second acceleration/deceleration ramp set. If unselected, only one ramp set is used. Note that if this selection is not enabled, the selections below are not available.	

Menu item	Description	Corresponding parameter
Activate ramp set 2	To switch ramp sets, you can either: <ul style="list-style-type: none"> • use a digital input (low = set 1; high = set 2), or • automatically switch to set 2 above a certain frequency/speed. 	23.11 Ramp set selection 28.71 Freq ramp set selection
Acceleration time 2	Sets the time between standstill and “scaling speed” when using ramp set 2.	23.14 Acceleration time 2 28.74 Freq acceleration time 2
Deceleration time 2	Sets the time between standstill and “scaling speed” when using ramp set 2.	23.15 Deceleration time 2 28.75 Freq deceleration time 2

4

Limits

Off	ACH480	0.0 Hz
Limits		
Minimum frequency:		0.00 Hz
Maximum frequency:		50.00 Hz
Maximum current:		3.06 A
Back	16:01	Edit

Use the **Limits** submenu to set the allowed operating range. This function is intended to protect the motor, connected hardware and mechanics. The drive stays within these limits, no matter what reference value it gets. See section [Communication](#) on page [73](#).

See also section [Limits](#) on page [163](#).

Note: These limit parameters have no effect on ramps.

The table below provides detailed information about the available setting items in the **Limits** submenu.

Menu item	Description	Corresponding parameter
Minimum frequency:	Sets the minimum operating frequency. Affects scalar control only.	30.13 Minimum frequency
Maximum frequency:	Sets the maximum operating frequency. Affects scalar control only.	30.14 Maximum frequency
Minimum speed:	Sets the minimum operating speed. Affects vector control only.	30.11 Minimum speed
Maximum speed:	Sets the maximum operating speed. Affects vector control only.	30.12 Maximum speed
Minimum torque:	Sets the minimum operating torque. Affects vector control only.	30.19 Minimum torque 1

Menu item	Description	Corresponding parameter
Maximum torque:	Sets the maximum operating torque. Affects vector control only.	30.20 Maximum torque 1
Maximum current:	Sets the maximum output current.	30.17 Maximum current

Communication

Off	ACH480	0.0 rpm
Communication		
Embedded fieldbus	Off	▶
Fieldbus adapter	Not used	▶
Back	16:02	Select

Use the **Communication** menu to set up and view communication through embedded fieldbus or fieldbus adapter.

Embedded fieldbus

Off	ACH480	0.0 rpm
Embedded fieldbus		
Communication setup		▶
Back	16:02	Select

Off	ACH480	0.0 Hz
Communication setup		
EFB selection:	Not selected	
Back	16:02	Edit

Off	ACH480	50.0 Hz
EFB selection:		
Not selected		
BACnet MS/TP		
Modbus RTU		
Cancel	09:36	Save

Use the settings in the **Embedded fieldbus** submenu to use the drive with the Modbus RTU and BACnet MS/TP protocols.

You can also configure all the embedded fieldbus related settings via the parameters (parameter group [58 Embedded fieldbus](#)), but the purpose of the **Embedded fieldbus** submenu is to make the protocol configurations easier.

For N2 protocol, you have to do the configuration through parameters (parameter group [58 Embedded fieldbus](#)).

See also chapters

- [Fieldbus control through a fieldbus adapter](#) on page 249
- [BACnet MS/TP control through the embedded fieldbus interface \(EFB\)](#) on page 279
- [N2 control through the embedded fieldbus interface \(EFB\)](#) on page 309.

The table below provides detailed information about the available setting items in the **Embedded fieldbus** submenu. Note that some of the items only become active once you have enabled embedded fieldbus.

4

Menu item	Description	Corresponding parameter
EFB selection	Select the protocol you want to use.	58.01 Protocol enable
Communication setup	To set up communication between the drive and the fieldbus master, define these settings and then select Apply settings to embedded fieldbus module .	58 Embedded fieldbus 58.03 Node address (Station ID) 58.04 Baud rate Modbus RTU: 58.05 Parity Modbus RTU: 58.25 Control profile 58.40 Device object ID 58.41 Max master 58.42 Max info frames 58.43 Max APDU retries 58.14 Communication loss action 58.15 Communication loss mode 58.16 Communication loss time 58.06 Communication control
Diagnostics	Diagnose embedded fieldbus communication, such as status, load of communication and message counters. <ul style="list-style-type: none"> • Actual status: • Status value: • EFB data from client View what the drive EFB receives from the fieldbus master (BACnet client, eg BMS). • EFB data to client View what the drive EFB sends to the fieldbus master (BACnet client, eg BMS). 	58.07 Communication diagnostics 58.08 Received packets 58.11 UART errors 58.12 CRC errors 58.13 Token counter 58.18 EFB control word 03.09 EFB reference 1 58.09 Transmitted packets 58.19 EFB status word

Fieldbus adapter

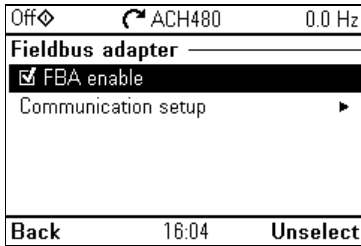

Use the settings in the **Fieldbus adapter** submenu to use the drive with the following fieldbus protocols, shown with the optional fieldbus adapter module required:

- BACnet/IP: FBIP-21 adapter
- CANopen: FCAN-01 adapter
- ControlNet: FCNA-01 adapter
- DeviceNet: FDNA-01 adapter
- EtherCAT: FECA-01 adapter
- Ethernet/IP: FEIP-21 adapter, FENA-21 adapter
- ETH Pwrlink (Ethernet Powerlink): FEPL-02 adapter
- ModbusTCP: FMBT-21 adapter, FENA-21 adapter
- PROFIBUS-DB: FBPA-01 adapter
- PROFINET IO: FPNO-21 adapter, FENA-21 adapter
- Ethernet/IP: FENA-21 adapter

Check the supported fieldbus modules with your ABB representative.

You can also configure all the fieldbus related settings via the parameters (parameter groups [50 Fieldbus adapter \(FBA\)](#), [51 FBA A settings](#), [52 FBA A data in](#), [53 FBA A data out](#), [58 Embedded fieldbus](#), but the purpose of the **Fieldbus adapter** submenu is to make the protocol configurations easier.

See also chapter [Fieldbus control through a fieldbus adapter](#) on page [323](#).

The table below provides detailed information about the available setting items in the **Fieldbus adapter** submenu. Note that some of the items only became active once you have enabled fieldbus.

Menu item	Description	Corresponding parameter
Fieldbus adapter	FBA enable: Select this if you want to use the drive with a fieldbus adapter.	50.01 FBA A enable

Menu item	Description	Corresponding parameter
Communication setup	<p>Select the module (protocol).</p> <p>To set up communication between the drive and the fieldbus master, define these settings and then select Apply settings to fieldbus module.</p>	<p>51.01 FBA A type 58.01 Protocol enable 51 FBA A settings 51.01 FBA A type 51.02 FBA A Par2 51.27 FBA A par refresh 51.31 D2FBA A comm status 50.13 FBA A control word 50.16 FBA A status word 51.27 FBA A par refresh</p>
Diagnostics	<p>Diagnose fieldbus communication, such as status, load of communication and message counters.</p> <p>Information on FBA A data from master and to master.</p>	
Drive control setup	<p>Sets how a fieldbus master can control this drive, and how the drive reacts if the fieldbus communication fails.</p> <p>Define these settings and then select Apply settings to fieldbus module.</p>	<p>20.01 Ext1 commands 19.11 Ext1/Ext2 selection 22.11 Ext1 speed ref1 28.11 Ext1 frequency ref1 22.41 Speed ref safe 28.41 Frequency ref safe 50.03 FBA A comm loss t out 46.01 Speed scaling 46.02 Frequency scaling 23.12 Acceleration time 1 23.13 Deceleration time 1 28.72 Freq acceleration time 1 28.73 Freq deceleration time 1 51.27 FBA A par refresh</p>

■ Override

Off	ACH480	0.0 Hz
Override		
Override mode:	Normal	
Activate override from:	DI6 high	
Reference from:	Constant frequencies	
Constant frequencies	▶	
Direction selection:	Forward	
Back	16:02	Edit

Off	ACH480	0.0 Hz
Reference from:		
Constant frequencies		
AI1 directly		
AI2 directly		
Override frequency		
Floating point		
Cancel	16:02	Save

Off	ACH480	0.0 Hz
Override safeties		
<input checked="" type="checkbox"/>	Use run permissive signal	
<input checked="" type="checkbox"/>	Use start interlock 1	
<input checked="" type="checkbox"/>	Use start interlock 2	
<input type="checkbox"/>	Use start interlock 3	
<input type="checkbox"/>	Use start interlock 4	
Back	16:03	Unselect

OVERRIDE	ACH480	0.0 Hz
	Warning AFPE Aux code: 0000 0000	
Override active	16:03:07	
Drive is in override mode		
Hide	16:03	How to fix

4

The Override submenu contains settings for the Override function.

See also section [Override](#) on page [164](#).

Menu item	Description	Corresponding parameter
	Override mode Activate override from: Reference from: Override frequency: Direction selection: Override safeties:	70.02 Override enable 70.02 Override activation source 70.04 Override reference source 70.06 Override frequency 70.05 Override direction 70.10 Override enables selection
	Use autoreset for critical faults Wait between reset attempts: Max attempts:	70.20 Override fault handling 70.22 Override auto reset time 70.21 Override auto reset trials

Fault functions

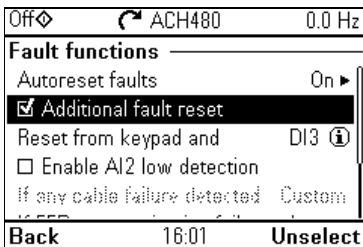

4

The **Fault functions** submenu contains settings for resetting faults automatically or manually.

Menu item	Description	Corresponding parameter
Autoreset faults	Reset faults automatically. For more information, see section Sleep and boost functions for process PID control on page 160.	31.12 Autoreset selection 31.14 Number of trials 31.15 Total trials time 31.16 Delay time
Additional fault reset	You can reset an active fault via I/O: a rising pulse in the selected input means reset. A fault can be reset from the fieldbus even if Reset faults manually is unselected.	31.11 Fault reset selection
Reset from keypad and...	Define from where you want to reset faults manually. Note that this submenu is active only if you have selected to reset faults manually.	31.11 Fault reset selection
Enable AI2 low detection	Enable AI2 minimum limit supervision AI2 < MIN.	12.04 AI supervision selection , bit 2
If any cable failure detected	Define action to be taken when AI2 low detection is enabled and AI2 is less than the minimum limit (AI2 < MIN).	12.03 AI supervision function
If EFB communication fails:	Define action to be taken if EFB communication fails.	58.14 Communication loss action
If EFB communication under monitoring:	Define which message types reset the timeout counter for detecting an EFB communication loss.	58.15 Communication loss mode
Ignore EFB failures shorter than:	Define a timeout for EFB communication. If a communication break lasts longer than the timeout, the action specified in If EFB communication fails: is taken.	58.16 Communication loss time

Security



The **Security** submenu is a protected menu that you can open with the user pass code. The menu lets you prevent actions and functionalities with the user lock. You can also change the user lock pass code.

See also section [User lock](#) on page 215.

Menu item	Description	Corresponding parameter
Unlock this menu / Lock this menu	You have to enter the user passcode to unlock the menu. The default passcode is "10000000". While you have the user lock open, warning A6B0 User lock is open is active. After making your changes in the menu, select row Lock this menu and press Select .	96.02 Pass code
Lock all parameters Disable backup and restore Disable OEM access level Disable ABB access level Disable file download		96.102 User lock functionality
Change security passcode	Note: You must change the default user pass code to maintain a high level of cybersecurity. <u>Store the code in a safe place – ABB CANNOT UNLOCK THE DRIVE ONCE YOU CHANGE THE PASS CODE.</u> Enter first the new passcode and then re-enter the new passcode to confirm it.	96.02 Pass code 96.100 Change user pass code 96.101 Confirm user pass code

Advanced functions

Off	ACH480	0.0 Hz
Advanced functions		
External events		▶
Supervision		▶
Timed functions	Enabled	▶
User sets		▶
First start assistant		
Back	16:01	Select

4

The **Advanced functions** submenu contains settings for advanced functions, such as triggering or resetting custom faults via I/O, signal supervision, using the drive with timed functions, or switching between several entire sets of settings. In addition you can run the First start assistant from this submenu.

The table below provides detailed information about the available setting items in the **Advanced functions** submenu.

Menu item	Description	Corresponding parameter
External events	Enables you to define custom faults or warnings you can trigger via digital input. The texts of these messages are customizable. For more information, see section External events on page 153 .	31.01 External event 1 source 31.02 External event 1 type 31.03 External event 2 source 31.04 External event 2 type 31.05 External event 3 source 31.06 External event 3 type

Menu item	Description	Corresponding parameter
Supervision	<p>You can select three signals to be supervised. If a signal is outside predefined limits a fault or warning is generated. For complete settings, see group 32 Supervision on page 485.</p> <p>For more information, see section Signal supervision on page 203.</p>	32.01 Supervision status 32.05 Supervision 1 function 32.06 Supervision 1 action 32.07 Supervision 1 signal 32.09 Supervision 1 low 32.10 Supervision 1 high 32.11 Supervision 1 hysteresis... 32.25 Supervision 3 function 32.26 Supervision 3 action 32.27 Supervision 3 signal 32.29 Supervision 3 low 32.30 Supervision 3 high 32.31 Supervision 3 hysteresis
Timed functions	<p>Enables using the drive with timed functions. For complete settings, see group 34 Timed functions on page 496.</p> <p>For more information, see section Timed functions on page 155.</p>	34.100 Timed function 1 34.101 Timed function 2 34.102 Timed function 3 34.111 Boost time activation source 34.112 Boost time duration 34.11 Timed functions enable 34.11 Timer 1 configuration 34.12 Timer 1 start time 34.13 Timer 1 duration ... 34.44 Timer 12 configuration 34.45 Timer 12 start time 34.46 Timer 12 duration
User sets	<p>This submenu enables you to save four sets of settings for easy switching.</p> <p>For more information about user sets, see section Data storage parameters on page 214.</p>	96.11 User set save/load 96.10 User set status 96.12 User set I/O mode in1 96.13 User set I/O mode in2

Menu item	Description	Corresponding parameter
Confirmation for HAND/OFF	<p>Selects if you want to add confirmation for Hand and Off buttons so that they need to be pressed twice within five seconds to operate. The control panel shows a message about pressing twice after the first press.</p> <p>This selection can be used to prevent accidental Hand and Off button presses.</p> <p>If Hand and/or Off buttons are disabled with parameters 19.18 HAND/OFF disable source and 19.19 HAND/OFF disable action, this setting has no effect.</p>	
Energy optimizer:	Enables/disables the energy optimization function.	45.11 Energy optimizer

■ Clock, region, display

Off	ACH480	50.0 Hz
Clock, region, display		
Select drive		
Language		
Date & time		
Units		
Drive name	ACH480	
Back	09:55	Select

The **Clock, region, display** submenu contains settings for language, date and time, display (such as brightness) and settings for changing how information is displayed on screen.

The table below provides detailed information about the available setting items in the **Clock, region, display** submenu.

Menu item	Description	Corresponding parameter
Select drive	<p>If more than one drive is connected to this control panel, select the drive to be controlled here.</p> <p>To see the other drives, set <i>Panel bus</i> to <i>On</i> and enable networking in the parameters of each drive.</p>	
Language	Change the language used on the control panel screen. Note that the language is loaded from the drive so this takes some time.	96.01 Language
Date & time	Set the time and date, and their formats.	
Units	Select the units used for power, temperature, torque and currency.	96.16 Unit selection

Menu item	Description	Corresponding parameter
Drive name	The drive name defined in this setting is shown in the PC tool and at the status bar at the top of the control panel screen while using the drive. If more than one drives are connected to the control panel, the drive names make it easy to identify each drive. It also identifies any backups you create for this drive.	
Contact info in fault view	Define a fixed text that is shown during any fault (for example, who to contact in case of a fault). If a fault occurs, this information appears on the control panel screen (in addition to the fault-specific information).	
Edit texts	Set the drive name, adjust currency unit and PID unit, and edit Start interlocks 1...4, Run permissive, Signal supervisions 1...3, External events 1...3, Contact info.	
Display settings	Adjust the brightness, contrast and display power save delay of the control panel screen or to invert white and black.	
Show in lists	Show or hide the numeric IDs of: <ul style="list-style-type: none"> • parameters and groups • option list items • bits • devices in Options > Select drive 	
Edit Home view	Select the parameters displayed in the Home view, with display style, decimals, name, unit, minimum and maximum.	
Show inhibit pop-up	Enables or disables pop-up views showing information on inhibits, for example, when you try to start the drive but it is prevented.	

Reset to defaults

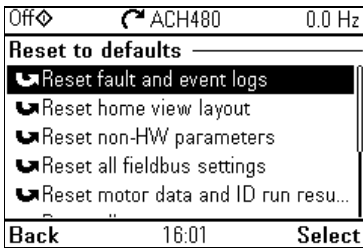

4

The **Reset to defaults** submenu enables you to reset parameters and other settings.

Menu item	Description	Corresponding parameter
Reset fault and event logs	Clears all events from the drive's fault and event logs.	96.51 Clear fault and event logger
Reset home view layout	Restores the home view layout back to show the values of the default parameters defined by the selected control macro.	96.06 Parameter restore , selection Reset home view
Reset non-HW parameters	Restores all editable parameter values to default values, except <ul style="list-style-type: none"> motor data and ID run results I/O extension module settings end user texts, such as customized warnings and faults, and the drive name control panel/PC communication settings fieldbus adapter settings parameter 95.01 Supply voltage parameter 95.20 HW options word 1 user lock configuration parameters 96.100...96.102. 	96.06 Parameter restore , selection Restore defaults
Reset all fieldbus settings	Restores all fieldbus and communication related settings to default values. Note: Fieldbus, control panel and PC tool communication are interrupted during the restore.	96.06 Parameter restore , selection Reset all fieldbus settings
Reset motor data and ID run results	Restores all motor nominal values and motor ID run results to default values.	96.06 Parameter restore , selection Reset motor data

Menu item	Description	Corresponding parameter
Reset all parameters	Restores all editable parameter values to default values, except <ul style="list-style-type: none"> • end user texts, such as customized warnings and faults, and the drive name • control panel/PC communication settings • parameter 95.01 Supply voltage • differentiated defaults implemented by parameter 95.20 HW options word 1 and the differentiated defaults implemented by them • user lock configuration parameters 96.100...96.102 • group 49 Panel port communication parameters. 	96.06 Parameter restore , selection Clear all
Reset end user texts	Restores all end user texts to default values, including the drive name, contact info, customized fault and warning texts, PID unit and currency unit. Note: PID unit is reset only if it is user editable text, that is, parameter 40.79 Set 1 units is set to User text.	96.06 Parameter restore , selection Reset end user texts
Reset first start assistant	Resets the first start assistant so that at the next time drive is powered on the first start assistant is shown.	
Reset all to factory defaults	Restores all drive parameters and settings back to initial factory values, except <ul style="list-style-type: none"> • parameter 95.20 HW options word 1 and the differentiated defaults implemented by them. 	96.06 Parameter restore , selection All to factory defaults

I/O menu

Off	ACH480	0.0 Hz
I/O		
DI1: 0	Start/stop	▶
DI2: 0	Not used	▶
DI3: 0	Used in several places	▶
DI4: 1	Start interlock 1 high	▶
DI5: 0	Not used	▶
Back	16:02	Select

4

To go the **I/O** menu from the Home view, select **Menu > I/O**.

Use the **I/O** menu to make sure that the actual I/O wiring matches the I/O use in the control program. It answers the questions:

- What is each input being used for?
- What is the meaning of each output?

You can configure, add and remove use of inputs and outputs.

In the **I/O** menu, each row provides the following information:

- Terminal name and number
- Electrical status
- Logical meaning of the drive

Each row also provides a submenu that provides further information on the menu item and lets you make changes to the I/O connections.

The table below provides detailed information about the contents of the different submenus available in the **I/O** menu.

Menu item	Description
DI1	This submenu lists the functions that use DI1 as input.
DI2	This submenu lists the functions that use DI2 as input.
DI3	This submenu lists the functions that use DI3 as input.
DI4	This submenu lists the functions that use DI4 as input.
DI5	This submenu lists the functions that use DI5 as input.
DI6	This submenu lists the functions that use DI6 or FI as input. The connector can be used as either digital input or frequency input.
AI1	This submenu lists the functions that use AI1 as input.
AI2	This submenu lists the functions that use AI2 as input.
RO1	This submenu lists what information goes into relay output 1.
RO2	This submenu lists what information goes into relay output 2.
RO3	This submenu lists what information goes into relay output 3.
AO1	This submenu lists what information goes into AO1.
AO2	This submenu lists what information goes into AO2.
I/O extension	This submenu has the following submenus:
RO4	This submenu lists what information goes into relay output 4.

Menu item	Description
RO5	This submenu lists what information goes into relay output 5.
RO6	This submenu lists what information goes into relay output 6.
RO7	This submenu lists what information goes into relay output 7.
DO1	This submenu lists what information goes into digital output 1.

Diagnostics menu

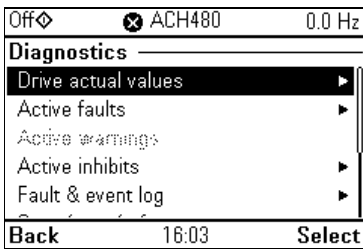

4

To go the **Diagnostics** menu from the Home view, select **Menu > Diagnostics**.

The **Diagnostics** menu provides you with diagnostic information, such as faults and warnings, and helps you to resolve potential problems. Use the menu to make sure that the drive setup is functioning correctly.

To clear the fault and event logger, select **Menu > Primary settings > Reset to defaults > Reset fault and event logs**, or set parameter [96.51 Clear fault and event logger](#) to value [Reset](#).

The table below provides detailed information about the contents of the different views available in the **Diagnostics** menu.

Menu item	Description
Drive actual values	Shows actual values: 01.01 Motor speed used , 01.06 Output frequency , 01.07 Motor current , 01.10 Motor torque , 01.11 DC voltage , 01.13 Output voltage , 01.14 Output power , 06.01 Main control word , 06.11 Main status word , 19.01 Actual operation mode , 05.01 On-time counter , 05.02 Run-time counter , 05.04 Fan on-time counter , 05.10 Control board temperature , 05.11 Inverter temperature , 35.01 Motor estimated temperature , 35.02 Measured temperature 1 , 35.03 Measured temperature 2 , 40.01 Process PID output actual , 40.02 Process PID feedback actual , 40.03 Process PID setpoint actual , 40.04 Process PID deviation actual , 40.07 Process PID operation mode .
Active faults	This view shows the currently active faults and provides instructions on how to fix and reset them.
Active warnings	This view shows the currently active warnings and provides instructions on how to fix them.
Active inhibits	This view shows up to five simultaneous active start inhibits and how to fix them.
Fault & event log	This view lists the faults, warnings and other events that have occurred in the drive. Press Details to see, for each stored fault, the fault code, time and values of nine parameters (actual signals and status words) stored at the time of the fault. The values of the parameters for the latest fault are in parameters 05.80...05.89 .

Menu item	Description
Start, stop, reference summary	This view shows where the drive is currently taking its start and stop commands and reference. The view is updated in real time. If the drive is not starting or stopping as expected, or runs at an undesired speed, use this view to find out where the control comes from.
Limit status	This view describes any limits currently affecting operation. If the drive is running at undesired speed, use this view to find out if any limitations are active.
Load profile	This view shows results of the load analyzer. Amplitude loggers show load distribution diagrams: how much of the drive's running time was spent at each load level. The peak value logger lists maximum momentary load levels.
Communication status	This view provides status information and sent and received data from fieldbus for troubleshooting.
Motor summary	This view provides motor information: nominal values, control mode and whether ID run has been completed.

System info menu

Off	ACH480	0.0 Hz
System info		
Drive		
Control panel		
QR code		
Back	16:03	Select

4

To go the **System info** menu from the Home view, select **Menu > System info**.

The **System info** menu shows information of the drive and the control panel. In problem situations you can also request the drive to generate a QR code for ABB service, so they can better assist you.

The table below provides detailed information about the available setting items in the **System info** menu.

Menu item	Description	Corresponding parameter
Drive	Panel bus id: Serial number: Manufacturing date: Product name: Product type: FW version: LP version: Backup version: Note: If no data was loaded in the factory, some information (for example, serial number) will not appear in the drive information.	<i>07.05 Firmware version</i> <i>07.07 Loading package version</i>
Control panel	Product type: HW version: FW version: Serial number: Manufacturing date:	
QR code	The drive generates a QR code (or a series of QR codes), which contains drive identification data, information on the latest events, and values of status and counter parameters. You can read the QR code with a mobile device containing the ABB application, which then sends the QR code to ABB for analysis.	

Energy efficiency menu

Off	ACH480	0.0 Hz
Energy efficiency		
Total energy saved	0.0 kWh	▶
Used, last hour	0.00 kWh	▶
Used, last day	0.00 kWh	▶
Used, last month	0.00 kWh	▶
Used, total	0.0 kWh	▶
Back	16:03	Select

To go the **Energy efficiency** menu from the Home view, select **Menu > Energy efficiency**.

Use the **Energy efficiency** menu to view energy and power values, view and change settings of the load analyzer (= amplitude and peak value loggers), for example, view graphical representation of the two amplitude loggers, as well as and change energy calculation settings.

See also sections [Energy efficiency](#) on page 206 and [Load analyzer](#) on page 207.

The table below provides detailed information about the available setting items in the **Energy efficiency** menu.

Menu item	Description	Corresponding parameter
Total energy saved	Energy saved in kWh compared to direct-on-line motor connection. Corresponding money saved. Corresponding CO ₂ saved.	45.04 Saved energy 45.07 Saved amount 45.10 Total saved CO₂
Used, last hour	Energy used during the last hour (the last 60 minutes). Average power during the last hour (value of 45.26 divided by one hour).	45.26 Hourly total energy (resettable)
Used, last day	Energy used during the previous day (between midnight of the previous day and midnight of the present day). Average power during the last day (value of 45.30 divided by 24 hours).	45.30 Last day total energy
Used, last month	Energy used during the previous month (between midnight of the first day or the previous month and midnight of the first day of the present month). Average power during the last month (value of 45.30 divided by 732 hours).	45.35 Last month total energy
Used, total	All-time total used energy Resettable total used energy	01.54 Cumulative inverter energy 01.58 Cumulative inverter energy (resettable)

Menu item	Description	Corresponding parameter
Peak power	Hourly peak power (during the last 60 minutes) Time of the hourly peak power Daily peak power (during the previous day) Time of the daily peak power Monthly peak power (during the previous month) Time of the monthly peak power Date of the monthly peak power All-time peak power Time of all time peak power Date of all time peak power	45.24 Hourly peak power value 45.25 Hourly peak power time 45.27 Daily peak power value (resettable) 45.28 Daily peak power time 45.31 Monthly peak power value (resettable) 45.33 Monthly peak power time 45.32 Monthly peak power date 45.36 Lifetime peak power value 45.38 Lifetime peak power time 45.37 Lifetime peak power time
Load profile	Motor current logger (graphical representation) Load profile logger (graphical representation) These loggers show load distribution diagrams: how much of the drive's running time was spent at each load level. Load profile configuration Peak value logger The peak value logger lists maximum momentary load levels.	36.06 AL2 signal source 36.07 AL2 signal scaling 36.09 Reset loggers 36.01 PVL signal source 36.02 PVL filter time 36.10 PVL peak value 36.11 PVL peak date 36.12 PVL peak time 36.13 PVL current at peak 36.14 PVL DC voltage at peak 36.15 PVL speed at peak 36.16 PVL reset date 36.17 PVL reset time
Calculation settings	Energy optimizer Energy tariff 1 Energy tariff 2 Tariff selection CO ₂ conversion Comparison power Reset saved energy counters Reset total used counter	45.11 Energy optimizer (Disable or Enable) 45.12 Energy tariff 1 45.13 Energy tariff 2 45.14 Tariff selection 45.18 CO₂ conversion factor 45.19 Comparison power 45.21 Energy calculations reset Enter 0 to 01.58 Inverter kWh counter (resettable)

Backups menu

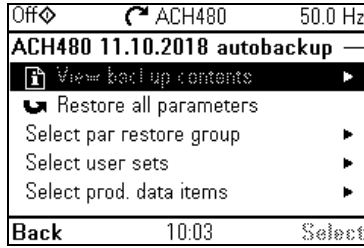
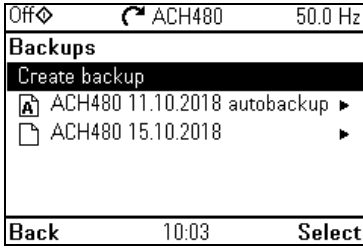



To go to the **Backups** menu from the Home view, select **Backups**.

For backups and restores, see section [Backup and restore](#) on page 213.

4

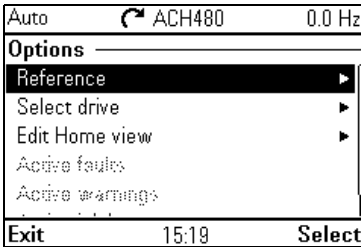
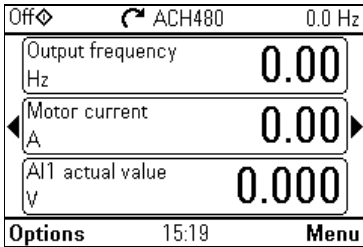
Options menu



To go to the **Options** menu, press the **Options** softkey () in any of the Home view displays. The table below provides information about the different options available in the **Options** menu.

Menu item	Description	Description
Reference	You can change the reference, which is visible on the top right corner of the panel displays.	
Direction change	Alters the sign of active reference between positive and negative. Absolute value of reference is not changed.	
Select drive	You can select a drive that you want to monitor or control from the list of drives showing the drives connected on the panel bus. You can also clear the list of drives.	

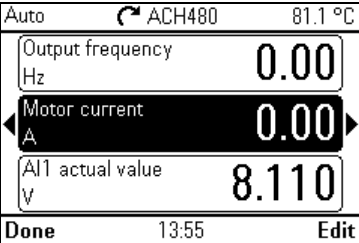
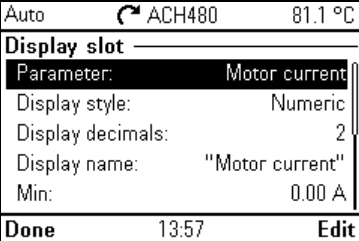
Menu item	Description	Description
Edit Home view	<p>You can edit the Home view displays. Scroll with the arrow keys (◀) and (▶) to the Home view you want to edit. Select the display slot, that is, which of the current parameter(s) you want to edit (Home views show one to three parameters). Edit the parameter and how you want to display it.</p>  	
Active faults	Shows the active faults.	
Active warnings	Shows the active warnings.	
Active inhibits	Shows the active inhibits.	

5

Default I/O configuration

5

Contents of this chapter

This chapter describes the intended use, operation and default control connections of the application.

Selecting default configurations

You select default configurations in the **Primary settings** menu.

To get to the **Primary settings** menu from the Home view, first select **Menu** to go the **Main** menu, and then select **Primary settings**. Select **Start, stop, reference**, and **How do you control?** then shows the default configurations (Direct control via I/O means the HVAC default configuration.)

Off	ACH480	0.0 Hz
Output frequency	0.00	Hz
Motor current	0.00	A
All actual value	0.000	V
Options	16:00	Menu

Off	ACH480	0.0 Hz
Main menu		
Primary settings		
I/O		
Diagnostics		
Exit	16:00	Select

Off	ACH480	0.0 Hz
Primary settings		
HVAC quick setup		▶
Start, stop, reference		▶
Motor		▶
Ramps		▶
Limits		▶
Back	16:00	Select

Off	ACH480	0.0 Hz
Start, stop, reference		
Basic operation setup		▶
Basic control setup		▶
Auto control selection:	Primary only	
Primary auto control location		▶
Interlocks/permissives		▶
Back	16:00	Select

HVAC default

Off	ACH480	0.0 Hz
How do you control?		
Press [?] for help.		
Direct control via I/O		
PID control, single motor		
Back	16:00	Next

This is the default configuration for HVAC (factory default). The HVAC default direct I/O control is used, for example, for typical I/O controlled BMS applications.

This configuration uses a direct speed reference in the Auto mode, with speed reference connected to analog input 1 (AI1). The start command is given with digital input 1 (DI1).

In the Hand/Off mode, the speed reference and start command are given through the control panel (operator keypad).

Note: You select default configurations in the **Primary settings** menu, not with parameter *96.04 Macro select*. This parameter is only used for Drive customizer support.

Off	ACH480	0.0 Hz
How do you control?		
Press [?] for help.		
Direct control via I/O		
PID control, single motor		
Back	16:00	Next

← HVAC default

Input signals

- Analog frequency/speed reference (AI1)
- Start/stop selection (DI1)
- Constant speed/frequency selection (DI3)
- Start interlock 1 (DI4)

Output signals

- Analog output AO1: Output frequency
- Analog output AO2: Motor current
- Relay output 1: Damper control
- Relay output 2: Running
- Relay output 3: Fault (-1)

Default control connections for the HVAC default

For the standard I/O configuration (drive base unit and RIIO-01 I/O module). The fixed terminals of the base unit are marked in the table:

Terminal	Description		Fixed	
Reference voltage and analog I/O				
	SCR	Signal cable shield (screen)		
	AI1	Output frequency/speed reference: 0...10 V		
	AGND	Analog input circuit common		
	+10 V	Reference voltage 10 V DC		
	AI2	Actual feedback: 0...20 mA		
	AGND	Analog input circuit common		
	AO1	Output frequency: 0...20 mA		
	AO2	Output current: 0...20 mA		
AGND	Analog output circuit common			
Aux. voltage output and programmable digital inputs				
	+24 V	Aux. voltage output +24 V DC, max. 200 mA	X	
	DGND	Aux. voltage output common	X	
	DCOM	Digital input common for all	X	
	DI1	Stop (0)/Start (1)	X	
	DI2	Not configured	X	
	DI3	Constant frequency/speed selection		
	DI4	Start interlock 1 (1 = allow start)		
	DI5	Not configured		
	DI6	Not configured		
Relay outputs				
Damper actuator	RO1C	Damper control 250 V AC/30 V DC, 2 A	Energize damper	X
	RO1A		RO1C connected to	X
	RO1B		RO1B	X
Run status	RO2C	Running 250 V AC/30 V DC, 2 A	Running	
	RO2A		RO2C connected to	
	RO2B		RO2B	
Fault status	RO3C	Fault (-1) 250 V AC/30 V DC, 2 A	Fault condition	
	RO3A		RO3C connected to	
	RO3B		RO3A	
Embedded fieldbus				
	B+	Embedded fieldbus, EFB (EIA-485)		
	A-			
	DGND			
	TERM&BIA	Termination switch and bias resistor switch		
Safe torque off				
	SGND	Safe torque off. Factory connection. Both circuits must be closed for the drive to start.		X
	IN1			X
	IN2			X
	OUT1			X
	+24V	Auxiliary voltage output. The alternative terminals have the same supply as the base unit.		
	DGND			
	DCOM			

Terminal sizes: 0.14...1.5 mm² (26...16 AWG)

Tightening torques: 0.5...0.6 N·m (4.4...5.3 lbf·in)

PID control, single motor

This configuration offers quick setup of PID control for keeping flow or pressure constant. It requires a measurement feedback from the process, and the feedback signal must be connected to the analog input 2 (AI2). You can specify the setpoint to come from analog input 1 (AI1) or from the control panel (operator keypad) in the Auto mode, or you can set a constant setpoint.

In the Hand/Off mode, the speed reference and start command are given through the control panel. In the Hand mode the speed reference is the direct speed reference and a PID setpoint value.

After you have commissioned the drive to use the PID control operation, single motor, you can adjust Process PI(D) in the **PID control** submenu of the **Primary settings** menu (see page 77).

Note: You select default configurations in the **Primary settings** menu, not with parameter 96.04 *Macro select*. This parameter is only used for Drive customizer support

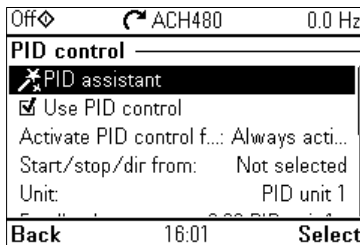
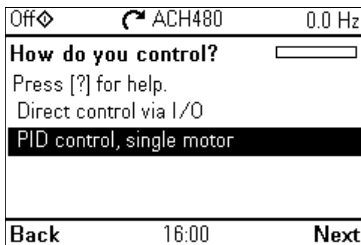

5

Input signals

- Setpoint selected from: control panel setpoint/ constant setpoint / analog input (AI1)
- PID feedback (AI2)
- Start/stop selection (DI1)
- Constant speed/frequency selection (DI3)
- Start interlock 1 (DI4)

Output signals

- Analog output AO1: Output frequency
- Analog output AO2: Motor current
- Relay output 1: Damper control
- Relay output 2: Running
- Relay output 3: Fault (-1)

Default control connections for the PID control, single motor

For the standard I/O configuration (drive base unit and RIIO-01 I/O module). The fixed terminals of the base unit are marked in the table:

Terminal	Description		Fixed	
Reference voltage and analog I/O				
	SCR	Signal cable shield (screen)		
	AI1	Panel setpoint ref/ Constant setpoint: 0...10 V		
	AGND	Analog input circuit common		
	+10 V	Reference voltage 10 V DC		
	AI2	PID feedback: 0...20 mA		
	AGND	Analog input circuit common		
	AO1	Output frequency: 0...20 mA		
	AO2	Output current: 0...20 mA		
AGND	Analog output circuit common			
Aux. voltage output and programmable digital inputs				
	+24 V	Aux. voltage output +24 V DC, max. 200 mA	X	
	DGND	Aux. voltage output common	X	
	DCOM	Digital input common for all	X	
	DI1	Stop (0)/Start (1)	X	
	DI2	Not configured	X	
	DI3	Constant frequency/speed selection		
	DI4	Start interlock 1 (1 = allow start)		
	DI5	Not configured		
	DI6	Not configured		
Relay outputs				
Damper actuator	RO1C	Damper control 250 V AC/30 V DC, 2 A	Energize damper	X
	RO1A		RO1C connected to	X
	RO1B		RO1B	X
Run status	RO2C	Running 250 V AC/30 V DC, 2 A	Running	
	RO2A		RO2C connected to	
	RO2B		RO2B	
Fault status	RO3C	Fault (-1) 250 V AC/30 V DC, 2 A	Fault condition	
	RO3A		25 connected to 26	
	RO3B			
Embedded fieldbus				
	B+	Embedded fieldbus, EFB (EIA-485)		
	A-			
	DGND			
	TERM&BIA	Termination switch and bias resistor switch		
Safe torque off				
	SGND	Safe torque off. Factory connection. Both circuits must be closed for the drive to start.		X
	IN1			X
	IN2			X
	OUT1			X
	+24V	Auxiliary voltage output. The alternative terminals have the same supply as the base unit.		
	DGND			
	DCOM			

Terminal sizes: 0.14...1.5 mm² (26...16 AWG)

Tightening torques: 0.5...0.6 N·m (4.4...5.3 lbf·in)

6

Program features

What this chapter contains

This chapter describes some of the more important functions within the control program, how to use them and how to program them to operate. It also explains the control locations and operating modes.

6

Local control vs. external control

The ACH480 has two main control locations: external and local. In local control there are two different modes: Off and Hand.

In the Off mode, the drive is stopped. In the Hand mode, the drive is running. The initial reference in the Hand mode is copied from the drive reference.

The following diagram shows the state transitions when you press the Hand, Off or Auto button:

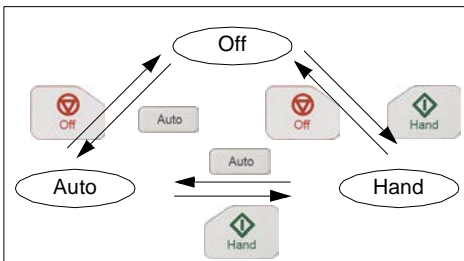

The control location can also be selected in the PC tool.

Note: If fault [7081 Control panel loss](#) is active and the drive is powered down, the mode changes to Auto when power is reapplied.

Note: Override function overrides the actual running mode.

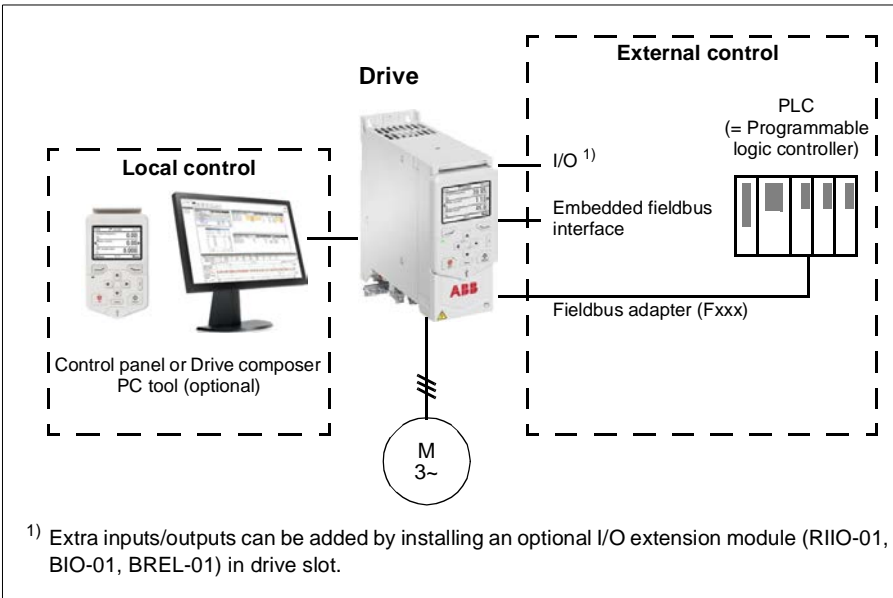

Local control

When the drive is in local control, control commands are given through

- the control panel keypad
- a PC equipped with Drive composer PC tool.

Speed control mode is available in vector motor control mode; frequency mode is available when scalar motor control mode is used.

Local control is mainly used during commissioning and maintenance. The control panel always overrides the external control signal sources when used in local control. Changing the control location to local can be prevented by parameter [19.18 HAND/OFF disable source](#).

The user can select with parameter [49.05 Communication loss action](#) how the drive reacts to a control panel or PC tool communication loss. (The parameter has no effect in external control.)

External control

When the drive is in external control, control commands are given through

- the I/O terminals (digital and analog inputs), or optional I/O extension modules
- the fieldbus interface (via the embedded fieldbus interface or an optional fieldbus adapter module).

Two external control locations, EXT1 and EXT2, are available. The user can select the sources of the start and stop commands separately for each location by setting parameters [20.01 Ext1 commands...](#)[20.10 Ext2 in3 source](#). The operating mode can be selected separately for each location, which enables quick switching between different operating modes, for example, speed and process PID control. Selection between EXT1 and EXT2 is done via any binary source such as a digital input or fieldbus control word (parameter [19.11 Ext1/Ext2 selection](#)). The source of reference is selectable for each operating mode separately.

Communication fail functionality

The communication fail functionality ensures continuous process without interruptions. If there is a communication loss, the drive automatically changes the control location from EXT1 to EXT2. This enables process to be controlled, for example, with the drive PID controller. When the original control location recovers, the drive automatically switches control back to the communication network (EXT1).

Block diagram: EXT1/EXT2 selection for speed control

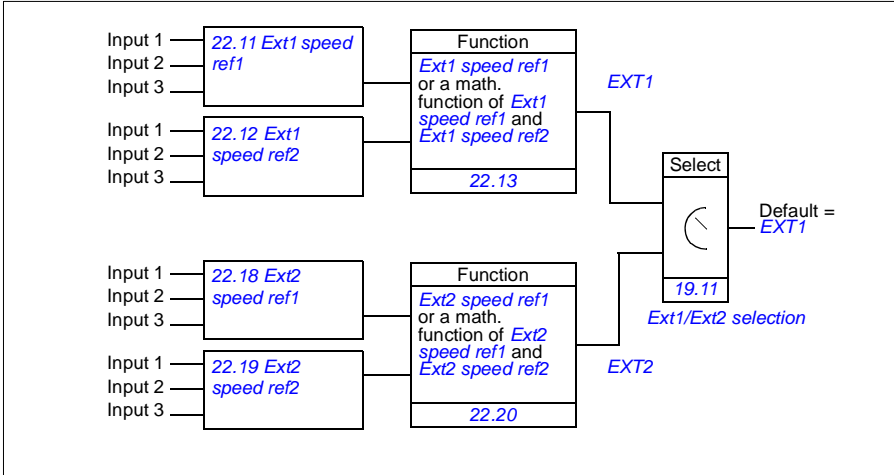

6

Block diagram: EXT1/EXT2 selection for frequency control

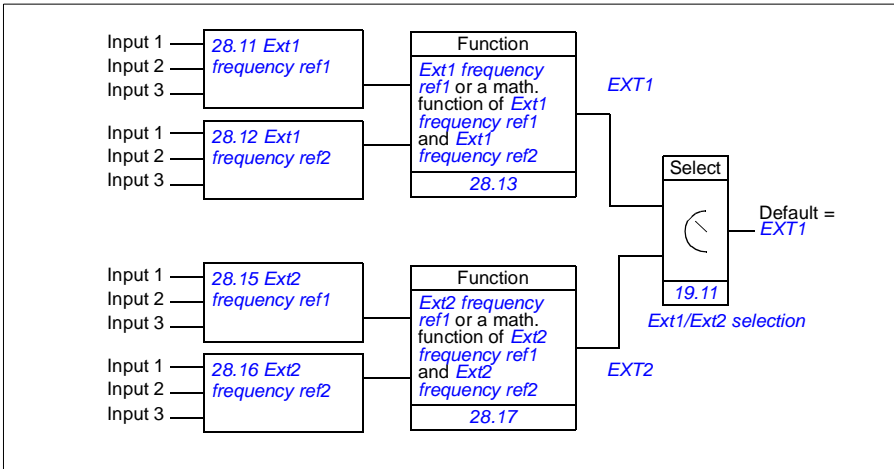

Settings

- Parameters [19.11 Ext1/Ext2 selection](#) (page 419); [20.01 Ext1 commands...20.10 Ext2 in3 source](#) (page 421).
- Parameters [22.11 Ext1 speed ref1...22.20 Ext2 speed function](#) (page 440)
- Parameters [28.11 Ext1 frequency ref1...28.17 Ext2 frequency function](#) (page 458).

Operating modes of the drive

The drive can operate in several operating modes with different types of reference. The mode is selectable for each control location (Local, EXT1 and EXT2) in parameter group [19 Operation mode](#). An overview of the different reference types and control chains is shown below.

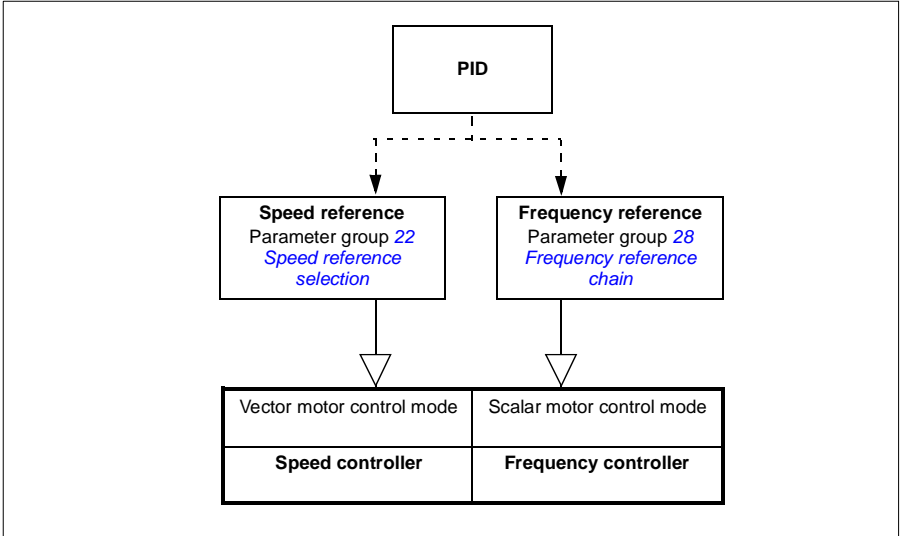

Drive configuration and programming

The drive control program performs the main control functions, including speed and frequency control, drive logic (start/stop), I/O, feedback, communication and protection functions. Control program functions are configured and programmed with parameters.

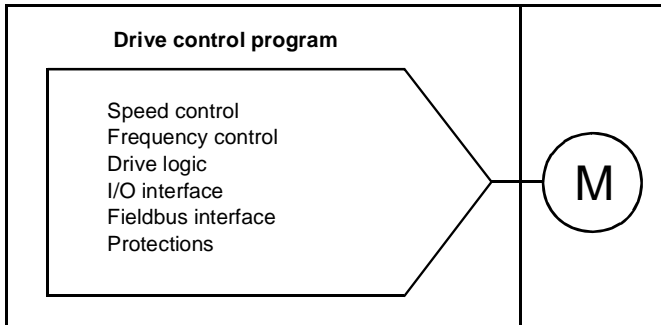

6

■ Configuring via default configurations

Default configurations are predefined I/O configurations. See chapter [Default I/O configuration](#) (page 95).

■ Configuring via menus

The drive can be configured using the **Primary settings** and other menus on the control panel. They effectively change parameters but they guide you with assistants, and you do not have to know the parameter names and numbers. See chapter [Settings, I/O and diagnostics on the control panel](#) (page 53).

■ Configuring via parameters

Parameters configure all of the standard drive operations and can be set via

- the control panel, as described in chapter [Control panel](#) (see page 41)
- the Drive composer PC tool, as described in *Drive composer user's manual* (3AUA0000094606 [English]), or
- the fieldbus interface, as described in chapters [Modbus RTU control through the embedded fieldbus interface \(EFB\)](#) (see page 249) and [Fieldbus control through a fieldbus adapter](#) (see page 323).

All parameter settings are stored automatically to the permanent memory of the drive. However, if an external +24 V DC power supply is used for the drive control unit, it is highly recommended to force a save by using parameter [96.07 Parameter save manually](#) before powering down the control unit after any parameter changes have been made.

If necessary, the default parameter values can be restored by parameter [96.06 Parameter restore](#).

■ Adaptive programming

Conventionally, the user can control the operation of the drive by parameters. However, the standard parameters have a fixed set of choices or a setting range. To further customize the operation of the drive, an adaptive program can be constructed out of a set of function blocks.

The Drive composer PC tool (available separately) has an Adaptive programming feature with a graphical user interface for building the custom program. The function blocks include the usual arithmetic and logical functions, as well as, for example, selection, comparison and timer blocks.

The physical inputs, drive status information, actual values, constants and parameters can be used as the input for the program. The output of the program can be used, for example, as a start signal, external event or reference, or connected to the drive outputs. See the table below for a listing of the available inputs and outputs.

If you connect the output of the adaptive program to a selection parameter that is a pointer parameter, the selection parameter will be write-protected.

Example:

If parameter [31.01 External event 1 source](#) is connected to an adaptive programming block output, the parameter value is shown as Adaptive program on a control panel or PC tool. The parameter is write-protected (= the selection cannot be changed).

The status of the adaptive program is shown by parameter [07.30 Adaptive program status](#). The adaptive program can be disabled by [96.70 Disable adaptive program](#).

For more information, see the *Adaptive programming application guide* (3AXD5000028574 [English]).

Inputs available to the adaptive program	
Input	Source
I/O	
DI1	10.02 DI delayed status , bit 0
DI2	10.02 DI delayed status , bit 1
DI3	10.02 DI delayed status , bit 2
DI4	10.02 DI delayed status , bit 3
DI5	10.02 DI delayed status , bit 4
DI6	10.02 DI delayed status , bit 5
AI1	12.11 AI1 actual value
AI2	12.21 AI2 actual value
Actual signals	
Motor speed	01.01 Motor speed used
Output frequency	01.06 Output frequency
Motor current	01.07 Motor current
Motor torque	01.10 Motor torque
Motor shaft power	01.17 Motor shaft power

Inputs available to the adaptive program	
<i>Input</i>	<i>Source</i>
<i>Status</i>	
Enabled	06.16 Drive status word 1, bit 0
Inhibited	06.16 Drive status word 1, bit 1
Ready to start	06.16 Drive status word 1, bit 3
Tripped	06.11 Main status word, bit 3
At setpoint	06.11 Main status word, bit 8
Limiting	06.16 Drive status word 1, bit 7
Ext1 active	06.16 Drive status word 1, bit 10
Ext2 active	06.16 Drive status word 1, bit 11
<i>Data storage</i>	
Data storage 1 real32	47.01 Data storage 1 real32
Data storage 2 real32	47.02 Data storage 2 real32
Data storage 3 real32	47.03 Data storage 3 real32
Data storage 4 real32	47.04 Data storage 4 real32

Outputs available to the adaptive program	
<i>Output</i>	<i>Target</i>
<i>I/O</i>	
RO1	10.24 RO1 source
RO2	10.27 RO2 source
RO3	10.30 RO3 source
AO1	13.12 AO1 source
AO2	13.22 AO2 source
<i>Start control</i>	
Ext1/Ext2 selection	19.11 Ext1/Ext2 selection
Ext1 in1 cmd	20.03 Ext1 in1 source
Ext1 in2 cmd	20.04 Ext1 in2 source
Ext1 in3 cmd	20.05 Ext1 in3 source
Ext2 in1 cmd	20.08 Ext2 in1 source
Ext2 in2 cmd	20.09 Ext2 in2 source
Ext2 in3 cmd	20.10 Ext2 in3 source
Fault reset	31.11 Fault reset selection
<i>Speed control</i>	
Ext1 speed reference	22.11 Ext1 speed ref1
Speed proportional gain	25.02 Speed proportional gain
Speed integration time	25.03 Speed integration time
Acceleration time 1	23.12 Acceleration time 1
Deceleration time 1	23.13 Deceleration time 1
<i>Frequency control</i>	
Ext1 frequency reference	28.11 Ext1 frequency ref1
<i>Limit function</i>	
Minimum torque 2	30.21 Min torque 2 source
Maximum torque 2	30.22 Max torque 2 source
<i>Events</i>	
External event 1	31.01 External event 1 source
External event 2	31.03 External event 2 source
External event 3	31.05 External event 3 source
External event 4	31.07 External event 4 source

Outputs available to the adaptive program	
<i>Output</i>	<i>Target</i>
External event 5	31.09 External event 5 source
<i>Data Storage</i>	
Data storage 1 real32	47.01 Data storage 1 real32
Data storage 2 real32	47.02 Data storage 2 real32
Data storage 3 real32	47.03 Data storage 3 real32
Data storage 4 real32	47.04 Data storage 4 real32
<i>Process PID</i>	
Set 1 setpoint 1	40.16 Set 1 setpoint 1 source
Set 1 setpoint 2	40.17 Set 1 setpoint 2 source
Set 1 feedback 1	40.08 Set 1 feedback 1 source
Set 1 feedback 2	40.09 Set 1 feedback 2 source
Set 1 gain	40.32 Set 1 gain
Set 1 integration time	40.33 Set 1 integration time
Set 1 tracking mode	40.49 Set 1 tracking mode
Set 1 track reference	40.50 Set 1 tracking ref selection

Adaptive program fault and aux code formats

The format of the aux code:

Bits 24-31: State number	Bits 16-23: block number	Bits 0-15: error code
--------------------------	--------------------------	-----------------------

If the state number is zero but the block number has a value, the fault is related to a function block in the base program. If both state number and block number are zero, the fault is a generic fault that is not related to a specific block.

See fault [64A6 Adaptive program](#) on page [239](#).

Sequence program

An adaptive program can contain base program and sequence program parts. Base program is run continuously when adaptive program is in running mode. The functionality of the base program is programmed using function blocks and system inputs and outputs.

Sequence program is a state machine. This means that only one state of the sequence program is run at a time. You can create a sequence program by adding states and programming the state programs using the same program elements as in the base program. You can program state transitions by adding state transition outputs to the state programs. The state transition rules are programmed using function blocks.

The number of the active state of the sequence program is shown by parameter [07.31 AP sequence state](#).

Control interfaces

■ Programmable analog inputs

The control unit with standard I/O extension RIIO-01 module has two programmable analog inputs. Each of the inputs can be independently set as a voltage (0/2...10 V) or current (0/4...20 mA) input with parameters. Each input can be filtered, inverted and scaled.

Settings

- Parameter group [12 Standard AI](#) (page [398](#)).

■ Programmable analog outputs

The control unit with standard I/O extension RIIO-01 module has two current (0...20 mA) analog outputs. Analog output 1 can be set as a voltage (0/2...10 V) or current (0/4...20 mA) output with a parameter. Analog output 2 always uses current. Each output can be filtered, inverted and scaled.

Settings

- Parameter group [13 Standard AO](#) (page [404](#)).

■ Programmable digital inputs and outputs

The control unit with standard I/O extension RIIO-01 module has six digital inputs. Digital input DI5 can be used as a frequency input.

Settings

- Parameter groups [10 Standard DI, RO](#) (page [379](#)) and [11 Standard DIO, FI, FO](#) (page [390](#)).

■ Programmable frequency input and output

Digital input DI5 can be configured as a frequency input.

Settings

- Parameter groups [10 Standard DI, RO](#) (page [379](#)) and [11 Standard DIO, FI, FO](#) (page [390](#)).

■ Programmable relay outputs

The control unit with standard I/O extension RIIO-01 module has three relay outputs. The signal to be indicated by the outputs can be selected by parameters.

Settings

- Parameter group [10 Standard DI, RO](#) (page [379](#)).

■ Programmable I/O extensions

Inputs and outputs can be added to the base unit either by using a standard I/O extension RIIO-01 module or an optional BIO-01 reduced I/O extension module or optional BREL-01 relay extension module. The I/O extension module is mounted on option slot of the control unit.

The table below shows the number of I/O on the base unit, on the standard I/O extension RIIO-01 module as well as optional BIO-01 module with reduced number of I/Os and optional BREL-01 relay extension module. The base unit with the standard I/O extension RIIO-01 module is called the standard unit.

Location	Digital inputs (DI)	Digital outputs (DO)	Digital I/Os (DIO)	Analog inputs (AI)	Analog outputs (AO)	Relay outputs (RO)
Base unit	2	-	-	-	-	1
RIIO-01	4	-	-	2	2	2
BIO-01 ¹⁾	Max. 3	Max. 1	-	1	Max. 1	-
BREL-01	-	-	-	-	-	4

1) The new (2021 model) BIO-01 module has two DIP switches to specify the port use. One switch changes the S1 port from Digital Output (DO1) to Analog Output (AO1) and the second switch changes the S2 port from Digital Input (DI3) to Digital Output (DO1). Note that the new BIO-01 has maximum one Digital Output. Having switches in positions that both ports configurable with DIP switches would be Digital Outputs (DO1) is not a supported combination. Earlier versions have 3 Digital Inputs, 1 Digital Output and 1 Analog Inputs. Both types of BIO-01 modules are supported by the firmware.

Note: The configuration parameter group contains parameters that display the values of the inputs on the extension module. These parameters are the only way of utilizing the inputs on an I/O extension module as signal sources.

Settings

- Parameter groups [10 Standard DI, RO](#) (page 379), [11 Standard DIO, FI, FO](#) (page 390) and [15 I/O extension module](#) (page 410).

■ Fieldbus control

The drive can be connected to several different automation systems through its fieldbus interfaces. See chapters [Modbus RTU control through the embedded fieldbus interface \(EFB\)](#) (page 249) and [Fieldbus control through a fieldbus adapter](#) (page 323).

Settings

- Parameter groups [50 Fieldbus adapter \(FBA\)](#) (page 552), [51 FBA A settings](#) (page 556), [52 FBA A data in](#) (page 557), and [53 FBA A data out](#) (page 558) and [58 Embedded fieldbus](#) (page 558).

Pump and fan control features

Note: ABB recommends reading the pump manufacturer's instructions for optimal performance.

■ Intelligent pump control (IPC)

Multipump/fan systems consist of several pumps or fans, each connected to a separate drive. This arrangement enables a high flexibility in load sharing, balancing the run time between the pumps or fans and keeping each pump or fan running optimally. If the active pumps or fans cannot meet the demand, the system automatically starts pumps or fans one by one. Similarly, if the demand decreases, the system automatically stops pumps or fans one by one in order to keep the remaining pumps or fans running at optimal efficiency.

The IPC system at first increases the first, or lead, pump's speed. If this is not sufficient, the IPC will start lag pump(s) in sequence to meet the process demand. While starting a new pump, the speed of the already running pumps is reduced to allow smooth flow of liquid.

6

The order of the pumps or fans used can be defined to balance the run time better (pumps or fans that have run the least, start first) or can be set by the efficiency class of each pump or fan (for example, pumps or fans with high efficiency are primarily used).

Note: Node numbers of the drives must be sequential starting from 1.

Multipump/fan systems achieve high levels of up-time and reliability, if one pump or fan fails or requires maintenance, other pumps or fans can take over the operation. Efficiency, continuous operation and easy maintenance are reasons why multipump/fan systems can be found in a variety of different applications in the HVAC and W/WW industries.

In the IPC system one drive at a time acts as a master and you can use up to seven follower drives. With a moving master strategy each of the drives in the team can be selected to be eligible as master. The master drive controls the whole multi-pump-system and has the following tasks:

- activating and deactivating the follower drives
- regulating the systems speed with its internal PID loop control according to an internal set-point
- processing the I/O signals (set-point and feedback signals).

The IPC system can be enabled using primary settings or parameter [76.21 Multipump configuration](#).

In an IPC system, the drives communicates through inverter-to-inverter link on embedded fieldbus. Each drive in the system requires a run command for the IPC logic to function and use the drive if needed. By default in Auto mode this is done by using DI1. Note that settings for setpoint and actual value are not copied through the

inverter-to-inverter link. These signals must be externally sent to each drive to ensure a redundant system.

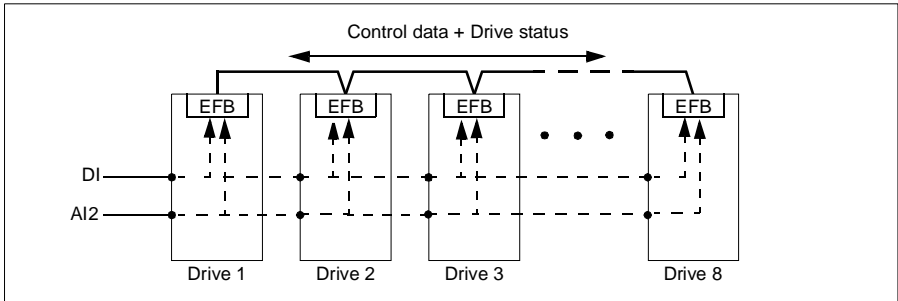

Starting the IPC system

The IPC system starts operation when the drive receives a start command from external control location EXT2 (parameter [20.08 Ext2 in1 source](#)). The start command indicates that the pump is available to the IPC system. However, the system sends the actual start command to the follower drives based on the required output of the system.

If all drives in the system receive a start command simultaneously, then, by default, the drive with the least run time and that is ready to run, will start as the master drive. See parameter [76.22 Multipump node number](#). For optimal energy operation, you can combine the PID sleep function with IPC system. For information on PID sleep function, see [Sleep and boost functions for process PID control](#) (page 160).

Note: The IPC system is not active on external control location EXT1.

Smooth pump transitions

The figure below shows the smooth pump transitions with different ramp times.

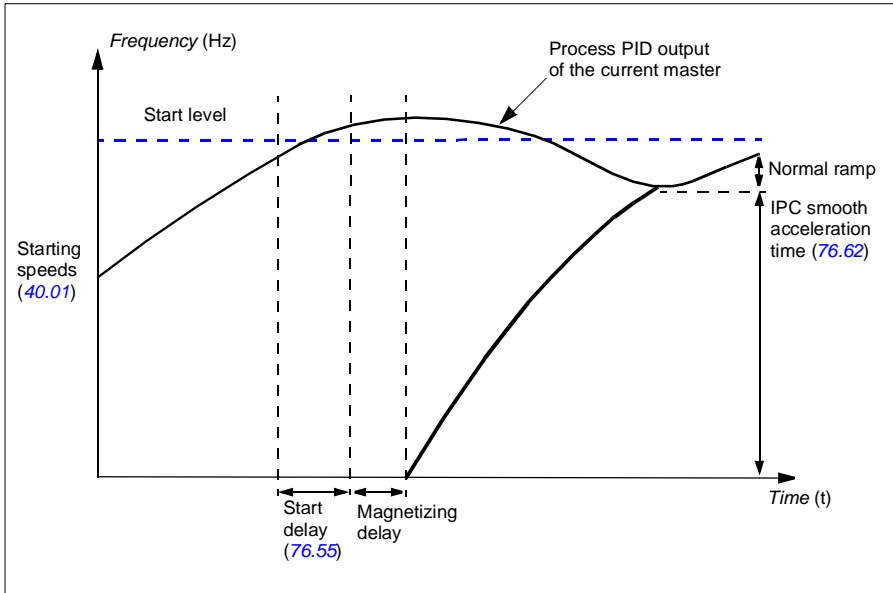

The timing diagram of smooth pump transitions shows the pump starting steps. In this case, the process PID output of the current master has exceeded the start level (76.30...76.32).

1. The IPC system starts a new pump after the start delay time (76.55 Start delay) is elapsed.
After the motor is magnetized and starts rotating, the new pump then accelerates to the master speed along IPC smooth ramp time defined with parameter 76.62 IPC smooth acceleration time.
2. When a new pump is accelerating, the other pumps decelerate to maintain the stable output of the system, shown as Normal ramp in the diagram.
3. After the new pump reaches the speed of the current master pump, the new pump becomes the new master.
4. The new master and all the remaining pumps will start to follow the master drive speed defined by the process PID of the master drive.

Pump priorities

The pumps are prioritized based on energy efficiency and process demand.

- **High** – more energy efficient pumps
- **Normal** – less energy efficient pumps
- **Low** – pumps which do not run unless process demands

You can select the pump priority with parameter [76.77 Pump priority](#). The IPC system prefers high priority pumps over normal and low priority pumps. You can limit the time a pump is not run with parameter [76.76 Max stationary time](#), so that even the low priority pumps are exercised often enough to keep them in operational condition. Pressure-maintenance pumps (Jockey pumps) should be controlled separately to provide the necessary control.

Master-follower change principle

1. The master controls the process until the follower has reached the setpoint. There is no master follower change if the setpoint is not achieved.
2. Max stationary time is followed (if that is set).
This has high priority because it makes sure the pump is kept in good condition and it just does not stay inoperative.
3. After checking the max stationary time, the pump priorities are followed.
This makes sure the pumps with high priority are operated the most often.
4. If none of the above conditions are set, the system tries to balance the operation time between all the pumps.

Automatic parameter synchronization

Automatic parameter synchronization feature reduces the number of configuration steps in the IPC system.

The synchronized parameter groups are selected with parameter [76.102 IPC synchronization settings](#). In addition, there are some drive dependent parameters that are not synchronized, like [76.22 Multipump node number](#). To enable synchronization of a parameter group between two or more drives, the group synchronization must be enabled in all the drives.

The synchronization process uses two mechanisms to make sure that the parameter groups are synchronized. When a parameter value is changed in a drive, it broadcasts the changed parameter value to inverter-to-inverter (I2I) link. From the inverter-to-inverter (I2I) link, all the drives that have the synchronization enabled, reads the value and set their own parameter value.

In addition, the drive periodically broadcast the group **CRC** (cyclic redundancy check) to the inverter-to-inverter (I2I) link along with the time stamp of the last edit time of the group. From this information, the drives can conclude if the group is synchronized and which drive has the latest parameter values. If there is a **CRC** mismatch, the

drives request the parameter values from the parameter group and from the drive with the latest values.

You can monitor changes in the drive configuration with Parameter checksum calculation, see section [Parameter checksum calculation](#) on page 214.

■ IPC master autochange

An IPC system consists of several pumps (drives) but has only one active master pump. The master pump controls the IPC system by starting and stopping the follower pumps when necessary, and by sending the reference to all follower pumps over the IPC network.

Usually the pump that was started first is the first active master. If multiple drives are started at the same time, the pump with the smallest node number will be the active master. The autochange feature is used to transfer this master status on the IPC system to the next pump in the specified sequence. This way the autochange will also affect the start order of the follower pumps.

Note: Node numbers of the drives must be sequential starting from 1.

6

Autochange can be triggered in several ways. The trigger is selected with parameter [76.70 PFC Autochange](#). These triggers include digital inputs, timed functions, fixed intervals of time, when all pumps are stopped or whenever wear logic determines it is time to change the master. Even when this trigger is active, PID feedback must be at the set point and pump speed must be below parameter [76.73 Autochange level](#) before autochange can occur.

If autochange is not possible because of the above reasons, the system will remember the request and will perform autochange when all the requirements have been fulfilled.

Autochange can be done using two possible sequences: either with even wear or fixed sequence.

For IPC, the default value for parameter [76.70 PFC Autochange](#) is *Even wear*. If the parameter value is *Not selected* or *Selected*, the system will automatically select *Even wear*.

If the [76.70 PFC Autochange](#) value is other than *Not selected*, *Selected* or *Even wear*, the fixed sequence will be used. The fixed interval time can be specified with parameter [76.71 PFC Autochange interval](#).

Even wear is the default value after selecting IPC configuration. With even wear, the master status is transferred to a follower pump fulfilling the necessary requirements. These requirements include (from the highest to the lowest priority):

- maximum stationary time (parameter [76.76](#))
- pump priority (parameter [76.77](#))
- maximum wear imbalance (parameter [76.72](#))
- run time (parameters [77.10...77.18](#))
- node number (parameter [76.22](#)).

Fixed sequence transfers the master status to the next node number. For example, if pump 1 is the master and the start order is 1-2-3-4, then after autochange pump 2 will be the master and the start order becomes 2-3-4-1. If the next master pump is not running when autochange is triggered, it will be started and master status will be transferred to that pump when it has completed start up ramping.

Note that fixed sequence autochange requires that one pump can be started or that all pumps (the number of pumps equals the maximum pump count) are running before autochange can be done. For example, if you have 8 pumps and the maximum has been set to 3, and 3 pumps are running, autochange will not occur until the third pump is stopped, because otherwise the start order would not be correct (it is not possible to exceed the maximum number of pumps). However, in this example, if the maximum has been set to 8 and all 8 pumps are running, autochange will occur.

If you do not want some specific pump to be a master (for example if the pump does not have process feedback connected), set parameter [76.23 Master enable](#) for that pump to *False*. This way the pump will be bypassed when transferring master status during the autochange.

The master enable parameter can also be connected to other bit sources, for example supervision, to prevent the pump from being a master after some event has occurred (if for example AI was broken).

If the running master loses its ability to be the master, the system tries to recover from this as fast as possible by selecting the new master and starting new pumps if needed.

The IPC system communicates via the I21 bus connected to EFB by sending reference, status, run time and other system information between the pumps. If there is a communication loss between pumps when using fixed sequence, the pump with the lowest node number becomes the new master for a network segment that did not yet have an active master. With even wear, the next master selection is based on the even wear logic. When pumps can again communicate with each other, the master pump with the lowest node number remains the master while the active master from the other network segment releases the master status after some delay.

If a pump does not see any other pumps, it will wait for the time defined in parameter [40.33 Set 1 integration time](#) before it starts pumping. If the system is at setpoint when

the time has passed, the single pump will not start in order to not interfere with the system.

Settings

- Parameter group [76 Multipump configuration](#) (page [575](#))
- Parameter group [77 Multipump maintenance and monitoring](#) (page [586](#)).

Application example: IPC system with three drives and three pumps

In this example three drives with three pumps are connected to work in cooperation. The example simulates how the pressure sensor controls the system. The external pressure sensor needs to be connected to the system and it will send the information to the drive, which controls the operation of the pump as well as the follower drives.

The individual pumps can be tested in Hand mode (local control) which gives the ability to set the speed from the control panel. The drives can be started and stopped via Hand and Off buttons on the control panel.

To operate the IPC system, the system needs to be operated in Auto mode (remote control) and with PID closed loop control. PID setpoint is set as constant setpoint and the pressure transmitter used as process feedback is wired to analog input 2.

To start the system, the following digital inputs are used: DI1 Enable start of the system (Start / Stop) and DI4 Start interlock (dry pump sensor connection).

Notes:

- If any interlock is not satisfied (see parameters [20.40 Run permissive ... 20.44 Start interlock 4](#)) the drive will not be allowed to run.
- IPC system requires that all the drives are programmed with the same firmware version. Drives with a different firmware version from the master will generate an IPC version mismatch warning because the internal checksum will have a mismatch.



Wiring diagram

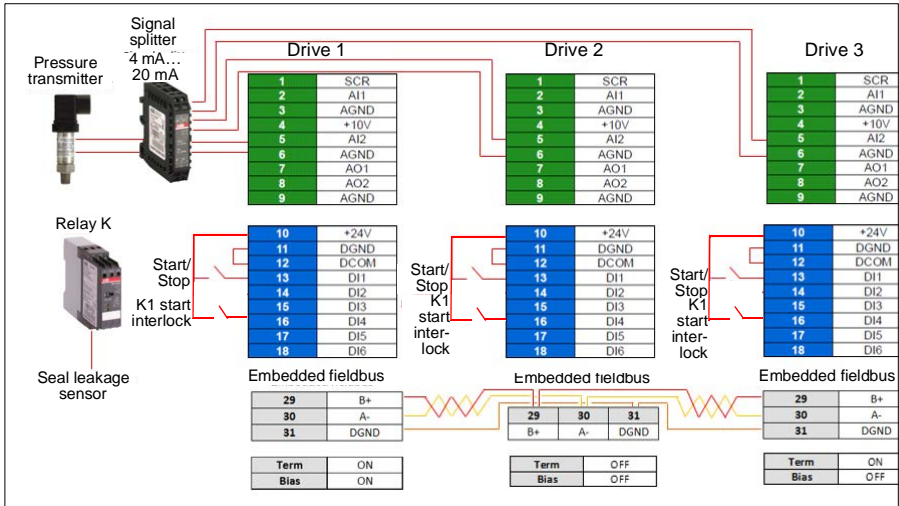

Note: If a current signal is used, use a signal splitter to connect the sensor signal to all drives that may take on the master role.

Voltage signal can also be used for sensor feedback. This allows chaining the sensor signal. The distance should be a consideration on the signal type.

Quick steps – Programming summary

Start up all three drives normally (see section [How to start up the drive](#) on page 22).

Configure IPC in the first drive

By setting up the first drive you can replicate the drive parameters using the synchronization feature under [Select Shared settings](#) below. This speeds up the commissioning process and helps to avoid mistakes.

Menu > Primary settings > Pump features

- Select **Multipump control**
- Select and edit **Pumping mode**: *Intelligent pump control (IPC)*
- Press **Next**
 - Edit **Node number**: (This number must be unique for each drive in the IPC system. In this example, we are using 1 for the first drive, 2 for the second drive and 3 for the third drive.)
 - Press **Next**
- Select **Settings for this pump**
 - Edit **Drive name**: (Keep the default name or give a unique name.)
 - Edit **Node number**: (Enter Node number if not already given above.)
 - Select **Can be master**. (In this example all three drives can act as a master. Redundant operation requires moving master. If this is not selected, the drive can only operate as a follower.)
 - Edit **Prefer this pump**: *Medium*. (The pumps can be prioritized based on energy efficiency and process demand: High - more energy efficient pumps, Medium - less energy efficient pumps, Low - pumps which do not run unless process demands. Similar pumps are recommended to be used in booster applications.)
 - Press **Back**
- Select **Shared settings**
 - Select **Synchronization settings**
 - Edit **Do you want to allow synchronization of settings with other drives?**: Yes. (Synchronization will save significant amount of time for the total system configuration. It also ensures that values within selected parameter groups are equal and copied according to last changed parameter.)
 - Press **Next**
 - Edit **Select settings to copy between all drives**:
 - Select **All settings**

- Select **PID settings**
- Select **IPC shared settings**
- Press **Next**
- Edit **Total number of pumps:** 3
- Edit **Always run at least:** 1 pump
- Edit **Never more than:** 3 pumps (These three pieces of information are synchronized over the inverter-to-inverter link between all drives.)
- Select **Start/stop speeds** (Define when a pump should be started or stopped by the system in order to meet the demand, keeping the target pressure.
Example values:
 - Edit **Start 2nd pump at:** 48 Hz
 - Edit **Start 3rd pump at:** 48 Hz
 - Edit **Stop 3rd pump at:** 25 Hz
 - Edit **Stop 2nd pump at:** 25 Hz

If the first pump cannot keep the pressure and exceeds 48 Hz, the second pump will be activated. If the demand is still rising and both pumps exceed 48 Hz the third pump will be activated.

If the demand declines and the three activated pumps fall under 25 Hz, the third pump will be deactivated. If the demand is still too low and the remaining two pumps fall below 25 Hz, the second pump will be deactivated.

These values **must** be defined according to the system. In many applications the start and stop speeds fall in narrow ranges, for example, 25...30 Hz and 40...45 Hz.
- Press **Back**
- Select **Transition smoothing**
 - Edit **Ignore demand spikes under:** 2.00 s (The spike time describes how long the output frequency needs to exceed the start point Hz setting, in this case, 48 Hz until the IPC starts the next drive.)
 - Edit **Ignore demand dips under:** 3.00 s (The dip time describes how long the frequency needs to stay below 25 Hz until the IPC stops one drive. This smooths the IPC behavior and avoids unnecessary starts and stops of the drives.)
 - Press **Back**
- Select **Autochange**. This function ensures, that the run time of all drives in the system is balanced.
 - Edit **Maximum wear imbalance:** 12 h. (This specifies the maximum difference in the running time between the drives in an IPC system.)

- Edit **Maximum stationary time:** *0.0 h*. (This makes sure the pump get exercised frequently. This protects especially low prioritized pump from pump blockages. Value 0.0 h disables the parameter.)
- Edit **Autochange only below:** *100%*. (This specifies the maximum speed when pump change is allowed. Value 100% allows a pump change action whenever it is needed.)
- Press **Back**
- Select **PID control (Secondary reference, EXT2)**
- Select **Use PID control**
- Edit **Activate PID control from:** *Always active*
- Edit **Start/stop/dir from:** *DI Start/stop*
- Edit **Unit:** *bar*
- View **PID status:** *0 hex*
- Select **Feedback**
 - **Actual value:** *0.0 bar*
 - Edit **Source:** *AI2 scaled*
 - Select **AI2 scaling**
 - Edit **Range:** *4...20 mA*
 - Edit **Scaled min:** *0.000 bar*
 - Edit **Scaled max:** *6.000 bar*
 - Press **Back**
 - Edit **filter time:** *0.000 s*
 - Press **Back**
- Select **Setpoint**
 - **Actual value:** *0.0 bar*
 - Edit **Source:** *Constant setpoint*
- Select **Constant setpoints**
 - Edit **Constant setpoint 1:** *4.00 bar*
 - Edit **Constant setpoint 2:** *0.00 bar*
 - Edit **Minimum:** *0.00 bar*
 - Edit **Maximum:** *6.00 bar*
 - Press **Back**
- Select **Tuning**
 - **Deviation actual value:** *0.00 bar*
 - Edit **Gain:** *1.00*
 - Edit **Derivation time:** *0.000 s*
 - Edit **Derivation filter time:** *0.0 s*

- Press **Back**
- Edit **Increase output**: *Feedback < Setpoint* (Used when filling booster pump or tank. “Feedback > Setpoint” is used, for example, when emptying a tank. “Feedback > Setpoint” is also used in cooling tower application.)
- Select **Output**:
 - **Actual value**: 0.00
 - Edit **Minimum**: 0.00
 - Edit **Maximum**: 50.00 (US:60.00) (Hz) or 100.0 (%)
 - Press **Back**
- Select and edit **Sleep function**: Off
- Press **Back** repeatedly to get to **Primary settings**.

Configure the rest of the drives

After starting up and configuring IPC of the first drive in the system, you can then start-up the rest of the drives (see section [How to start up the drive](#) on page 22).

Then configure each of these drive as follows.

Menu > Primary settings > Pump features

- Select **Multipump control**
- Select **Pumping mode**: *Intelligent pump control (IPC)*
- Press **Next**
 - Edit **Node number**: (The rest of the drives, in this example 2...3.)
 - Press **Next**
- Select **Communication link source**
 - Select EFB or FBA
 - Press **Next**
- Select **Settings for this pump**
 - Edit **Drive name**: (Give a unique name.)
 - Edit **Node number**: (Enter Node number if not already given above.)
 - Select **Can be master**
 - Edit **Prefer this pump**: *Medium*
 - Press **Back**
- Select **Shared settings**
 - Select **Synchronization settings**
 - Edit Do you want to allow synchronization of settings with other drives?: Yes.
 - Press **Next**
 - Edit **Select settings to copy between all drives**:
 - Select **AI settings**

- Select **PID settings**
- Select **IPC shared settings**
- Press **Back** repeatedly to get to **Primary settings**.

Now all the above parameter settings are copied to this drive and the system is ready to run.

Settings

- **Menu > Primary settings > Multipump Control (IPC)**
- Parameter group *01 Actual values* (page 361)
- Parameter group *40 Process PID set 1* (page 521)
- Parameter groups *76 Multipump configuration* (page 575) and *77 Multipump maintenance and monitoring* (page 586).

■ Single pump and fan control (PFC/SPFC)

The Single pump and fan control (PFC) is used in pump or fan systems consisting of one drive and multiple pumps or fans. The drive controls the speed of one of the pumps/fans and in addition connects (and disconnects) the other pumps/fans directly to the supply network through contactors.

6

The PFC control logic switches auxiliary motors on and off as required by the capacity changes of the process. In a pump application, for example, the drive controls the motor of the first pump, varying the motor speed to control the output of the pump. This pump is the speed regulated pump. When the demand (represented by the process PID reference) exceeds the capacity of the first pump (a user defined speed/frequency limit), the PFC logic automatically starts an auxiliary pump. The logic also reduces the speed of the first pump, controlled by the drive, to account for the addition to the total system output by the auxiliary pump. Then, as before, the PID controller adjusts the speed/frequency of the first pump in such a way that the system output meets the process needs. If the demand continues to increase, the PFC logic adds further auxiliary pumps, in a similar manner as just described.

As the demand drops, making the speed of the first pump fall below a minimum limit (user defined as a speed/frequency limit), the PFC logic automatically stops an auxiliary pump. The PFC logic also increases the speed of the drive controlled pump to account for the missing output of the stopped auxiliary pump.

The Single pump and fan control (PFC) is supported in external control location EXT2 only.

Example: Three-pump constant pressure water supply application

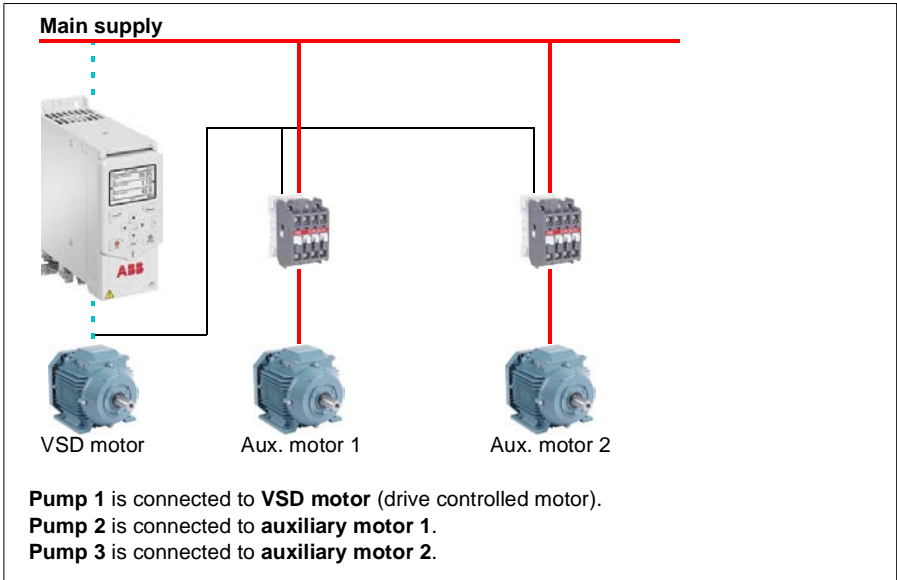

Flow consumption vs. pump status			
Consumption	Pump 1	Pump 2	Pump 3
Low	VSD	Off	Off
↓	VSD	DOL	Off
High	VSD	DOL	DOL
↓	VSD	DOL	Off
Low	VSD	Off	Off

VSD = Controlled by drive, tuning the output speed according to PID control.

DOL = Direct On Line. Pump is running at fixed motor nominal speed.

Off = Off-line. Pump stops.

Soft pump and fan control (SPFC)

The Soft pump and fan control (SPFC) logic is a variant of the PFC logic for pump and fan alternation applications where lower pressure peaks are desirable when a new auxiliary motor is to be started. The SPFC logic is an easy way to implement soft starting of direct on line (auxiliary) motors.

The main difference between traditional PFC and SPFC logic is how the SPFC logic connects auxiliary motors on-line. When the criteria for starting a new motor is fulfilled (see above) the SPFC logic disconnects the drive controlled motor from the drive and immediately connects that motor to the supply network in a flying start, that is, while the motor is still coasting. The drive then connects to the next pump/fan unit to be

started and starts controlling the speed of that one, while the previously controlled unit is now connected directly on line through a contactor.

Further (auxiliary) motors are started in a similar manner. The motor stopping routine is the same as for the normal PFC routine.

In some cases SPFC makes it possible to soften the start-up current while connecting auxiliary motors on-line. Lower pressure peaks on the pipelines and pumps may be achieved as a result.

Example: Three-pump constant pressure water supply application

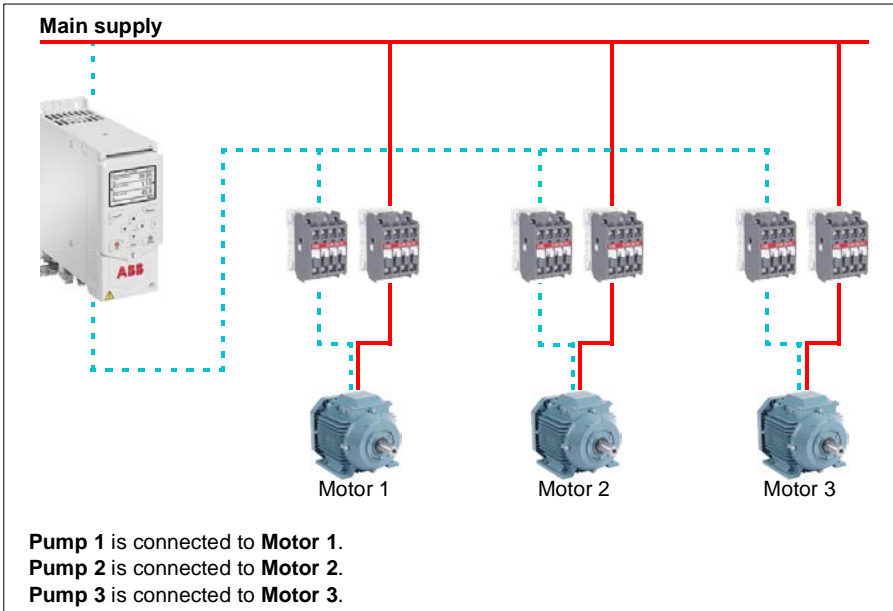

Flow consumption and pump status			
Consumption	Pump 1	Pump 2	Pump 3
Low	VSD	Off	Off
↓	DOL	VSD	Off
High	DOL	DOL	VSD
↓	DOL	Off	VSD
Low	Off	Off	VSD
↓	VSD	Off	DOL
High	DOL	VSD	DOL
↓	DOL	VSD	Off
Low	Off	VSD	Off
↓	VSD	DOL	Off
High	DOL	DOL	VSD

VSD = Controlled by drive, tuning the output speed according to PID control.

DOL = Direct On Line. Pump is running at fixed motor nominal speed.

Off = Off-line. Pump stops.

Autochange

Automatic rotation of the start order, or Autochange functionality, serves two main purposes in many PFC type setups. One is to keep the run times of the pumps/fans equal over time to even their wear. The other is to prevent any pump/fan from standing still for too long, which would clog up the unit. In some cases it is desirable to rotate the start order only when all units are stopped, for example, to minimize the impact on the process.

The Autochange can also be triggered by the Timed function (see page 155).

There are three modes of autochange according to what kind of PFC and SPFC together with auxiliary circuit are implemented.

1. Autochange PFC with auxiliary motors only

Example: Three-pump constant pressure water supply application.

Two pumps fulfill the flow consumption for long term running, and the third pump is reserved for shifting. In this mode, only two auxiliary motors, pump 2 and pump 3, shift working.

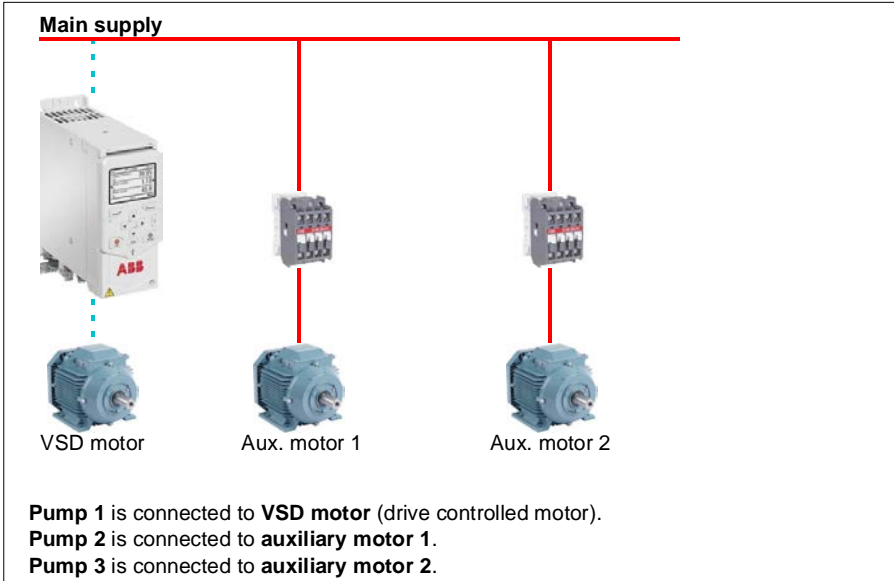

6

Flow consumption and pump status			
Consumption	Pump 1	Pump 2	Pump 3
Low	VSD	Off	Off
Normal	VSD	DOL	Off
↓	VSD	Off	DOL
↓	VSD	DOL	Off
Normal	VSD	Off	DOL

VSD = Controlled by drive, tuning the output speed according to PID control.

DOL = Direct On Line. Pump is running at fixed motor nominal speed.

Off = Off-line. Pump stops.

2. Autochange PFC with all motors

Example: Three-pump constant pressure water supply application

Two pumps fulfill the flow consumption for long term running, and the third pump is reserved for shifting. Because all motors will be shifted for autochange routine, special auxiliary circuit is needed, which is the same as for the SPFC system.

In this mode, the VSD motor will move to the next pump one by one, but the auxiliary motor will always be put on-line in DOL mode. However, three pumps are shifted overall.

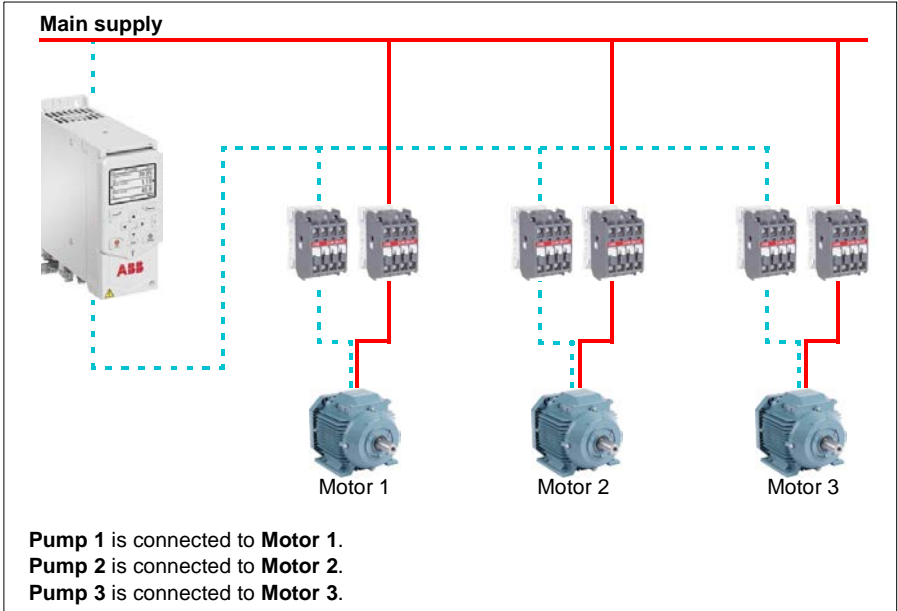

6

Flow consumption and pump status			
Consumption	Pump 1	Pump 2	Pump 3
Low	VSD	Off	Off
Normal	VSD	DOL	Off
↓	Off	VSD	DOL
↓	DOL	Off	VSD
Normal	VSD	DOL	Off

VSD = Controlled by drive, tuning the output speed according to PID control.

DOL = Direct On Line. Pump is running at fixed motor nominal speed.

Off = Off-line. Pump stops.

3. Autochange with SPFC

Auxiliary motor is meaningless in SPFC. So it does not matter if you select All motors or Aux motor only.

Example: Three-pump constant pressure water supply application

Two pumps fulfill the flow consumption for long term running, and the third pump is reserved for shifting.

SPFC system supports autochange naturally. No extra component is needed as long as SPFC is already working there. In this mode, all the pumps are always started by the drive as they are in SPFC normal operation.

6

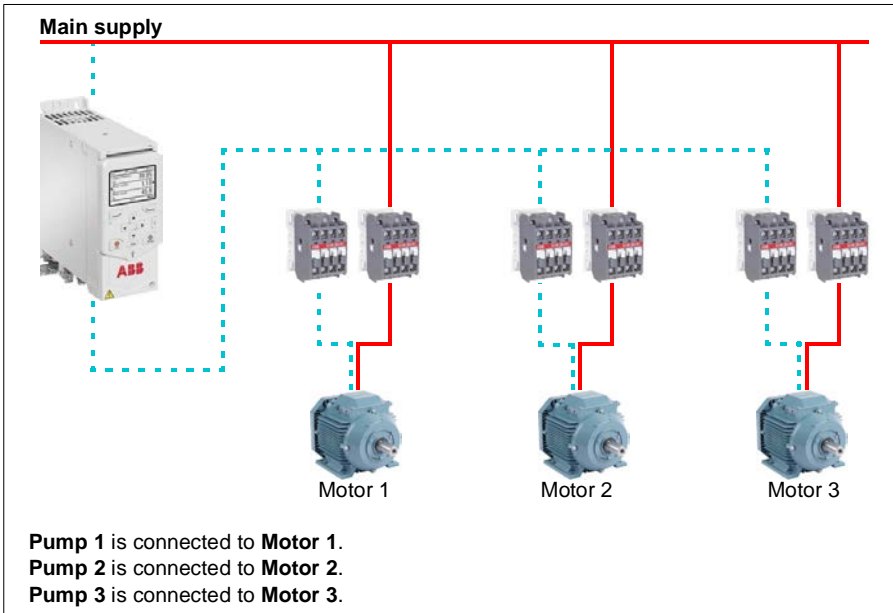

Flow consumption and pump status			
Consumption	Pump 1	Pump 2	Pump 3
Low	VSD	Off	Off
Normal	DOL	VSD	Off
↓	Off	DOL	VSD
↓	VSD	Off	DOL
Normal	DOL	VSD	Off

VSD = Controlled by drive, tuning the output speed according to PID control.

DOL = Direct On Line. Pump is running at fixed motor nominal speed.

Off = Off-line. Pump stops.

Interlock

There is an option to define interlock signals for each motor in the PFC system. When the interlock signal of a motor is available, the motor participates in the PFC starting sequence. If the signal is Interlocked, the motor is excluded. This feature can be used for informing the PFC logic that a motor is not available (for example, due to maintenance or manual direct-on-line starting).

Settings

- Parameter group [10 Standard DI, RO](#) (page [379](#))
- Parameter group [40 Process PID set 1](#) (page [521](#))
- Parameter groups [76 Multipump configuration](#) (page [575](#)) and [77 Multipump maintenance and monitoring](#) (page [586](#)).

Application example 1: Supply fan, Basic speed follower

There are a variety of different inputs and control schemes that may be applied to a drive being used on a supply fan. The example below consists of one of the more basic configurations. The following pages will build upon this example and provide more advanced examples. The example below consists of:

- Start/stop contact closure from the building automation system (BAS)
- A 0...10 V DC analog speed command signal from the BAS
- No safeties to the drive and no status feedback to the BAS.

Wiring diagram

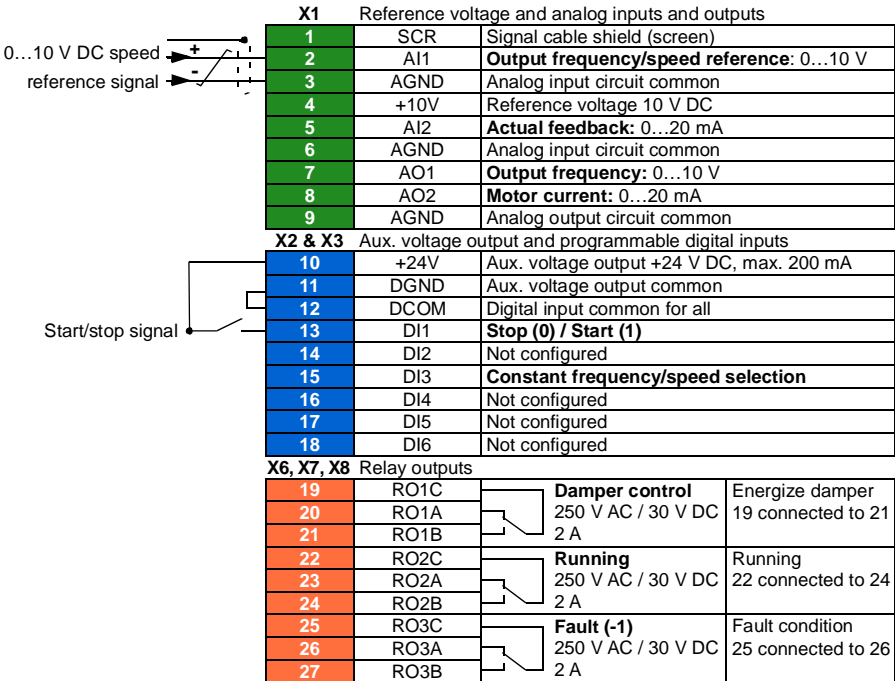

Quick steps – Programming summary

Settings listed below are changed relative to the drive's factory defaults to meet the application requirements:

Menu > Primary settings > Start, stop, reference > Interlocks/permissives

- Unselect Use start interlock 1

■ Application example 2: Supply fan, basic speed follower with interlock and status

There are a variety of different inputs and control schemes that may be applied to a drive being used as the controller for a supply fan. The example below consists of:

- Start/stop contact closure from the building automation system (BAS)
- A 0...10 V DC analog speed command signal from the BAS
- A duct high static pressure safety (Overpressure) contact wired to the drive
- A run/stop status feedback from the drive to the BAS
- A fault/not-faulted status feedback from the drive to the BAS.

Wiring diagram

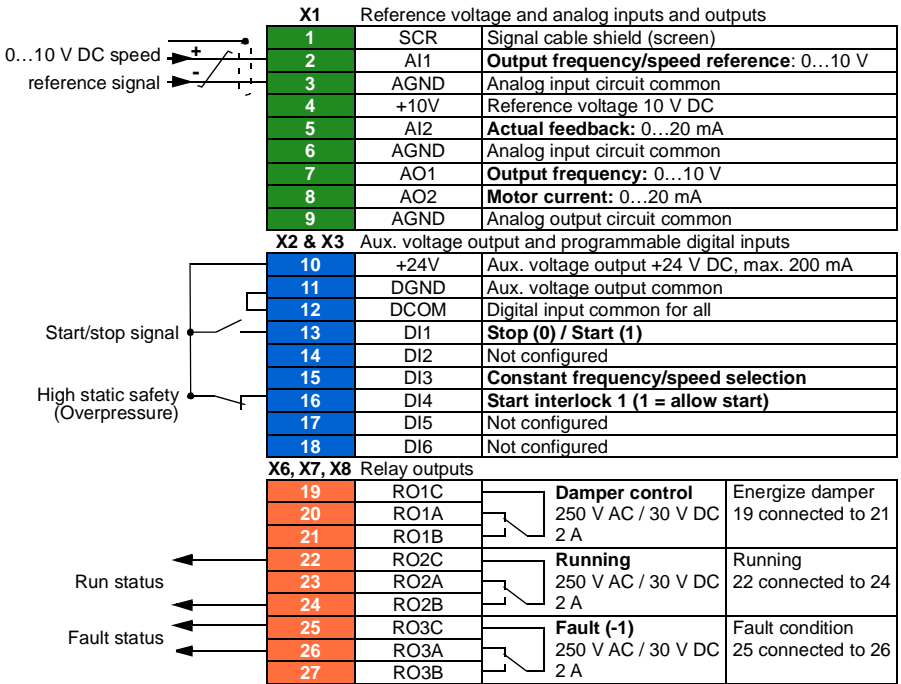

Quick steps – Programming summary

Settings listed below are changed relative to the drive's factory defaults to meet the application requirements:

Menu > Primary settings > Start, stop, reference > Interlocks/permisives

- **Use start interlock 1**
 - Edit **Description text:** *Overpressure*

■ Application example 3: Supply fan, speed follower complete integration

There are a variety of different inputs and control schemes that may be applied to a drive being used as the controller for a supply fan. The example below consists of:

- Start/stop contact closure from the building automation system (BAS)
- A 0...10 V DC analog speed command signal from the BAS
- A damper end-switch contact closure to the drive, to indicate the damper open/closed status
- A duct high static pressure safety (Overpressure) contact wired to the drive
- A supply air Smoke alarm safety contact wired to the drive
- A run/stop status feedback from the drive to the BAS
- A fault/not-faulted status feedback from the drive to the BAS
- A relay output to the external, actuator control circuit to open an isolation damper
- A 0...10 V DC analog output signal from the drive, to indicate drive output frequency, to the BAS.

Wiring diagram

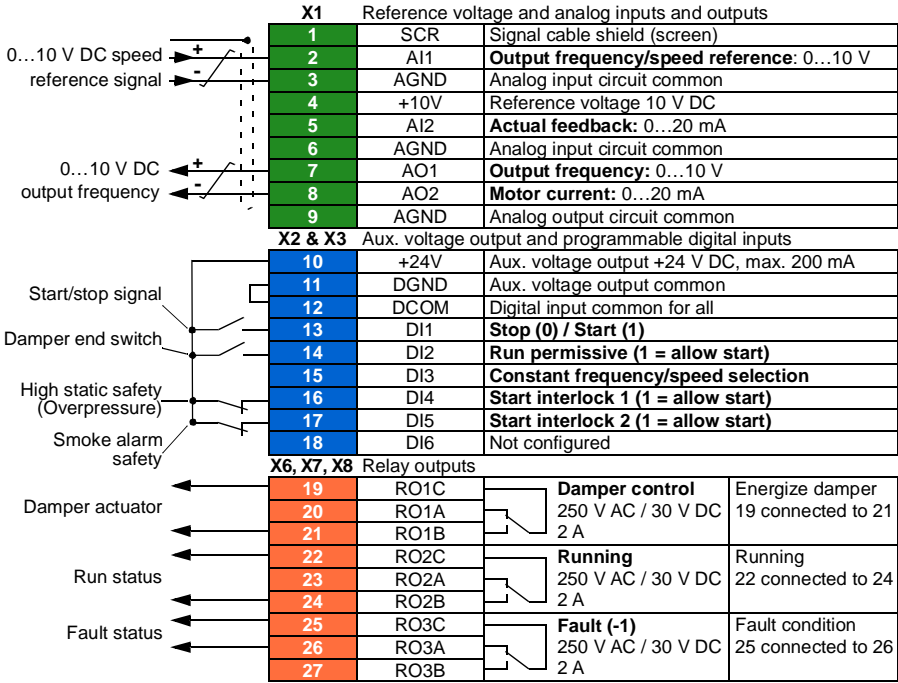

6

Quick steps – Programming summary

Settings listed below are changed relative to the drive's factory defaults to meet the application requirements:

Primary settings > Start, stop, reference > Interlocks/permissives

- Select **Use run permissive signal**
 - Edit **Run enabled when:** *DI2 high*
 - Edit **Description text:** *Damper end switch*
- **Use start interlock 1**
 - Edit **Description text:** *Overpressure*
- Select **Use start interlock 2.**
 - Edit **Start enabled when:** *DI5 high*
 - Edit **Description text:** *Smoke alarm*

Application example 4: Supply fan, PID control

The drive can be used with a supply fan to maintain static air duct pressure. The drive must speed up when the pressure is too low, and slow down when the pressure is too high. The example below consists of:

- Start/stop contact closure from the building automation system (BAS)
- A 4...20 mA setpoint command signal from the BAS
 - 4 mA = 0.0 kPa (or 0.0 inWC)
 - 20 mA = 0.5 kPa (or 2.0 inWC)
- A 4...20 mA analog pressure transducer feedback signal wired to the drive with a pressure range of 0...1.25 kPa (0...5 inWC)
 - 4 mA = 0.0 kPa (0.0 inWC)
 - 20 mA = 1.25 kPa (5.0 inWC)
- A duct high static pressure safety (Overpressure) contact wired to the drive
- A Freezestat safety contact wired to the drive
- A run/stop status feedback from the drive to the BAS
- A fault/not-faulted status feedback from the drive to the BAS.



Wiring diagram

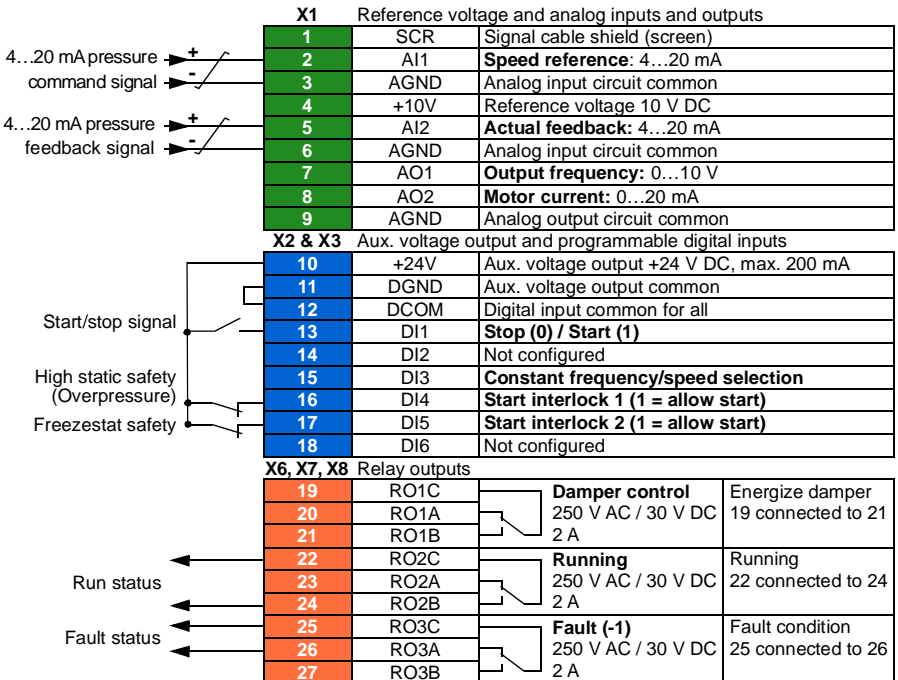

Quick steps – Programming summary

Settings listed below are changed relative to the drive's factory defaults to meet the application requirements:

Menu > Primary settings > Start, stop, reference > Interlocks/permissives

- **Use start interlock 1**
 - Edit **Description text:** *Overpressure*
- Select **Use start interlock 2**
 - Edit **Description text:** *Freezestat*

Menu > Primary settings > PID control

- Select **Use PID control**
- Edit **Start/stop/dir from:** *DI1 start/stop*
- Edit **Unit:** *kPa* (or *inWC*)

Menu > Primary settings > PID control > Feedback

- Edit **Source:** *AI2 Scaled*

6

Menu > Primary settings > PID control > Feedback > AI2 Scaling

- Edit **Range:** *4...20 mA*
- Edit **Scaled min:** *0 kPa* (or *0 inWC*)
- Edit **Scaled max:** *1.25 kPa* (or *5.0 inWC*)

Menu > Primary settings > PID control > Setpoint

- Edit **Source:** *AI1 scaled*

Menu > Primary settings > PID control > Setpoint > AI1 Scaling

- Edit **Range:** *4...20 mA*
- Edit **Scaled min:** *0.0 kPa* (or *0.0 inWC*)
- Edit **Scaled max:** *0.5 kPa* (or *2.0 inWC*)

Menu > Primary settings > PID control

- **Tuning** (adjust the gain and integration time of the PID, as needed for the application)

Application example 5: Cooling tower fan, speed follower

There are a variety of different inputs and control schemes that may be applied to a drive being used as the controller for a cooling tower. The example below consists of:

- Start/stop contact closure from the building automation system (BAS)
- A 4...20 mA analog speed command signal from the BAS
- A vibration safety switch contact wired to the drive
- A run/stop status feedback from the drive to the BAS
- A fault/not-faulted status feedback from the drive to the BAS
- Minimum frequency programmed to 30 Hz due to lubrication needs of this particular fan's right angle gear box.

Wiring diagram

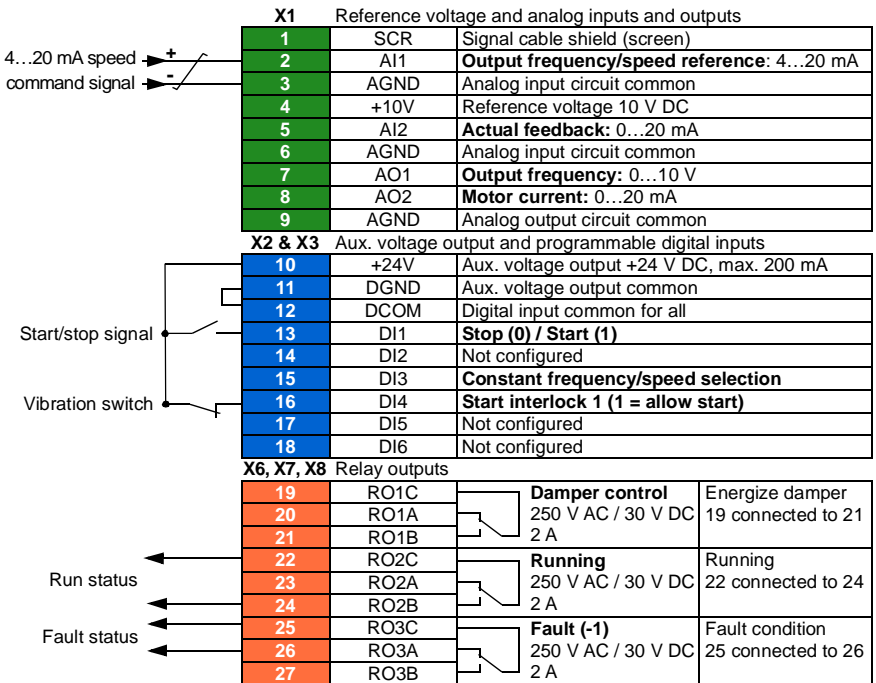

Quick steps – Programming summary

Settings listed below are changed relative to the drive's factory defaults to meet the application requirements:

Menu > Primary settings > Start, stop, reference > Primary auto control location > AI1 scaling

- Edit **Range**: *4...20 mA*

Primary settings > Start, stop, reference > Interlocks/permissives

- **Use start interlock 1**
 - Edit **Description text**: *Vibration switch*

Primary setting > Limits

- Edit **Minimum frequency**: *30.00 Hz*

■ Application example 6: Cooling tower, PID

There are a variety of different inputs and control schemes that may be applied to a drive being used as the controller for a Cooling tower. The example below consists of:

- Start/stop contact closure from the building automation system (BAS)
- Water temperature setpoint fixed at 24 °C (75 °F). The drive speeds up the fan when the temperature is too warm, and slows it down when the temperature is too cool
- A 4...20 mA analog water temperature transducer feedback signal wired directly to the drive with a temperature range of -30...50 °C (-22...122 °F)
 - 4 mA = -30 °C (-22 °F)
 - 20 mA = 50 °C (122 °F)
- A vibration safety switch contact wired to the drive
- A run/stop status feedback from the drive to the BAS
- A fault/not-faulted status feedback from the drive to the BAS
- Minimum frequency programmed to 20 Hz due to lubrication needs of this particular fan's right angle gear box
- The drive stops the fan and enters sleep mode when the motor speed drops below 25 Hz for more than 30 seconds.
- The drive wakes up from sleep mode when the water temperature increases above 26 °C (79 °F), which is also a deviation of 2 °C (4 °F) above the setpoint of 24 °C (75 °F).

Wiring diagram

		X1 Reference voltage and analog inputs and outputs				
		1	SCR	Signal cable shield (screen)		
		2	AI1	Output frequency/speed reference: 0...10 V		
		3	AGND	Analog input circuit common		
		4	+10V	Reference voltage 10 V DC		
4...20 mA temp. feedback signal		5	AI2	Actual feedback: 4...20 mA		
		6	AGND	Analog input circuit common		
		7	AO1	Output frequency: 0...10 V		
		8	AO2	Motor current: 0...20 mA		
		9	AGND	Analog output circuit common		
		X2 & X3 Aux. voltage output and programmable digital inputs				
		10	+24V	Aux. voltage output +24 V DC, max. 200 mA		
		11	DGND	Aux. voltage output common		
		12	DCOM	Digital input common for all		
Start/stop signal		13	DI1	Stop (0) / Start (1)		
		14	DI2	Not configured		
		15	DI3	Constant frequency/speed selection		
Vibration switch		16	DI4	Start interlock 1 (1 = allow start)		
		17	DI5	Not configured		
		18	DI6	Not configured		
		X6, X7, X8 Relay outputs				
		19	RO1C		Damper control 250 V AC / 30 V DC 2 A	Energize damper 19 connected to 21
		20	RO1A			
		21	RO1B			
Run status		22	RO2C		Running 250 V AC / 30 V DC 2 A	Running 22 connected to 24
		23	RO2A			
		24	RO2B			
Fault status		25	RO3C		Fault (-1) 250 V AC / 30 V DC 2 A	Fault condition 25 connected to 26
		26	RO3A			
		27	RO3B			

6

Quick steps – Programming summary

Settings listed below are changed relative to the drive's factory defaults to meet the application requirements:

Menu > Primary settings > Start, stop, reference > Interlocks/permissives

- Use Start interlock 1**
 - Edit **Description text:** *Vibration switch*

Menu > Primary settings > Limits

- Edit **Minimum frequency:** 20 Hz

Menu > Primary settings > PID control

- Select **Use PID control**
- Edit **Start/stop/dir from:** *DI1 start/stop*
- Edit **Unit:** °C (or °F)

Menu > Primary Settings > PID control > Feedback

- Edit **Source:** *AI2 Scaled*

Menu > Primary Settings > PID control > Feedback > AI2 Scaling

- Edit **Range**: 4...20 mA
- Edit **Scaled min**: -30.0°C (or -22°F)
- Edit **Scaled max**: 50.0°C (or 122°F)

Menu > Primary Settings > PID control > Setpoint

- Edit **Source**: *Constant setpoint*
- Edit **Constant setpoint 1**: 24.0°C (or 75.0°F)

Menu > Primary Settings > PID control >

- **Tuning** (adjust the gain and integration time of the PID, as needed for the application)
- Edit **Increase output**: *Feedback > setpoint*

Menu > Primary Settings > PID control > Sleep function

- Select **Use sleep function**
- Edit **Activation level**: 25 Hz
- Edit **Delay**: 30.0 s
- Edit **Wake-up deviation**: 2 °C (or 4 °F)

Application example 7: Chilled water pump

There are a variety of different inputs and control schemes that may be applied to the drive being used on a chilled water pump. The example below consists of:

- Start/stop contact closure from the building automation system (BAS)
- A 0...10 V DC analog speed command signal from the BAS
- A run/stop status feedback from the drive to the BAS
- A fault/not-faulted status feedback from the drive to the BAS
- A 4...20 mA analog output signal from the drive, to indicate drive output current, to the BAS
- When a stop command is received, the drive shall ramp the motor to a stop to prevent water hammer.

Wiring diagram

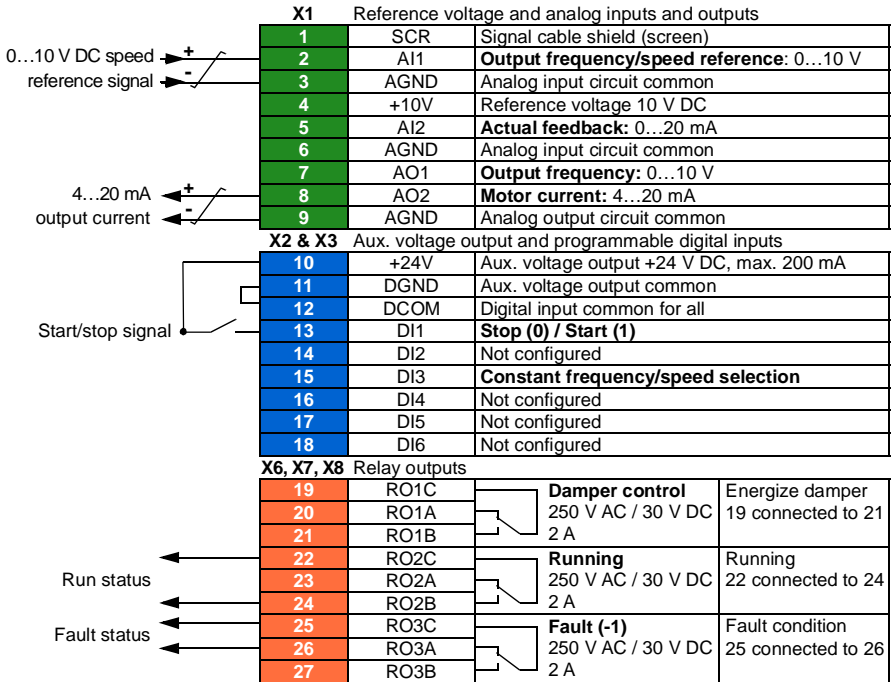

Quick steps – Programming summary

Settings listed below are changed relative to the drive's factory defaults to meet the application requirements:

Menu > I/O > AO2

- Edit **Range**: *4...20 mA*

Menu > Primary settings > Ramps

- Edit **Stop mode**: *Ramp*

Menu > Primary settings > Start, stop, reference > Interlocks/permisives

- Unselect **Use start interlock 1**

Application example 8: Condenser water pump

There are a variety of different inputs and control schemes that may be applied to a drive being used on a condenser water pump. The example below consists of:

- Start/stop contact closure from the building automation system (BAS)
- A 4...20 mA analog speed command signal from the BAS
- A run/stop status feedback from the drive to the BAS
- A fault/not-faulted status feedback from the drive to the BAS
- When a stop command is received, the drive ramps the motor to a stop to prevent water hammer.
- Minimum frequency set to 20 Hz.

Wiring diagram

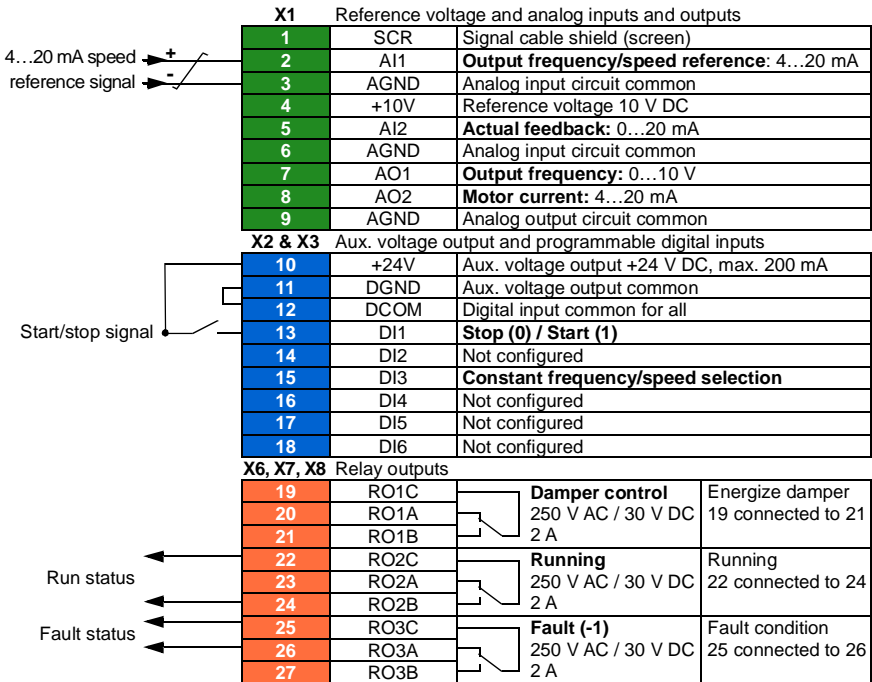

Quick steps – Programming summary

Settings listed below are changed relative to the drive's factory defaults to meet the application requirements:

Menu > Primary settings > Start, stop, reference > Primary auto control location A11 scaling

- Edit **Range**: 4...20 mA

Menu > Primary settings > Start, stop, reference > Interlocks/permissives

- Unselect **Use start interlock 1**

Menu > Primary settings > Ramps

- Edit **Stop mode**: *Ramp*

Menu > Primary setting > Limits

- Edit **Minimum frequency**: 20 Hz

■ Soft pipe fill

The Soft pipe fill function can be used to fill an empty pipe softly. The function can avoid sudden charge of water and rise in pressure in a closed valve or a nozzle at the end of the pump system.

The figure below illustrates the operation of the Soft pipe fill function.

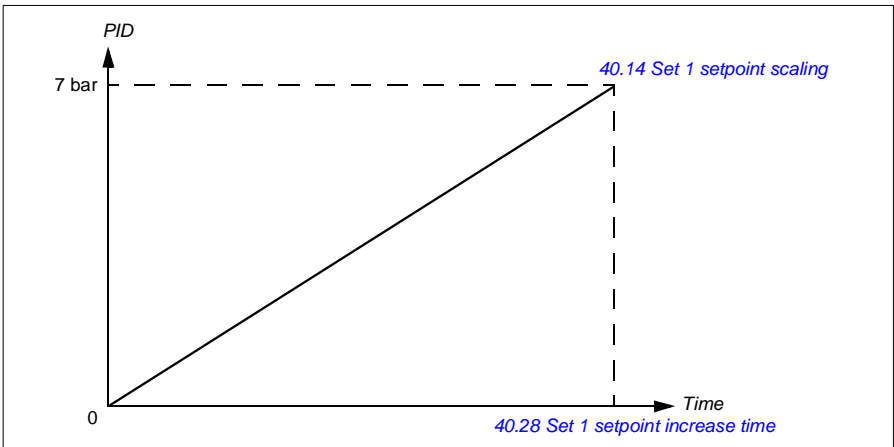

If the pumping system is leaking or is damaged then the setpoint will not reach in time. To detect such a condition, you can enable soft pipe fill supervision to generate a warning or a fault. The time is calculated with the last reference change in parameter [40.03 Process PID setpoint actual](#).

Settings

- **Menu - Primary settings - Pump features - Soft pipe fill**
- Parameter groups [40 Process PID set 1](#) (page 521) and [82 Pump protections](#) (page 595).

■ Sensorless flow calculation

The flow calculation function provides a reasonably accurate (typically $\pm 3\text{...}6\%$) calculation of the flow without the installation of a separate flow meter. The flow is calculated on the basis of parameter data such as pump inlet and outlet diameters, pressure at pump inlet and outlet, height difference of pressure sensors, and pump characteristics.

The user can either define a HQ (head/flow) or PQ (power/flow) performance curve that is used as the basis for the calculation. It is also possible to use differential pressure based flow feedback. Flow calculation method is selected in Primary settings or with parameter [80.13 Flow feedback function](#).

The figure below shows the HQ performance curve of the pump for the flow calculation function.

6

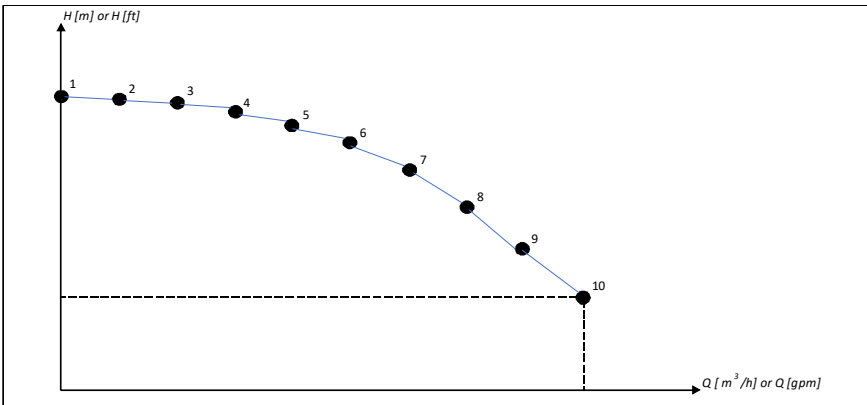

The figure below shows the PQ performance curve of the pump for the flow calculation function.

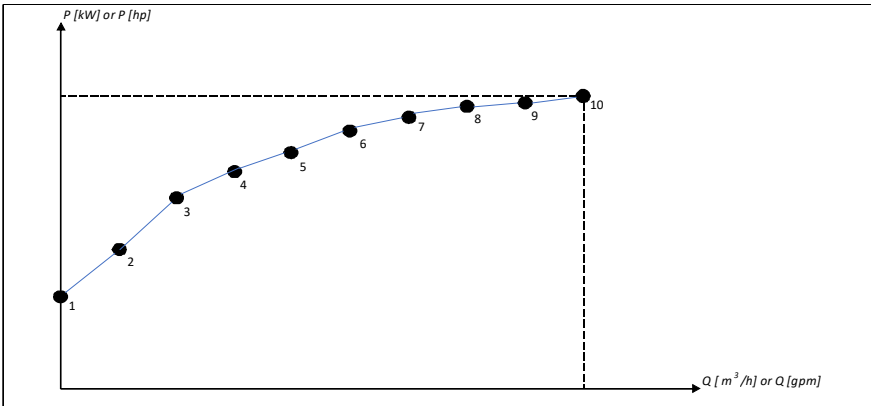

The flow calculated based on HQ or PQ curve is scaled according to the actual speed of the pump. Scaling reference speed is set in parameter [80.21 Flow pump nominal speed](#).

To increase the flow calculation accuracy, a correction factor can be entered to parameter [80.14 Flow feedback multiplier](#).

Sensorless head calculation

If these two pump curves are properly parameterized, they can be used to not only calculate the flow without a sensor, but to also calculate the head without a sensor. In simplified terms, the PQ curve can be used to calculate the flow and that calculated flow can then be used in the QH curve to determine the head.

The selection *PQ and QH curves* is available from Drive firmware version 2.18.2.1 onwards and is selected with parameter [80.13 Flow feedback function](#).

Notes

- The flow calculation function cannot be used for invoicing purposes.
- The flow calculation function cannot be used outside the normal operating range of the pump.
- Head point H1 in HQ curve must be defined at zero flow.
- Head points in HQ curve are expected to be in descending order (H1 > H2 > H3 > H4 > H5, etc).
- Power point P1 in PQ curve must be defined at zero flow.
- Power points in PQ curve are expected to be in ascending order (P1 < P2 < P3 < P4 < P5, etc).

Parameter group [80 Flow calculation](#) (page [588](#)) defines the HQ/PQ or differential pressure-based flow feedback and [81 Sensor settings](#) (page [593](#)) defines pump inlet and outlet selection for HQ calculation.

Settings

- Parameter group [80 Flow calculation](#) (page [588](#)) and [81 Sensor settings](#) (page [593](#)).

■ Dry pump protection

The Dry pump protection (dry run protection) function can be used to protect the pump from getting dry.

The figure below illustrates the operation of dry pump protection function.

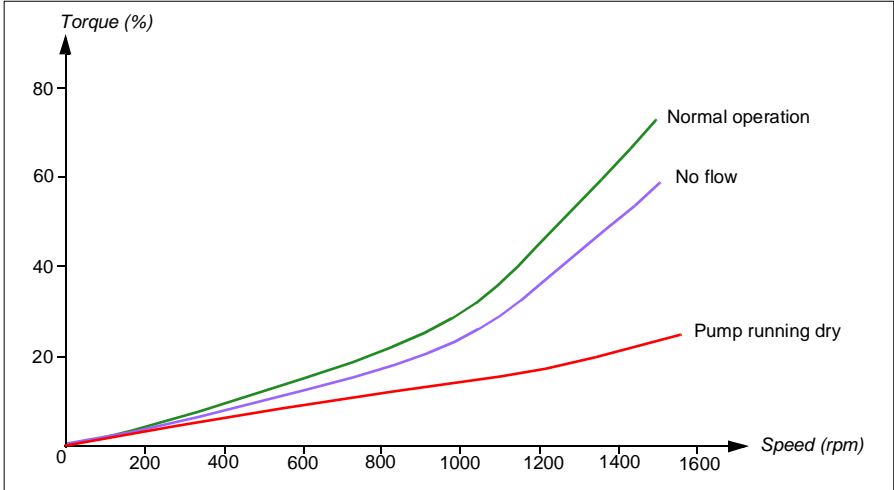

The dry pump can be detected using the underload curve, low level mechanical switch and pressure sensor.

- **Underload curve** - Detects the pump maybe getting dry and generates a warning or fault.
- **Low/high level mechanical switch** - Indicates the water level in the pump system through a digital input and generates a warning or fault.
- **Pressure sensor** - Connected to Supervision 1...3 through an analog input. The output of supervision indicates the pump inlet getting dry and generates a warning or fault.

Settings

- **Menu** -> **Primary settings** -> **Pump features** -> **Dry pump protection**
- Parameter group [82 Pump protections](#) (page [595](#)).

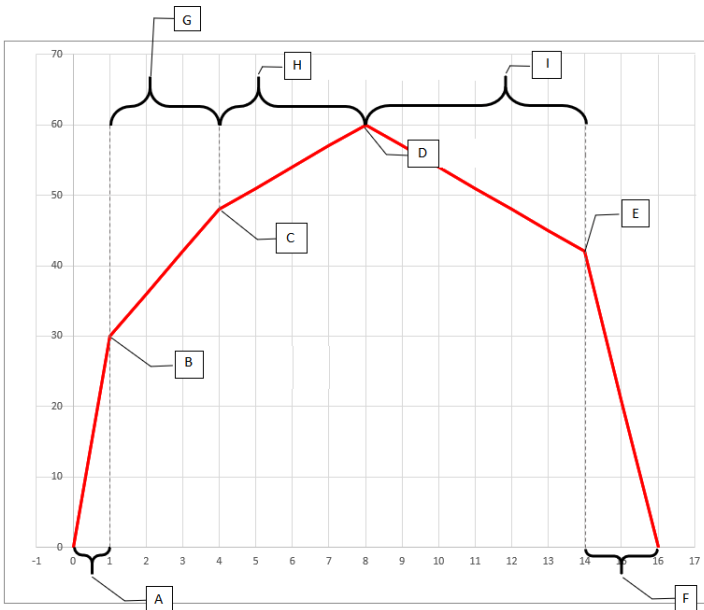

6

- A = 82.05 1st quick ramp accel. time
 B = 82.07 1st quick ramp accel. limit
 C = 82.12 2nd quick ramp accel. limit
 D = 46.01 Speed scaling / 46.02 Frequency scaling
 E = 82.08 Final quick ramp decel. limit
 F = 82.06 Final quick ramp decel. time
 G = 82.10 2nd quick ramp accel. time
 H = 82.14 Oper. quick ramp accel. time (3rd)
 I = 82.15 Oper. quick ramp decel. time (1st)

Automatic fault resets

The drive can automatically reset itself after overcurrent, overvoltage, undervoltage and external faults. The user can also specify a fault that is automatically reset.

By default, automatic resets are off and must be specifically activated by the user.



WARNING! Before you activate the function, make sure that no dangerous situations can occur. The function resets the drive automatically and continues operation after a fault.

Settings

- Menu > Primary settings > Advanced functions > Autoreset faults
- Parameters 31.12...31.16 (page 478).

■ External events

Five different event signals from the process can be connected to selectable inputs to generate trips and warnings for the driven equipment. When the signal is lost, an external event (fault, warning, or a mere log entry) is generated. The contents of the messages can be edited on the control panel.

Settings

- **Menu > Primary settings > Advanced functions > External events**
- Parameters [31.01...31.10](#) (page [475](#)).

■ Constant speeds/frequencies

Constant speeds and frequencies are predefined references that can be quickly activated, for example, through digital inputs. It is possible to define up to 7 speeds for speed control and 7 constant frequencies for frequency control.



WARNING: Speeds and frequencies override the normal reference irrespective of where the reference is coming from.

Settings

- **Menu > Primary settings > Start, stop, reference > Constant speeds**
- **Menu > Primary settings > Start, stop, reference > Constant frequencies**
- Parameter groups [22 Speed reference selection](#) (page [439](#)) and [28 Frequency reference chain](#) (page [457](#)).

■ Critical speeds/frequencies

Critical speeds (sometimes called “skip speeds”) can be predefined for applications where it is necessary to avoid certain motor speeds or speed ranges because of, for example, mechanical resonance problems.

The critical speeds function prevents the reference from dwelling within a critical band for extended times. When a changing reference ([22.87 Speed reference act 7](#)) enters a critical range, the output of the function ([22.01 Speed ref unlimited](#)) freezes until the reference exits the range. Any instant change in the output is smoothed out by the ramping function further in the reference chain.

When the drive is limiting the allowed output speeds/frequencies, it limits to the absolutely lowest critical speed (critical speed low or critical frequency low) when accelerating from standstill, unless the speed reference is over the upper critical speed/ frequency limit.

The function is also available for scalar motor control with a frequency reference. The input of the function is shown by [28.96 Frequency ref act 7](#), the output by [28.97 Frequency ref unlimited](#).

Example for critical speeds:

A fan has vibrations in the range of 540...690 rpm and 1380...1560 rpm. To make the drive avoid these speed ranges,

- enable the critical speeds function by turning on bit 0 of parameter [22.51 Critical speed function](#), and
- set the critical speed ranges as in the figure below.

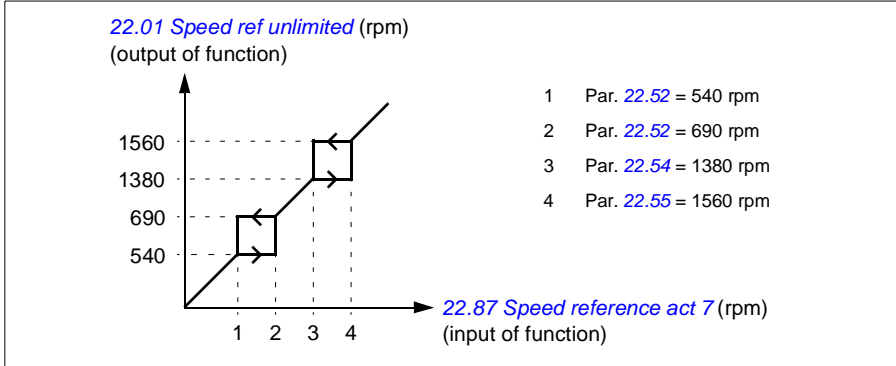
**Example for critical frequencies:**

A fan has vibrations in the range of 18...23 Hz and 46...52 Hz. To make the drive avoid these frequency ranges,

- enable the critical frequencies function by turning on bit 0 of parameter [28.51 Critical frequency function](#), and
- set the critical frequency ranges as in the figure below.

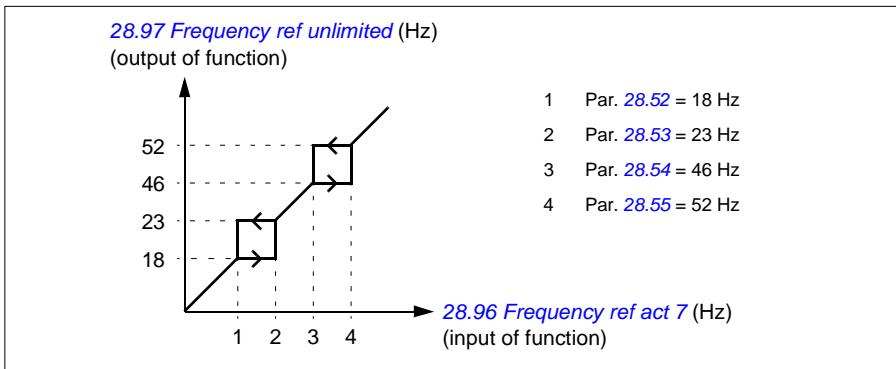

Settings

- **Menu > Primary settings > Start, stop, reference > Constant speeds**
- **Menu > Primary settings > Start, stop, reference > Constant frequencies**
- Critical speeds: parameters [22.51...22.57](#) (page [446](#))
- Critical frequencies: parameters [28.51...28.57](#) (page [464](#)).

■ Timed functions

The base entity of the timed functions is called a timer. A timer can be active based on time of the day, day of the week and season of the year. In addition to these time related parameters, the timer activation can be influenced by so called days of exception (configurable as holiday or workday). For example, 25.12. (Dec 25th) can be defined as holiday in many countries. A timer can be set to be active or inactive during the days of exception.

Several timers can be connected to a timed function with the OR function. Thus if any of the timers connected to a timed function is active, the timed function is also active. The timed function is then in turn controlling normal drive functions like starting the drive, choosing the right speed or right setpoint for the PID loop controller.

In many cases where a fan, pump or other equipment is controlled with a timed function, it is often required that there is a possibility to override the time program for a short while. The overriding functionality is called boost. The boost is directly affecting selected timed function(s) and switches it (them) on for a predefined time. The boost mode is typically activated through a digital input and its operation time is set in parameters.

A diagram illustrating the relations of the timed functions entities is shown below.

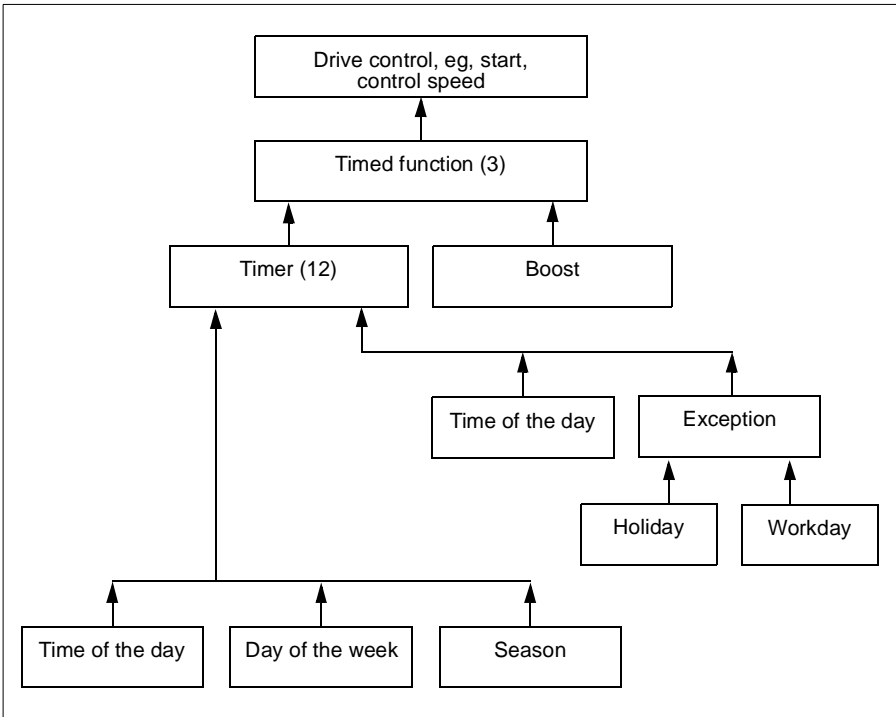

Settings

- **Menu > Primary settings > Advanced functions > Timed functions**
- Parameter group [34 Timed functions](#) (page 496).

Ramps

■ Overview

Ramps refer to acceleration and deceleration times. The ramps function adjusts the rate of how fast or slow a drive changes the motor speed with respect to the commanded speed. Ramps should be configured based on the specific application requirements.

■ Functionality

Acceleration ramps are recommended for all applications. The acceleration ramp is the amount of time required for the drive to ramp up the motor from 0 Hz to the ramp

time target frequency setting. The Ramp time target frequency setting is located under **Menu > Primary Settings > Ramps**.

The deceleration ramp is the amount of time required for the drive to ramp down from the ramp time target frequency to 0 Hz. The most typical settings of ramp time target frequency are 50 Hz outside of North America and 60 Hz for North America. Note that the ramps function is always active during operation and not just used for starting and stopping modes.

In fan applications, the stop mode is typically set to coast, which causes the drive to ignore the deceleration ramp while stopping. In this scenario, the drive will no longer be controlling the speed of the motor once the run command is removed. The figure below shows a ramp curve for 90-second acceleration and no deceleration.

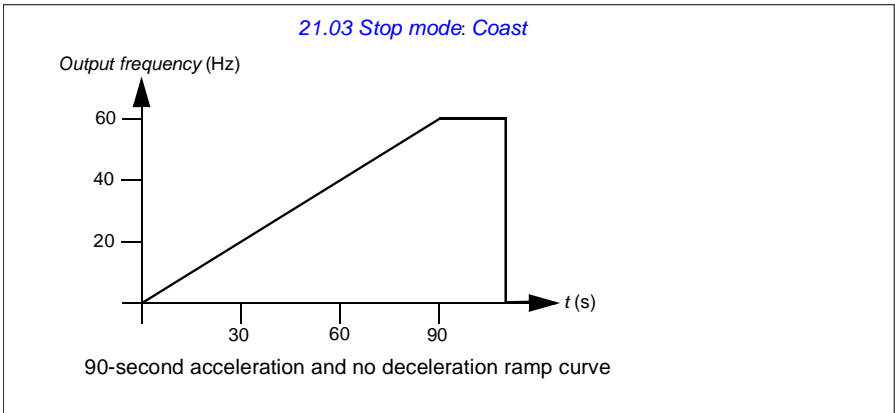

In pump applications, the stop mode is typically set to ramp and the deceleration ramp is used while stopping. Ramping a pump motor to a stop helps prevent issues

such as water hammer and assist in closing the check valve. The figure below shows a ramp curve for 30-second acceleration and deceleration.

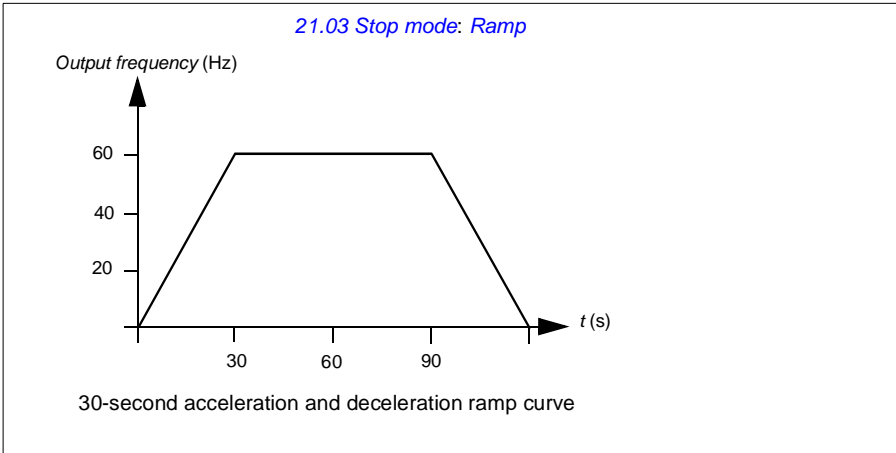

6

If the acceleration time is too short, the drive may trip out on overcurrent. If the deceleration ramp is set to stop too quickly, the drive may trip out on overvoltage. These scenarios are unlikely in most applications due to the internal current and voltage limiting features built into the drive. However, the desired ramps times will not be achieved in such circumstances.

Each application and motor is unique. As a general guideline for HVAC pumps and fans, ramp times are often set between 30 and 90 seconds. Typically a larger drive/motor has a longer ramp time. However, certain applications or pump types require a much faster or slower ramp time.

The drive also supports the ability to have two ramp sets. This feature is most commonly used in situations where a fast acceleration time is needed to a certain speed, and then a slower acceleration time is needed above that speed. This feature is configured with **Menu > Primary settings > Ramps > Use two ramp sets**.

Settings

- **Menu > Primary settings > Ramps**
- Speed reference ramping: Parameters [23.11...23.15](#) and [46.01](#) (pages [450](#) and [546](#))
- Frequency reference ramping: Parameters [28.71...28.75](#) and [46.02](#) (pages [465](#) and [547](#))
- Floating point control (Motor potentiometer): Parameter [22.75](#) (page [448](#))
- Emergency stop ("Off3" mode): Parameter [23.23 Emergency stop time](#) (page [451](#)).

■ Application examples

Referring to [Application example 7: Chilled water pump](#) (page 144) and [Application example 8: Condenser water pump](#) (page 146), the drive is programmed to have the drive ramp the motor to a stop to prevent water hammer. All of the fan application examples are set up to coast to stop.

In the case of the fan application examples, it is not necessary to control the fan while stopping because the resistive forces are not great enough to cause damage to any part in the system. The fan will slowly come to a stop due to the air resistance and friction in the system. If a drive receives a new run command while the fan is still slowing, the drive can catch the spinning motor and ramp the fan to the reference speed.

In the pump application examples, the fluid in the pipes can create enough force on the pump to cause the pump to come to a stop very quickly after the drive stops controlling the motor. This sudden stop will cause a pressure surge in the pipes, often known as water hammer. Water hammer problems include noise and vibration, but can also cause major problems like pipe collapse. By using the drive to control the slowdown of the pump over a longer period of time, the pressure change is not sudden and the water hammer issue is eliminated.

Process PID control

There are two built-in process PID controllers (PID set 1 and PID set 2) in the drive. The controller can be used to control process variables such as pressure or flow in the pipe or fluid level in the container.

In process PID control, a process reference (setpoint) is connected to the drive instead of a speed reference. An actual value (process feedback) is also brought back to the drive. The process PID control adjusts the drive speed in order to keep the measured process quantity (actual value) at the desired level (setpoint). This means that user does not need to set a frequency/speed/torque reference to the drive but the drive adjust its operation according to the process PID.

The simplified block diagram below illustrates the process PID control. For more detailed block diagrams, see pages [350](#) and [352](#).

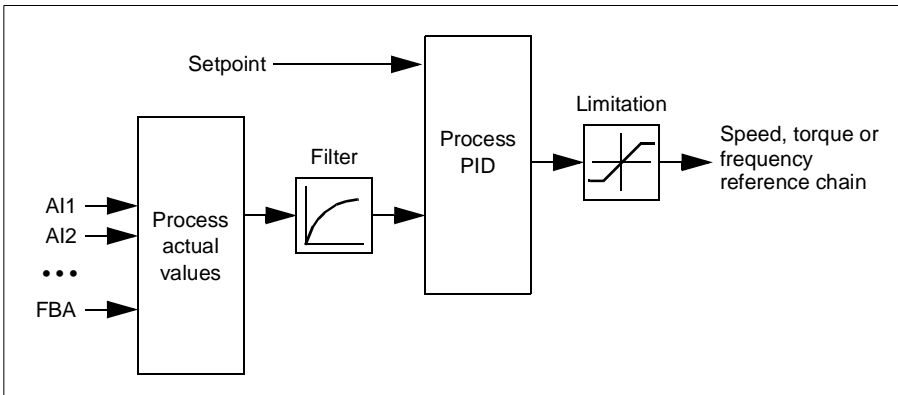

The drive contains two complete sets of process PID controller settings that can be alternated whenever necessary; see parameter [40.57 PID set1/set2 selection](#).

Note: Process PID control is only available in external control location EXT2; see section [Local control vs. external control](#) (page [101](#)).

Sleep and boost functions for process PID control

The sleep function is suitable for PID control applications where the consumption varies, such as clean water pumping systems. When used, it stops the pump completely during low demand, instead of running the pump slowly below its efficient operating range. The following example visualizes the operation of the function.

Example: The drive controls a pressure boost pump. The water consumption falls at night. As a consequence, the process PID controller decreases the motor speed. However, due to natural losses in the pipes and the low efficiency of the centrifugal pump at low speeds, the motor would never stop rotating. The sleep function detects the slow rotation and stops the unnecessary pumping after the sleep delay has passed. The drive shifts into sleep mode, still monitoring the pressure. The pumping

resumes when the pressure falls under the predefined minimum level and the wake-up delay has passed.

The user can extend the PID sleep time by the boost functionality. The boost functionality increases the process setpoint for a predetermined time before the drive enters the sleep mode.

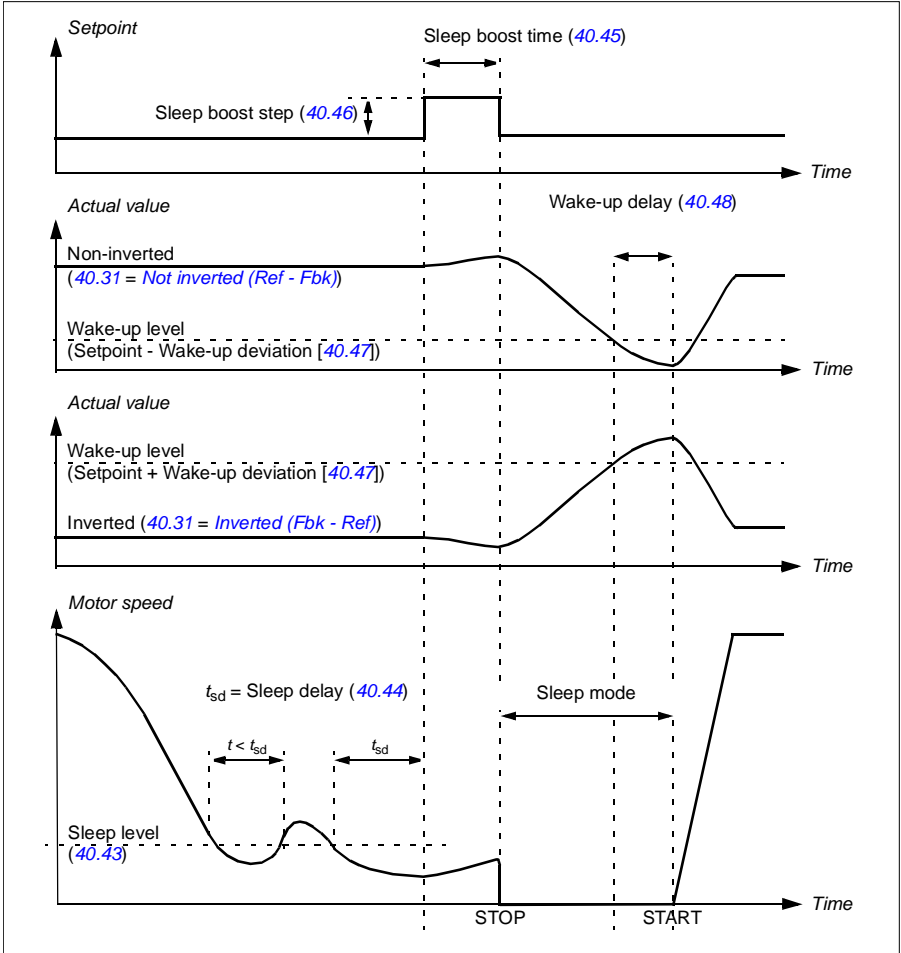

Tracking

In tracking mode, the PID block output is set directly to the value of parameter [40.50](#) (or [41.50](#)) *Set 1 tracking ref selection*. The internal I term of the PID controller is set so that no transient is allowed to pass on to the output, so when the tracking mode is left, normal process control operation can be resumed without a significant bump.

Settings

- Parameter groups [40 Process PID set 1](#) (page [521](#)) and [41 Process PID set 2](#) (page [537](#)).

Limits

■ Limits overview

The drive has multiple limits that can be set to prevent the drive from causing damage to the motor or the mechanical system. Limits can be applied to the minimum and maximum frequency, speed, or torque and the maximum current. Frequency limits are used in scalar motor control mode, while speed limits are used in vector motor control mode.

Setting a minimum speed/frequency may be used to prevent a pump or motor from overheating. Running a certain pump or motor type at too slow a speed will decrease its ability to cool itself. Also, certain gearbox style cooling towers require a minimum speed setting to provide proper lubrication of the gearbox. Equipment that runs warmer, or lacks proper lubrication, will likely have a shorter lifespan. Consult the equipment manufacturer for minimum speed/frequency settings.

Setting a maximum speed/frequency may be used to prevent excessive mechanical stress. Mechanical stress at levels above the equipment's design will likely shorten the lifespan of the equipment. Consult the equipment manufacturer to determine the maximum safe speed/frequency.

The maximum current setting will prevent steady-state operation above a specific current operation. Note that this setting is unrelated to the motor overload protection, which is configured based on actual motor current information entered into the drive.

Settings

- **Menu > Primary Settings > Limits**
- Parameter group [30 Limits](#).

■ Application examples

Referring to [Application example 5: Cooling tower fan, speed follower](#) (page 139) and [Application example 6: Cooling tower, PID](#) (page 141), the minimum frequency is set based on limitations on the lubrication requirements of the fan's gearbox. In this case, the limit is based on information provided by the equipment manufacturer.

While the other examples on pages [132...146](#) do not use limitations, there may be a benefit. For example, in the pumping application examples, a pump manufacturer may recommend a minimum flow of 25%. Flow is linearly related to motor speed. In this example, assuming a 60 Hz pump system, the drive's minimum frequency would be set to 15 Hz.

Override

■ Overview

The Override mode, a flexible way to configure a critical response, is typically used in fan applications that require a special operating mode to assist with fire and smoke control. The Override mode can also be used in a variety of different applications besides life safety control.

Note: The following section details the operation of Override for a stand-alone drive in scalar mode. See section [Scalar motor control](#) (page 181).

■ Activating the Override mode

When Override is activated, the drive follows the programmed functionality defined in the parameter group [70 Override](#), using the settings defined in the **Menu > Primary settings > Override** menu. The Override mode is activated through an assigned digital input in the drive, which you select in the **Primary settings > Override > Activate override from:** menu. The digital input also acts as the start command for the drive in Override mode

6

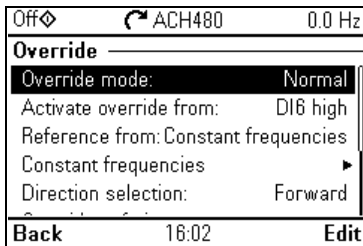

Select Normal or Critical Override mode in **Menu > Primary settings > Override > Override mode**. Normal follows the programmed number of fault resets while in Override mode. Critical allows for infinite number of fault resets. Disabled indicates that Override is not being used.

It is important that the system will operate as programmed when the Override mode is triggered. Secure the Override settings so that they cannot be changed:

1. Select **Menu > Primary settings > Security**.
2. Unlock the **Security** menu by entering the user pass code.
3. Select **Lock override settings**.
4. Lock the **Security** menu at the end.

When Override is deactivated, the drive returns to the original programmed mode of operation. Note that if the drive was in the Hand mode before Override was selected, the drive returns to the Off mode after Override is deactivated.

Reference for Override frequency

You can configure the drive to run in seven different Override mode types by selecting the reference for Override frequency in the **Reference from:** menu.

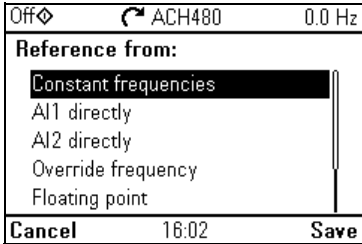

- **Constant frequencies** allows you to select multiple, constant frequencies based on multiple digital inputs.
- **AI1 directly** or **AI2 directly** is the speed reference in the Override mode.
- **Override frequency** commands the drive frequency to a single preprogrammed value.
- **Floating point** uses two defined digital inputs to increase or decrease the drive frequency. Initial values can be configured, as well as, minimum and maximum values and ramp times.
- **Force stop** stops the drive following the defined stop mode.
- **PID, set1** controls the drive frequency using the output value of the process PID controller for PID parameter set 1.

Override mode features

When placed into the Override mode, the drive shows the following features and behaviors.

- Once in Override, the drive ignores all fieldbus communication commands for start/stop and speed reference.
- In the Override mode the drive ignores all commands from the control panel: for example, Hand/Off/Auto requests and any parameters changes that would affect override are ignored. If a DriveWare tool is connected via the USB port, it will be ignored.
- Activating the Override mode also initiates a start command. There is no need for a secondary start command while in the Override mode.

- The run permissive signal and the signal source for the start interlock(s) that will be followed during the Override mode can be set up from the **Primary settings > Override > Override safeties** menu.

Off	ACH480	0.0 Hz
Override safeties		
<input checked="" type="checkbox"/>	Use run permissive signal	
<input checked="" type="checkbox"/>	Use start interlock 1	
<input checked="" type="checkbox"/>	Use start interlock 2	
<input type="checkbox"/>	Use start interlock 3	
<input type="checkbox"/>	Use start interlock 4	
Back	16:03	Unselect

- When Override is enabled, the drive ignores all inputs with the exception of the override activation/deactivation input, the digital inputs selecting the constant frequency, or frequencies, and the safeties selected to be effective in the Override mode. Selecting which ones remain active is done in the **Override safeties** menu and they can be the run permissive signal and/or up to four start interlock(s).
- When the Override mode is active, the drive displays warning message **Override active**.

OVERRIDE	ACH480	0.0 Hz
	Warning AFPE Aux code: 0000 0000	
Override active	16:03:07	
Drive is in override mode		
Hide	16:03	How to fix

- The monitoring of parameters by fieldbus communication is still available during the Override mode. Pass through I/O points (analog outputs, relays outputs and digital inputs that are controlled through a fieldbus) will operate normally and pass data through the drive.

- Faults are grouped into high priority faults and low priority faults. High priority faults are displayed and they will stop the drive. See parameter group [70 Override](#) (page [567](#)) for fault handling. The following is a list of the high priority faults:

2310 Overcurrent	5090 STO hardware failure
2330 Earth leakage	5091 Safe torque off
2340 Short circuit	7122 Motor overload
3210 DC link overvoltage	FA81 Safe torque off 1
4981 External temperature 1	FA82 Safe torque off 2
4982 External temperature 2	

- Unless listed above, all other faults are low priority faults. Active low priority faults are reset when the drive enters the Override mode. Low priority faults are ignored when the drive is in the Override mode.
- You can select whether or not to use autoreset for critical faults (**Use autoreset for critical faults**) or require a manual reset from the control panel or designated digital input.
- The number of high priority fault reset attempts is affected by the Override mode. You can select: **Disabled, Normal, or Critical**. Disabled indicates that Override is not being used. Normal follows the programmed number of fault resets. Critical allows for an infinite number of fault resets.
Note: Using Critical Override might void the warranty if the function is not used correctly.
- The Override configuration is able to be locked through the drive's access level security. See parameter group [96 System](#) (page [607](#)) for pass code and access level settings.
- The AI supervision function still operates for any Override modes that utilize an analog input. Thus if an analog input signal is lost, the drive will operate based on parameter group [12 Standard AI](#) (page [398](#)) configuration.
- If Safe Torque Off (STO) is triggered while the drive is in the Override mode, the drive exits override and follows the programming for STO alarm and fault configuration. A fault code is displayed to let the operator know the drive is in an STO condition. When STO is disabled, the drive does not go back into override operation.

Settings

- Menu > Primary settings > Override**
- Parameter group [70 Override](#) (page [567](#))
- Parameter group [12 Standard AI](#) (page [398](#))
- Parameter group [96 System](#) (page [607](#)).

■ Application example 1: Override for single Override frequency control

The air handler unit (AHU) that normally provides conditioned air to the occupied zone may be switched into a smoke control mode by the fire alarm system. The AHU dampers are typically configured to full outside air and exhaust air paths, in smoke control mode. The supply fan and the return/exhaust fan are controlled to pre-determined speeds to provide the specified air flow and space pressurization. This example consists of:

- A start/stop command from the building automation system (BAS) for Normal mode operation
- A 0...10 V DC analog speed command signal from the BAS for Normal mode operation
- A Freezestat safety configured as a low priority safety interlock that will be ignored in the Override mode
- A duct high static pressure safety (Overpressure) configured as a high priority safety interlock that will operate in normal and Override modes
- A supply air smoke detector/alarm safety configured as a high priority safety interlock that will operate in normal and Override modes
- In the Override mode, the drive will operate at a single, predefined override frequency (air balance preset of 48 Hz)
- In the Override mode the high priority safeties will be reset as many times as required to ensure the system stays in operation
- Override mode is enabled by relay output from the fire alarm system to the drive
- A run/stop status feedback from the drive to the BAS
- A fault/not-faulted status feedback from the drive to the BAS.

Wiring diagram

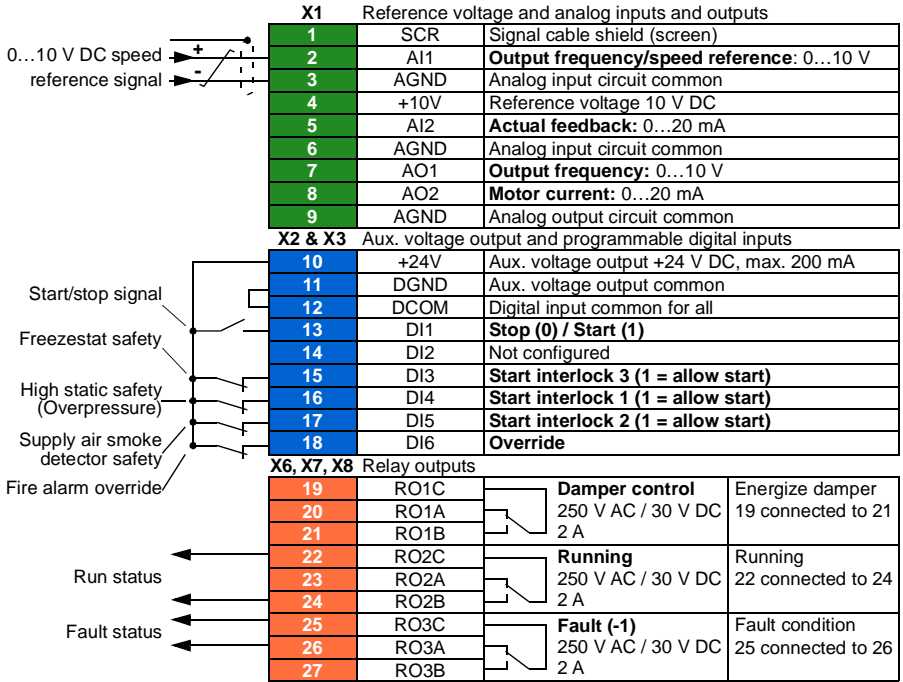

Quick steps – Programming summary

Unless otherwise noted, the settings listed below are changed relative to the drive's factory defaults to meet the application requirements. The settings identified below are specific to the configuration of Override mode and configuration of the Interlock text, and do not review the complete normal mode configuration.

Menu > Primary settings > Override

- Edit **Override mode**: *Critical*
- Edit **Activate override from**: *DI6 high*
- Edit **Reference from**: *Override frequency*
- Edit **Override frequency**: *48.0 Hz*
- Edit **Direction selection**: *Forward* (default)
- Select **Override safeties**
 - **Use safety/start interlock 1**
 - **Use safety/start interlock 2**
- Select **Use autoreset for critical faults**
- Edit **Wait between reset attempts**: *5.0 s* (default)
- Edit **Max attempts**: *5* (default)

Menu > Primary settings > Start, stop, reference > Interlocks/permissions

- **Use safety/start interlock 1**
 - Edit **Description text**: *Overpressure*
- Select **Use safety/start interlock 2**
 - Edit **Start enabled when**: *DI5 high*
 - Edit **Description text**: *Smoke alarm*
- Select **Use safety/start interlock 3**
 - Edit **Start enabled when**: *DI3 high*
 - Edit **Description text**: *Freezestat*

■ Application example 2: Override for PID control

In the application example 1, the drive ran at a predetermined fixed frequency. In this example, the drive will use its internal PID loop to control based on a fixed pressure. A common application of the control scheme used in application example 2 is for the control of a dedicated stairwell pressurization fan in multi-story buildings during a fire or smoke event. The drive controls the stairwell pressurization fan speed to maintain a specific level of positive pressure in the stairwell. The positive pressure relative to the occupied space helps reduce the amount of smoke that enters the stairwell. This example consists of:

- The drive/fan only operates during a fire or smoke event
- An analog differential pressure sensor measuring the pressure differential between the stairwell and the occupied space
- An override input (Run) from the fire alarm system to start the drive and place it in the Override mode
- A dedicated “shutdown” command from the fire alarm system
- An isolation damper end-switch contact closure, wired from the damper to the drive, to indicate the damper open/close status. (The isolation damper has to be proven open for the fan to operate.)
- A High pressure static safety (Overpressure)
- Resetting of high priority faults is Normal with two resets. (This is not “run to destruction”.)
- A run/stop status feedback from the drive to the building automation system (BAS)
- A fault/not-faulted status feedback from the drive to the BAS.

Wiring diagram

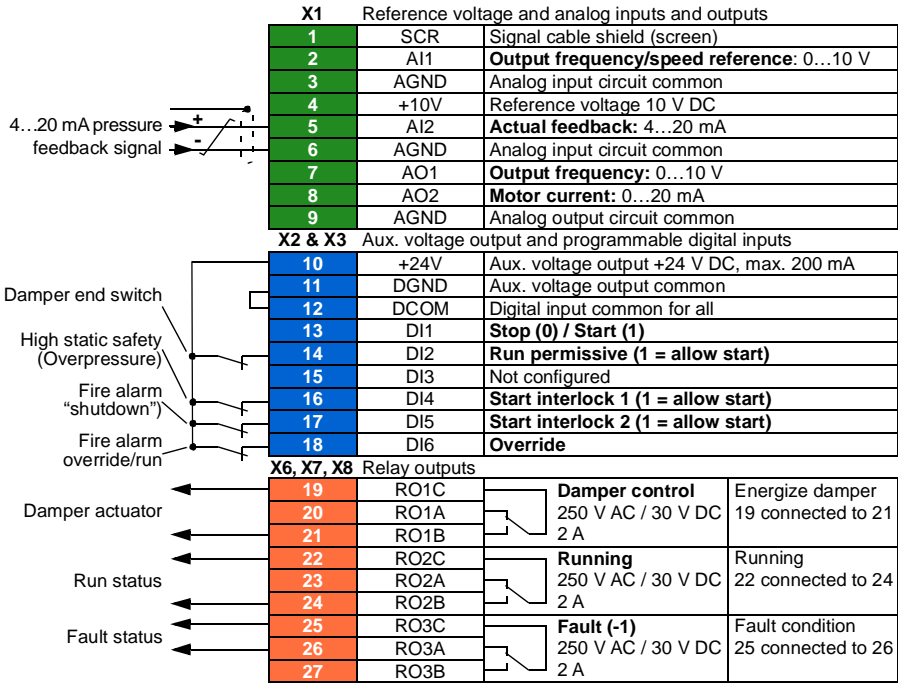

Quick steps – Programming summary

Unless otherwise noted, the settings listed below are changed relative to the drive's factory defaults to meet the application requirements. The settings identified below are specific to configuration of the Override mode and configuration of the Interlock text, and do not review the complete setup of the PID configuration.

Primary settings > Override

- Edit **Override mode:** *Normal*
- Edit **Activate override from:** *DI6 high*
- Edit **Reference from:** *PID, set 1*
- Edit **Direction selection:** *Forward* (default)
- Select **Override safeties**
 - Select **Run permissive signal**
 - Select **Start safety/interlock 1**
 - Select **Start safety/interlock 2**
- Select **Use autoreset for critical faults**
 - Edit **Wait between reset attempts:** *5.0 s* (default)
 - Edit **Max attempts:** *2*

Primary settings > Start, stop, reference > Interlocks/permissives

- Select **Run permissive signal**
 - Edit **Description text:** *Damper end switch*
- Select **Use safety/start interlock 1**
 - Edit **Description text:** *Overpressure*
- Select **Use safety/start interlock 2**
 - Edit **Start enabled when:** *DI5 high*
- Edit **Description text:** *Smoke alarm*

-

Interlocks

■ Overview

Interlocks provide a way to prevent the drive from running when an input is not satisfied. The interlock feature of the drive is often used to wire safeties back to the drive. ABB does not recommend wiring interlocks in series with each other, unless there are more than four interlocks. Wiring interlocks separately allows for faster system troubleshooting, as the drive provides quick identification on which individual interlock is no longer satisfied. Monitoring the status of each interlock is available over fieldbus communications.

Interlocks typically are wired to the drive's digital inputs (DI), DI1 through DI6. Certain fieldbus communications can also be used to control interlocks, although typically not recommended for most applications.

■ Configuration

6

You can configure interlocks either in the **Primary settings** menu, or via parameter group [20 Start/stop/direction](#) in the **Parameters** menu. ABB recommends configuration via the **Primary settings** menu (**Menu > Primary settings > Start, stop, reference > Interlocks/permisives**).

Interlocks are configurable for normally open or normally closed functionality.

- For example, in the **Primary settings**, selecting an interlock for DI4 high indicates that digital input 4 must be closed, or logic 1, to allow the drive to run. A setting of DI4 low indicates the digital input must be open, or logic 0, to allow the drive to run. If the interlock is not in a logic state that will allow the drive to run, the interlock is unsatisfied. If the interlock is in a logic state that will allow the drive to run, the interlock is satisfied.

An unsatisfied interlock is indicated on the drive control panel display via a flashing green LED light, and a flashing warning on the display. You can set up the drive to indicate an unsatisfied interlock in one of two methods (**Menu > Primary settings > Start, stop, reference > Interlocks/permisives > Interlock warning condition**). This setting applies to all the interlocks.

- Indicate a warning, whenever an interlock is unsatisfied, regardless of a run command.
- Indicate a warning, whenever an interlock is unsatisfied and a run command is present.

You can configure the drive for either coast or ramp to a stop, when the interlock changes to an unsatisfied state (**Menu > Primary settings > Start, stop, reference > Interlocks/permisives > Interlock stop mode**).

■ Wiring connections

Interlocks function in both Auto and Hand control modes. ABB recommends that the system interlocks are wired directly to the drive, and not to an external building automation system (BAS) controller.

Failure to wire the interlock(s) directly to the drive can inadvertently allow Hand mode operation, when an interlock is not satisfied.

■ Functionality

The drive allows predefined descriptive text and label text (free text) to be independently associated with each of the four different interlocks. The control panel display will display that specific text when the interlock becomes unsatisfied.

You configure (select) the predefined descriptive text in **Menu > Primary settings > Start, stop, reference > Interlocks/Permissives > Descriptive text**.

You configure (edit) the label text in **Menu > Primary settings > Start, stop, reference > Interlocks/Permissives > Label text**.

Settings and diagnostics

- **Menu > Primary settings > Start, stop, reference > Interlocks/Permissives**
- Parameter [20.41 Start interlock 1](#) (page 428)
- Warnings [AFEE Start interlock 1](#), [AFEF Start interlock 2](#), [AFF0 Start interlock 3](#), [AFF1 Start interlock 4](#) and [AFF3 Start interlock forced warning](#)

■ Application examples of interlocks

The following are application examples of interlocks that can be connected to the drive. The drive has predefined text available for all of these examples.

1. **Overpressure.** This interlock is typically used with air handlers for air duct protection. This interlock stops operation when the measured pressure exceeds a threshold, to prevent damage to ductwork. For integration examples, see [Application example 2: Supply fan, basic speed follower with interlock and status](#) (page 133) and [Application example 3: Supply fan, speed follower complete integration](#) (page 135).
2. **Motor disconnect open.** This interlock is used in a variety of applications that have a disconnect switch between the drive and motor, to indicate the disconnect switch has been opened. This interlock prevents the drive from attempting to operate a motor while the disconnect switch is open. Note that without this interlock wired to the drive, under certain operating conditions, the motor will attempt to draw a high amount of inrush current once the disconnect switch is closed. This high amount of current may cause the drive to fault to protect itself.
3. **Vibration trip.** This interlock is typically used with cooling towers for vibration protection. This interlock stops operation when the measured vibration exceeds a threshold, to prevent damage to the tower.

A vibration switch that is connected to the drive digital input setup as an interlock should be a latching style vibration switch. A latching style vibration switch requires manual reset to allow the drive to run the motor again. If the vibration switch is an auto reset style, the drive digital input should be setup as an external event to fault the drive. This can be done in **Menu > Primary Settings > Advanced functions > External events**.

For integration examples, see [Application example 5: Cooling tower fan, speed follower](#) (page 139) and [Application example 6: Cooling tower, PID](#) (page 141).

4. **Smoke alarm.** This interlock is typically used with air handlers to stop the propagation of smoke through air ducts. This interlock stops operation when the measured smoke exceeds a threshold, to limit the amount of smoke spread through the system. For an integration example, see [Application example 3: Supply fan, speed follower complete integration](#) (page 135).
5. **Freezestat.** This interlock is typically used with air handlers for coil protection. This interlock stops operation when the measured temperature is below a threshold, to prevent freezing and subsequent coil damage. For an integration example, see [Application example 4: Supply fan, PID control](#) (page 137).
6. **Firestat.** This interlock is typically used with air handlers. This interlock stops operation when the measured temperature is above a threshold, possibly indicating a fire in the building.
7. **Low suction or Low pressure.** This interlock is typically used with pumps for pump protection. This interlock stops operation when the measured pressure on the suction side of the pump is below a threshold, to prevent pump damage from having it run dry.
8. **Access door.** This interlock is used in a variety of applications that have an access door. This interlock stops operation when the access door is opened. Note that an interlock is not an acceptable alternative to following proper safety procedures.
9. **Auxiliary open.** This interlock text is a generic term used in a variety of applications that have auxiliary contacts that need to stop drive operation. This interlock stops operation when the auxiliary has been opened.
10. **Pressure relief.** This interlock is used in applications that have a pressure relief method, such as a pressure relief valve, that also has an interlock tied to this relief method. This interlock stops operation when pressure exceeds a threshold and pressure is being mechanically relieved.
11. **Start interlock 1, Start interlock 2, Start interlock 3, and Start interlock 4.** This interlock text is a generic term used in a variety of applications that have interlocks. This interlock stops operation when the interlock has been opened or closed depending on the setup. ABB recommends using the predefined

Descriptive text and/or custom Label text whenever possible, as this will simplify any future interlock troubleshooting needs.

12. **Label text.** Provides up to 35 characters of free/custom text describing the interlock. This text will appear on the drive control panel when the interlock is no longer satisfied. This text can be used to better describe the interlock itself or its physical location. This text can also be used to enter a phone number for the local support of that equipment. Note that the Label text option is separate from the predefined text, thus the two can be used in conjunction with each other. For example, the predefined text can be selected for Overpressure, while the Label text may state "Reset switch located in control panel."

Run permissives

Overview

The run permissive function provides a way to prevent the drive from outputting to a motor when an input is not satisfied. This function is used to support applications that require the drive to first trigger an external event before the drive starts to ramp the motor. Run permissive is often used in conjunction with an end-switch wired back to the drive. This end-switch could be part of a damper or valve control scheme. Monitoring the status of the run permissive is available over fieldbus communications.

Run permissive is different from start interlock:

- A run permissive makes the drive enter a run state but does not provide an output to the motor.
- An unsatisfied run permissive input will only indicate a warning on the control panel display if a start command is also provided. No warning will be provided if the start command is not present. Start interlock is configurable to acknowledge, or ignore, the start command status when determining if a warning must be indicated.

6

The run permissive is typically wired to one of the drive's digital inputs (DI), DI1 through DI6. DI2 is most commonly used. Certain fieldbus communications can also be used to control run permissive, although typically not recommended for most applications.

Configuration

You can configure run permissive either in the **Primary settings** menu, or via parameter group [20 Start/stop/direction](#) in the **Parameters** menu. ABB recommends configuration via the **Primary settings** menu (**Menu > Primary settings > Start, stop, reference > Interlocks/permissives**). Run permissive is configurable for normally open or normally closed functionality.

Wiring connections

The run permissive functions in both Auto and Hand control modes. ABB recommends that any system permissive is wired directly to the drive and not to an external building automation system (BAS) controller.

Failure to wire the permissive directly to the drive can inadvertently allow Hand mode operation when a permissive is not satisfied.

■ Functionality

The drive allows predefined Descriptive text, and Label text (free text), to be associated with the Run permissive. The control panel will display that specific text when the permissive becomes unsatisfied.

- You configure (select) the predefined descriptive text in **Menu > Primary settings > Start, stop, reference > Interlocks/Permissives > Descriptive text.**
- You configure (edit) the label text in **Menu > Primary settings > Start, stop, reference > Interlocks/Permissives > Label text.**

Run permissive features include the following:

- With no run command issued and run permissive not satisfied, no warning is displayed.
- With a start command issued and run permissive not satisfied, the drive displays a warning that the run permissive is missing, the status LED will flash green, and the control panel's direction arrow is dashed and rotating. The drive remains in running mode, but does not output to the motor until run permissive is satisfied.
- During normal operation of the motor, if run permissive changes state, the drive will coast to stop and display a warning that run permissive is keeping the drive from outputting to the motor.
- Relay settings that are not affected by run permissive input not being satisfied include: Ready run, Enabled, Started, Running, and Damper control. Relay settings that are affected by run permissive include: Warning and Fault/Warning.

Settings and diagnostics

- **Menu > Primary settings > Start, stop, reference > Interlocks/permissives**
- Parameter [20.40 Run permissive](#) (page [427](#))
- Warnings [AFED Run permissive](#) and [AFF2 Run permissive forced warning](#).

■ Application example 1: Damper end switch

The run permissive function is used in damper control to monitor the damper status through the damper end switch. Sequence of operation:

1. Drive receives start command, either via Hand or Auto source.
2. Drive verifies safeties are satisfied and end switch has not yet been satisfied.
3. Drive activates a relay output that was programmed to Damper control. This relay allows power to the actuator.
4. Once the damper end switch closes, run permissive is satisfied and the drive outputs to the motor.

See the figure on page [386](#) and [Application example 3: Supply fan, speed follower complete integration](#) (page [135](#)).

■ Application example 2: Valve opening

The Run permissive function is used in valve control to prevent the pump from running until the valve is opened. Sequence of operation:

1. Drive receives start command, either via Hand or Auto source.
2. Drive verifies safeties are satisfied and valve position has not yet been satisfied.
3. Drive activates a relay output that was programmed to Valve opening (could have also been programmed to Started or Running). This relay allows power to the actuator.
4. Once the valve is opened, run permissive is satisfied and the drive outputs to the motor.

Motor control

■ Frequency control mode

The motor follows a frequency reference given to the drive. Frequency control is available in both local and external control. It is supported in scalar motor control only.

Frequency control uses frequency reference chain. Select frequency reference with parameters in group [28 Frequency reference chain](#) on page [457](#).

■ Scalar motor control

Scalar motor control is the default motor control method. In scalar control mode, the drive is controlled with a frequency reference. However, the excellent performance of vector control is not achieved in scalar control.

It is recommended to activate scalar motor control mode in the following situations:

- If the exact nominal motor values are not available or the drive needs to run different motor after the commissioning phase
- If a short commissioning time is needed or no ID run is wanted
- In multimotor systems: 1) if the load is not equally shared between the motors, 2) if the motors are of different sizes, or 3) if the motors are going to be changed after motor identification (ID run)
- If the nominal current of the motor is less than 1/6 of the nominal output current of the drive
- If the drive is used without a motor connected (for example, for test purposes)
- If the drive is equipped with a sine filter.

In scalar control, some standard features are not available.

See also section [Operating modes of the drive](#) (page [105](#)).

IR compensation for scalar motor control

R compensation (also known as voltage boost) is available only when the motor control mode is scalar. When IR compensation is activated, the drive gives an extra voltage boost to the motor at low speeds. IR compensation is useful in applications, such as positive displacement pumps, that require a high break-away torque.

In vector control, no IR compensation is possible or needed as it is applied automatically.

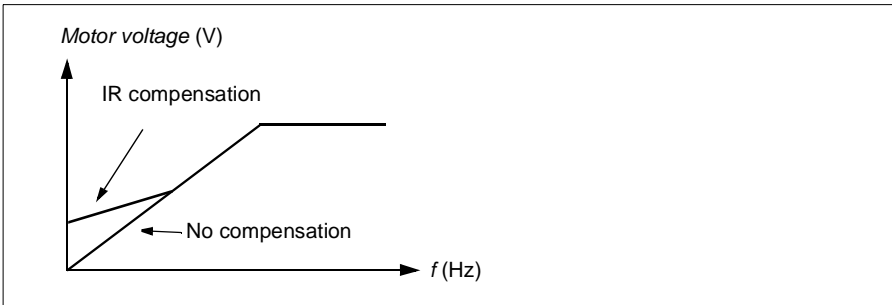

Settings

- **Menu > Primary settings > Motor > IR compensation**
- Parameters [97.13 IR compensation](#) (page 620), [97.94 IR comp max frequency](#) (page 621) and [99.04 Motor control mode](#) (page 623)
- Parameter group [28 Frequency reference chain](#) (page 457).

6

Speed control mode

The motor follows a speed reference given to the drive. This mode can be used with estimated speed used as feedback.

Speed control mode is available in both local and external control. It is supported in vector motor control only.

Speed control uses speed reference chain. Select speed reference with parameters in group [22 Speed reference selection](#) on page 439.

Vector motor control

Vector control is the motor control mode that is intended for applications where high control accuracy is needed. It offers better control over whole speed range, in particular in applications where slow speed with high torque is needed. It requires an identification run at startup. Vector control cannot be used in all applications, for example, when sine filters are being used or there are multiple motors connected to single drive.

The switching of the output semiconductors is controlled to achieve the required stator flux and motor torque. The reference value for the torque controller comes from the speed controller.

Stator flux is calculated by integrating the motor voltage in vector space. Rotor flux can be calculated from stator flux and the motor model. Motor torque is produced by controlling current 90 degrees from the rotor flux. By utilizing the identified motor

model, the rotor flux estimate is improved. Actual motor shaft speed is not needed for the motor control.

Settings

- **Menu > Primary settings > Motor > Control mode**
- Parameters [99.04 Motor control mode](#) (page 623) and [99.13 ID run requested](#) (page 626)

■ Motor types

The drive supports asynchronous AC induction, permanent magnet (PM) and synchronous reluctance motors (SynRM).

■ Motor identification

The performance of vector control is based on an accurate motor model determined during the motor start-up.

A motor identification magnetization is automatically performed the first time the start command is given. During this first start-up, the motor is magnetized at zero speed for several seconds and the motor and motor cable resistance are measured to allow the motor model to be created. This identification method is suitable for most applications.

In demanding applications a separate Identification run (ID run) can be performed.

Settings

- **Menu > Primary settings > Motor > Control mode > Vector control**
- Parameter [99.13 ID run requested](#) (page 626).

■ U/f ratio

The *U/f* function is only available in scalar motor control mode, which uses frequency control.

The function has two modes: linear and squared.

In linear mode, the ratio of voltage to frequency is constant below the field weakening point. This is used in constant torque applications where it may be necessary to produce torque at or near the rated torque of the motor throughout the frequency range

In squared mode (default), the ratio of the voltage to frequency increases as the square of the frequency below the field weakening point. This is typically used in centrifugal pump or fan applications. For these applications, the torque required follows the square relationship with frequency. Therefore, if the voltage is varied using the square relationship, the motor operates at improved efficiency and lower noise levels in these applications. Thus using squared mode saves energy.

The U/f function cannot be used with energy optimization; if parameter [45.11 Energy optimizer](#) is set to *Enable*, parameter [97.20 U/F ratio](#) is ignored.

Settings

- **Menu > Primary settings > Motor > U/f ratio**
- Parameter [97.20 U/F ratio](#) (page [620](#)).

Flux braking

The drive can provide greater deceleration by raising the level of magnetization in the motor. By increasing the motor flux, the energy generated by the motor during braking can be converted to motor thermal energy.

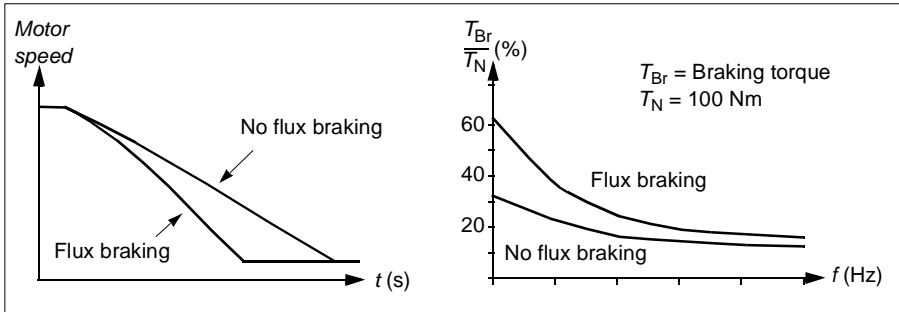

The drive monitors the motor status continuously, also during flux braking. Therefore, flux braking can be used both for stopping the motor and for changing the speed. The other benefits of flux braking are:

- The braking starts immediately after a stop command is given. The function does not need to wait for the flux reduction before it can start the braking.
- The cooling of the induction motor is efficient. The stator current of the motor increases during flux braking, not the rotor current. The stator cools much more efficiently than the rotor.
- Flux braking can be used with induction motors and permanent magnet synchronous motors.

Two braking power levels are available:

- Moderate braking provides faster deceleration compared to a situation where flux braking is disabled. The flux level of the motor is limited to prevent excessive heating of the motor.
- Full braking exploits almost all available current to convert the mechanical braking energy to motor thermal energy. Braking time is shorter compared to moderate braking. In cyclic use, motor heating may be significant.



WARNING: The motor needs to be rated to absorb the thermal energy generated by flux braking.

Settings

- **Menu > Primary settings > Motor > Flux braking**
- Parameter [97.05 Flux braking](#) (page 619).

■ Start methods – DC magnetization

The drive has different magnetization functions for different phases of motor start/rotation/stop: pre-heating (motor heating), pre-magnetization, DC hold and post-magnetization.

Pre-heating (Motor heating)

The pre-heating function keeps the motor warm and prevents condensation inside the motor by feeding it with DC current when the drive has been stopped. The heating can only be on when the drive is in the stopped state, and starting the drive stops the heating.

When pre-heating is activated and the stop command is given, pre-heating starts immediately if the drive is running below the zero speed limit (see bit 0 in parameter [06.19 Speed control status word](#)). If the drive is running above the zero speed limit, pre-heating is delayed by the time defined by parameter [21.15 Pre-heating time delay](#) to prevent excessive current.

The function can be defined to be always active when the drive is stopped or it can be activated by a digital input, fieldbus, timed function or supervision function. For example, with the help of signal supervision function, the heating can be activated by a thermal measurement signal from the motor.

The pre-heating current fed to the motor can be defined as 0...30% of the nominal motor current.

Notes:

- In applications where the motor keeps rotating for a long time after the modulation is stopped, it is recommended to use ramp stop with pre-heating to prevent a sudden pull at the rotor when the pre-heating is activated.
- The heating function requires that the STO circuit is closed or not triggered open.
- The heating function requires that the drive is not faulted.
- The heating function is allowed even if Run permissive signal is missing.
- The heating function is allowed even if one or more Start interlock signals are missing.
- Pre-heating uses DC hold to produce current.

Settings

- **Menu > Primary settings > Motor > Pre-heating**
- Parameters [21.14 Pre-heating input source](#), [21.15 Pre-heating time delay](#) and [21.16 Pre-heating current](#) (page 434).

Pre-magnetization

Pre-magnetization refers to DC magnetization of the motor before start. Depending on the selected start mode ([21.01 Start mode](#) or [21.19 Scalar start mode](#)), pre-magnetization can be applied to guarantee the highest possible breakaway torque, up to 200% of the nominal torque of the motor. By adjusting the pre-magnetization time ([21.02 Magnetization time](#)), it is possible to synchronize the motor start and, for example, the release of a mechanical brake.

Settings

- Parameters [21.01 Start mode](#), [21.19 Scalar start mode](#), [21.02 Magnetization time](#).

DC hold

The function makes it possible to lock the rotor at (near) zero speed in the middle of normal operation. DC hold is activated by parameter [21.08 DC current control](#). When both the reference and motor speed drop below a certain level (parameter [21.09 DC hold speed](#)), the drive will stop generating sinusoidal current and start to inject DC into the motor. The current is set by parameter [21.10 DC current reference](#). When the reference exceeds parameter [21.09 DC hold speed](#), normal drive operation continues.

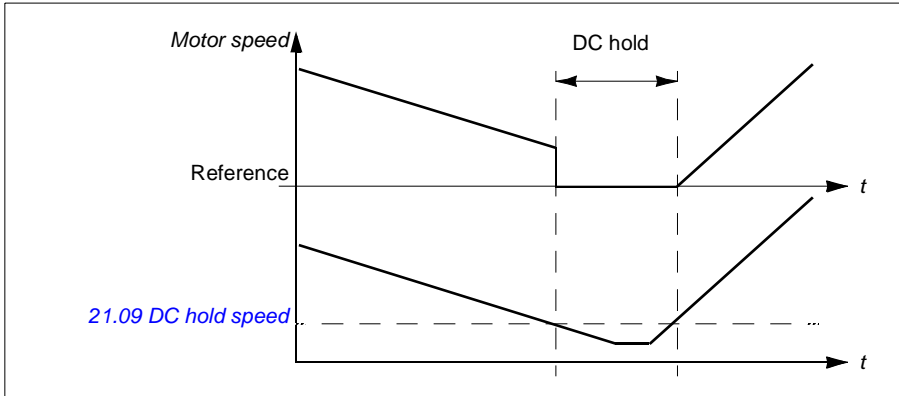

Settings

- Parameters [21.08 DC current control](#) and [21.09 DC hold speed](#).

DC brake

This function enables DC injection braking after modulation has stopped for a certain period ([21.11 Post magnetization time](#)). DC injection braking can be used to quickly stop the motor without using a mechanical brake. DC brake is activated by parameter [21.08 DC current control](#). The DC braking current is set by parameter [21.10 DC current reference](#).

Post-magnetization

The function keeps the motor magnetized for a certain period (parameter [21.11 Post magnetization time](#)) after stopping. This is to prevent the machinery from moving under load, for example, before a mechanical brake can be applied. Post-magnetization is activated by parameter [21.08 DC current control](#). The magnetization current is set by parameter [21.10 DC current reference](#).

Note: Post-magnetization is only available when ramp stop is selected (see parameter [21.03 Stop mode](#)).

Settings

- Parameters [21.03 Stop mode](#) (page 431), [21.08 DC current control](#) and [21.11 Post magnetization time](#).

Switching frequency

The drive has two switching frequencies: reference switching frequency and minimum switching frequency. The drive tries to keep the highest allowed switching frequency (= reference switching frequency) if thermally possible, and then adjusts dynamically between the reference and minimum switching frequencies depending on the drive temperature. When the drive reaches the minimum switching frequency (= lowest allowed switching frequency), it starts to limit output current as the heating up continues.

For derating, see chapter *Technical data*, section *Switching frequency derating* in the *Hardware manual* of the drive.

Example 1: If you need to fix the switching frequency to a certain value as with some external filters, for example, with EMC C1 filters (see the *Hardware manual* of the drive), set both the reference and the minimum switching frequency to this value and the drive will retain this switching frequency.

Example 2: If the reference switching frequency is set to 8 kHz and the minimum switching frequency is set to the smallest available value, the drive maintains the highest possible switching frequency to reduce motor noise and only when the drive heats it will decrease the switching frequency. This is useful, for example, in applications where low noise is necessary but higher noise can be tolerated when the full output current is needed.

Settings

- Menu > Primary settings > Motor > Switching frequency**
- Parameters [97.01 Switching frequency reference](#) and [97.02 Minimum switching frequency](#) (page 604).

■ Motor thermal protection

The control program features two separate motor temperature monitoring functions. The temperature data sources and warning/trip limits can be set up independently for each function.

The motor temperature can be monitored using

- the motor thermal protection model (estimated temperature derived internally inside the drive), or
- sensors installed in the windings. This will result in a more accurate motor model.

Motor thermal protection model

The drive calculates the temperature of the motor on the basis of the following assumptions:

1. When power is applied to the drive for the first time, the motor is assumed to be at ambient temperature (defined by parameter *35.50 Motor ambient temperature*). After this, when power is applied to the drive, the motor is assumed to be at the estimated temperature.
2. Motor temperature is calculated using the user-adjustable motor thermal time and motor load curve. The load curve should be adjusted in case the ambient temperature exceeds 30 °C.

Note: The motor thermal model can be used when only one motor is connected to the drive.

Insulation



WARNING! IEC 60664 requires double or reinforced insulation between live parts and the surface of accessible parts of electrical equipment which are either non-conductive or conductive but not connected to the protective earth.

To fulfil this requirement, connect a thermistor to the drive's control terminals using any of these alternatives:

- Separate the thermistor from live parts of the motor with double reinforced insulation.
- Protect all circuits connected to the drive's digital and analog inputs. Protect against contact, and insulate from other low voltage circuits with basic insulation (rated for the same voltage level as the drive's main circuit).
- Use an external thermistor relay. The relay insulation must be rated for the same voltage level as the drive's main circuit.

When analog output is not available or used for other purposes, it is possible to set up a voltage divider utilizing internal resistance of a digital input. 1...3 PTC sensors are connected in series to 10V reference and digital and analog inputs. The temperature

measurement function reads the voltage over the sensor from the analog input and calculates the resistance.

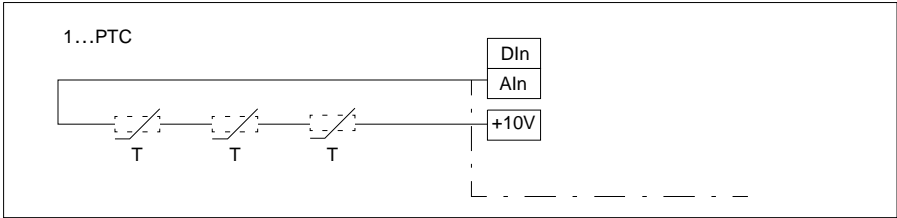

Note: It is important to ensure that the DI used for this is not configured to start any action.

Temperature monitoring using Pt100 sensors

1...3 Pt100 sensors can be connected in series to an analog input and an analog output.

The analog output feeds a constant excitation current of 9.1 mA through the sensor. The sensor resistance increases as the motor temperature rises, as does the voltage over the sensor. The temperature measurement function reads the voltage through the analog input and converts it into degrees Celsius.

It is possible to adjust the motor temperature supervision limits and select how the drive reacts when overtemperature is detected.

See section [Insulation](#) on page 188.

For the wiring of the sensor, see [AI1 and AI2 as Pt100, Pt1000, Ni1000, KTY83 and KTY84 sensor inputs](#) on page 192.

Temperature monitoring using Pt1000 sensors

1...3 Pt1000 sensors can be connected in series to an analog input and an analog output.

The analog output feeds a constant excitation current of 0.1 mA through the sensor. The sensor resistance increases as the motor temperature rises, as does the voltage over the sensor. The temperature measurement function reads the voltage through the analog input and converts it into degrees Celsius.

See section [Insulation](#) on page 188.

For the wiring of the sensor, see [AI1 and AI2 as Pt100, Pt1000, Ni1000, KTY83 and KTY84 sensor inputs](#) on page 192.

Temperature monitoring using Ni1000 sensors

One Ni1000 sensor can be connected to an analog input and an analog output on the control unit.

The analog output feeds a constant excitation current of 9.1 mA through the sensor. The sensor resistance increases as the motor temperature rises, as does the voltage over the sensor. Resistance at 100 degrees Celsius is 1618 ohm, and the rate of change is 6180 ppm / degrees Celsius. The temperature measurement function reads the voltage through the analog input and converts it into degrees Celsius.

See section [Insulation](#) on page 188.

For the wiring of the sensor, see section [AI1 and AI2 as Pt100, Pt1000, Ni1000, KTY83 and KTY84 sensor inputs](#) on page 192.

Temperature monitoring using KTY84 sensors

One KTY84 sensor can be connected to an analog input and an analog output on the control unit.

The analog output feeds a constant excitation current of 2.0 mA through the sensor. The sensor resistance increases as the motor temperature rises, as does the voltage over the sensor. The temperature measurement function reads the voltage through the analog input and converts it into degrees Celsius.

6

The figure and table on page 191 show typical KTY84 sensor resistance values as a function of the motor operating temperature.

See section [Insulation](#) on page 188.

For the wiring of the sensor, see section [AI1 and AI2 as Pt100, Pt1000, Ni1000, KTY83 and KTY84 sensor inputs](#) on page 192.

Temperature monitoring using KTY83 sensors

One KTY83 sensor can be connected to an analog input and an analog output on the control unit.

The analog output feeds a constant excitation current of 1.0 mA through the sensor. The sensor resistance increases as the motor temperature rises, as does the voltage over the sensor. The temperature measurement function reads the voltage through the analog input and converts it into degrees Celsius.

The figure and table below show typical KTY83 sensor resistance values as a function of the motor operating temperature.

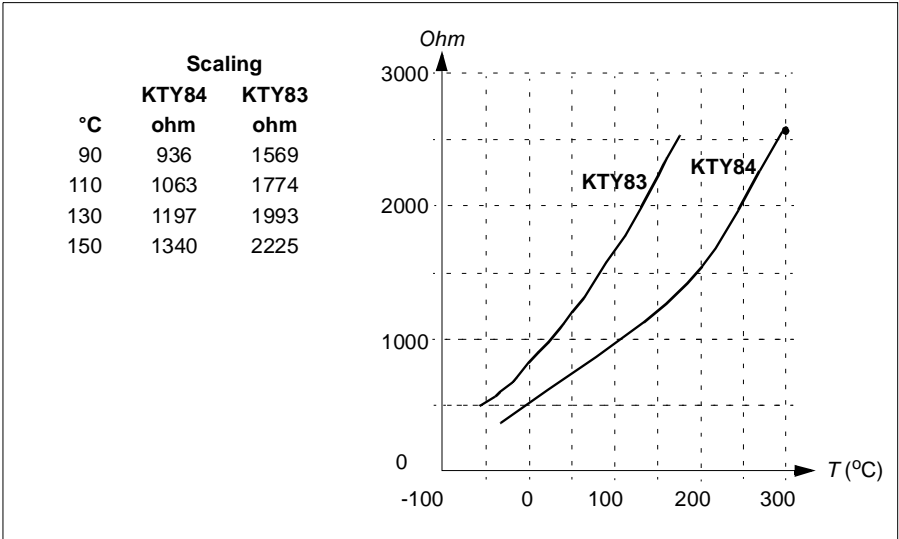

It is possible to adjust the motor temperature supervision limits and select how the drive reacts when overtemperature is detected.

See section [Insulation](#) on page 188.

For the wiring of the sensor, see section [AI1 and AI2 as Pt100, Pt1000, Ni1000, KTY83 and KTY84 sensor inputs](#) on page 192.

AI1 and AI2 as Pt100, Pt1000, Ni1000, KTY83 and KTY84 sensor inputs

One, two or three Pt100 sensors; one, two or three Pt1000 sensors; or one Ni1000, KTY83 or KTY84 sensor for motor temperature measurement can be connected between an analog input and output as shown below. Do not connect both ends of the cable shields directly to ground. If a capacitor cannot be used at one end, leave that end of the shield unconnected.

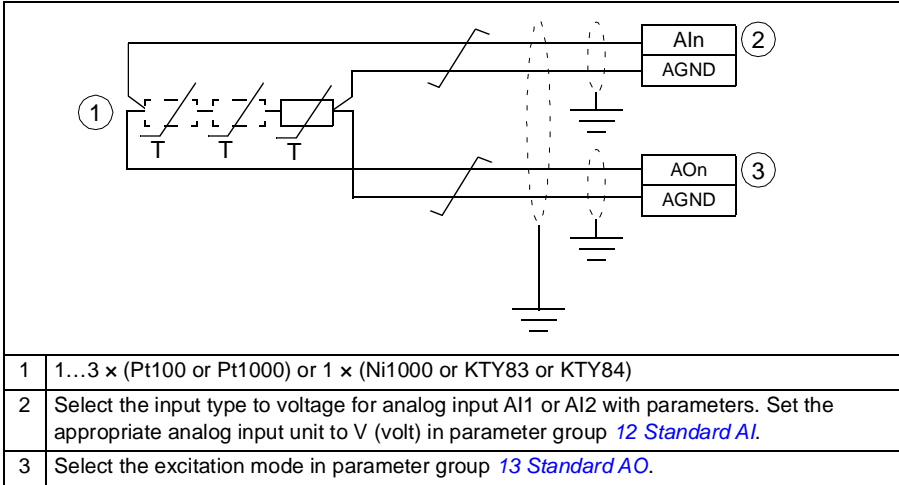

WARNING! As the inputs pictured above are not insulated according to IEC 60664, the connection of the motor temperature sensor requires double or reinforced insulation between motor live parts and the sensor. If the assembly does not fulfill the requirement, the I/O board terminals must be protected against contact and must not be connected to other equipment or the temperature sensor must be isolated from the I/O terminals.

Temperature monitoring using thermistor relays

A normally closed or a normally open thermistor relay can be connected to digital input DI6.

See section [Insulation](#) on page 188.

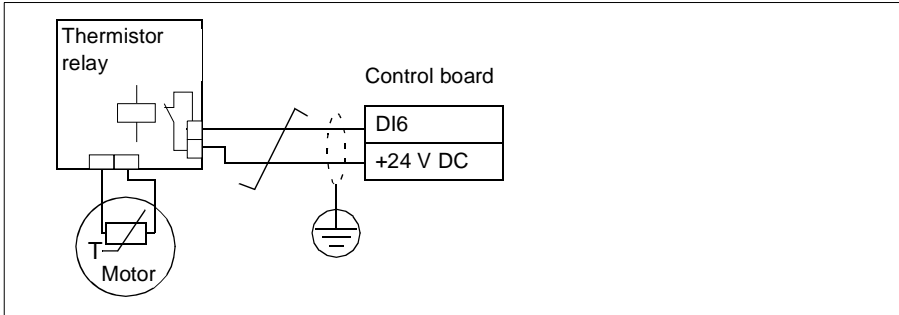

Settings

- **Menu > Primary settings > Motor > Thermal protection estimated**
- **Menu > Primary settings > Motor > Thermal protection measured**
- Parameter group [35 Motor thermal protection](#) (page 504).

■ Motor overload protection

This section describes motor overload protection without using motor thermal protection model, either with estimated or measured temperature. For protection with the motor thermal protection model, see section [Motor thermal protection](#) on page 188.

Motor overload protection is required and specified by multiple standards including the US National Electric Code (NEC), UL 508C and the common UL/IEC 61800-5-1 standard in conjunction with IEC 60947-4-1. The standards allow for motor overload protection without external temperature sensors.

The protection feature allows the user to specify the class of operation in the same manner as the overload relays are specified in standards IEC 60947-4-1 and NEMA ICS 2.

Motor overload protection requires that you specify a motor current tripping level. This is defined by a curve using parameters [35.51 Motor load curve](#), [35.52 Zero speed load](#) and [35.53 Break point](#). The tripping level is the motor current at which the overload protection will ultimately trip if the motor current remains at this level continuously.

The motor overload class (class of operation), parameter [35.57 Motor overload class](#), is given as the time required for the overload relay to trip when operating at 7.2 times the tripping level in the case of IEC 60947-4-1 and 6 times the tripping level in the case of NEMA ICS 2. The standards also specify the time to trip for current levels

between the tripping level and the 6 times tripping level. The drive satisfies the IEC standard and NEMA standard trip times.

Using class 20 satisfies the UL 508C requirements.

The motor overload algorithm monitors the squared ratio (motor current / tripping level)² and accumulates this over time. This is sometimes referred to as I^2t protection. The accumulated value is shown with parameter [35.05 Motor overload level](#).

You can define with parameter [35.56 Motor overload action](#) that when [35.05 Motor overload level](#) reaches 88%, a motor overload warning will be generated, and when it reaches 100%, the drive will trip on the motor overload fault. The rate at which this internal value is increased depends on the actual current, tripping level current and overload class selected.

Parameters [35.51 Motor load curve](#), [35.52 Zero speed load](#) and [35.53 Break point](#) serve a dual purpose. They determine the load curve for temperature estimate when using motor thermal protection model as well as specify the overload tripping level.

6

Motor overload protection fulfills standard IEC/EN 61800-5-1 ed. 2.1 requirements for thermal memory retention and speed sensitivity. The motor overload state is retained over power down. Speed dependency is set by parameters [35.51 Motor load curve](#), [35.52 Zero speed load](#) and [35.53 Break point](#).

Settings

- Parameters common to motor thermal protection and motor overload protection: [35.51 Motor load curve](#) (page 512), [35.52 Zero speed load](#) (page 512) and [35.53 Break point](#) (page 512).
 - Parameters specific to motor overload protection: [35.05 Motor overload level](#) (page 505), [35.56 Motor overload action](#) (page 514) and [35.57 Motor overload class](#) (page 514).
-

Speed control performance figures

The table below shows typical performance figures for speed control.

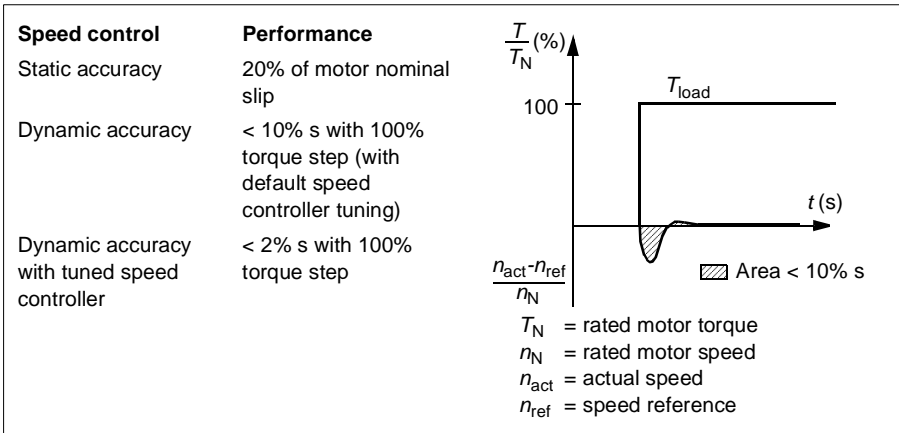

Floating point control (Motor potentiometer)

The Floating point control (parameters are named Motor potentiometer, however) is, in effect, a counter whose value can be adjusted up and down using two digital signals selected by parameters [22.73 Motor potentiometer up source](#) and [22.74 Motor potentiometer down source](#). When the Floating point control is enabled by [22.71 Motor potentiometer function](#), the counter assumes the value set by [22.72 Motor potentiometer initial value](#). Depending on the mode selected in [22.71](#), the counter value is either retained or reset over a power cycle.

The change rate is defined in [22.75 Motor potentiometer ramp time](#) as the time it would take for the value to change from the minimum ([22.76 Motor potentiometer min value](#)) to the maximum ([22.77 Motor potentiometer max value](#)) or vice versa. If the up and down signals are simultaneously on, the counter value does not change.

The output of the Floating point control counter is shown by [22.80 Motor potentiometer ref act](#), which can directly be set as the reference source in the main selector parameters, or used as an input by other source selector parameters, both in scalar and vector control.

Note: Parameter [22.70 Motor potentiometer reference enable](#) should be set appropriately (see the parameter description) to ensure that parameter [22.80 Motor potentiometer ref act](#) is increased/decreased by [22.73 Motor potentiometer up source](#) or [22.74 Motor potentiometer down source](#).

The following example shows the behavior of the Floating point control counter value.

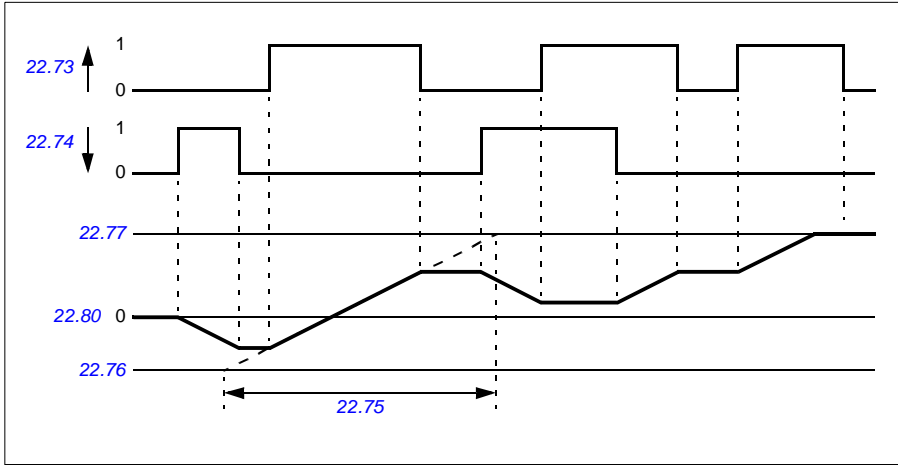

6

Parameters *22.73 Motor potentiometer up source* and *22.74 Motor potentiometer down source* control speed or frequency from zero to maximum speed or frequency. The running direction can be changed with parameter *20.04 Ext1 in2 source*. See the following example.

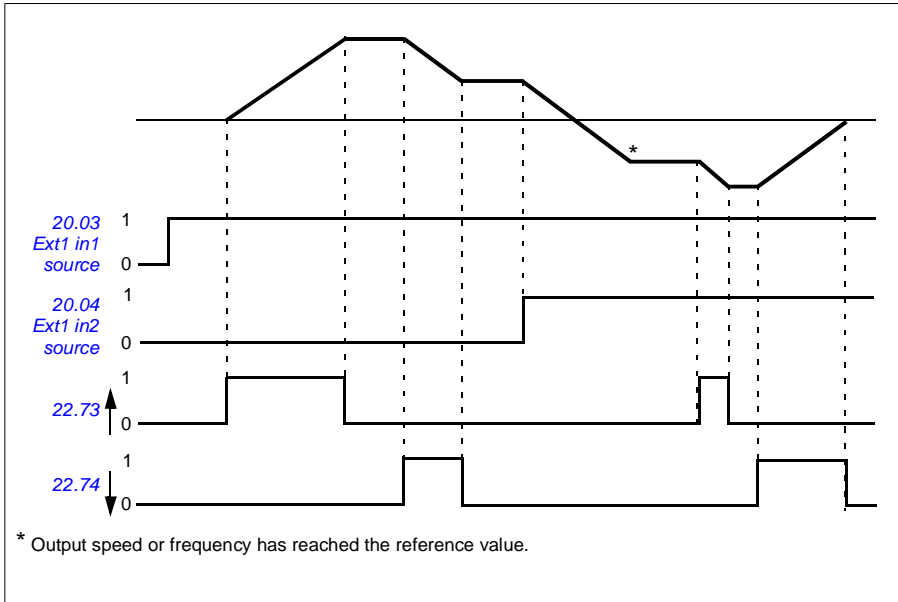

Settings

- Parameters [22.71 Motor potentiometer function...22.80](#)
- [22.80 Motor potentiometer ref act](#) (page 447).

DC voltage control

Overvoltage control

Overvoltage control of the intermediate DC link is typically needed when the motor is in generating mode. The motor can generate when it decelerates or when the load overhauls the motor shaft, causing the shaft to turn faster than the applied speed or frequency. To prevent the DC voltage from exceeding the overvoltage control limit, the overvoltage controller automatically decreases the generating torque when the limit is reached. The overvoltage controller also increases any programmed deceleration times if the limit is reached; to achieve shorter deceleration times, a brake chopper and resistor may be required.

Undervoltage control (power loss ride-through)

If the incoming supply voltage is cut off, the drive will continue to operate by utilizing the kinetic energy of the rotating motor. The drive will be fully operational as long as the motor rotates and generates energy to the drive. The drive can continue operation after the break if the main contactor (if present) remained closed.

6

Note: Units equipped with a main contactor must be equipped with a hold circuit (for example, UPS) to keep the contactor control circuit closed during a short supply break.

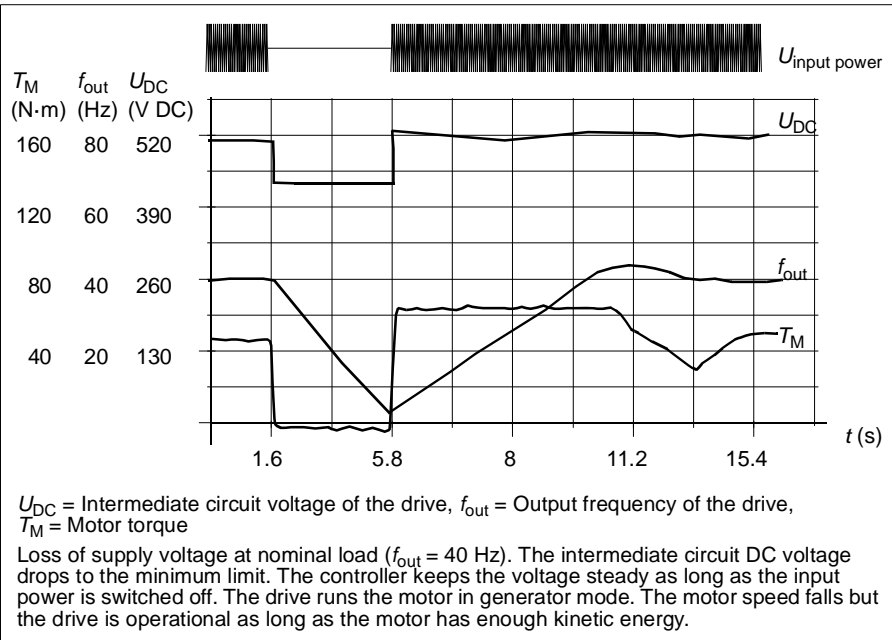

Implementing the undervoltage control (power loss ride-through)

Implement the undervoltage control function as follows:

- Check that the undervoltage control function of the drive is enabled with parameter [30.31 Undervoltage control](#).
- Parameter [21.01 Start mode](#) must be set to *Automatic* (in vector mode) or parameter [21.19 Scalar start mode](#) to *Automatic* (in scalar mode) to make flying start (starting into a rotating motor) possible.

If the installation is equipped with a main contactor, prevent its tripping at the input power break. For example, use a time delay relay (hold) in the contactor control circuit.



WARNING! Make sure that the flying restart of the motor will not cause any danger. If you are in doubt, do not implement the undervoltage control function.

Automatic restart

It is possible to restart the drive automatically after a short (max. 10 seconds) power supply failure by using the Automatic restart function, provided that the drive is allowed to run for 10 seconds without the cooling fans operating.

When enabled, the function takes the following actions upon a supply failure to a successful restart:

- The undervoltage fault is suppressed (but a warning is generated).
- Modulation and cooling is stopped to conserve any remaining energy.
- DC circuit pre-charging is enabled.

If the DC voltage is restored before the expiration of the period defined by parameter [21.18 Auto restart time](#) and the start signal is still on, normal operation will continue. However, if the DC voltage remains too low at that point, the drive trips on a fault, [3220 DC link undervoltage](#).

If parameter [21.34 Force auto restart](#) is set to *Enable*, the drive never trips on the undervoltage fault and the start signal is on forever. When the DC voltage is restored, the normal operation continues.



WARNING! Before you activate the function, make sure that no dangerous situations can occur. The function restarts the drive automatically and continues operation after a supply break.

■ Voltage control and trip limits

The control and trip limits of the intermediate DC voltage regulator are relative to the supply voltage as well as drive/inverter type. The DC voltage (U_{DC}) is approximately

1.41 times the line-to-line supply voltage, and is displayed by parameter [01.11 DC voltage](#).

The system calculates the necessary drive DC limits from parameters [95.01 Supply voltage](#) and [95.02 Adaptive voltage limits](#).

DC voltage levels for drive types -01 and -04

The following table shows the values of selected DC voltage levels. Note that the absolute voltages vary according to the drive/inverter type and AC supply voltage range.

Adaptive voltage limit enabled by parameter [95.02 Adaptive voltage limits](#)

DC voltage level [V] See 95.01 Supply voltage .	95.01 Supply voltage				Automatic / Not selected
	AC supply voltage range [V] 208...240	AC supply voltage range [V] 380...415	AC supply voltage range [V] 440...480	AC supply voltage range [V] 525...600	
Overvoltage fault limit	421	842	842	1053	842
Overvoltage control limit	389	779	779	974	779
Internal brake chopper start limit	389	779	779	974	779
Internal brake chopper stop limit	379	759	759	949	759
Overvoltage warning limit	372	745	745	931	745
Undervoltage warning limit	0.85 x 1.41 x par 95.03 value	0.85 x 1.41 x par 95.03 value	0.85 x 1.41 x par 95.03 value	0.85 x 1.41 x par 95.03 value	0.85 x 1.41 x par 95.03 value
Undervoltage control limit	0.78 x 1.41 x par 95.03 value	0.78 x 1.41 x par 95.03 value	0.78 x 1.41 x par 95.03 value	0.78 x 1.41 x par 95.03 value	0.78 x 1.41 x par 95.03 value
Charging relay closing limit / charging deactivation	0.78 x 1.41 x par 95.03 value	0.78 x 1.41 x par 95.03 value	0.78 x 1.41 x par 95.03 value	0.78 x 1.41 x par 95.03 value	0.78 x 1.41 x par 95.03 value
Charging relay opening limit / charging activation	0.73 x 1.41 x par 95.03 value	0.73 x 1.41 x par 95.03 value	0.73 x 1.41 x par 95.03 value	0.73 x 1.41 x par 95.03 value	0.73 x 1.41 x par 95.03 value
DC voltage at upper bound of supply voltage range (U_{DCmax})	324	560	648	810	(variable)
DC voltage at lower bound of supply voltage range (U_{DCmin})	281	513	594	709	(variable)
Standby limit ³⁾	0.73 x 1.41 x par 95.03 value	0.73 x 1.41 x par 95.03 value	0.73 x 1.41 x par 95.03 value	0.73 x 1.41 x par 95.03 value	0.73 x 1.41 x par 95.03 value
Charging relay opening limit / charging activation	0.73 x 1.41 x par 95.03 value	0.73 x 1.41 x par 95.03 value	0.73 x 1.41 x par 95.03 value	0.73 x 1.41 x par 95.03 value	0.73 x 1.41 x par 95.03 value

Note: Parameter [95.03 Estimated AC supply voltage](#) is the estimated AC supply voltage while powering up the drive and it will not be continuously updated during run time.

Adaptive voltage limit disabled by parameter [95.02 Adaptive voltage limits](#)

DC voltage level [V] See 95.01 Supply voltage .	95.01 Supply Voltage					
	AC supply voltage range [V] 208...240	AC supply voltage range [V] 380...415	AC supply voltage range [V] 440...480	AC supply voltage range [V] 525...600	Automatic / Not selected	
					if 95.03 < 456 V AC	if 95.03 > 456 V AC
Overvoltage fault limit	421	842	842	1053	842	842
Overvoltage control limit	389	779	779	974	779	779
Internal brake chopper start limit	389	779	779	974	779	779
Internal brake chopper stop limit	379	759	759	949	759	759
Overvoltage warning limit	372	745	745	931	745	745
Undervoltage warning limit	0.85 x 1.35 x 208 = 239	0.85 x 1.35 x 380 = 436	0.85 x 1.35 x 440 = 504	0.85 x 1.35 x 525 = 602	0.85 x 1.35 x 380 = 436	0.85 x 1.35 x 440 = 505
Undervoltage control limit	0.78 x 1.35 x 208 = 219	0.78 x 1.35 x 380 = 400	0.78 x 1.35 x 440 = 463	0.78 x 1.35 x 525 = 553	0.78 x 1.35 x 380 = 400	0.78 x 1.35 x 440 = 463
Charging relay closing limit / charging deactivation	0.78 x 1.35 x 208 = 219	0.78 x 1.35 x 380 = 400	0.78 x 1.35 x 440 = 463	0.78 x 1.35 x 525 = 553	0.78 x 1.35 x 380 = 400	0.78 x 1.35 x 440 = 463
Charging relay opening limit / charging activation	0.73 x 1.35 x 208 = 205	0.73 x 1.35 x 380 = 374	0.73 x 1.35 x 440 = 433	0.73 x 1.35 x 525 = 517	0.73 x 1.35 x 380 = 374	0.73 x 1.35 x 440 = 433
DC voltage at upper bound of supply voltage range (U_{DCmax})	324	560	648	810	(variable)	(variable)
DC voltage at lower bound of supply voltage range (U_{DCmin})	281	513	594	709	(variable)	(variable)
Standby limit	0.73 x 1.35 x 208 = 205	0.73 x 1.35 x 380 = 374	0.73 x 1.35 x 440 = 433	0.73 x 1.35 x 525 = 517	0.73 x 1.35 x 380 = 374	0.73 x 1.35 x 440 = 433
Undervoltage fault limit ¹⁾	0.73 x 1.35 x 208 = 205	0.73 x 1.35 x 380 = 374	0.73x1.35x440 = 433	0.73 x 1.35 x 525 = 517	0.73 x 1.35 x 380 = 374	0.73 x 1.35 x 440 = 433

¹⁾ See section [Triggering the undervoltage fault](#) on page 202.

Triggering the undervoltage warning

The undervoltage warning [A3A2](#) is triggered if one of below conditions is active:

- If the DC link voltage goes below the undervoltage warning limit when the drive is not modulating.
- If the DC link voltage goes below the standby limit when the drive is modulating, and auto restart is enabled (that is, parameter [2.1.18 Auto restart time](#) > 0.0 s). The warning will continue to appear if the actual DC link voltage is continuously below the standby limit and until the auto restart time has elapsed. The drive

control board must be externally powered by 24 VDC to have this functionality, otherwise the control board may be switched off if the voltage goes below the hardware limit.

Triggering the undervoltage fault

The undervoltage fault [3220](#) is triggered if the drive is modulating and one of the below conditions is active:

- If the DC link voltage goes below the undervoltage trip limit and auto restart is not enabled (that is, parameter [21.18 Auto restart time](#) = 0.0 s).
- If the DC link voltage goes below the undervoltage trip limit and auto restart is enabled (that is, parameter [21.18 Auto restart time](#) > 0.0 s), then undervoltage trip will occur if only the DC link voltage is continuously below the undervoltage trip limit and after auto restart time has elapsed. Control board of the drive must be externally powered by 24 VDC source to have this functionality. Otherwise the control board may be switched off, just showing an undervoltage warning.

Settings

- Parameters [01.11 DC voltage](#) (page [361](#)), [30.30 Overvoltage control](#) (page [473](#)), [30.31 Undervoltage control](#) (page [474](#)), [95.01 Supply voltage](#) (page [604](#)) and [95.02 Adaptive voltage limits](#) (page [604](#)).
- Warning [A3A2 DC link undervoltage](#) (page [223](#)) and fault [3220 DC link undervoltage](#) (page [237](#)).

■ Brake chopper

A brake chopper can be used to handle the energy generated by a decelerating motor. When the DC voltage rises high enough, the chopper connects the DC circuit to an external brake resistor. The chopper operates on the pulse width modulation principle.

The internal brake choppers in the drive start conducting when the DC link voltage reaches approximately $1.15 \times U_{DCmax}$. 100% maximum pulse width is reached at approximately $1.2 \times U_{DCmax}$. (U_{DCmax} is the DC voltage corresponding to the maximum of the AC supply voltage range.) For information on external brake choppers, refer to their documentation.

Note: Overvoltage control needs to be disabled for the chopper to operate.

Settings

- Parameter [01.11 DC voltage](#) (page [361](#))
- Parameter group [43 Brake chopper](#) (page [540](#)).

Supervisory

■ Signal supervision

Six signals can be selected to be supervised by this function. Whenever a supervised signal exceeds or falls below predefined limits, a bit in [32.01 Supervision status](#) is activated, and a warning or fault generated.

The supervised signal is low-pass filtered.

Settings

- Parameter group [32 Supervision](#) (page [485](#)).

■ Application example 1: Dirty filter

The supervisory function can be used to indicate a dirty filter. Since pressure drop across the air filter increases as the filter becomes dirty, a transducer can be installed that measures the differential pressure across the filter. The transducer output signal is an analog value that is fed back to an analog input on the drive. The supervisory function in the drive is configured to monitor the analog value.

For example, the user wants to be notified when an air handler filter needs to be replaced. Starting with a published value for the drop across a clean filter, a value is established that corresponds to a dirty filter scenario. The drive is then configured to monitor the transducer's analog output signal. This includes a supervision level to indicate when a threshold for a dirty filter has been exceeded. To use this status, a drive relay output can be used instead of a separate relay to indicate the filter status. This information may also be monitored over fieldbus communications, such as BACnet.

The benefit of using the drive to accomplish this function is to eliminate the need for one analog (transducer) input on the controller, thereby resulting in reduced cost of the building automation controller for the air handler.

■ Application example 2: High current

The supervisory function can be used to monitor motor current for increasing or excessive loading. This increase in loading may be due to mechanical failure/wear. A single “high current” threshold may be used with the supervisory function. Alternately, parameter group [37 User load curve](#) (page [517](#)) can be used to detect this scenario throughout the entire speed range, as shown under [User load curve](#) (page [204](#)).

For example, a fan bearing is beginning to fail due to lack of lubrication. The bearing surfaces are beginning to bind, causing the motor current draw to exceed its normal level. The supervisory function indicates the load is drawing higher current than normal. As a result, service personnel can investigate the problem. The goal is to find the problem before a catastrophic failure occurs.

■ User load curve

The User load curve provides a supervisory function that monitors an input signal as a function of frequency or speed, and load. It shows the status of the monitored signal and can give a warning or fault based on the violation of a user defined profile.

The user load curve consists of an overload and an underload curve, or just one of them. Each curve is formed by five points that represent the monitored signal as a function of frequency or speed.

In the example below, the user load curve is constructed from the motor nominal torque to which a 10% margin is added and subtracted. The margin curves define a working envelope for the motor so that excursions outside the envelope can be supervised, timed and detected.

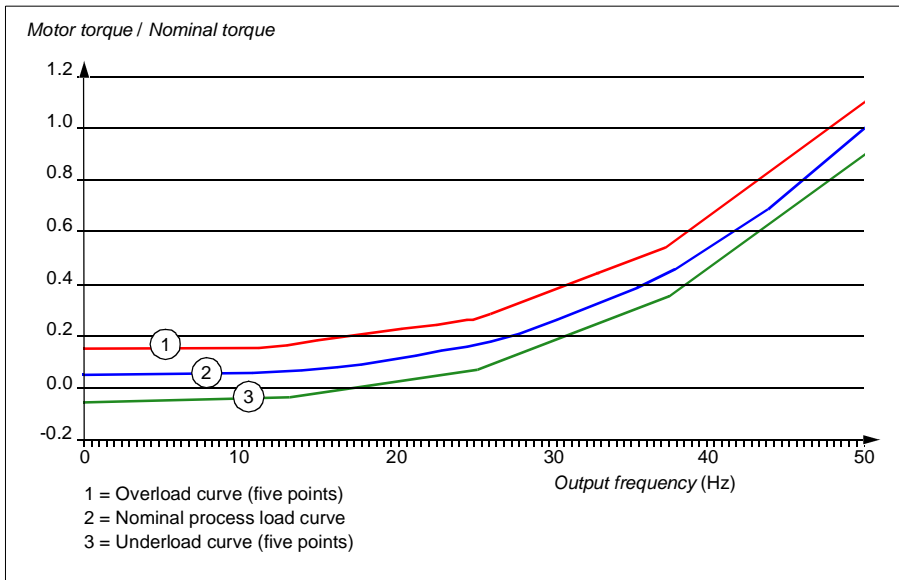

An overload warning and/or fault can be set to occur if the monitored signal stays continuously over the overload curve for a defined time. An underload warning and/or fault can be set to occur if the monitored signal stays continuously under the underload for a defined time.

Overload can be, for example, used to monitor for fan load profiles becoming too high.

Underload can be, for example, used to monitor for load dropping and breaking of conveyer belts or fan belts.

Settings

- Parameter group [37 User load curve](#) (page [517](#)).

Application example: Proof of flow

The user load curve function can be used to indicate proof of flow. Proof of flow is most commonly used for indicating a broken belt on a belt-driven fan. This drive function eliminates the need and cost for an external current-sensing relay and is more reliable. External current-sensing relays depend on the difference in motor current draw between a full-speed, no-load condition (broken belt) and a slow speed with load. This difference is minimal since the motor's magnetizing current makes up the vast majority of the motor's current consumption, which is unrelated to load. The drive's user load curve is adjustable and ideal for variable speed, variable torque, proof-of-flow applications.

For example, during commissioning of the fan, the motor torque is recorded with the belt installed and the fan operating at 50% speed. The drive control panel is capable of displaying the motor torque. See parameter [01.10 Motor torque](#) (page 361). Using this value as a reference point, a low torque threshold is determined to indicate a broken belt indication. This technique verifies that not only the drive is running the motor, but that the motor is also loaded by the application. A time delay value is available and configurable to allow for system variables. A relay output can be configured for the user load curve (proof of flow) status.

Energy efficiency

■ Energy optimization

The function optimizes the motor flux so that total energy consumption and motor noise level are reduced when the drive operates below the nominal load. The total efficiency (motor and drive) can be improved by 1...20% depending on load torque and speed. Energy optimization is enabled by default.

Note: With permanent magnet and synchronous reluctance motors, energy optimization is always enabled.

Settings

- **Menu > Energy efficiency**
- Parameter [45.11 Energy optimizer](#) (page 544).

■ Energy saving calculators

This feature consists of the following functionalities:

- An energy optimizer that adjusts the motor flux in such a way that the total system efficiency is maximized
- A counter that monitors used and saved energy by the motor and displays them in kWh, currency or volume of CO₂ emissions, and
- A load analyzer showing the load profile of the drive (see separate section on page 207).

In addition, there are counters that show energy consumption in kWh of the current and previous hour as well as the current and previous day.

The amount of energy that has passed through the drive (in either direction) is counted and shown as full GWh, MWh and kWh. The cumulative energy is also shown as full kWh. All these counters are resettable.

Note: The accuracy of the energy savings calculation is directly dependent on the accuracy of the reference motor power given in parameter [45.19 Comparison power](#).

Settings

- **Menu > Energy efficiency**
- Parameter group [45 Energy efficiency](#) (page 542)
- Parameters [01.50 Current hour kWh](#), [01.51 Previous hour kWh](#), [01.52 Current day kWh](#) and [01.53 Previous day kWh](#) (on page 362)
- Parameters [01.55 Inverter GWh counter \(resettable\)](#), [01.56 Inverter MWh counter \(resettable\)](#), [01.57 Inverter kWh counter \(resettable\)](#) and [01.58 Cumulative inverter energy \(resettable\)](#) (on page 363).

■ Load analyzer

Peak value logger

The user can select a signal to be monitored by a peak value logger. The logger records the peak value of the signal along with the time the peak occurred, as well as motor current, DC voltage and motor speed at the time of the peak. The peak value is sampled at 2 ms intervals.

Amplitude loggers

The control program has two amplitude loggers.

For amplitude logger 2, the user can select a signal to be sampled at 200 ms intervals, and specify a value that corresponds to 100%. The collected samples are sorted into 10 read-only parameters according to their amplitude. Each parameter represents an amplitude range 10 age points wide, and displays the age of the collected samples that have fallen within that range.

You can view this graphically with the assistant control panel or the Drive composer PC tool.

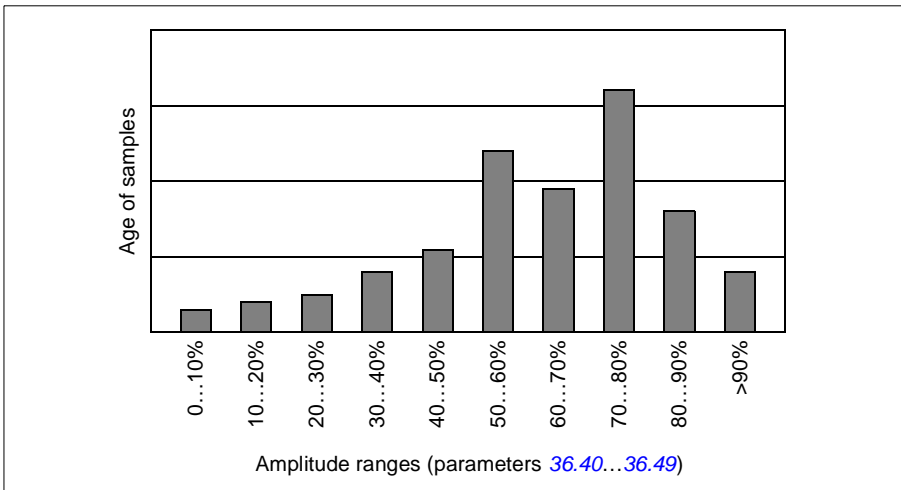

Amplitude logger 1 is fixed to monitor motor current, and cannot be reset. With amplitude logger 1, 100% corresponds to the maximum output current of the drive (I_{max}), which is listed in the *Hardware manual* of the drive. The measured current is logged continuously. The distribution of samples is shown by parameters [36.20](#)...[36.29](#).

Settings

- **Menu > Diagnostics > Load profile**
- Parameter group [36 Load analyzer](#) (page [514](#)).

User parameter sets

The drive supports four user parameter sets that can be saved to the permanent memory and recalled using drive parameters. It is possible to use digital inputs to switch between user parameter sets.

A user parameter set contains all editable values in parameter groups 10...99 except

- forced I/O values such as parameters [10.03 DI force selection](#) and [10.04 DI forced data](#)
- I/O extension module settings (group 15)
- data storage parameters (group 47)
- fieldbus communication enable parameter ([50.01 FBA A enable](#))
- other fieldbus communication settings (groups 51...53 and 58)
- some hardware settings in group [95 HW configuration](#) (for example parameter [95.01 Supply voltage](#))
- user set selection parameters [96.11...96.13](#).

6

As the motor settings are included in the user parameter sets, make sure the settings correspond to the motor used in the application before recalling a user set. In an application where different motors are used with the drive, the motor ID run needs to be performed with each motor and the results saved to different user sets. The appropriate set can then be recalled when the motor is switched.

If no parameter sets have been saved, attempting to load a set will create all sets from the currently active parameter settings.

Switching between sets is only possible with the drive stopped.

Settings

- **Menu > Primary settings > Advanced functions > User sets**
- Parameters [96.10...96.13](#) (page [609](#)).

System safety and protections

■ Fixed/Standard protections

Overcurrent

If the output current exceeds the internal overcurrent limit, the IGBTs are shut down immediately to protect the drive.

DC overvoltage

See section *Overvoltage control* on page 198.

DC undervoltage

See section *Undervoltage control (power loss ride-through)* on page 198.

Drive temperature

If the temperature rises high enough, the drive first starts to limit the switching frequency and then the current to protect itself. If it is still keeps heating up, for example, because of a fan failure, an overtemperature fault is generated.

Short circuit

In case of a short circuit, the IGBTs are shut down immediately to protect the drive.

■ Programmable protection functions

Motor phase loss detection (parameter 31.19)

The parameter selects how the drive reacts whenever a motor phase loss is detected.

Supply phase loss detection (parameter 31.21)

The parameter selects how the drive reacts whenever a supply phase loss is detected.

Safe torque off detection (parameter 31.22)

The drive monitors the status of the Safe torque off input, and this parameter selects which indications are given when the signals are lost. (The parameter does not affect the operation of the Safe torque off function itself.) For more information on the Safe torque off function, see chapter *Planning the electrical installation*, section *Implementing the Safe torque off function* in the *Hardware manual* of the drive.

Swapped supply and motor cabling (parameter 31.23)

The drive can detect if the supply and motor cables have accidentally been swapped (for example, if the supply is connected to the motor connection of the drive). The parameter selects if a fault is generated or not.

Stall protection (parameters [31.24...31.28](#))

The drive protects the motor in a stall situation. It is possible to adjust the supervision limits (current, frequency and time) and choose how the drive reacts to a motor stall condition.

Overspeed protection (parameter [31.30...31.31](#))

The user can set overspeed and overfrequency limits by specifying a margin that is added to the currently-used maximum and minimum speed or frequency limits.

Local control loss detection (parameter [49.05](#))

The parameter selects how the drive reacts to a control panel or PC tool communication break.

AI supervision (parameters [12.03...12.04](#))

The parameters select how the drive reacts when an analog input signal moves out of the minimum and/or maximum limits specified for the input. This can be due to broken I/O wiring or sensor.

6

Emergency stop

The emergency stop signal is connected to the input selected by parameter [21.05 Emergency stop source](#). An emergency stop can also be generated through fieldbus (parameter [06.01 Main control word](#), bits 0...2).

The mode of the emergency stop is selected by parameter [21.04 Emergency stop mode](#). The following modes are available:

- Off1: Stop along the standard deceleration ramp defined for the particular reference type in use
- Off2: Stop by coasting
- Off3: Stop by the emergency stop ramp defined by parameter [23.23 Emergency stop time](#).

With Off1 or Off3 emergency stop modes, the ramp-down of the motor speed can be supervised by parameters [31.32 Emergency ramp supervision](#) and [31.33 Emergency ramp supervision delay](#).

Notes:

- The installer of the equipment is responsible for installing the emergency stop devices and all additional devices needed for the emergency stop function to fulfill

the required emergency stop categories. For more information, contact your local ABB representative.

- After an emergency stop signal is detected, the emergency stop function cannot be canceled even though the signal is canceled.
- If the minimum (or maximum) torque limit is set to 0%, the emergency stop function may not be able to stop the drive.
- While the ramp-down of the motor speed is in progress due to emergency stop with mode Off1, a sudden activation of Override mode will cause the motor to immediately ramp to the override speed selection.

Settings

- Parameters [21.04 Emergency stop mode](#) (page 431), [21.05 Emergency stop source](#) (page 431), [23.23 Emergency stop time](#) (page 451), [31.32 Emergency ramp supervision](#) (page 484) and [31.33 Emergency ramp supervision delay](#) (page 485).

Diagnostics

■ Diagnostics menu

The **Diagnostics** menu provides quick information about active faults, warnings and inhibits in the drive and how to fix and reset them. It also helps you to find out why the drive is not starting, stopping or running at the desired speed.

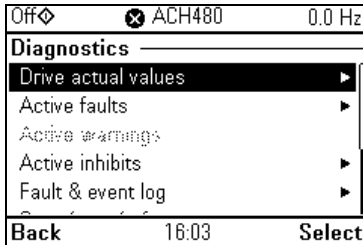

- **Drive actual values**
- **Active faults:** Use this view to see currently active faults and how to fix and reset them.
- **Active warnings:** Use this view to see currently active warnings and how to fix them.
- **Active inhibits:** Use this view to see the active inhibits and how to fix them. In addition, in the **Clock, region, display** menu you can disable (enabled by default) pop-up views showing information on inhibits when you try to start the drive but it is prevented.
- **Fault and event log:** Shows lists faults and other events.
- **Start/stop/reference summary:** Use this view to find out where the control comes from if the drive is not starting or stopping as expected, or runs at an undesired speed.
- **Limit status:** Use this view to find out whether any limitations are active if the drive is running at undesired speed.
- **Communication status:** Use this view to find out status information and sent and received data from fieldbus.
- **Motor summary:** Use this view to find out motor nominal values, control mode and whether ID run has been completed.

Settings

- **Menu > Diagnostics**
- **Menu > Primary settings > Clock, region, display > Show inhibit pop-up.**

Miscellaneous

■ Backup and restore

You can make backups of the settings manually to the assistant control panel. The assistant control panel also keeps one automatic backup. You can restore a backup to another drive, or a new drive replacing a faulty one. You can make backups and restore on the assistant control panel or with the Drive composer PC tool.

Backup

Manual backup

Make a backup when necessary, for example, after you have started up the drive or when you want to copy the settings to another drive.

Parameter changes from fieldbus interfaces are ignored unless you have forced parameter saving with parameter [96.07 Parameter save manually](#).



Automatic backup

The assistant control panel has a dedicated space for one automatic backup. An automatic backup is created two hours after the last parameter change. After completing the backup, the control panel waits for 24 hours before checking if there are additional parameter changes. If there are, it creates a new backup overwriting the previous one when two hours have passed after the latest change.

You cannot adjust the delay time or disable the automatic backup function.

Parameter changes from fieldbus interfaces are ignored unless you have forced parameter saving with parameter [96.07 Parameter save manually](#).

Restore

The backups are shown on the control panel. Automatic backups are marked with icon  and manual backups with . To restore a backup, select it and press . In the following display you can view backup contents and restore all parameters or select a subset to be restored.

Note: To restore a backup, the drive has to be in Local control.

Note: There is a risk of removing the **QR code** menu entry permanently if a backup from a drive with an old firmware or old control panel firmware is restored to a drive with a new firmware from October 2014 or later.

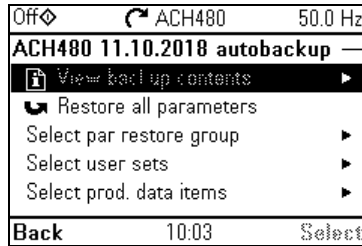
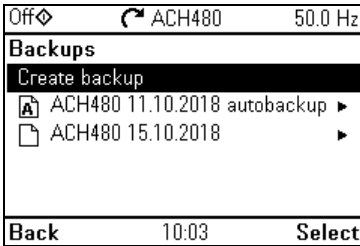

Settings

- **Menu > Backups**
- Parameter [96.07 Parameter save manually](#) (page 608).

Data storage parameters

6

Twelve (eight 32-bit, four 16-bit) parameters are reserved for data storage. These parameters are unconnected by default and can be used for linking, testing and commissioning purposes. They can be written to and read from using other parameters' source or target selections.

Settings

- Parameter group [47 Data storage](#) (page 549).

Parameter checksum calculation

Two parameter checksums, A and B, can be calculated from a set of parameters to monitor changes in the drive configuration. The sets are different for checksums A and B. Each of these checksum is compared to the corresponding reference checksum; in case of a mismatch, an event (a pure event, warning or fault) is generated. The calculated checksum can be set as the new reference checksum.

The set of parameters for checksum A does not include fieldbus settings.

The parameters included in the checksum A calculation are user editable parameters in parameter groups 10...13, 15, 19...25, 28, 30...32, 34...37, 40...41, 43, 45...46, 70...74, 76, 80, 94...99.

The set of parameters for checksum B does not include

- fieldbus settings
- motor data settings
- energy data settings.

The parameters included in the checksum B calculation are user editable parameters in parameter groups 10...13, 15, 19...25, 28, 30...32, 34, 35...37, 40...41, 43, 46, 70...74, 76, 80, 94...97.

Settings

- Parameters [96.54...96.69](#), [96.71...96.72](#) (page [613](#)).

■ User lock

For improved cybersecurity, it is highly recommended that you set a master pass code to prevent, for example, the changing of parameter values and/or the loading of firmware and other files.



WARNING! ABB will not be liable for damages or losses caused by the failure to activate the user lock using a new pass code. See [Cybersecurity disclaimer](#) (page [19](#)).

- To activate the user lock for the first time:
- Enter the default pass code, 10000000, into [96.02 Pass code](#). This will make parameters [96.100...96.102](#) visible.
- Enter a new pass code into [96.100 Change user pass code](#). Always use eight digits; if using Drive composer PC tool, finish with Enter.
- Confirm the new pass code in [96.101 Confirm user pass code](#).



WARNING! Store the pass code in a safe place – even ABB cannot open the user lock if the pass code is lost.

- In [96.102 User lock functionality](#), define the actions that you want to prevent (we recommend you select all the actions unless otherwise required by the application).
- Enter an invalid pass code into [96.02 Pass code](#).
- Activate [96.08 Control board boot](#), or cycle the power to the drive.
- Check that parameters [96.100...96.102](#) are hidden. If they are not, enter another random pass code into [96.02](#).

To reopen the lock, enter your pass code into [96.02 Pass code](#). This will again make parameters [96.100...96.102](#) visible.

Settings

- Parameters [96.02](#) (page [607](#)) and [96.100...96.102](#) (page [616](#)).
-

■ Sine filter support

With a sine filter connected to the output of the drive, the drive must use scalar motor control mode, and limit the switching and output frequencies to

- prevent the drive from operating at filter resonance frequencies, and
- protect the filter from overheating.

When using ABB sine filters (available separately), this is done automatically when you switch bit 1 of [95.15 Special HW settings](#) on.

Contact your local ABB representative before connecting a sine filter from another manufacturer.

Settings

- Parameter [95.15 Special HW settings](#) (page 604).

■ AI dead band

AI dead band value is set in parameter 12.110 (AI dead band) as a percentage of 10V in case of voltage, 20mA in case of current and applicable to both AI1 and AI2. In addition to this, 10% of the dead band value is added as a dead band hysteresis positive and negative.

- In case of voltage: AI dead band value = $10 * \text{AI dead band (parameter 12.110)} * 0.01$
- In case of current: AI dead band value = $20 * \text{AI dead band (parameter 12.110)} * 0.01$

After this, the AI dead band value is multiplied with the Hysteresis value (fixed to 10%):

- AI Hysteresis value = AI dead band value * 0.1

Example

Parameter 12.110 (AI dead band) value is set to 50%.

In case of voltage:

- AI unit selection = V
- AI max in range of 0V to 10V
- AI dead band value = $10 * 50 * 0.01 = 5V$
- AI Hysteresis value = $5 * 0.1 = 0.5V$
- Hysteresis positive value = $5 + 0.5 = 5.5V$
- Hysteresis negative value = $5 - 0.5 = 4.5V$

Now, when AI input voltage is increasing up to 5.5V, AI actual shows 0. As soon as AI input voltage reaches 5.5V, AI actual shows 5.5V and continues to detect the AI input voltage up to AI max which is in range of 0V to 10V. When AI input voltage is

decreasing, AI actual shows the actual AI applied up to 4.5V. As soon as AI input goes below 4.5V, AI actual shows 0 till input voltage reaches 0V.

In case of current:

- AI unit selection = mA
- AI max in range of 0mA to 20mA
- AI dead band value = $20 * 50 * 0.01 = 10\text{mA}$
- AI Hysteresis value = $10 * 0.1 = 1.0\text{mA}$
- Hysteresis positive value = $10 + 1.0 = 11.0\text{mA}$
- Hysteresis negative value = $10 - 1.0 = 9.0\text{mA}$

Now, when AI input current is increasing up to 11mA, AI actual shows 0mA. As soon as AI input current reaches 11.0mA, AI actual shows 11.0mA and continues to detect the AI input current up to AI max which is in range of 0mA to 20mA. When AI input current is decreasing, AI actual shows the actual AI applied up to 9.0mA. As soon as AI input goes below 9.0mA, AI actual shows 0 till input current reaches 0mA.

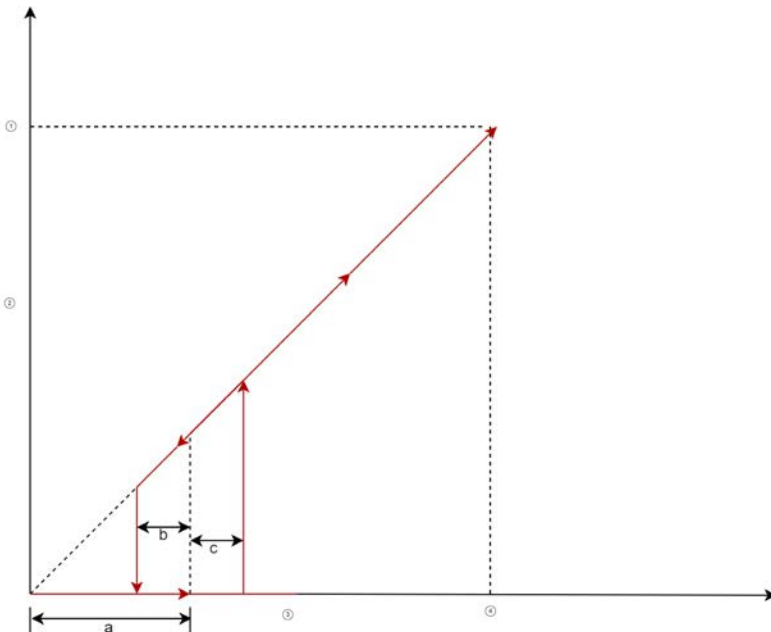

- 1 = AI max actual
- 2 = AI actual
- 3 = AI given
- 4 = AI max

In the above diagram, a is the deadband value. Values b and c are -10% and +10% hysteresis value respectively. Hysteresis values are internally set in firmware and cannot be edited by the user.

7

Fault tracing

What this chapter contains

The chapter lists the warning and fault messages including possible causes and corrective actions. The causes of most warnings and faults can be identified and corrected using the information in this chapter. If not, contact an ABB service representative. If you have a possibility to use the Drive composer PC tool, send the Support package created by the Drive composer to the ABB service representative.

Warnings and faults are listed below in separate tables. Each table is sorted by warning/fault code.

Safety



WARNING! Only qualified electricians are allowed to service the drive. Read the instructions in chapter *Safety instructions* at the beginning of the *Hardware manual* of the drive before working on the drive.

Indications

■ Warnings and faults

Warnings and faults indicate an abnormal drive status. The codes and names of active warnings and faults are displayed on the control panel of the drive as well as in the Drive composer PC tool. Only the codes of warnings and faults are available over fieldbus.

Warnings do not need to be reset; they stop showing when the cause of the warning ceases. Warnings do not trip the drive and it will continue to operate the motor.

Faults latch inside the drive and cause the drive to trip, and the motor stops. After the cause of a fault has been removed, the fault can be reset from the control panel or from a selectable source (parameter [31.11 Fault reset selection](#)) such as the digital inputs of the drive. Resetting the fault creates an event [64FF Fault reset](#). After the reset, the drive can be restarted.

Note that some faults require a reboot of the control unit either by switching the power off and on, or using parameter [96.08 Control board boot](#) – this is mentioned in the fault listing wherever appropriate.

■ Pure events

In addition to warnings and faults, there are pure events that are only recorded in the event log of the drive. The codes of these events are included in the [Warning messages](#) table on page [222](#).

■ Editable messages

For external events, the action (fault or warning), name and the message text can be edited. To specify external events, select **Menu > Primary settings > Advanced functions > External events**.

Contact information can also be included and the text edited. To specify contact information, select **Menu > Primary settings > Clock, region, display > Contact info view**.

7

Warning/fault history

■ Event log

The drive has two event logs. One log contains faults and fault resets, the other contains warnings, pure events, and clearing entries. Each log contains 32 the most recent events. All indications are stored in the event log with a time stamp and other information. See section [Viewing warning/fault information](#) on page [220](#).

To clear the fault and event logger, select **Menu > Primary settings > Reset to defaults > Reset fault and event logs**, or set parameter [96.51 Clear fault and event logger](#) to value Clear.

Auxiliary codes

Some events generate an auxiliary code that often helps in pinpointing the problem. On the control panel, the auxiliary code is stored as part of the details of the event; in the Drive composer PC tool, the auxiliary code is shown in the event listing.

■ Viewing warning/fault information

The drive is able to store a list of the active faults actually causing the drive to trip at the present time. The drive also stores a list of faults and warnings that have previously occurred.

For each stored fault, the control panel shows the fault code, time and values of nine parameters (actual signals and status words) stored at the time of the fault. The values of the parameters for the latest fault are in parameters [05.80...05.89](#).

For active faults and warnings, see

- **Menu > Diagnostics > Active faults**
- **Menu > Diagnostics > Active warnings**
- parameters in group [04 Warnings and faults](#) (page [365](#)).

For previously occurred faults and warnings, see

- **Menu > Diagnostics > Fault & event log**
- parameters in group [04 Warnings and faults](#) (page [365](#)).

The event log can also be accessed (and reset) using the Drive composer PC tool. See *Drive composer PC tool user's manual* (3AUA0000094606 [English]).

QR code generation for mobile service application

A QR code (or a series of QR codes) can be generated by the drive for display on the control panel. The QR code contains drive identification data, information on the latest events, and values of status and counter parameters. The code can be read with a mobile device containing the ABB service application, which then sends the data to ABB for analysis. For more information on the application, contact your local ABB service representative.

To generate the QR code, select **Menu > System info > QR code**.

Note: If a control panel which does not support QR code generation (version older than v.6.4x) is used, the **QR code** menu entry will disappear totally and will not be available any longer either with control panels supporting the QR code generation.

Note: There is a risk of removing the **QR code** menu permanently if a backup from a drive with an old firmware or old panel firmware is restored to a drive with a new firmware from October 2014 or later.

Warning messages

Note: The list also contains events that only appear in the Event log.

Code (hex)	Warning / Aux. code	Cause	What to do
A2B1	Overcurrent	Output current has exceeded internal fault limit. In addition to an actual overcurrent situation, this warning may also be caused by an earth fault or supply phase loss.	<p>Check motor load.</p> <p>Check acceleration times in parameter group 23 Speed reference ramp (speed control) or 28 Frequency reference chain (frequency control). Also check parameters 46.01 Speed scaling, 46.02 Frequency scaling and 46.03 Torque scaling.</p> <p>Check motor and motor cable (including phasing and delta/star connection). Check for an earth fault in motor or motor cables by measuring the insulation resistances of motor and motor cable. See chapter <i>Electrical installation</i>, section <i>Checking the insulation of the assembly</i> in the <i>Hardware manual</i> of the drive.</p> <p>Check there are no contactors opening and closing in motor cable.</p> <p>Check that the start-up data in parameter group 99 Motor data corresponds to the motor rating plate.</p> <p>Check that there are no power factor correction capacitors or surge absorbers in motor cable.</p>
A2B3	Earth leakage	Drive has detected load unbalance typically due to earth fault in motor or motor cable.	<p>Check there are no power factor correction capacitors or surge absorbers in motor cable.</p> <p>Check for an earth fault in motor or motor cables by measuring the insulation resistances of motor and motor cable. See chapter <i>Electrical installation</i>, section <i>Checking the insulation of the assembly</i> in the <i>Hardware manual</i> of the drive. If an earth fault is found, fix or change the motor cable and/or motor. If no earth fault can be detected, contact your local ABB representative.</p>
A2B4	Short circuit	Short-circuit in motor cable(s) or motor.	<p>Check motor and motor cable for cabling errors.</p> <p>Check motor and motor cable (including phasing and delta/star connection). Check for an earth fault in motor or motor cables by measuring the insulation resistances of motor and motor cable. See chapter <i>Electrical installation</i>, section <i>Checking the insulation of the assembly</i> in the <i>Hardware manual</i> of the drive.</p> <p>Check there are no power factor correction capacitors or surge absorbers in motor cable.</p>

Code (hex)	Warning / Aux. code	Cause	What to do
	0001	Short circuit in the upper transistor of the U-phase. For frames R6 to R11.	
	0002	Short circuit in the lower transistor of the U-phase. For frames R6 to R11.	
	0004	Short circuit in the upper transistor of the V-phase. For frames R6 to R11.	
	0008	Short circuit in the lower transistor of the V-phase. For frames R6 to R11.	
	0010	Short circuit in the upper transistor of the W-phase. For frames R6 to R11.	
	0020	Short circuit in the lower transistor of the W-phase. For frames R6 to R11.	
	0040	DC capacitor short circuit. For frames R6 to R11.	
	0080	State feedback from output phases does not match control signals. For frames R6 and R7.	
A2BA	IGBT overload	Excessive IGBT junction to case temperature. This warning protects the IGBT(s) and can be activated by a short circuit in the motor cable.	Check motor cable. Check ambient conditions. Check air flow and fan operation. Check heatsink fins for dust pick-up. Check motor power against drive power.
A3A1	DC link overvoltage	Intermediate circuit DC voltage too high (when the drive is stopped).	Check the supply voltage setting (parameter 95.01 Supply voltage). Note that the wrong setting of the parameter may cause the motor to rush uncontrollably, or may overload the brake chopper or resistor.
A3A2	DC link undervoltage	Intermediate circuit DC voltage too low (when the drive is stopped).	Check the supply voltage.
A3AA	DC not charged	The voltage of the intermediate DC circuit has not yet risen to operating level.	If the problem persists, contact your local ABB representative.
A490	Incorrect temperature sensor setup	Temperature cannot be supervised due to incorrect adapter setup.	Check the settings of temperature source parameters 35.11 and 35.21 .
A491	External temperature 1 (Editable message text)	Measured temperature 1 has exceeded warning limit.	Check the value of parameter 35.02 Measured temperature 1 . Check the cooling of the motor (or other equipment whose temperature is being measured). Check the value of 35.13 Temperature 1 warning limit .

Code (hex)	Warning / Aux. code	Cause	What to do
A492	External temperature 2 (Editable message text)	Measured temperature 2 has exceeded warning limit.	Check the value of parameter 35.03 Measured temperature 2 . Check the cooling of the motor (or other equipment whose temperature is being measured). Check the value of 35.23 Temperature 2 warning limit .
A4A0	Control board temperature	Control board temperature is too high.	Check the auxiliary code. See actions for each code below.
	(none)	Temperature above warning limit	Check ambient conditions. Check air flow and fan operation. Check heatsink fins for dust pick-up.
	0001	Thermistor broken	Contact an ABB service representative for control board replacement.
A4A1	IGBT overtemperature	Estimated drive IGBT temperature is excessive.	Check ambient conditions. Check air flow and fan operation. Check heatsink fins for dust pick-up. Check motor power against drive power.
A4A9	Cooling	Drive module temperature is excessive.	Check ambient temperature. If it exceeds 50 °C /122 °F, ensure that load current does not exceed derated load capacity of the drive. Check drive module cooling air flow and fan operation. Check inside of cabinet and heatsink of drive module for dust pick-up. Clean whenever necessary.
A4B0	Excess temperature	Power unit module temperature is excessive.	Check ambient conditions. Check air flow and fan operation. Check heatsink fins for dust pick-up. Check motor power against drive power.
A4B1	Excess temperature difference	High temperature difference between the IGBTs of different phases.	Check the motor cabling. Check cooling of drive module(s).
A4F6	IGBT temperature	Drive IGBT temperature is excessive.	Check ambient conditions. Check air flow and fan operation. Check heatsink fins for dust pick-up. Check motor power against drive power.
A581	Fan	Cooling fan feedback missing.	Check the auxiliary code to identify the fan. Code 0 denotes main fan 1. Other codes (format XYZ): "X" specifies state code (1 : ID run, 2 : normal). "Y" = 0, "Z" specifies the index of the fan (1 : Main fan 1, 2 : Main fan 2, 3 : Main fan 3). Check fan operation and connection. Replace fan if faulty.

Code (hex)	Warning / Aux. code	Cause	What to do
A5A0	Safe torque off Programmable warning: <i>31.22 STO indication run/stop</i>	Safe torque off function is active, ie, safety circuit signal(s) connected to connector STO is lost.	Check safety circuit connections. For more information, chapter <i>The Safe torque off function</i> in the <i>Hardware manual</i> of the drive and description of parameter <i>31.22 STO indication run/stop</i> . Check the value of parameter <i>95.04 Control board supply</i> .
A5EA	Measurement circuit temperature	Problem with internal temperature measurement of the drive.	Check the auxiliary code. They depend on the control unit type.
		Frames R1...R4	Contact your local ABB representative.
	0000 0000	IGBT temperature	
	0000 0003	Board temperature	
	0000 0006	Power supply temperature	
		Frames R6...R11 and ACx580-31 frame R3	Contact your local ABB representative.
	0000 0001	U-phase IGBT	
	0000 0002	V-phase IGBT	
	0000 0003	W-phase IGBT	
	0000 0004	Board temperature	
	0000 0005	Brake chopper	
	0000 0006	Air inlet (TEMP3)	
	0000 0007	Power supply temperature	
	0000 0008	du/dt (TEMP2)	
	0000 0009	TEMP1	
	FAh =1111 1010	Ambient temperature	
A5EB	PU board powerfail	Power unit power supply failure.	Contact your local ABB representative.
A5ED	Measurement circuit ADC	Measurement circuit fault.	Contact your local ABB representative.
A5EE	Measurement circuit DFF	Measurement circuit fault.	Contact your local ABB representative.
A5EF	PU state feedback	State feedback from output phases does not match control signals.	Contact your local ABB representative.
A5F0	Charging feedback	Charging feedback signal missing.	Check the feedback signal coming from the charging system.
A682	Flash erase speed exceeded	The flash memory (in the memory unit) has been erased too frequently, compromising the lifetime of the memory.	Avoid forcing unnecessary parameter saves by parameter <i>96.07</i> or cyclic parameter writes (such as user logger triggering through parameters). Check the auxiliary code (format XYYY YZZZ). "X" specifies the source of warning (1: generic flash erase supervision). "ZZZ" specifies the flash subsector number that generated the warning.

Code (hex)	Warning / Aux. code	Cause	What to do
A686	Checksum mismatch Programmable warning: 96.54 Checksum action	The calculated parameter checksum does not match any enabled reference checksum.	Check that all necessary approved (reference) checksums (96.71...96.72) are enabled in 96.55 Checksum control word . Check the parameter configuration. Using 96.55 Checksum control word , enable a checksum parameter and copy the actual checksum into that parameter.
A687	Checksum configuration	An action has been defined for a parameter checksum mismatch but the feature has not been configured.	Contact your local ABB representative for configuring the feature, or disable the feature in 96.54 Checksum action .
A6A4	Motor nominal value	The motor parameters are set incorrectly. The drive is not dimensioned correctly.	Check the auxiliary code. See actions for each code below.
	0001	Slip frequency is too small.	Check the settings of the motor configuration parameters in groups 98 and 99. Check that the drive is sized correctly for the motor.
	0002	Synchronous and nominal speeds differ too much.	
	0003	Nominal speed is higher than synchronous speed with 1 pole pair.	
	0004	Nominal current is outside limits	
	0005	Nominal voltage is outside limits.	
	0006	Nominal power is higher than apparent power.	
	0007	Nominal power not consistent with nominal speed and torque.	
	0008	Motor nominal power factor is not within limits for Asynchronous motors [0.5...0.97].	
A6A5	No motor data	Parameters in group 99 have not been set.	Check that all the required parameters in group 99 have been set. Note: It is normal for this warning to appear during the start-up and continue until the motor data is entered.
A6A6	Voltage category unselected	The voltage category has not been defined.	Set voltage category in parameter 95.01 Supply voltage .
A6A7	System time not set	System time is not set. Timed functions cannot be used and fault log dates are not correct.	Set the system time manually or connect the control panel to the drive to synchronize the clock. If basic control panel is used, synchronize the clock through the EFB or a fieldbus module. Set parameter 34.10 Timed functions enable to <i>Disabled</i> to disable the timed functions if they are not used.

Code (hex)	Warning / Aux. code	Cause	What to do
A6B0	User lock is open	The user lock is open, ie, user lock configuration parameters 96.100...96.102 are visible.	Close the user lock by entering an invalid pass code in parameter 96.02 Pass code . See section Parameter checksum calculation (page 214).
A6B1	User pass code not confirmed	A new user pass code has been entered in parameter 96.100 but not confirmed in 96.101 .	Confirm the new pass code by entering the same code in 96.101 . To cancel, close the user lock without confirming the new code. See section Parameter checksum calculation (page 214).
A6D1	FBA A parameter conflict	The drive does not have a functionality requested by a PLC, or requested functionality has not been activated.	Check PLC programming. Check settings of parameter group 50 Fieldbus adapter (FBA) .
A6E5	AI parametrization	The current/voltage hardware setting of an analog input does not correspond to parameter settings.	Check the event log for an auxiliary code. The code identifies the analog input whose settings are in conflict. Adjust either the hardware setting (on the drive control unit) or parameter 12.15/12.25 . Note: Control board reboot (either by cycling the power or through parameter 96.08 Control board boot) is required to validate any changes in the hardware settings.
A6E6	ULC configuration	User load curve configuration error.	Check the auxiliary code. See actions for each code below.
	0000	Speed points inconsistent.	Check that each speed point (parameters 37.11...37.15) has a higher value than the previous point.
	0001	Frequency points inconsistent.	Check that each frequency point (37.20...37.16) has a higher value than the previous point.
	0002	Underload point above overload point.	Check that each overload point (37.31...37.35) has a higher value than the corresponding underload point (37.21...37.25).
	0003	Overload point below underload point.	
A6E7	IPC configuration warning	IPC configuration error.	Check the auxiliary code. See actions for each code below.
	0001	IPC incorrectly configured for EFB.	Check that if parameter 76.21 Multipump configuration is set to <i>IPC</i> , parameter 58.01 Protocol enable is set to <i>None / IPC communication</i> . Check that if 58.01 Protocol enable is set to <i>None / IPC communication</i> , 76.21 Multipump configuration is set to <i>IPC</i> , and 76.24 IPC communication port is set to <i>EFB</i> .
	0002	IPC incorrectly configured for FBA.	Check that if parameter 76.21 Multipump configuration is set to none of <i>IPC</i> , parameter 50.01 FBA A enable is set to <i>Disable</i> .

Code (hex)	Warning / Aux. code	Cause	What to do
A6E8	IPC version mismatch	The master and follower(s) do not have the same IPC version and will not run in IPC mode.	Check 07.05 Firmware version of all drives on the IPC network and load the drive(s) as needed with the desired firmware version.
A780	Motor stall Programmable warning: 31.24 Stall function	Motor is operating in stall region because of, for example, excessive load or insufficient motor power.	Check motor load and drive ratings. Check fault function parameters.
A783	Motor overload	Motor current is too high.	Check for overloaded motor. Adjust the parameters used for the motor overload function (35.51...35.53) and 35.55...35.56 .
A784	Motor disconnect	All three output phases are disconnected from motor.	Check that switches between drive and motor are closed. Check that all cables between drive and motor are connected and secured. If no issue was detected and drive output was actually connected to motor, contact ABB.
A793	BR excess temperature	Brake resistor temperature has exceeded warning limit defined by parameter 43.12 Brake resistor warning limit .	Stop drive. Let resistor cool down. Check resistor overload protection function settings (parameter group 43 Brake chopper). Check warning limit setting, parameter 43.12 Brake resistor warning limit . Check that the resistor has been dimensioned correctly. Check that braking cycle meets allowed limits.
A794	BR data	Brake resistor data has not been given.	One or more of the resistor data settings (parameters 43.08...43.10) is incorrect. The parameter is specified by the auxiliary code.
	0000 0001	Resistance value too low.	Check value of 43.10 Brake resistance .
	0000 0002	Thermal time constant not given.	Check value of 43.08 Brake resistor thermal tc .
	0000 0003	Maximum continuous power not given.	Check value of 43.09 Brake resistor Pmax cont .
A79C	BC IGBT excess temperature	Brake chopper IGBT temperature has exceeded internal warning limit.	Let chopper cool down. Check for excessive ambient temperature. Check for cooling fan failure. Check for obstructions in the air flow. Check the dimensioning and cooling of the cabinet. Check resistor overload protection function settings (parameters 43.06...43.10). Check minimum allowed resistor value for the chopper being used. Check that braking cycle meets allowed limits. Check that drive supply AC voltage is not excessive.

Code (hex)	Warning / Aux. code	Cause	What to do
A7AB	Extension I/O configuration failure	Installed extension module is not the same as configured.	Check that the installed extension module (shown by parameter 15.02 Detected extension module) is the same as selected by parameter 15.01 Extension module type .
A7C1	FBA A communication Programmable warning: 50.02 FBA A comm loss func	Cyclical communication between drive and fieldbus adapter module A or between PLC and fieldbus adapter module A is lost.	Check status of fieldbus communication. See user documentation of fieldbus interface. Check settings of parameter groups 50 Fieldbus adapter (FBA) , 51 FBA A settings , 52 FBA A data in and 53 FBA A data out . Check cable connections. Check if communication master is able to communicate.
A7CE	EFB comm loss Programmable warning: 58.14 Communication loss action	Communication break in embedded fieldbus (EFB) communication.	Check the status of the fieldbus master (online/offline/error etc.). Check cable connections to the EIA-485/X5 terminals 29, 30 and 31 on the control unit.
A7EE	Panel loss Programmable warning: 49.05 Communication loss action	Control panel or PC tool selected as active control location for drive has ceased communicating.	Check PC tool or control panel connection. Check control panel connector. Check mounting platform if being used. Disconnect and reconnect the control panel.
A88F	Cooling fan	Maintenance timer limit exceeded.	Consider changing the cooling fan. Parameter 05.04 Fan on-time counter shows the running time of the cooling fan.
A8A0	AI supervision Programmable warning: 12.03 AI supervision function	An analog signal is outside the limits specified for the analog input.	Check signal level at the analog input. Check the wiring connected to the input. Check the minimum and maximum limits of the input in parameter group 12 Standard AI .
A8A1	RO life warning	The relay has changed states more than the recommended number of times.	Change the control board or stop using the relay output. Check the auxiliary code, which identifies the relay output.
	0001	Relay output 1	Change the control board or stop using relay output 1.
	0002	Relay output 2	Change the control board or stop using relay output 2.
	0003	Relay output 3	Change the control board or stop using relay output 3.
A8A2	RO toggle warning	The relay output is changing states faster than recommended, for example, if a fast changing frequency signal is connected to it. The relay lifetime will be exceeded shortly.	Replace the signal connected to the relay output source with a less frequently changing signal. Check the auxiliary code, which identifies the relay output source parameter.
	0001	Relay output 1	Select a different signal with parameter 10.24 RO1 source .

Code (hex)	Warning / Aux. code	Cause	What to do
	0002	Relay output 2	Select a different signal with parameter 10.27 RO2 source .
	0003	Relay output 3	Select a different signal with parameter 10.30 RO3 source .
A8B0	ABB Signal supervision 1 (Editable message text) Programmable warning: 32.06 Supervision 1 action	Warning generated by the signal supervision function 1.	Check the source of the warning (parameter 32.07 Supervision 1 signal).
A8B1	ABB Signal supervision 2 (Editable message text) Programmable warning: 32.16 Supervision 2 action	Warning generated by the signal supervision function 2.	Check the source of the warning (parameter 32.17 Supervision 2 signal).
A8B2	ABB Signal supervision 3 (Editable message text) Programmable warning: 32.26 Supervision 3 action	Warning generated by the signal supervision function 3.	Check the source of the warning (parameter 32.27 Supervision 3 signal).
A8B3	ABB Signal supervision 4 (Editable message text) Programmable warning: 32.36 Supervision 4 action	Warning generated by the signal supervision function 4.	Check the source of the warning (parameter 32.37 Supervision 4 signal).
A8B4	ABB Signal supervision 5 (Editable message text) Programmable warning: 32.46 Supervision 5 action	Warning generated by the signal supervision function 5.	Check the source of the warning (parameter 32.47 Supervision 5 signal).
A8B5	ABB Signal supervision 6 (Editable message text) Programmable warning: 32.56 Supervision 6 action	Warning generated by the signal supervision function 6.	Check the source of the warning (parameter 32.57 Supervision 6 signal).
A8BE	ULC overload warning Programmable fault: 37.03 ULC overload actions	Selected signal has exceeded the user overload curve.	Check for any operating conditions increasing the monitored signal (for example, the loading of the motor if the torque or current is being monitored). Check the definition of the load curve (parameter group 37 User load curve).
A8BF	ULC underload warning Programmable fault: 37.04 ULC underload actions	Selected signal has fallen below the user underload curve.	Check for any operating conditions decreasing the monitored signal (for example, loss of load if the torque or current is being monitored). Check the definition of the load curve (parameter group 37 User load curve).
A981	External warning 1 (Editable message text) Programmable warning: 31.01 External event 1 source 31.02 External event 1 type	Fault in external device 1.	Check the external device. Check setting of parameter 31.01 External event 1 source .

Code (hex)	Warning / Aux. code	Cause	What to do
A982	External warning 2 (Editable message text) Programmable warning: 31.03 External event 2 source 31.04 External event 2 type	Fault in external device 2.	Check the external device. Check setting of parameter 31.03 External event 2 source .
A983	External warning 3 (Editable message text) Programmable warning: 31.05 External event 3 source 31.06 External event 3 type	Fault in external device 3.	Check the external device. Check setting of parameter 31.05 External event 3 source .
A984	External warning 4 (Editable message text) Programmable warning: 31.07 External event 4 source 31.08 External event 4 type	Fault in external device 4.	Check the external device. Check setting of parameter 31.07 External event 4 source .
A985	External warning 5 (Editable message text) Programmable warning: 31.09 External event 5 source 31.10 External event 5 type	Fault in external device 5.	Check the external device. Check setting of parameter 31.09 External event 5 source .
AF88	Season configuration warning	You have configured a season which starts before the previous season.	Configure the seasons with increasing start dates, see parameters 34.60 Season 1 start date... 34.63 Season 4 start date .
AFAA	Autoreset	A fault is about to be autoreset.	Informative warning. See the settings in parameter group 31 Fault functions .
AFE1	Emergency stop (off2)	Drive has received an emergency stop (mode selection off2) command.	Check that it is safe to continue operation. Then return emergency stop push button to normal position. Restart drive.
AFE2	Emergency stop (off1 or off3)	Drive has received an emergency stop (mode selection off1 or off3) command.	If the emergency stop was unintentional, check the source selected by parameter 21.05 Emergency stop source .
AFE9	Start delay	The start delay is active and the drive will start the motor after a predefined delay.	Informative warning. See parameter 21.22 Start delay .
AFED	Run permissive	Run permissive is keeping the drive from running the motor.	Check the setting of (and source selected by) parameter 20.40 Run permissive .
AFEE	Start interlock 1	Start interlock 1 is keeping the drive from starting.	Check the signal source selected for parameter 20.41 Start interlock 1 .
AFEF	Start interlock 2	Start interlock 2 is keeping the drive from starting.	Check the signal source selected for parameter 20.42 Start interlock 2 .
AFF0	Start interlock 3	Start interlock 3 is keeping the drive from starting.	Check the signal source selected for parameter 20.43 Start interlock 3 .
AFF1	Start interlock 4	Start interlock 4 is keeping the drive from starting.	Check the signal source selected for parameter 20.44 Start interlock 4 .

Code (hex)	Warning / Aux. code	Cause	What to do
AFF2	Run permissive forced warning	A forced DI is used as a source for parameter 20.40 Run permissive .	If 20.40 Run permissive uses DIx as the source, check if the bit corresponding to DIx in parameter 10.03 DI force selection is 1.
AFF3	Start interlock forced warning	One or more forced DIx is used as a source for one or more of parameters 20.41 Start interlock 1 ... 20.44 Start interlock 4 .	Check all parameters 20.41 Start interlock 1 ... 20.44 Start interlock 4 . If any of these parameters uses DIx as the source, check if the bit corresponding to DIx in parameter 10.03 DI force selection is 1.
AFF5	Override new start required	The Safe torque off function was active and has been reset while in Override.	A new start signal is required to start the drive again.
AFF6	Identification run	Motor ID run will occur at next start.	Informative warning.
AFF8	Motor heating active	Pre-heating is being performed	Informative warning. Motor pre-heating is active. Current specified by parameter 21.16 Pre-heating current is being passed through the motor.
AFFE	Override active	Drive is in Override mode.	Informative warning.
B5A0	STO event Programmable event: 31.22 STO indication run/stop	Safe torque off function is active, ie, safety circuit signal(s) connected to connector STO is lost.	Informative warning. Check safety circuit connections. For more information, see chapter <i>The Safe torque off function</i> in the <i>Hardware manual</i> of the drive and description of parameter 31.22 STO indication run/stop (page 480).
B5A2	Power applied	The drive was powered up or the control board was rebooted successfully.	Informative event.
B681	Hand mode selected	The drive was placed in Hand mode.	Informative event. Check the control panel to ensure that the current control location is correct.
B682	Off mode selected	The drive was placed in Off mode.	Informative event. Check the control panel to ensure that the current control location is correct.
B683	Auto mode selected	The drive was placed in Auto mode.	Informative event. Check the control panel to ensure that the current control location is correct.
B686	Checksum mismatch Programmable event: 96.54 Checksum action	The calculated parameter checksum does not match any enabled reference checksum.	See A686 Checksum mismatch (page 226).
B687	Auto start command	The drive received a start command while in Auto mode.	Informative event.
B688	Auto stop command	The drive received a stop command while in Auto mode.	Informative event.
B689	Modulating started	The drive started modulating.	Informative event.
B68A	Modulating stopped	The drive stopped modulating.	Informative event.

Code (hex)	Warning / Aux. code	Cause	What to do
D501	No more available PFC motors	No more PFC motors can be started because they can be interlocked or in the Hand mode.	Check that there are no interlocked PFC motors, see parameters: 76.81...76.84 . If all motors are in use, the PFC system is not adequately dimensioned to handle the demand.
D502	All motors interlocked	All the motors in the PFC system are interlocked.	Check that there are no interlocked PFC motors, see parameters 76.81...76.84 .
D503	VSD controlled PFC motor interlocked	The motor connected to the drive is interlocked (unavailable).	Motor connected to the drive is interlocked and thus cannot be started. Remove the corresponding interlock to start the drive controlled PFC motor. See parameters 76.81...76.84 .
D504	Damper timeout	Discharge air or outside air damper has timed out.	Check the auxiliary code, which identifies the parameter to be checked.
	0001	Discharge air damper was commanded to open and it timed out while opening	See parameter 84.05 .
	0002	Discharge air damper was commanded to close and it timed out while closing.	See parameter 84.08 .
	0003	Outside air damper was commanded to open and it timed out while opening.	See parameter 84.15 .
	0004	Outside air damper was commanded to close and it timed out while closing.	See parameter 84.18 .
D50A	Running dry Programmable warning: 82.20 Dry run protection	Dry run protection is activated.	Check the pump inlet for sufficient water level. Check dry run protection settings in parameters 82.20 Dry run protection and 82.21 Dry run source .
D50B	Pipe fill-timeout Programmable warning: 82.25 Soft pipe fill supervision	Soft pipe fill is reached the timeout limit. The PID output is not reached the setpoint after reference ramping is ended and timeout limit is elapsed.	Check the pipe for possible leakage. See parameter 82.25 Soft pipe fill supervision and 82.26 Time-out limit .
D50C	Maximum flow protection Programmable warning: 80.17 Maximum flow protection	Actual flow is exceeded the defined warning level.	Check the system for leakages. Check flow protection settings in parameters 80.15 Maximum flow , 80.17 Maximum flow protection and 80.19 Flow check delay .
D50D	Minimum flow protection Programmable warning: 80.18 Minimum flow protection	Actual flow is below the defined warning level.	Check that the inlet and outlet valves are open. Check flow protection settings in parameters 80.16 Minimum flow , 80.18 Minimum flow protection and 80.19 Flow check delay .
D50E	Outlet minimum pressure Programmable warning: 82.30 Outlet minimum pressure protection	Measured outlet pressure is below the defined warning limit.	Check the pump outlet for leakages. Check the configuration of outlet pressure protection. See parameters 82.30 Outlet minimum pressure protection and 82.31 Outlet minimum pressure warning level .

Code (hex)	Warning / Aux. code	Cause	What to do
D50F	Outlet maximum pressure Programmable warning: 82.35 Outlet maximum pressure protection	Measured outlet pressure is above the defined warning limit.	Check the pump outlet for blockages or closed valve. Check the configuration of outlet pressure protection. See parameters 82.35 Outlet maximum pressure protection and 82.37 Outlet maximum pressure warning level
D510	Inlet minimum pressure Programmable warning: 82.40 Inlet minimum pressure protection	Measured inlet pressure is below the defined warning level.	Check the pump inlet for blockages or closed valve. Check the configuration of inlet pressure protection. See parameters 82.40 Inlet minimum pressure protection and 82.41 Inlet minimum pressure warning level .
D590	Restart delay	The restart delay is active.	Check parameter 21.40 Restart delay . The drive cannot be started until the restart delay has elapsed. The restart delay can be bypassed by setting parameter 21.42 Restart delay remaining to 0.
	0000	-	Contact your local ABB representative.
	0001	-	
	0002	Pump short cycle protection.	

Fault messages

Code (hex)	Fault / Aux. code	Cause	What to do
1080	Backup/Restore timeout	Control panel or PC tool has failed to communicate with the drive when backup was being made or restored.	Request backup or restore again.
1081	Rating ID fault	Drive software has not been able to read the rating ID of the drive.	Reset the fault to make the drive try to reread the rating ID. If the fault reappears, cycle the power to the drive. You may have to repeat this. If the fault persists, contact your local ABB representative.
2310	Overcurrent	Output current has exceeded internal fault limit. In addition to an actual overcurrent situation, this fault may also be caused by an earth fault or supply phase loss.	<p>Check the received auxiliary code (format XXXYYYZZ). The ZZ part indicates the overcurrent type and the phase that triggered the fault:</p> <ul style="list-style-type: none"> • bit0 = Phase U, • bit1 = Phase V, • bit2 = Phase W <p>If bit7 is 1, this indicates SW overcurrent. For example aux code 0x83 indicates SW overcurrent of phase U and V. If there is no aux code, HW overcurrent has been triggered.</p> <p>Check the motor load.</p> <p>Check acceleration times in parameter group 23 Speed reference ramp (speed control) or 28 Frequency reference chain (frequency control). Also check parameters 46.01 Speed scaling, 46.02 Frequency scaling and 46.03 Torque scaling.</p> <p>Check the motor and motor cable (including phasing and delta/star connection).</p> <p>Check there are no contactors opening and closing in motor cable.</p> <p>Check that the start-up data in parameter group 99 Motor data corresponds to the motor rating plate.</p> <p>Check that there are no power factor correction capacitors or surge absorbers in motor cable.</p> <p>Check for an earth fault in motor or motor cables by measuring the insulation resistances of motor and motor cable. See chapter <i>Electrical installation</i>, section <i>Checking the insulation of the assembly</i> in the <i>Hardware manual</i> of the drive.</p>

Code (hex)	Fault / Aux. code	Cause	What to do
2330	Earth leakage	Drive has detected load unbalance typically due to earth fault in motor or motor cable.	Check there are no power factor correction capacitors or surge absorbers in motor cable. Check for an earth fault in motor or motor cables by measuring the insulation resistances of motor and motor cable. Try running the motor in scalar control mode if allowed. (See parameter 99.04 Motor control mode .) If no earth fault can be detected, contact your local ABB representative.
2340	Short circuit	Short-circuit in motor cable(s) or motor.	Check motor and motor cable for cabling errors. Check there are no power factor correction capacitors or surge absorbers in motor cable. Cycle the power to the drive. Auxiliary codes are shown below.
	0001	Short circuit in the upper transistor of the U-phase. For frames R6 to R11.	
	0002	Short circuit in the lower transistor of the U-phase. For frames R6 to R11.	
	0004	Short circuit in the upper transistor of the V-phase. For frames R6 to R11.	
	0008	Short circuit in the lower transistor of the V-phase. For frames R6 to R11.	
	0010	Short circuit in the upper transistor of the W-phase. For frames R6 to R11.	
	0020	Short circuit in the lower transistor of the W-phase. For frames R6 to R11.	
	0040	DC capacitor short circuit. For frames R6 to R11.	
	0080	State feedback from output phases does not match control signals. For frames R6 and R7.	
2381	IGBT overload	Excessive IGBT junction to case temperature. This fault protects the IGBT(s) and can be activated by a short circuit in the motor cable.	Check motor cable. Check ambient conditions. Check air flow and fan operation. Check heatsink fins for dust pick-up. Check motor power against drive power.
3130	Input phase loss Programmable fault: 31.21 Supply phase loss	Intermediate circuit DC voltage is oscillating due to missing input power line phase or blown fuse.	Check input power line fuses. Check for loose power cable connections. Check for input power supply imbalance.

Code (hex)	Fault / Aux. code	Cause	What to do
3181	Wiring or earth fault Programmable fault: 31.23 <i>Wiring or earth fault</i>	Incorrect input power and motor cable connection (ie. input power cable is connected to drive motor connection).	Check input power connections.
3210	DC link overvoltage	Excessive intermediate circuit DC voltage.	Check that overvoltage control is on (parameter 30.30 Overvoltage control). Check that the supply voltage matches the nominal input voltage of the drive. Check the supply line for static or transient overvoltage. Check brake chopper and resistor (if present). Check deceleration time. Use coast-to-stop function (if applicable). Retrofit drive with brake chopper and brake resistor. Check that the brake resistor is dimensioned properly and the resistance is between acceptable range for the drive.
3220	DC link undervoltage	Intermediate circuit DC voltage is not sufficient because of a missing supply phase, blown fuse or fault in the rectifier bridge.	Check supply cabling, fuses and switchgear.
3381	Output phase loss Programmable fault: 31.19 <i>Motor phase loss</i>	Motor circuit fault due to missing motor connection (all three phases are not connected).	Connect motor cable.
4110	Control board temperature	Control board temperature is too high.	Check proper cooling of the drive. Check the auxiliary cooling fan.
4210	IGBT overtemperature	Estimated drive IGBT temperature is excessive.	Check ambient conditions. Check air flow and fan operation. Check heatsink fins for dust pick-up. Check motor power against drive power.
4290	Cooling	Drive module temperature is excessive.	Check ambient temperature. If it exceeds 50 °C /122 °F, ensure that load current does not exceed derated load capacity of drive. See chapter <i>Technical data</i> , section <i>Derating</i> in the <i>Hardware manual</i> of the drive. Check drive module cooling air flow and fan operation. Check inside of cabinet and heatsink of drive module for dust pick-up. Clean whenever necessary.
42F1	IGBT temperature	Drive IGBT temperature is excessive.	Check ambient conditions. Check air flow and fan operation. Check heatsink fins for dust pick-up. Check motor power against drive power.
4310	Excess temperature	Power unit module temperature is excessive.	Check ambient conditions. Check air flow and fan operation. Check heatsink fins for dust pick-up. Check motor power against drive power.

Code (hex)	Fault / Aux. code	Cause	What to do
4380	Excess temperature difference	High temperature difference between the IGBTs of different phases.	Check the motor cabling. Check cooling of drive module(s).
4981	External temperature 1 (Editable message text)	Measured temperature 1 has exceeded fault limit.	Check the value of parameter 35.02 Measured temperature 1 . Check the cooling of the motor (or other equipment whose temperature is being measured).
4982	External temperature 2 (Editable message text)	Measured temperature 2 has exceeded fault limit.	Check the value of parameter 35.03 Measured temperature 2 . Check the cooling of the motor (or other equipment whose temperature is being measured).
5080	Fan	Cooling fan feedback missing.	See A581 Fan (page 224).
5090	STO hardware failure	STO hardware diagnostics has detected hardware failure.	Contact your local ABB representative for hardware replacement.
5091	Safe torque off Programmable fault: 31.22 STO indication run/stop	Safe torque off function is active, ie, safety circuit signal(s) connected to connector STO is broken during start or run.	Check safety circuit connections. For more information, see chapter <i>The Safe torque off function</i> in the <i>Hardware manual</i> of the drive and description of parameter 31.22 STO indication run/stop (page 480). Check the value of parameter 95.04 Control board supply .
5092	PU logic error	Power unit memory has cleared.	Contact your local ABB representative.
5093	Rating ID mismatch	The hardware of the drive does not match the information stored in the memory. This may occur, for example, after a firmware update.	Cycle the power to the drive. You may have to repeat this.
5094	Measurement circuit temperature	Problem with internal temperature measurement of the drive.	Contact your local ABB representative.
5098	I/O communication loss	Internal standard I/O communication failure.	Try resetting the fault or reboot the drive.
50A0	Fan	Cooling fan stuck or disconnected.	Check fan operation and connection. Replace fan if faulty.
5681	PU communication	Communication errors detected between the drive control unit and the power unit.	Check the connection between the drive control unit and the power unit. Check the value of parameter 95.04 Control board supply .
5682	Power unit lost	Connection between the drive control unit and the power unit is lost.	Check the connection between the control unit and the power unit.
5691	Measurement circuit ADC	Measurement circuit fault.	Contact your local ABB representative.
5692	PU board powerfail	Power unit power supply failure.	Contact your local ABB representative.
5693	Measurement circuit DFF	Measurement circuit fault.	Contact your local ABB representative.

Code (hex)	Fault / Aux. code	Cause	What to do
5697	Charging feedback	Charging feedback signal missing.	Check the feedback signal coming from the charging system.
5698	Unknown PU fault	The power unit logic has generated a fault which is not known by the software.	Check the logic and software compatibility.
6181	FPGA version incompatible	Firmware and FPGA versions are incompatible.	Reboot the control unit (using parameter 96.08 Control board boot) or by cycling power. If the problem persists, contact your local ABB representative
6200	Checksum mismatch Programmable fault: 96.54 Checksum action	The calculated parameter checksum does not match any enabled reference checksum.	See A686 Checksum mismatch (page 226).
6306	FBA A mapping file	Fieldbus adapter A mapping file read error.	Contact your local ABB representative.
6481	Task overload	Internal fault.	Reboot the control unit (using parameter 96.08 Control board boot) or by cycling power. If the problem persists, contact your local ABB representative
6487	Stack overflow	Internal fault.	Reboot the control unit (using parameter 96.08 Control board boot) or by cycling power. If the problem persists, contact your local ABB representative
64A1	Internal file load	File read error.	Reboot the control unit (using parameter 96.08 Control board boot) or by cycling power. If the problem persists, contact your local ABB representative
64A4	Rating ID fault	Rating ID load error.	Contact your local ABB representative.
64A6	Adaptive program	Error running the adaptive program.	Check the auxiliary code (format XXYY ZZZZ). "XX" specifies the number of the state (00=base program) and "YY" specifies the number of the function block (0000=generic error). "ZZZZ" indicates the problem.
	000A	Program corrupted or block non-existent	Restore the template program or download the program to the drive.
	000C	Required block input missing	Check the inputs of the block.
	000E	Program corrupted or block non-existent	Restore the template program or download the program to the drive.
	0011	Program too large.	Remove blocks until the error stops.
	0012	Program is empty.	Correct the program and download it to the drive.
	001C	A non-existing parameter or block is used in the program.	Edit the program to correct the parameter reference, or to use an existing block.
	001D	Parameter type invalid for selected pin.	Edit the program to correct the parameter reference.
	001E	Output to parameter failed because the parameter was write-protected.	Check the parameter reference in the program. Check for other sources affecting the target parameter.

Code (hex)	Fault / Aux. code	Cause	What to do
	0023	Program file incompatible with current firmware version.	Adapt the program to current block library and firmware version.
	0024		
	Other	-	Contact your local ABB representative, quoting the auxiliary code.
64B1	Internal SSW fault	Internal fault.	Reboot the control unit (using parameter 96.08 Control board boot) or by cycling power. If the problem persists, contact your local ABB representative.
64B2	User set fault	Loading of user parameter set failed because <ul style="list-style-type: none"> • requested set does not exist • set is not compatible with control program • drive was switched off during loading. 	Ensure that a valid user parameter set exists. Reload if uncertain.
64B3	Macro parameterization error	Loading of macro parameter set failed.	Reboot the control unit (using parameter 96.08 Control board boot) or by cycling power. If the problem persists, contact your local ABB representative.
64E1	Kernel overload	Operating system error.	Reboot the control unit (using parameter 96.08 Control board boot) or by cycling power. If the problem persists, contact your local ABB representative.
64FF	Fault reset	A fault has been reset from the control panel, Drive composer PC tool, fieldbus or I/O.	Event. Informative only.
6581	Parameter system	Parameter load or save failed.	Try forcing a save using parameter 96.07 Parameter save manually . Retry.
6591	Backup/Restore timeout	During backup creating or restoring operation a control panel or PC tool has failed to communicate with the drive as part this operation.	Check control panel or PC tool communication and if it is still in backup or restore state.
65A1	FBA A parameter conflict	The drive does not have a functionality requested by PLC, or requested functionality has not been activated.	Check PLC programming. Check settings of parameter groups 50 Fieldbus adapter (FBA) and 51 FBA A settings .
6681	EFB comm loss Programmable fault: 58.14 Communication loss action	Communication break in embedded fieldbus (EFB) communication.	Check the status of the fieldbus master (online/offline/error etc.). Check cable connections to the EIA-485/X5 terminals on the control unit.
6682	EFB config file	Embedded fieldbus (EFB) configuration file could not be read.	Contact your local ABB representative.
6683	EFB invalid parameterization	Embedded fieldbus (EFB) parameter settings inconsistent or not compatible with selected protocol.	Check the settings in parameter group 58 Embedded fieldbus .

Code (hex)	Fault / Aux. code	Cause	What to do
6684	EFB load fault	Embedded fieldbus (EFB) protocol firmware could not be loaded. Version mismatch between EFB protocol firmware and drive firmware.	Contact your local ABB representative.
6685	EFB fault 2	Fault reserved for the EFB protocol application.	Check the documentation of the protocol.
6686	EFB fault 3	Fault reserved for the EFB protocol application.	Check the documentation of the protocol.
6882	Text 32-bit table overflow	Internal fault.	Reset the fault. Contact your local ABB representative if the fault persists.
6885	Text file overflow	Internal fault.	Reset the fault. Contact your local ABB representative if the fault persists.
7081	Control panel loss Programmable fault: 49.05 Communication loss action	Control panel or PC tool selected as active control location for drive has ceased communicating.	Check PC tool or control panel connection. Check control panel connector. Disconnect and reconnect the control panel.
7082	I/O module comm loss	Communication between IO module and drive is not working properly.	Check the IO module installation.
7085	Incompatible option module	Fieldbus option module not supported.	Replace the module with a supported type.
7086	AI Overvoltage	An overvoltage has been detected on an analog input. The analog input has temporarily been changed to voltage mode and will be changed back to current mode when the AI signal level is back within acceptable limits.	Check AI signal levels.
7087	I/O module configuration fault	I/O module configuration not supported or illegal.	See the auxiliary code.
	0001	S1/S2 DIP switch position on BIO-01 has changed after power up.	This is not an allowed operation. To activate a new DIP switch position, the control unit must be rebooted either by cycling the power or via parameter 96.08 Control board boot .
	0002	S1/S2 DIP switch positions are such that DO1 would be in both S1 and S2 pins. This is not a supported combination.	Change the S1/S2 DIP switch positions to a supported combination. See parameter 05.99 BIO-01 DIP switch status .
7100	Excitation current	Excitation current feedback low or missing	
7121	Motor stall Programmable fault: 31.24 Stall function	Motor is operating in stall region because of, for example, excessive load or insufficient motor power.	Check motor load and drive ratings. Check fault function parameters.
7122	Motor overload	Motor current is too high.	Check for overloaded motor. Adjust the parameters used for the motor overload function (35.51...35.53) and 35.55...35.56 .

Code (hex)	Fault / Aux. code	Cause	What to do
7181	Brake resistor	Brake resistor broken or not connected.	Check that a brake resistor has been connected. Check the condition of the brake resistor. Check the dimensioning of the brake resistor.
7183	BR excess temperature	Brake resistor temperature has exceeded fault limit defined by parameter 43.11 Brake resistor fault limit .	Stop drive. Let resistor cool down. Check resistor overload protection function settings (parameter group 43 Brake chopper). Check fault limit setting, parameter 43.11 Brake resistor fault limit . Check that braking cycle meets allowed limits.
7184	Brake resistor wiring	Brake resistor short circuit or brake chopper control fault.	Check brake chopper and brake resistor connection. Ensure brake resistor is not damaged.
7191	BC short circuit	Short circuit in brake chopper IGBT.	Ensure brake resistor is connected and not damaged. Check the electrical specifications of the brake resistor against chapter <i>Resistor braking</i> in the <i>Hardware manual</i> of the drive. Replace brake chopper (if replaceable).
7192	BC IGBT excess temperature	Brake chopper IGBT temperature has exceeded internal fault limit.	Let chopper cool down. Check for excessive ambient temperature. Check for cooling fan failure. Check for obstructions in the air flow. Check resistor overload protection function settings (parameter group 43 Brake chopper). Check that braking cycle meets allowed limits. Check that drive supply AC voltage is not excessive.
7310	Overspeed	Motor is turning faster than highest allowed speed due to incorrectly set minimum/maximum speed, insufficient braking torque or changes in load when using torque reference.	Check minimum/maximum speed settings, parameters 30.11 Minimum speed and 30.12 Maximum speed . Check adequacy of motor braking torque. Check applicability of torque control. Check need for brake chopper and resistor(s).
73B0	Emergency ramp failed	Emergency stop did not finish within expected time.	Check the settings of parameters 31.32 Emergency ramp supervision and 31.33 Emergency ramp supervision delay . Check the predefined ramp times (23.11/23.15 for mode Off1, 23.23 for mode Off3).
73F0	Overfrequency	Maximum allowed output frequency exceeded.	Check the auxiliary code.

Code (hex)	Fault / Aux. code	Cause	What to do
	00FA	Motor is turning faster than the highest allowed frequency due to incorrectly set minimum/maximum frequency or the motor rushes because of too high supply voltage or incorrect supply voltage selection in parameter 95.01 Supply voltage .	Check minimum/maximum frequency settings, parameters 30.13 Minimum frequency and 30.14 Maximum frequency . Check used supply voltage and voltage selection parameter 95.01 Supply voltage .
	Other	-	Contact your local ABB representative, quoting the auxiliary code.
7510	FBA A communication Programmable fault: 50.02 FBA A comm loss func	Cyclical communication between drive and fieldbus adapter module A or between PLC and fieldbus adapter module A is lost.	Check status of fieldbus communication. See user documentation of fieldbus interface. Check settings of parameter groups 50 Fieldbus adapter (FBA) , 51 FBA A settings , 52 FBA A data in and 53 FBA A data out . Check cable connections. Check if communication master is able to communicate.
8001	ULC underload fault	User load curve: Signal has been too long under the underload curve.	See parameter 37.04 ULC underload actions .
8002	ULC overload fault	User load curve: Signal has been too long over the overload curve.	See parameter 37.03 ULC overload actions .
80A0	AI supervision Programmable fault: 12.03 AI supervision function	An analog signal is outside the limits specified for the analog input.	Check signal level at the analog input. Check the auxiliary code. Check the wiring connected to the input. Check the minimum and maximum limits of the input in parameter group 12 Standard AI .
	0001	AI1LessMIN	
	0002	AI1GreaterMAX	
	0003	AI2LessMIN.	
	0004	AI2GreaterMAX	
80B0	Signal supervision 1 (Editable message text) Programmable fault: 32.06 Supervision 1 action	Fault generated by the signal supervision function 1.	Check the source of the fault (parameter 32.07 Supervision 1 signal).
80B1	Signal supervision 2 (Editable message text) Programmable fault: 32.16 Supervision 2 action	Fault generated by the signal supervision function 2.	Check the source of the fault (parameter 32.17 Supervision 2 signal).
80B2	Signal supervision 3 (Editable message text) Programmable fault: 32.26 Supervision 3 action	Fault generated by the signal supervision function 3.	Check the source of the fault (parameter 32.27 Supervision 3 signal).
80B3	Signal supervision 4 (Editable message text) Programmable fault: 32.36 Supervision 4 action	Fault generated by the signal supervision function 4.	Check the source of the fault (parameter 32.37 Supervision 4 signal).

Code (hex)	Fault / Aux. code	Cause	What to do
80B4	Signal supervision 5 (Editable message text) Programmable fault: 32.46 Supervision 5 action	Fault generated by the signal supervision function 5.	Check the source of the fault (parameter 32.47 Supervision 5 signal).
80B5	Signal supervision 6 (Editable message text) Programmable fault:., 32.56 Supervision 6 action	Fault generated by the signal supervision function 6.	Check the source of the fault (parameter 32.57 Supervision 6 signal).
9081	External fault 1 (Editable message text) Programmable fault: 31.01 External event 1 source , 31.02 External event 1 type	Fault in external device 1.	Check the external device. Check setting of parameter 31.01 External event 1 source .
9082	External fault 2 (Editable message text) Programmable fault: 31.03 External event 2 source , 31.04 External event 2 type	Fault in external device 2.	Check the external device. Check setting of parameter 31.03 External event 2 source .
9083	External fault 3 (Editable message text) Programmable fault: 31.05 External event 3 source , 31.06 External event 3 type	Fault in external device 3.	Check the external device. Check setting of parameter 31.05 External event 3 source .
9084	External fault 4 (Editable message text) Programmable fault: 31.07 External event 4 source , 31.08 External event 4 type	Fault in external device 4.	Check the external device. Check setting of parameter 31.07 External event 4 source .
9085	External fault 5 (Editable message text) Programmable fault: 31.09 External event 5 source , 31.10 External event 5 type	Fault in external device 5.	Check the external device. Check setting of parameter 31.09 External event 5 source .
D404	Running dry Programmable fault: 82.20 Dry run protection	Dry run protection is activated.	Check the pump inlet for sufficient water level. Check dry run protection settings in parameters 82.20 Dry run protection and 82.21 Dry run source .
D405	Pipe fill-timeout Programmable fault: 82.25 Soft pipe fill supervision	Soft pipe fill has reached timeout limit. The PID output is not reached the setpoint after reference ramping is ended and the timeout limit is elapsed.	Check the pipe for possible leakage. See parameter 82.25 Soft pipe fill supervision and 82.26 Time-out limit .
D406	Maximum flow protection Programmable fault: 80.17 Maximum flow protection	Actual flow is exceeded the defined fault level.	Check the system for leakages. Check flow protection settings in parameters 80.15 Maximum flow , 80.17 Maximum flow protection and 80.19 Flow check delay .

Code (hex)	Fault / Aux. code	Cause	What to do
D407	Minimum flow protection Programmable fault: 80.18 Minimum flow protection	Actual flow is below the defined fault level.	Check that the inlet and outlet valves are open. Check flow protection settings in parameters 80.16 Minimum flow , 80.18 Minimum flow protection and 80.19 Flow check delay .
D408	Outlet minimum pressure Programmable fault: 82.30 Outlet minimum pressure protection	The measured outlet pressure is below the defined fault limit.	Check the pump outlet for leakages. Check the configuration of outlet pressure protection. See parameters 82.30 Outlet minimum pressure protection and 82.32 Outlet minimum pressure fault level .
D409	Outlet maximum pressure Programmable fault: 82.35 Outlet maximum pressure protection	The measured outlet pressure is above the defined fault limit.	Check the pump outlet for blockages or closed valve. Check the configuration of outlet pressure protection. See parameters 82.35 Outlet maximum pressure protection and 82.38 Outlet maximum pressure fault level .
D40A	Inlet minimum pressure Programmable fault: 82.40 Inlet minimum pressure protection	The measured inlet pressure is below the defined fault level.	Check the pump inlet for blockages or closed valve. Check the configuration of inlet pressure protection. See parameters 82.40 Inlet minimum pressure protection and 82.42 Inlet minimum pressure fault level .
D40B	Damper timeout	Discharge air or outside air damper has timed out.	Check the auxiliary code, which identifies the parameter to be checked.
	0001	Discharge air damper was commanded to open and it timed out while opening.	See parameter 84.05 .
	0002	Discharge air damper was commanded to close and it timed out while closing.	See parameter 84.08 .
	0003	Outside air damper was commanded to open and it timed out while opening.	See parameter 84.15 .
	0004	Outside air damper was commanded to close and it timed out while closing.	See parameter 84.18 .
D40C	Multipump run permissive timeout	The run permissive setting configured with parameter 20.40 Run permissive was not satisfied within the time set in parameter 20.40 Run permissive 76.64 Run permissive timeout from when the drive was commanded to start.	Check the signal source selected for parameter 20.40 Run permissive .

Code (hex)	Fault / Aux. code	Cause	What to do
FA81	Safe torque off 1	Safe torque off function is active, that is, STO circuit 1 is broken.	Check safety circuit connections. For more information, see chapter <i>The Safe torque off function</i> in the <i>Hardware manual</i> of the drive and description of parameter 31.22 STO indication run/stop (page 480).
FA82	Safe torque off 2	Safe torque off function is active, that is, STO circuit 2 is broken.	Check the value of parameter 95.04 Control board supply .
FF61	ID run	Motor ID run was not completed successfully.	Check the nominal motor values in parameter group 99 Motor data . Check that no external control system is connected to the drive. Cycle the power to the drive (and its control unit, if powered separately). Check that no operation limits prevent the completion of the ID run. Restore parameters to default settings and try again. Check that the motor shaft is not locked. Check the auxiliary code. See actions for each code below.
	0001	Maximum current limit too low.	Check settings of parameters 99.06 Motor nominal current and 30.17 Maximum current . Make sure that $30.17 > 99.06$. Check that the drive is dimensioned correctly according to the motor.
	0002	Maximum speed limit or calculated field weakening point too low.	Check settings of parameters <ul style="list-style-type: none"> • 30.11 Minimum speed • 30.12 Maximum speed • 99.07 Motor nominal voltage • 99.08 Motor nominal frequency • 99.09 Motor nominal speed. Make sure that <ul style="list-style-type: none"> • $30.12 > (0.55 \times 99.09) > (0.50 \times \text{synchronous speed})$ • $30.11 \leq 0$, and • supply voltage $\geq (0.66 \times 99.07)$.
	0003	Maximum torque limit too low.	Check settings of parameter 99.12 Motor nominal torque , and the torque limits in group 30 Limits . Make sure that the maximum torque limit in force is greater than 100%.
	0004	Current measurement calibration did not finish within reasonable time	Contact your local ABB representative.
	0005...0008	Internal error.	Contact your local ABB representative.
	0009	(Asynchronous motors only) Acceleration did not finish within reasonable time.	Contact your local ABB representative.
	000A	(Asynchronous motors only) Deceleration did not finish within reasonable time.	Contact your local ABB representative.

Code (hex)	Fault / Aux. code	Cause	What to do
	000B	(Asynchronous motors only) Speed dropped to zero during ID run.	Contact your local ABB representative.
	000C	(Permanent magnet motors only) First acceleration did not finish within reasonable time.	Contact your local ABB representative.
	000D	(Permanent magnet motors only) Second acceleration did not finish within reasonable time.	Contact your local ABB representative.
	000E...0010	Internal error.	Contact your local ABB representative.
	0011	(Synchronous reluctance motors only) Pulse test error.	Contact your local ABB representative.
	0012	Motor too large for advanced standstill ID run.	Check that the motor and drive sizes are compatible. Contact your local ABB representative.
	0013	(Asynchronous motors only) Motor data error.	Check that the motor nominal value settings in the drive are the same as in the motor nameplate. Contact your local ABB representative.
FF63	STO diagnostics failure.	SW internal malfunction.	Reboot the control unit (using parameter <i>96.08 Control board boot</i>) or by cycling power.
FF81	FB A force trip	A fault trip command has been received through fieldbus adapter A.	Check the fault information provided by the PLC.
FF8E	EFB force trip	A fault trip command has been received through the embedded fieldbus interface.	Check the fault information provided by the PLC.



Modbus RTU control through the embedded fieldbus interface (EFB)

What this chapter contains

The chapter describes how the drive can be controlled by external devices over a communication network (fieldbus) using the embedded fieldbus interface.

System overview

The drive can be connected to an external control system through a communication link using either a fieldbus adapter or the embedded fieldbus interface.

The embedded fieldbus interface supports the Modbus RTU protocol. The drive control program can handle 10 Modbus registers in a 10-millisecond time level. For example, if the drive receives a request to read 20 registers, it will start its response within 22 ms of receiving the request – 20 ms for processing the request and 2 ms overhead for handling the bus. The actual response time depends on other factors as well, such as the baud rate (a parameter setting in the drive).

The drive can be set to receive all of its control information through the fieldbus interface, or the control can be distributed between the embedded fieldbus interface and other available sources, for example, digital and analog inputs.

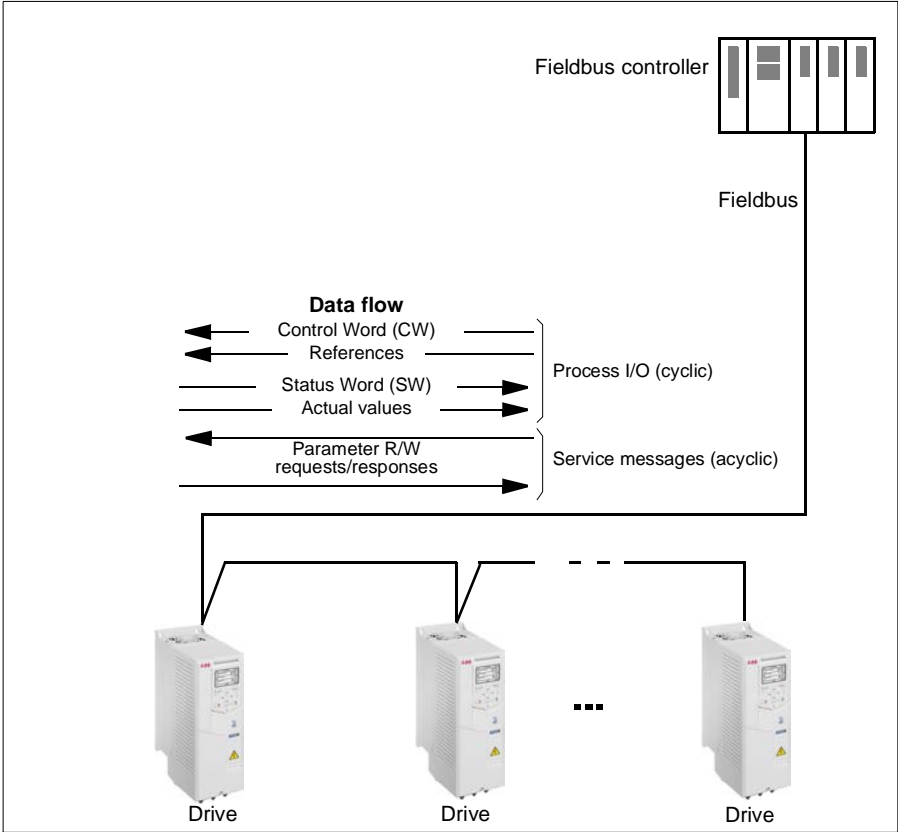

Connecting the drive to the fieldbus

See the Hardware manual of the drive.

Setting up the embedded fieldbus interface

Set the drive up for the embedded fieldbus communication with the parameters shown in the table below. The **Setting for fieldbus control** column gives either the value to use or the default value. The **Function/Information column** gives a description of the parameter.

Parameter	Setting for fieldbus control	Function/Information
COMMUNICATION INITIALIZATION		
58.01 <i>Protocol enable</i>	<i>Modbus RTU</i>	Initializes embedded fieldbus communication.
EMBEDDED MODBUS CONFIGURATION		
58.03 <i>Node address</i>	1 (default)	Node address. There must be no two nodes with the same node address online.
58.04 <i>Baud rate</i>	19.2 <i>kbps</i> (default)	Defines the communication speed of the link. Use the same setting as in the master station.
58.05 <i>Parity</i>	8 <i>EVEN 1</i> (default)	Selects the parity and stop bit setting. Use the same setting as in the master station.
58.14 <i>Communication loss action</i>	<i>No action</i> (default)	Defines the action taken when a communication loss is detected.
58.15 <i>Communication loss mode</i>	<i>Cw / Ref1 / Ref2</i> (default)	Enables/disables communication loss monitoring and defines the means for resetting the counter of the communication loss delay.
58.16 <i>Communication loss time</i>	30.0 s (default)	Defines the timeout limit for the communication monitoring.
58.17 <i>Transmit delay</i>	0 ms (default)	Defines a response delay for the drive.
58.25 <i>Control profile</i>	<i>ABB Drives</i> (default)	Selects the control profile used by the drive. See section <i>Basics of the embedded fieldbus interface</i> (page 254).
58.26 <i>EFB ref1 type</i> 58.27 <i>EFB ref2 type</i>	<i>Speed or frequency</i> (default for 58.26), <i>Transparent, General, Speed, Frequency</i>	Defines the types of fieldbus references 1 and 2. The scaling for each reference type is defined by parameters 46.01...46.03. With the <i>Speed or frequency</i> setting, the type is selected automatically according to the currently active drive control mode.
58.28 <i>EFB act1 type</i> 58.29 <i>EFB act2 type</i>	<i>Speed or frequency</i> (default for 58.28), <i>Transparent</i> (default for 58.29), <i>General, Speed, Frequency</i>	Defines the types of actual values 1 and 2. The scaling for each actual value type is defined by parameters 46.01...46.03. With the <i>Speed or frequency</i> setting, the type is selected automatically according to the currently active drive control mode.

Parameter	Setting for fieldbus control	Function/Information
58.31 <i>EFB act1</i> 58.32 <i>transparent source</i> <i>EFB act2</i> <i>transparent source</i>	<i>Not selected</i>	Defines the source of actual values 1 and 2 when the <i>58.26 EFB ref1 type</i> (<i>58.27 EFB ref2 type</i>) is set to <i>Transparent</i> .
58.33 <i>Addressing mode</i>	<i>Mode 0</i> (default)	Defines the mapping between parameters and holding registers in the 400001...465536 (100...65535) Modbus register range.
58.34 <i>Word order</i>	<i>LO-HI</i> (default)	Defines the order of the data words in the Modbus message frame.
58.101 <i>Data I/O 1</i> ... 58.114 <i>Data I/O 14</i>	For example, the default settings (I/Os 1...6 contain the control word, the status word, two references and two actual values) <i>RO/DIO control word, AO1 data storage, AO2 data storage, Feedback data storage, Setpoint data storage</i>	Defines the address of the drive parameter which the Modbus master accesses when it reads from or writes to the register address corresponding to Modbus In/Out parameters. Select the parameters that you want to read or write through the Modbus I/O words. These settings write the incoming data into storage parameters <i>10.99 RO/DIO control word, 13.91 AO1 data storage, 13.92 AO2 data storage, 40.91 Feedback data storage</i> or <i>40.92 Setpoint data storage</i> .
58.06 <i>Communication control</i>	<i>Refresh settings</i>	Validates the settings of the configuration parameters.

8

The new settings will take effect when the drive is powered up the next time, or when they are validated by parameter *58.06 Communication control* (*Refresh settings*).

Setting the drive control parameters

After the embedded fieldbus interface has been set up, check and adjust the drive control parameters listed in the table below. The **Setting for fieldbus control** column gives the value or values to use when the embedded fieldbus signal is the desired source or destination for that particular drive control signal. The

Function/Information column gives a description of the parameter.

Parameter	Setting for fieldbus control	Function/Information
CONTROL COMMAND SOURCE SELECTION		
<i>20.01 Ext1 commands</i>	<i>Embedded fieldbus</i>	Selects fieldbus as the source for the start and stop commands when EXT1 is selected as the active control location.

Parameter	Setting for fieldbus control	Function/Information
20.06 Ext2 commands	Embedded fieldbus	Selects fieldbus as the source for the start and stop commands when EXT2 is selected as the active control location.

SPEED REFERENCE SELECTION

22.11 Ext1 speed ref1	EFB ref1	Selects a reference received through the embedded fieldbus interface as speed reference 1.
22.18 Ext2 speed ref1	EFB ref1	Selects a reference received through the embedded fieldbus interface as speed reference 2.

FREQUENCY REFERENCE SELECTION

28.11 Ext1 frequency ref1	EFB ref1	Selects a reference received through the embedded fieldbus interface as frequency reference 1.
28.15 Ext2 frequency ref1	EFB ref1	Selects a reference received through the embedded fieldbus interface as frequency reference 2.

OTHER SELECTIONS

EFB references can be selected as the source at virtually any signal selector parameter by selecting *Other*, then either [03.09 EFB reference 1](#) or [03.10 EFB reference 2](#).

SYSTEM CONTROL INPUTS

96.07 Parameter save manually	Save (reverts to Done)	Saves parameter value changes (including those made through fieldbus control) to permanent memory.
---	---	--

Basics of the embedded fieldbus interface

The cyclic communication between a fieldbus system and the drive consists of 16-bit data words or 32-bit data words (with a transparent control profile).

The diagram below illustrates the operation of the embedded fieldbus interface. The signals transferred in the cyclic communication are explained further below the diagram.

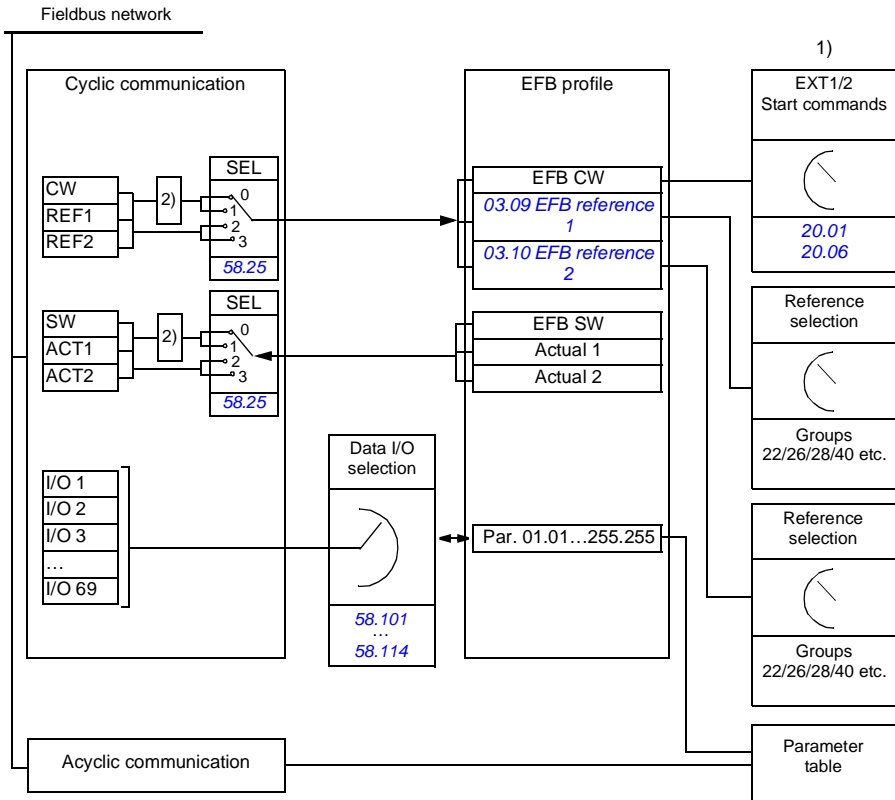

1. See also other parameters which can be controlled through fieldbus.
2. Data conversion if parameter 58.25 Control profile is set to *ABB Drives*. See section *About the control profiles* (page 257).

■ Control word and Status word

The Control Word (CW) is a 16-bit or 32-bit packed boolean word. It is the principal means of controlling the drive from a fieldbus system. The CW is sent by the fieldbus controller to the drive. With drive parameters, the user selects the EFB CW as the source of drive control commands (such as start/stop, emergency stop, selection between external control locations EXT1 and EXT2, or fault reset). The drive switches between its states according to the bit-coded instructions of the CW.

The fieldbus CW is either written to the drive as it is or the data is converted. See section [About the control profiles](#) (page 257).

The fieldbus Status Word (SW) is a 16-bit or 32-bit packed boolean word. It contains status information from the drive to the fieldbus controller. The drive SW is either written to the fieldbus SW as it is or the data is converted. See section [About the control profiles](#) (page 257).

■ References

EFB references 1 and 2 are 16-bit or 32-bit signed integers. The contents of each reference word can be used as the source of virtually any signal, such as the speed, frequency, torque or process reference. In embedded fieldbus communication, references 1 and 2 are displayed by [03.09 EFB reference 1](#) and [03.10 EFB reference 2](#) respectively. Whether the references are scaled or not depends on the settings of [58.26 EFB ref1 type](#) and [58.27 EFB ref2 type](#). See section [About the control profiles](#) (page 257).

■ Actual values

Fieldbus actual signals (ACT1 and ACT2) are 16-bit or 32-bit signed integers. They convey selected drive parameter values from the drive to the master. Whether the actual values are scaled or not depends on the settings of [58.28 EFB act1 type](#) and [58.29 EFB act2 type](#). See section [About the control profiles](#) (page 257).

■ Data input/outputs

Data input/outputs are 16-bit or 32-bit words containing selected drive parameter values. Parameters [58.101 Data I/O 1](#) ... [58.114 Data I/O 14](#) define the addresses from which the master either reads data (input) or to which it writes data (output).

■ Register addressing

The address field of Modbus requests for accessing holding registers is 16 bits. This allows the Modbus protocol to support addressing of 65536 holding registers.

Historically, Modbus master devices used 5-digit decimal addresses from 40001 to 49999 to represent holding register addresses. The 5-digit decimal addressing limited to 9999 the number of holding registers that could be addressed.

Modern Modbus master devices typically provide a means to access the full range of 65536 Modbus holding registers. One of these methods is to use 6-digit decimal addresses from 400001 to 465536. This manual uses 6-digit decimal addressing to represent Modbus holding register addresses.

Modbus master devices that are limited to the 5-digit decimal addressing may still access registers 400001 to 409999 by using 5-digit decimal addresses 40001 to 49999. Registers 410000-465536 are inaccessible to these masters.

See parameter [58.33 Addressing mode](#).

Note: Register addresses of 32-bit parameters cannot be accessed by using 5-digit register numbers.

About the control profiles

A control profile defines the rules for data transfer between the drive and the fieldbus master, for example:

- if packed boolean words are converted and how
- if signal values are scaled and how
- how drive register addresses are mapped for the fieldbus master.

You can configure the drive to receive and send messages according to one of the two profiles:

- [ABB Drives](#)
- [DCU Profile](#).

For the ABB Drives profile, the embedded fieldbus interface of the drive converts the fieldbus data to and from the native data used in the drive. The DCU Profile involves no data conversion or scaling. The figure below illustrates the effect of the profile selection.

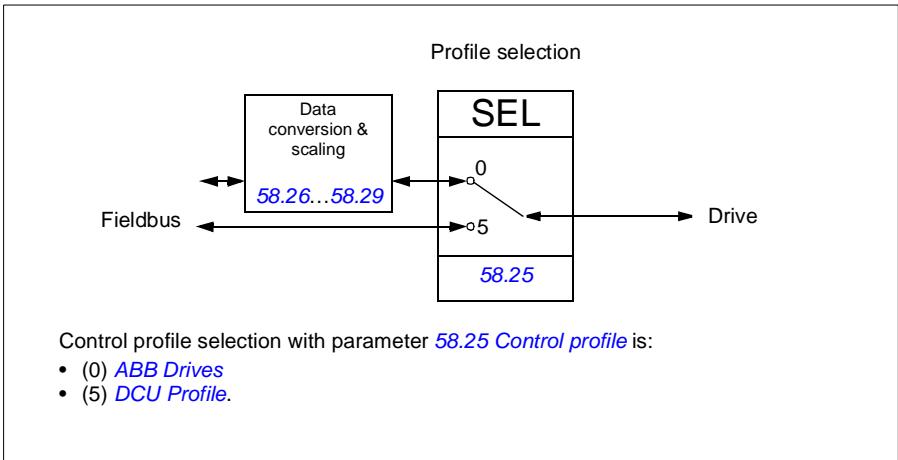

Control Word

Control Word for the ABB Drives profile

The table below shows the contents of the fieldbus Control Word for the ABB Drives control profile. The embedded fieldbus interface converts this word to the form in which it is used in the drive. The upper case boldface text refers to the states shown in [State transition diagram for the ABB Drives profile](#) on page 265.

Bit	Name	Value	STATE/Description
0	OFF1_ CONTROL	1	Proceed to READY TO OPERATE .
		0	Stop along currently active deceleration ramp. Proceed to OFF1 ACTIVE ; proceed to READY TO SWITCH ON unless other interlocks (OFF2, OFF3) are active.
1	OFF2_ CONTROL	1	Continue operation (OFF2 inactive).
		0	Emergency OFF, coast to stop. Proceed to OFF2 ACTIVE , proceed to SWITCH-ON INHIBITED .
2	OFF3_ CONTROL	1	Continue operation (OFF3 inactive).
		0	Emergency stop, stop within time defined by drive parameter. Proceed to OFF3 ACTIVE ; proceed to SWITCH-ON INHIBITED . Warning: Ensure that the motor and driven machine can be stopped using this stop mode.
3	INHIBIT_ OPERATION	1	Proceed to OPERATION ENABLED . Note: Run permissive signal must be active; see the drive documentation. If the drive is set to receive the Run permissive signal from the fieldbus, this bit activates the signal.
		0	Inhibit operation. Proceed to OPERATION INHIBITED .
4	RAMP_OUT_ ZERO	1	Normal operation. Proceed to RAMP FUNCTION GENERATOR: OUTPUT ENABLED .
		0	Force Ramp Function Generator output to zero. Drive ramps to stop (current and DC voltage limits in force).
5	RAMP_HOLD	1	Enable ramp function. Proceed to RAMP FUNCTION GENERATOR: ACCELERATOR ENABLED .
		0	Halt ramping (Ramp Function Generator output held).
6	RAMP_IN_ ZERO	1	Normal operation. Proceed to OPERATING . Note: This bit is effective only if the fieldbus interface is set as the source for this signal by drive parameters.
		0	Force Ramp Function Generator input to zero.
7	RESET	0=>1	Fault reset if an active fault exists. Proceed to SWITCH-ON INHIBITED . Note: This bit is effective only if the fieldbus interface is set as the source for this signal by drive parameters.
		0	Continue normal operation.

Bit	Name	Value	STATE/Description
8	Reserved		
9	Reserved		
10	REMOTE_CMD	1	Fieldbus control d.
		0	Control Word <> 0 or Reference <> 0: Retain last Control Word and Reference. Control Word = 0 and Reference = 0: Fieldbus control d. Reference and deceleration/acceleration ramp are locked.
11	EXT_CTRL_LOC	1	Select External Control Location EXT2. Effective if the control location is parameterized to be selected from the fieldbus.
		0	Select External Control Location EXT1. Effective if the control location is parameterized to be selected from the fieldbus.
12	USER_0		Writable control bits that can be combined with drive logic for application-specific functionality.
13	USER_1		
14	USER_2		
15	USER_3		

■ Control Word for the DCU Profile

The embedded fieldbus interface writes the fieldbus Control Word as is to the drive Control Word bits 0 to 15. Bits 16 to 32 of the drive Control Word are not in use.

Bit	Name	Value	State/Description
0	STOP	1	Stop according to the Stop Mode parameter or the stop mode request bits (bits 7...9).
		0	(no op)
1	START	1	Start the drive.
		0	(no op)
2	REVERSE	1	Reverse direction of motor rotation.
		0	Direction of motor rotation depends on the sign of reference: Positive reference: Forward Negative reference: Reverse.
3	Reserved		
4	RESET	0=>1	Fault reset if an active fault exists.
		0	(no op)
5	EXT2	1	Select External control location EXT2. Effective if the control location is parameterized to be selected from the fieldbus.
		0	Select External control location EXT1. Effective if the control location is parameterized to be selected from the fieldbus.

Bit	Name	Value	State/Description
6	RUN_DISABLE	1	Run disable. If the drive is set to receive the run enable signal from the fieldbus, this bit deactivates the signal.
		0	Run enable. If the drive is set to receive the run enable signal from the fieldbus, this bit activates the signal.
7	STOPMODE_RAMP	1	Normal ramp stop mode
		0	(no op) Default to parameter stop mode if bits 7...9 are all 0.
8	STOPMODE_EMERGENCY_RAMP	1	Emergency ramp stop mode.
		0	(no op) Default to parameter stop mode if bits 7...9 are all 0.
9	STOPMODE_COAST	1	Coast stop mode.
		0	(no op) Default to parameter stop mode if bits 7...9 are all 0.
10	RAMP_PAIR_2	1	Select ramp set 2 (Acceleration time 2 / Deceleration time 2) when parameter 23.11 Ramp set selection is set to EFB DCU CW bit 10
		0	Select ramp set 1 (Acceleration time 1 / Deceleration time 1) when parameter 23.11 Ramp set selection is set to EFB DCU CW bit 10 .
11	RAMP_OUT_ZERO	1	Force Ramp Function Generator output to zero. Drive ramps to stop (current and DC voltage limits in force).
		0	Normal operation.
12	RAMP_HOLD	1	Halt ramping (Ramp Function Generator output held).
		0	Normal operation.
13	RAMP_IN_ZERO	1	Force Ramp Function Generator input to zero.
		0	Normal operation.
14	REQ_LOCAL_LOCK	1	Drive does not switch to local control mode (see parameter 19.18 HAND/OFF disable source).
		0	Drive can switch between local and external control modes.
15	TORQ_LIM_PAIR_2	1	Select torque limit set 2 (Minimum torque 2 / Maximum torque 2) when parameter 30.18 Torq lim sel is set to EFB .
		0	Select torque limit set 1 (Minimum torque 1 / Maximum torque 1) when parameter 30.18 Torq lim sel is set to EFB .
16	FB_LOCAL_CTL	1	Local mode for control from the fieldbus is requested. Steal control from the active source.
		0	(no op)
17	FB_LOCAL_REF	1	Local mode for reference from the fieldbus is requested. Steal reference from the active source.
		0	(no op)
18	Reserved for RUN_DISABLE_1		Not yet implemented.

Bit	Name	Value	State/Description
19	Reserved		
20	Reserved		
21	Reserved		
22	USER_0		Writable control bits that can be combined with drive logic for application-specific functionality.
23	USER_1		
24	USER_2		
25	USER_3		
26... 31	Reserved		

Status Word

■ Status Word for the ABB Drives profile

The table below shows the fieldbus Status Word for the ABB Drives control profile. The embedded fieldbus interface converts the drive Status Word into this form for the fieldbus. The upper case boldface text refers to the states shown in [State transition diagram for the ABB Drives profile](#) on page 265.

Bit	Name	Value	STATE/Description
0	RDY_ON	1	READY TO SWITCH ON.
		0	NOT READY TO SWITCH ON.
1	RDY_RUN	1	READY TO OPERATE.
		0	OFF1 ACTIVE.
2	RDY_REF	1	OPERATION ENABLED.
		0	OPERATION INHIBITED.
3	TRIPPED	1	FAULT.
		0	No fault.
4	OFF_2_STATUS	1	OFF2 inactive.
		0	OFF2 ACTIVE.
5	OFF_3_STATUS	1	OFF3 inactive.
		0	OFF3 ACTIVE.
6	SWC_ON_INHIB	1	SWITCH-ON INHIBITED.
		0	–
7	ALARM	1	Warning/Alarm.
		0	No warning/alarm.
8	AT_SETPOINT	1	OPERATING. Actual value equals Reference (is within tolerance limits, for example, in speed control, speed error is 10% max. of nominal motor speed).
		0	Actual value differs from Reference (is outside tolerance limits).
9	REMOTE	1	Drive control location: REMOTE (EXT1 or EXT2).
		0	Drive control location: LOCAL.
10	ABOVE_LIMIT	1	Actual frequency or speed equals or exceeds supervision limit (set by drive parameter). Valid in both directions of rotation. Set by drive parameters 46.31 Above speed limit and 46.32 Above frequency limit . These parameters are indicated by bit 10 of 06.11 Main status word .
		0	Actual frequency or speed within supervision limit.

Bit	Name	Value	STATE/Description
11	USER_0		Status bits that can be combined with drive logic for application-specific functionality.
12	USER_1		
13	USER_2		
14	USER_3		
15	Reserved		

■ Status Word for the DCU Profile

The embedded fieldbus interface writes the drive Status Word bits 0 to 15 to the fieldbus Status Word as is.

Bit	Name	Value	State/Description
0	READY	1	Drive is ready to receive the start command.
		0	Drive is not ready.
1	ENABLED	1	Run permissive and all start interlocks are active.
		0	Run permissive and all start interlocks are not active.
2	STARTED	1	Drive has received start command.
		0	Drive has not received start command.
3	RUNNING	1	Drive is modulating.
		0	Drive is not modulating.
4	ZERO_SPEED	1	Drive is at zero speed.
		0	Drive is not at zero speed.
5	ACCELERATING	1	Drive speed is increasing.
		0	Drive speed is not increasing.
6	DECELERATING	1	Drive speed is decreasing.
		0	Drive speed is not decreasing.
7	AT_SETPOINT	1	Drive is at setpoint.
		0	Drive is not at setpoint.
8	LIMIT	1	Drive operation is limited.
		0	Drive operation is not limited.
9	SUPERVISION	1	Actual value (speed, frequency or torque) is above a limit. Limit is set with parameters 46.31 Above speed limit and 46.32 Above frequency limit .
		0	Actual value (speed, frequency or torque) is within limits.
10	REVERSE_REF	1	Drive reference is in the reverse direction.
		0	Drive reference is in the forward direction
11	REVERSE_ACT	1	Drive is running in the reverse direction
		0	Drive is running in the forward direction

Bit	Name	Value	State/Description
12	PANEL_LOCAL	1	Control panel/keypad (or PC tool) is in local control mode.
		0	Control panel/keypad (or PC tool) is not in local control mode.
13	FIELDBUS_LOCAL	1	Fieldbus is in local control mode.
		0	Fieldbus is not in local control mode.
14	EXT2_ACT	1	External control location EXT2 is active.
		0	External control location EXT1 is active.
15	FAULT	1	Drive is faulted.
		0	Drive is not faulted.
16	ALARM	1	Warning/Alarm is active.
		0	No warning/alarm.
17	Reserved		
18	DIRLOCK	1	Direction lock is ON. (Direction change is locked out.)
		0	Direction lock is OFF.
19	LOCALLOCK	1	Local mode lock is ON. (Local mode is locked out.)
		0	Local mode lock is OFF.
20	CTL_MODE	1	Vector motor control mode is active.
		0	Scalar motor control mode is active.
21	Reserved		
22	USER_0		Status bits that can be combined with drive logic for application-specific functionality.
23	USER_1		
24	USER_2		
25	USER_3		
26	REQ_CTL	1	Control has been granted to this channel.
		0	Control has not been granted to this channel.
27	REQ_REF1	1	Reference 1 has been requested in this channel.
		0	Reference 1 has not been requested in this channel.
28	REQ_REF2	1	Reference 2 has been requested in this channel.
		0	Reference 2 has not been requested in this channel.
29... 31	Reserved		

State transition diagrams

■ State transition diagram for the ABB Drives profile

The diagram below shows the state transitions in the drive when the drive is using the ABB Drives profile and the drive is configured to follow the commands of the control word from the embedded fieldbus interface. The upper case texts refer to the states which are used in the tables representing the fieldbus Control and Status words. See sections [Control Word for the ABB Drives profile](#) on page 258 and [Status Word for the ABB Drives profile](#) on page 262.

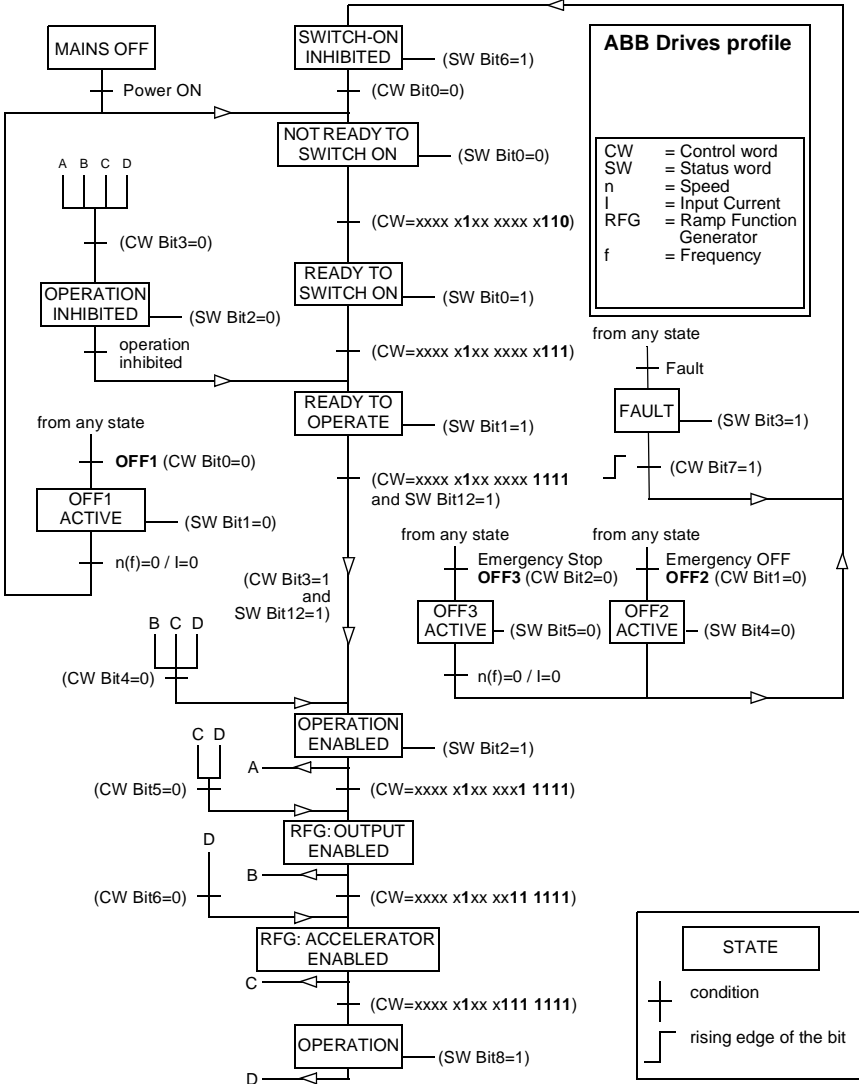

The start and stop sequences are given below.

Control word:

Start:

- 1142 (476h) → NOT READY TO SWITCH ON
- If MSW bit 0 = 1 then
 - 1150 (47Eh) → READY TO SWITCH ON (Stopped)
 - 1151 (47Fh) → OPERATION (Running)

Stop:

- 1143 (477h) = Stop according to [21.03 Stop mode](#) (Preferred)
- 1150 (47Eh) = OFF1 ramp stop (Note: uninterruptable ramp stop)
- 1149 (47Dh) = OFF2 emergency coast to stop
- 1147 (47Bh) = OFF3 emergency ramp stop

Fault reset:

- Rising edge of MCW bit 7

Start after STO:

- If [31.22 STO indication run/stop](#) is not Fault/ Fault, check that [06.18 Start inhibit status word](#), bit 7 STO = 0 before giving a start command.

References

■ References for the ABB Drives profile and DCU Profile

The ABB Drives profile supports the use of two references, EFB reference 1 and EFB reference 2. The references are 16-bit words each containing a sign bit and a 15-bit integer. A negative reference is formed by calculating the two's complement from the corresponding positive reference.

The references are scaled as defined by parameters [46.01...46.04](#); which scaling is in use depends on the setting of [58.26 EFB ref1 type](#) and [58.27 EFB ref2 type](#).

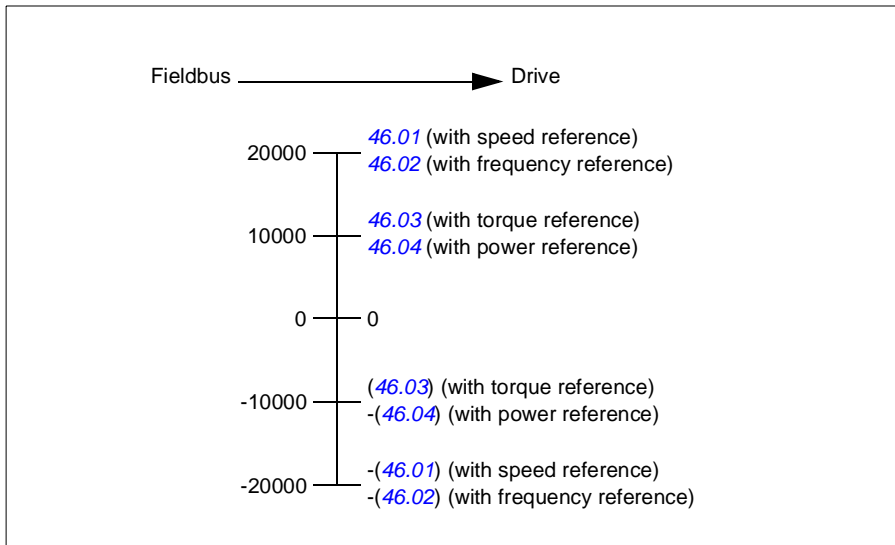

The scaled references are shown by parameters [03.09 EFB reference 1](#) and [03.10 EFB reference 2](#).

Actual values

Actual values for the ABB Drives profile and DCU Profile

The ABB Drives profile supports the use of two fieldbus actual values, ACT1 and ACT2. The actual values are 16-bit words each containing a sign bit and a 15-bit integer. A negative value is formed by calculating the two's complement from the corresponding positive value.

The actual values are scaled as defined by parameters [46.01...46.04](#); which scaling is in use depends on the setting of parameters [58.28 EFB act1 type](#) and [58.29 EFB act2 type](#).

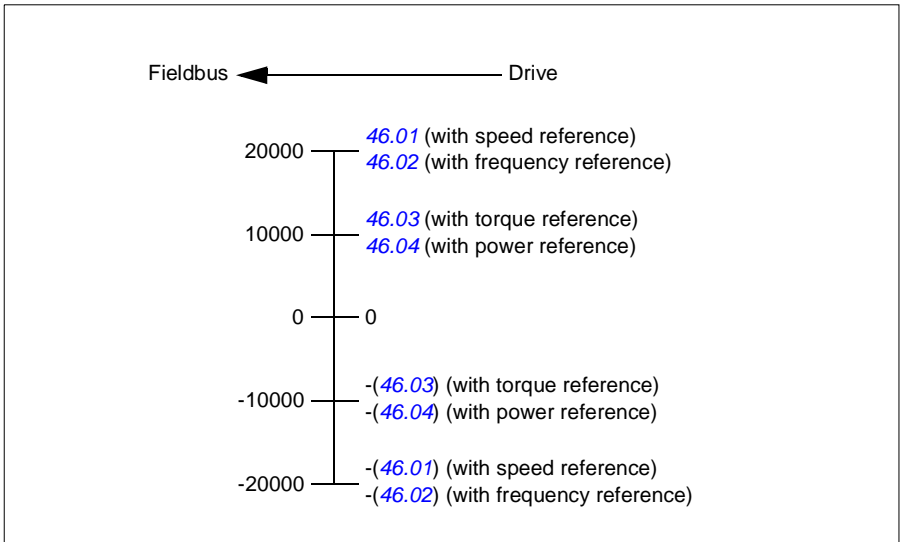

Modbus holding register addresses

■ Modbus holding register addresses for the ABB Drives profile and DCU Profile

The table below shows the default Modbus holding register addresses for the drive data with the ABB Drives profile. This profile provides a converted 16-bit access to the drive data.

Note: Only the 16 least significant bits of the drive's 32-bit Control and Status Words can be accessed.

Note: Bits 16 through 32 of the DCU Control/Status word are not in use if 16-bit control/status word is used with the DCU Profile.

Register address	Register data (16-bit words)
400001	Default: Control word (<i>CW 16bit</i>). See sections <i>Control Word for the ABB Drives profile</i> (page 258) and <i>Control Word for the DCU Profile</i> (page 259). The selection can be changed using parameter <i>58.101 Data I/O 1</i> .
400002	Default: Reference 1 (<i>Ref1 16bit</i>). The selection can be changed using parameter <i>58.102 Data I/O 2</i> .
400003	Default: Reference 2 (<i>Ref2 16bit</i>). The selection can be changed using parameter <i>58.103 Data I/O 3</i> .
400004	Default: Status Word (<i>SW 16bit</i>). See sections <i>Status Word for the ABB Drives profile</i> (page 262) and <i>Status Word for the DCU Profile</i> (page 263). The selection can be changed using parameter <i>58.104 Data I/O 4</i> .
400005	Default: Actual value 1 (<i>Act1 16bit</i>). The selection can be changed using parameter <i>58.105 Data I/O 5</i> .
400006	Actual value 2 (<i>Act2 16bit</i>). The selection can be changed using parameter <i>58.106 Data I/O 6</i> .
400007...400014	Data in/out 7...14. Selected by parameters <i>58.107 Data I/O 7...58.114 Data I/O 14</i> .
400015...400089	Unused
400090...400100	Error code access. See section <i>Error code registers (holding registers 400090...400100)</i> (page 277).
400101...465536	Parameter read/write. Parameters are mapped to register addresses according to parameter <i>58.33 Addressing mode</i> .

Modbus function codes

The table below shows the Modbus function codes supported by the embedded fieldbus interface.

Code	Function name	Description
01h	Read Coils	Reads the 0/1 status of coils (0X references).
02h	Read Discrete Inputs	Reads the 0/1 status of discrete inputs (1X references).
03h	Read Holding Registers	Reads the binary contents of holding registers (4X references).
05h	Write Single Coil	Forces a single coil (0X reference) to 0 or 1.
06h	Write Single Register	Writes a single holding register (4X reference).
08h	Diagnostics	Provides a series of tests for checking the communication, or for checking various internal error conditions. Supported subcodes: <ul style="list-style-type: none"> • 00h Return Query Data: Echo/loopback test. • 01h Restart Comm Option: Restarts and initializes the EFB, clears communications event counters. • 04h Force Listen Only Mode • 0Ah Clear Counters and Diagnostic Register • 0Bh Return Bus Message Count • 0Ch Return Bus Comm. Error Count • 0Dh Return Bus Exception Error Count • 0Eh Return Slave Message Count • 0Fh Return Slave No Response Count • 10h Return Slave NAK (negative acknowledge) Count • 11h Return Slave Busy Count • 12h Return Bus Character Overrun Count • 14h Clear Overrun Counter and Flag
0Bh	Get Comm Event Counter	Returns a status word and an event count.
0Fh	Write Multiple Coils	Forces a sequence of coils (0X references) to 0 or 1.
10h	Write Multiple Registers	Writes the contents of a contiguous block of holding registers (4X references).
16h	Mask Write Register	Modifies the contents of a 4X register using a combination of an AND mask, an OR mask, and the register's current contents.

Code	Function name	Description
17h	Read/Write Multiple Registers	Writes the contents of a contiguous block of 4X registers, then reads the contents of another group of registers (the same or different than those written) in a server device.
2Bh / 0Eh	Encapsulated Interface Transport	<p>Supported subcodes:</p> <ul style="list-style-type: none"> • 0Eh Read Device Identification: Allows reading the identification and other information. <p>Supported ID codes (access type):</p> <ul style="list-style-type: none"> • 00h: Request to get the basic device identification (stream access) • 04h: Request to get one specific identification object (individual access) <p>Supported Object IDs:</p> <ul style="list-style-type: none"> • 00h: Vendor Name ("ABB") • 01h: Product Code (for example, "AHVKA") • 02h: Major Minor Revision (combination of contents of parameters 07.05 Firmware version and 58.02 Protocol ID). • 03h: Vendor URL ("www.abb.com") • 04h: Product name: ("ACH480").

Exception codes

The table below shows the Modbus exception codes supported by the embedded fieldbus interface.

8

Code	Name	Description
01h	ILLEGAL FUNCTION	The function code received in the query is not an allowable action for the server.
02h	ILLEGAL ADDRESS	The data address received in the query is not an allowable address for the server.
03h	ILLEGAL VALUE	The requested quantity of registers is larger than the device can handle. This error does not mean that a value written to the device is outside of the valid range.
04h	DEVICE FAILURE	An unrecoverable error occurred while the server was attempting to perform the requested action. See section Error code registers (holding registers 400090...400100) on page 277.

Coils (0xxxx reference set)

Coils are 1-bit read/write values. Control Word bits are exposed with this data type. The table below summarizes the Modbus coils (0xxxx reference set). Note that the references are 1-based index which match the address transmitted on the wire.

Reference	ABB Drives profile	DCU Profile
000001	OFF1_CONTROL	STOP
000002	OFF2_CONTROL	START
000003	OFF3_CONTROL	Reserved
000004	INHIBIT_OPERATION	Reserved
000005	RAMP_OUT_ZERO	RESET
000006	RAMP_HOLD	EXT2
000007	RAMP_IN_ZERO	RUN_DISABLE
000008	RESET	STOPMODE_RAMP
000009	Not for ACH480	STOPMODE_EMERGENCY_RAMP
000010	Not for ACH480	STOPMODE_COAST
000011	REMOTE_CMD	Reserved
000012	EXT_CTRL_LOC	RAMP_OUT_ZERO
000013	USER_0	RAMP_HOLD
000014	USER_1	RAMP_IN_ZERO
000015	USER_2	Reserved
000016	USER_3	Reserved
000017	Reserved	FB_LOCAL_CTL
000018	Reserved	FB_LOCAL_REF
000019	Reserved	Reserved
000020	Reserved	Reserved
000021	Reserved	Reserved
000022	Reserved	Reserved
000023	Reserved	USER_0
000024	Reserved	USER_1
000025	Reserved	USER_2
000026	Reserved	USER_3
000027	Reserved	Reserved
000028	Reserved	Reserved
000029	Reserved	Reserved
000030	Reserved	Reserved
000031	Reserved	Reserved
000032	Reserved	Reserved

Reference	ABB Drives profile	DCU Profile
000033	Control for relay output RO1 (parameter <i>10.99 RO/DIO control word</i> , bit 0)	Control for relay output RO1 (parameter <i>10.99 RO/DIO control word</i> , bit 0)
000034	Control for relay output RO2 (parameter <i>10.99 RO/DIO control word</i> , bit 1)	Control for relay output RO2 (parameter <i>10.99 RO/DIO control word</i> , bit 1)
000035	Control for relay output RO3 (parameter <i>10.99 RO/DIO control word</i> , bit 2)	Control for relay output RO3 (parameter <i>10.99 RO/DIO control word</i> , bit 2)
000036	Control for relay output RO4 (parameter <i>10.99 RO/DIO control word</i> , bit 3)	Control for relay output RO4 (parameter <i>10.99 RO/DIO control word</i> , bit 3)
000037	Control for relay output RO5 (parameter <i>10.99 RO/DIO control word</i> , bit 4)	Control for relay output RO5 (parameter <i>10.99 RO/DIO control word</i> , bit 4)
000038	Control for relay output RO6 (parameter <i>10.99 RO/DIO control word</i> , bit 5)	Control for relay output RO6 (parameter <i>10.99 RO/DIO control word</i> , bit 5)
000039	Control for relay output RO7 (parameter <i>10.99 RO/DIO control word</i> , bit 6)	Control for relay output RO7 (parameter <i>10.99 RO/DIO control word</i> , bit 6)
000040	Control for relay output DO1 (parameter <i>10.99 RO/DIO control word</i> , bit 8)	Control for relay output DO1 (parameter <i>10.99 RO/DIO control word</i> , bit 8)

Discrete inputs (1xxxx reference set)

Discrete inputs are 1-bit read-only values. Status Word bits are exposed with this data type. The table below summarizes the Modbus discrete inputs (1xxxx reference set). Note that the references are 1-based index which match the address transmitted on the wire.

Reference	ABB Drives profile	DCU Profile
100001	RDY_ON	READY
100002	RDY_RUN	D
100003	RDY_REF	Reserved
100004	TRIPPED	RUNNING
100005	OFF_2_STATUS	ZERO_SPEED
100006	OFF_3_STATUS	Reserved
100007	SWC_ON_INHIB	Reserved
100008	ALARM	AT_SETPOINT
100009	AT_SETPOINT	LIMIT
100010	REMOTE	SUPERVISION
100011	ABOVE_LIMIT	Reserved
100012	USER_0	Reserved
100013	USER_1	PANEL_LOCAL
100014	USER_2	FIELDBUS_LOCAL
100015	USER_3	EXT2_ACT
100016	Reserved	FAULT
100017	Reserved	ALARM
100018	Reserved	Reserved
100019	Reserved	Reserved
100020	Reserved	Reserved
100021	Reserved	CTL_MODE
100022	Reserved	Reserved
100023	Reserved	USER_0
100024	Reserved	USER_1
100025	Reserved	USER_2
100026	Reserved	USER_3
100027	Reserved	REQ_CTL
100028	Reserved	Reserved
100029	Reserved	Reserved
100030	Reserved	Reserved
100031	Reserved	Reserved
100032	Reserved	Reserved

Reference	ABB Drives profile	DCU Profile
100033	Delayed status of digital input DI1 (parameter 10.02 DI delayed status , bit 0)	Delayed status of digital input DI1 (parameter 10.02 DI delayed status , bit 0)
100034	Delayed status of digital input DI2 (parameter 10.02 DI delayed status , bit 1)	Delayed status of digital input DI2 (parameter 10.02 DI delayed status , bit 1)
100035	Delayed status of digital input DI3 (parameter 10.02 DI delayed status , bit 2)	Delayed status of digital input DI3 (parameter 10.02 DI delayed status , bit 2)
100036	Delayed status of digital input DI4 (parameter 10.02 DI delayed status , bit 3)	Delayed status of digital input DI4 (parameter 10.02 DI delayed status , bit 3)
100037	Delayed status of digital input DI5 (parameter 10.02 DI delayed status , bit 4)	Delayed status of digital input DI5 (parameter 10.02 DI delayed status , bit 4)
100038	Delayed status of digital input DI6 (parameter 10.02 DI delayed status , bit 5)	Delayed status of digital input DI6 (parameter 10.02 DI delayed status , bit 5)

Error code registers (holding registers 400090...400100)

These registers contain information about the last query. The error register is cleared when a query has finished successfully.

Reference	Name	Description
400090	Reset Error Registers	1 = Reset internal error registers (91...95). 0 = Do nothing.
400091	Error Function Code	Function code of the failed query.
400092	Error Code	Set when exception code 04h is generated (see table above). <ul style="list-style-type: none"> • 00h No error • 02h Low/High limit exceeded • 03h Faulty Index: Unavailable index of an array parameter • 05h Incorrect Data Type: Value does not match the data type of the parameter • 65h General Error: Undefined error when handling query
400093	Failed Register	The last register (discrete input, coil, input register or holding register) that failed to be read or written.
400094	Last Register Written Successfully	The last register (discrete input, coil, input register or holding register) that was written successfully.
400095	Last Register Read Successfully	The last register (discrete input, coil, input register or holding register) that was read successfully.

9

BACnet MS/TP control through the embedded fieldbus interface (EFB)

Contents of this chapter

The chapter describes BACnet MS/TP control through the embedded fieldbus interface (EFB): supported functionality, services and objects as well as how to configure the BACnet through the **Primary settings** menu and with parameters.

BACnet overview

BACnet is an open standard for data communication that enables interoperability between different building systems (eg fire, security, lighting, HVAC, elevator, etc.) and devices in building automation and control applications. It enables data sharing among different types of devices from a broad set of suppliers.

You will find BACnet Protocol Implementation Conformance Statement (PICS) (3AXD10000786871 [English]) for the ACH480 in the ABB Document library on the Internet. You can also download the most recent version from <https://www.bacnetinternational.net/btl/>.

Hardware installation

■ Connecting devices to a BACnet MS/TP EIA-485 network

See the hardware manual of the drive, the relevant *Electrical installation* chapter for your region, section *Additional information on the control connections*.

Starting up BACnet communication through the Primary settings menu

The **Primary settings** menu enables easy programming of the most common settings for the drive including BACnet communication settings.

Commissioning	
<input type="checkbox"/> To start up fieldbus communication select Menu > Primary settings > Communication.	<p>The screenshot shows the 'Commissioning' menu with 'ACH480' and '0.0 Hz' at the top. The 'Main menu' is displayed with 'Primary settings' highlighted in black. Other options include 'I/O', 'Diagnostics', and 'Exit' (16:00). A 'Select' button is visible at the bottom right.</p>
<input type="checkbox"/> Select Embedded fieldbus > Communication setup.	<p>The screenshot shows the 'Primary settings' menu with 'ACH480' and '0.0 Hz' at the top. The 'Communication' option is highlighted in black, with 'Off' and a right arrow next to it. Other options include 'Motor', 'Ramps', 'Limits', and 'PID control' (Not selected). A 'Back' button (16:01) and 'Select' button are at the bottom.</p>
	<p>The screenshot shows the 'Embedded fieldbus' menu with 'ACH480' and '0.0 rpm' at the top. The 'Communication setup' option is highlighted in black with a right arrow. Other options include 'Embedded fieldbus' (Off) and 'Fieldbus adapter' (Not used). A 'Back' button (16:02) and 'Select' button are at the bottom.</p>

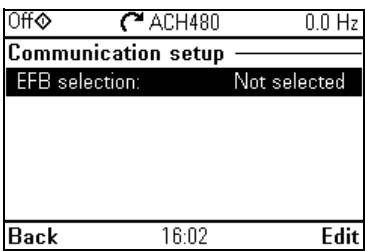
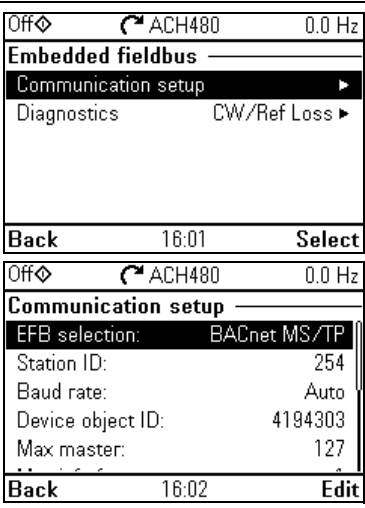
<input type="checkbox"/>	<p>Select EFB selection and then select BACnet MS/TP and press Save.</p>	
<input type="checkbox"/>	<p>To set up BACnet MS/TP parameters select Embedded fieldbus > Communication setup > Roll the screen down to see all rows.</p>	

<input type="checkbox"/>	<p>After setting all necessary parameters, select Apply settings to embedded fieldbus to validate your settings.</p>	<table border="1"> <tr> <td>Off</td> <td>ACH480</td> <td>0.0 Hz</td> </tr> <tr> <td colspan="3">Communication setup</td> </tr> <tr> <td>Max info frames:</td> <td></td> <td>1</td> </tr> <tr> <td>Max APDU retries:</td> <td></td> <td>3</td> </tr> <tr> <td>If communication fails:</td> <td></td> <td>Fault</td> </tr> <tr> <td>Communication unde...:</td> <td></td> <td>CW / Ref1 ...</td> </tr> <tr> <td>Ignore failures shorter than:</td> <td></td> <td>30.0 s</td> </tr> <tr> <td>Back</td> <td>16:03</td> <td>Edit</td> </tr> </table>	Off	ACH480	0.0 Hz	Communication setup			Max info frames:		1	Max APDU retries:		3	If communication fails:		Fault	Communication unde...:		CW / Ref1 ...	Ignore failures shorter than:		30.0 s	Back	16:03	Edit
Off	ACH480	0.0 Hz																								
Communication setup																										
Max info frames:		1																								
Max APDU retries:		3																								
If communication fails:		Fault																								
Communication unde...:		CW / Ref1 ...																								
Ignore failures shorter than:		30.0 s																								
Back	16:03	Edit																								
<input type="checkbox"/>	<p>After validating the settings, press Back twice until you see Pass through I/O on the Communication menu. Select Pass through I/O and then Drive control setup.</p>	<table border="1"> <tr> <td>Off</td> <td>ACH480</td> <td>0.0 Hz</td> </tr> <tr> <td colspan="3">Communication</td> </tr> <tr> <td colspan="3">Embedded fieldbus BACnet MS/TP</td> </tr> <tr> <td>Fieldbus adapter</td> <td></td> <td>Not used</td> </tr> <tr> <td>Pass through I/O</td> <td></td> <td></td> </tr> <tr> <td>Back</td> <td>16:04</td> <td>Select</td> </tr> </table>	Off	ACH480	0.0 Hz	Communication			Embedded fieldbus BACnet MS/TP			Fieldbus adapter		Not used	Pass through I/O			Back	16:04	Select						
Off	ACH480	0.0 Hz																								
Communication																										
Embedded fieldbus BACnet MS/TP																										
Fieldbus adapter		Not used																								
Pass through I/O																										
Back	16:04	Select																								

<input type="checkbox"/> For relay output control through BACnet MS/TP, select Relay outputs and set the source of appropriate relays to EFB.	Off ACH480 0.0 Hz Drive control setup Relay outputs ▶ Analog outputs ▶ <hr/> Back 16:04 Select
	Off ACH480 0.0 Hz Relay outputs R01 Not energized ▶ R02 Custom ▶ R03 Custom ▶ <hr/> Back 16:04 Select
	Off ACH480 0.0 Hz R01 Actual command: 0 Source: EFB/FBA Off delay: 0.0 s On delay: 0.0 s <hr/> Back 16:04 Edit

<input type="checkbox"/> For analog output control through BACnet MS/TP, select Analog outputs and configure the appropriate analog outputs.	Off ◊ ↻ ACH480 0.0 Hz Drive control setup Relay outputs ▶ Analog outputs ▶ Back 16:04 Select
	Off ◊ ↻ ACH480 0.0 Hz Analog outputs A01: 0.000 V Custom ▶ A02: 0.000 mA Custom ▶ Back 16:05 Select
	Off ◊ ↻ ACH480 0.0 Hz A01: Output value: 0.000 V EFB/FBA Source value: 0.00 % Source: Custom Source min: 0.0 % Source max: 50.0 % Back 16:05 View

Starting up fieldbus communication with parameters

9

Follow these steps to setup fieldbus communication with parameters in the **Parameters** menu. For example of appropriate values, see section *Activating drive control functions* on page 285.

1. Power up the drive.
2. Enable BACnet communication by setting parameter *58.01 Protocol enable* to *BACnet MSTP*.
3. Configure network settings with parameters *58.03 Node address* and *58.04 Baud rate*.
4. Define the device object instance value with parameter *58.40 Device object ID*.

- Note:** The object instance value should be unique and in the range 1...4194303.
- Define communication loss function to detect communication loss between EFB and the drive:
 - Set the communication loss mode and communication loss time with parameters [58.15 Communication loss mode](#) and [58.16 Communication loss time](#).
 - Select how the drive reacts to an EFB communication break with parameter [58.14 Communication loss action](#).
 - Save the valid parameter values to permanent memory by setting parameter [96.07 Parameter save manually](#) to *Save*.
 - Validate the settings made in parameter group [58 Embedded fieldbus](#) by setting parameter [58.06 Communication control](#) to *Refresh settings*.
 - You can use parameters [58.07...58.13](#) for diagnostics. You can reset counters [58.08...58.12](#) by setting the parameter value to 0.
 - Set the relevant drive control parameters to control the drive according to the application.

Note: You find all embedded fieldbus parameters in group [58 Embedded fieldbus](#) on page [558](#).

Activating drive control functions

■ Drive control

To enable fieldbus control of various drive functions through BACnet MS/TP, do the following:

- Configure the drive to accept embedded fieldbus communication by enabling BACnet communication and defining the node address and device id for the drive.
- Select the individual control functions to use the embedded fieldbus as a source. This makes the input source come from the corresponding BACnet object.

Note: Change those parameter of the functions that you want to control through BACnet MS/TP. All other parameters can remain as factory default values.

Start/stop direction control

For Start/stop direction control through fieldbus, configure the following drive parameters and set the fieldbus controller supplied command(s) in the appropriate location:

Drive parameter	Value	Description	BACnet object
20.01 Ext1 commands	Embedded fieldbus	Start/stop by fieldbus with Ext1 selected	BV10
20.07 Ext2 commands	Embedded fieldbus	Start/stop by fieldbus with Ext2 selected	BV10

Drive parameter	Value	Description	BACnet object
20.21 Direction	Request	Direction by fieldbus, if required	BV11

Input reference select

The tables below show how to use the BACnet embedded fieldbus to select the drive input references for frequency and speed control modes

- For frequency control, set parameter [99.04 Motor control mode](#) = *Scalar* (default value for ACH480). See section [Frequency reference](#) on page 286 and parameter group [28 Frequency reference chain](#) on page 457.
- For speed control, set parameter [99.04 Motor control mode](#) = *Vector*. See section [Speed reference](#) on page 286 and parameter group [22 Speed reference selection](#) on page 439.

Vector control has better accuracy than scalar control, but vector control cannot be used in all situations. See parameter [99.04 Motor control mode](#).

Frequency reference

For using the BACnet embedded fieldbus to provide input frequency references to the drive, configure the following drive parameters and set the fieldbus controller supplied reference word(s) in the appropriate location:

Drive parameter	Value	Description	BACnet object
19.11 Ext1/Ext2 selection	32 = <i>EFB MCW bit 11</i>	Reference set selection by fieldbus	BV13
28.11 Ext1 frequency ref1	8 = <i>EFB ref1</i> ¹⁾	Frequency reference source 1	AV16 Input Reference1
28.15 Ext2 frequency ref1	9 = <i>EFB ref2</i> ¹⁾	Frequency reference source 2	AV17 Input Reference 2
46.02 Frequency scaling	50.00 Hz ¹⁾	16-bit scaling of frequency-related parameters	No direct BACnet object

¹⁾ As an example

Speed reference

For using the BACnet embedded fieldbus to provide input speed references to the drive, configure the following drive parameters and set the fieldbus controller supplied reference word(s) in the appropriate location:

Drive parameter	Value	Description	BACnet object
19.11 Ext1/Ext2 selection	32 = <i>EFB MCW bit 11</i>	Reference set selection by fieldbus	BV13
22.11 Ext1 speed ref1	8 = <i>EFB ref1</i> ¹⁾	Speed reference source 1	AV16 Input Reference1
22.18 Ext2 speed ref1	9 = <i>EFB ref2</i> ¹⁾	Speed reference source 2	AV17 Input Reference 2
46.01 Speed scaling	1500 rpm ¹⁾	16-bit scaling of speed-related parameters	No direct BACnet object

¹⁾ As an example

Interlocks and permissives

To use the BACnet embedded fieldbus for different drive control functions, configure the following drive parameters and set the fieldbus controller supplied command(s) in the appropriate location:

Drive parameter	Value	Description	BACnet object
20.40 Run permissive	15 = <i>Embedded fieldbus</i>	Run permission by fieldbus	BV12
No direct drive parameter. Via BACnet object the fault reset always goes through.	-	Fault reset via fieldbus	BV14
20.41 Start interlock 1	15 = <i>Embedded fieldbus</i>	Source for start interlock 1 is fieldbus	BV20
20.42 Start interlock 2	15 = <i>Embedded fieldbus</i>	Source for start interlock 2 is fieldbus	BV21

Relay output control

For relay output control through BACnet embedded fieldbus,

- set the following drive parameters to select the source for the ROs
- program the drive for control through BACnet.

Drive parameter	Value	Description	BACnet object
10.24 RO1 source	40 = <i>RO/DIO control word bit0</i>	Relay output 1 controlled by fieldbus	BO0
10.27 RO2 source	41 = <i>RO/DIO control word bit1</i>	Relay output 2 controlled by fieldbus	BO1
10.30 RO3 source	42 = <i>RO/DIO control word bit2</i>	Relay output 3 controlled by fieldbus	BO2
15.07 RO4 source	Other (10.99 RO/DIO control word , bit 3)	Relay output 4 controlled by fieldbus	BO3
15.10 RO5 source	Other (10.99 RO/DIO control word , bit 4)	Relay output 5 controlled by fieldbus	BO4
15.23 DO1 source	Other (10.99 RO/DIO control word , bit 8)	Digital output 1 controlled by fieldbus	BO5

Data point connections

The BACnet objects control parameter [10.99 RO/DIO control word](#) bit values. These bits need to be connected to the corresponding RO and DO sources as above.

Drive parameter	Description	BACnet object
10.99 RO/DIO control word	Storage parameter for relay outputs and digital output	BO0...BO5

Analog output control

For analog output control through BACnet embedded fieldbus, configure the following drive parameters and set the fieldbus controller supplied analog value(s) in the appropriate location:

Drive parameter	Value	Description	BACnet object
13.12 AO1 source	37 = AO1 data storage	Analog output 1 controlled by fieldbus	AO0
13.22 AO2 source	38 = AO2 data storage	Analog output 2 controlled by fieldbus	AO1
13.17 AO1 source min	0.0 ¹⁾	Minimum value of signal selected by parameter 13.12 AO1 source	No direct BACnet object
13.18 AO1 source max	100.0 ¹⁾	Maximum value of signal selected by parameter 13.12 AO1 source	No direct BACnet object
13.27 AO2 source min	0.0 ¹⁾	Minimum value of signal selected by parameter 13.22 AO2 source	No direct BACnet object
13.28 AO2 source max	100.0 ¹⁾	Maximum value of signal selected by parameter 13.22 AO2 source	No direct BACnet object

¹⁾ As an example

Data point connections

The BACnet objects control parameters [13.91 AO1 data storage](#) and [13.92 AO2 data storage](#) values. These values need to be connected to the corresponding AO sources as above.

Drive parameter	Description	BACnet object
13.91 AO1 data storage	Storage parameter for AO1	AO0
13.92 AO2 data storage	Storage parameter for AO2	AO1

PID control

For PID control through BACnet embedded fieldbus, configure the following drive parameters and set the fieldbus controller supplied PID value(s) in the appropriate location:

Drive parameter	Value	Description	BACnet object
40.08 Set 1 feedback 1 source	10 = Feedback data storage	Feedback 1 source data storage	AV43
40.09 Set 1 feedback 2 source	10 = Feedback data storage	Feedback 2 source data storage	AV43
40.16 Set 1 setpoint 1 source	24 = Setpoint data storage	Setpoint 1 source data storage	AV42
40.17 Set 1 setpoint 2 source	24 = Setpoint data storage	Setpoint 2 source data storage	AV42

Data point connections

The BACnet objects control parameters [40.91 Feedback data storage](#) and [40.92 Setpoint data storage](#). These values need to be connected to the corresponding PID setpoint and feedback values as above.

Drive parameter	Description	BACnet object
40.91 Feedback data storage	Storage parameter for process feedback value	AV43
40.92 Setpoint data storage	Storage parameter for process setpoint value	AV42

Communication fault

BACnet has no built-in feature to detect communication timeout, because it is not a synchronous protocol. If communication timeouts are needed, you can use the following parameters to detect timeouts based on different packets and specifying the drive action.

Drive parameter	Value	Description
58.15 Communication loss mode	1 = <i>Any message</i> 2 = <i>Cw / Ref1 / Ref2</i>	Defines which message types reset the timeout counter for detecting an EFB communication loss.
58.14 Communication loss action	0 = <i>No action</i> 1 = <i>Fault</i> 2 = <i>Last speed</i> 3 = <i>Speed ref safe</i> 4 = <i>Fault always</i> 5 = <i>Warning</i>	Selects how the drive reacts to an EFB communication break. Changes to this parameter take effect after the control unit is rebooted or the new settings are validated by parameter 58.06 Communication control (1 = <i>Refresh settings</i>).
58.16 Communication loss time	0.0...6000.0 s	Sets a timeout for EFB communication. If a communication break lasts longer than the timeout, the action specified by parameter 58.16 Communication loss time is taken.

Drive feedback

The inputs to the BMS controller (drive output signals) have pre-defined content. These drive feedback signals do not require any additional drive configuration. The following table lists a subset of the supported feedback data. For a complete listing, see the Protocol Implementation Conformance Statement (PICS) (3AXD10000387059 [English]), which you can find in the ABB Document library on the Internet.

Drive parameter	Description	BACnet object
01.01 Motor speed used	Estimated motor speed (rpm)	AV0
01.06 Output frequency	Estimated drive output frequency (Hz)	AV1
01.11 DC voltage	DC link voltage (V)	AV2
01.13 Output voltage	Calculated motor voltage (V AC)	AV3
01.07 Motor current	Measured (absolute) motor current (A)	AV4
01.10 Motor torque	Motor torque in percent of the nominal motor torque (%)	AV5

Drive parameter	Description	BACnet object
01.14 Output power	Drive output power (kW)	AV6
05.11 Inverter temperature	Estimated drive temperature in percent of fault limit (%)	AV7
01.20 Inverter kWh counter	Amount of energy that has passed through the drive (in either direction) in full kilowatthours. Whenever the counter rolls over, 01.19 Inverter MWh counter is incremented. The minimum value is zero.	AV9
35.01 Motor estimated temperature	Displays the motor temperature (°C or °F) as estimated by the internal motor thermal protection model. The unit is selected by parameter 96.16 Unit selection .	AV15
01.03 Motor speed %	Motor speed in percent of the synchronous motor speed.	AV31
40.01 Process PID output actual	PID controller output	AV44
40.04 Process PID deviation actual	PID deviation	AV49
01.50 Current hour kWh	Current day energy consumption. This is the energy of the last 24 hours (not necessarily continuous) the drive has been running, not the energy of a calendar day. If the power is cycled, after the drive is again up and running, the parameter value is set to the value it had before the power cycle.	AV130
01.51 Previous hour kWh	Previous hour energy consumption. The value 01.50 Current hour kWh is stored here when its values has been cumulated for 60 minutes. If the power is cycled, after the drive is again up and running, the parameter value is set to the value it had before the power cycle.	AV131
01.52 Current day kWh	Current day energy consumption. This is the energy of the last 24 hours (not necessarily continuous) the drive has been running, not the energy of a calendar day. If the power is cycled, after the drive is again up and running, the parameter value is set to the value it had before the power cycle.	AV132
01.53 Previous day kWh	Previous day energy consumption. The value 01.52 Current day kWh is stored here when its value has been cumulated for 24 hours. If the power is cycled, after the drive is again up and running, the parameter value is set to the value it had before the power cycle.	AV133
04.01 Tripping fault	Fault that caused the current trip (active fault)	AV18
04.11 Latest fault	Previous fault (non-active)	AV19
04.12 2nd latest fault	Fault before the previous fault (non-active)	AV20

The actual output values of the drive can be read from AV0...AV6, AV31 and AV32:

Object ID	Default object name	Description	Min/max present value	Unit	Present value access type
AV0	Output-RPM	Motor speed	0, nominal speed	rpm	R
AV1	Output-Freq	Output frequency	-500, 500	Hz	R

Object ID	Default object name	Description	Min/max present value	Unit	Present value access type
AV2	DC-Voltage	DC link voltage	0, 2000	V	R
AV3	Output-Voltage	AC output voltage	0, 2000	V	R
AV4	Output-Current	Output current of drive	0, nominal current	A	R
AV5	Output-Torque	Output torque of motor as a percentage of nominal torque	-1600, 1600	%	R
AV6	Output-Power	Output power in kW	nominal power (+/-)	kW	R
AV31	Output-Speed	Actual motor speed	-200, 200	%	R
AV32	Output-Current-Range	Actual motor current	0, 200	%	R

Parameter setting example

■ Frequency control

The table below shows an example of how to configure a basic frequency control application. The rest of parameters can be left as default values.

Drive parameter	Settings	Description
<i>58.06 Communication control</i>	0 = <i>Enabled</i>	Normal operation
<i>58.03 Node address</i>	181 ¹⁾	Defines the node address of the drive on the fieldbus link.
<i>58.40 Device object ID</i>	51 ¹⁾	Configures device object ID.
<i>58.16 Communication loss time</i>	30 ¹⁾	Sets the communication timeout as 30 seconds.
<i>58.15 Communication loss mode</i>	1 = <i>Any message</i> ¹⁾	The timeout feature monitors any directed message received from the drive.
<i>58.06 Communication control</i>	0 = <i>Refresh settings</i>	Refreshes settings and takes changed EFB configuration settings in use.
<i>20.01 Ext1 commands</i>		Selects the embedded fieldbus interface as the source of start and stop commands for external control location 1.
<i>28.11 Ext1 frequency ref1</i>		Selects embedded fieldbus reference 1 as the source for frequency reference 1.

¹⁾ Example

BACnet protocol implementation conformance statement

Document: 3AXD10000786871, Rev 1

Date: Sept 12, 2018

Vendor name: ABB, Vendor ID 127

Product name: HVAC Drive

Product model number: ACH480

Applications software version: Drive FW: 2.x.x.x BACnet Appl: 2025

Firmware revision: 14.01

BACnet protocol revision: 14

■ Product description:

The ACH480 is a high-performance variable speed drive (VSD) designed for HVAC and refrigeration applications. Product supports native BACnet, connecting directly to the MS/TP LAN. MS/TP baud rates are supported up to 115.2 kbps, as well as master and slave mode functionalities. Over BACnet, the drive can be fully controlled and monitored as a standard variable speed drive. In addition, the drive's standard I/O is available over BACnet to the user application.

■ BACnet standardized device profile (Annex L):

- BACnet Operator Workstation (B-OWS)
- BACnet Advanced Operator Workstation (B-AWS)
- BACnet Operator Display (B-OD)
- BACnet Building Controller (B-BC)
- BACnet Advanced Application Controller (B-AAC)
- BACnet Application specific Controller (B-ASC)
- BACnet Smart Sensor (B-SS)
- BACnet Smart Actuator (B-SA)

■ List all BACnet interoperability building blocks supported (Annex K):

DS-RP-B	Data Sharing-ReadProperty
DS-RPM-B	Data Sharing-ReadProperty Multiple
DS-WP-B	Data Sharing-WriteProperty
DS-WPM-B	Data Sharing-WriteProperty Multiple
DS-COV-B	Data Sharing-Change of Value
DM-DDB-B	Device Management-DynamicDeviceBinding
DM-DOB-B	Device Management-DynamicObjectBinding
DM-DCC-B	Device Management-DeviceCommunicationControl
DM-RD-B	Device Management-ReinitializeDevice
DM-TS-B	Device Management-Time Synchronization

Segmentation capability:

- Able to transmit segmented messages Window size: -
- Able to receive segmented messages Window size: -

Standard object types supported:

Object instantiation is static, i.e. objects cannot be created or deleted. Refer to tables at end of this document for object details.

Data link layer options:

- BACnet IP, (Annex J)
- BACnet IP, (Annex J), foreign device
- ISO 8802-3, Ethernet (Clause 7)
- ATA 878.1, 2.5 Mb. ARCNET (Clause 8)
- ATA 878.1, EIA-485 ARCNET (Clause 8), baud rate(s) _____
- MS/TP master (Clause 9), baud rate(s): 9.6k, 19.2k, 38.4k, 76.8k, 115.2k
- MS/TP slave (Clause 9), baud rate(s): 9.6k, 19.2k, 38.4k, 76.8k, 115.2k
- Point-to-point, EIA 232 (Clause 10), baud rate(s): _____
- Point-to-point, modem, (Clause 10), baud rate(s): _____
- LonTalk, (Clause 11), medium: _____
- BACnet/ZigBee (ANNEX O)
- Other: _____

Device address binding:

Is static device binding supported? (This is currently necessary for two-way communication with MS/TP slaves and certain other devices.) Yes No

Networking options:

- Router, Clause 6
 - BACnet/IP to MS/TP
 - BACnet/ ISO 8802-3, Ethernet to MS/TP
 - BACnet/IP to BACnet/ ISO 8802-3, Ethernet
 - BACnet/IP to BACnet/ ISO 8802-3, Ethernet to MS/TP
- Annex H, BACnet tunneling router over IP
- BACnet/IP broadcast management device (BBMD)
 - Does the BBMD support registrations by foreign devices? Yes No
 - Max BDT (Broadcast distribution table)-entries:
 - Does the BBMD support network address translation? Yes No

■ **Network security options:**

- Non-secure device - is capable of operating without BACnet network security
- Secure device - is capable of using BACnet network security (NS-SD BIBB)
 - Multiple application-specific keys:
 - Supports encryption (NS-ED BIBB)
 - Key server (NS-KS BIBB)

■ **Character sets supported:**

Indicating support for multiple character sets does not imply that they can all be supported simultaneously.

- ISO 10646 (UTF-8)
- IBM /Microsoft DBCS
- ISO 8859-1
- ISO 10646 (UCS-2)
- ISO 10646 (UCS-4)
- JIS X 0208

If this product is a communication gateway, describe the types of non-BACnet equipment/network(s) that the gateway supports:

Object/Property support matrix

The following table summarizes the object types/properties supported and default values:

Property	Object type							Loop
	Binary input	Binary output	Binary value	Analog input	Analog output	Analog value	Multistate value	
Object identifier	R	R	R	R	R	R	R	R
Object name	W, P	W, P	R	W, P	W, P	R ⁽¹⁾	R	W,P
Object type	R	R	R	R	R	R	R	R
Present value	R	C	C	R	C	C	R	R
Status flags	R	R	R	R	R	R	R	R
Event state	R	R	R	R	R	R	R	R
Out-of-service	W	W	W	W	W	W	W	W
Polarity	W, P	W, P						
Active text	R	R	R					
Inactive text	R	R	R					
Units				R	R	R		
Min present value				R	R	R		
Max present value				R	R	R		
Priority array		R	R		R	R		
Relinquish default		W, P	W,P		W, P	W, P		
COV increment				W,P	W,P	W,P		
Number of states							R	
State text							R	
Property list	R	R	R	R	R	R	R	R
	<ul style="list-style-type: none"> • R = Read only, W = Writable, C = Commandable, P = Persist • AV16, AV17, AV21, AV22, AV40- AV44, AV55, AV56, AV59, AV120-129 have W, P. • Max length of writable object names is 25 characters 							

9

Device object instance summary

The following table summarizes the device object supported:

Device object			
Property	Flag	Type	Default value
Object identifier	W, P	OID	4194303
Object name	W, P	CharString, max length 25	AC Drive 4194303
Object type	R	Enum	DEV (8)
System status	R	Enum	
Vendor name	R	CharString	ABB
Vendor identifier	R	Unsigned	127
Model name	R	CharString	ACH480

Firmware revision	R	CharString	14.01
Application software revision	R	CharString	
Description	W, P	CharString, max length 100	"ACH480 is a high-performance variable speed drive designed for HVAC and refrigeration applications."
Location	W, P	CharString, max length 50	"(not set)"
Protocol version	R	Unsigned	1
Protocol revision	R	Unsigned	14
Protocol services supported	R	BitString	
Protocol object types supported	R	BitString	
Object list	R	Array of OID	
Max APDU length accepted	R	Unsigned	480
Segmentation supported	R	Enum	No segmentation (3)
Local time	R	BACnetTime	
Local date	R	BACnetDate	
APDU timeout	W, P	Unsigned	10000 ms
Number of APDU retries	W, P	Unsigned	3
Max master	W, P	Unsigned	127
Max info frames	W, P	Unsigned	1
Device address binding	R	List of Struct	
Database revision	R, P	Unsigned	
Active COV subscriptions	R	Array of BACnetCOVSubscription	
Serial number	R	CharString	
Property list	R	Array of Unsigned	
Flags: R = Read only, W = Writable, C = Commandable, P = Persist			

Binary input object instance summary

The following table summarizes the binary input objects supported:

Object ID	Object name	Description	Active/Inactive text	Present value access type
BI0	RO1-Monitor	Status of relay output 1	On / Off	R
BI1	RO2-Monitor	Status of relay output 2	On / Off	R
BI2	RO3-Monitor	Status of relay output 3	On / Off	R
BI3	RO4-Monitor	Status of relay output 4	On / Off	R
BI4	RO5-Monitor	Status of relay output 5	On / Off	R
BI5	DO1-Monitor	Status of digital output 1	On / Off	R
BI6	DI1-Monitor	Status of digital input 1	On / Off	R
BI7	DI2-Monitor	Status of digital input 2	On / Off	R
BI8	DI3-Monitor	Status of digital input 3	On / Off	R

Object ID	Object name	Description	Active/Inactive text	Present value access type
BI9	DI4-Monitor	Status of digital input 4	On / Off	R
BI10	DI5-Monitor	Status of digital input 5	On / Off	R
BI11	DI6-Monitor	Status of digital input 6	On / Off	R

Note: For present value access types, R = Read-only, W = Writeable, C = Commandable. Commandable values support priority arrays & relinquish defaults.

Binary output object instance summary

The following table summarizes the binary output objects supported:

Object ID	Object name	Description	Active/Inactive text	Present value access type
BO0	RO1-Command	Output state of relay 1	On / Off	C
BO1	RO2-Command	Output state of relay 2	On / Off	C
BO2	RO3-Command	Output state of relay 3	On / Off	C
BO3	RO4-Command	Output state of relay 4	On / Off	C
BO4	RO4-Command	Output state of relay 5	On / Off	C
BO5	DO1-Command	Output state of digital output 1	On / Off	C

Note: For present value access types, R = Read-only, W = Writeable, C = Commandable. Commandable values support priority arrays & relinquish defaults.

Binary value object instance summary

The following table summarizes the binary value objects supported:

Object ID	Object name	Description	Active/Inactive text	Present value access type
BV0	RUN-STOP-Monitor	Drive's run status	Run / Stop	R
BV1	Direction-Monitor	Rotational direction of the motor	Reverse / Forward	R
BV2	OK-FAULT-Monitor	Actual fault status of drive	Fault / OK	R
BV3	EXT1-EXT2-Monitor	Actual control source	Ext2 / Ext1	R
BV4	HAND-AUTO-Monitor	Actual operating mode.	Hand / Auto	R
BV5	Warning-Monitor	Actual warning status	Warning / OK	R
BV7	Ready-Monitor	Actual ready status	Ready / Not-Ready	R
BV8	At-Setpoint-Monitor	Actual at setpoint status	Yes / No	R
BV9	Enabled-Monitor	Actual run enabled status	Enable / Disable	R

Object ID	Object name	Description	Active/Inactive text	Present value access type
BV10	RUN-STOP-Command	Command to start drive	Run / Stop	C
BV11	Direction-Command	Command to rotational direction	Reverse / Forward	C
BV12	Run-Permissive-Command	Command to run permissive command	Enable / Disable	C
BV13	EXT1-EXT2-Command	Commanded to external 1 or external 2 selection	Ext2 / Ext1	C
BV14	Fault-Reset-Command	Commanded to fault reset	Reset / No	W
BV15-BV16	<Reserved>			
BV17	Lock-Parameters	Actual status of parameter lock.	Lock / Unlock	R
BV18	Control-Override-Command	Command the drive into BACnet control override. In this mode, BACnet acquires drive control from its normal source. Note that HAND mode of the panel has priority over BACnet Control Override.	On / Off	C
BV19	Control-Override-Monitor	Indicates if drive has been placed in BACnet control override by commanding BV18. In this mode, BACnet acquires drive control from its normal source. Note that HAND mode of the panel has priority over BACnet control override.	On / Off	R
BV20	Start-Interlock-1-Command	Command to start enable 1	Enable / Disable	C
BV21	Start-Interlock-2-Command	Command to start enable 2	Enable / Disable	C
BV24	Started-Monitor	Actual start status	Started / Not-Started	R
BV25	Safe-Torque-Off-Monitor	Actual status of Safe Torque Off	Active / OK	R
BV26	Underload-Monitor	Indicates if ULC signal is lower than the Underload curve	Underload / OK	R
BV27	Overload-Monitor	Indicates if ULC signal is higher than the overload curve	Overload / OK	R
BV28	Motor-Heating-Command	Command to motor heating mode	On / Off	W
BV29	Motor-Heating-Monitor	Actual status of motor heating mode	On / Off	R
BV30	User0-Monitor	Actual status of "User bit0" in drive status word	On / Off	R
BV31	User1-Monitor	Actual status of "User bit1" in drive status word	On / Off	R
BV32	User2-Monitor	Actual status of "User bit2" in drive status word	On / Off	R

Object ID	Object name	Description	Active/Inactive text	Present value access type
BV33	User3-Monitor	Actual status of "User bit3" in drive status word	On / Off	R
BV34	User0-Command	Commands "User bit0" in drive status word	On / Off	C
BV35	User1-Command	Commands "User bit1" in drive status word	On / Off	C
BV36	User2-Command	Commands "User bit2" in drive status word	On / Off	C
BV37	User3-Command	Commands "User bit3" in drive status word	On / Off	C
BV38	<Reserved>			
BV39	Parameter-Save-Command	Command to save drive parameters and BACnet property data (properties marked as 'P=Persist')	Save / No	W
BV40	PID-Set-Select	Command to Process PID set1 or Process PID set2 selection	Set1 / Set2	W

Note: For present value access types, R = Read-only, W = Writeable, C = Commandable. Commandable values support priority arrays & relinquish defaults.

Analog input object instance summary

The following table summarizes the analog input objects supported:

Object ID	Default object name	Description	Min / Max present value	Units	Present value access type
AI0	AI1-Monitor	Indicates the input level of analog input 1.	0...100	Percent (%)	R
AI1	AI2-Monitor	Indicates the input level of analog input 2.	0...100	Percent (%)	R

Note: For present value access types, R = Read-only, W = Writeable, C = Commandable. Commandable values support priority arrays & relinquish defaults.

Analog output object instance summary

The following table summarizes the analog output objects supported:

Object ID	Default object name	Description	Min / Max present value	Units	Present value access type
AO0	AO1-Command	Controls analog output 1 (drive must be configured for BACnet control).	0...100	Percent	C
AO1	AO2-Command	Controls analog output 2 (drive must be configured for BACnet control).	0...100	Percent	C

Note: For present value access types, R = Read-only, W = Writeable, C = Commandable. Commandable values support priority arrays & relinquish defaults.

Analog value object instance summary

The following table summarizes the analog value objects supported:

Object ID	Default object name	Description	Min / Max present value	Units	Present value access type
AV0	Output-RPM	Motor speed	0, nominal speed	rpm	R
AV1	Output-Freq	Output frequency	-500, 500	Hz	R
AV2	DC-Voltage	DC bus voltage	0, 2000	V	R
AV3	Output-Voltage	AC output voltage	0, 2000	V	R
AV4	Output-Current	Output current of drive	0, nominal current	A	R
AV5	Output-Torque	Output torque of motor as a percentage of nominal torque	-1600, 1600	%	R
AV6	Output-Power	Output power in kW	nominal power (+/-)	kW	R
AV7	Operating-Temp-Range	Heatsink temperature	-40, 160	%	R
AV8	Kilowatt-Hour-Meter-R	Drive's cumulative energy usage. This value is resettable.	0,65535	kWh	W
AV9	Kilowatt-Hour-Meter-NR	Drive's cumulative energy usage. This value is not resettable.	0, 6553599999	kWh	R
AV10	Process-PID-Feedback	This object is the process PID feedback signal.	0, 100	%	R
AV11	Process-PID-Deviation	This object is the process PID output signal's deviation from its setpoint.	0, 100	%	R
AV12	External-PID-Feedback	This object is the external PID feedback signal.	0, 100	%	R
AV13	External-PID-Deviation	This object is the external PID output signal's deviation from its setpoint.	0, 100	%	R
AV14	Running-Hours	Drive's resettable run time (reset by writing 0).	0, 3.40282347e38	hours	R
AV15	Motor-Temp-Degrees-C	Motor temperature	-10, 200	°C	R
AV16	Input-Reference-1	Speed setpoint 1	-150, 150	%	C

Object ID	Default object name	Description	Min / Max present value	Units	Present value access type
AV17	Input-Reference-2	Speed setpoint 2.	-150, 150	%	C
AV18	Active-Fault	Displays most recent fault currently active.			R
AV19	Previous-Fault-1	Displays most recent stored (non-active) fault			R
AV20	Previous-Fault-2	Displays the second most recent stored (non-active) fault			R
AV21	AO1-Monitor	Output level of analog output 1	0, 100	%	R
AV22	AO2-Monitor	Output level of analog output 2	0, 100	%	R
AV23	Accel-1-Seconds	Ramp1 acceleration time	0, 1800	s	W
AV24	Decel-1-Seconds	Ramp 1 deceleration time	0, 1800	s	W
AV25	Mbox-Param	Parameter number to be used by mailbox function.		No Units	W
AV26	Mbox-Data	Set (W) or indicate (R) of the data value of mailbox function		No Units	W
AV27	External-PID-Setpoint	This object sets the external PID controller setpoint	0, 100	%	C
AV27-AV28	<Reserved>				
AV29	Min-Speed	Defines the allowed minimum output frequency	-500, 500	Hz	W
AV30	Max-Speed	Defines the allowed maximum output frequency	-500, 500	Hz	W
AV31	Output-Speed	Actual motor speed	-200, 200	%	R
AV32	Output-Current-Range	Actual motor current	0, 200	%	R
AV33	Max-Current	Max motor current	0, nominal current	A	W
AV34-AV39	<Reserved>				
AV40	LOOP-Feedback-Monitor	Loop controller feedback value after source selection, mathematical function and filtering (read-only)	0, 100	%	R
AV41	LOOP-Setpoint-Monitor	Loop controller setpoint value after source selection, mathematical function limitation and ramping (read-only)	0,100	%	R

Object ID	Default object name	Description	Min / Max present value	Units	Present value access type
AV42	LOOP-Setpoint	Command to store loop controller setpoint value used as input for the process	0,100	%	C
AV43	LOOP-Feedback	Stores the feedback value for loop controller	0,100	%	W
AV44	LOOP-Output	Loop controller output	0,100	%	R
AV45	LOOP- Gain	Loop controller gain	0.1,100	No Units	W
AV46	LOOP-Integration-Time	Loop controller integration time	0,3600	s	W
AV47-AV48	<Reserved>				
AV49	LOOP-Deviation-Monitor	Loop controller deviation	0,100	%	R
AV50-AV52	<Reserved>				
AV53	LOOP-1-Gain	Loop controller gain (set 2)	0.1,100	No Units	W
AV54	LOOP-1-Integration-Time	Loop controller integration time (set 2)	0,3600	s	W
AV55	LOOP-2-Feedback-Monitor	External loop controller feedback value after source selection, mathematical function and filtering (read-only)	0,100	%	R
AV56	LOOP-2-Setpoint-Monitor	External loop controller setpoint value after source selection, mathematical function limitation and ramping (read-only)	0,100	%	R
AV57-AV58	<Reserved>				
AV59	LOOP-2-Output	External loop controller output	0,100	%	R
AV60	LOOP-2-Gain	External loop controller gain	0.1,100	No Units	W
AV61	LOOP-2-Integration-Time	External loop controller integration time	0,3600	s	W
AV62-AV63	<Reserved>				
AV64	LOOP-2-Deviation-Monitor	External loop controller deviation	0,100	%	R
AV65-119	<Reserved>			No Units	W
AV120	Data-IO-1	Holds the value of drive parameter, which is mapped using Data I/O parameter 58.101		No Units	W

Object ID	Default object name	Description	Min / Max present value	Units	Present value access type
AV121	Data-IO-2	Holds the value of drive parameter, which is mapped using Data I/O parameter 58.102		No Units	W
AV122	Data-IO-3	Holds the value of drive parameter, which is mapped using Data I/O parameter 58.103		No Units	W
AV123	Data-IO-4	Holds the value of drive parameter, which is mapped using Data I/O parameter 58.104		No Units	W
AV124	Data-IO-5	Holds the value of drive parameter, which is mapped using Data I/O parameter 58.105 (Read-only)		No Units	R
AV125	Data-IO-6	Holds the value of drive parameter, which is mapped using Data I/O parameter 58.106 (Read-only)		No Units	R
AV126	Data-IO-7	Holds the value of drive parameter, which is mapped using Data I/O parameter 58.107 (Read-only)		No Units	R
AV127	Data-IO-8	Holds the value of drive parameter, which is mapped using Data I/O parameter 58.108 (Read-only)		No Units	R
AV128	Data-IO-9	Holds the value of drive parameter, which is mapped using Data I/O parameter 58.109 (Read-only)		No Units	R
AV129	Data-IO-10	Holds the value of drive parameter, which is mapped using Data I/O parameter 58.110 (Read-only)		No Units	R
AV130	Kilowatt-Hour-This-Hour	Current hour energy consumption	0, 3.40282347e38	kWh	R
AV131	Kilowatt-Hour-Last-Hour	Last hour energy consumption	0, 3.40282347e38	kWh	R
AV132	Kilowatt-Hour-This-Day	Current day energy consumption	0, 3.40282347e38	kWh	R
AV133	Kilowatt-Hour-Last-Day	Last day energy consumption	0, 3.40282347e38	kWh	R

Note: For present value access types, R = Read-only, W = Writeable, C = Commandable. Commandable values support priority arrays & relinquish defaults.

Multistate value object instance summary

The following table summarizes the multistate value objects supported:

Object ID	Object name	Description	State text	Present value access type
MSV0	HAND-AUTO-Reference	Indicates whether the drive is under Hand or Auto control, or if Override mode is active.	Off, Hand, Auto, Override	R
MSV1	Active-Fault-1	Enumerated type of the most recent fault currently active	None, Comm-Error, Overcurrent, Overtemperature, Overspeed, Overvoltage, Undervoltage, Short-Circuit, Ground-Fault, Motor-Overload, Inverter-Overload, Motor-Underload, External-Fault, Operator-Interface-Error, Config-Error, Feedback-Failure, Output-Phase-Loss Motor-Stall, Power-Unit-Error, Input-Phase-Fault, Internal-Failure, STO-Active, Other	R

Object ID	Object name	Description	State text	Present value access type
MSV2	Active-Fault-2	Enumerated type of the 2nd most recent fault currently active	None, Comm-Error, Overcurrent, Overtemperature, Overspeed, Overvoltage, Undervoltage, Short-Circuit, Ground-Fault, Motor-Overload, Inverter-Overload, Motor-Underload, External-Fault, Operator-Interface-Error, Config-Error, Feedback-Failure, Output-Phase-Loss Motor-Stall, Power-Unit-Error, Input-Phase-Fault, Internal-Failure, STO-Active, Other	R
MSV3	Active-Fault-3	Enumerated type of the 3rd most recent fault currently active	None, Comm-Error, Overcurrent, Overtemperature, Overspeed, Overvoltage, Undervoltage, Short-Circuit, Ground-Fault, Motor-Overload, Inverter-Overload, Motor-Underload, External-Fault, Operator-Interface-Error, Config-Error, Feedback-Failure, Output-Phase-Loss Motor-Stall, Power-Unit-Error, Input-Phase-Fault, Internal-Failure, STO-Active, Other	R

Object ID	Object name	Description	State text	Present value access type
MSV4	Active-Warning-1	Enumerated type of the most recent warning currently active	None, Comm-Error, Current-Limit, Overtemperature, Start-Interlock-1, Start-Interlock-2, Start-Interlock-3, Start-Interlock-4, Run-Permissive, Internal-Warning, Start-Delay, Other	R
MSV5	Active-Warning-2	Enumerated type of the 2nd most recent warning currently active	None, Comm-Error, Current-Limit, Overtemperature, Start-Interlock-1, Start-Interlock-2, Start-Interlock-3, Start-Interlock-4, Run-Permissive, Internal-Warning, Start-Delay, Other	R
MSV6	Active-Warning-3	Enumerated type of the 3rd most recent warning currently active	None, Comm-Error, Current-Limit, Overtemperature, Start-Interlock-1, Start-Interlock-2, Start-Interlock-3, Start-Interlock-4, Run-Permissive, Internal-Warning, Start-Delay, Other	R

Note: For present value access types, R = Read-only, W = Writeable, C = Commandable. Commandable values support priority arrays & relinquish defaults.

Loop object instance summary

The following table summarizes the loop objects supported:

Object ID	Object name	Description	Manipulated variable reference	Controlled variable reference	Setpoint reference	Present value access type
LOOP0	LOOP-Set1	Loop object for process PID set 1	AV44 Present Value	AV43 Present Value	AV42 Present Value	R

Object ID	Object name	Description	Manipulated variable reference	Controlled variable reference	Setpoint reference	Present value access type
LOOP1	LOOP-Set2	Loop object for process PID set 2	AV44 Present Value	AV43 Present Value	AV42 Present Value	R

Note: For present value access types, R = Read-only, W = Writeable, C = Commandable. Commandable values support priority arrays & relinquish defaults.

10

N2 control through the embedded fieldbus interface (EFB)

Contents of this chapter

The chapter describes N2 control through the embedded fieldbus interface (EFB): supported functionality, services and objects as well as how to configure the N2 with parameters.

N2 overview

The N2 fieldbus connection to the drive is based on an industry standard RS-485 physical interface. The N2 fieldbus protocol is a master-slave type, serial communication protocol, used by the Johnson Controls Metasys® system. In the Metasys architecture the N2 fieldbus connects object interfaces and remote controllers to network control units (NCUs).

The N2 fieldbus can also be used to connect the drives to the Metasys Companion product line.

This section describes the use of the N2 fieldbus with the drive's connection and does not describe the protocol in detail.

Supported features

In the N2 fieldbus protocol the drive appears as a “virtual object”.

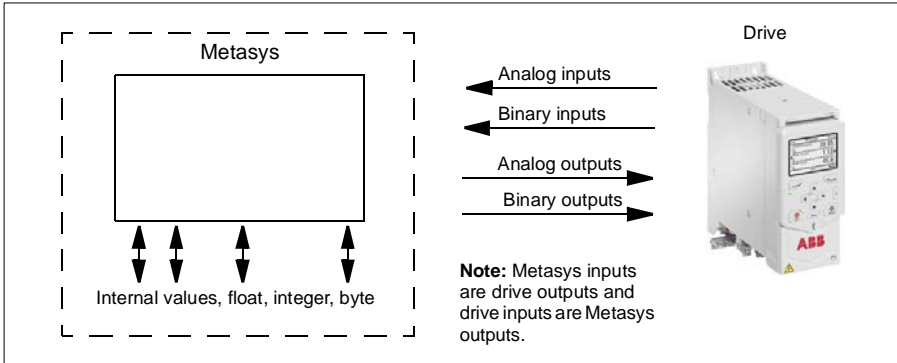

A virtual object is made up of:

- analog inputs
- binary inputs
- analog outputs
- binary outputs
- internal values for floating point, integer, and byte values.

The drive does not support N2 fieldbus communication “internal values”.

All of the analog and binary I/O objects are listed below, starting with N2 analog input objects.

Analog input - the analog input objects support the following features:

- analog input actual value in engineering units
- low alarm limit
- low warning limit
- high warning limit
- high alarm limit
- differential value for the hysteresis of the alarms and warnings
- change of state (COS) enabled
- alarm enabled
- warning enabled
- override value is received, but there is no action taken.

Binary input - the binary input objects support the following features:

- binary input actual value
- normal / alarm state specification
- alarm enabled
- change of state (COS) enabled
- override value is received, but there is no action taken.

Analog output - the analog output objects support the following features:

- analog output value in engineering units
- override value is used to change the analog output value. It is not possible to return to the previous value by removing the override. The Override feature is used only to change the value.

Binary output - the binary output objects support the following features:

- binary output value
- override value is used to change the binary output value. It is not possible to return to the previous value by removing the override. The Override feature is used only to change the value.

■ Metasys integration

The following diagram shows the drives' integration to the Johnson Controls Metasys system.

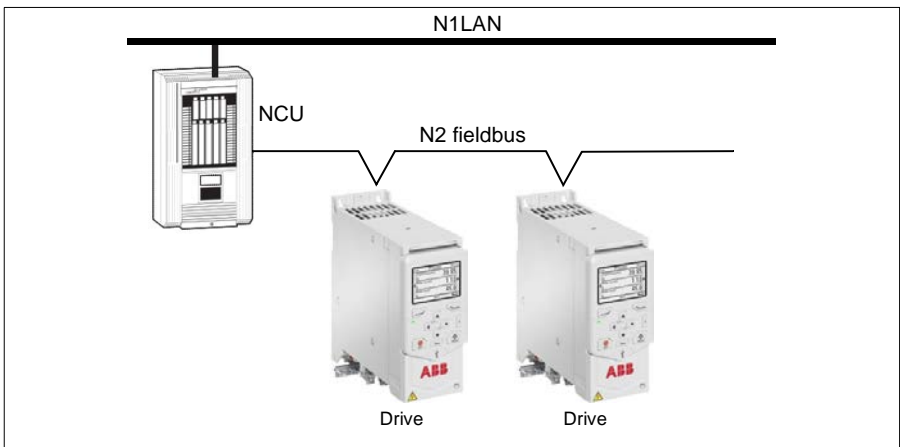

The following diagram shows the drive's integration to the Johnson Controls Metasys Companion system.

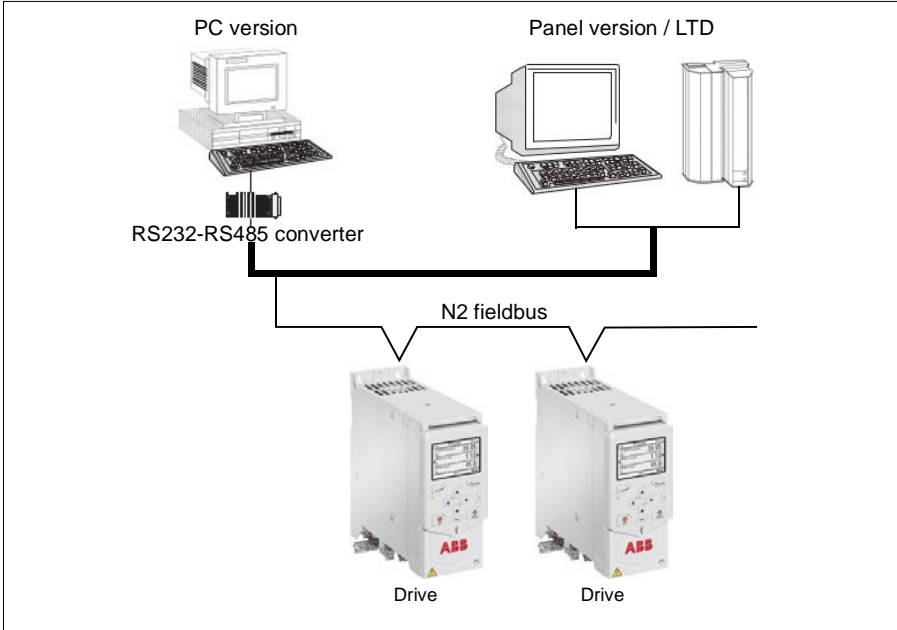

On the N2 fieldbus each drive can be accessed by the full complement of Metasys FMS features, including change-of-state (COS) monitoring, alarm notification, scheduling, trend, and totalization.

On one N2 fieldbus segment there can be up to 32 nodes while integrating drives with Johnson Controls Metasys.

■ Drive device type

10

For the Metasys and Metasys Companion products, the device type for the drive is VND.

Hardware installation

■ Connecting devices to a N2 EIA-485 network

See the hardware manual of the drive.

N2 analog input objects

The following table lists the N2 analog input objects defined for the drive.

N2 analog inputs						
No	Object	Drive parameter	Scale factor	Units	Range	Notes
AI1	OUTPUT FREQUENCY	01.06 Output frequency	100	Hz	0...250	
AI2	RATED SPEED	01.62 Abs motor speed %	100	%	0...100	
AI3	SPEED	01.01 Motor speed used	100	rpm	0...9999	
AI4	CURRENT	01.07 Motor current	100	A	0...9999	
AI5	TORQUE	01.10 Motor torque	100	%	-200...200	
AI6	POWER	01.17 Motor shaft power	10	kW	0...9999	
AI7	DRIVE TEMPERATURE	05.11 Inverter temperature	10	%	-40...160	
AI8	KILOWATT HOURS	01.58 Cumulative inverter energy (resettable)	10	kW	0...65535	
AI9	MEGAWATT HOURS	Derived value	10000	MWh	0...65535	Parameter 01.54 Cumulative inverter energy / 1000
AI10	RUN TIME	05.03 Hours run	10	h	0...65535	
AI11	DC BUS VOLTAGE	01.11 DC voltage	100	V	0...999	
AI12	OUTPUT VOLTAGE	01.13 Output voltage	1	V	0...999	
AI13	PRC PID FEEDBACK	40.97 Process PID feedback %	100	%	0...100	
AI14	PRC PID DEVIATION	40.99 Process PID deviation %	100	%	0...100	
AI15	EXT PID FEEDBACK	Derived value	10	%	0...100	= 71.02 Feedback act value * 1000 / 71.14 Setpoint scaling
AI16	EXT PID DEVIATION	Derived value	10	%	0...100	= 71.04 Deviation act value * 1000 / 71.14 Setpoint scaling
AI17	LAST FAULT	Derived value	1		fault code	Most recent fault
AI18	PREV FAULT	Derived value	1		fault code	Second most recent fault
AI19	OLDEST FAULT	Derived value	1		fault code	Third most recent fault
AI20	AI 1 ACTUAL	12.101 AI1 percent value	100	%	0...100	
AI21	AI 2 ACTUAL	12.102 AI2 percent value	100	%	0...100	
AI22	AO 1 ACTUAL	13.11 AO1 actual value	1000	mA	0...20	

N2 analog inputs						
No	Object	Drive parameter	Scale factor	Units	Range	Notes
AI23	AO 2 ACTUAL	<i>13.21 AO2 actual value</i>	1000	mA	0...20	
AI24	MOTOR TEMP	Derived value	1	°C	0...200	Value is derived from <i>35.01</i> , <i>35.02</i> and <i>35.03</i> : <ul style="list-style-type: none"> • If <i>35.11</i> and <i>35.21</i> are both non-zero, the temperature is the maximum value of <i>35.02</i> and <i>35.03</i>. • If only <i>35.11</i> is non-zero, the temperature is value of <i>35.02</i>. • If only <i>35.21</i> is non-zero, the temperature is value of <i>35.03</i>. • If both <i>35.11</i> and <i>35.21</i> are zero, the value is as <i>35.01</i>.

N2 binary input objects

The following table lists the N2 binary input objects defined for the drive.

N2 binary inputs			
No	Object	Drive parameter	Range
BI1	STOP/RUN	Status Word, bit 2	0 = Drive received start command 1 = Drive has not received start command
BI2	FORWARD/REVERSE	Status Word, bit 11	0 = Forward, 1 = Reverse
BI3	FAULT STATUS	Status Word, bit 15	0 = OK, 1 = Drive fault
BI4	RELAY 1 STATUS	<i>10.21 RO status</i> , bit 0	0 = Off, 1 = On
BI5	RELAY 2 STATUS	<i>10.21 RO status</i> , bit 1	0 = Off, 1 = On
BI6	RELAY 3 STATUS	<i>10.21 RO status</i> , bit 2	0 = Off, 1 = On
BI7	RELAY 4 STATUS	<i>15.04 RO/DO status</i> , bit 0	0 = Off, 1 = On
BI8	RELAY 5 STATUS	<i>15.04 RO/DO status</i> , bit 1	0 = Off, 1 = On
BI9	DIGITAL OUTPUT1 STATUS	<i>15.04 RO/DO status</i> , bit 5	0 = Off, 1 = On
BI10	INPUT 1 STATUS	<i>10.02 DI delayed status</i> , bit 0	0 = Off, 1 = On
BI11	INPUT 2 STATUS	<i>10.02 DI delayed status</i> , bit 1	0 = Off, 1 = On
BI12	INPUT 3 STATUS	<i>10.02 DI delayed status</i> , bit 2	0 = Off, 1 = On
BI13	INPUT 4 STATUS	<i>10.02 DI delayed status</i> , bit 3	0 = Off, 1 = On
BI14	INPUT 5 STATUS	<i>10.02 DI delayed status</i> , bit 4	0 = Off, 1 = On

N2 binary inputs			
No	Object	Drive parameter	Range
BI15	INPUT 6 STATUS	10.02 DI delayed status , bit 5	0 = Off, 1 = On
BI16	EXTERNAL 2 SELECT	DCU Status Word, bit 14	0 = EXT1 active, 1 = EXT2 active
BI17	HAND/AUTO	DCU Status Word, bit 12	0 = AUTO, 1 = HAND
BI18	ALARM	DCU Status Word, bit 16	0 = OK, 1 = Warning/alarm
BI20	DRIVE READY	DCU Status Word, bit 0	0 = Not ready, 1 = Ready
BI21	AT SETPOINT	DCU Status Word, bit 7	0 = No, 1 = At setpoint
BI22	RUN ENABLED	DCU Status Word, bit 1	0 = Not enabled, 1 = Enabled
BI23	N2 LOCAL MODE	DCU Status Word, bit 13	0 = Auto, 1 = N2 local
BI24	N2 CONTROL SRC	DCU Status Word, bit 26	0 = No, 1 = Yes
BI25	N2 REF1 SRC	DCU Status Word, bit 27	0 = No, 1 = Yes
BI26	N2 REF2 SRC	DCU Status Word, bit 28	0 = No, 1 = Yes

N2 analog output objects

The following table lists the N2 analog output objects defined for the drive.

N2 analog outputs						
No	Object	Drive parameter	Scale factor	Units	Range	Notes
AO1	REFERENCE 1	Reference 1	10	%	0...100	
AO2	REFERENCE 2	Reference 2	10	%	0...100	
AO3	ACCEL TIME 1	No direct mapping	1000	s	0.1...1800	If parameter 99.04 Motor control mode is set <ul style="list-style-type: none"> to vector mode (99.04 = 0), map to 23.12 Acceleration time 1. to scalar mode (99.04 = 1), map to 28.72 Freq acceleration time 1.
AO4	DECEL TIME 1	No direct mapping	1000	s	0.1...1800	If parameter 99.04 Motor control mode is set <ul style="list-style-type: none"> to vector mode (99.04 = 0), map to 23.13 Deceleration time 1 to scalar mode (99.04 = 1), map to 28.73 Freq deceleration time 1.
AO5	CURRENT LIMIT	30.17 Maximum current	100	A	0...1.3 ¹ _{2N}	

N2 analog outputs						
No	Object	Drive parameter	Scale factor	Units	Range	Notes
AO6	PID1-CONT GAIN	40.32 Set 1 gain	100	%	0.1...100	
AO7	PID1-CONT I-TIME	40.33 Set 1 integration time	10	s	0.1...600	
AO8	PID1-CONT D-TIME	40.34 Set 1 derivation time	10	s	0...10	
AO9	PID1-CONT D FILTER	40.35 Set 1 derivation filter time	10	s	0...10	
AO10	PID2-CONT GAIN	41.32 Set 2 gain	100	%	0.1...100	
AO11	PID2-CONT I-TIME	41.33 Set 2 integration time	10	s	0.1...600	
AO12	PID2-CONT D-TIME	41.34 Set 2 derivation time	1000	s	0...10	
AO13	PID2-CONT D FILTER	41.35 Set 2 derivation filter time	10	s	0...10	
AO14	COMMAND AO 1	13.91 AO1 data storage	10	%	0...100	
AO15	COMMAND AO 2	13.92 AO2 data storage	10	%	0...100	
AO16	EXT PID SETPOINT	71.21 Internal setpoint 1	100	%	0...100	
AO17	SPD OUT MIN	Derived value	10	%	0...200	<p>Writing:</p> <ul style="list-style-type: none"> scalar mode: 30.13 <i>Minimum frequency = AO17 * 99.08 Motor nominal frequency</i> vector mode: 30.11 <i>Minimum speed = AO17 * 99.09 Motor nominal speed.</i> <p>Reading:</p> <ul style="list-style-type: none"> scalar mode: 99.08 <i>Motor nominal frequency / 30.13 Minimum frequency</i> vector mode: 99.09 <i>Motor nominal speed / 30.11 Minimum speed.</i>

N2 analog outputs						
No	Object	Drive parameter	Scale factor	Units	Range	Notes
AO18	SPD OUT MAX	Derived value	10	%	0...200	Writing: <ul style="list-style-type: none"> • <u>scalar mode</u>: 30.14 <i>Maximum frequency</i> = AO17 * 99.08 <i>Motor nominal frequency</i> • <u>vector mode</u>: 30.12 <i>Maximum speed</i> = AO17 * 99.09 <i>Motor nominal speed</i>. Reading: <ul style="list-style-type: none"> • <u>scalar mode</u>: 99.08 <i>Motor nominal frequency</i> / 30.13 <i>Minimum frequency</i> • <u>vector mode</u>: 99.09 <i>Motor nominal speed</i> / 30.11 <i>Minimum speed</i>.
AO19	MAILBOX PARAMETER		1		0...65535	Mailbox feature is not supported
AO20	MAILBOX DATA		1		0...65535	Mailbox feature is not supported

N2 binary output objects

The following table lists the N2 binary output objects defined for the drive.

N2 binary outputs				
No	Object	Drive parameter	Range	Notes
BO1	STOP/START	DCU Control Word, bit 0 and bit 1	0 = Stop, 1 = Start to Speed	Stop: set bit 0, clear bit 1 Start: set bit 1, clear bit 0
BO2	FORWARD/REVERSE	DCU Control Word, bit 12	0 = Forward, 1 = Reverse	
BO3	PANEL LOCK	Derived	0 = Open, 1 = Locked	Derived from 96.03 Access level status, bit 14 parameter lock
BO4	RUN ENABLE	Derived value	0 = Enable, 1 = Disable	Invert DCU control word bit 6, RUN_DISABLE
BO5	REF1/REF2 SELECT	DCU Control Word, bit 5, EXT	0 = Ref1, 1 = Ref2	
BO6	FAULT RESET	DCU Control Word, bit 4, RESET	Change 0 -> 1 Resets	
BO7	COMMAND RO 1	10.99 RO/DIO control word , bit 0	0 = Off, 1 = On	
BO8	COMMAND RO 2	10.99 RO/DIO control word , bit 1	0 = Off, 1 = On	

N2 binary outputs				
No	Object	Drive parameter	Range	Notes
BO9	COMMAND RO 3	<i>10.99 RO/DIO control word, bit 2</i>	0 = Off, 1 = On	
BO10	COMMAND RO 4	<i>10.99 RO/DIO control word, bit 3</i>	0 = Off, 1 = On	
BO11	COMMAND RO 5	<i>10.99 RO/DIO control word, bit 4</i>	0 = Off, 1 = On	
BO12	COMMAND RO 6	<i>10.99 RO/DIO control word, bit 5</i>	0 = Off, 1 = On	
BO13	RESET RUN TIME	Indirectly mapping	0 = N/A, 1 = On (Reset run time, <i>05.03 Hours run</i>)	
BO14	RESET KWH COUNT	Indirectly mapping	0 = N/A, 1 = On (Reset kWh count <i>01.58 Cumulative inverter energy (resettable)</i>)	
BO15	PRC PID SELECT	<i>40.57 PID set1/set2 selection</i> (indirectly)	0 = SET1, 1 = SET2	If BO15 = 0, <i>40.57 PID set1/set2 selection</i> is set to PID Set1 (1). If BO15 = 1, <i>40.57 PID set1/set2 selection</i> is set to PID Set2 (2).
BO16	N2 LOCAL CTL ¹⁾	DCU Control Word, bit 16	0 = Auto, 1 = N2	
BO17	N2 LOCAL REF ¹⁾	DCU Control Word, bit 17	0 = Auto, 1 = N2	
BO18	SAVE PARAMETERS	<i>96.07 Parameter save manually</i> (indirectly)	0 = N/A, 1 = On (Save Parameters)	
BO19	READ MAILBOX		0 = No, 1 = Yes	Mailbox feature is not supported
BO20	WRITE MAILBOX		0 = No, 1 = Yes	Mailbox feature is not supported

¹⁾ N2 LOCAL CTL and N2 LOCAL REF have priority over drive input terminals. Use these binary outputs for temporary N2 control of the drive when COMM is not the selected control source. Need to be verified.

10

DDL file for NCU

The listing below is the data definition language (DDL) file for ACH480 drives used with the network control units (NCU). It is useful when defining drive I/O objects to the network controller units. Below is the ACH480.DDL file listing.

```
*****
*
*           ABB Drives, ACH 480 Variable Frequency Drive
*
*****
```

CSMODEL "ACH_480 ","VND"

AITITLE "Analog_Inputs"

BITITLE "Binary_Inputs"

AOTITLE "Analog_Outputs"

BOTITLE "Binary_Outputs"

CSAI "AI1",N,N,"FREQ_ACT","Hz"

CSAI "AI2",N,N,"PCT_ACT","%"

CSAI "AI3",N,N,"SPEED","RPM"

CSAI "AI4",N,N,"CURRENT","A"

CSAI "AI5",N,N,"TORQUE","%"

CSAI "AI6",N,N,"POWER","kW"

CSAI "AI7",N,N,"DRV_TEMP_PCT","%"

CSAI "AI8",N,N,"ENERGY_k","kWh"

CSAI "AI9",N,N,"ENERGY_M","MWh"

CSAI "AI10",N,N,"RUN_TIME","H"

CSAI "AI11",N,N,"DC_VOLT","V"

CSAI "AI12",N,N,"VOLT_ACT","V"

CSAI "AI13",N,N,"PID1_ACT","%"

CSAI "AI14",N,N,"PID2_DEV","%"

CSAI "AI15",N,N,"PID2_ACT","%"

CSAI "AI16",N,N,"PID2_DEV","%"

CSAI "AI17",N,N,"LAST_FLT","Code"

CSAI "AI18",N,N,"PREV_FLT","Code"

CSAI "AI19",N,N,"1ST_FLT","Code"

CSAI "AI20",N,N,"AI_1_ACT","%"

CSAI "AI21",N,N,"AI_2_ACT","%"

CSAI "AI22",N,N,"AO_1_ACT","mA"

CSAI "AI23",N,N,"AO_2_ACT","mA"

CSAI "AI24",N,N,"MTR_TEMP","°C"

CSBI "BI1",N,N,"STOP/RUN","STOP","RUN"

CSBI "BI2",N,N,"FWD/REV","FWD","REV"

CSBI "BI3",N,N,"FAULT","OK","FLT"

CSBI "BI4",N,N,"RELAY_1","OFF","ON"

CSBI "BI5",N,N,"RELAY_2","OFF","ON"
 CSBI "BI6",N,N,"RELAY_3","OFF","ON"
 CSBI "BI7",N,N,"RELAY_4","OFF","ON"
 CSBI "BI8",N,N,"RELAY_5","OFF","ON"
 CSBI "BI9",N,N,"DO_1","OFF","ON"
 CSBI "BI10",N,N,"INPUT_1","OFF","ON"
 CSBI "BI11",N,N,"INPUT_2","OFF","ON"
 CSBI "BI12",N,N,"INPUT_3","OFF","ON"
 CSBI "BI13",N,N,"INPUT_4","OFF","ON"
 CSBI "BI14",N,N,"INPUT_5","OFF","ON"
 CSBI "BI15",N,N,"INPUT_6","OFF","ON"
 CSBI "BI16",N,N,"EXT1/2","EXT1","EXT2"
 CSBI "BI17",N,N,"HND/AUTO","AUTO","HAND"
 CSBI "BI18",N,N,"ALARM","OFF","ON"
 CSBI "BI20",N,N,"DRV_REDY","NO","YES"
 CSBI "BI21",N,N,"AT_SETPT","NO","YES"
 CSBI "BI22",N,N,"RUN_ENAB","NO","YES"
 CSBI "BI23",N,N,"N2_LOC_M","AUTO","N2_L"
 CSBI "BI24",N,N,"N2_CTRL","NO","YES"
 CSBI "BI25",N,N,"N2_R1SRC","NO","YES"
 CSBI "BI26",N,N,"N2_R2SRC","NO","YES"
 CSAO "AO1",Y,Y,"REF_1","%"
 CSAO "AO2",Y,Y,"REF_2","%"
 CSAO "AO3",Y,Y,"ACCEL_1","s"
 CSAO "AO4",Y,Y,"DECEL_1","s"
 CSAO "AO5",Y,Y,"CURR_LIM","A"
 CSAO "AO6",Y,Y,"PID1_GN","%"
 CSAO "AO7",Y,Y,"PID1_I","s"
 CSAO "AO8",Y,Y,"PID1_D","s"
 CSAO "AO9",Y,Y,"PID1_FLT","s"
 CSAO "AO10",Y,Y,"PID2_GN","%"
 CSAO "AO11",Y,Y,"PID2_I","s"
 CSAO "AO12",Y,Y,"PID2_D","s"
 CSAO "AO13",Y,Y,"PID2_FLT","s"

CSAO "AO14",Y,Y,"CMD_AO_1", "%"
CSAO "AO15",Y,Y,"CMD_AO_2", "%"
CSAO "AO16",Y,Y,"PI2_STPT", "%"
CSAO "AO17",Y,Y,"MIN_SPD", "%"
CSAO "AO18",Y,Y,"MAX_SPD", "%"
CSAO "AO19",Y,Y,"MB_PARAM", ""
CSAO "AO20",Y,Y,"MB_DATA", ""
CSBO "BO1",Y,Y,"START", "STOP", "START"
CSBO "BO2",Y,Y,"REVERSE", "FWD", "REV"
CSBO "BO3",Y,Y,"PAN_LOCK", "OPEN", "LOCKED"
CSBO "BO4",Y,Y,"RUN_ENAB", "ENABLE", "DISABLE"
CSBO "BO5",Y,Y,"R1/2_SEL", "EXT_1", "EXT_2"
CSBO "BO6",Y,Y,"FLT_RSET", "-", "RESET"
CSBO "BO7",Y,Y,"CMD_RO_1", "OFF", "ON"
CSBO "BO8",Y,Y,"CMD_RO_2", "OFF", "ON"
CSBO "BO9",Y,Y,"CMD_RO_3", "OFF", "ON"
CSBO "BO10",Y,Y,"CMD_RO_4", "OFF", "ON"
CSBO "BO11",Y,Y,"CMD_RO_5", "OFF", "ON"
CSBO "BO12",Y,Y,"CMD_RO_6", "OFF", "ON"
CSBO "BO13",Y,Y,"RST_RTIM", "OFF", "RESET"
CSBO "BO14",Y,Y,"RST_KWH", "OFF", "RESET"
CSBO "BO15",Y,Y,"PID_SEL", "SET1", "SET2"
CSBO "BO16",Y,Y,"N2_LOC_C", "AUTO", "N2"
CSBO "BO17",Y,Y,"N2_LOC_R", "AUTO", "N2"
CSBO "BO18",Y,Y,"SAV_PRMS", "OFF", "SAVE"
CSBO "BO19",Y,Y,"READ_MB", "NO", "READ"
CSBO "BO20",Y,Y,"WRITE_MB", "NO", "WRITE"

11

Fieldbus control through a fieldbus adapter

What this chapter contains

This chapter describes how the drive can be controlled by external devices over a communication network (fieldbus) through an optional fieldbus adapter module.

The fieldbus control interface of the drive is described first, followed by a configuration example.

System overview

The drive can be connected to an external control system through an optional fieldbus adapter (“fieldbus adapter A” = FBA A) mounted onto the control unit of the drive. The drive can be configured to receive all of its control information through the fieldbus interface, or the control can be distributed between the fieldbus interface and other available sources such as digital and analog inputs, depending on how control locations EXT1 and EXT2 are configured.

Fieldbus adapters are available for various communication systems and protocols, for example:

- BACnet/IP (FBIP-21 adapter)
- CANopen (FCAN-01 adapter)
- ControlNet (FCNA-01 adapter)
- DeviceNet™ (FDNA-01 adapter)
- Ethernet POWERLINK (FEPL-02 adapter)
- EtherCAT (FECA-01 adapter)
- EtherNet/IP™ (FEIP-21 adapter, FENA-21 adapter)
- Modbus/RTU (FSCA-01 adapter)
- ModbusTCP (FBMT-21 adapter, FENA-21 adapter)
- PROFINET IO (FPNO-21 adapter, FENA-21 adapter)
- PROFIBUS DP (FPBA-01 adapter).

Note: The text and examples in this chapter describe the configuration of one fieldbus adapter (FBA A) by parameters [50.01 ...50.18](#) and parameter groups [51 FBA A settings...53 FBA A data out](#).

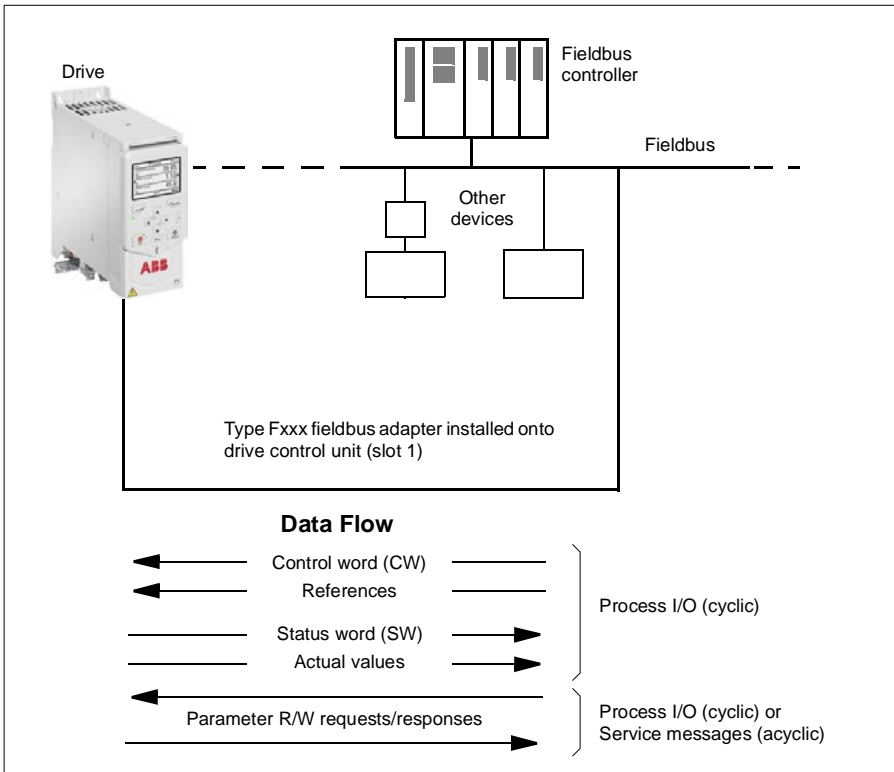

Basics of the fieldbus control interface

The cyclic communication between a fieldbus system and the drive consists of 16- or 32-bit input and output data words. The drive is able to support a maximum of 12 data words (16 bits) in each direction.

Data transmitted from the drive to the fieldbus controller is defined by parameters [52.01 FBA A data in1](#) ... [52.12 FBA A data in12](#). The data transmitted from the fieldbus controller to the drive is defined by parameters [53.01 FBA A data out1](#) ... [53.12 FBA A data out12](#).

■ Control word and Status word

The Control word is the principal means for controlling the drive from a fieldbus system. It is sent by the fieldbus master station to the drive through the adapter module. The drive switches between its states according to the bit-coded instructions in the Control word, and returns status information to the master in the Status word.

For the ABB Drives communication profile, the contents of the Control word and the Status word are detailed on pages [328](#) and [329](#), respectively. The drive states are presented in the state diagram (page [330](#)). For other fieldbus-specific communication profiles, see the *User's manual* of the fieldbus adapter.

Debugging the network words

If parameter [50.12 FBA A debug mode](#) is set to *Fast*, the Control word received from the fieldbus is shown by parameter [50.13 FBA A control word](#), and the Status word transmitted to the fieldbus network by [50.16 FBA A status word](#). This “raw” data is very useful to determine if the fieldbus master is transmitting the correct data before handing control to the fieldbus network.

References

References are 16-bit words containing a sign bit and a 15-bit integer. A negative reference (indicating reversed direction of rotation) is formed by calculating the two's complement from the corresponding positive reference.

ABB drives can receive control information from multiple sources including analog and digital inputs, the drive control panel and a fieldbus adapter module. In order to have the drive controlled through the fieldbus, the module must be defined as the source for control information such as reference. This is done using the source selection parameters in groups [22 Speed reference selection](#) and [28 Frequency reference chain](#).

Debugging the network words

If parameter [50.12 FBA A debug mode](#) is set to *Fast*, the references received from the fieldbus are displayed by [50.14 FBA A reference 1](#) and [50.15 FBA A reference 2](#).

Scaling of references

Note: The scalings described below are for the ABB Drives communication profile. Fieldbus-specific communication profiles may use different scalings. For more information, see the *User's manual* of the fieldbus adapter.

The references are scaled as defined by parameters [46.01...46.04](#); which scaling is in use depends on the setting of [50.04 FBA A ref1 type](#) and [50.05 FBA A ref2 type](#).

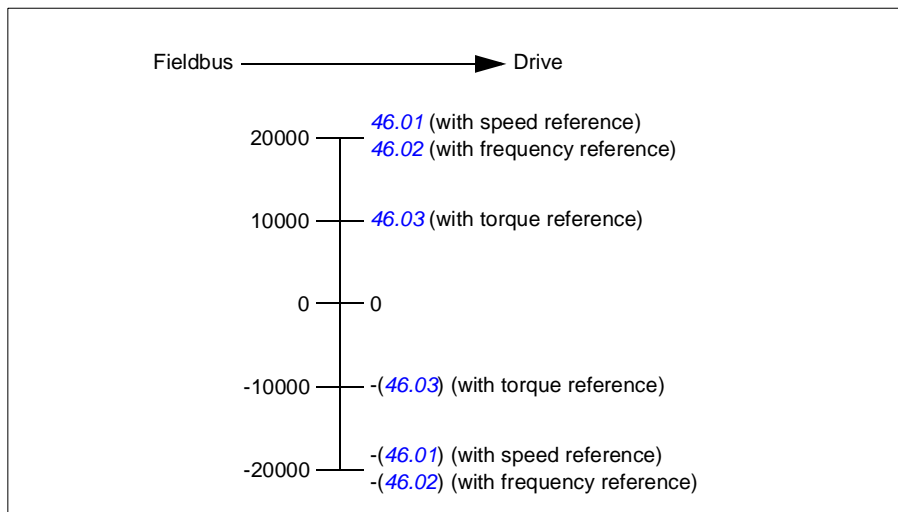

The scaled references are shown by parameters [03.05 FB A reference 1](#) and [03.06 FB A reference 2](#).

Actual values

Note: The scalings described below are for the ABB Drives communication profile. Fieldbus-specific communication profiles may use different scalings. For more information, see the *User's manual* of the fieldbus adapter.

Actual values are 16-bit words containing information on the operation of the drive. The types of the monitored signals are selected by parameters [50.07 FBA A actual 1 type](#) and [50.08 FBA A actual 2 type](#).

Debugging the network words

If parameter [50.12 FBA A debug mode](#) is set to *Fast*, the actual values sent to the fieldbus are displayed by [50.17 FBA A actual value 1](#) and [50.18 FBA A actual value 2](#).

Scaling of actual values

The actual values are scaled as defined by parameters [46.01...46.04](#); which scaling is in use depends on the setting of parameters [50.07 FBA A actual 1 type](#) and [50.08 FBA A actual 2 type](#).

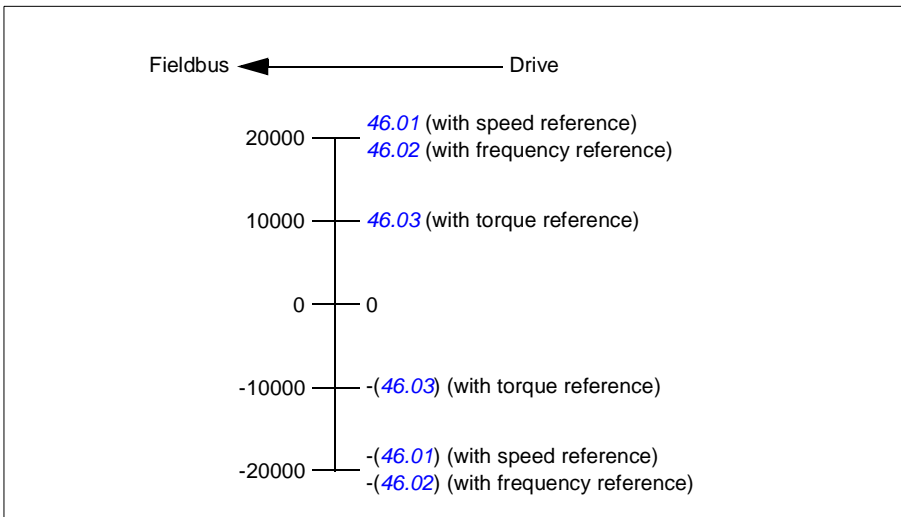

■ Contents of the fieldbus Control word (ABB Drives profile)

The upper case boldface text refers to the states shown in the state diagram (page 330).

Bit	Name	Value	STATE/Description
0	Off1 control	1	Proceed to READY TO OPERATE .
		0	Stop along currently active deceleration ramp. Proceed to OFF1 ACTIVE ; proceed to READY TO SWITCH ON unless other interlocks (OFF2, OFF3) are active.
1	Off2 control	1	Continue operation (OFF2 inactive).
		0	Emergency OFF, coast to a stop. Proceed to OFF2 ACTIVE , proceed to SWITCH-ON INHIBITED .
2	Off3 control	1	Continue operation (OFF3 inactive).
		0	Emergency stop, stop within time defined by drive parameter. Proceed to OFF3 ACTIVE ; proceed to SWITCH-ON INHIBITED .  WARNING: Ensure motor and driven machine can be stopped using this stop mode.
3	Run	1	Proceed to OPERATION ENABLED . Note: Run permissive signal must be active; see the drive documentation. If the drive is set to receive the Run permissive signal from the fieldbus, this bit activates the signal. See also parameter <i>06.18 Start inhibit status word</i> .
		0	Inhibit operation. Proceed to OPERATION INHIBITED .
4	Ramp out zero	1	Normal operation. Proceed to RAMP FUNCTION GENERATOR: OUTPUT ENABLED .
		0	Force Ramp function generator output to zero. The drive will immediately decelerate to zero speed (observing the torque limits).
5	Ramp hold	1	Enable ramp function. Proceed to RAMP FUNCTION GENERATOR: ACCELERATOR ENABLED .
		0	Halt ramping (Ramp Function Generator output held).
6	Ramp in zero	1	Normal operation. Proceed to OPERATING . Note: This bit is effective only if the fieldbus interface is set as the source for this signal by drive parameters.
		0	Force Ramp function generator input to zero.
7	Reset	0=>1	Fault reset if an active fault exists. Proceed to SWITCH-ON INHIBITED . Note: This bit is effective only if the fieldbus interface is set as the source of the reset signal by drive parameters.
		0	Continue normal operation.
8...9	Reserved		
10	Remote cmd	1	Fieldbus control enabled.
		0	Control word and reference not getting through to the drive, except for bits 0...2.
11	Ext ctrl loc	1	Select External Control Location EXT2. Effective if control location is parameterized to be selected from fieldbus.
		0	Select External Control Location EXT1. Effective if control location is parameterized to be selected from fieldbus.
12	User bit 0	1	User configurable
		0	
13	User bit 1	1	
		0	
14	User bit 2	1	
		0	
15	User bit 3	1	
		0	

■ Contents of the fieldbus Status word (ABB Drives profile)

The upper case boldface text refers to the states shown in the state diagram (page 330).

Bit	Name	Value	STATE/Description
0	Ready to switch ON	1	READY TO SWITCH ON.
		0	NOT READY TO SWITCH ON.
1	Ready run	1	READY TO OPERATE.
		0	OFF1 ACTIVE.
2	Ready ref	1	OPERATION ENABLED.
		0	OPERATION INHIBITED. See also parameter 06.18 Start inhibit status word .
3	Tripped	1	FAULT.
		0	No fault.
4	Off 2 inactive	1	OFF2 inactive.
		0	OFF2 ACTIVE.
5	Off 3 inactive	1	OFF3 inactive.
		0	OFF3 ACTIVE.
6	Switch-on inhibited	1	SWITCH-ON INHIBITED.
		0	–
7	Warning	1	Warning active.
		0	No warning active.
8	At setpoint	1	OPERATING. Actual value equals reference = is within tolerance limits (see parameters 46.21...46.22).
		0	Actual value differs from reference = is outside tolerance limits.
9	Remote	1	Drive control location: REMOTE (EXT1 or EXT2).
		0	Drive control location: LOCAL.
10	Above limit	-	See parameter 06.29 MSW bit 10 selection .
11	User bit 0	-	See parameter 06.30 MSW bit 11 selection .
12	User bit 1	-	See parameter 06.31 MSW bit 12 selection .
13	User bit 2	-	See parameter 06.32 MSW bit 13 selection .
14	User bit 3	-	See parameter 06.33 MSW bit 14 selection .
15	Reserved		

■ The state diagram

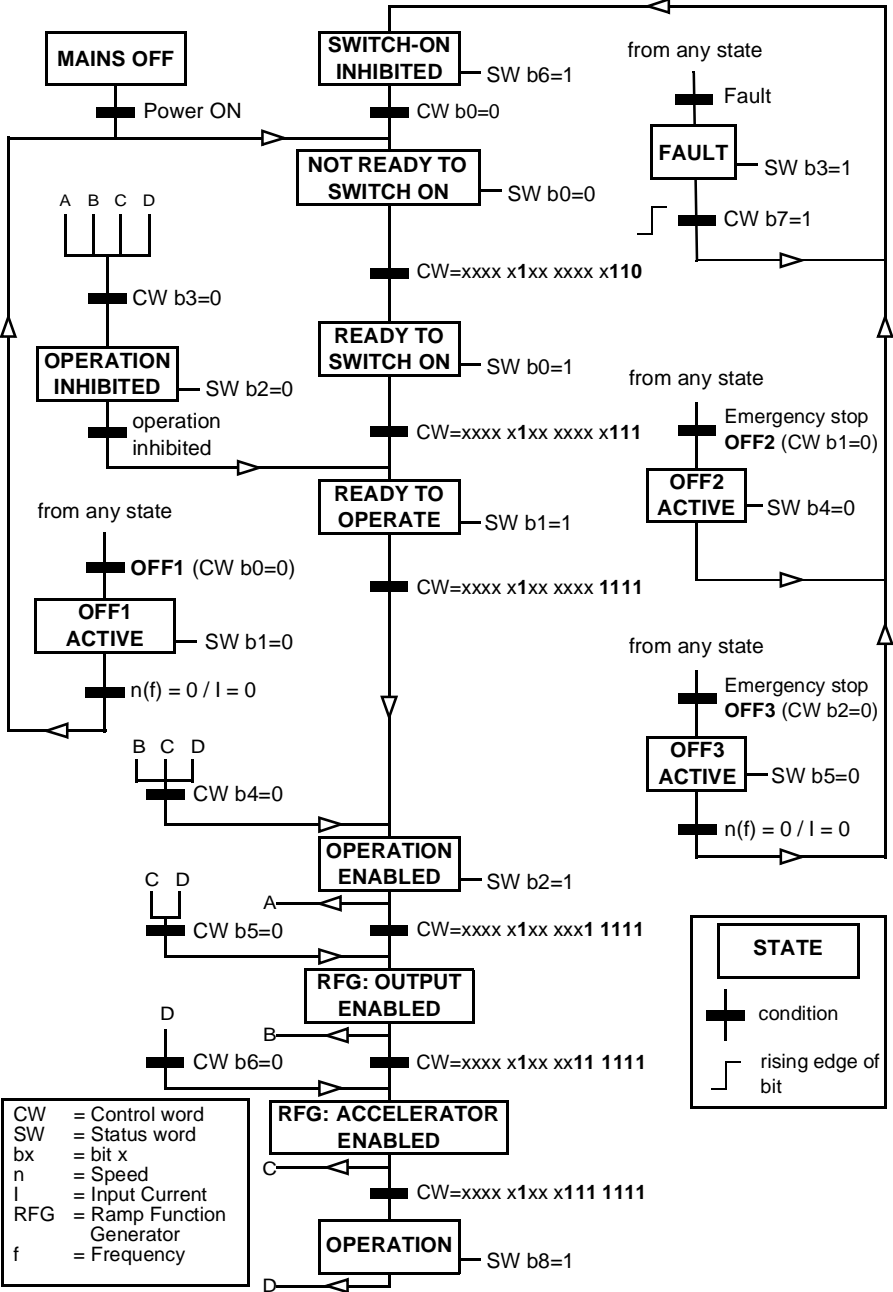

Setting up the drive for fieldbus control

1. Install the fieldbus adapter module mechanically and electrically according to the instructions given in the *User's manual* of the module.
2. Power up the drive.
3. Enable the communication between the drive and the fieldbus adapter module with parameter [50.01 FBA A enable](#).
4. With [50.02 FBA A comm loss func](#), select how the drive should react to a fieldbus communication break.
Note: This function monitors both the communication between the fieldbus master and the adapter module and the communication between the adapter module and the drive.
5. With [50.03 FBA A comm loss t out](#), define the time between communication break detection and the selected action.
6. Select application-specific values for the rest of the parameters in group [50 Fieldbus adapter \(FBA\)](#), starting from [50.04](#). Examples of appropriate values are shown in the tables below.
7. Set the fieldbus adapter module configuration parameters in group [51 FBA A settings](#). As a minimum, set the required node address and the communication profile.
8. Define the process data transferred to and from the drive in parameter groups [52 FBA A data in](#) and [53 FBA A data out](#).
Note: Depending on the communication protocol and profile being used, the Control word and Status word may already be configured to be sent/received by the communication system.
9. Save the valid parameter values to permanent memory by setting parameter [96.07 Parameter save manually](#) to [Save](#).
10. Validate the settings made in parameter groups 51, 52 and 53 by setting parameter [51.27 FBA A par refresh](#) to [Configure](#).
11. Configure control locations EXT1 and EXT2 to allow control and reference signals to come from the fieldbus. Examples of appropriate values are shown in the tables below.

■ Parameter setting example: FPBA (PROFIBUS DP) with ABB Drives profile

This example shows how to configure a basic speed control application that uses the ABB Drives communication profile with PPO Type 2. The start/stop commands and reference are according to the ABB Drives profile, speed control mode.

The reference values sent over the fieldbus have to be scaled within the drive so they have the desired effect. The reference value ± 20000 corresponds to the range of speed set in parameter [46.01 Speed scaling](#) (both forward and reverse directions). For example, if [46.01](#) is set to 480 rpm, then 20000 sent over fieldbus will request 480 rpm.

Direction	PZD1	PZD2	PZD3	PZD4	PZD5	PZD6
Out	Control word	Speed reference	Acc time 1		Dec time 1	
In	Status word	Speed actual value	Motor current		DC voltage	

The table below gives the recommended drive parameter settings.

Drive parameter	Setting for ACH480 drives	Description
50.01 FBA A enable	1 = [slot number]	Enables/disables communication between the drive and the fieldbus adapter module.
50.04 FBA A ref1 type	4 = <i>Speed</i>	Selects the fieldbus A reference 1 type and scaling.
50.07 FBA A actual 1 type	0 = <i>Speed or frequency</i>	Selects the actual value type and scaling according to the currently active Ref1 mode defined in parameter 50.04 .
51.01 FBA A type	1 = FPBA ¹⁾	Displays the type of the fieldbus adapter module.
51.02 Node address	3 ²⁾	Defines the PROFIBUS node address of the fieldbus adapter module.
51.03 Baud rate	12000 ¹⁾	Displays the current baud rate on the PROFIBUS network in kbit/s.
51.04 MSG type	1 = PPO2 ¹⁾	Displays the telegram type selected by the PLC configuration tool.
51.05 Profile	1 = ABB Drives	Selects the Control word according to the ABB Drives profile (speed control mode).
51.07 RPBA mode	0 = Disabled	Disables the RPBA emulation mode.
52.01 FBA A data in1	4 = SW 16bit ¹⁾	Status word
52.02 FBA data in2	5 = Act1 16bit	Actual value 1
52.03 FBA data in3	01.07 ²⁾	Motor current
52.05 FBA data in5	01.11 ²⁾	DC voltage
53.01 FBA data out1	1 = CW 16bit ¹⁾	Control word

Drive parameter	Setting for ACH480 drives	Description
53.02 FBA data out2	2 = Ref1 16bit	Reference 1 (speed)
53.03 FBA data out3	23.12 ²⁾	Acceleration time 1
53.05 FBA data out5	23.13 ²⁾	Deceleration time 1
<i>51.27 FBA A par refresh</i>	1 = <i>Configure</i>	Validates the configuration parameter settings.
<i>20.01 Ext1 commands</i>	12 = <i>Fieldbus A</i>	Selects fieldbus adapter A as the source of the start and stop commands for external control location EXT1.
<i>20.02 Ext1 start trigger type</i>	1 = <i>Level</i>	Selects a level-triggered start signal for external control location EXT1.
<i>22.11 Ext1 speed ref1</i>	4 = <i>FB A ref1</i>	Selects fieldbus A reference 1 as the source for speed reference 1.

¹⁾ Read-only or automatically detected/set

²⁾ Example

■ Parameter setting example: FPBA (PROFIBUS DP) with PROFIdrive profile

This example shows how to configure a basic speed control application that uses the PROFIdrive communication profile with PPO Type 2. The start/stop commands and reference are according to the PROFIdrive profile, speed control mode.

The reference values sent over the fieldbus have to be scaled within the drive so they have the desired effect. The reference value ± 16384 (4000h) corresponds to the range of speed set in parameter [46.01 Speed scaling](#) (both forward and reverse directions). For example, if [46.01](#) is set to 480 rpm, then 4000h sent over fieldbus will request 480 rpm.

Direction	PZD1	PZD2	PZD3	PZD4	PZD5	PZD6
Out	Control word	Speed reference	Acc time 1		Dec time 1	
In	Status word	Speed actual value	Motor current		DC voltage	

The table below gives the recommended drive parameter settings.

Drive parameter	Setting for ACH480 drives	Description
50.01 FBA A enable	1 = [slot number]	Enables/disables communication between the drive and the fieldbus adapter module.
50.04 FBA A ref1 type	4 = <i>Speed</i>	Selects the fieldbus A reference 1 type and scaling.
50.07 FBA A actual 1 type	0 = <i>Speed or frequency</i>	Selects the actual value type and scaling according to the currently active Ref1 mode defined in parameter 50.04 .
51.01 FBA A type	1 = FPBA ¹⁾	Displays the type of the fieldbus adapter module.
51.02 Node address	3 ²⁾	Defines the PROFIBUS node address of the fieldbus adapter module.
51.03 Baud rate	12000 ¹⁾	Displays the current baud rate on the PROFIBUS network in kbit/s.
51.04 MSG type	1 = PPO2 ¹⁾	Displays the telegram type selected by the PLC configuration tool.
51.05 Profile	0 = PROFIdrive	Selects the Control word according to the PROFIdrive profile (speed control mode).
51.07 RPBA mode	0 = Disabled	Disables the RPBA emulation mode.
52.01 FBA A data in1	4 = SW 16bit ¹⁾	Status word
52.02 FBA data in2	5 = Act1 16bit	Actual value 1
52.03 FBA data in3	01.07 ²⁾	Motor current
52.05 FBA data in5	01.11 ²⁾	DC voltage
53.01 FBA data out1	1 = CW 16bit ¹⁾	Control word

Drive parameter	Setting for ACH480 drives	Description
53.02 FBA data out2	2 = Ref1 16bit	Reference 1 (speed)
53.03 FBA data out3	23.12 ²⁾	Acceleration time 1
53.05 FBA data out5	23.13 ²⁾	Deceleration time 1
<i>51.27 FBA A par refresh</i>	1 = <i>Configure</i>	Validates the configuration parameter settings.
<i>20.01 Ext1 commands</i>	12 = <i>Fieldbus A</i>	Selects fieldbus adapter A as the source of the start and stop commands for external control location EXT1.
<i>20.02 Ext1 start trigger type</i>	1 = <i>Level</i>	Selects a level-triggered start signal for external control location EXT1.
<i>22.11 Ext1 speed ref1</i>	4 = <i>FB A ref1</i>	Selects fieldbus A reference 1 as the source for speed reference 1.

¹⁾ Read-only or automatically detected/set

²⁾ Example

The start and stop sequences for the parameter examples above are given below.

Control word:

Start:

- 1142 (476h) → NOT READY TO SWITCH ON
- If MSW bit 0 = 1 then
 - 1150 (47Eh) → READY TO SWITCH ON (Stopped)
 - 1151 (47Fh) → OPERATION (Running)

Stop:

- 1143 (477h) = Stop according to [21.03 Stop mode](#) (Preferred)
- 1150 (47Eh) = OFF1 ramp stop (Note: uninterruptable ramp stop)
- 1149 (47Dh) = OFF2 emergency coast to stop
- 1147 (47Bh) = OFF3 emergency ramp stop

Fault reset:

- Rising edge of MCW bit 7

Start after STO:

- If [31.22 STO indication run/stop](#) is not Fault/ Fault, check that [06.18 Start inhibit status word](#), bit 7 STO = 0 before giving a start command.

Automatic drive configuration for fieldbus control

The parameters set on module detection are shown in the table below. See also parameters [07.35 Drive configuration](#) and [07.36 Drive configuration 2](#).

Option	10.24 RO1 source	10.27 RO2 source	10.30 RO3 source	20.01 Ext1 commands	20.03 Ext1 in1 source	20.04 Ext1 in2 source
BIO-01	-	-	-	2 (In1 Start, In2 Dir)	2 (DI1)	3 (DI2)
RIIO-01	-	-	-	2 (In1 Start, In2 Dir)	2 (DI1)	3 (DI2)

Option	22.11 Ext1 speed ref1	22.22 Constant speed sel1	23.11 Ramp set selection	28.11 Ext1 frequency ref1	28.22 Constant frequency sel1	28.71 Freq ramp set selection
BIO-01	1 (AI1 scaled)	4 (DI3)	6 (DI5)	1 (AI1 scaled)	4 (DI3)	6 (DI5)
RIIO-01	1 (AI1 scaled)	4 (DI3)	6 (DI5)	1 (AI1 scaled)	4 (DI3)	6 (DI5)

Option	31.11 Fault reset selection
BIO-01	0
RIIO-01	0

Option	50.01 FBA A enable	50.02 FBA A comm loss func	51.02 FBA A Par2	51.04 FBA A Par4	51.05 FBA A Par5	51.06 FBA A Par6
BIO-01	0	0	-	-	-	-
RIIO-01	0	0	-	-	-	-
FENA-21	1 (Enable)	0 (No action)	11	0	-	-
FECA-01	1 (Enable)	0 (No action)	0	-	-	-
FPBA-01	1 (Enable)	0 (No action)	-	-	1	-
FCAN-01	1 (Enable)	0 (No action)	-	-	0	-
FSCA-01	1 (Enable)	0 (No action)	-	-	-	10
FEIP-21	1 (Enable)	0 (No action)	100	0	-	-
FMBT-21	1 (Enable)	0 (No action)	0	0	-	-
FBIP-21	1 (Enable)	0 (No action)	-	0	-	-
FPNO-21	1 (Enable)	0 (No action)	11	0	-	-
FEPL-02	1 (Enable)	0 (No action)	-	-	-	-
FDNA-01	1 (Enable)	0 (No action)	-	-	-	-
FCNA-01	1 (Enable)	0 (No action)	-	-	-	-

Option	51.07 FBA A Par7	51.21 FBA A Par21	51.23 FBA A Par23	51.24 FBA A Par24	52.01 FBA data in1	52.02 FBA data in2
BIO-01	-	-	-	-	-	-
RIIO-01	-	-	-	-	-	-
FENA-21	-	-	-	-	4	5
FECA-01	-	-	-	-	-	-
FPBA-01	-	-	-	-	4	5
FCAN-01	-	-	-	-	-	-
FSCA-01	1	-	-	-	-	-
FEIP-21	-	-	128	128	-	-
FMBT-21	-	1	-	-	-	-
FBIP-21	-	-	-	-	-	-
FPNO-21	-	-	-	-	4	5
FEPL-02	-	-	-	-	-	-
FDNA-01	-	-	-	-	-	-
FCNA-01	-	-	-	-	-	-

Option	53.01 FBA data out1	53.02 FBA data out2
BIO-01	-	-
RIIO-01	-	-
FENA-21	1	2
FECA-01	-	-
FPBA-01	1	2
FCAN-01	-	-
FSCA-01		
FEIP-21	-	-
FMBT-21	-	-
FBIP-21	-	-
FPNO-21	1	2
FEPL-02	-	-
FDNA-01	-	-
FCNA-01	-	-

12

Control chain diagrams

Contents of this chapter

The chapter presents the reference chains of the drive. The control chain diagrams can be used to trace how parameters interact and where parameters have an effect within the drive parameter system.

For a more general diagram, see section [Operating modes of the drive](#) (page 105).

Frequency reference selection

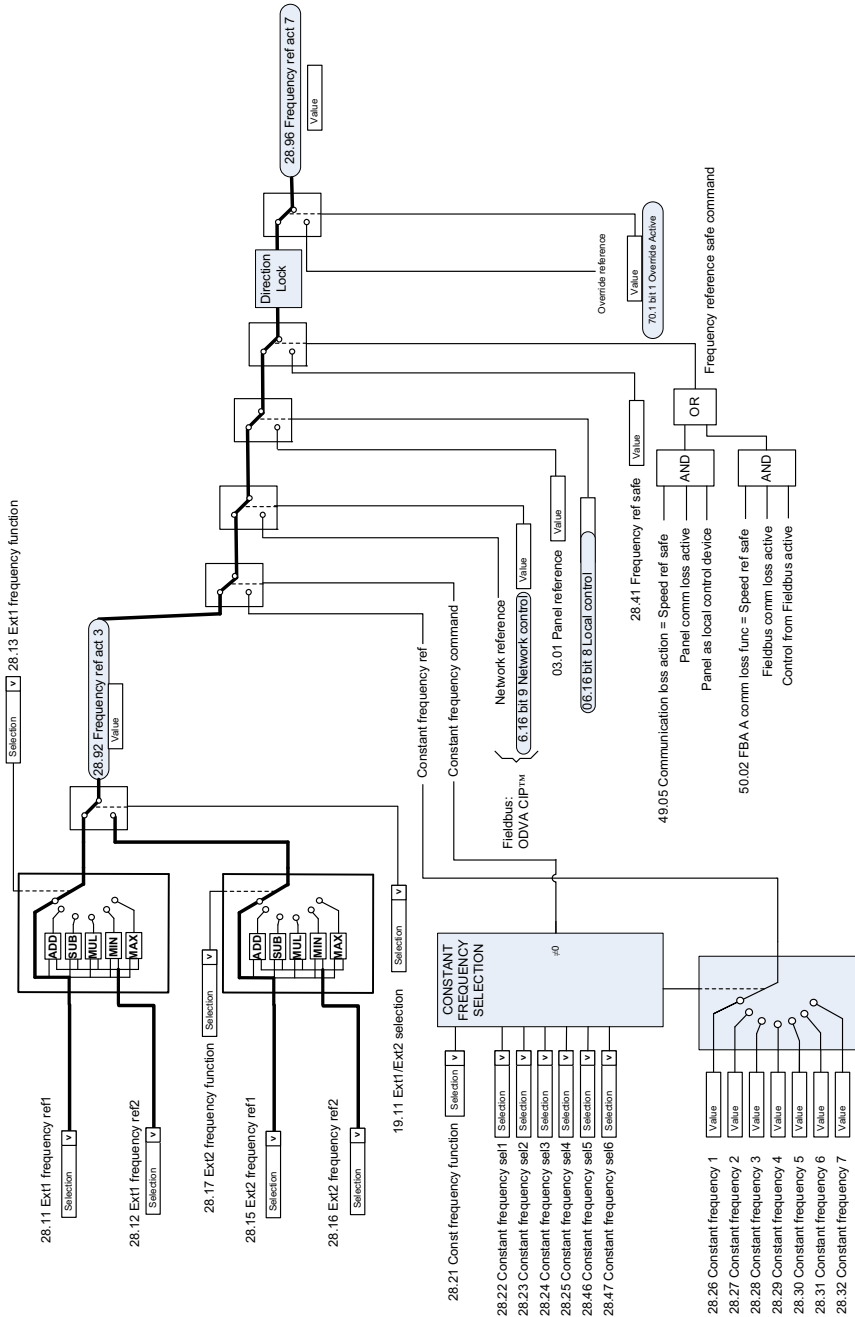

Frequency reference modification

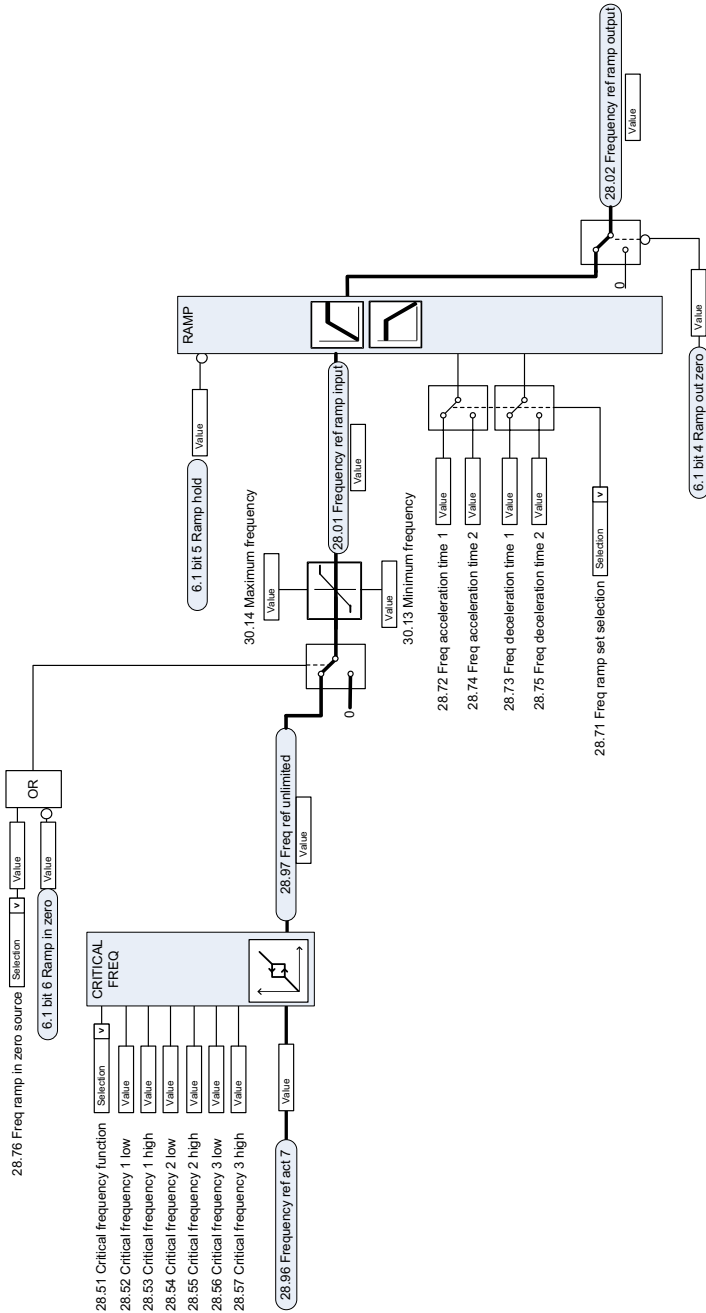

Speed reference source selection I

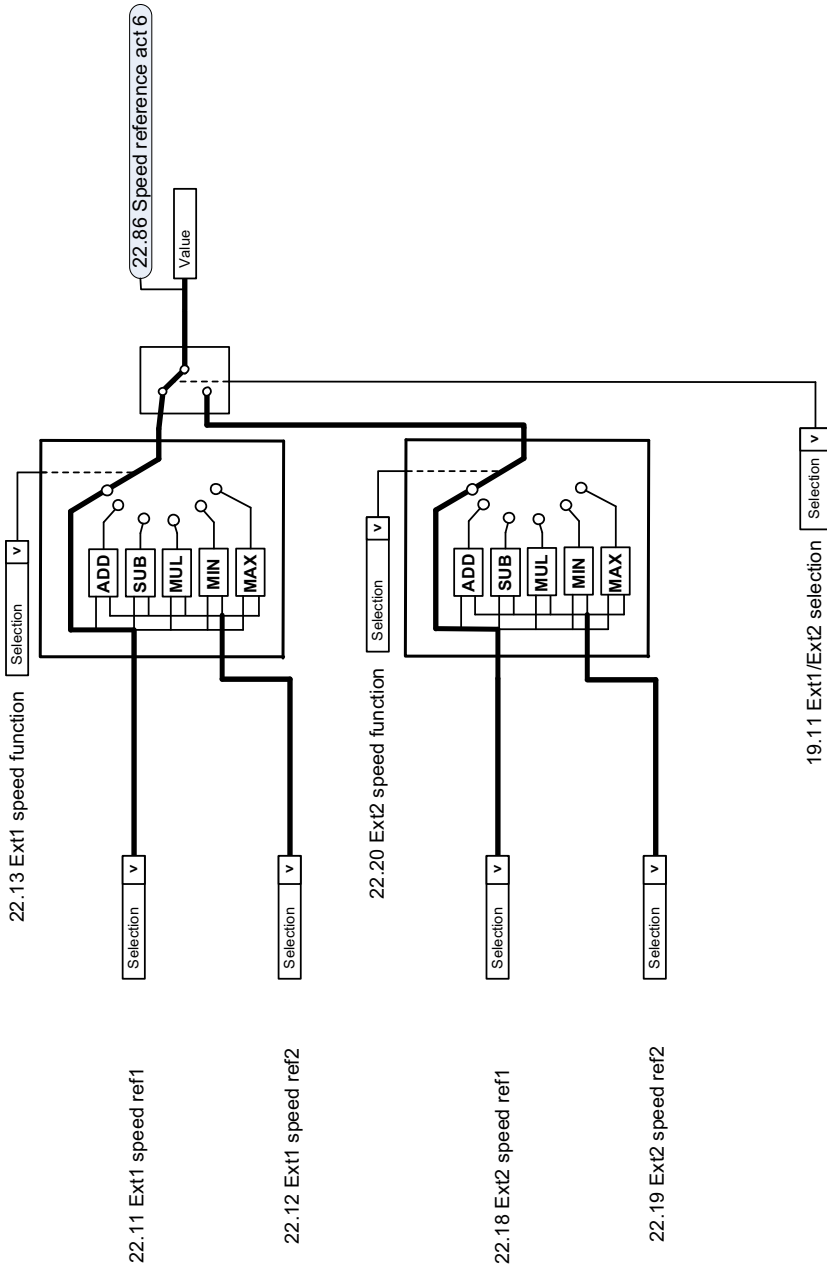

Speed reference source selection II

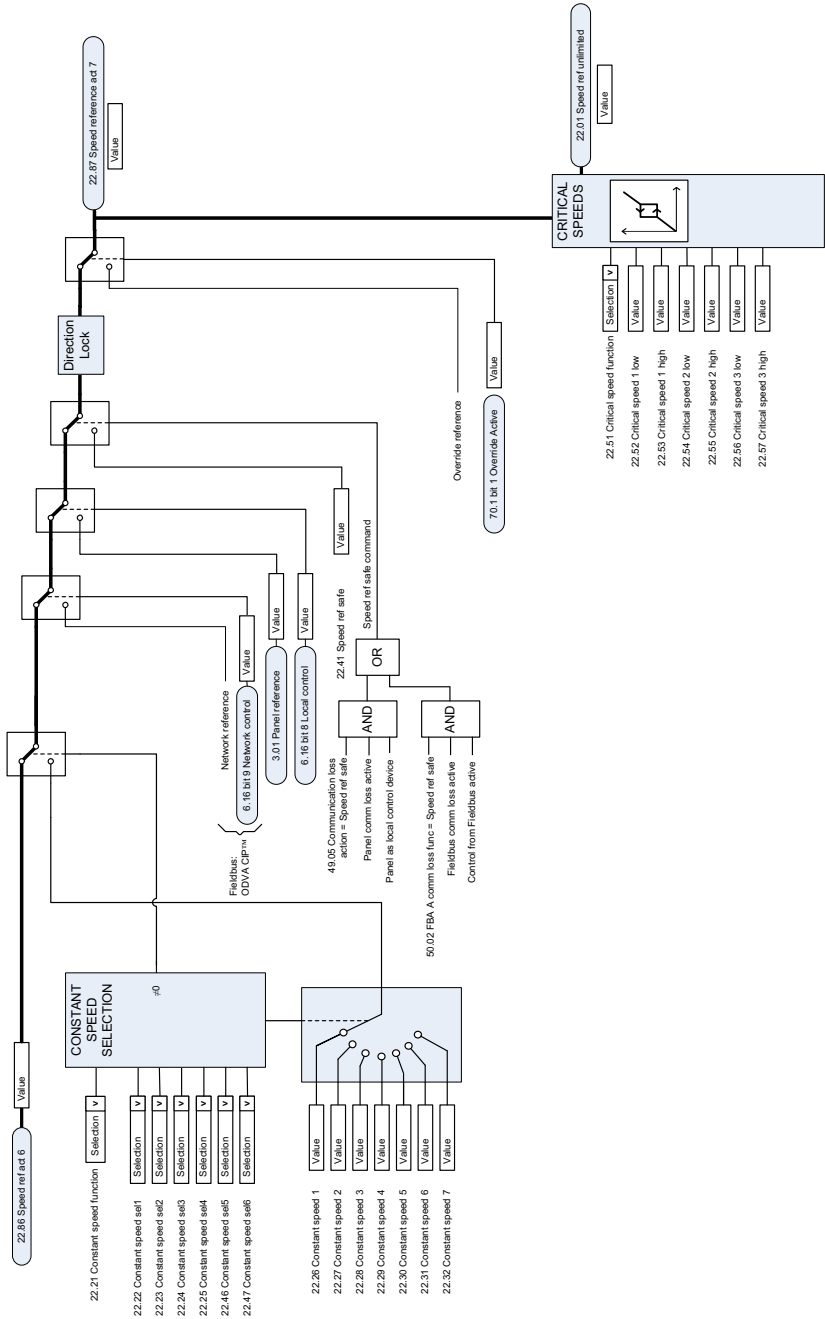

Speed reference ramping and shaping

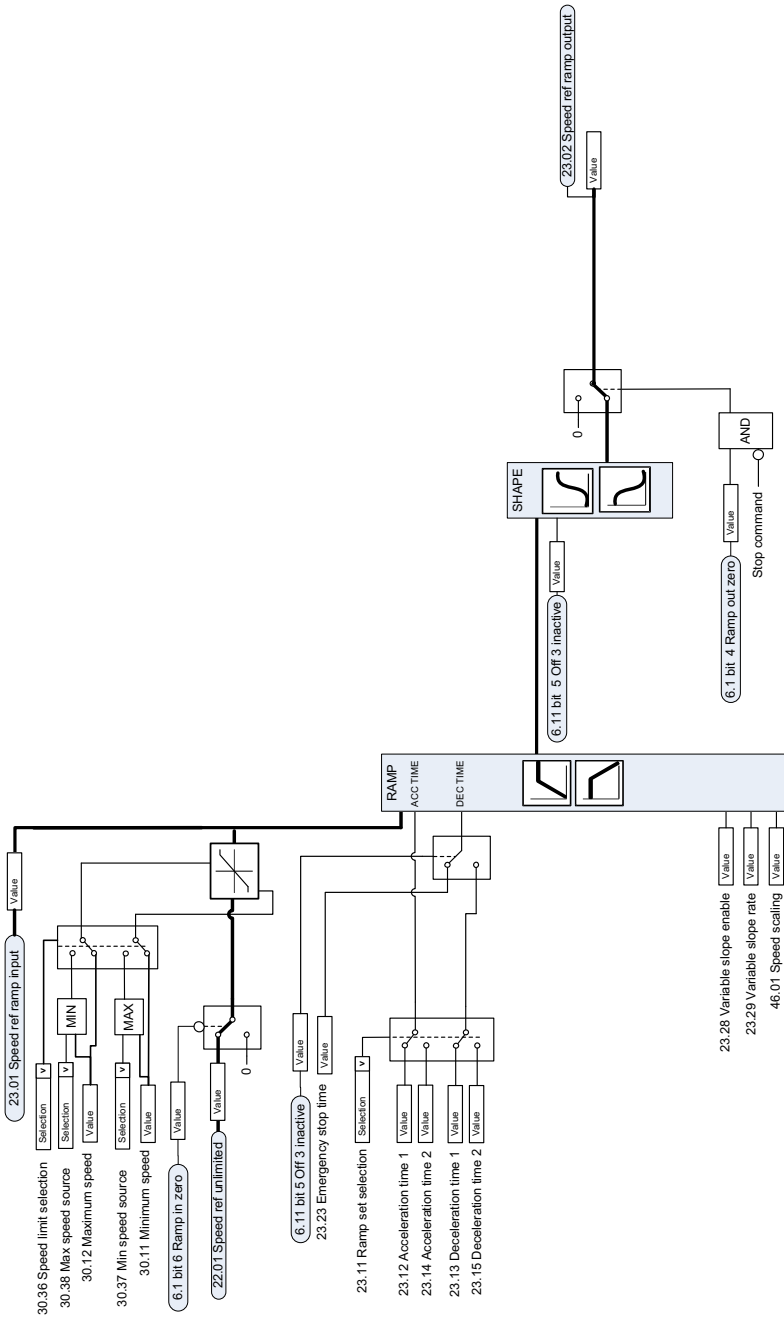

Speed error calculation

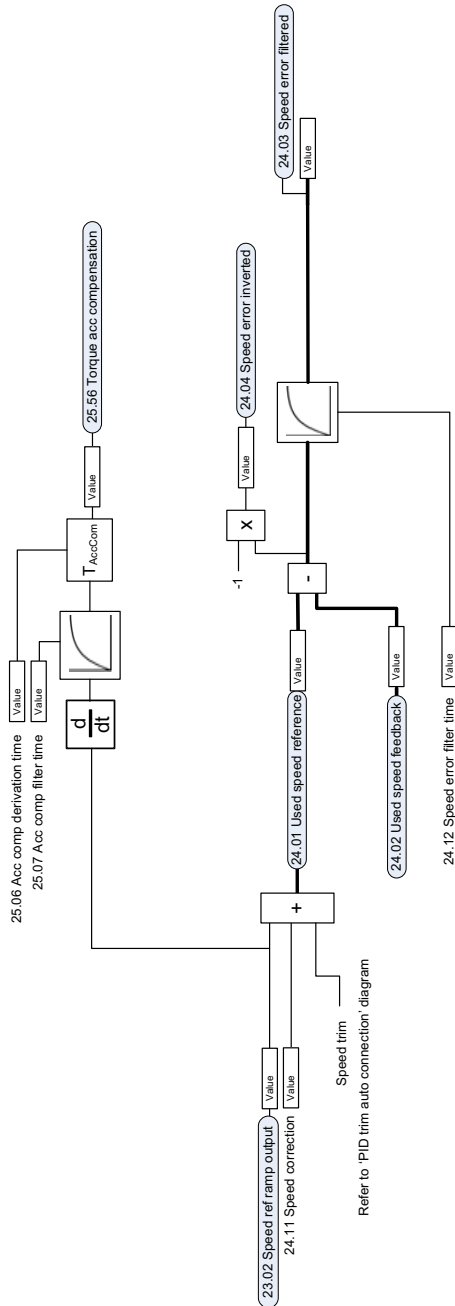

Speed feedback

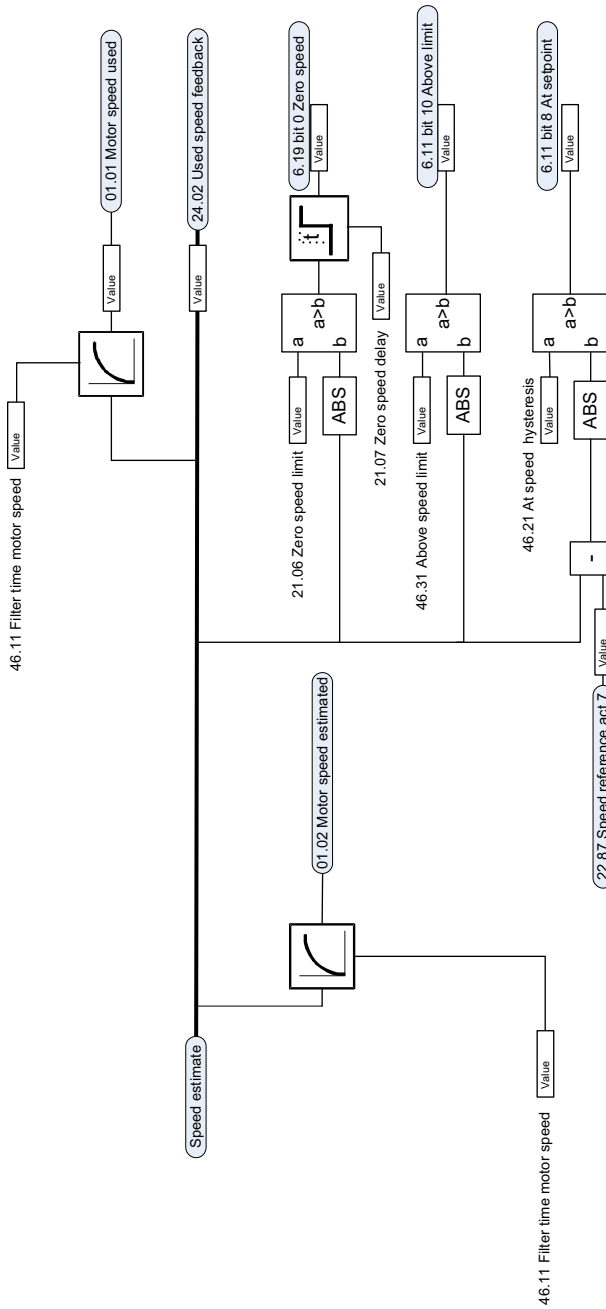

Speed controller

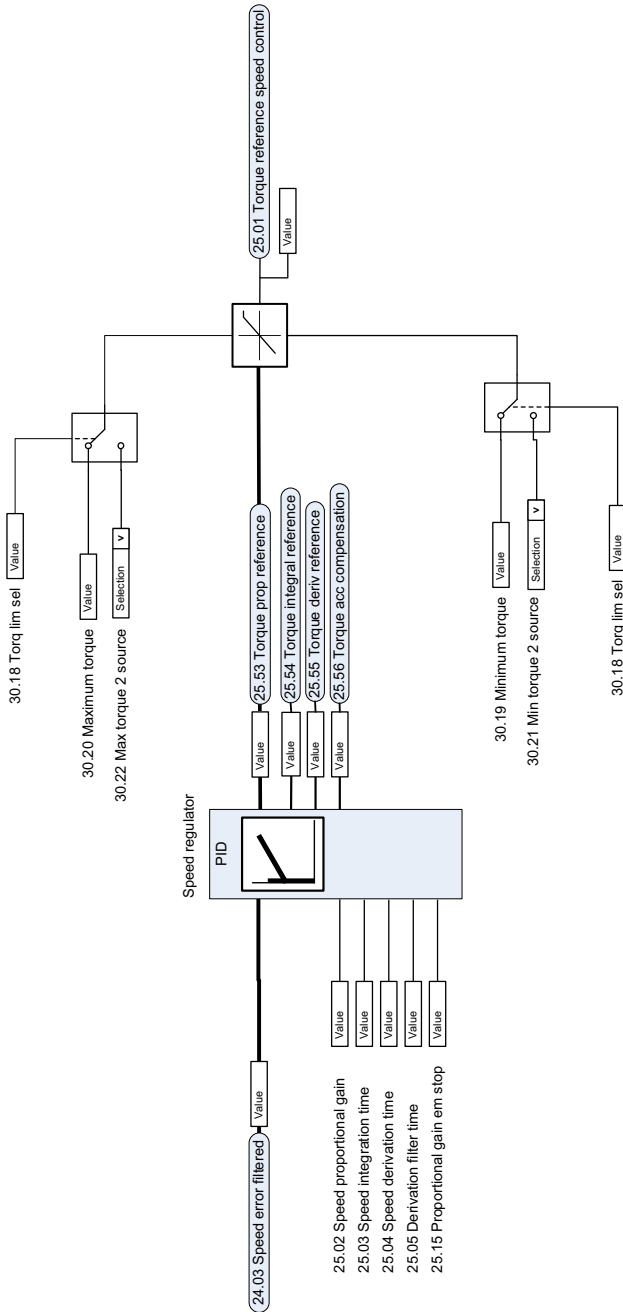

Torque limitation

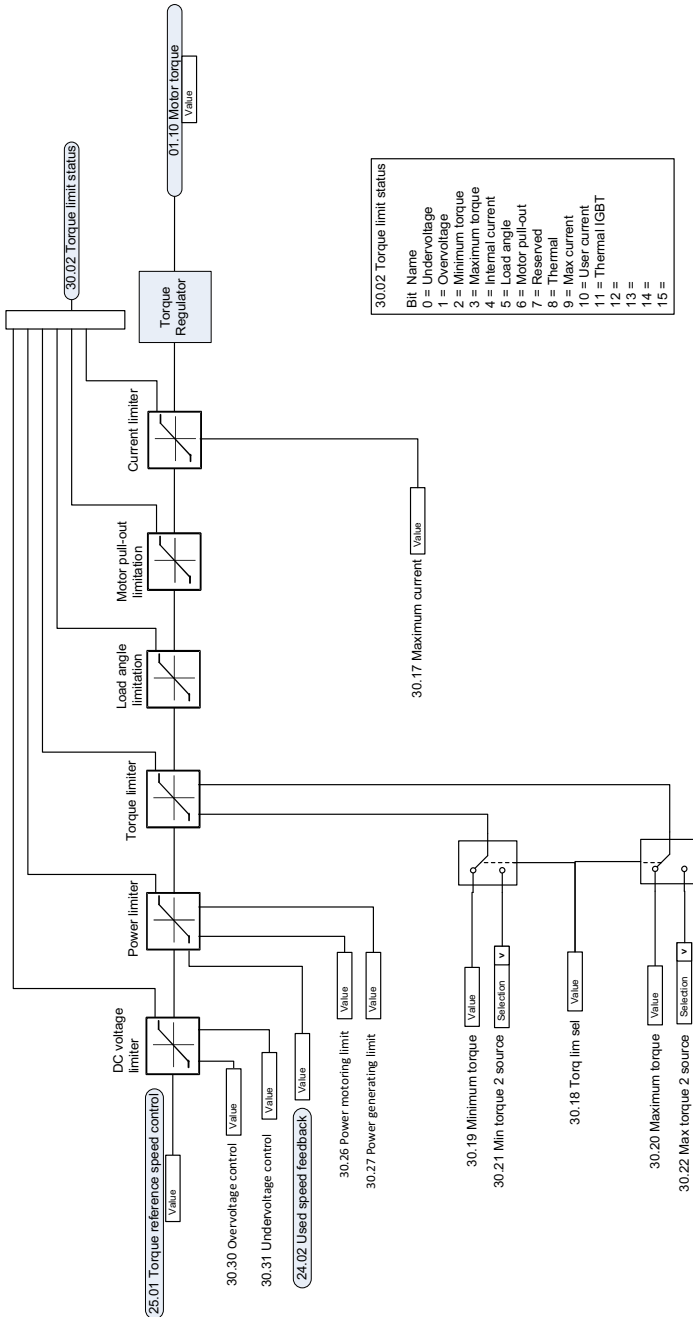

PID flow calculation

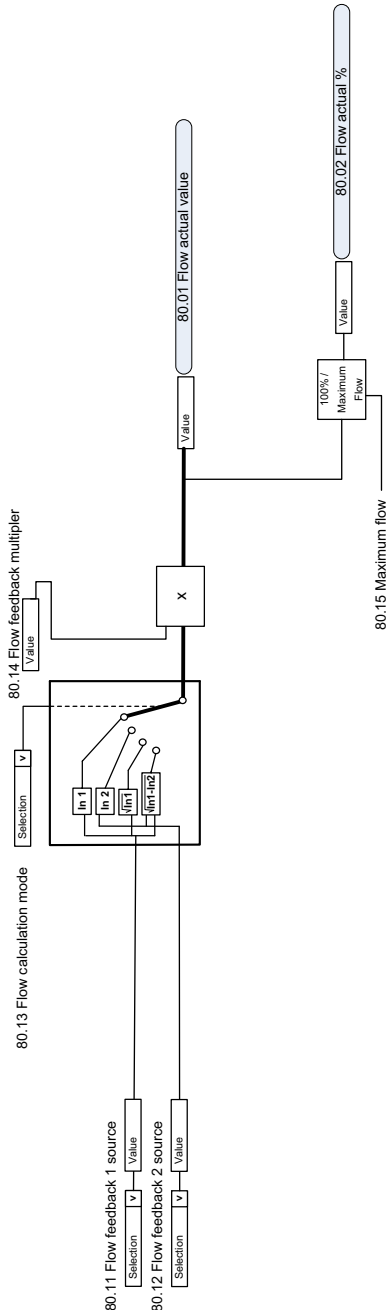

PID setpoint compensation

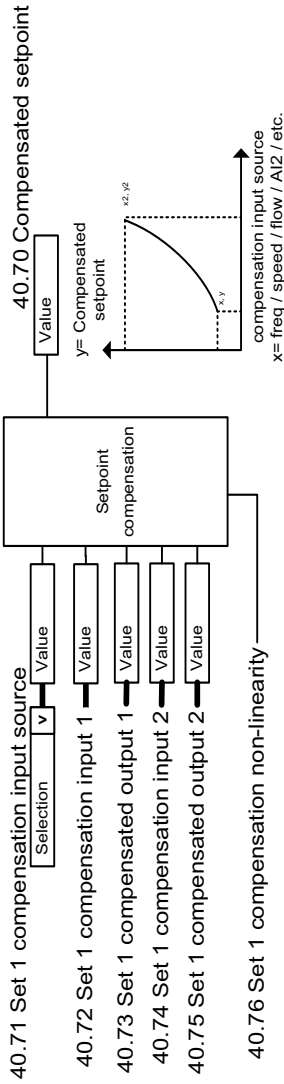

Process PID setpoint and feedback source selection

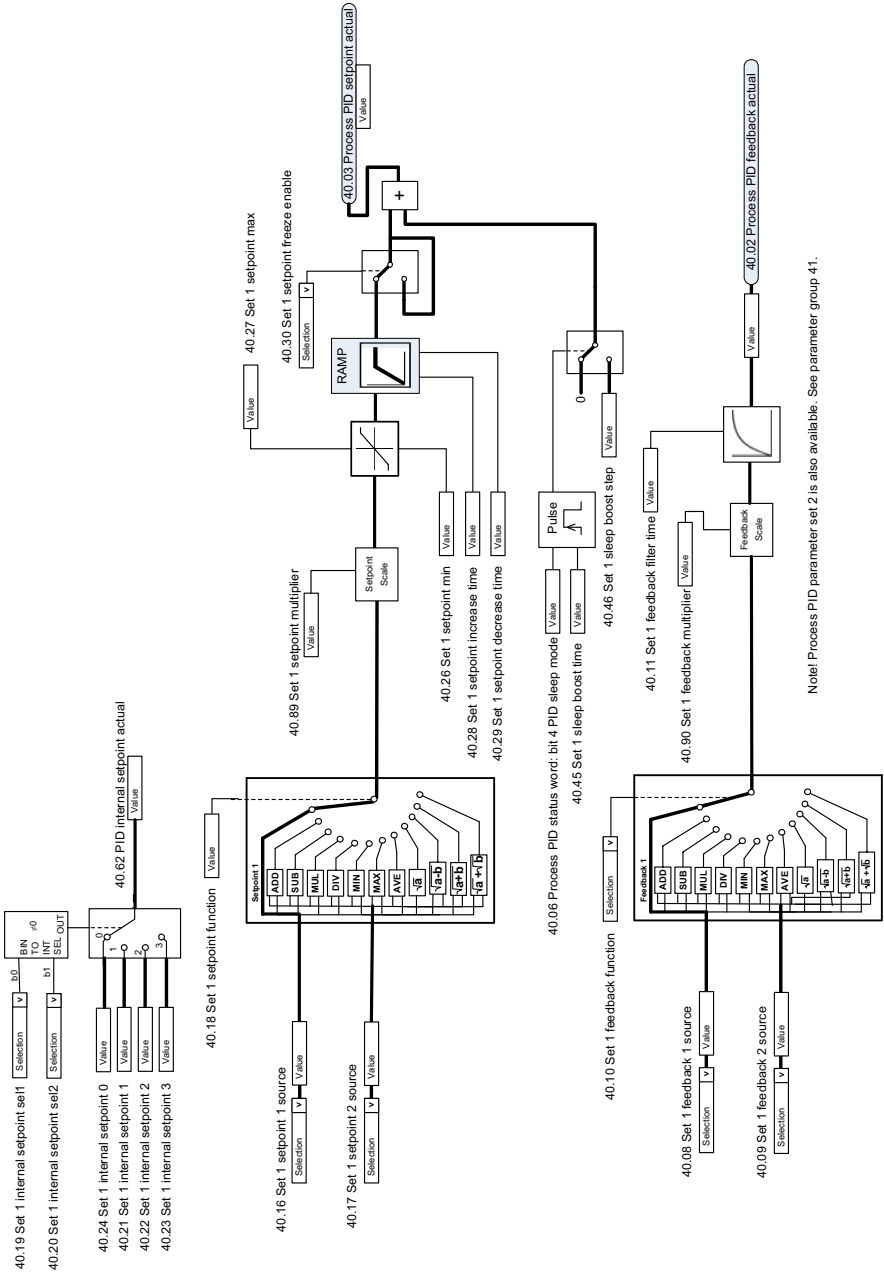

Note! Process PID parameter set 2 is also available. See parameter group 41.

Process PID controller

PROCESS PID FUNCTION

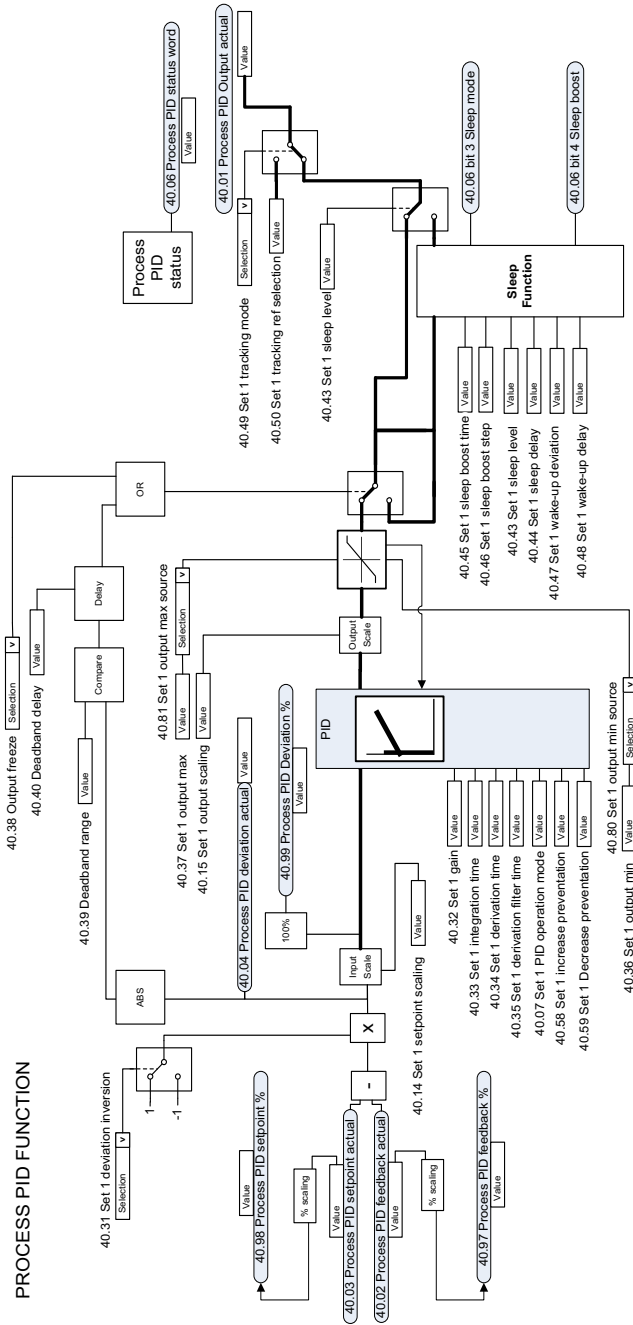

External PID setpoint and feedback source selection

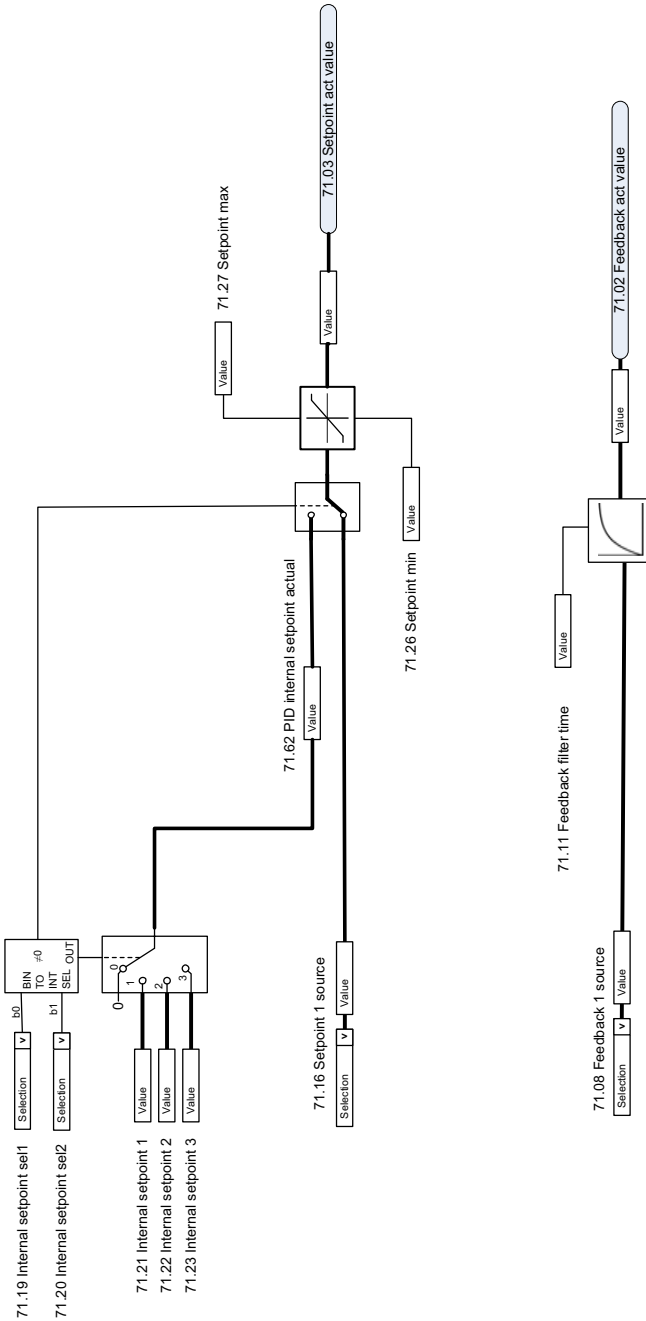

External PID controller

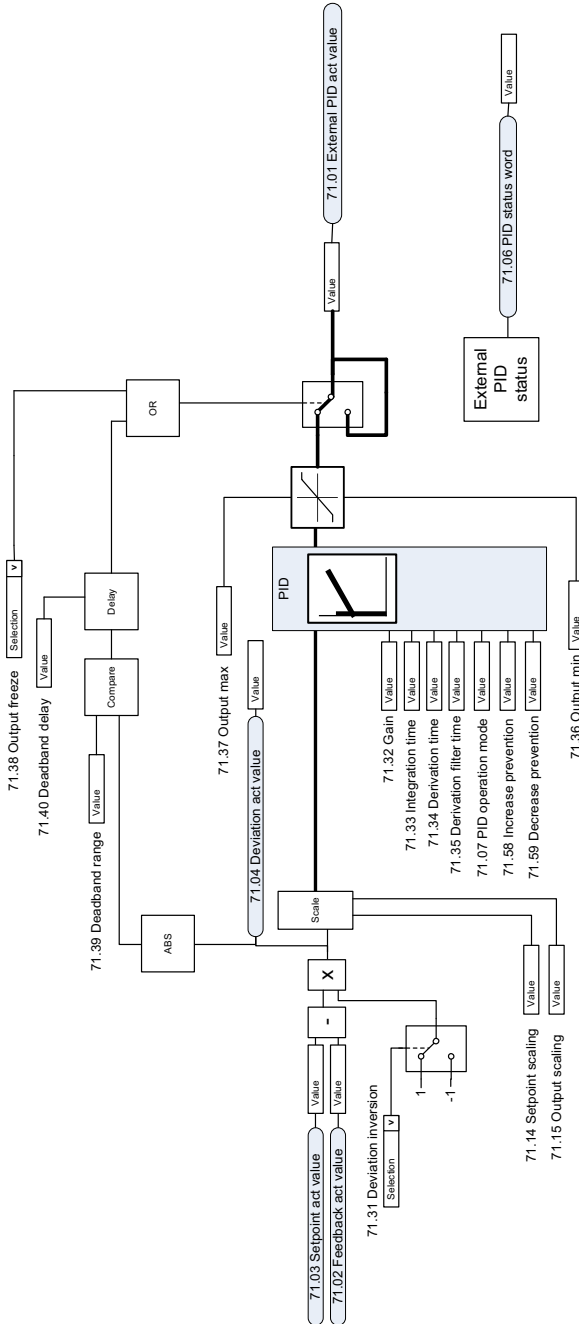

Direction lock

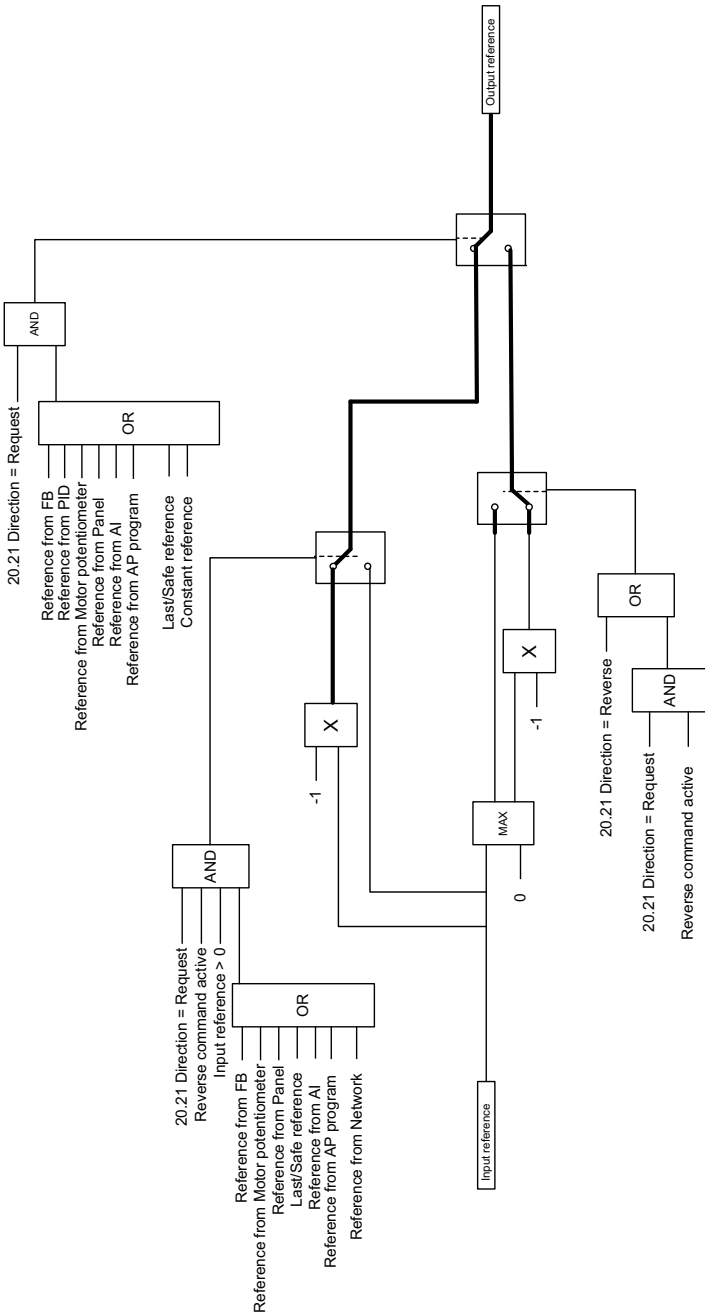

Override

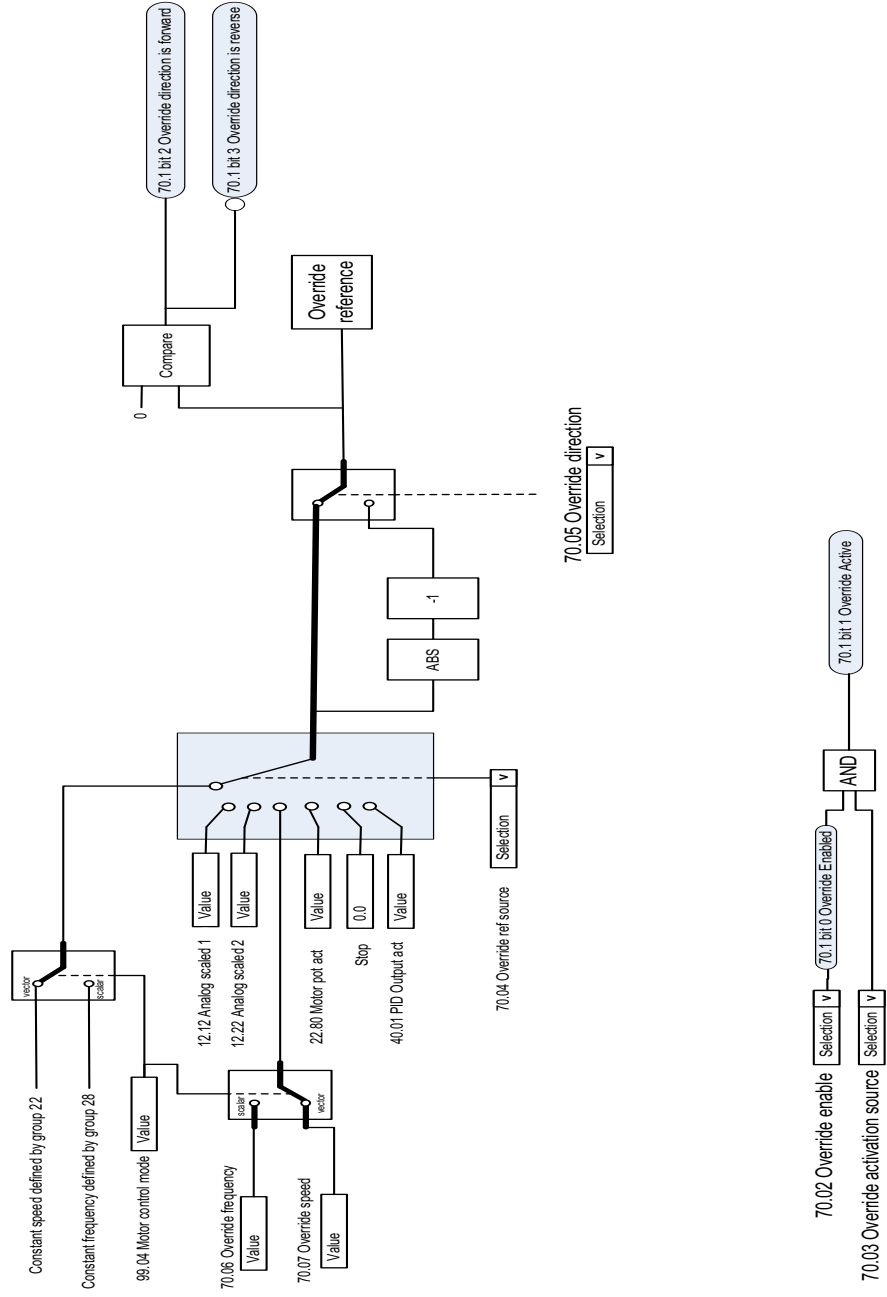

13

Parameters

What this chapter contains

The chapter describes the parameters, including actual signals, of the control program. At the end of the chapter, on page [629](#), there is a separate list of the parameters whose default values are different between 50 Hz and 60 Hz supply frequency settings.

Terms and abbreviations

Term	Definition
Actual signal	Type of parameter that is the result of a measurement or calculation by the drive, or contains status information. Most actual signals are read-only, but some (especially counter-type actual signals) can be reset.
Def	(In the following table, shown on the same row as the parameter name) The default value of a parameter when used in the default configuration. For information on other macro-specific parameter values, see chapter Default I/O configuration .
FbEq16	(In the following table, shown on the same row as the parameter range, or for each selection) 16-bit fieldbus equivalent: The scaling between the value shown on the control panel and the integer used in communication when a 16-bit value is selected for transmission to an external system. A dash (-) indicates that the parameter is not accessible in 16-bit format. The corresponding 32-bit scalings are listed in chapter Additional parameter data (page 685). Note: Any scaled value that exceeds 32767 will be clamped at 32767 when reading with a 16 bit system.
Other	The value is taken from another parameter. Choosing "Other" displays a parameter list in which the user can specify the source parameter.
Other [bit]	The value is taken from a specific bit in another parameter. Choosing "Other" displays a parameter list in which the user can specify the source parameter and bit.
Parameter	Either a user-adjustable operating instruction for the drive, or an actual signal .
p.u.	Per unit
[parameter number]	Value of the parameter

Summary of parameter groups

Group	Contents	Page
01 Actual values	Basic signals for monitoring the drive.	361
03 Input references	Values of references received from various sources.	364
04 Warnings and faults	Information on warnings and faults that occurred last.	365
05 Diagnostics	Various run-time-type counters and measurements related to drive maintenance.	367
06 Control and status words	Drive control and status words.	370
07 System info	Drive hardware and firmware information.	377
10 Standard DI, RO	Configuration of digital inputs and relay outputs.	379
11 Standard DIO, FI, FO	Configuration of frequency inputs 1 and 2 as well as frequency output and digital output.	390
12 Standard AI	Configuration of standard analog inputs.	398
13 Standard AO	Configuration of standard analog outputs.	404
15 I/O extension module	Configuration of the I/O extension module installed in slot 2.	410
19 Operation mode	Selection of local and external control location sources and operating modes.	419
20 Start/stop/direction	Start/stop/direction and run/start enable signal source selection; positive/negative reference enable signal source selection.	421
21 Start/stop mode	Start and stop modes; emergency stop mode and signal source selection; DC magnetization settings.	430
22 Speed reference selection	Speed reference selection; Floating point control (Motor potentiometer) settings.	439
23 Speed reference ramp	Speed reference ramp settings (programming of the acceleration and deceleration rates for the drive).	449
24 Speed reference conditioning	Speed error calculation; speed error window control configuration; speed error step.	452
25 Speed control	Speed controller settings.	453
28 Frequency reference chain	Settings for the frequency reference chain.	457
30 Limits	Drive operation limits.	467
31 Fault functions	Configuration of external events; selection of behavior of the drive upon fault situations.	475
32 Supervision	Configuration of signal supervision functions 1...6.	485
34 Timed functions	Configuration of the timed functions.	496
35 Motor thermal protection	Motor thermal protection settings such as temperature measurement configuration, load curve definition and motor fan control configuration; motor overload protection.	504
36 Load analyzer	Peak value and amplitude logger settings.	514
37 User load curve	Settings for user load curve.	517
40 Process PID set 1	Parameter values for process PID control.	521
41 Process PID set 2	A second set of parameter values for process PID control.	537
43 Brake chopper	Settings for the internal brake chopper.	540
45 Energy efficiency	Settings for the energy saving calculators as well as peak and energy loggers.	542
46 Monitoring/scaling settings	Speed supervision settings; actual signal filtering; general scaling settings.	546

Group	Contents	Page
47 Data storage	Data storage parameters that can be written to and read from using other parameters' source and target settings.	549
49 Panel port communication	Communication settings for the control panel port on the drive.	551
50 Fieldbus adapter (FBA)	Fieldbus communication configuration.	552
51 FBA A settings	Fieldbus adapter A configuration.	556
52 FBA A data in	Selection of data to be transferred from drive to fieldbus controller through fieldbus adapter A.	557
53 FBA A data out	Selection of data to be transferred from fieldbus controller to drive through fieldbus adapter A.	558
58 Embedded fieldbus	Configuration of the embedded fieldbus (EFB) interface.	558
70 Override	Enabling/disabling of the Override function, Override activation signal and Override speed/frequency.	567
71 External PID1	Configuration of external PID.	572
76 Multipump configuration	PFC (Pump and fan control), multipump and autochange configuration parameters.	575
77 Multipump maintenance and monitoring	PFC (Pump and fan control) and multipump maintenance and monitoring parameters	586
80 Flow calculation	Actual flow calculation.	588
81 Sensor settings	Sensor settings for inlet and outlet pressure protection function.	593
82 Pump protections	Settings for pump protection functions soft pipe fill and dry pump protection (dry run protection).	595
84 Advanced damper control	Settings for the advanced damper control.	598
95 HW configuration	Various hardware-related settings.	604
96 System	Language selection; access levels; macro selection; parameter save and restore; control unit reboot; user parameter sets; unit selection; parameter checksum calculation; user lock.	607
97 Motor control	Switching frequency; slip gain; voltage reserve; flux braking; anti-cogging (signal injection); IR compensation.	618
98 User motor parameters	Motor values supplied by the user that are used in the motor model.	621
99 Motor data	Motor configuration settings.	623

Parameter listing

No.	Name/Value	Description	Def/FbEq16
01 Actual values		Basic signals for monitoring the drive. All parameters in this group are read-only unless otherwise noted. Note: Values of these actual signals are filtered with the filter time defined in group 46 Monitoring/scaling settings . The selection lists for parameters in other groups mean the raw value of the actual signal instead. For example, if a selection is "Output frequency" it does not point to the value of parameter 01.06 Output frequency but to the raw value.	
01.01	Motor speed used	Estimated motor speed. A filter time constant for this signal can be defined by parameter 46.11 Filter time motor speed .	-
	-30000.00... 30000.00 rpm	Estimated motor speed.	See par. 46.01
01.02	Motor speed estimated	Estimated motor speed in rpm. A filter time constant for this signal can be defined by parameter 46.11 Filter time motor speed .	-
	-30000.00... 30000.00 rpm	Estimated motor speed.	See par. 46.01
01.03	Motor speed %	Motor speed in percent of the synchronous motor speed.	-
	-1000.00... 1000.00%	Motor speed.	10 = 1%
01.06	Output frequency	Estimated drive output frequency in Hz. A filter time constant for this signal can be defined by parameter 46.12 Filter time output frequency .	-
	-500.00...500.00 Hz	Estimated output frequency.	See par. 46.02
01.07	Motor current	Measured (absolute) motor current in A.	-
	0.00...30000.00 A	Motor current.	See par. 46.05
01.08	Motor current % of motor nom	Motor current (drive output current) in percent of the nominal motor current.	-
	0.0...1000.0%	Motor current.	1 = 1%
01.09	Motor current % of drive nom	Motor current (drive output current) in percent of the nominal drive current.	-
	0.0...1000.0%	Motor current.	1 = 1%
01.10	Motor torque	Motor torque in percent of the nominal motor torque. See also parameter 01.30 Nominal torque scale . A filter time constant for this signal can be defined by parameter 46.13 Filter time motor torque .	-
	-1600.0...1600.0%	Motor torque.	See par. 46.03
01.11	DC voltage	Measured DC link voltage.	-
	0.00...2000.00 V	DC link voltage.	10 = 1 V
01.13	Output voltage	Calculated motor voltage in V AC.	-
	0...2000 V	Motor voltage.	1 = 1 V

No.	Name/Value	Description	Def/FbEq16
01.14	<i>Output power</i>	Drive output power. The unit is selected by parameter 96.16 Unit selection . A filter time constant for this signal can be defined by parameter 46.14 Filter time power .	-
	-32768.00... 32767.00 kW	Output power.	See par. 46.04
01.15	<i>Output power % of motor nom</i>	Output power in percent of the nominal motor power.	-
	-300.00... 300.00%	Output power.	10 = 1%
01.17	<i>Motor shaft power</i>	Estimated mechanical power at motor shaft.	-
	-32768.00... 32767.00 kW or hp	Motor shaft power.	1 = 1 unit
01.18	<i>Inverter GWh counter</i>	Amount of energy that has passed through the drive (in either direction) in full gigawatt-hours. The minimum value is zero.	-
	0...65535 GWh	Energy in GWh.	1 = 1 GWh
01.19	<i>Inverter MWh counter</i>	Amount of energy that has passed through the drive (in either direction) in full megawatt-hours. Whenever the counter rolls over, 01.18 Inverter GWh counter is incremented. The minimum value is zero.	-
	0...1000 MWh	Energy in MWh.	1 = 1 MWh
01.20	<i>Inverter kWh counter</i>	Amount of energy that has passed through the drive (in either direction) in full kilowatt-hours. Whenever the counter rolls over, 01.19 Inverter MWh counter is incremented. The minimum value is zero.	-
	0...1000 kWh	Energy in kWh.	10 = 1 kWh
01.24	<i>Flux actual %</i>	Used flux reference in percent of nominal flux of motor.	-
	0...200%	Flux reference.	1 = 1%
01.30	<i>Nominal torque scale</i>	Torque that corresponds to 100% of nominal motor torque. The unit is selected by parameter 96.16 Unit selection . Note: This value is copied from parameter 99.12 Motor nominal torque if entered. Otherwise the value is calculated from other motor data.	-
	0.000...4000000 N-m or lb-ft	Nominal torque.	1 = 100 unit
01.50	<i>Current hour kWh</i>	Current hour energy consumption. This is the energy of the last 60 minutes (not necessarily continuous) the drive has been running, not the energy of a calendar hour. If the power is cycled, after the drive is again up and running, the parameter value is set to the value it had before the power cycle.	-
	0.00...1000000.00 kWh	Energy.	-
01.51	<i>Previous hour kWh</i>	Previous hour energy consumption. The value 01.50 Current hour kWh is stored here when its values has been cumulated for 60 minutes. If the power is cycled, after the drive is again up and running, the parameter value is set to the value it had before the power cycle.	-
	0.00...1000000.00 kWh	Energy.	-

No.	Name/Value	Description	Def/FbEq16
01.52	<i>Current day kWh</i>	Current day energy consumption. This is the energy of the last 24 hours (not necessarily continuous) the drive has been running, not the energy of a calendar day. If the power is cycled, after the drive is again up and running, the parameter value is set to the value it had before the power cycle.	-
	0.00... 1000000.00 kWh	Energy.	-
01.53	<i>Previous day kWh</i>	Previous day energy consumption. The value <i>01.52 Current day kWh</i> is stored here when its value has been cumulated for 24 hours. If the power is cycled, after the drive is again up and running, the parameter value is set to the value it had before the power cycle.	-
	0.00... 1000000.00 kWh	Energy.	-
01.54	<i>Cumulative inverter energy</i>	Amount of energy that has passed through the drive (in either direction) in full kilowatt-hours. The minimum value is zero.	-
	-200000000.0... 200000000.0 kWh	Energy in kWh.	10 = 1 kWh
01.55	<i>Inverter GWh counter (resettable)</i>	Amount of energy that has passed through the drive (in either direction) in full gigawatt-hours. The minimum value is zero. You can reset the value by setting it to zero or by pressing the Reset softkey for 3 seconds. Resetting any of parameters <i>01.55...01.58</i> resets all of them.	-
	0...65535 GWh	Energy in GWh.	1 = 1 GWh
01.56	<i>Inverter MWh counter (resettable)</i>	Amount of energy that has passed through the drive (in either direction) in full megawatt-hours. Whenever the counter rolls over, <i>01.55 Inverter GWh counter (resettable)</i> is incremented. The minimum value is zero. You can reset the value by setting it to zero or by pressing the Reset softkey for 3 seconds. Resetting any of parameters <i>01.55...01.58</i> resets all of them.	-
	0...1000 MWh	Energy in MWh.	1 = 1 MWh
01.57	<i>Inverter kWh counter (resettable)</i>	Amount of energy that has passed through the drive (in either direction) in full kilowatt-hours. Whenever the counter rolls over, <i>01.56 Inverter MWh counter (resettable)</i> is incremented. The minimum value is zero. You can reset the value by setting it to zero or by pressing the Reset softkey for 3 seconds. Resetting any of parameters <i>01.55...01.58</i> resets all of them.	-
	0...1000 kWh	Energy in kWh.	10 = 1 kWh
01.58	<i>Cumulative inverter energy (resettable)</i>	Amount of energy that has passed through the drive (in either direction) in full kilowatt-hours. The minimum value is zero. You can reset the value by setting it to zero or by pressing the Reset softkey for 3 seconds. Resetting any of parameters <i>01.55...01.58</i> resets all of them.	-
	-200000000.0... 200000000.0 kWh	Energy in kWh.	10 = 1 kWh
01.61	<i>Abs motor speed used</i>	Absolute value of parameter <i>01.01 Motor speed used</i> .	-
	0.00... 30000.00 rpm	Estimated motor speed.	See par. 46.01

No.	Name/Value	Description	Def/FbEq16
01.62	<i>Abs motor speed %</i>	Absolute value of parameter <i>01.03 Motor speed %</i> .	-
	0.00... 1000.00%	Estimated motor speed.	10 = 1%
01.63	<i>Abs output frequency</i>	Absolute value of parameter <i>01.06 Output frequency</i> .	-
	0.00...500.00 Hz	Estimated output frequency.	See par. 46.02
01.64	<i>Abs motor torque</i>	Absolute value of parameter <i>01.10 Motor torque</i> .	-
	0.0...1600.0%	Motor torque.	See par. 46.03
01.65	<i>Abs output power</i>	Absolute value of parameter <i>01.14 Output power</i> .	-
	0.00... 32767.00 kW	Output power.	1 = 1 kW
01.66	<i>Abs output power % motor nom</i>	Absolute value of parameter <i>01.15 Output power % of motor nom</i> .	-
	0.00... 300.00%	Output power.	10 = 1%
01.68	<i>Abs motor shaft power</i>	Absolute value of parameter <i>01.17 Motor shaft power</i> .	-
	0.00... 32767.00 kW or hp	Motor shaft power.	1 = 1 unit
01.72	<i>U-phase RMS current</i>	U-phase RMS current.	-
	0.00... 30000.00 A	U-phase RMS current.	See 46.05 .
01.73	<i>V-phase RMS current</i>	V-phase RMS current.	-
	0.00... 30000.00 A	V-phase RMS current.	See 46.05 .
01.74	<i>W-phase RMS current</i>	W-phase RMS current.	-
	0.00... 30000.00 A	W-phase RMS current.	See 46.05 .
03 Input references		Values of references received from various sources. All parameters in this group are read-only unless otherwise noted.	
03.01	<i>Panel reference</i>	Reference 1 given from the control panel or PC tool.	-
	-100000.00... 100000.00	Control panel or PC tool reference.	1 = 10
03.02	<i>Panel reference remote</i>	Reference 2 given from the control panel or PC tool.	-
	-100000.00... 100000.00	Control panel or PC tool reference.	1 = 10
03.05	<i>FB A reference 1</i>	Reference 1 received through fieldbus adapter A. See also chapter <i>Fieldbus control through a fieldbus adapter</i> .	-
	-100000.00... 100000.00	Reference 1 from fieldbus adapter A.	1 = 10
03.06	<i>FB A reference 2</i>	Reference 2 received through fieldbus adapter A.	-
	-100000.00... 100000.00	Reference 2 from fieldbus adapter A.	1 = 10

No.	Name/Value	Description	Def/FbEq16
03.09	EFB reference 1	Scaled reference 1 received through the embedded fieldbus interface.	-
	-30000.00... 30000.00	Scaled reference 1 received through the embedded fieldbus interface.	1 = 10
03.10	EFB reference 2	Scaled reference 2 received through the embedded fieldbus interface.	-
	-30000.00... 30000.00	Scaled reference 2 received through the embedded fieldbus interface.	1 = 10

04 Warnings and faults		Information on warnings and faults that occurred last. For explanations of individual warning and fault codes, see chapter Fault tracing . All parameters in this group are read-only unless otherwise noted. Fault and event logs can be cleared with parameter 96.51 Clear fault and event logger .	
04.01	Tripping fault	Code of the 1st active fault (the fault that caused the current trip).	-
	0000h...FFFFh	1st active fault.	1 = 1
04.02	Active fault 2	Code of the 2nd active fault.	-
	0000h...FFFFh	2nd active fault.	1 = 1
04.03	Active fault 3	Code of the 3rd active fault.	-
	0000h...FFFFh	3rd active fault.	1 = 1
04.06	Active warning 1	Code of the 1st active warning.	-
	0000h...FFFFh	1st active warning.	1 = 1
04.07	Active warning 2	Code of the 2nd active warning.	-
	0000h...FFFFh	2nd active warning.	1 = 1
04.08	Active warning 3	Code of the 3rd active warning.	-
	0000h...FFFFh	3rd active warning.	1 = 1
04.11	Latest fault	Code of the 1st stored (non-active) fault.	-
	0000h...FFFFh	1st stored fault.	1 = 1
04.12	2nd latest fault	Code of the 2nd stored (non-active) fault.	-
	0000h...FFFFh	2nd stored fault.	1 = 1
04.13	3rd latest fault	Code of the 3rd stored (non-active) fault.	-
	0000h...FFFFh	3rd stored fault.	1 = 1
04.16	Latest warning	Code of the 1st stored (non-active) warning.	-
	0000h...FFFFh	1st stored warning.	1 = 1
04.17	2nd latest warning	Code of the 2nd stored (non-active) warning.	-
	0000h...FFFFh	2nd stored warning.	1 = 1
04.18	3rd latest warning	Code of the 3rd stored (non-active) warning.	-
	0000h...FFFFh	3rd stored warning.	1 = 1

No.	Name/Value	Description	Def/FbEq16															
04.40	<i>Event word 1</i>	User-defined event word. This word collects the status of the events (warnings or faults) selected by parameters 04.41...04.71 . This parameter is read-only.	-															
<table border="1"> <thead> <tr> <th>Bit</th> <th>Name</th> <th>Description</th> </tr> </thead> <tbody> <tr> <td>0</td> <td>User bit 0</td> <td>1 = Event selected by parameter 04.41 is active</td> </tr> <tr> <td>1</td> <td>User bit 1</td> <td>1 = Event selected by parameter 04.43 is active</td> </tr> <tr> <td>...</td> <td>...</td> <td>...</td> </tr> <tr> <td>15</td> <td>User bit 15</td> <td>1 = Event selected by parameter 04.71 is active</td> </tr> </tbody> </table>				Bit	Name	Description	0	User bit 0	1 = Event selected by parameter 04.41 is active	1	User bit 1	1 = Event selected by parameter 04.43 is active	15	User bit 15	1 = Event selected by parameter 04.71 is active
Bit	Name	Description																
0	User bit 0	1 = Event selected by parameter 04.41 is active																
1	User bit 1	1 = Event selected by parameter 04.43 is active																
...																
15	User bit 15	1 = Event selected by parameter 04.71 is active																
	0000h...FFFFh	User-defined event word.	1 = 1															
04.41	<i>Event word 1 bit 0 code</i>	Selects the hexadecimal code of an event (warning, fault or pure event) whose status is shown as bit 0 of 04.40 Event word 1 . The event codes are listed in chapter Fault tracing (page 237).	2310h															
	0000h...FFFFh	Default fault 2310 Overcurrent.	1 = 1															
04.43	<i>Event word 1 bit 1 code</i>	Selects the hexadecimal code of an event (warning, fault or pure event) whose status is shown as bit 1 of 04.40 Event word 1 . The events are listed in chapter Fault tracing (page 237).	3210h															
	0000h...FFFFh	Default fault 3210 DC link overvoltage.	1 = 1															
04.45	Event word 1 bit 2 code	Default fault 4310 Excess temperature.	4310h															
04.47	Event word 1 bit 3 code	Default fault 2340 Short circuit.	2340h															
04.49	Event word 1 bit 4 code	No default fault	0000h															
04.51	Event word 1 bit 5 code	Default fault 3220 DC link undervoltage.	3220h															
04.53	Event word 1 bit 6 code	Default fault 80A0 AI supervision.	80A0h															
04.55	Event word 1 bit 7 code	No default fault.	0000h															
04.57	Event word 1 bit 8 code	Default fault 7122 Motor overload.	7122h															
04.59	Event word 1 bit 9 code	Default fault 7081 Control panel loss.	7081h															
04.61	Event word 1 bit 10 code	Default fault FF61 ID run.	FF61h															
04.63	Event word 1 bit 11 code	Default fault 7121 Motor stall.	7121h															
04.65	Event word 1 bit 12 code	Default fault 4110 Control board temperature.	4110h															
04.67	Event word 1 bit 13 code	Default fault 9081 External fault 1.	9081h															
04.69	Event word 1 bit 14 code	Default fault 9082 External fault 2.	9082h															

No.	Name/Value	Description	Def/FbEq16
04.71	<i>Event word 1 bit 15 code</i>	Selects the hexadecimal code of an event (warning, fault or pure event) whose status is shown as bit 15 of <i>04.40 Event word 1</i> . The events are listed in chapter <i>Fault tracing</i> (page 237). Default fault 2330 Earth leakage.	2330h
	0000h...FFFFh	Code of event.	1 = 1
05 Diagnostics		Various run-time-type counters and measurements related to drive maintenance. All parameters in this group are read-only unless otherwise noted.	
05.01	<i>On-time counter</i>	On-time counter. The counter runs when the drive is powered.	-
	0...65535 days	On-time counter.	1 = 1 day
05.02	<i>Run-time counter</i>	Motor run-time counter in full days. The counter runs when the inverter modulates.	-
	0...65535 days	Motor run-time counter.	1 = 1 day
05.03	<i>Hours run</i>	Corresponding parameter to <i>05.02 Run-time counter</i> in hours, that is, 24 * <i>05.02</i> value + fractional part of a day.	-
	0.0... 429496729.5 h	Hours.	1 = 1 h
05.04	<i>Fan on-time counter</i>	Running time of the drive cooling fan. Can be reset from the control panel by pressing the Reset softkey for 3 seconds.	-
	0...65535 days	Cooling fan run-time counter.	1 = 1 day
05.10	<i>Control board temperature</i>	Measured temperature of the control board.	-
	-100... 300 °C or °F	Control board temperature in degrees Celsius or Fahrenheit.	1 = 1 unit
05.11	<i>Inverter temperature</i>	Estimated drive temperature in percent of fault limit. The fault limit varies according to the type of the drive. 0.0% = 0 °C (32 °F) 100.0% = Fault limit	-
	-40.0...160.0%	Drive temperature in percent.	1 = 1%

No.	Name/Value	Description	Def/FbEq16																																				
05.20	<i>Diagnostic word 1</i>	Diagnostic word 1. For possible causes and remedies, see chapter <i>Fault tracing</i> .	-																																				
<table border="1"> <thead> <tr> <th>Bit</th> <th>Name</th> <th>Value</th> </tr> </thead> <tbody> <tr> <td>0</td> <td>Any warning or fault</td> <td>1 = Yes = Drive has generated a warning or tripped on a fault. 0 = None active = No warning or fault active.</td> </tr> <tr> <td>1</td> <td>Any warning</td> <td>1 = Yes = Drive has generated a warning. 0 = None active = No warning active.</td> </tr> <tr> <td>2</td> <td>Any fault</td> <td>1 = Yes = Drive has tripped on a fault. 0 = None active = No fault active.</td> </tr> <tr> <td>3</td> <td>Reserved</td> <td></td> </tr> <tr> <td>4</td> <td>Overcurrent flt</td> <td>Yes = Drive has tripped on fault <i>2310 Overcurrent</i>.</td> </tr> <tr> <td>5</td> <td>Reserved</td> <td></td> </tr> <tr> <td>6</td> <td>DC overvoltage</td> <td>Yes = Drive has tripped on fault <i>3210 DC link overvoltage</i>.</td> </tr> <tr> <td>7</td> <td>DC undervoltage</td> <td>Yes = Drive has tripped on fault <i>3220 DC link undervoltage</i>.</td> </tr> <tr> <td>8</td> <td>Reserved</td> <td></td> </tr> <tr> <td>9</td> <td>Device overtemp flt</td> <td>Yes = Drive has tripped on fault <i>4310 Excess temperature</i>.</td> </tr> <tr> <td>10...15</td> <td>Reserved</td> <td></td> </tr> </tbody> </table>				Bit	Name	Value	0	Any warning or fault	1 = Yes = Drive has generated a warning or tripped on a fault. 0 = None active = No warning or fault active.	1	Any warning	1 = Yes = Drive has generated a warning. 0 = None active = No warning active.	2	Any fault	1 = Yes = Drive has tripped on a fault. 0 = None active = No fault active.	3	Reserved		4	Overcurrent flt	Yes = Drive has tripped on fault <i>2310 Overcurrent</i> .	5	Reserved		6	DC overvoltage	Yes = Drive has tripped on fault <i>3210 DC link overvoltage</i> .	7	DC undervoltage	Yes = Drive has tripped on fault <i>3220 DC link undervoltage</i> .	8	Reserved		9	Device overtemp flt	Yes = Drive has tripped on fault <i>4310 Excess temperature</i> .	10...15	Reserved	
Bit	Name	Value																																					
0	Any warning or fault	1 = Yes = Drive has generated a warning or tripped on a fault. 0 = None active = No warning or fault active.																																					
1	Any warning	1 = Yes = Drive has generated a warning. 0 = None active = No warning active.																																					
2	Any fault	1 = Yes = Drive has tripped on a fault. 0 = None active = No fault active.																																					
3	Reserved																																						
4	Overcurrent flt	Yes = Drive has tripped on fault <i>2310 Overcurrent</i> .																																					
5	Reserved																																						
6	DC overvoltage	Yes = Drive has tripped on fault <i>3210 DC link overvoltage</i> .																																					
7	DC undervoltage	Yes = Drive has tripped on fault <i>3220 DC link undervoltage</i> .																																					
8	Reserved																																						
9	Device overtemp flt	Yes = Drive has tripped on fault <i>4310 Excess temperature</i> .																																					
10...15	Reserved																																						
	0000h...FFFFh	Diagnostic word 1.	1 = 1																																				
05.21	<i>Diagnostic word 2</i>	Diagnostic word 2. For possible causes and remedies, see chapter <i>Fault tracing</i> .	-																																				
<table border="1"> <thead> <tr> <th>Bit</th> <th>Name</th> <th>Value</th> </tr> </thead> <tbody> <tr> <td>0...9</td> <td>Reserved</td> <td></td> </tr> <tr> <td>10</td> <td>Motor overtemp flt</td> <td>Yes = Drive has tripped on fault <i>4981 External temperature 1</i> or <i>4982 External temperature 2</i>.</td> </tr> <tr> <td>11...15</td> <td>Reserved</td> <td></td> </tr> </tbody> </table>				Bit	Name	Value	0...9	Reserved		10	Motor overtemp flt	Yes = Drive has tripped on fault <i>4981 External temperature 1</i> or <i>4982 External temperature 2</i> .	11...15	Reserved																									
Bit	Name	Value																																					
0...9	Reserved																																						
10	Motor overtemp flt	Yes = Drive has tripped on fault <i>4981 External temperature 1</i> or <i>4982 External temperature 2</i> .																																					
11...15	Reserved																																						
	0000h...FFFFh	Diagnostic word 2.	1 = 1																																				
05.22	<i>Diagnostic word 3</i>	Diagnostic word 3..	-																																				
<table border="1"> <thead> <tr> <th>Bit</th> <th>Name</th> <th>Value</th> </tr> </thead> <tbody> <tr> <td>0...8</td> <td>Reserved</td> <td></td> </tr> <tr> <td>9</td> <td>kWh pulse</td> <td>Yes = kWh pulse is active.</td> </tr> <tr> <td>10</td> <td>Reserved</td> <td></td> </tr> <tr> <td>11</td> <td>Fan command</td> <td>On = Drive fan is rotating above idle speed.</td> </tr> <tr> <td>12...15</td> <td>Reserved</td> <td></td> </tr> </tbody> </table>				Bit	Name	Value	0...8	Reserved		9	kWh pulse	Yes = kWh pulse is active.	10	Reserved		11	Fan command	On = Drive fan is rotating above idle speed.	12...15	Reserved																			
Bit	Name	Value																																					
0...8	Reserved																																						
9	kWh pulse	Yes = kWh pulse is active.																																					
10	Reserved																																						
11	Fan command	On = Drive fan is rotating above idle speed.																																					
12...15	Reserved																																						
	0000h...FFFFh	Diagnostic word 3.	1 = 1																																				
05.80	<i>Motor speed at fault</i>	Copy of parameter <i>24.02 Used speed feedback</i> (in both scalar and speed control modes) at the occurrence of the latest fault.	-																																				
	-30000.00... 30000.00 rpm	Estimated motor speed.	1 = 1 rpm																																				

No.	Name/Value	Description	Def/FbEq16												
05.81	<i>Output frequency at fault</i>	Copy of parameter <i>01.06 Output frequency</i> at the occurrence of the latest fault.	-												
	-500.00...500.00 Hz	Estimated output frequency.	1 = 1 Hz												
05.82	<i>DC voltage at fault</i>	Copy of parameter <i>01.11 DC voltage</i> at the occurrence of the latest fault.	-												
	0.00...2000.00 V	DC link voltage.	10 = 1 V												
05.83	<i>Motor current at fault</i>	Copy of parameter <i>01.07 Motor current</i> at the occurrence of the latest fault.	-												
	0.00...30000.00 A	Motor current.	1 = 1 A												
05.84	<i>Motor torque at fault</i>	Copy of parameter <i>01.10 Motor torque</i> at the occurrence of the latest fault.	-												
	-1600.0...1600.0%	Motor torque.	1 = 1 %												
05.85	<i>Main status word at fault</i>	Copy of parameter <i>06.11 Main status word</i> at the occurrence of the latest fault.	-												
	0000h...FFFFh	Main status word.	1 = 1												
05.86	<i>DI delayed status at fault</i>	Copy of parameter <i>10.02 DI delayed status</i> at the occurrence of the latest fault.	-												
	0000h...FFFFh	Delayed status for digital inputs.	1 = 1												
05.87	<i>Inverter temperature at fault</i>	Copy of parameter <i>05.11 Inverter temperature</i> at the occurrence of the latest fault.	-												
	-40...160 units	Drive temperature in °C or °F.	1 = 1 unit												
05.88	<i>Reference used at fault</i>	Copy of parameter <i>28.01 Frequency ref ramp input</i> (in scalar control mode) or <i>23.01 Speed ref ramp input</i> (in speed control mode) at the occurrence of the latest fault.	-												
	-500.00... 500.00 Hz or -30000.00... 30000.00 rpm	Frequency or speed reference.	1 = 1 unit												
05.89	<i>HVAC status word at fault</i>	Copy of parameter <i>06.22 HVAC status word</i> at the occurrence of the latest fault.	-												
	0000h...FFFFh	ACH480 specific status word.	1 = 1												
05.99	<i>BIO-01 DIP switch status</i>	Shows the states of BIO-01 module DIP switches S1 and S2. Note: This parameter is applicable only when the BIO-01 module is attached. Note: Both DIP switches cannot be connected simultaneously to DO1. The forbidden bit combination S1-0 and S2 - 1 causes a fault <i>7087 I/O module configuration fault</i> .	-												
<table border="1" style="width: 100%;"> <thead> <tr> <th>Bit</th> <th>Name</th> <th>Value</th> </tr> </thead> <tbody> <tr> <td>0</td> <td>S1</td> <td>0 - OFF - DO1 on port S1 1 - ON - AO1 on port S1</td> </tr> <tr> <td>1</td> <td>S2</td> <td>0 - OFF - DI3 on port S2 1 - ON - DO1 on port S2</td> </tr> <tr> <td>2...15</td> <td>Reserved</td> <td></td> </tr> </tbody> </table>				Bit	Name	Value	0	S1	0 - OFF - DO1 on port S1 1 - ON - AO1 on port S1	1	S2	0 - OFF - DI3 on port S2 1 - ON - DO1 on port S2	2...15	Reserved	
Bit	Name	Value													
0	S1	0 - OFF - DO1 on port S1 1 - ON - AO1 on port S1													
1	S2	0 - OFF - DI3 on port S2 1 - ON - DO1 on port S2													
2...15	Reserved														
	0000h...FFFFh	The states of BIO-01 module DIP switches S1 and S2	1 = 1												

No.	Name/Value	Description	Def/FbEq16																																		
06 Control and status words		Drive control and status words.																																			
06.01	<i>Main control word</i>	<p>The main control word of the drive. This parameter shows the control signals as received from the selected sources (such as digital inputs, the fieldbus interfaces and the application program).</p> <p>For the control word bit descriptions see page 353. The related status word and state diagram are presented on pages 354 and 355 respectively.</p> <p>This parameter is read-only.</p> <p>Note: When using fieldbus control, this parameter value is not the same as the Control word value that the drive receives from the PLC. For the exact value, see 50.12 FBA A debug mode.</p> <table border="1" data-bbox="339 549 850 1005"> <thead> <tr> <th>Bit</th> <th>Name</th> </tr> </thead> <tbody> <tr><td>0</td><td><i>Off1 control</i></td></tr> <tr><td>1</td><td><i>Off2 control</i></td></tr> <tr><td>2</td><td><i>Off3 control</i></td></tr> <tr><td>3</td><td><i>Run</i></td></tr> <tr><td>4</td><td><i>Ramp out zero</i></td></tr> <tr><td>5</td><td><i>Ramp hold</i></td></tr> <tr><td>6</td><td><i>Ramp in zero</i></td></tr> <tr><td>7</td><td><i>Reset</i></td></tr> <tr><td>8</td><td>Reserved</td></tr> <tr><td>9</td><td>Reserved</td></tr> <tr><td>10</td><td><i>Remote cmd</i></td></tr> <tr><td>11</td><td><i>Ext ctrl loc</i></td></tr> <tr><td>12</td><td><i>User bit 0</i></td></tr> <tr><td>13</td><td><i>User bit 1</i></td></tr> <tr><td>14</td><td><i>User bit 2</i></td></tr> <tr><td>15</td><td><i>User bit 3</i></td></tr> </tbody> </table>	Bit	Name	0	<i>Off1 control</i>	1	<i>Off2 control</i>	2	<i>Off3 control</i>	3	<i>Run</i>	4	<i>Ramp out zero</i>	5	<i>Ramp hold</i>	6	<i>Ramp in zero</i>	7	<i>Reset</i>	8	Reserved	9	Reserved	10	<i>Remote cmd</i>	11	<i>Ext ctrl loc</i>	12	<i>User bit 0</i>	13	<i>User bit 1</i>	14	<i>User bit 2</i>	15	<i>User bit 3</i>	-
Bit	Name																																				
0	<i>Off1 control</i>																																				
1	<i>Off2 control</i>																																				
2	<i>Off3 control</i>																																				
3	<i>Run</i>																																				
4	<i>Ramp out zero</i>																																				
5	<i>Ramp hold</i>																																				
6	<i>Ramp in zero</i>																																				
7	<i>Reset</i>																																				
8	Reserved																																				
9	Reserved																																				
10	<i>Remote cmd</i>																																				
11	<i>Ext ctrl loc</i>																																				
12	<i>User bit 0</i>																																				
13	<i>User bit 1</i>																																				
14	<i>User bit 2</i>																																				
15	<i>User bit 3</i>																																				
0000h...FFFFh		Main control word.	1 = 1																																		

No.	Name/Value	Description	Def/FbEq16																																		
06.11	<i>Main status word</i>	<p>Main status word of the drive.</p> <p>For the status word bit descriptions see page 354. The related control word and state diagram are presented on pages 353 and 355 respectively.</p> <p>This parameter is read-only.</p> <p>Note: When using fieldbus control, this parameter value is not the same as the Status word value that the drive sends to the PLC. For the exact value, see 50.12 <i>FBA A debug mode</i>.</p> <table border="1" data-bbox="393 387 901 951"> <thead> <tr> <th data-bbox="393 387 468 411">Bit</th> <th data-bbox="468 387 901 411">Name</th> </tr> </thead> <tbody> <tr><td data-bbox="393 411 468 435">0</td><td data-bbox="468 411 901 435"><i>Ready to switch ON</i></td></tr> <tr><td data-bbox="393 435 468 459">1</td><td data-bbox="468 435 901 459"><i>Ready run</i></td></tr> <tr><td data-bbox="393 459 468 483">2</td><td data-bbox="468 459 901 483"><i>Ready ref</i></td></tr> <tr><td data-bbox="393 483 468 507">3</td><td data-bbox="468 483 901 507"><i>Tripped</i></td></tr> <tr><td data-bbox="393 507 468 531">4</td><td data-bbox="468 507 901 531"><i>Off 2 inactive</i></td></tr> <tr><td data-bbox="393 531 468 555">5</td><td data-bbox="468 531 901 555"><i>Off 3 inactive</i></td></tr> <tr><td data-bbox="393 555 468 579">6</td><td data-bbox="468 555 901 579"><i>Switch-on inhibited</i></td></tr> <tr><td data-bbox="393 579 468 603">7</td><td data-bbox="468 579 901 603"><i>Warning</i></td></tr> <tr><td data-bbox="393 603 468 627">8</td><td data-bbox="468 603 901 627"><i>At setpoint</i></td></tr> <tr><td data-bbox="393 627 468 651">9</td><td data-bbox="468 627 901 651"><i>Remote</i></td></tr> <tr><td data-bbox="393 651 468 675">10</td><td data-bbox="468 651 901 675"><i>Above limit</i> as default, see parameter 06.29 MSW bit 10 selection.</td></tr> <tr><td data-bbox="393 675 468 699">11</td><td data-bbox="468 675 901 699"><i>User bit 0</i>, see parameter 06.30 MSW bit 11 selection.</td></tr> <tr><td data-bbox="393 699 468 722">12</td><td data-bbox="468 699 901 722"><i>User bit 1</i>, see parameter 06.31 MSW bit 12 selection.</td></tr> <tr><td data-bbox="393 722 468 746">13</td><td data-bbox="468 722 901 746"><i>User bit 2</i>, see parameter 06.32 MSW bit 13 selection.</td></tr> <tr><td data-bbox="393 746 468 770">14</td><td data-bbox="468 746 901 770"><i>User bit 3</i>, see parameter 06.33 MSW bit 14 selection.</td></tr> <tr><td data-bbox="393 770 468 794">15</td><td data-bbox="468 770 901 794"><i>Reserved</i></td></tr> </tbody> </table>	Bit	Name	0	<i>Ready to switch ON</i>	1	<i>Ready run</i>	2	<i>Ready ref</i>	3	<i>Tripped</i>	4	<i>Off 2 inactive</i>	5	<i>Off 3 inactive</i>	6	<i>Switch-on inhibited</i>	7	<i>Warning</i>	8	<i>At setpoint</i>	9	<i>Remote</i>	10	<i>Above limit</i> as default, see parameter 06.29 MSW bit 10 selection.	11	<i>User bit 0</i> , see parameter 06.30 MSW bit 11 selection.	12	<i>User bit 1</i> , see parameter 06.31 MSW bit 12 selection.	13	<i>User bit 2</i> , see parameter 06.32 MSW bit 13 selection.	14	<i>User bit 3</i> , see parameter 06.33 MSW bit 14 selection.	15	<i>Reserved</i>	-
Bit	Name																																				
0	<i>Ready to switch ON</i>																																				
1	<i>Ready run</i>																																				
2	<i>Ready ref</i>																																				
3	<i>Tripped</i>																																				
4	<i>Off 2 inactive</i>																																				
5	<i>Off 3 inactive</i>																																				
6	<i>Switch-on inhibited</i>																																				
7	<i>Warning</i>																																				
8	<i>At setpoint</i>																																				
9	<i>Remote</i>																																				
10	<i>Above limit</i> as default, see parameter 06.29 MSW bit 10 selection.																																				
11	<i>User bit 0</i> , see parameter 06.30 MSW bit 11 selection.																																				
12	<i>User bit 1</i> , see parameter 06.31 MSW bit 12 selection.																																				
13	<i>User bit 2</i> , see parameter 06.32 MSW bit 13 selection.																																				
14	<i>User bit 3</i> , see parameter 06.33 MSW bit 14 selection.																																				
15	<i>Reserved</i>																																				
	0000h...FFFFh	Main status word.	1 = 1																																		

No.	Name/Value	Description	Def/FbEq16																																																			
06.16	Drive status word 1	Drive status word 1. This parameter is read-only.	-																																																			
<table border="1"> <thead> <tr> <th>Bit</th> <th>Name</th> <th>Description</th> </tr> </thead> <tbody> <tr> <td>0</td> <td>Enabled</td> <td>1 = If start interlock signals (par. 20.41...20.44) are all present. Note: This bit is not affected by the presence of a fault.</td> </tr> <tr> <td>1</td> <td>Inhibited</td> <td>1 = Start inhibited. To start the drive, the inhibiting signal (see par. 06.18) must be removed and the start signal cycled.</td> </tr> <tr> <td>2</td> <td>DC charged</td> <td>1 = DC circuit has been charged</td> </tr> <tr> <td>3</td> <td>Ready to start</td> <td>1 = Drive is ready to receive a start command</td> </tr> <tr> <td>4</td> <td>Following reference</td> <td>1 = Drive is ready to follow given reference</td> </tr> <tr> <td>5</td> <td>Started</td> <td>1 = Drive has been started</td> </tr> <tr> <td>6</td> <td>Modulating</td> <td>1 = Drive is modulating (output stage is being controlled)</td> </tr> <tr> <td>7</td> <td>Limiting</td> <td>1 = Any operating limit (speed, torque, etc.) is active</td> </tr> <tr> <td>8</td> <td>Local control</td> <td>1 = Drive is in local control</td> </tr> <tr> <td>9</td> <td>Network control</td> <td>1 = Drive is in <i>network control</i> (see page 25).</td> </tr> <tr> <td>10</td> <td>Ext1 active</td> <td>1 = Control location EXT1 active</td> </tr> <tr> <td>11</td> <td>Ext2 active</td> <td>1 = Control location EXT2 active</td> </tr> <tr> <td>12</td> <td>Reserved</td> <td></td> </tr> <tr> <td>13</td> <td>Start request</td> <td>1 = If Start requested. 0 = When Run permissive signal (see par. 20.40) is 0.</td> </tr> <tr> <td>14</td> <td>Running</td> <td>1 = Drive is controlling speed or frequency, in PID sleep or pre-magnetization.</td> </tr> <tr> <td>15</td> <td>Reserved</td> <td></td> </tr> </tbody> </table>				Bit	Name	Description	0	Enabled	1 = If start interlock signals (par. 20.41...20.44) are all present. Note: This bit is not affected by the presence of a fault.	1	Inhibited	1 = Start inhibited. To start the drive, the inhibiting signal (see par. 06.18) must be removed and the start signal cycled.	2	DC charged	1 = DC circuit has been charged	3	Ready to start	1 = Drive is ready to receive a start command	4	Following reference	1 = Drive is ready to follow given reference	5	Started	1 = Drive has been started	6	Modulating	1 = Drive is modulating (output stage is being controlled)	7	Limiting	1 = Any operating limit (speed, torque, etc.) is active	8	Local control	1 = Drive is in local control	9	Network control	1 = Drive is in <i>network control</i> (see page 25).	10	Ext1 active	1 = Control location EXT1 active	11	Ext2 active	1 = Control location EXT2 active	12	Reserved		13	Start request	1 = If Start requested. 0 = When Run permissive signal (see par. 20.40) is 0.	14	Running	1 = Drive is controlling speed or frequency, in PID sleep or pre-magnetization.	15	Reserved	
Bit	Name	Description																																																				
0	Enabled	1 = If start interlock signals (par. 20.41...20.44) are all present. Note: This bit is not affected by the presence of a fault.																																																				
1	Inhibited	1 = Start inhibited. To start the drive, the inhibiting signal (see par. 06.18) must be removed and the start signal cycled.																																																				
2	DC charged	1 = DC circuit has been charged																																																				
3	Ready to start	1 = Drive is ready to receive a start command																																																				
4	Following reference	1 = Drive is ready to follow given reference																																																				
5	Started	1 = Drive has been started																																																				
6	Modulating	1 = Drive is modulating (output stage is being controlled)																																																				
7	Limiting	1 = Any operating limit (speed, torque, etc.) is active																																																				
8	Local control	1 = Drive is in local control																																																				
9	Network control	1 = Drive is in <i>network control</i> (see page 25).																																																				
10	Ext1 active	1 = Control location EXT1 active																																																				
11	Ext2 active	1 = Control location EXT2 active																																																				
12	Reserved																																																					
13	Start request	1 = If Start requested. 0 = When Run permissive signal (see par. 20.40) is 0.																																																				
14	Running	1 = Drive is controlling speed or frequency, in PID sleep or pre-magnetization.																																																				
15	Reserved																																																					
0000h...FFFFh		Drive status word 1.	1 = 1																																																			

No.	Name/Value	Description	Def/FbEq16																																													
06.17	Drive status word 2	Drive status word 2. This parameter is read-only.	-																																													
<table border="1"> <thead> <tr> <th>Bit</th> <th>Name</th> <th>Description</th> </tr> </thead> <tbody> <tr> <td>0</td> <td>Identification run done</td> <td>1 = Motor identification (ID) run has been performed</td> </tr> <tr> <td>1</td> <td>Magnetized</td> <td>1 = The motor has been magnetized</td> </tr> <tr> <td>2</td> <td>Reserved</td> <td></td> </tr> <tr> <td>3</td> <td>Speed control</td> <td>1 = Speed control mode active</td> </tr> <tr> <td>4</td> <td>Reserved</td> <td></td> </tr> <tr> <td>5</td> <td>Safe reference active</td> <td>1 = A "safe" reference is applied by functions such as parameters 49.05 and 50.02</td> </tr> <tr> <td>6</td> <td>Last speed active</td> <td>1 = A "last speed" reference is applied by functions such as parameters 49.05 and 50.02</td> </tr> <tr> <td>7</td> <td>Reserved</td> <td></td> </tr> <tr> <td>8</td> <td>Emergency stop failed</td> <td>1 = Emergency stop failed (see parameters 31.32 and 31.33)</td> </tr> <tr> <td>9</td> <td>Reserved</td> <td></td> </tr> <tr> <td>10</td> <td>Above limit</td> <td>1 = Actual speed or frequency equals or exceeds limit (defined by parameters 46.31...46.32). Valid in both directions of rotation.</td> </tr> <tr> <td>11...12</td> <td>Reserved</td> <td></td> </tr> <tr> <td>13</td> <td>Start delay active</td> <td>1 = Start delay (par. 21.22) active</td> </tr> <tr> <td>14...15</td> <td>Reserved</td> <td></td> </tr> </tbody> </table>				Bit	Name	Description	0	Identification run done	1 = Motor identification (ID) run has been performed	1	Magnetized	1 = The motor has been magnetized	2	Reserved		3	Speed control	1 = Speed control mode active	4	Reserved		5	Safe reference active	1 = A "safe" reference is applied by functions such as parameters 49.05 and 50.02	6	Last speed active	1 = A "last speed" reference is applied by functions such as parameters 49.05 and 50.02	7	Reserved		8	Emergency stop failed	1 = Emergency stop failed (see parameters 31.32 and 31.33)	9	Reserved		10	Above limit	1 = Actual speed or frequency equals or exceeds limit (defined by parameters 46.31 ... 46.32). Valid in both directions of rotation.	11...12	Reserved		13	Start delay active	1 = Start delay (par. 21.22) active	14...15	Reserved	
Bit	Name	Description																																														
0	Identification run done	1 = Motor identification (ID) run has been performed																																														
1	Magnetized	1 = The motor has been magnetized																																														
2	Reserved																																															
3	Speed control	1 = Speed control mode active																																														
4	Reserved																																															
5	Safe reference active	1 = A "safe" reference is applied by functions such as parameters 49.05 and 50.02																																														
6	Last speed active	1 = A "last speed" reference is applied by functions such as parameters 49.05 and 50.02																																														
7	Reserved																																															
8	Emergency stop failed	1 = Emergency stop failed (see parameters 31.32 and 31.33)																																														
9	Reserved																																															
10	Above limit	1 = Actual speed or frequency equals or exceeds limit (defined by parameters 46.31 ... 46.32). Valid in both directions of rotation.																																														
11...12	Reserved																																															
13	Start delay active	1 = Start delay (par. 21.22) active																																														
14...15	Reserved																																															
0000h...FFFFh		Drive status word 2.	1 = 1																																													

No.	Name/Value	Description	Def/FbEq16
06.18	<i>Start inhibit status word</i>	Start inhibit status word. This word specifies the source of the inhibiting signal that is preventing the drive from starting. The conditions marked with an asterisk (*) only require that the start command is cycled. In all other instances, the inhibiting condition must be removed first. See also parameter <i>06.16 Drive status word 1</i> , bit 1. This parameter is read-only.	-

Bit	Name	Description
0	Not ready run	1 = DC voltage is missing or drive has not been parametrized correctly. Check the parameters in groups 95 and 99.
1	Ctrl location changed	* 1 = Control location has changed
2	SSW inhibit	1 = Control program is keeping itself in inhibited state
3	Fault reset	* 1 = A fault has been reset
4	Start interlocked	1 = Start interlocked
5	Run permissive	1 = Run permissive signal missing
6	Reserved	
7	STO	1 = Safe torque off function active
8	Current calibration ended	* 1 = Current calibration routine has finished
9	ID run ended	* 1 = Motor identification run has finished
10	Reserved	
11	Em Off1	1 = Emergency stop signal (mode off1)
12	Em Off2	1 = Emergency stop signal (mode off2)
13	Em Off3	1 = Emergency stop signal (mode off3)
14	Auto reset inhibit	1 = The autoreset function is inhibiting operation
15	Reserved	

0000h...FFFFh	Start inhibit status word.	1 = 1
---------------	----------------------------	-------

06.19	<i>Speed control status word</i>	Speed control status word. This parameter is read-only.	-
-------	----------------------------------	---	---

Bit	Name	Description
0	Zero speed	1 = Drive has been running below zero speed limit (par. 21.06) for a time defined by parameter 21.07 Zero speed delay
1	Forward	1 = Drive is running in forward direction above zero speed limit (par. 21.06)
2	Reverse	1 = Drive is running in reverse direction above zero speed limit (par. 21.06)
3...6	Reserved	
7	Any constant speed request	1 = A constant speed or frequency has been selected; see par. 06.20
8...15	Reserved	

0000h...FFFFh	Speed control status word.	1 = 1
---------------	----------------------------	-------

No.	Name/Value	Description	Def/FbEq16																											
06.20	<i>Constant speed status word</i>	Constant speed/frequency status word. Indicates which constant speed or frequency is active (if any). See also parameter 06.19 Speed control status word , bit 7, and section Constant speeds/frequencies (page 230). This parameter is read-only.	-																											
<table border="1"> <thead> <tr> <th>Bit</th> <th>Name</th> <th>Description</th> </tr> </thead> <tbody> <tr> <td>0</td> <td>Constant speed 1</td> <td>1 = Constant speed or frequency 1 selected</td> </tr> <tr> <td>1</td> <td>Constant speed 2</td> <td>1 = Constant speed or frequency 2 selected</td> </tr> <tr> <td>2</td> <td>Constant speed 3</td> <td>1 = Constant speed or frequency 3 selected</td> </tr> <tr> <td>3</td> <td>Constant speed 4</td> <td>1 = Constant speed or frequency 4 selected</td> </tr> <tr> <td>4</td> <td>Constant speed 5</td> <td>1 = Constant speed or frequency 5 selected</td> </tr> <tr> <td>5</td> <td>Constant speed 6</td> <td>1 = Constant speed or frequency 6 selected</td> </tr> <tr> <td>6</td> <td>Constant speed 7</td> <td>1 = Constant speed or frequency 7 selected</td> </tr> <tr> <td>7...15</td> <td>Reserved</td> <td></td> </tr> </tbody> </table>				Bit	Name	Description	0	Constant speed 1	1 = Constant speed or frequency 1 selected	1	Constant speed 2	1 = Constant speed or frequency 2 selected	2	Constant speed 3	1 = Constant speed or frequency 3 selected	3	Constant speed 4	1 = Constant speed or frequency 4 selected	4	Constant speed 5	1 = Constant speed or frequency 5 selected	5	Constant speed 6	1 = Constant speed or frequency 6 selected	6	Constant speed 7	1 = Constant speed or frequency 7 selected	7...15	Reserved	
Bit	Name	Description																												
0	Constant speed 1	1 = Constant speed or frequency 1 selected																												
1	Constant speed 2	1 = Constant speed or frequency 2 selected																												
2	Constant speed 3	1 = Constant speed or frequency 3 selected																												
3	Constant speed 4	1 = Constant speed or frequency 4 selected																												
4	Constant speed 5	1 = Constant speed or frequency 5 selected																												
5	Constant speed 6	1 = Constant speed or frequency 6 selected																												
6	Constant speed 7	1 = Constant speed or frequency 7 selected																												
7...15	Reserved																													
	0000h...FFFFh	Constant speed/frequency status word.	1 = 1																											
06.21	<i>Drive status word 3</i>	Drive status word 3. This parameter is read-only.	-																											
<table border="1"> <thead> <tr> <th>Bit</th> <th>Name</th> <th>Description</th> </tr> </thead> <tbody> <tr> <td>0</td> <td>DC hold active</td> <td>1 = DC hold is active</td> </tr> <tr> <td>1</td> <td>Post-magnetizing active</td> <td>1 = Post-magnetizing is active</td> </tr> <tr> <td>2</td> <td>Motor pre-heating active</td> <td>1 = Motor pre-heating is active</td> </tr> <tr> <td>3</td> <td>PM smooth start active</td> <td>1 = PM smooth start active</td> </tr> <tr> <td>4...15</td> <td>Reserved</td> <td></td> </tr> </tbody> </table>				Bit	Name	Description	0	DC hold active	1 = DC hold is active	1	Post-magnetizing active	1 = Post-magnetizing is active	2	Motor pre-heating active	1 = Motor pre-heating is active	3	PM smooth start active	1 = PM smooth start active	4...15	Reserved										
Bit	Name	Description																												
0	DC hold active	1 = DC hold is active																												
1	Post-magnetizing active	1 = Post-magnetizing is active																												
2	Motor pre-heating active	1 = Motor pre-heating is active																												
3	PM smooth start active	1 = PM smooth start active																												
4...15	Reserved																													
	0000h...FFFFh	Drive status word 1.	1 = 1																											

No.	Name/Value	Description	Def/FbEq16																																										
06.22	<i>HVAC status word</i>	HVAC specific status word. This parameter is read-only.	-																																										
		<table border="1"> <thead> <tr> <th>Bit</th> <th>Name</th> <th>Description</th> </tr> </thead> <tbody> <tr> <td>0</td> <td>Hand mode</td> <td>0 = Drive is not operated from the control panel in the Hand mode; 1 = Drive is operated from the control panel in the Hand mode.</td> </tr> <tr> <td>1</td> <td>Off mode</td> <td>0 = Drive is not in the Off mode; 1 = Drive is in the Off mode.</td> </tr> <tr> <td>2</td> <td>Auto mode</td> <td>0 = Drive is not in the Auto mode; 1 = Drive is in the Auto mode.</td> </tr> <tr> <td>4</td> <td>Pre-heating</td> <td>0 = Motor pre-heating is not active; 1 = Motor pre-heating is active.</td> </tr> <tr> <td>5</td> <td>Damper control</td> <td>0 = Damper control is not active; 1 = Damper control is active.</td> </tr> <tr> <td>6</td> <td>Reserved</td> <td></td> </tr> <tr> <td>7</td> <td>Run permissive</td> <td>0 = Run permissive is not present, drive is not allowed to run; 1 = Run permissive is present, drive is allowed to run.</td> </tr> <tr> <td>8</td> <td>Start interlock 1</td> <td>0 = Start interlock 1 is not present, drive is not allowed to start; 1 = Start interlock 1 is present, drive is allowed to start.</td> </tr> <tr> <td>9</td> <td>Start interlock 2</td> <td>0 = Start interlock 2 is not present, drive is not allowed to start; 1 = Start interlock 2 is present, drive is allowed to start.</td> </tr> <tr> <td>10</td> <td>Start interlock 3</td> <td>0 = Start interlock 3 is not present, drive is not allowed to start; 1 = Start interlock 3 is present, drive is allowed to start.</td> </tr> <tr> <td>11</td> <td>Start interlock 4</td> <td>0 = Start interlock 4 is not present, drive is not allowed to start; 1 = Start interlock 4 is present, drive is allowed to start.</td> </tr> <tr> <td>12</td> <td>All start interlocks</td> <td>0 = One or more of Start interlock 1, Start interlock 2, Start interlock 3 or Start interlock 4 is not present, drive is not allowed to start; 1 = Start interlock 1 and Start interlock 2 and Start interlock 3 and Start interlock 4 are all present, drive is allowed to start.</td> </tr> <tr> <td>13...15</td> <td>Reserved</td> <td></td> </tr> </tbody> </table>	Bit	Name	Description	0	Hand mode	0 = Drive is not operated from the control panel in the Hand mode; 1 = Drive is operated from the control panel in the Hand mode.	1	Off mode	0 = Drive is not in the Off mode; 1 = Drive is in the Off mode.	2	Auto mode	0 = Drive is not in the Auto mode; 1 = Drive is in the Auto mode.	4	Pre-heating	0 = Motor pre-heating is not active; 1 = Motor pre-heating is active.	5	Damper control	0 = Damper control is not active; 1 = Damper control is active.	6	Reserved		7	Run permissive	0 = Run permissive is not present, drive is not allowed to run; 1 = Run permissive is present, drive is allowed to run.	8	Start interlock 1	0 = Start interlock 1 is not present, drive is not allowed to start; 1 = Start interlock 1 is present, drive is allowed to start.	9	Start interlock 2	0 = Start interlock 2 is not present, drive is not allowed to start; 1 = Start interlock 2 is present, drive is allowed to start.	10	Start interlock 3	0 = Start interlock 3 is not present, drive is not allowed to start; 1 = Start interlock 3 is present, drive is allowed to start.	11	Start interlock 4	0 = Start interlock 4 is not present, drive is not allowed to start; 1 = Start interlock 4 is present, drive is allowed to start.	12	All start interlocks	0 = One or more of Start interlock 1, Start interlock 2, Start interlock 3 or Start interlock 4 is not present, drive is not allowed to start; 1 = Start interlock 1 and Start interlock 2 and Start interlock 3 and Start interlock 4 are all present, drive is allowed to start.	13...15	Reserved		
Bit	Name	Description																																											
0	Hand mode	0 = Drive is not operated from the control panel in the Hand mode; 1 = Drive is operated from the control panel in the Hand mode.																																											
1	Off mode	0 = Drive is not in the Off mode; 1 = Drive is in the Off mode.																																											
2	Auto mode	0 = Drive is not in the Auto mode; 1 = Drive is in the Auto mode.																																											
4	Pre-heating	0 = Motor pre-heating is not active; 1 = Motor pre-heating is active.																																											
5	Damper control	0 = Damper control is not active; 1 = Damper control is active.																																											
6	Reserved																																												
7	Run permissive	0 = Run permissive is not present, drive is not allowed to run; 1 = Run permissive is present, drive is allowed to run.																																											
8	Start interlock 1	0 = Start interlock 1 is not present, drive is not allowed to start; 1 = Start interlock 1 is present, drive is allowed to start.																																											
9	Start interlock 2	0 = Start interlock 2 is not present, drive is not allowed to start; 1 = Start interlock 2 is present, drive is allowed to start.																																											
10	Start interlock 3	0 = Start interlock 3 is not present, drive is not allowed to start; 1 = Start interlock 3 is present, drive is allowed to start.																																											
11	Start interlock 4	0 = Start interlock 4 is not present, drive is not allowed to start; 1 = Start interlock 4 is present, drive is allowed to start.																																											
12	All start interlocks	0 = One or more of Start interlock 1, Start interlock 2, Start interlock 3 or Start interlock 4 is not present, drive is not allowed to start; 1 = Start interlock 1 and Start interlock 2 and Start interlock 3 and Start interlock 4 are all present, drive is allowed to start.																																											
13...15	Reserved																																												
	0000h...FFFFh		1 = 1																																										
06.29	<i>MSW bit 10 selection</i>	Selects a binary source whose status is transmitted as bit 10 of <i>06.11 Main status word</i> .	See parameter <i>06.17 Drive status word 2</i> .																																										
	False	0.	0																																										
	True	1.	1																																										
	Above limit	Bit 10 of <i>06.17 Drive status word 2</i> (see page 373).	2																																										
	<i>Other [bit]</i>	Source selection (see <i>Terms and abbreviations</i> on page 358).	-																																										
06.30	<i>MSW bit 11 selection</i>	Selects a binary source whose status is transmitted as bit 11 (User bit 0) of <i>06.11 Main status word</i> .	<i>Ext ctrl loc</i>																																										
	False	0.	0																																										
	True	1.	1																																										
	Ext ctrl loc	Bit 11 of <i>06.01 Main control word</i> (see page 371).	2																																										
	<i>Other [bit]</i>	Source selection (see <i>Terms and abbreviations</i> on page 358).	-																																										

No.	Name/Value	Description	Def/FbEq16
06.31	<i>MSW bit 12 selection</i>	Selects a binary source whose status is transmitted as bit 12 (User bit 1) of <i>06.11 Main status word</i> .	See parameter
	False	0.	0
	True	1.	1
	Reserved	1.	2
	Run permissive	Bit 5 of <i>06.18 Start inhibit status word</i> status word (see page 374).	3
	<i>Other [bit]</i>	Source selection (see <i>Terms and abbreviations</i> on page 358).	-
06.32	<i>MSW bit 13 selection</i>	Selects a binary source whose status is transmitted as bit 13 (User bit 2) of <i>06.11 Main status word</i> .	<i>False</i>
	False	0.	0
	True	1.	1
	<i>Other [bit]</i>	Source selection (see <i>Terms and abbreviations</i> on page 358).	-
06.33	<i>MSW bit 14 selection</i>	Selects a binary source whose status is transmitted as bit 14 (User bit 3) of <i>06.11 Main status word</i> .	<i>False</i>
	False	0.	0
	True	1.	1
	<i>Other [bit]</i>	Source selection (see <i>Terms and abbreviations</i> on page 358).	-
07 System info		Drive hardware and firmware information. All parameters in this group are read-only.	
07.03	<i>Drive rating id</i>	Type of the drive. (Rating ID in brackets.)	1 = 1
07.04	<i>Firmware name</i>	Firmware identification.	-
07.05	<i>Firmware version</i>	Version number of the firmware.	-
07.06	<i>Loading package name</i>	Name of the firmware loading package.	-
07.07	<i>Loading package version</i>	Version number of the firmware loading package.	-
07.11	<i>Cpu usage</i>	Microprocessor load in percent.	-
	0...100%	Microprocessor load.	1 = 1%
07.25	<i>Customization package name</i>	First five ASCII letters of the name given to the customization package. The full name is visible under System info on the control panel or the Drive composer PC tool. _N/A_ = None.	-
07.26	<i>Customization package version</i>	Customization package version number. Also visible under System info on the control panel or the Drive composer PC tool.	-

No.	Name/Value	Description	Def/FbEq16																																																
07.30	<i>Adaptive program status</i>	Shows the status of the adaptive program. See section <i>Adaptive programming</i> (page 113).	-																																																
<table border="1"> <thead> <tr> <th>Bit</th> <th>Name</th> <th>Description</th> </tr> </thead> <tbody> <tr> <td>0</td> <td>Initialized</td> <td>1 = Adaptive program initialized</td> </tr> <tr> <td>1</td> <td>Editing</td> <td>1 = Adaptive program is being edited</td> </tr> <tr> <td>2</td> <td>Edit done</td> <td>1 = Editing of adaptive program finished</td> </tr> <tr> <td>3</td> <td>Running</td> <td>1 = Adaptive program running</td> </tr> <tr> <td>4...13</td> <td>Reserved</td> <td></td> </tr> <tr> <td>14</td> <td>State changing</td> <td>1 = State change in progress in adaptive programming engine</td> </tr> <tr> <td>15</td> <td>Faulted</td> <td>1 = Error in adaptive program</td> </tr> </tbody> </table>				Bit	Name	Description	0	Initialized	1 = Adaptive program initialized	1	Editing	1 = Adaptive program is being edited	2	Edit done	1 = Editing of adaptive program finished	3	Running	1 = Adaptive program running	4...13	Reserved		14	State changing	1 = State change in progress in adaptive programming engine	15	Faulted	1 = Error in adaptive program																								
Bit	Name	Description																																																	
0	Initialized	1 = Adaptive program initialized																																																	
1	Editing	1 = Adaptive program is being edited																																																	
2	Edit done	1 = Editing of adaptive program finished																																																	
3	Running	1 = Adaptive program running																																																	
4...13	Reserved																																																		
14	State changing	1 = State change in progress in adaptive programming engine																																																	
15	Faulted	1 = Error in adaptive program																																																	
	0000h...FFFFh	Adaptive program status.	1 = 1																																																
07.31	<i>AP sequence state</i>	Shows the number of the active state of the sequence program part of the adaptive program (AP). If adaptive programming is not running, or it does not contain a sequence program, the parameter is zero.																																																	
	0...20		1 = 1																																																
07.35	<i>Drive configuration</i>	Plug 'n' play configuration. Performs HW initialization, and shows the detected module configuration of the drive. During the HW initialization, if the drive is not able to detect any module, the value is set to 1, Base unit. For information on automatic setting of parameters after detecting a module, see section <i>Automatic drive configuration for fieldbus control</i> on page 361.	0000h																																																
<table border="1"> <thead> <tr> <th>Bit</th> <th>Name</th> <th>Description</th> </tr> </thead> <tbody> <tr> <td>0</td> <td>Not initialized</td> <td>1 = Drive configuration has not been initialized</td> </tr> <tr> <td>1</td> <td>Base unit</td> <td>1 = Drive has not detected any modules.</td> </tr> <tr> <td>2</td> <td>Reserved</td> <td></td> </tr> <tr> <td>3</td> <td>FENA-21</td> <td>1 = FENA-21 Two-port Ethernet adapter module included</td> </tr> <tr> <td>4</td> <td>FECA-01</td> <td>1 = FECA-01 EtherCAT adapter module included</td> </tr> <tr> <td>5</td> <td>FPBA-01</td> <td>1 = FPBA-01 PROFIBUS DP adapter module included</td> </tr> <tr> <td>6</td> <td>FCAN-01</td> <td>1 = FCAN-01 CANopen adapter module included</td> </tr> <tr> <td>7</td> <td>Reserved</td> <td></td> </tr> <tr> <td>8</td> <td>BIO-01</td> <td>1 = Frontal I/O extension</td> </tr> <tr> <td>9</td> <td>RIIO-01</td> <td>1 = Frontal standard I/O extension</td> </tr> <tr> <td>10</td> <td>FSCA-01</td> <td>1 = FSCA-01 Modbus/RTU adapter module included</td> </tr> <tr> <td>11</td> <td>FEIP-21</td> <td>1 = FEIP-21 Two-port EtherNet/IP adapter module included</td> </tr> <tr> <td>12</td> <td>FMBT-21</td> <td>1 = FMBT-21 Two-port Modbus/TCP adapter module included</td> </tr> <tr> <td>13</td> <td>FBIP-21</td> <td>1 = FBIP-21 BACnet/IP (2-port) adapter module included</td> </tr> <tr> <td>14</td> <td>FBNO-21</td> <td>1 = FPNO-21 Two-port PROFINET IO adapter module included</td> </tr> </tbody> </table>				Bit	Name	Description	0	Not initialized	1 = Drive configuration has not been initialized	1	Base unit	1 = Drive has not detected any modules.	2	Reserved		3	FENA-21	1 = FENA-21 Two-port Ethernet adapter module included	4	FECA-01	1 = FECA-01 EtherCAT adapter module included	5	FPBA-01	1 = FPBA-01 PROFIBUS DP adapter module included	6	FCAN-01	1 = FCAN-01 CANopen adapter module included	7	Reserved		8	BIO-01	1 = Frontal I/O extension	9	RIIO-01	1 = Frontal standard I/O extension	10	FSCA-01	1 = FSCA-01 Modbus/RTU adapter module included	11	FEIP-21	1 = FEIP-21 Two-port EtherNet/IP adapter module included	12	FMBT-21	1 = FMBT-21 Two-port Modbus/TCP adapter module included	13	FBIP-21	1 = FBIP-21 BACnet/IP (2-port) adapter module included	14	FBNO-21	1 = FPNO-21 Two-port PROFINET IO adapter module included
Bit	Name	Description																																																	
0	Not initialized	1 = Drive configuration has not been initialized																																																	
1	Base unit	1 = Drive has not detected any modules.																																																	
2	Reserved																																																		
3	FENA-21	1 = FENA-21 Two-port Ethernet adapter module included																																																	
4	FECA-01	1 = FECA-01 EtherCAT adapter module included																																																	
5	FPBA-01	1 = FPBA-01 PROFIBUS DP adapter module included																																																	
6	FCAN-01	1 = FCAN-01 CANopen adapter module included																																																	
7	Reserved																																																		
8	BIO-01	1 = Frontal I/O extension																																																	
9	RIIO-01	1 = Frontal standard I/O extension																																																	
10	FSCA-01	1 = FSCA-01 Modbus/RTU adapter module included																																																	
11	FEIP-21	1 = FEIP-21 Two-port EtherNet/IP adapter module included																																																	
12	FMBT-21	1 = FMBT-21 Two-port Modbus/TCP adapter module included																																																	
13	FBIP-21	1 = FBIP-21 BACnet/IP (2-port) adapter module included																																																	
14	FBNO-21	1 = FPNO-21 Two-port PROFINET IO adapter module included																																																	
	0000h...FFFFh	Drive configuration.	1 = 1																																																

No.	Name/Value	Description	Def/FbEq16																		
07.36	Drive configuration 2	Shows the detected module configuration. See parameter 07.35 Drive configuration .	0000h																		
<table border="1"> <thead> <tr> <th>Bit</th> <th>Name</th> <th>Description</th> </tr> </thead> <tbody> <tr> <td>0</td> <td>Reserved</td> <td></td> </tr> <tr> <td>1</td> <td>FDNA-01</td> <td>1 = FDNA-01 DeviceNet™ adapter module include</td> </tr> <tr> <td>2</td> <td>FCNA-01</td> <td>1 = FCNA-01 ControlNet™ adapter module include</td> </tr> <tr> <td>8</td> <td>CAIO-01</td> <td>1 = CAIO-01 adapter module included</td> </tr> <tr> <td>3...15</td> <td>Reserved</td> <td></td> </tr> </tbody> </table>				Bit	Name	Description	0	Reserved		1	FDNA-01	1 = FDNA-01 DeviceNet™ adapter module include	2	FCNA-01	1 = FCNA-01 ControlNet™ adapter module include	8	CAIO-01	1 = CAIO-01 adapter module included	3...15	Reserved	
Bit	Name	Description																			
0	Reserved																				
1	FDNA-01	1 = FDNA-01 DeviceNet™ adapter module include																			
2	FCNA-01	1 = FCNA-01 ControlNet™ adapter module include																			
8	CAIO-01	1 = CAIO-01 adapter module included																			
3...15	Reserved																				
0000h...FFFFh		Drive configuration.	1 = 1																		

10 Standard DI, RO		Configuration of digital inputs and relay outputs.																									
10.01	DI status	Displays the electrical status of digital inputs DI1...DI6. The activation/deactivation delays of the inputs (if any are specified) are ignored. Bits 0...5 reflect the status of DI1...DI6. Example: 0000000000010011b = DI5, DI2 and DI1 are on, DI3, DI4 and DI6 are off. This parameter is read-only.	-																								
<table border="1"> <thead> <tr> <th>Bit</th> <th>Name</th> <th>Description</th> </tr> </thead> <tbody> <tr> <td>0</td> <td>DI1</td> <td>1 = Digital input 1 is ON.</td> </tr> <tr> <td>1</td> <td>DI2</td> <td>1 = Digital input 2 is ON.</td> </tr> <tr> <td>2</td> <td>DI3</td> <td>1 = Digital input 3 is ON.</td> </tr> <tr> <td>3</td> <td>DI4</td> <td>1 = Digital input 4 is ON.</td> </tr> <tr> <td>4</td> <td>DI5</td> <td>1 = Digital input 5 is ON.</td> </tr> <tr> <td>5</td> <td>DI6</td> <td>1 = Digital input 6 is ON.</td> </tr> <tr> <td>6...15</td> <td>Reserved</td> <td></td> </tr> </tbody> </table>				Bit	Name	Description	0	DI1	1 = Digital input 1 is ON.	1	DI2	1 = Digital input 2 is ON.	2	DI3	1 = Digital input 3 is ON.	3	DI4	1 = Digital input 4 is ON.	4	DI5	1 = Digital input 5 is ON.	5	DI6	1 = Digital input 6 is ON.	6...15	Reserved	
Bit	Name	Description																									
0	DI1	1 = Digital input 1 is ON.																									
1	DI2	1 = Digital input 2 is ON.																									
2	DI3	1 = Digital input 3 is ON.																									
3	DI4	1 = Digital input 4 is ON.																									
4	DI5	1 = Digital input 5 is ON.																									
5	DI6	1 = Digital input 6 is ON.																									
6...15	Reserved																										
0000h...FFFFh		Status of digital inputs.	1 = 1																								
10.02	DI delayed status	Displays the delayed status of digital inputs DI1...DI6. Bits 0...5 reflect the delayed status of DI1...DI6. Example: 0000000000010011b = DI5, DI2 and DI1 are on, DI3, DI4 and DI6 are off. This word is updated only after a 2 ms activation/deactivation delay. When the value of a digital input changes, it must remain the same in two consecutive samples, that is for 2 ms, for the new value to be accepted. This parameter is read-only.	-																								
0000h...FFFFh		Delayed status for digital inputs.	1 = 1																								

No.	Name/Value	Description	Def/FbEq16																								
10.03	<i>DI force selection</i>	The electrical statuses of the digital inputs can be overridden, for example, testing purposes. A bit in parameter <i>10.04 DI forced data</i> is provided for each digital input, and its value is applied whenever the corresponding bit in this parameter is 1. Note: Boot and power cycle reset the force selections (parameters <i>10.03</i> and <i>10.04</i>).	0000h																								
<table border="1"> <thead> <tr> <th>Bit</th> <th>Name</th> <th>Value</th> </tr> </thead> <tbody> <tr> <td>0</td> <td>DI1</td> <td>1 = Force DI1 to value of bit 0 of parameter <i>10.04 DI forced data</i>. (0 = Normal mode)</td> </tr> <tr> <td>1</td> <td>DI2</td> <td>1 = Force DI2 to value of bit 1 of parameter <i>10.04 DI forced data</i>. (0 = Normal mode)</td> </tr> <tr> <td>2</td> <td>DI3</td> <td>1 = Force DI3 to value of bit 2 of parameter <i>10.04 DI forced data</i>. (0 = Normal mode)</td> </tr> <tr> <td>3</td> <td>DI4</td> <td>1 = Force DI4 to value of bit 3 of parameter <i>10.04 DI forced data</i>. (0 = Normal mode)</td> </tr> <tr> <td>4</td> <td>DI5</td> <td>1 = Force DI5 to value of bit 4 of parameter <i>10.04 DI forced data</i>. (0 = Normal mode)</td> </tr> <tr> <td>5</td> <td>DI6</td> <td>1 = Force DI6 to value of bit 5 of parameter <i>10.04 DI forced data</i>. (0 = Normal mode)</td> </tr> <tr> <td>6...15</td> <td colspan="2">Reserved</td> </tr> </tbody> </table>				Bit	Name	Value	0	DI1	1 = Force DI1 to value of bit 0 of parameter <i>10.04 DI forced data</i> . (0 = Normal mode)	1	DI2	1 = Force DI2 to value of bit 1 of parameter <i>10.04 DI forced data</i> . (0 = Normal mode)	2	DI3	1 = Force DI3 to value of bit 2 of parameter <i>10.04 DI forced data</i> . (0 = Normal mode)	3	DI4	1 = Force DI4 to value of bit 3 of parameter <i>10.04 DI forced data</i> . (0 = Normal mode)	4	DI5	1 = Force DI5 to value of bit 4 of parameter <i>10.04 DI forced data</i> . (0 = Normal mode)	5	DI6	1 = Force DI6 to value of bit 5 of parameter <i>10.04 DI forced data</i> . (0 = Normal mode)	6...15	Reserved	
Bit	Name	Value																									
0	DI1	1 = Force DI1 to value of bit 0 of parameter <i>10.04 DI forced data</i> . (0 = Normal mode)																									
1	DI2	1 = Force DI2 to value of bit 1 of parameter <i>10.04 DI forced data</i> . (0 = Normal mode)																									
2	DI3	1 = Force DI3 to value of bit 2 of parameter <i>10.04 DI forced data</i> . (0 = Normal mode)																									
3	DI4	1 = Force DI4 to value of bit 3 of parameter <i>10.04 DI forced data</i> . (0 = Normal mode)																									
4	DI5	1 = Force DI5 to value of bit 4 of parameter <i>10.04 DI forced data</i> . (0 = Normal mode)																									
5	DI6	1 = Force DI6 to value of bit 5 of parameter <i>10.04 DI forced data</i> . (0 = Normal mode)																									
6...15	Reserved																										
0000h...FFFFh		Override selection for digital inputs.	1 = 1																								
10.04	<i>DI forced data</i>	Allows the data value of a forced digital input to be changed from 0 to 1. It is only possible to force an input that has been selected in parameter <i>10.03 DI force selection</i> . Bit 0 is the forced value for DI1; bit 5 is the forced value for the DI6.	0000h																								
<table border="1"> <thead> <tr> <th>Bit</th> <th>Name</th> <th>Value</th> </tr> </thead> <tbody> <tr> <td>0</td> <td>DI1</td> <td>1 = Force the value of this bit to D1, if so defined in parameter <i>10.03 DI force selection</i>.</td> </tr> <tr> <td>1</td> <td>DI2</td> <td>1 = Force the value of this bit to D3, if so defined in parameter <i>10.03 DI force selection</i>.</td> </tr> <tr> <td>2</td> <td>DI3</td> <td>1 = Force the value of this bit to D3, if so defined in parameter <i>10.03 DI force selection</i>.</td> </tr> <tr> <td>3</td> <td>DI4</td> <td>1 = Force the value of this bit to D4, if so defined in parameter <i>10.03 DI force selection</i>.</td> </tr> <tr> <td>4</td> <td>DI5</td> <td>1 = Force the value of this bit to D5, if so defined in parameter <i>10.03 DI force selection</i>.</td> </tr> <tr> <td>5</td> <td>DI6</td> <td>1 = Force the value of this bit to D6, if so defined in parameter <i>10.03 DI force selection</i>.</td> </tr> <tr> <td>6...15</td> <td colspan="2">Reserved</td> </tr> </tbody> </table>				Bit	Name	Value	0	DI1	1 = Force the value of this bit to D1, if so defined in parameter <i>10.03 DI force selection</i> .	1	DI2	1 = Force the value of this bit to D3, if so defined in parameter <i>10.03 DI force selection</i> .	2	DI3	1 = Force the value of this bit to D3, if so defined in parameter <i>10.03 DI force selection</i> .	3	DI4	1 = Force the value of this bit to D4, if so defined in parameter <i>10.03 DI force selection</i> .	4	DI5	1 = Force the value of this bit to D5, if so defined in parameter <i>10.03 DI force selection</i> .	5	DI6	1 = Force the value of this bit to D6, if so defined in parameter <i>10.03 DI force selection</i> .	6...15	Reserved	
Bit	Name	Value																									
0	DI1	1 = Force the value of this bit to D1, if so defined in parameter <i>10.03 DI force selection</i> .																									
1	DI2	1 = Force the value of this bit to D3, if so defined in parameter <i>10.03 DI force selection</i> .																									
2	DI3	1 = Force the value of this bit to D3, if so defined in parameter <i>10.03 DI force selection</i> .																									
3	DI4	1 = Force the value of this bit to D4, if so defined in parameter <i>10.03 DI force selection</i> .																									
4	DI5	1 = Force the value of this bit to D5, if so defined in parameter <i>10.03 DI force selection</i> .																									
5	DI6	1 = Force the value of this bit to D6, if so defined in parameter <i>10.03 DI force selection</i> .																									
6...15	Reserved																										
0000h...FFFFh		Forced values of digital inputs.	1 = 1																								

No.	Name/Value	Description	Def/FbEq16
10.05	<i>DI1 ON delay</i>	Defines the activation delay for digital input DI1.	0.00 s
<p> $t_{On} = 10.05$ <i>DI1 ON delay</i> $t_{Off} = 10.06$ <i>DI1 OFF delay</i> *Electrical status of digital input. Indicated by <i>10.01 DI status</i>. **Indicated by <i>10.02 DI delayed status</i>. </p>			
	0.00 ... 3000.00 s	Activation delay for DI1.	10 = 1 s
10.06	<i>DI1 OFF delay</i>	Defines the deactivation delay for digital input DI1. See parameter <i>10.05 DI1 ON delay</i> .	0.00 s
	0.00 ... 3000.00 s	Deactivation delay for DI1.	10 = 1 s
10.07	<i>DI2 ON delay</i>	Defines the activation delay for digital input DI2.	0.00 s
<p> $t_{On} = 10.07$ <i>DI2 ON delay</i> $t_{Off} = 10.08$ <i>DI2 OFF delay</i> *Electrical status of digital input. Indicated by <i>10.01 DI status</i>. **Indicated by <i>10.02 DI delayed status</i>. </p>			
	0.00 ... 3000.00 s	Activation delay for DI2.	10 = 1 s
10.08	<i>DI2 OFF delay</i>	Defines the deactivation delay for digital input DI2. See parameter <i>10.07 DI2 ON delay</i> .	0.00 s
	0.00 ... 3000.00 s	Deactivation delay for DI2.	10 = 1 s

No.	Name/Value	Description	Def/FbEq16
10.09	<i>DI3 ON delay</i>	Defines the activation delay for digital input DI3.	0.00 s
<p><i>t</i>_{On} = 10.09 <i>DI3 ON delay</i> <i>t</i>_{Off} = 10.10 <i>DI3 OFF delay</i> *Electrical status of digital input. Indicated by 10.01 <i>DI status</i>. **Indicated by 10.02 <i>DI delayed status</i>.</p>			
	0.00 ... 3000.00 s	Activation delay for DI3.	10 = 1 s
10.10	<i>DI3 OFF delay</i>	Defines the deactivation delay for digital input DI3. See parameter 10.09 <i>DI3 ON delay</i> .	0.00 s
	0.00 ... 3000.00 s	Deactivation delay for DI3.	10 = 1 s
10.11	<i>DI4 ON delay</i>	Defines the activation delay for digital input DI4.	0.00 s
<p><i>t</i>_{On} = 10.11 <i>DI4 ON delay</i> <i>t</i>_{Off} = 10.12 <i>DI4 OFF delay</i> *Electrical status of digital input. Indicated by 10.01 <i>DI status</i>. **Indicated by 10.02 <i>DI delayed status</i>.</p>			
	0.00 ... 3000.00 s	Activation delay for DI4.	10 = 1 s
10.12	<i>DI4 OFF delay</i>	Defines the deactivation delay for digital input DI4. See parameter 10.11 <i>DI4 ON delay</i> .	0.00 s
	0.00 ... 3000.00 s	Deactivation delay for DI4.	10 = 1 s

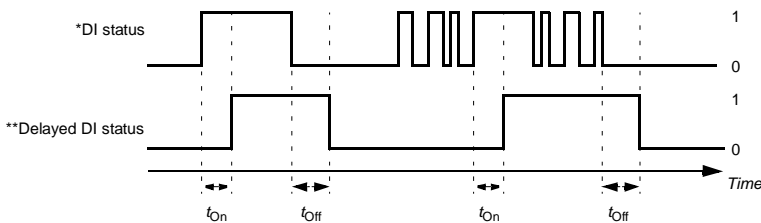
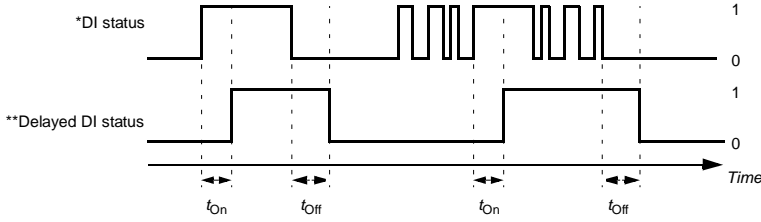
No.	Name/Value	Description	Def/FbEq16										
10.13	<i>DI5 ON delay</i>	Defines the activation delay for digital input DI5.	0.00 s										
 <p>$t_{On} = 10.13$ <i>DI5 ON delay</i> $t_{Off} = 10.14$ <i>DI5 OFF delay</i> *Electrical status of digital input. Indicated by <i>10.01 DI status</i>. **Indicated by <i>10.02 DI delayed status</i>.</p>													
	0.00 ... 3000.00 s	Activation delay for DI5.	10 = 1 s										
10.14	<i>DI5 OFF delay</i>	Defines the deactivation delay for digital input DI5. See parameter <i>10.13 DI5 ON delay</i> .	0.00 s										
	0.00 ... 3000.00 s	Deactivation delay for DI5.	10 = 1 s										
10.15	<i>DI6 ON delay</i>	Defines the activation delay for digital input DI6.	0.00 s										
 <p>$t_{On} = 10.15$ <i>DI6 ON delay</i> $t_{Off} = 10.16$ <i>DI6 OFF delay</i> *Electrical status of digital input. Indicated by <i>10.01 DI status</i>. **Indicated by <i>10.02 DI delayed status</i>.</p>													
	0.00 ... 3000.00 s	Activation delay for DI6.	10 = 1 s										
10.16	<i>DI6 OFF delay</i>	Defines the deactivation delay for digital input DI6. See parameter <i>10.15 DI6 ON delay</i> .	0.00 s										
	0.00 ... 3000.00 s	Deactivation delay for DI6.	10 = 1 s										
10.21	<i>RO status</i>	Status of relay outputs RO3...RO1.	-										
<table border="1" data-bbox="212 1197 1019 1340"> <thead> <tr> <th>Bit</th> <th>Value</th> </tr> </thead> <tbody> <tr> <td>0</td> <td>1 = RO1 is energized.</td> </tr> <tr> <td>1</td> <td>1 = RO2 is energized.</td> </tr> <tr> <td>2</td> <td>1 = RO3 is energized.</td> </tr> <tr> <td>3...15</td> <td>Reserved</td> </tr> </tbody> </table>				Bit	Value	0	1 = RO1 is energized.	1	1 = RO2 is energized.	2	1 = RO3 is energized.	3...15	Reserved
Bit	Value												
0	1 = RO1 is energized.												
1	1 = RO2 is energized.												
2	1 = RO3 is energized.												
3...15	Reserved												
	0000h...FFFFh	Status of relay outputs.	1 = 1										

No.	Name/Value	Description	Def/FbEq16										
10.22	<i>RO force selection</i>	The signals connected to the relay outputs can be overridden for, for example, testing purposes. A bit in parameter 10.23 RO forced data is provided for each relay output, and its value is applied whenever the corresponding bit in this parameter is 1. Note: Boot and power cycle reset the force selections (parameters 10.22 and 10.23).	0000h										
<table border="1"> <thead> <tr> <th>Bit</th> <th>Value</th> </tr> </thead> <tbody> <tr> <td>0</td> <td>1 = Force RO1 to value of bit 0 of parameter 10.23 RO forced data. (0 = Normal mode)</td> </tr> <tr> <td>1</td> <td>1 = Force RO2 to value of bit 1 of parameter 10.23 RO forced data. (0 = Normal mode)</td> </tr> <tr> <td>2</td> <td>1 = Force RO3 to value of bit 2 of parameter 10.23 RO forced data. (0 = Normal mode)</td> </tr> <tr> <td>3...15</td> <td>Reserved</td> </tr> </tbody> </table>				Bit	Value	0	1 = Force RO1 to value of bit 0 of parameter 10.23 RO forced data . (0 = Normal mode)	1	1 = Force RO2 to value of bit 1 of parameter 10.23 RO forced data . (0 = Normal mode)	2	1 = Force RO3 to value of bit 2 of parameter 10.23 RO forced data . (0 = Normal mode)	3...15	Reserved
Bit	Value												
0	1 = Force RO1 to value of bit 0 of parameter 10.23 RO forced data . (0 = Normal mode)												
1	1 = Force RO2 to value of bit 1 of parameter 10.23 RO forced data . (0 = Normal mode)												
2	1 = Force RO3 to value of bit 2 of parameter 10.23 RO forced data . (0 = Normal mode)												
3...15	Reserved												
	0000h...FFFFh	Override selection for relay outputs.	1 = 1										
10.23	<i>RO forced data</i>	Contains the values of relay outputs that are used instead of the connected signals if selected in parameter 10.22 RO force selection . Bit 0 is the forced value for RO1.	0000h										
<table border="1"> <thead> <tr> <th>Bit</th> <th>Value</th> </tr> </thead> <tbody> <tr> <td>0</td> <td>1 = Force the value of this bit to RO1, if so defined in parameter 10.22 RO force selection.</td> </tr> <tr> <td>1</td> <td>1 = Force the value of this bit to RO2, if so defined in parameter 10.22 RO force selection.</td> </tr> <tr> <td>2</td> <td>1 = Force the value of this bit to RO3, if so defined in parameter 10.22 RO force selection.</td> </tr> <tr> <td>3...15</td> <td>Reserved</td> </tr> </tbody> </table>				Bit	Value	0	1 = Force the value of this bit to RO1, if so defined in parameter 10.22 RO force selection .	1	1 = Force the value of this bit to RO2, if so defined in parameter 10.22 RO force selection .	2	1 = Force the value of this bit to RO3, if so defined in parameter 10.22 RO force selection .	3...15	Reserved
Bit	Value												
0	1 = Force the value of this bit to RO1, if so defined in parameter 10.22 RO force selection .												
1	1 = Force the value of this bit to RO2, if so defined in parameter 10.22 RO force selection .												
2	1 = Force the value of this bit to RO3, if so defined in parameter 10.22 RO force selection .												
3...15	Reserved												
	0000h...FFFFh	Forced RO values.	1 = 1										
10.24	<i>RO1 source</i>	Selects a drive signal to be connected to relay output RO1.	<i>Damper control</i>										
	Not energized	Output is not energized.	0										
	Energized	Output is energized.	1										
	Ready run	Bit 1 of 06.11 Main status word (see page 371).	2										
	Enabled	Bit 0 of 06.16 Drive status word 1 (see page 372).	4										
	Started	Bit 5 of 06.16 Drive status word 1 (see page 372).	5										
	Magnetized	Bit 1 of 06.17 Drive status word 2 (see page 373).	6										
	Running	Bit 14 of 06.16 Drive status word 1 (see page 372).	7										
	Ready ref	Bit 2 of 06.11 Main status word (see page 371).	8										
	At setpoint	Bit 8 of 06.11 Main status word (see page 371).	9										
	Reverse	Bit 2 of 06.19 Speed control status word (see page 374).	10										
	Zero speed	Bit 0 of 06.19 Speed control status word (see page 374).	11										
	Above limit	Bit 10 of 06.17 Drive status word 2 (see page 373).	12										
	Warning	Bit 7 of 06.11 Main status word (see page 371).	13										
	Fault	Bit 3 of 06.11 Main status word (see page 371).	14										
	Fault (-1)	Inverted bit 3 of 06.11 Main status word (see page 371).	15										

No.	Name/Value	Description	Def/FbEq16
	Fault/Warning	Bit 3 of <i>06.11 Main status word</i> OR bit 7 of <i>06.11 Main status word</i> (see page 371).	16
	Overcurrent	Fault <i>2310 Overcurrent</i> has occurred.	17
	Overvoltage	Fault <i>3210 DC link overvoltage</i> has occurred.	18
	Drive temp	Fault <i>2381 IGBT overload</i> , <i>4110 Control board temperature</i> , <i>4210 IGBT overtemperature</i> , <i>4290 Cooling</i> , <i>42F1 IGBT temperature</i> , <i>4310 Excess temperature</i> or <i>4380 Excess temperature difference</i> has occurred.	19
	Undervoltage	Fault <i>3220 DC link undervoltage</i> has occurred.	20
	Motor temp	Fault <i>4981 External temperature 1</i> or <i>4982 External temperature 2</i> has occurred.	21
	Reserved		22
	Ext2 active	Bit 11 of <i>06.16 Drive status word 1</i> (see page 372).	23
	Remote control	Bit 9 of <i>06.11 Main status word</i> (see page 371).	24
	Reserved		25...26
	Timed function 1	Bit 0 of <i>34.01 Timed functions status</i> (see page 496).	27
	Timed function 2	Bit 1 of <i>34.01 Timed functions status</i> (see page 496).	28
	Timed function 3	Bit 2 of <i>34.01 Timed functions status</i> (see page 496).	29
	Reserved		30...32
	Supervision 1	Bit 0 of <i>32.01 Supervision status</i> (see page 485).	33
	Supervision 2	Bit 1 of <i>32.01 Supervision status</i> (see page 485).	34
	Supervision 3	Bit 2 of <i>32.01 Supervision status</i> (see page 485).	35
	Reserved		36...38
	Start delay	Bit 13 of <i>06.17 Drive status word 2</i> (see page 373).	39
	RO/DIO control word bit0	Bit 0 of <i>10.99 RO/DIO control word</i> (see page 389).	40
	RO/DIO control word bit1	Bit 1 of <i>10.99 RO/DIO control word</i> (see page 389).	41
	RO/DIO control word bit2	Bit 2 of <i>10.99 RO/DIO control word</i> (see page 389).	42
	Reserved		43...44
	PFC1	Bit 0 of <i>76.01 PFC status</i> (see page 575).	45
	PFC2	Bit 1 of <i>76.01 PFC status</i> (see page 575).	46
	PFC3	Bit 2 of <i>76.01 PFC status</i> (see page 575).	47
	PFC4	Bit 3 of <i>76.01 PFC status</i> (see page 575).	48
	PFC5	Bit 4 of <i>76.01 PFC status</i> (see page 575). See parameter <i>76.01</i> .	49
	PFC6	Bit 5 of <i>76.01 PFC status</i> (see page 575). See parameter <i>76.01</i> .	50
	Reserved		51...52
	Event word 1	Event word 1 = 1 if any bit of <i>04.40 Event word 1</i> (see page 366) is 1, that is, if any warning, fault or pure event that has been defined with parameters <i>04.41...04.71</i> is on.	53

No.	Name/Value	Description	Def/FbEq16
	Damper control	See the figure below.	54

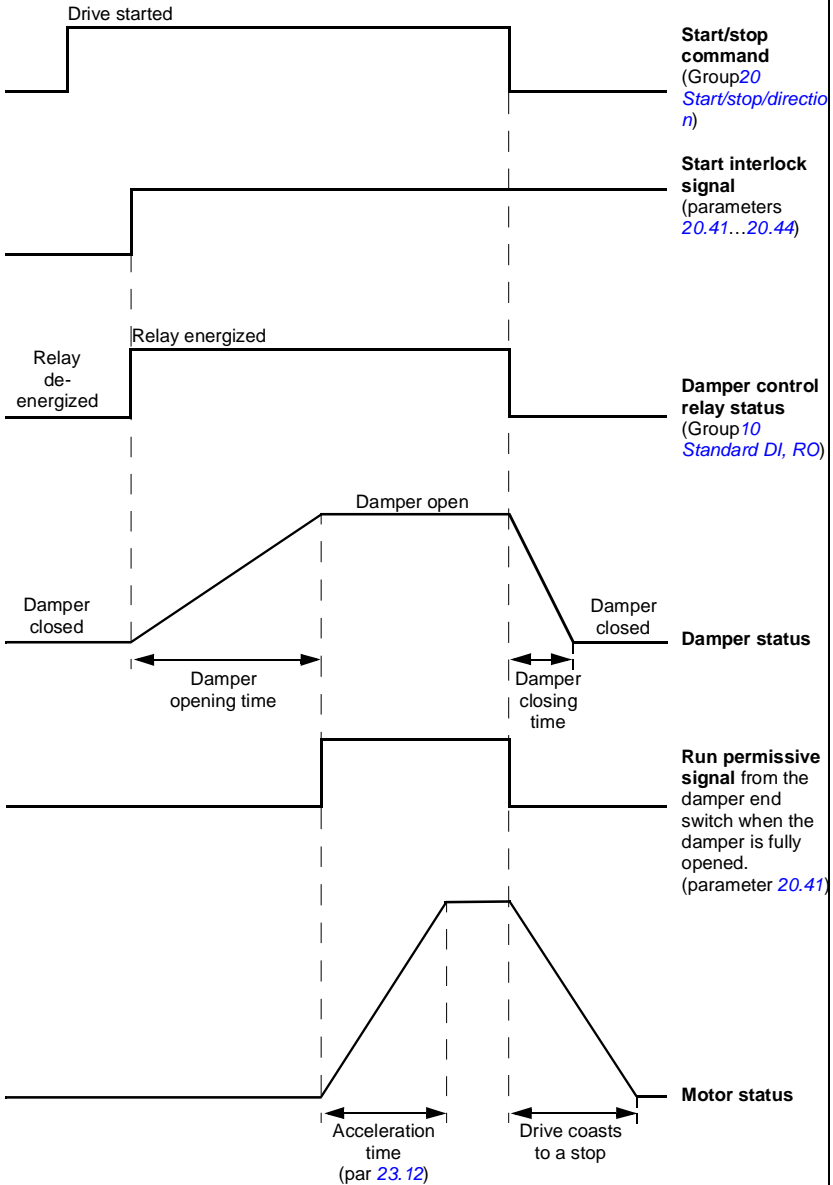

Run permissive	Bit 7 of <i>06.22 HVAC status word.</i>	55
Start interlock 1	Bit 8 of <i>06.22 HVAC status word.</i>	56

No.	Name/Value	Description	Def/FbEq16
	Start interlock 2	Bit 9 of 06.22 HVAC status word .	57
	Start interlock 3	Bit 10 of 06.22 HVAC status word .	58
	Start interlock 4	Bit 11 of 06.22 HVAC status word .	59
	All start interlocks	Bit 12 of 06.22 HVAC status word .	60
	User load curve	Bit 3 (Outside load limit) of 37.01 ULC output status word (see page 517).	61
	RO/DIO control word	For 10.24 RO1 source : Bit 0 (RO1) of 10.99 RO/DIO control word (see page 389). For 10.27 RO2 source : Bit 1 (RO2) of 10.99 RO/DIO control word (see page 389). For 10.30 RO3 source : Bit 2 (RO3) of 10.99 RO/DIO control word (see page 389).	62
	Discharge damper control	Bit 3 of 84.02 Damper control status word .	63
	Outside air damper control	Bit 7 of 84.02 Damper control status word .	64
	Other [bit]	Source selection (see Terms and abbreviations on page 358).	-
10.25	RO1 ON delay	Defines the activation delay for relay output RO1.	0.0 s
<p> $t_{On} = 10.25 \text{ RO1 ON delay}$ $t_{Off} = 10.26 \text{ RO1 OFF delay}$ </p>			
	0.0 ... 3000.0 s	Activation delay for RO1.	10 = 1 s
10.26	RO1 OFF delay	Defines the deactivation delay for relay output RO1. See parameter 10.25 RO1 ON delay .	0.0 s
	0.0 ... 3000.0 s	Deactivation delay for RO1.	10 = 1 s
10.27	RO2 source	Selects a drive signal to be connected to relay output RO2. For the available selections, see parameter 10.24 RO1 source .	Running

No.	Name/Value	Description	Def/FbEq16
10.28	<i>RO2 ON delay</i>	Defines the activation delay for relay output RO2.	0.0 s
<p>$t_{On} = 10.28 \text{ RO2 ON delay}$ $t_{Off} = 10.29 \text{ RO2 OFF delay}$</p>			
	0.0 ... 3000.0 s	Activation delay for RO2.	10 = 1 s
10.29	<i>RO2 OFF delay</i>	Defines the deactivation delay for relay output RO2. See parameter 10.28 RO2 ON delay .	0.0 s
	0.0 ... 3000.0 s	Deactivation delay for RO2.	10 = 1 s
10.30	<i>RO3 source</i>	Selects a drive signal to be connected to relay output RO3. For the available selections, see parameter 10.24 RO1 source .	<i>Fault (-1)</i>
10.31	<i>RO3 ON delay</i>	Defines the activation delay for relay output RO3.	0.0 s
<p>$t_{On} = 10.31 \text{ RO3 ON delay}$ $t_{Off} = 10.32 \text{ RO3 OFF delay}$</p>			
	0.0 ... 3000.0 s	Activation delay for RO3.	10 = 1 s
10.32	<i>RO3 OFF delay</i>	Defines the deactivation delay for relay output RO3. See parameter 10.31 RO3 ON delay .	0.0 s
	0.0 ... 3000.0 s	Deactivation delay for RO3.	10 = 1 s

No.	Name/Value	Description	Def/FbEq16																														
10.99	<i>RO/DIO control word</i>	Storage parameter for controlling the relay outputs, for example, through the embedded fieldbus interface. To control the relay outputs (RO) of the drive, send a control word with the bit assignments shown below as Modbus I/O data. Set the target selection parameter of that particular data (58.101...58.114) to <i>RO/DIO control word</i> . In the source selection parameter of the desired output, select the appropriate bit of this word.	0000h																														
<table border="1"> <thead> <tr> <th>Bit</th> <th>Name</th> <th>Description</th> </tr> </thead> <tbody> <tr> <td>0</td> <td>RO1</td> <td>Source bit for relay output RO1. See parameter 10.24.</td> </tr> <tr> <td>1</td> <td>RO2</td> <td>Source bit for relay output RO2. See parameter 10.27.</td> </tr> <tr> <td>2</td> <td>RO3</td> <td>Source bit for relay output RO3. See parameter 10.30.</td> </tr> <tr> <td>3</td> <td>RO4</td> <td>Source bit for extension module relay output RO4. See parameter 15.07.</td> </tr> <tr> <td>4</td> <td>RO5</td> <td>Source bit for extension module relay output RO4. See parameter 15.10.</td> </tr> <tr> <td>5</td> <td>RO6</td> <td>Source bit for extension module relay output RO4. See parameter 15.13.</td> </tr> <tr> <td>6</td> <td>RO7</td> <td>Source bit for extension module relay output RO4. See parameter 15.16.</td> </tr> <tr> <td>8</td> <td>DIO1</td> <td>Source bit for digital output DO1 with a BIO-01 extension module. See parameter 15.23.</td> </tr> <tr> <td>9...15</td> <td>Reserved</td> <td></td> </tr> </tbody> </table>				Bit	Name	Description	0	RO1	Source bit for relay output RO1. See parameter 10.24.	1	RO2	Source bit for relay output RO2. See parameter 10.27.	2	RO3	Source bit for relay output RO3. See parameter 10.30.	3	RO4	Source bit for extension module relay output RO4. See parameter 15.07.	4	RO5	Source bit for extension module relay output RO4. See parameter 15.10.	5	RO6	Source bit for extension module relay output RO4. See parameter 15.13.	6	RO7	Source bit for extension module relay output RO4. See parameter 15.16.	8	DIO1	Source bit for digital output DO1 with a BIO-01 extension module. See parameter 15.23.	9...15	Reserved	
Bit	Name	Description																															
0	RO1	Source bit for relay output RO1. See parameter 10.24.																															
1	RO2	Source bit for relay output RO2. See parameter 10.27.																															
2	RO3	Source bit for relay output RO3. See parameter 10.30.																															
3	RO4	Source bit for extension module relay output RO4. See parameter 15.07.																															
4	RO5	Source bit for extension module relay output RO4. See parameter 15.10.																															
5	RO6	Source bit for extension module relay output RO4. See parameter 15.13.																															
6	RO7	Source bit for extension module relay output RO4. See parameter 15.16.																															
8	DIO1	Source bit for digital output DO1 with a BIO-01 extension module. See parameter 15.23.																															
9...15	Reserved																																
	0000h...FFFFh	RO/DIO control word.	1 = 1																														
10.101	<i>RO1 toggle counter</i>	Displays the number of times relay output RO1 has changed states. Can be reset from the control panel by pressing the Reset softkey for 3 seconds.	5																														
	0...4294967000	State change count.	1 = 1																														
10.102	<i>RO2 toggle counter</i>	Displays the number of times relay output RO2 has changed states. Can be reset from the control panel by pressing the Reset softkey for 3 seconds.	0																														
	0...4294967000	State change count.	1 = 1																														
10.103	<i>RO3 toggle counter</i>	Displays the number of times relay output RO3 has changed states. Can be reset from the control panel by pressing the Reset softkey for 3 seconds.	5																														
	0...4294967000	State change count.	1 = 1																														

No.	Name/Value	Description	Def/FbEq16									
11 Standard DIO, FI, FO												
11 Standard DIO, FI, FO		Configuration of frequency inputs 1 and 2 as well as frequency output and digital output.										
11.02	<i>DIO delayed status</i>	Displays the status of digital or frequency output DIO1 (terminal DO1 on BIO-01). Bit 0 reflects the delayed status of DIO1. Example: 0000000000000001b = DIO1 is on. This word is updated only after a 2 ms activation/deactivation delay. When the value of a digital input changes, it must remain the same in two consecutive samples, that is for 2 ms, for the new value to be accepted. This parameter is read-only.	-									
<table border="1"> <thead> <tr> <th>Bit</th> <th>Name</th> <th>Description</th> </tr> </thead> <tbody> <tr> <td>0</td> <td>DIO1</td> <td>1 = Digital or frequency output DIO1 is ON.</td> </tr> <tr> <td>1...15</td> <td>Reserved</td> <td></td> </tr> </tbody> </table>				Bit	Name	Description	0	DIO1	1 = Digital or frequency output DIO1 is ON.	1...15	Reserved	
Bit	Name	Description										
0	DIO1	1 = Digital or frequency output DIO1 is ON.										
1...15	Reserved											
	0000h...FFFFh	Delayed status for digital or frequency output DIO1.	1 = 1									
11.04	<i>DIO force data</i>	The signal connected to the digital output can be overridden for, for example, testing purposes. A bit in parameter <i>11.04 DIO force data</i> is provided for digital or frequency output DIO1 (terminal DO1 on BIO-01), and its value is applied whenever the corresponding bit in this parameter is 1. Note: Boot and power cycle reset the force selections (parameters <i>10.22</i> and <i>10.23</i>).	0000h									
<table border="1"> <thead> <tr> <th>Bit</th> <th>Value</th> </tr> </thead> <tbody> <tr> <td>0</td> <td>1 = Force DIO1 to value of bit 0 of parameter <i>11.04 DIO force data</i>. (0 = Normal mode)</td> </tr> <tr> <td>1...15</td> <td>Reserved</td> </tr> </tbody> </table>				Bit	Value	0	1 = Force DIO1 to value of bit 0 of parameter <i>11.04 DIO force data</i> . (0 = Normal mode)	1...15	Reserved			
Bit	Value											
0	1 = Force DIO1 to value of bit 0 of parameter <i>11.04 DIO force data</i> . (0 = Normal mode)											
1...15	Reserved											
	0000h...FFFFh	Override selection for digital or frequency output DIO1.	1 = 1									
11.04	<i>DIO force data</i>	Contains the value of for digital or frequency output DIO1 (terminal DO1 on BIO-01) that is used instead of the connected signals if selected in parameter <i>11.04 DIO force data</i> . Bit 0 is the forced value for DIO1.	0000h									
<table border="1"> <thead> <tr> <th>Bit</th> <th>Value</th> </tr> </thead> <tbody> <tr> <td>0</td> <td>1 = Force the value of this bit to DIO1, if so defined in parameter <i>11.04 DIO force data</i>.</td> </tr> <tr> <td>1...15</td> <td>Reserved</td> </tr> </tbody> </table>				Bit	Value	0	1 = Force the value of this bit to DIO1, if so defined in parameter <i>11.04 DIO force data</i> .	1...15	Reserved			
Bit	Value											
0	1 = Force the value of this bit to DIO1, if so defined in parameter <i>11.04 DIO force data</i> .											
1...15	Reserved											
	0000h...FFFFh	Forced value of digital or frequency output DIO1.	1 = 1									
11.06	<i>DIO1 configuration</i>	Selects whether output DIO1 (terminal DO1 on BIO-01) is used as a digital output or frequency output.	<i>Digital output</i>									
	Digital output	DIO1 is used as a digital output.	0									
	Frequency output	DIO1 is used as a frequency output.	2									
11.06	<i>DIO1 configuration</i>	Selects a drive signal to be connected to output DIO1 (terminal DO1 on BIO-01) when it is configured to digital output by parameter <i>11.06 DIO1 configuration</i> .	<i>Not energized</i>									
	Not energized	Output is not energized.	0									

No.	Name/Value	Description	Def/FbEq16
	Energized	Output is energized.	1
	Ready run	Bit 1 of <i>06.11 Main status word</i> (see page 371).	2
	Enabled	Bit 0 of <i>06.16 Drive status word 1</i> (see page 372).	4
	Started	Bit 5 of <i>06.16 Drive status word 1</i> (see page 372).	5
	Magnetized	Bit 1 of <i>06.17 Drive status word 2</i> (see page 373).	6
	Running	Bit 6 of <i>06.16 Drive status word 1</i> (see page 372).	7
	Ready ref	Bit 2 of <i>06.11 Main status word</i> (see page 371).	8
	At setpoint	Bit 8 of <i>06.11 Main status word</i> (see page 371).	9
	Reverse	Bit 2 of <i>06.19 Speed control status word</i> (see page 374).	10
	Zero speed	Bit 0 of <i>06.19 Speed control status word</i> (see page 374).	11
	Above limit	Bit 10 of <i>06.17 Drive status word 2</i> (see page 373).	12
	Warning	Bit 7 of <i>06.11 Main status word</i> (see page 371).	13
	Fault	Bit 3 of <i>06.11 Main status word</i> (see page 371).	14
	Fault (-1)	Inverted bit 3 of <i>06.11 Main status word</i> (see page 371).	15
	Fault/Warning	Bit 3 of <i>06.11 Main status word</i> OR bit 7 of <i>06.11 Main status word</i> (see page 371).	16
	Overcurrent	Fault <i>2310 Overcurrent</i> has occurred.	17
	Overvoltage	Fault <i>3210 DC link overvoltage</i> .	18
	Drive temp	Fault <i>2381 IGBT overload</i> , <i>4110 Control board temperature</i> , <i>4210 IGBT overtemperature</i> , <i>4290 Cooling</i> , <i>42F1 IGBT temperature</i> , <i>4310 Excess temperature</i> or <i>4380 Excess temperature difference</i> has occurred.	19
	Undervoltage	Fault <i>3220 DC link undervoltage</i> .	20
	Motor temp	Fault <i>4981 External temperature 1</i> or <i>4982 External temperature 2</i> has occurred.	21
	Reserved		22
	Ext2 active	Bit 11 of <i>06.16 Drive status word 1</i> (see page 372).	23
	Remote control	Bit 9 of <i>06.11 Main status word</i> (see page 371).	24
	Reserved		25...26
	Timed function 1	Bit 0 of <i>34.01 Timed functions status</i> (see page 496).	27
	Timed function 2	Bit 1 of <i>34.01 Timed functions status</i> (see page 496).	28
	Timed function 3	Bit 2 of <i>34.01 Timed functions status</i> (see page 496).	29
	Reserved		30...32
	Supervision 1	Bit 0 of <i>32.01 Supervision status</i> (see page 485).	33
	Supervision 2	Bit 1 of <i>32.01 Supervision status</i> (see page 485).	34
	Supervision 3	Bit 2 of <i>32.01 Supervision status</i> (see page 485).	35
	Reserved		36...38
	Start delay	Bit 13 of <i>06.17 Drive status word 2</i> (see page 373).	39
	RO/DIO control word bit0	Bit 0 of <i>10.99 RO/DIO control word</i> (see page 389).	40
	RO/DIO control word bit1	Bit 1 of <i>10.99 RO/DIO control word</i> (see page 389).	41
	RO/DIO control word bit2	Bit 2 of <i>10.99 RO/DIO control word</i> (see page 389).	42

No.	Name/Value	Description	Def/FbEq16
	Reserved		43...44
	PFC1	Bit 0 of 76.01 PFC status (see page 575).	45
	PFC2	Bit 1 of 76.01 PFC status (see page 575).	46
	PFC3	Bit 2 of 76.01 PFC status (see page 575).	47
	PFC4	Bit 3 of 76.01 PFC status (see page 575).	48
	PFC5	Bit 4 of 76.01 PFC status (see page 575).	49
	PFC6	Bit 5 of 76.01 PFC status (see page 575).	50
	Reserved		51...52
	Event word 1	Event word 1 = 1 if any bit of 04.40 Event word 1 (see page 366) is 1, that is, if any warning, fault or pure event that has been defined with parameters 04.41...04.71 is on.	53

No.	Name/Value	Description	Def/FbEq16
	Damper control	See the figure below.	54
<p>The diagram illustrates the timing sequence for damper control. It features six horizontal signal lines:</p> <ul style="list-style-type: none"> Drive started: A pulse that initiates the process. Start interlock signal: A pulse that occurs after the drive starts. Relay energized: A pulse that occurs after the start interlock signal. Damper status: Shows the damper transitioning from 'closed' to 'open' (ramp up) and back to 'closed' (ramp down). It includes 'Damper opening time' and 'Damper closing time' intervals. Run permissive signal: A pulse that occurs when the damper is fully open. Motor status: Shows a ramp up during 'Acceleration time (par 23.12)' and a ramp down during 'Drive coasts to a stop'. 			
	Run permissive	Bit 7 of <i>06.22 HVAC status word</i> .	55
	Start interlock 1	Bit 8 of <i>06.22 HVAC status word</i> .	56

No.	Name/Value	Description	Def/FbEq16
	Start interlock 2	Bit 9 of 06.22 HVAC status word .	57
	Start interlock 3	Bit 10 of 06.22 HVAC status word .	58
	Start interlock 4	Bit 11 of 06.22 HVAC status word .	59
	All start interlocks	Bit 12 of 06.22 HVAC status word .	60
	User load curve	Bit 3 (Outside load limit) of 37.01 ULC output status word (see page 517).	61
	RO/DIO control word	For 10.24 RO1 source : Bit 0 (RO1) of 10.99 RO/DIO control word (see page 389). For 10.27 RO2 source : Bit 1 (RO2) of 10.99 RO/DIO control word (see page 389). For 10.30 RO3 source : Bit 2 (RO3) of 10.99 RO/DIO control word (see page 389).	62
	<i>Other [bit]</i>	Source selection (see Terms and abbreviations on page 358).	-
11.07	DIO1 ON delay	Defines the activation delay for DO1 on BIO-01 when it is used as a digital output.	0.00 s
	0.0...3000.0 s	Activation delay for DO1.	10 = 1 s
11.08	DIO1 OFF delay	Defines the deactivation delay for DO1 on BIO-01 when it is used as a digital output.	0.00 s
	0.0...3000.0 s	Deactivation delay for DO1.	10 = 1 s
11.17	DI4 configuration	Selects how digital input 4 is used.	Digital input
	Digital input	DI4 is used as a digital input.	0
	Frequency input	DI4 is used as a frequency input 1.	1
11.21	DI5 configuration	Selects how digital input 5 is used.	Digital input
	Digital input	DI5 is used as a digital input.	0
	Frequency input	DI5 is used as a frequency input 2.	1
11.38	Freq in 1 actual value	Displays the value of frequency input 1 (via DI4 when it is used as a frequency input) before scaling. See parameter 11.42 Freq in 1 min . This parameter is read-only.	-
	0 ... 16000 Hz	Unscaled value of frequency input 1 (DI4).	1 = 1 Hz
11.39	Freq in 1 scaled value	Displays the value of frequency input 1 (via DI4 when it is used as a frequency input) after scaling. See parameter 11.42 Freq in 1 min . This parameter is read-only.	-
	-32768.000... 32767.000	Scaled value of frequency input 1 (DI4).	1 = 1

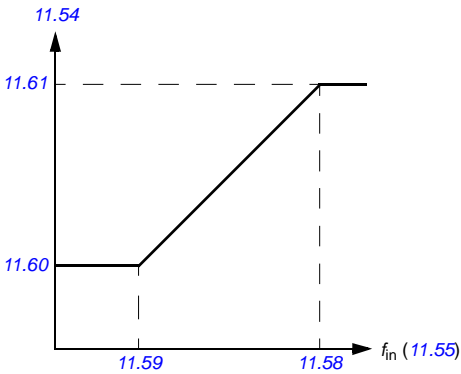

No.	Name/Value	Description	Def/FbEq16
11.42	<i>Freq in 1 min</i>	<p>Defines the minimum for the frequency actually arriving at frequency input 1 (DI4) when it is used as a frequency input. The incoming frequency signal (<i>11.38 Freq in 1 actual value</i>) is scaled into an internal signal (<i>11.39 Freq in 1 scaled value</i>) by parameters 11.42...11.45 as follows:</p>	0 Hz
	0 ... 16000 Hz	Minimum frequency of frequency input 1 (DI4).	1 = 1 Hz
11.43	<i>Freq in 1 max</i>	<p>Defines the maximum for the frequency actually arriving at frequency input 1 (DI4) when it is used as a frequency input. See parameter 11.42 <i>Freq in 1 min</i>.</p>	16000 Hz
	0 ... 16000 Hz	Maximum frequency for frequency input 1 (DI4).	1 = 1 Hz
11.44	<i>Freq in 1 at scaled min</i>	<p>Defines the value that is required to correspond internally to the minimum input frequency defined by parameter 11.42 <i>Freq in 1 min</i>. See diagram at parameter 11.42 <i>Freq in 1 min</i>.</p>	0.000
	-32768.000... 32767.000	Value corresponding to minimum of frequency input 1.	1 = 1
11.45	<i>Freq in 1 at scaled max</i>	<p>Defines the value that is required to correspond internally to the maximum input frequency defined by parameter 11.43 <i>Freq in 1 max</i>. See diagram at parameter 11.42 <i>Freq in 1 min</i>.</p>	1500.000; 1800.000 (95.20 b0)
	-32768.000... 32767.000	Value corresponding to maximum of frequency input 1.	1 = 1
11.46	<i>Freq in 2 actual value</i>	<p>Displays the value of frequency input 2 (via DI5 when it is used as a frequency input) before scaling. See parameter 11.50 <i>Freq in 2 min</i>. This parameter is read-only.</p>	-
	0 ... 16000 Hz	Unscaled value of frequency input 2.	1 = 1 Hz
11.47	<i>Freq in 2 scaled value</i>	<p>Displays the value of frequency input 2 (via DI5 when it is used as a frequency input) after scaling. See parameter 11.50 <i>Freq in 2 min</i>. This parameter is read-only.</p>	-
	-32768.000... 32767.000	Scaled value of frequency input 2 (DI5).	1 = 1

No.	Name/Value	Description	Def/FbEq16
11.50	<i>Freq in 2 min</i>	<p>Defines the minimum for the frequency actually arriving at frequency input 1 (DI5) when it is used as a frequency input). The incoming frequency signal (11.46 <i>Freq in 2 actual value</i>) is scaled into an internal signal (11.47 <i>Freq in 2 scaled value</i>) by parameters 11.50...11.53 as follows:</p>	0 Hz
	0...16000 Hz	Minimum frequency of frequency input 1 (DI5).	1 = 1 Hz
11.51	<i>Freq in 2 max</i>	<p>Defines the maximum for the frequency actually arriving at frequency input 1 (DI5) when it is used as a frequency input). See parameter 11.50 <i>Freq in 2 min</i>.</p>	16000 Hz
	0...16000 Hz	Maximum frequency for frequency input 2 (DI5).	1 = 1 Hz
11.52	<i>Freq in 2 at scaled min</i>	<p>Defines the value that is required to correspond internally to the minimum input frequency defined by parameter 11.50 <i>Freq in 2 min</i>. See diagram at parameter 11.50 <i>Freq in 2 min</i>.</p>	0.000
	-32768.000... 32767.000	Value corresponding to minimum of frequency input 2.	1 = 1
11.53	<i>Freq in 2 at scaled max</i>	<p>Defines the value that is required to correspond internally to the maximum input frequency defined by parameter 11.51 <i>Freq in 2 max</i>. See diagram at parameter 11.50 <i>Freq in 2 min</i>.</p>	1500.000; 1800.000 (95.20 b0)
	-32768.000... 32767.000	Value corresponding to maximum of frequency input 1.	1 = 1
11.54	<i>Freq out 1 actual value</i>	<p>Displays the value of frequency output 1 (terminal DO1 on BIO-01) after scaling. See parameter 11.58 <i>Freq out 1 src min</i>. This applies when parameter 11.06 <i>DIO1 configuration</i> is set to <i>Frequency output</i>. This parameter is read-only.</p>	-
	0...16000 Hz	Unscaled value of frequency output 1.	1 = 1 Hz

No.	Name/Value	Description	Def/FbEq16
11.55	<i>Freq out 1 source</i>	Selects a signal to be connected to frequency output 1 (terminal DO1 on BIO-01) when parameter 11.06 DIO1 configuration is set to <i>Frequency output</i> .	<i>Not energized</i>
	Not selected	None.	0
	Motor speed used	01.01 <i>Motor speed used</i> (page 361).	1
	Reserved		2
	Output frequency	01.06 <i>Output frequency</i> (page 361).	3
	Motor current	01.07 <i>Motor current</i> (page 361).	4
	Reserved		5
	Motor torque	01.10 <i>Motor torque</i> (page 361).	6
	DC voltage	01.11 <i>DC voltage</i> (page 361).	7
	Output power	01.14 <i>Output power</i> (page 362).	8
	Reserved		9
	Speed ref ramp in	23.01 <i>Speed ref ramp input</i> (page 449).	10
	Speed ref ramp out	23.02 <i>Speed ref ramp output</i> (page 449).	11
	Speed ref used	24.01 <i>Used speed reference</i> (page 452).	12
	Reserved		13
	Freq ref used	28.02 <i>Frequency ref ramp output</i> (page 457).	14
	Reserved		15
	Process PID out	40.01 <i>Process PID output actual</i> (page 521).	16
	Reserved		17...19
11.58	<i>Freq out 1 src min</i>	<p>Defines the real value of the signal (selected by parameter 11.55 <i>Freq out 1 source</i> and shown by parameter 11.54 <i>Freq out 1 actual value</i>) that corresponds to the minimum value of frequency output 1 (defined by parameter 11.60 <i>Freq out 1 src min</i>).</p> <p>This applies when parameter 11.06 DIO1 configuration is set to <i>Frequency output</i>.</p> 	0.000
	-32768.000... 32767.000	Real signal value corresponding to minimum value of frequency output 1.	1 = 1

No.	Name/Value	Description	Def/FbEq16
11.59	<i>Freq out 1 src max</i>	the real value of the signal (selected by parameter 11.55 Freq out 1 source and shown by parameter 11.54 Freq out 1 actual value) that corresponds to the maximum value of frequency output 1 (defined by parameter 11.61 Freq out 1 src max). See parameter 11.58 Freq out 1 src min . This applies when parameter 11.06 DIO1 configuration is set to <i>Frequency output</i>	1500.000
	-32768.000... 32767.000	Real signal value corresponding to maximum value of frequency output 1.	1 = 1
11.60	<i>Freq out 1 at src min</i>	Defines the minimum value of frequency output 1. See diagram at 11.58 Freq out 1 src min .	0 Hz
	0 ... 16000 Hz	Minimum value of frequency output 1.	1 = 1 Hz
11.61	<i>Freq out 1 at src max</i>	Defines the maximum value of frequency output 1. See diagram at 11.58 Freq out 1 src min .	16000 Hz
	0 ... 16000 Hz	Maximum value of frequency output 1.	1 = 1 Hz

12 Standard AI		Configuration of standard analog inputs.													
12.02	<i>AI force selection</i>	<p>The true readings of the analog inputs can be overridden, for example, for testing purposes. A forced value parameter is provided for each analog input, and its value is applied whenever the corresponding bit in this parameter is 1.</p> <p>Notes:</p> <ul style="list-style-type: none"> AI filter times (parameters 12.16 AI1 filter time and 12.26 AI2 filter time) have no effect on forced AI values (parameters 12.13 AI1 forced value and 12.23 AI2 forced value). Boot and power cycle reset the force selections (parameters 12.02 and 12.03). 	0000h												
		<table border="1"> <thead> <tr> <th>Bit</th> <th>Name</th> <th>Value</th> </tr> </thead> <tbody> <tr> <td>0</td> <td>AI1</td> <td>1 = Force AI1 to value of parameter 12.13 AI1 forced value.</td> </tr> <tr> <td>1</td> <td>AI2</td> <td>1 = Force AI2 to value of parameter 12.23 AI2 forced value.</td> </tr> <tr> <td>2...15</td> <td>Reserved</td> <td></td> </tr> </tbody> </table>	Bit	Name	Value	0	AI1	1 = Force AI1 to value of parameter 12.13 AI1 forced value .	1	AI2	1 = Force AI2 to value of parameter 12.23 AI2 forced value .	2...15	Reserved		
Bit	Name	Value													
0	AI1	1 = Force AI1 to value of parameter 12.13 AI1 forced value .													
1	AI2	1 = Force AI2 to value of parameter 12.23 AI2 forced value .													
2...15	Reserved														
	0000h...FFFFh	Forced values selector for analog inputs AI1 and AI2.	1 = 1												
12.03	<i>AI supervision function</i>	<p>Selects how the drive reacts when an analog input signal moves out of the minimum and/or maximum limits specified for the input.</p> <p>The supervision applies a margin of 0.5 V or 1.0 mA to the limits. For example, if the maximum limit for the input is 7.000 V, the maximum limit supervision activates at 7.500 V. The inputs and the limits to be observed are selected by parameter 12.04 AI supervision selection.</p>	<i>No action</i>												
	No action	No action taken.	0												
	Fault	Drive trips on fault 80A0 AI supervision .	1												
	Warning	Drive generates warning A8A0 AI supervision .	2												

No.	Name/Value	Description	Def/FbEq16																											
	Last speed	Drive generates warning <i>A8A0 AI supervision</i> and freezes the speed (or frequency) to the level the drive was operating at. The speed/frequency is determined on the basis of actual speed using 850 ms low-pass filtering.  WARNING! Make sure that it is safe to continue operation in case of a communication break.	3																											
	Speed ref safe	Drive generates warning <i>A8A0 AI supervision</i> and sets the speed to the speed defined by parameter <i>22.41 Speed ref safe</i> (or <i>28.41 Frequency ref safe</i> when frequency reference is being used).  WARNING! Make sure that it is safe to continue operation in case of a communication break.	4																											
12.04	<i>AI supervision selection</i>	Specifies the analog input limits to be supervised. See parameter <i>12.03 AI supervision function</i> .	0000h																											
<table border="1"> <thead> <tr> <th>Bit</th> <th>Name</th> <th>Description</th> </tr> </thead> <tbody> <tr> <td>0</td> <td>AI1 < MIN</td> <td>1 = Minimum limit supervision of AI1 active.</td> </tr> <tr> <td>1</td> <td>AI1 > MAX</td> <td>1 = Maximum limit supervision of AI1 active.</td> </tr> <tr> <td>2</td> <td>AI2 < MIN</td> <td>1 = Minimum limit supervision of AI2 active.</td> </tr> <tr> <td>3</td> <td>AI2 > MAX</td> <td>1 = Maximum limit supervision of AI2 active.</td> </tr> <tr> <td>4...15</td> <td>Reserved</td> <td></td> </tr> </tbody> </table>				Bit	Name	Description	0	AI1 < MIN	1 = Minimum limit supervision of AI1 active.	1	AI1 > MAX	1 = Maximum limit supervision of AI1 active.	2	AI2 < MIN	1 = Minimum limit supervision of AI2 active.	3	AI2 > MAX	1 = Maximum limit supervision of AI2 active.	4...15	Reserved										
Bit	Name	Description																												
0	AI1 < MIN	1 = Minimum limit supervision of AI1 active.																												
1	AI1 > MAX	1 = Maximum limit supervision of AI1 active.																												
2	AI2 < MIN	1 = Minimum limit supervision of AI2 active.																												
3	AI2 > MAX	1 = Maximum limit supervision of AI2 active.																												
4...15	Reserved																													
	0000h...FFFFh	Activation of analog input supervision.	1 = 1																											
12.05	<i>AI supervision force</i>	Activates/deactivate the Analog Input supervision for each control location (EXT1, EXT2, Local). When a particular control location is not utilizing AI for referencing, then the AI supervision can be deactivated using this parameter, by deactivating particular AI supervision force bit. The user can mask the fault/warning for the selected control location.																												
<table border="1"> <thead> <tr> <th>Bit</th> <th>Name</th> <th>Description</th> </tr> </thead> <tbody> <tr> <td>0</td> <td>AI1 Ext1</td> <td>0 = AI1 supervision not active when EXT1 control is being used.</td> </tr> <tr> <td>1</td> <td>AI1 Ext2</td> <td>0 = AI1 supervision not active when EXT2 control is being used.</td> </tr> <tr> <td>2</td> <td>AI1 Local</td> <td>0 = AI1 supervision not active when Local control is being used.</td> </tr> <tr> <td>3</td> <td>Reserved</td> <td></td> </tr> <tr> <td>4</td> <td>AI2 Ext1</td> <td>0 = AI2 supervision not active when EXT1 control is being used.</td> </tr> <tr> <td>5</td> <td>AI2 Ext2</td> <td>0 = AI2 supervision not active when EXT2 control is being used.</td> </tr> <tr> <td>6</td> <td>AI2 Local</td> <td>0 = AI2 supervision not active when Local control is being used.</td> </tr> <tr> <td>7...15</td> <td>Reserved</td> <td></td> </tr> </tbody> </table>				Bit	Name	Description	0	AI1 Ext1	0 = AI1 supervision not active when EXT1 control is being used.	1	AI1 Ext2	0 = AI1 supervision not active when EXT2 control is being used.	2	AI1 Local	0 = AI1 supervision not active when Local control is being used.	3	Reserved		4	AI2 Ext1	0 = AI2 supervision not active when EXT1 control is being used.	5	AI2 Ext2	0 = AI2 supervision not active when EXT2 control is being used.	6	AI2 Local	0 = AI2 supervision not active when Local control is being used.	7...15	Reserved	
Bit	Name	Description																												
0	AI1 Ext1	0 = AI1 supervision not active when EXT1 control is being used.																												
1	AI1 Ext2	0 = AI1 supervision not active when EXT2 control is being used.																												
2	AI1 Local	0 = AI1 supervision not active when Local control is being used.																												
3	Reserved																													
4	AI2 Ext1	0 = AI2 supervision not active when EXT1 control is being used.																												
5	AI2 Ext2	0 = AI2 supervision not active when EXT2 control is being used.																												
6	AI2 Local	0 = AI2 supervision not active when Local control is being used.																												
7...15	Reserved																													
	AI1 Ext1	If active control location is EXT1, and AI supervision selection is high for AI1 (either bit0 AI1 < MIN or bit1 AI1 > MAX is true) and Supervision force bit 0 (AI1 Ext1) is deactivated, then the corresponding supervision function (fault/warning) can be masked.	0																											
	AI1 Ext2	If active control location is EXT2, and AI supervision selection is high for AI1 (either bit0 AI1 < MIN or bit1 AI1 > MAX is true) and Supervision force bit 1 (AI1 Ext2) is deactivated, then the corresponding supervision function (fault/warning) can be masked.	1																											

No.	Name/Value	Description	Def/FbEq16
	AI1 Local	If active control location is Local, and AI supervision selection is high for AI1 (either bit0 AI1 < MIN or bit1 AI1 > MAX is true) and Supervision force bit 1 (AI1 Local) is deactivated, then the corresponding supervision function (fault/warning) can be masked.	2
	AI2 Ext1	If active control location is EXT1, and AI supervision selection is high for AI2 (either bit2 AI2 < MIN or bit3 AI2 > MAX is true) and Supervision force bit 4 (AI2 Ext1) is deactivated, then the corresponding supervision function (fault/warning) can be masked.	4
	AI2 Ext2	If active control location is EXT1, and AI supervision selection is high for AI2 (either bit2 AI2 < MIN or bit3 AI2 > MAX is true) and Supervision force bit 4 (AI2 Ext1) is deactivated, then the corresponding supervision function (fault/warning) can be masked.	5
	AI2 Local	If active control location is Local, and AI supervision selection is high for AI1 (either bit2 AI2 < MIN or bit3 AI2 > MAX is true) and Supervision force bit 6 (AI2 Local) is deactivated, then the corresponding supervision function (fault/warning) can be masked.	6
12.11	AI1 actual value	Displays the value of analog input AI1 in mA or V (depending on whether the input is set to current or voltage). This parameter is read-only.	-
	0.000...22.000 mA or 0.000...11.000 V	Value of analog input AI1.	1000 = 1 unit
12.12	AI1 scaled value	Displays the value of analog input AI1 after scaling. See parameters 12.19 AI1 scaled at AI1 min and 12.20 AI1 scaled at AI1 max . This parameter is read-only.	-
	-32768.000... 32767.000	Scaled value of analog input AI1.	1 = 1
12.13	AI1 forced value	Forced value that can be used instead of the true reading of the input. See parameter 12.02 AI force selection .	0.000 V
	0.000...22.000 mA or 0.000...11.000 V	Forced value of analog input AI1.	1000 = 1 unit
12.15	AI1 unit selection	Selects the unit for readings and settings related to analog input AI1.	V
	V	Volts.	2
	mA	Milliamperes.	10

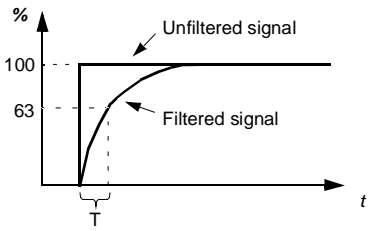
No.	Name/Value	Description	Def/FbEq16
12.16	<i>AI1 filter time</i>	<p>Defines the filter time constant for analog input AI1.</p>  $O = I \times (1 - e^{-t/T})$ <p>I = filter input (step) O = filter output t = time T = filter time constant</p> <p>Note: The signal is also filtered due to the signal interface hardware (approximately 0.25 ms time constant). This cannot be changed by any parameter.</p>	0.100 s
	0.000...30.000 s	Filter time constant.	1000 = 1 s
12.17	<i>AI1 min</i>	<p>Defines the minimum site value for analog input AI1. Set the value actually sent to the drive when the analog signal from plant is wound to its minimum setting. See also parameter 12.19 AI1 scaled at AI1 min.</p>	4.000 mA or 0.000 V
	0.000...22.000 mA or 0.000...11.000 V	Minimum value of AI1.	1000 = 1 unit
12.18	<i>AI1 max</i>	<p>Defines the maximum site value for analog input AI1. Set the value actually sent to the drive when the analog signal from plant is wound to its maximum setting. See also parameter 12.19 AI1 scaled at AI1 min.</p>	20.000 mA or 10.000 V
	0.000...22.000 mA or 0.000...11.000 V	Maximum value of AI1.	1000 = 1 unit

No.	Name/Value	Description	Def/FbEq16
12.19	<i>AI1 scaled at AI1 min</i>	<p>Defines the real internal value that corresponds to the minimum analog input AI1 value defined by parameter 12.17 AI1 min. (Changing the polarity settings of 12.19 and 12.20 can effectively invert the analog input.)</p>	0.000
	-32768.000... 32767.000	Real value corresponding to minimum AI1 value.	1 = 1
12.20	<i>AI1 scaled at AI1 max</i>	<p>Defines the real internal value that corresponds to the maximum analog input AI1 value defined by parameter 12.18 AI1 max. See the drawing at parameter 12.19 AI1 scaled at AI1 min.</p>	50.000; 60.000 (95.20 b0)
	-32768.000... 32767.000	Real value corresponding to maximum AI1 value.	1 = 1
12.21	<i>AI2 actual value</i>	<p>Displays the value of analog input AI2 in mA or V (depending on whether the input is set to current or voltage by a hardware setting). This parameter is read-only.</p>	-
	0.000...22.000 mA or 0.000...11.000 V	Value of analog input AI2.	1000 = 1 unit
12.22	<i>AI2 scaled value</i>	<p>Displays the value of analog input AI2 after scaling. See parameters 12.29 AI2 scaled at AI2 min and 12.101 AI1 percent value. This parameter is read-only.</p>	-
	-32768.000... 32767.000	Scaled value of analog input AI2.	1 = 1
12.23	<i>AI2 forced value</i>	<p>Forced value that can be used instead of the true reading of the input. See parameter 12.02 AI force selection.</p>	0.000 V
	0.000...22.000 mA or 0.000...11.000 V	Forced value of analog input AI2.	1000 = 1 unit
12.25	<i>AI2 unit selection</i>	<p>Selects the unit for readings and settings related to analog input AI2.</p>	<i>mA</i>
	V	Volts.	2
	mA	Milliamperes.	10
12.26	<i>AI2 filter time</i>	<p>Defines the filter time constant for analog input AI2. See parameter 12.16 AI1 filter time.</p>	0.100 s
	0.000...30.000 s	Filter time constant.	1000 = 1 s

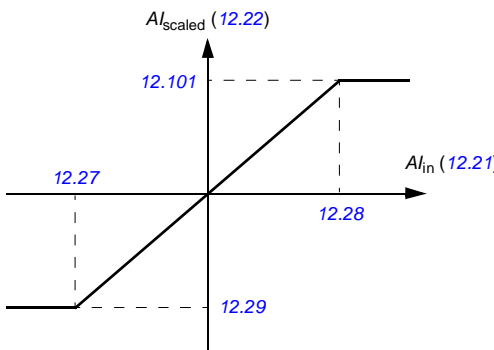
No.	Name/Value	Description	Def/FbEq16
12.27	<i>AI2 min</i>	Defines the minimum site value for analog input AI2. Set the value actually sent to the drive when the analog signal from plant is wound to its minimum setting.	4.000 mA
	0.000...22.000 mA or 0.000...11.000 V	Minimum value of AI2.	1000 = 1 unit
12.28	<i>AI2 max</i>	Defines the maximum site value for analog input AI2. Set the value actually sent to the drive when the analog signal from plant is wound to its maximum setting.	20.000 mA
	0.000...22.000 mA or 0.000...11.000 V	Maximum value of AI2.	1000 = 1 unit
12.29	<i>AI2 scaled at AI2 min</i>	Defines the real value that corresponds to the minimum analog input AI2 value defined by parameter 12.27 <i>AI2 min</i> . (Changing the polarity settings of 12.29 and 12.101 can effectively invert the analog input.) 	0.000
	-32768.000... 32767.000	Real value corresponding to minimum AI2 value.	1 = 1
12.30	<i>AI2 scaled at AI2 max</i>	Defines the real value that corresponds to the maximum analog input AI2 value defined by parameter 12.28 <i>AI2 max</i> . See the drawing at parameter of 12.29 <i>AI2 scaled at AI2 min</i> .	50.000
	-32768.000... 32767.000	Real value corresponding to maximum AI2 value.	1 = 1
12.101	<i>AI1 percent value</i>	Value of analog input AI1 in percent of AI1 scaling (12.18 <i>AI1 max</i> - 12.17 <i>AI1 min</i>).	-
	0.00...100.00%	AI1 value.	100 = 1%
12.102	<i>AI2 percent value</i>	Value of analog input AI2 in percent of AI2 scaling (12.28 <i>AI2 max</i> - 12.27 <i>AI2 min</i>).	-
	0.00...100.00%	AI2 value.	100 = 1%
12.110	<i>AI dead band</i>	AI dead band value in percentage where 100% = 10V in voltage mode and 100% = 20mA in current mode. Applicable for both AI1 and AI2 Note: 10% of AI dead band value is internally added in firmware as AI dead band hysteresis positive and negative. See section <i>AI dead band</i> on page 234.	0.40%
	0.00...100.00%	AI dead band value	100 = 1%

No.	Name/Value	Description	Def/FbEq16												
13 Standard AO															
Configuration of standard analog outputs.															
13.02	<i>AO force selection</i>	The source signals of the analog outputs can be overridden, for example, for testing purposes. A forced value parameter is provided for each analog output, and its value is applied whenever the corresponding bit in this parameter is 1. Note: Boot and power cycle reset the force selections (parameters 13.02 and 13.11).	0000h												
<table border="1"> <thead> <tr> <th>Bit</th> <th>Name</th> <th>Value</th> </tr> </thead> <tbody> <tr> <td>0</td> <td>AO1</td> <td>1 = Force AO1 to value of parameter 13.13 AO1 forced value. (0 = Normal mode)</td> </tr> <tr> <td>1</td> <td>AO2</td> <td>1 = Force AO2 to value of parameter 13.23 AO2 forced value. (0 = Normal mode)</td> </tr> <tr> <td>2...15</td> <td>Reserved</td> <td></td> </tr> </tbody> </table>				Bit	Name	Value	0	AO1	1 = Force AO1 to value of parameter 13.13 AO1 forced value . (0 = Normal mode)	1	AO2	1 = Force AO2 to value of parameter 13.23 AO2 forced value . (0 = Normal mode)	2...15	Reserved	
Bit	Name	Value													
0	AO1	1 = Force AO1 to value of parameter 13.13 AO1 forced value . (0 = Normal mode)													
1	AO2	1 = Force AO2 to value of parameter 13.23 AO2 forced value . (0 = Normal mode)													
2...15	Reserved														
	0000h...FFFFh	Forced values selector for analog outputs AO1 and AO2.	1 = 1												
13.11	<i>AO1 actual value</i>	Displays the value of AO1 in mA or V. This parameter is read-only.	-												
	0.000...22.000 mA or 0.000...11.000 V	Value of AO1.	1000 = 1 unit												
13.12	<i>AO1 source</i>	Selects a signal to be connected to analog output AO1.	<i>Output frequency</i>												
	Zero	None.	0												
	Motor speed used	01.01 Motor speed used (page 361).	1												
	Reserved		2												
	Output frequency	01.06 Output frequency (page 361).	3												
	Motor current	01.07 Motor current (page 361).	4												
	Motor current % of motor nominal	01.08 Motor current % of motor nom (page 361).	5												
	Motor torque	01.10 Motor torque (page 361).	6												
	DC voltage	01.11 DC voltage (page 361).	7												
	Output power	01.14 Output power (page 362).	8												
	Reserved		9												
	Speed ref ramp in	23.01 Speed ref ramp input (page 449).	10												
	Speed ref ramp out	23.02 Speed ref ramp output (page 449).	11												
	Speed ref used	24.01 Used speed reference (page 452).	12												
	Reserved		13												
	Freq ref used	28.02 Frequency ref ramp output (page 457).	14												
	Reserved		15												
	Process PID out	40.01 Process PID output actual (page 521).	16												
	Reserved		17...19												
	Temp sensor 1 excitation	The output is used to feed an excitation current to the temperature sensor 1, see parameter 35.11 Temperature 1 source . See also section Programmable protection functions (page 227).	20												

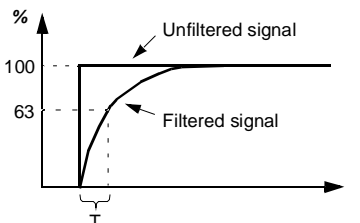
No.	Name/Value	Description	Def/FbEq16
	Temp sensor 2 excitation	The output is used to feed an excitation current to the temperature sensor 2, see parameter 35.21 Temperature 2 source . See also section Programmable protection functions (page 227).	21
	Reserved		21...25
	Abs motor speed used	01.61 Abs motor speed used (page 386).	26
	Abs motor speed %	01.62 Abs motor speed % (page 364).	27
	Abs output frequency	01.63 Abs output frequency (page 364).	28
	Reserved		29
	Abs motor torque	01.64 Abs motor torque (page 364).	30
	Abs output power	01.65 Abs output power (page 364).	31
	Abs motor shaft power	01.68 Abs motor shaft power (page 364).	32
	External PID1 out	71.01 External PID act value (page 572).	33
	Reserved		34...36
	AO1 data storage	13.91 AO1 data storage (page 410).	37
	AO2 data storage	13.92 AO2 data storage (page 410).	38
	<i>Other</i>	Source selection (see Terms and abbreviations on page 358).	-
13.13	AO1 forced value	Forced value that can be used instead of the selected output signal. See parameter 13.02 AO force selection .	0.000 V
	0.000...22.000 mA / 0.000...11.000 V	Forced value for AO1.	1000 = 1 unit
13.15	AO1 unit selection	Selects the unit for readings and settings related to analog input AO1.	V
	V	Volts.	2
	mA	Milliamperes.	10
13.16	AO1 filter time	<p>Defines the filtering time constant for analog output AO1.</p>  <p>$O = I \times (1 - e^{-t/T})$</p> <p>I = filter input (step) O = filter output t = time T = filter time constant</p>	0.100 s
	0.000 ... 30.000 s	Filter time constant.	1000 = 1 s

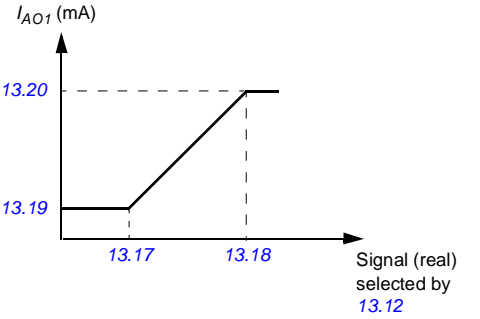
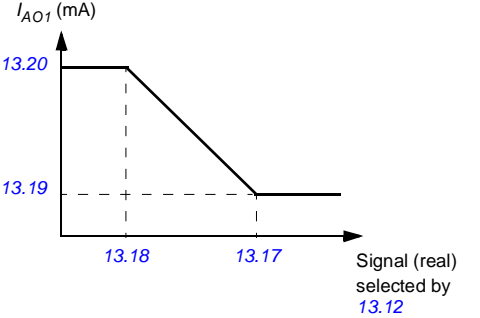
No.	Name/Value	Description	Def/FbEq16
13.17	AO1 source min	<p data-bbox="337 165 854 256">Defines the real minimum value of the signal (selected by parameter 13.12 AO1 source) that corresponds to the minimum required AO1 output value (defined by parameter 13.19 AO1 out at AO1 src min).</p>  <p data-bbox="337 639 854 683">Programming 13.17 as the maximum value and 13.18 as the minimum value inverts the output.</p> 	0.0

No.	Name/Value	Description	Def/FbEq16
AO has automatic scaling. Every time the source for the AO is changed, the scaling range is changed accordingly. User given minimum and maximum values override the automatic values.			
	13.12 AO1 source, 13.22 AO2 source	13.17 AO1 source min, 13.27 AO2 source min	13.18 AO1 source max, 13.28 AO2 source max
0	Zero	N/A (Output is constant zero.)	
1	Motor speed used	0	46.01 Speed scaling
3	Output frequency	0	46.02 Frequency scaling
4	Motor current	0	Max. value of 30.17 Maximum current
5	Motor current % of motor nominal	0%	100%
6	Motor torque	0	46.03 Torque scaling
7	DC voltage	Min. value of 01.11 DC voltage	Max. value of 01.11 DC voltage
8	Output power	0	46.04 Power scaling
10	Speed ref ramp in	0	46.01 Speed scaling
11	Speed ref ramp out	0	46.01 Speed scaling
12	Speed ref used	0	46.01 Speed scaling
14	Freq ref used	0	46.02 Frequency scaling
16	Process PID out	Min. value of 40.01 Process PID output actual	Max. value of 40.01 Process PID output actual
20	Temp sensor 1 excitation	N/A (Analog output is not scaled; it is determined by the sensor's triggering voltage.)	
21	Temp sensor 2 excitation		
26	Abs motor speed used	0	46.01 Speed scaling
27	Abs motor speed %	0	46.01 Speed scaling
28	Abs output frequency	0	46.02 Frequency scaling
30	Abs motor torque	0	46.03 Torque scaling
31	Abs output power	0	46.04 Power scaling
32	Abs motor shaft power	0	46.04 Power scaling
33	External PID1 out	Min. value of 71.01 External PID act value	Max. value of 71.01 External PID act value
	Other	Min. value of the selected parameter	Max. value of the selected parameter
	-32768.0...32767.0	Real signal value corresponding to minimum AO1 output value.	1 = 1
13.18	AO1 source max	Defines the real maximum value of the signal (selected by parameter 13.12 AO1 source) that corresponds to the maximum required AO1 output value (defined by parameter 13.20 AO1 out at AO1 src max). See parameter 13.17 AO1 source min.	50.0; 60.0 (95.20 b0)
	-32768.0...32767.0	Real signal value corresponding to maximum AO1 output value.	1 = 1
13.19	AO1 out at AO1 src min	Defines the minimum output value for analog output AO1. See also drawing at parameter 13.17 AO1 source min.	0.000 V
	0.000...22.000 mA / 0.000...11.000 V	Minimum AO1 output value.	1000 = 1 unit

No.	Name/Value	Description	Def/FbEq16
13.20	<i>AO1 out at AO1 src max</i>	Defines the maximum output value for analog output AO1. See also drawing at parameter <i>13.17 AO1 source min</i> .	10.000 V
	0.000...22.000 mA / 0.000...11.000 V	Maximum AO1 output value.	1000 = 1 unit
13.21	<i>AO2 actual value</i>	Displays the value of AO2 in mA. This parameter is read-only.	-
	0.000 ... 22.000 mA	Value of AO2.	1000 = 1 mA
13.22	<i>AO2 source</i>	Selects a signal to be connected to analog output AO2. Alternatively, sets the output to excitation mode to feed a constant current to a temperature sensor. For the selections, see parameter <i>13.12 AO1 source</i> .	<i>Motor current</i>
13.23	<i>AO2 forced value</i>	Forced value that can be used instead of the selected output signal. See parameter <i>13.02 AO force selection</i> .	0.000 mA
	0.000 ... 22.000 mA	Forced value for AO2.	1000 = 1 mA
13.26	<i>AO2 filter time</i>	Defines the filtering time constant for analog output AO2. See parameter <i>13.16 AO1 filter time</i> .	0.100 s
	0.000 ... 30.000 s	Filter time constant.	1000 = 1 s

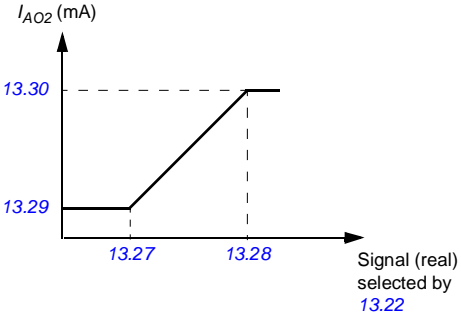
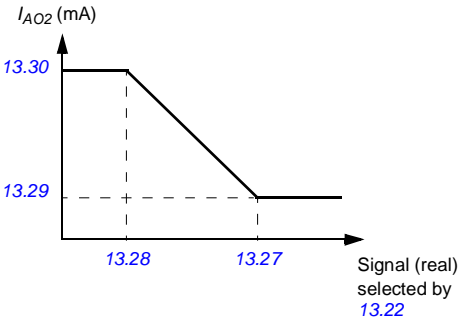
No.	Name/Value	Description	Def/FbEq16
13.27	<i>AO2 source min</i>	<p>Defines the real minimum value of the signal (selected by parameter 13.22 AO2 source) that corresponds to the minimum required AO2 output value (defined by parameter 13.29 AO2 out at AO2 src min). See parameter 13.17 AO1 source min about the AO automatic scaling.</p>  <p>Programming 13.27 as the maximum value and 13.28 as the minimum value inverts the output.</p> 	0.0
	-32768.0...32767.0	Real signal value corresponding to minimum AO2 output value.	1 = 1
13.28	<i>AO2 source max</i>	<p>Defines the real maximum value of the signal (selected by parameter 13.22 AO2 source) that corresponds to the maximum required AO2 output value (defined by parameter 13.30 AO2 out at AO2 src max). See parameter 13.27 AO2 source min. See parameter 13.17 AO1 source min about the AO automatic scaling.</p>	30000.0
	-32768.0...32767.0	Real signal value corresponding to maximum AO2 output value.	1 = 1
13.29	<i>AO2 out at AO2 src min</i>	Defines the minimum output value for analog output AO2. See also drawing at parameter 13.27 AO2 source min .	4.000 mA
	0.000 ... 22.000 mA	Minimum AO2 output value.	1000 = 1 mA

No.	Name/Value	Description	Def/FbEq16
13.30	<i>AO2 out at AO2 src max</i>	Defines the maximum output value for analog output AO2. See also drawing at parameter <i>13.27 AO2 source min</i> .	20.000 mA
	0.000 ... 22.000 mA	Maximum AO2 output value.	1000 = 1 mA
13.91	<i>AO1 data storage</i>	Storage parameter for controlling analog output AO1, for example, through the embedded fieldbus interface. In parameter <i>13.12 AO1 source</i> , select <i>AO1 data storage</i> . Then set this parameter as the target of the incoming value data. With the embedded fieldbus interface, simply set the target selection parameter of that particular data (<i>58.101...58.114</i>) to <i>AO1 data storage</i> .	0.00
	-327.68...327.67	Storage parameter for AO1.	100 = 1
13.92	<i>AO2 data storage</i>	Storage parameter for controlling analog output AO2, for example, through the embedded fieldbus interface. In parameter <i>13.22 AO2 source</i> , select <i>AO2 data storage</i> . Then set this parameter as the target of the incoming value data. With the embedded fieldbus interface, simply set the target selection parameter of that particular data (<i>58.101...58.114</i>) to <i>AO2 data storage</i> .	0.00
	-327.68...327.67	Storage parameter for AO2.	100 = 1
15 I/O extension module		Configuration of the I/O extension module installed in slot 2. See also section <i>Programmable I/O extensions</i> (page 117). Note: The contents of the parameter group vary according to the selected I/O extension module type.	
15.01	<i>Extension module type</i>	Activates (and specifies the type of) I/O extension module. If the extension module has been installed and the drive is powered (keeping all bits in <i>07.35 Drive configuration</i> and <i>07.36 Drive configuration 2</i> as 0), the drive automatically sets the value to the type it has detected in <i>15.02 Detected extension module</i> . Warning <i>A7AB Extension I/O configuration failure</i> is generated if <i>15.01 Extension module type</i> is not <i>None</i> and not matching with <i>15.02 Detected extension module</i> . In that case you will have to set the value of this parameter manually.	<i>None</i>
	None	Inactive.	0
	BREL-01	BREL relay extension module.	5
	BAPO-01	Auxiliary power extension module option BAPO-01.	6
15.02	<i>Detected extension module</i>	I/O extension module detected on the drive.	<i>None</i>
	None	Inactive.	0
	BREL-01	BREL relay extension module.	5
	BAPO-01	Auxiliary power extension module BAPO-01.	6

No.	Name/Value	Description	Def/FbEq16																								
15.04	<i>RO/DO status</i>	<p>Displays the status of the relay outputs RO4...RO7 and digital output DO1 on the extension module.</p> <p>Bits 0...3 indicates the status of RO4...RO7; bit 5 indicates the status of DO1.</p> <p>Example: 100101b = RO4 and RO7 are on, RO5 and R6 are off and DO1 is on.</p> <p>This parameter is read-only.</p>	-																								
<table border="1"> <thead> <tr> <th>Bit</th> <th>Name</th> <th>Description</th> </tr> </thead> <tbody> <tr> <td>0</td> <td>RO4</td> <td>1 = Relay output 4 is ON.</td> </tr> <tr> <td>1</td> <td>RO5</td> <td>1 = Relay output 5 is ON</td> </tr> <tr> <td>2</td> <td>RO6</td> <td>1 = Relay output 6 is ON</td> </tr> <tr> <td>3</td> <td>RO7</td> <td>1 = Relay output 7 is ON</td> </tr> <tr> <td>4</td> <td>Reserved</td> <td></td> </tr> <tr> <td>5</td> <td>DO1</td> <td>1 = Digital output 1 is ON.</td> </tr> <tr> <td>6...15</td> <td>Reserved</td> <td></td> </tr> </tbody> </table>				Bit	Name	Description	0	RO4	1 = Relay output 4 is ON.	1	RO5	1 = Relay output 5 is ON	2	RO6	1 = Relay output 6 is ON	3	RO7	1 = Relay output 7 is ON	4	Reserved		5	DO1	1 = Digital output 1 is ON.	6...15	Reserved	
Bit	Name	Description																									
0	RO4	1 = Relay output 4 is ON.																									
1	RO5	1 = Relay output 5 is ON																									
2	RO6	1 = Relay output 6 is ON																									
3	RO7	1 = Relay output 7 is ON																									
4	Reserved																										
5	DO1	1 = Digital output 1 is ON.																									
6...15	Reserved																										
0000h...FFFFh		Status of relay/digital outputs.	1 = 1																								
15.05	<i>RO/DO force selection</i>	<p>The electrical statuses of the relay/digital outputs can be overridden, for example, for testing purposes. A bit in parameter 15.06 RO/DO forced data is provided for each relay or digital output, and its value is applied whenever the corresponding bit in this parameter is 1.</p> <p>Note: Boot and power cycle reset the force selections (parameters 15.05 and 15.06).</p>	0000h																								
<table border="1"> <thead> <tr> <th>Bit</th> <th>Name</th> <th>Value</th> </tr> </thead> <tbody> <tr> <td>0</td> <td>RO4</td> <td>1 = Force RO4 to value of bit 0 of parameter 15.06 RO/DO forced data. (0 = Normal mode)</td> </tr> <tr> <td>1</td> <td>RO5</td> <td>1 = Force RO5 to value of bit 1 of parameter 15.06 RO/DO forced data. (0 = Normal mode)</td> </tr> <tr> <td>2</td> <td>RO6</td> <td>1 = Force RO6 to value of bit 2 of parameter 15.06 RO/DO forced data. (0 = Normal mode)</td> </tr> <tr> <td>3</td> <td>RO7</td> <td>1 = Force RO7 to value of bit 3 of parameter 15.06 RO/DO forced data. (0 = Normal mode)</td> </tr> <tr> <td>4</td> <td>Reserved</td> <td></td> </tr> <tr> <td>5</td> <td>DO1</td> <td>1 = Force DO1 to value of bit 5 of parameter 15.06 RO/DO forced data. (0 = Normal mode)</td> </tr> <tr> <td>6...15</td> <td>Reserved</td> <td></td> </tr> </tbody> </table>				Bit	Name	Value	0	RO4	1 = Force RO4 to value of bit 0 of parameter 15.06 RO/DO forced data . (0 = Normal mode)	1	RO5	1 = Force RO5 to value of bit 1 of parameter 15.06 RO/DO forced data . (0 = Normal mode)	2	RO6	1 = Force RO6 to value of bit 2 of parameter 15.06 RO/DO forced data . (0 = Normal mode)	3	RO7	1 = Force RO7 to value of bit 3 of parameter 15.06 RO/DO forced data . (0 = Normal mode)	4	Reserved		5	DO1	1 = Force DO1 to value of bit 5 of parameter 15.06 RO/DO forced data . (0 = Normal mode)	6...15	Reserved	
Bit	Name	Value																									
0	RO4	1 = Force RO4 to value of bit 0 of parameter 15.06 RO/DO forced data . (0 = Normal mode)																									
1	RO5	1 = Force RO5 to value of bit 1 of parameter 15.06 RO/DO forced data . (0 = Normal mode)																									
2	RO6	1 = Force RO6 to value of bit 2 of parameter 15.06 RO/DO forced data . (0 = Normal mode)																									
3	RO7	1 = Force RO7 to value of bit 3 of parameter 15.06 RO/DO forced data . (0 = Normal mode)																									
4	Reserved																										
5	DO1	1 = Force DO1 to value of bit 5 of parameter 15.06 RO/DO forced data . (0 = Normal mode)																									
6...15	Reserved																										
0000h...FFFFh		Override selection for relay/digital outputs.	1 = 1																								

No.	Name/Value	Description	Def/FbEq16																								
15.06	<i>RO/DO forced data</i>	Allows the data value of a forced relay or digital output to be changed from 0 to 1. It is only possible to force an output that has been selected in parameter 15.05 RO/DO force selection . Bits 0...1 are the forced values for RO4...RO5; bit 5 is the forced value for DO1.	0000h																								
<table border="1"> <thead> <tr> <th>Bit</th> <th>Name</th> <th>Description</th> </tr> </thead> <tbody> <tr> <td>0</td> <td>RO4</td> <td>1 = Force the value of this bit to RO4, if so defined in parameter 15.05 RO/DO force selection.</td> </tr> <tr> <td>1</td> <td>RO5</td> <td>1 = Force the value of this bit to RO5, if so defined in parameter 15.05 RO/DO force selection.</td> </tr> <tr> <td>2</td> <td>RO6</td> <td>1 = Force the value of this bit to RO6, if so defined in parameter 15.05 RO/DO force selection.</td> </tr> <tr> <td>3</td> <td>RO7</td> <td>1 = Force the value of this bit to RO7, if so defined in parameter 15.05 RO/DO force selection.</td> </tr> <tr> <td>4</td> <td>Reserved</td> <td></td> </tr> <tr> <td>5</td> <td>DO1</td> <td>1 = Force the value of this bit to DO1 if so defined in parameter 15.05 RO/DO force selection.</td> </tr> <tr> <td>6...15</td> <td>Reserved</td> <td></td> </tr> </tbody> </table>				Bit	Name	Description	0	RO4	1 = Force the value of this bit to RO4, if so defined in parameter 15.05 RO/DO force selection .	1	RO5	1 = Force the value of this bit to RO5, if so defined in parameter 15.05 RO/DO force selection .	2	RO6	1 = Force the value of this bit to RO6, if so defined in parameter 15.05 RO/DO force selection .	3	RO7	1 = Force the value of this bit to RO7, if so defined in parameter 15.05 RO/DO force selection .	4	Reserved		5	DO1	1 = Force the value of this bit to DO1 if so defined in parameter 15.05 RO/DO force selection .	6...15	Reserved	
Bit	Name	Description																									
0	RO4	1 = Force the value of this bit to RO4, if so defined in parameter 15.05 RO/DO force selection .																									
1	RO5	1 = Force the value of this bit to RO5, if so defined in parameter 15.05 RO/DO force selection .																									
2	RO6	1 = Force the value of this bit to RO6, if so defined in parameter 15.05 RO/DO force selection .																									
3	RO7	1 = Force the value of this bit to RO7, if so defined in parameter 15.05 RO/DO force selection .																									
4	Reserved																										
5	DO1	1 = Force the value of this bit to DO1 if so defined in parameter 15.05 RO/DO force selection .																									
6...15	Reserved																										
	0000h...FFFFh	Forced values of relay/digital outputs.	1 = 1																								
15.07	<i>RO4 source</i>	Selects a drive signal to be connected to relay output RO4.	<i>Not energized</i>																								
	Not energized	Output is not energized.	0																								
	Energized	Output is energized.	1																								
	Ready run	Bit 1 of 06.11 Main status word (see page 371).	2																								
	Reserved		3																								
	Enabled	Bit 0 of 06.16 Drive status word 1 (see page 372).	4																								
	Started	Bit 5 of 06.16 Drive status word 1 (see page 372).	5																								
	Magnetized	Bit 1 of 06.17 Drive status word 2 (see page 373).	6																								
	Running	Bit 6 of 06.16 Drive status word 1 (see page 372).	7																								
	Ready ref	Bit 2 of 06.11 Main status word (see page 371).	8																								
	At setpoint	Bit 8 of 06.11 Main status word (see page 371).	9																								
	Reverse	Bit 2 of 06.19 Speed control status word (see page 374).	10																								
	Zero speed	Bit 0 of 06.19 Speed control status word (see page 374).	11																								
	Above limit	Bit 10 of 06.17 Drive status word 2 (see page 373).	12																								
	Warning	Bit 7 of 06.11 Main status word (see page 371).	13																								
	Fault	Bit 3 of 06.11 Main status word (see page 371).	14																								
	Fault (-1)	Inverted bit 3 of 06.11 Main status word (see page 371).	15																								
	Fault/Warning	Bit 3 of 06.11 Main status word OR bit 7 of 06.11 Main status word (see page 371).	16																								
	Overcurrent	Fault 2310 Overcurrent has occurred.	17																								
	Overvoltage	Fault 3210 DC link overvoltage has occurred.	18																								
	Drive temp	Fault 2381 IGBT overload , 4110 Control board temperature , 4210 IGBT overtemperature , 4290 Cooling , 42F1 IGBT temperature , 4310 Excess temperature or 4380 Excess temperature difference has occurred.	19																								

No.	Name/Value	Description	Def/FbEq16
	Undervoltage	Fault 3220 DC link undervoltage has occurred.	20
	Motor temp	Fault 4981 External temperature 1 or 4982 External temperature 2 has occurred.	21
	Reserved		22
	Ext2 active	Bit 11 of 06.16 Drive status word 1 (see page 372).	23
	Remote control	Bit 9 of 06.11 Main status word (see page 371).	24
	Reserved		25...26
	Timed function 1	Bit 0 of 34.01 Timed functions status (see page 496).	27
	Timed function 2	Bit 1 of 34.01 Timed functions status (see page 496).	28
	Timed function 3	Bit 2 of 34.01 Timed functions status (see page 496).	29
	Reserved		30...32
	Supervision 1	Bit 0 of 32.01 Supervision status (see page 485).	33
	Supervision 2	Bit 1 of 32.01 Supervision status (see page 485).	34
	Supervision 3	Bit 2 of 32.01 Supervision status (see page 485).	35
	Reserved		36...38
	Start delay	Bit 13 of 06.17 Drive status word 2 (see page 373).	39
	RO/DIO control word bit0	Bit 0 of 10.99 RO/DIO control word (see page 389).	40
	RO/DIO control word bit1	Bit 1 of 10.99 RO/DIO control word (see page 389).	41
	RO/DIO control word bit2	Bit 2 of 10.99 RO/DIO control word (see page 389).	42
	Reserved		43...44
	PFC1	Bit 0 of 76.01 PFC status (see page 575).	45
	PFC2	Bit 1 of 76.01 PFC status (see page 575).	46
	PFC3	Bit 2 of 76.01 PFC status (see page 575).	47
	PFC4	Bit 3 of 76.01 PFC status (see page 575).	48
	PFC5	Bit 4 of 76.01 PFC status (see page 575). See parameter 76.01 .	49
	PFC6	Bit 5 of 76.01 PFC status (see page 575). See parameter 76.01 .	50
	Reserved		51...52
	Event word 1	Event word 1 = 1 if any bit of 04.40 Event word 1 (see page 366) is 1, that is, if any warning, fault or pure event that has been defined with parameters 04.41...04.71 is on.	53
	Damper control	See the diagram on page 386 .	54
	Run permissive	Bit 7 of 06.22 HVAC status word .	55
	Start interlock 1	Bit 8 of 06.22 HVAC status word .	56
	Start interlock 2	Bit 9 of 06.22 HVAC status word .	57
	Start interlock 3	Bit 10 of 06.22 HVAC status word .	58
	Start interlock 4	Bit 11 of 06.22 HVAC status word .	59
	All start interlocks	Bit 12 of 06.22 HVAC status word .	60
	User load curve	Bit 3 (Outside load limit) of 37.01 ULC output status word (see page 517).	61

No.	Name/Value	Description	Def/FbEq16
	RO/DIO control word	For 15.07 RO4 source : Bit 3 (RO4) of 10.99 RO/DIO control word (see page 389). For 15.10 RO5 source : Bit 4 (RO5) of 10.99 RO/DIO control word (see page 389). For 15.13 RO6 source : Bit 5 (RO6) of 10.99 RO/DIO control word (see page 389). For 15.16 RO7 source : Bit 6 (RO7) of 10.99 RO/DIO control word (see page 389).	62
	<i>Other [bit]</i>	Source selection (see Terms and abbreviations on page 358).	-
15.08	RO4 ON delay	Defines the activation delay for relay output RO4.	0.0 s
<p>$t_{on} = 15.08 \text{ RO4 ON delay}$ $t_{off} = 15.09 \text{ RO4 OFF delay}$</p>			
	0.0 ... 3000.0 s	Activation delay for RO4.	1 = 1 s
15.09	RO4 OFF delay	Defines the deactivation delay for relay output RO4. See parameter 15.08 RO4 ON delay .	0.0 s
	0.0 ... 3000.0 s	Deactivation delay for RO4.	1 = 1 s
15.10	RO5 source	Selects a drive signal to be connected to relay output RO5. For the available selections, see parameter 15.07 RO4 source .	<i>Not energized</i>
15.11	RO5 ON delay	Defines the activation delay for relay output RO5.	0.0 s
<p>$t_{on} = 15.11 \text{ RO5 ON delay}$ $t_{off} = 15.12 \text{ RO5 OFF delay}$</p>			
	0.0 ... 3000.0 s	Activation delay for RO5.	1 = 1 s
15.12	RO5 OFF delay	Defines the deactivation delay for relay output RO5. See parameter 15.11 RO5 ON delay .	0.0 s
	0.0 ... 3000.0 s	Deactivation delay for RO5.	1 = 1 s
15.13	RO6 source	Selects a drive signal to be connected to relay output RO6. For the available selections, see parameter 15.07 RO4 source .	<i>Not energized</i>

No.	Name/Value	Description	Def/FbEq16
15.14	<i>RO6 ON delay</i>	Defines the activation delay for relay output RO6.	0.0 s
<p>$t_{On} = 15.14$ RO6 ON delay $t_{Off} = 15.15$ RO6 OFF delay</p>			
	0.0 ... 3000.0 s	Activation delay for RO6.	10 = 1 s
15.15	<i>RO6 OFF delay</i>	Defines the deactivation delay for relay output RO6. See parameter 15.15 RO6 ON delay .	0.0 s
	0.0 ... 3000.0 s	Deactivation delay for RO6.	10 = 1 s
15.16	<i>RO7 source</i>	Selects a drive signal to be connected to relay output RO7. For the available selections, see parameter 15.07 RO4 source .	<i>Not energized</i>
15.17	<i>RO7 ON delay</i>	Defines the activation delay for relay output RO7.	0.0 s
<p>$t_{On} = 15.17$ RO7 ON delay $t_{Off} = 15.18$ RO7 OFF delay</p>			
	0.0 ... 3000.0 s	Activation delay for RO7.	10 = 1 s
15.18	<i>RO7 OFF delay</i>	Defines the deactivation delay for relay output RO7. See parameter 15.17 RO7 ON delay .	0.0 s
	0.0 ... 3000.0 s	Deactivation delay for RO7.	10 = 1 s
15.22	<i>DO1 configuration</i>	Selects how DO1 is used.	<i>Digital output</i>
	Digital output	DO1 is used as a digital output.	0
	Frequency output	DO1 is used as a frequency output.	2
15.23	<i>DO1 source</i>	Selects a drive signal to be connected to digital output DO1 when 15.22 DO1 configuration is set to <i>Digital output</i> .	<i>Not energized</i>
	Not energized	Output is not energized.	0
	Energized	Output is energized.	1
	Ready run	Bit 1 of 06.11 Main status word (see page 371).	2
	Reserved		3
	Enabled	Bit 0 of 06.16 Drive status word 1 (see page 372).	4
	Started	Bit 5 of 06.16 Drive status word 1 (see page 372).	5

No.	Name/Value	Description	Def/FbEq16
	Magnetized	Bit 1 of 06.17 Drive status word 2 (see page 373).	6
	Running	Bit 6 of 06.16 Drive status word 1 (see page 372).	7
	Ready ref	Bit 2 of 06.11 Main status word (see page 371).	8
	At setpoint	Bit 8 of 06.11 Main status word (see page 371).	9
	Reverse	Bit 2 of 06.19 Speed control status word (see page 374).	10
	Zero speed	Bit 0 of 06.19 Speed control status word (see page 374).	11
	Above limit	Bit 10 of 06.17 Drive status word 2 (see page 373).	12
	Warning	Bit 7 of 06.11 Main status word (see page 371).	13
	Fault	Bit 3 of 06.11 Main status word (see page 371).	14
	Fault (-1)	Inverted bit 3 of 06.11 Main status word (see page 371).	15
	Fault/Warning	Bit 3 of 06.11 Main status word OR bit 7 of 06.11 Main status word (see page 371).	16
	Overcurrent	Fault 2310 Overcurrent has occurred.	17
	Overvoltage	Fault 3210 DC link overvoltage has occurred.	18
	Drive temp	Fault 2381 IGBT overload , 4110 Control board temperature , 4210 IGBT overtemperature , 4290 Cooling , 42F1 IGBT temperature , 4310 Excess temperature or 4380 Excess temperature difference has occurred.	19
	Undervoltage	Fault 3220 DC link undervoltage has occurred.	20
	Motor temp	Fault 4981 External temperature 1 or 4982 External temperature 2 has occurred.	21
	Reserved		22
	Ext2 active	Bit 11 of 06.16 Drive status word 1 (see page 372).	23
	Remote control	Bit 9 of 06.11 Main status word (see page 371).	24
	Reserved		25...26
	Timed function 1	Bit 0 of 34.01 Timed functions status (see page 496).	27
	Timed function 2	Bit 1 of 34.01 Timed functions status (see page 496).	28
	Timed function 3	Bit 2 of 34.01 Timed functions status (see page 496).	29
	Reserved		30...32
	Supervision 1	Bit 0 of 32.01 Supervision status (see page 485).	33
	Supervision 2	Bit 1 of 32.01 Supervision status (see page 485).	34
	Supervision 3	Bit 2 of 32.01 Supervision status (see page 485).	35
	Reserved		36...38
	Start delay	Bit 13 of 06.17 Drive status word 2 (see page 373).	39
	RO/DIO control word bit0	Bit 0 of 10.99 RO/DIO control word (see page 389).	40
	RO/DIO control word bit1	Bit 1 of 10.99 RO/DIO control word (see page 389).	41
	RO/DIO control word bit2	Bit 2 of 10.99 RO/DIO control word (see page 389).	42
	PFC1	Bit 0 of 76.01 PFC status (see page 575).	45
	PFC2	Bit 1 of 76.01 PFC status (see page 575).	46
	PFC3	Bit 2 of 76.01 PFC status (see page 575).	47
	PFC4	Bit 3 of 76.01 PFC status (see page 575).	48

No.	Name/Value	Description	Def/FbEq16
	PFC5	Bit 4 of 76.01 PFC status (see page 575). See parameter 76.01 .	49
	PFC6	Bit 5 of 76.01 PFC status (see page 575). See parameter 76.01 .	50
	Reserved		51...52
	Event word 1	Event word 1 = 1 if any bit of 04.40 Event word 1 (see page 366) is 1, that is, if any warning, fault or pure event that has been defined with parameters 04.41...04.71 is on.	53
	Damper control	See the diagram on page 386 .	54
	Run permissive	Bit 7 of 06.22 HVAC status word .	55
	Start interlock 1	Bit 8 of 06.22 HVAC status word .	56
	Start interlock 2	Bit 9 of 06.22 HVAC status word .	57
	Start interlock 3	Bit 10 of 06.22 HVAC status word .	58
	Start interlock 4	Bit 11 of 06.22 HVAC status word .	59
	All start interlocks	Bit 12 of 06.22 HVAC status word .	60
	User load curve	Bit 3 (Outside load limit) of 37.01 ULC output status word (see page 517).	61
	RO/DIO control word	Bit 8 (DIO1) of 10.99 RO/DIO control word (see page 389).	62
	<i>Other [bit]</i>	Source selection (see Terms and abbreviations on page 358).	-
15.24	DO1 ON delay	Defines the activation delay for digital output DO1 when 15.22 DO1 configuration is set to Digital output .	0.0 s
<p> $t_{On} = \text{15.24 DO1 ON delay}$ $t_{Off} = \text{15.25 DO1 OFF delay}$ </p>			
	0.0 ... 3000.0 s	Activation delay for DO1.	1 = 1 s
15.25	DO1 OFF delay	Defines the deactivation delay for relay output DO1 when 15.22 DO1 configuration is set to Digital output . See parameter 15.24 DO1 ON delay .	0.0 s
	0.0 ... 3000.0 s	Deactivation delay for DO1.	1 = 1 s
15.32	Freq out 1 actual value	Displays the value of frequency output 1 at digital output DO1 when 15.22 DO1 configuration is set to Frequency output . This parameter is read-only.	-
	0 ... 16000 Hz	Value of frequency output 1.	1 = 1 Hz
15.33	Freq out 1 source	Selects a signal to be connected to digital output DO1 when 15.22 DO1 configuration is set to Frequency output . Alternatively, sets the output to excitation mode to feed a constant current to a temperature sensor.	Motor speed used
	Not selected	None.	0

No.	Name/Value	Description	Def/FbEq16
	Motor speed used	01.01 Motor speed used (page 361).	1
	Output frequency	01.06 Output frequency (page 361).	3
	Motor current	01.07 Motor current (page 361).	4
	Motor torque	01.10 Motor torque (page 361).	6
	DC voltage	01.11 DC voltage (page 361).	7
	Output power	01.14 Output power (page 362).	8
	Speed ref ramp in	23.01 Speed ref ramp input (page 449).	10
	Speed ref ramp out	23.02 Speed ref ramp output (page 449).	11
	Speed ref used	24.01 Used speed reference (page 452).	12
	Reserved		13
	Freq ref used	28.02 Frequency ref ramp output (page 457).	14
	Reserved		15
	Process PID out	40.01 Process PID output actual (page 521).	16
	<i>Other</i>	Source selection (see Terms and abbreviations on page 358).	-
15.34	<i>Freq out 1 src min</i>	<p>Defines the real value of the signal (selected by parameter 15.33 Freq out 1 source) that corresponds to the minimum value of frequency output 1 (defined by parameter 15.36 Freq out 1 at src min). This applies when 15.22 DO1 configuration is set to <i>Frequency output</i>.</p> <p>The figure contains two graphs. Both graphs have 'Signal (real) selected by par. 15.33' on the x-axis and 'Hz' on the y-axis. The top graph shows a horizontal line at 15.36 Hz from signal 15.34 to 15.35, followed by a linear ramp up to 15.37 Hz at signal 15.35, and then a horizontal line at 15.37 Hz. The bottom graph shows a horizontal line at 15.37 Hz from signal 15.35 to 15.34, followed by a linear ramp down to 15.36 Hz at signal 15.34, and then a horizontal line at 15.36 Hz.</p>	0.000
	-32768.000... 32767.000	Real signal value corresponding to minimum value of frequency output 1.	1 = 1

No.	Name/Value	Description	Def/FbEq16
15.35	<i>Freq out 1 src max</i>	Defines the real value of the signal (selected by parameter 15.33 Freq out 1 source) that corresponds to the maximum value of frequency output 1 (defined by parameter 15.37 Freq out 1 at src max). This applies when 15.22 DO1 configuration is set to <i>Frequency output</i> . See parameter 15.34 Freq out 1 src min .	1500.000; 1800.000 (95.20 b0)
	-32768.000... 32767.000	Real signal value corresponding to maximum value of frequency output 1.	1 = 1
15.36	<i>Freq out 1 at src min</i>	Defines the minimum output value of frequency output 1 when 15.22 DO1 configuration is set to <i>Frequency output</i> . See also drawing at parameter 15.34 Freq out 1 src min .	0 Hz
	0 ... 16000 Hz	Minimum frequency output 1 value.	1 = 1 Hz
15.37	<i>Freq out 1 at src max</i>	Defines the maximum value of frequency output 1 when 15.22 DO1 configuration is set to <i>Frequency output</i> . See also drawing at parameter 15.34 Freq out 1 src min .	16000 Hz
	0 ... 16000 Hz	Maximum value of frequency output 1.	1 = 1 Hz
	0000h...FFFFh	Bitmask	1 = 1

19 Operation mode		Selection of local and external control location sources and operating modes. See also section <i>Operating modes of the drive</i> (page 111).	
19.01	<i>Actual operation mode</i>	Displays the operating mode currently used. See parameter 19.11 . This parameter is read-only.	-
	Zero	None.	1
	Speed	Speed control (in vector motor control mode).	2
	Reserved		3...9
	Scalar (Hz)	Frequency control in scalar motor control mode (in scalar motor control mode).	10
	Forced magn.	Motor is in magnetizing mode.	20
19.11	<i>Ext1/Ext2 selection</i>	Selects the source for external control location EXT1/EXT2 selection. 0 = EXT1 1 = EXT2	<i>EXT1</i>
	EXT1	EXT1 (permanently selected).	0
	EXT2	EXT2 (permanently selected).	1
	FBA A MCW bit 11	Control word bit 11 received through fieldbus interface A.	2
	DI1	Digital input DI1 (10.02 DI delayed status , bit 0).	3
	DI2	Digital input DI2 (10.02 DI delayed status , bit 1).	4
	DI3	Digital input DI3 (10.02 DI delayed status , bit 2).	5
	DI4	Digital input DI4 (10.02 DI delayed status , bit 3).	6
	DI5	Digital input DI5 (10.02 DI delayed status , bit 4).	7
	DI6	Digital input DI6 (10.02 DI delayed status , bit 5).	8
	Reserved		9...18
	Timed function 1	Bit 0 of 34.01 Timed functions status (see page 496).	19
	Timed function 2	Bit 1 of 34.01 Timed functions status (see page 496).	20
	Timed function 3	Bit 2 of 34.01 Timed functions status (see page 496).	21

No.	Name/Value	Description	Def/FbEq16
	Reserved		22...24
	Supervision 1	Bit 0 of 32.01 Supervision status (see page 485).	25
	Supervision 2	Bit 1 of 32.01 Supervision status (see page 485).	26
	Supervision 3	Bit 2 of 32.01 Supervision status (see page 485).	27
	Reserved		28...31
	EFB MCW bit 11	Control word bit 11 received through the embedded fieldbus interface.	32
	FBA A connection loss	Detected communication loss of fieldbus interface A changes control mode to EXT2.	33
	EFB connection loss	Detected communication loss of embedded fieldbus interface changes control mode to EXT2.	35
	<i>Other [bit]</i>	Source selection (see Terms and abbreviations on page 358).	-
19.18	HAND/OFF disable source	Selects the source for Hand/Off disable. 1 = Hand and/or Off buttons are disabled on the control panel and in Drive composer PC tool. Parameter 19.19 HAND/OFF disable action specifies which buttons are disabled or enabled. If the HAND/OFF disable is activated while the drive is in the Hand mode, the mode will be automatically switched to Off and the motor stops, and the user must start the motor again.	<i>Not used</i>
	Not used	0 = Hand and/or Off buttons are enabled and operational.	0
	Active	1 = Hand and/or Off buttons are disabled and not operational.	1
	DI1	Digital input DI1 (10.02 DI delayed status , bit 0).	2
	DI2	Digital input DI2 (10.02 DI delayed status , bit 1).	3
	DI3	Digital input DI3 (10.02 DI delayed status , bit 2).	4
	DI4	Digital input DI4 (10.02 DI delayed status , bit 3).	5
	DI5	Digital input DI5 (10.02 DI delayed status , bit 4).	6
	DI6	Digital input DI6 (10.02 DI delayed status , bit 5).	7
	Comms	DCU profile control word bit 14 received through the embedded fieldbus interface. If a fieldbus adapter that supports transparent mode profiles is used, DCU control word bit 14 through the transparent mode profile is used.	8
	<i>Other [bit]</i>	Source selection (see Terms and abbreviations on page 358).	-
19.19	HAND/OFF disable action	Selects which buttons are disabled on the control panel and in the Drive composer PC tool when parameter 19.18 HAND/OFF disable source is disabled.	HAND
	HAND	Hand button disabled.	0
	OFF and HAND	Both Off and Hand buttons disabled.	1
	OFF when Auto	Off button is disabled when the drive is in the Auto mode. Off button is again enabled after the Hand button has been pressed.	2

No.	Name/Value	Description	Def/FbEq16																					
20	Start/stop/direction	Start/stop/direction and run/start enable signal source selection; positive/negative reference enable signal source selection. For information on control locations, see section Local control vs. external control (page 107).																						
20.01	<i>Ext1 commands</i>	Selects the source of start, stop and direction commands for external control location 1 (EXT1). See parameter 20.21 for the determination of the actual direction. See also parameters 20.02...20.05.	<i>In1 Start</i>																					
	Not selected	No start or stop command sources selected.	0																					
	In1 Start	The source of the start and stop commands is selected by parameter 20.03 <i>Ext1 in1 source</i> . The state transitions of the source bits are interpreted as follows: <table border="1" data-bbox="393 520 740 627"> <thead> <tr> <th>State of source 1 (20.03)</th> <th>Command</th> </tr> </thead> <tbody> <tr> <td>0 -> 1 (20.02 = Edge)</td> <td>Start</td> </tr> <tr> <td>1 (20.02 = Level)</td> <td>Stop</td> </tr> <tr> <td>0</td> <td>Stop</td> </tr> </tbody> </table>	State of source 1 (20.03)	Command	0 -> 1 (20.02 = Edge)	Start	1 (20.02 = Level)	Stop	0	Stop	1													
State of source 1 (20.03)	Command																							
0 -> 1 (20.02 = Edge)	Start																							
1 (20.02 = Level)	Stop																							
0	Stop																							
	In1 Start; In2 Dir	The source selected by 20.03 <i>Ext1 in1 source</i> is the start signal; the source selected by 20.04 <i>Ext1 in2 source</i> determines the direction. The state transitions of the source bits are interpreted as follows: <table border="1" data-bbox="393 756 900 887"> <thead> <tr> <th>State of source 1 (20.03)</th> <th>State of source 2 (20.04)</th> <th>Command</th> </tr> </thead> <tbody> <tr> <td>0</td> <td>Any</td> <td>Stop</td> </tr> <tr> <td>0 -> 1 (20.02 = Edge)</td> <td>0</td> <td>Start forward</td> </tr> <tr> <td>1 (20.02 = Level)</td> <td>1</td> <td>Start reverse</td> </tr> </tbody> </table>	State of source 1 (20.03)	State of source 2 (20.04)	Command	0	Any	Stop	0 -> 1 (20.02 = Edge)	0	Start forward	1 (20.02 = Level)	1	Start reverse	2									
State of source 1 (20.03)	State of source 2 (20.04)	Command																						
0	Any	Stop																						
0 -> 1 (20.02 = Edge)	0	Start forward																						
1 (20.02 = Level)	1	Start reverse																						
	In1 Start fwd; In2 Start rev	The source selected by 20.03 <i>Ext1 in1 source</i> is the forward start signal; the source selected by 20.04 <i>Ext1 in2 source</i> is the reverse start signal. The state transitions of the source bits are interpreted as follows: <table border="1" data-bbox="393 1018 900 1222"> <thead> <tr> <th>State of source 1 (20.03)</th> <th>State of source 2 (20.04)</th> <th>Command</th> </tr> </thead> <tbody> <tr> <td>0</td> <td>0</td> <td>Stop</td> </tr> <tr> <td>0 -> 1 (20.02 = Edge)</td> <td>0</td> <td>Start forward</td> </tr> <tr> <td>1 (20.02 = Level)</td> <td>0</td> <td>Start forward</td> </tr> <tr> <td>0</td> <td>0 -> 1 (20.02 = Edge)</td> <td>Start reverse</td> </tr> <tr> <td>1</td> <td>1 (20.02 = Level)</td> <td>Start reverse</td> </tr> <tr> <td>1</td> <td>1</td> <td>Stop</td> </tr> </tbody> </table>	State of source 1 (20.03)	State of source 2 (20.04)	Command	0	0	Stop	0 -> 1 (20.02 = Edge)	0	Start forward	1 (20.02 = Level)	0	Start forward	0	0 -> 1 (20.02 = Edge)	Start reverse	1	1 (20.02 = Level)	Start reverse	1	1	Stop	3
State of source 1 (20.03)	State of source 2 (20.04)	Command																						
0	0	Stop																						
0 -> 1 (20.02 = Edge)	0	Start forward																						
1 (20.02 = Level)	0	Start forward																						
0	0 -> 1 (20.02 = Edge)	Start reverse																						
1	1 (20.02 = Level)	Start reverse																						
1	1	Stop																						

No.	Name/Value	Description	Def/FbEq16																
	In1P Start; In2 Stop	<p>The sources of the start and stop commands are selected by parameters 20.03 Ext1 in1 source and 20.04 Ext1 in2 source. The state transitions of the source bits are interpreted as follows:</p> <table border="1" data-bbox="340 276 845 379"> <thead> <tr> <th data-bbox="340 276 529 323">State of source 1 (20.03)</th> <th data-bbox="529 276 719 323">State of source 2 (20.04)</th> <th data-bbox="719 276 845 323">Command</th> </tr> </thead> <tbody> <tr> <td data-bbox="340 323 529 351">0 -> 1</td> <td data-bbox="529 323 719 351">1</td> <td data-bbox="719 323 845 351">Start</td> </tr> <tr> <td data-bbox="340 351 529 379">Any</td> <td data-bbox="529 351 719 379">0</td> <td data-bbox="719 351 845 379">Stop</td> </tr> </tbody> </table> <p>Notes:</p> <ul style="list-style-type: none"> Run permissive and Start interlock signals can be put ON before or after the start pulse has been given. Parameter 20.02 Ext1 start trigger type has an effect only at startup of the drive with this setting. If the start input is ON and 20.02 = Level (1) when the drive is powered up, the motor will start. 	State of source 1 (20.03)	State of source 2 (20.04)	Command	0 -> 1	1	Start	Any	0	Stop	4							
State of source 1 (20.03)	State of source 2 (20.04)	Command																	
0 -> 1	1	Start																	
Any	0	Stop																	
	In1P Start; In2 Stop; In3 Dir	<p>The sources of the start and stop commands are selected by parameters 20.03 Ext1 in1 source and 20.04 Ext1 in2 source. The source selected by 20.05 Ext1 in3 source determines the direction. The state transitions of the source bits are interpreted as follows:</p> <table border="1" data-bbox="340 686 845 836"> <thead> <tr> <th data-bbox="340 686 467 756">State of source 1 (20.03)</th> <th data-bbox="467 686 593 756">State of source 2 (20.04)</th> <th data-bbox="593 686 720 756">State of source 3 (20.05)</th> <th data-bbox="720 686 845 756">Command</th> </tr> </thead> <tbody> <tr> <td data-bbox="340 756 467 783">0 -> 1</td> <td data-bbox="467 756 593 783">1</td> <td data-bbox="593 756 720 783">0</td> <td data-bbox="720 756 845 783">Start forward</td> </tr> <tr> <td data-bbox="340 783 467 810">0 -> 1</td> <td data-bbox="467 783 593 810">1</td> <td data-bbox="593 783 720 810">1</td> <td data-bbox="720 783 845 810">Start reverse</td> </tr> <tr> <td data-bbox="340 810 467 836">Any</td> <td data-bbox="467 810 593 836">0</td> <td data-bbox="593 810 720 836">Any</td> <td data-bbox="720 810 845 836">Stop</td> </tr> </tbody> </table> <p>Notes:</p> <ul style="list-style-type: none"> Run permissive and Start interlock signals can be put ON before or after the start pulse has been given. Parameter 20.02 Ext1 start trigger type has an effect only at startup of the drive with this setting. If the start input is ON and 20.02 = Level (1) when the drive is powered up, the motor will start. 	State of source 1 (20.03)	State of source 2 (20.04)	State of source 3 (20.05)	Command	0 -> 1	1	0	Start forward	0 -> 1	1	1	Start reverse	Any	0	Any	Stop	5
State of source 1 (20.03)	State of source 2 (20.04)	State of source 3 (20.05)	Command																
0 -> 1	1	0	Start forward																
0 -> 1	1	1	Start reverse																
Any	0	Any	Stop																
	In1P Start fwd; In2P Start rev; In3 Stop	<p>The sources of the start and stop commands are selected by parameters 20.03 Ext1 in1 source, 20.04 Ext1 in2 source and 20.05 Ext1 in3 source. The source selected by 20.05 Ext1 in3 source determines the stop. The state transitions of the source bits are interpreted as follows:</p> <table border="1" data-bbox="340 1144 845 1294"> <thead> <tr> <th data-bbox="340 1144 467 1214">State of source 1 (20.03)</th> <th data-bbox="467 1144 593 1214">State of source 2 (20.04)</th> <th data-bbox="593 1144 720 1214">State of source 3 (20.05)</th> <th data-bbox="720 1144 845 1214">Command</th> </tr> </thead> <tbody> <tr> <td data-bbox="340 1214 467 1241">0 -> 1</td> <td data-bbox="467 1214 593 1241">Any</td> <td data-bbox="593 1214 720 1241">1</td> <td data-bbox="720 1214 845 1241">Start forward</td> </tr> <tr> <td data-bbox="340 1241 467 1268">Any</td> <td data-bbox="467 1241 593 1268">0 -> 1</td> <td data-bbox="593 1241 720 1268">1</td> <td data-bbox="720 1241 845 1268">Start reverse</td> </tr> <tr> <td data-bbox="340 1268 467 1294">Any</td> <td data-bbox="467 1268 593 1294">Any</td> <td data-bbox="593 1268 720 1294">0</td> <td data-bbox="720 1268 845 1294">Stop</td> </tr> </tbody> </table> <p>Notes:</p> <ul style="list-style-type: none"> Run permissive and Start interlock signals can be put ON before or after the start pulse has been given. Parameter 20.02 Ext1 start trigger type has no effect with this setting. 	State of source 1 (20.03)	State of source 2 (20.04)	State of source 3 (20.05)	Command	0 -> 1	Any	1	Start forward	Any	0 -> 1	1	Start reverse	Any	Any	0	Stop	6
State of source 1 (20.03)	State of source 2 (20.04)	State of source 3 (20.05)	Command																
0 -> 1	Any	1	Start forward																
Any	0 -> 1	1	Start reverse																
Any	Any	0	Stop																
	Reserved		7...10																

No.	Name/Value	Description	Def/FbEq16
	Control panel	The start and stop commands are taken from the control panel (or PC connected to the control panel connector).	11
	Fieldbus A	The start and stop commands are taken from fieldbus adapter A. Note: Set also 20.02 Ext1 start trigger type to <i>Level</i> .	12
	Reserved		13
	Embedded fieldbus	The start and stop commands are taken from the embedded fieldbus interface. Note: Set also 20.02 Ext1 start trigger type to <i>Level</i> .	14
20.02	Ext1 start trigger type	Defines whether the start signal for external control location EXT1 is edge-triggered or level-triggered. Note: If a pulse type start signal is selected, this parameter is only effective at drive startup. See the descriptions of the selections of parameter 20.01 Ext1 commands .	<i>Level</i>
	Edge	The start signal is edge-triggered.	0
	Level	The start signal is level-triggered.	1
20.03	Ext1 in1 source	Selects source 1 for parameter 20.01 Ext1 commands .	<i>DI1</i>
	Always off	0.	0
	Always on	1.	1
	DI1	Digital input DI1 (10.02 DI delayed status , bit 0).	2
	DI2	Digital input DI2 (10.02 DI delayed status , bit 1).	3
	DI3	Digital input DI3 (10.02 DI delayed status , bit 2).	4
	DI4	Digital input DI4 (10.02 DI delayed status , bit 3).	5
	DI5	Digital input DI5 (10.02 DI delayed status , bit 4).	6
	DI6	Digital input DI6 (10.02 DI delayed status , bit 5).	7
	Reserved		8...17
	Timed function 1	Bit 0 of 34.01 Timed functions status (see page 496).	18
	Timed function 2	Bit 1 of 34.01 Timed functions status (see page 496).	19
	Timed function 3	Bit 2 of 34.01 Timed functions status (see page 496).	20
	Reserved		21...23
	Supervision 1	Bit 0 of 32.01 Supervision status (see page 485).	24
	Supervision 2	Bit 1 of 32.01 Supervision status (see page 485).	25
	Supervision 3	Bit 2 of 32.01 Supervision status (see page 485).	26
	Reserved		27...39
	Constant speed	Bit 7 of 06.19 Speed control status word (see page 374).	40
	<i>Other [bit]</i>	Source selection (see Terms and abbreviations on page 358).	-
20.04	Ext1 in2 source	Selects source 2 for parameter 20.01 Ext1 commands . For the available selections, see parameter 20.03 Ext1 in1 source .	<i>Always off</i>
20.05	Ext1 in3 source	Selects source 3 for parameter 20.01 Ext1 commands . For the available selections, see parameter 20.03 Ext1 in1 source .	<i>Always off</i>

No.	Name/Value	Description	Def/FbEq16																		
20.06	Ext2 commands	Selects the source of start, stop and direction commands for external control location 2 (EXT2). See parameter 20.21 for the determination of the actual direction. See also parameters 20.07...20.10.	Not selected																		
	Not selected	No start or stop command sources selected.	0																		
	In1 Start	The source of the start and stop commands is selected by parameter 20.08 Ext2 in1 source. The state transitions of the source bits are interpreted as follows: <table border="1" data-bbox="341 387 688 491"> <thead> <tr> <th>State of source 1 (20.08)</th> <th>Command</th> </tr> </thead> <tbody> <tr> <td>0 -> 1 (20.07 = Edge)</td> <td>Start</td> </tr> <tr> <td>1 (20.07 = Level)</td> <td>Stop</td> </tr> </tbody> </table>	State of source 1 (20.08)	Command	0 -> 1 (20.07 = Edge)	Start	1 (20.07 = Level)	Stop	1												
State of source 1 (20.08)	Command																				
0 -> 1 (20.07 = Edge)	Start																				
1 (20.07 = Level)	Stop																				
	In1 Start; In2 Dir	The source selected by 20.08 Ext2 in1 source is the start signal; the source selected by 20.09 Ext2 in2 source determines the direction. The state transitions of the source bits are interpreted as follows: <table border="1" data-bbox="341 619 848 746"> <thead> <tr> <th>State of source 1 (20.08)</th> <th>State of source 2 (20.09)</th> <th>Command</th> </tr> </thead> <tbody> <tr> <td>0</td> <td>Any</td> <td>Stop</td> </tr> <tr> <td>0 -> 1 (20.07 = Edge)</td> <td>0</td> <td>Start forward</td> </tr> <tr> <td>1 (20.07 = Level)</td> <td>1</td> <td>Start reverse</td> </tr> </tbody> </table>	State of source 1 (20.08)	State of source 2 (20.09)	Command	0	Any	Stop	0 -> 1 (20.07 = Edge)	0	Start forward	1 (20.07 = Level)	1	Start reverse	2						
State of source 1 (20.08)	State of source 2 (20.09)	Command																			
0	Any	Stop																			
0 -> 1 (20.07 = Edge)	0	Start forward																			
1 (20.07 = Level)	1	Start reverse																			
	In1 Start fwd; In2 Start rev	The source selected by 20.08 Ext2 in1 source is the forward start signal; the source selected by 20.09 Ext2 in2 source is the reverse start signal. The state transitions of the source bits are interpreted as follows: <table border="1" data-bbox="341 874 848 1082"> <thead> <tr> <th>State of source 1 (20.08)</th> <th>State of source 2 (20.09)</th> <th>Command</th> </tr> </thead> <tbody> <tr> <td>0</td> <td>0</td> <td>Stop</td> </tr> <tr> <td>0 -> 1 (20.07 = Edge)</td> <td>0</td> <td>Start forward</td> </tr> <tr> <td>1 (20.07 = Level)</td> <td>0</td> <td>Start reverse</td> </tr> <tr> <td>0</td> <td>0 -> 1 (20.07 = Edge)</td> <td>Start reverse</td> </tr> <tr> <td>1</td> <td>1 (20.07 = Level)</td> <td>Stop</td> </tr> </tbody> </table>	State of source 1 (20.08)	State of source 2 (20.09)	Command	0	0	Stop	0 -> 1 (20.07 = Edge)	0	Start forward	1 (20.07 = Level)	0	Start reverse	0	0 -> 1 (20.07 = Edge)	Start reverse	1	1 (20.07 = Level)	Stop	3
State of source 1 (20.08)	State of source 2 (20.09)	Command																			
0	0	Stop																			
0 -> 1 (20.07 = Edge)	0	Start forward																			
1 (20.07 = Level)	0	Start reverse																			
0	0 -> 1 (20.07 = Edge)	Start reverse																			
1	1 (20.07 = Level)	Stop																			
	In1P Start; In2 Stop	The sources of the start and stop commands are selected by parameters 20.08 Ext2 in1 source and 20.09 Ext2 in2 source. The state transitions of the source bits are interpreted as follows: <table border="1" data-bbox="341 1209 848 1313"> <thead> <tr> <th>State of source 1 (20.08)</th> <th>State of source 2 (20.09)</th> <th>Command</th> </tr> </thead> <tbody> <tr> <td>0 -> 1</td> <td>1</td> <td>Start</td> </tr> <tr> <td>Any</td> <td>0</td> <td>Stop</td> </tr> </tbody> </table> Notes: <ul style="list-style-type: none"> Run permissive and Start interlock signals can be put ON before or after the start pulse has been given. Parameter 20.07 Ext2 start trigger type has an effect only at startup of the drive with this setting. If the start input is ON and 20.07 = Level (1) when the drive is powered up, the motor will start. 	State of source 1 (20.08)	State of source 2 (20.09)	Command	0 -> 1	1	Start	Any	0	Stop	4									
State of source 1 (20.08)	State of source 2 (20.09)	Command																			
0 -> 1	1	Start																			
Any	0	Stop																			

No.	Name/Value	Description	Def/FbEq16																
	In1P Start; In2 Stop; In3 Dir	<p>The sources of the start and stop commands are selected by parameters 20.08 Ext2 in1 source and 20.09 Ext2 in2 source. The source selected by 20.10 Ext2 in3 source determines the direction. The state transitions of the source bits are interpreted as follows:</p> <table border="1"> <thead> <tr> <th>State of source 1 (20.08)</th> <th>State of source 2 (20.09)</th> <th>State of source 3 (20.10)</th> <th>Command</th> </tr> </thead> <tbody> <tr> <td>0 -> 1</td> <td>1</td> <td>0</td> <td>Start forward</td> </tr> <tr> <td>0 -> 1</td> <td>1</td> <td>1</td> <td>Start reverse</td> </tr> <tr> <td>Any</td> <td>0</td> <td>Any</td> <td>Stop</td> </tr> </tbody> </table> <p>Notes:</p> <ul style="list-style-type: none"> Run permissive and Start interlock signals can be put ON before or after the start pulse has been given. Parameter 20.07 Ext2 start trigger type has an effect only at startup of the drive with this setting. If the start input is ON and 20.07 = Level (1) when the drive is powered up, the motor will start. 	State of source 1 (20.08)	State of source 2 (20.09)	State of source 3 (20.10)	Command	0 -> 1	1	0	Start forward	0 -> 1	1	1	Start reverse	Any	0	Any	Stop	5
State of source 1 (20.08)	State of source 2 (20.09)	State of source 3 (20.10)	Command																
0 -> 1	1	0	Start forward																
0 -> 1	1	1	Start reverse																
Any	0	Any	Stop																
	In1P Start fwd; In2P Start rev; In3 Stop	<p>The sources of the start and stop commands are selected by parameters 20.08 Ext2 in1 source, 20.09 Ext2 in2 source and 20.10 Ext2 in3 source. The source selected by 20.10 Ext2 in3 source determines the direction. The state transitions of the source bits are interpreted as follows:</p> <table border="1"> <thead> <tr> <th>State of source 1 (20.08)</th> <th>State of source 2 (20.09)</th> <th>State of source 3 (20.10)</th> <th>Command</th> </tr> </thead> <tbody> <tr> <td>0 -> 1</td> <td>Any</td> <td>1</td> <td>Start forward</td> </tr> <tr> <td>Any</td> <td>0 -> 1</td> <td>1</td> <td>Start reverse</td> </tr> <tr> <td>Any</td> <td>Any</td> <td>0</td> <td>Stop</td> </tr> </tbody> </table> <p>Notes:</p> <ul style="list-style-type: none"> Run permissive and Start interlock signals can be put ON before or after the start pulse has been given. Parameter 20.07 Ext2 start trigger type has no effect with this setting. 	State of source 1 (20.08)	State of source 2 (20.09)	State of source 3 (20.10)	Command	0 -> 1	Any	1	Start forward	Any	0 -> 1	1	Start reverse	Any	Any	0	Stop	6
State of source 1 (20.08)	State of source 2 (20.09)	State of source 3 (20.10)	Command																
0 -> 1	Any	1	Start forward																
Any	0 -> 1	1	Start reverse																
Any	Any	0	Stop																
	Reserved		7...10																
	Control panel	The start and stop commands are taken from the control panel (or PC connected to the control panel connector).	11																
	Fieldbus A	The start and stop commands are taken from fieldbus adapter A. Note: Set also 20.07 Ext2 start trigger type to <i>Level</i> .	12																
	Reserved		13																
	Embedded fieldbus	The start and stop commands are taken from the embedded fieldbus interface. Note: Set also 20.07 Ext2 start trigger type to <i>Level</i> .	14																
20.07	Ext2 start trigger type	Defines whether the start signal for external control location EXT2 is edge-triggered or level-triggered. Note: If a pulse type start signal is selected, this parameter is only effective at drive startup. See the descriptions of the selections of parameter 20.06 Ext2 commands .	<i>Level</i>																
	Edge	The start signal is edge-triggered.	0																

No.	Name/Value	Description	Def/FbEq16
	Level	The start signal is level-triggered.	1
20.08	<i>Ext2 in1 source</i>	Selects source 1 for parameter <i>20.06 Ext2 commands</i> . For the available selections, see parameter <i>20.03 Ext1 in1 source</i> .	<i>Always off</i>
20.09	<i>Ext2 in2 source</i>	Selects source 2 for parameter <i>20.06 Ext2 commands</i> . For the available selections, see parameter <i>20.03 Ext1 in1 source</i> .	<i>Always off</i>
20.10	<i>Ext2 in3 source</i>	Selects source 3 for parameter <i>20.06 Ext2 commands</i> . For the available selections, see parameter <i>20.03 Ext1 in1 source</i> .	<i>Always off</i>
20.21	<i>Direction</i>	Reference direction lock. Defines the direction of the drive rather than the sign of the reference, except in some cases. In the table the actual drive rotation is shown as a function of parameter <i>20.21 Direction</i> and Direction command (from parameter <i>20.01 Ext1 commands</i> or <i>20.06 Ext2 commands</i>). See control chain diagram <i>Direction lock</i> (page 379)	<i>Forward</i>

	Direction command = Forward	Direction command = Reverse	Direction command not defined
Par. <i>20.21 Direction = Forward</i>	Forward	Forward	Forward
Par. <i>20.21 Direction = Reverse</i>	Reverse	Reverse	Reverse
Par. <i>20.21 Direction = Request</i>	Forward, but <ul style="list-style-type: none"> If reference from Constant, Floating point control (Motor potentiometer), PID, Safe speed, Last or Panel reference, reference used as is. If reference from the network, reference used as is. 	Reverse, but <ul style="list-style-type: none"> If reference from Constant or PID, reference used as is. If reference from the network, Panel, Analog input, Floating point control (Motor potentiometer), Safe speed or Last reference, reference multiplied by -1. 	Forward

Request	In external control the direction is selected by a direction command (parameter <i>20.01 Ext1 commands</i> or <i>20.06 Ext2 commands</i>). If the reference comes from Constant (constant speeds/frequencies), Floating point control (Motor potentiometer), PID, Speed ref safe, Last speed reference or Panel reference, the reference is used as is. If the reference comes from a fieldbus: <ul style="list-style-type: none"> if the direction command is forward, the reference is used as is if the direction command is reverse, the reference is multiplied by -1. 	0
Forward	Motor rotates forward regardless of the sign of the external reference. (Negative reference values are replaced by zero. Positive reference values are used as is.)	1

No.	Name/Value	Description	Def/FbEq16												
	Reverse	Motor rotates reverse regardless of the sign of the external reference. (Negative reference values are replaced by zero. Positive reference values are multiplied by -1.)	2												
20.30	<i>Enable signal warning function</i>	Selects enable signal warnings to be suppressed. This parameter can be used to prevent these warnings from flooding the event log. Whenever a bit of this parameter is set to 1, the corresponding warning is suppressed.	0000h												
<table border="1"> <thead> <tr> <th>Bit</th> <th>Name</th> <th>Description</th> </tr> </thead> <tbody> <tr> <td>0</td> <td>Run permissive</td> <td>1 = Warning <i>AFED Run permissive</i> is suppressed.</td> </tr> <tr> <td>1</td> <td>Start interlocks</td> <td>1 = Following warnings are suppressed: <ul style="list-style-type: none"> • <i>AFEE Start interlock 1</i> • <i>AFEF Start interlock 2</i> • <i>AFF0 Start interlock 3</i> • <i>AFF1 Start interlock 4</i> </td> </tr> <tr> <td>3...15</td> <td>Reserved</td> <td></td> </tr> </tbody> </table>				Bit	Name	Description	0	Run permissive	1 = Warning <i>AFED Run permissive</i> is suppressed.	1	Start interlocks	1 = Following warnings are suppressed: <ul style="list-style-type: none"> • <i>AFEE Start interlock 1</i> • <i>AFEF Start interlock 2</i> • <i>AFF0 Start interlock 3</i> • <i>AFF1 Start interlock 4</i> 	3...15	Reserved	
Bit	Name	Description													
0	Run permissive	1 = Warning <i>AFED Run permissive</i> is suppressed.													
1	Start interlocks	1 = Following warnings are suppressed: <ul style="list-style-type: none"> • <i>AFEE Start interlock 1</i> • <i>AFEF Start interlock 2</i> • <i>AFF0 Start interlock 3</i> • <i>AFF1 Start interlock 4</i> 													
3...15	Reserved														
	0000h...FFFFh	Word for disabling enable signal warnings.	1 = 1												
20.40	<i>Run permissive</i>	Selects the source of the Run permissive signal. Value 0 of the source deactivates the Run permissive and prevents running. Value 1 of the source activates the Run permissive and permits running. Note: Removal of the Run permissive setting when the drive is running results in a Coast Stop condition.	<i>Not used</i>												
	Not used	0.	0												
	Not used	1.	1												
	DI1	Digital input DI1 (<i>10.02 DI delayed status</i> , bit 0).	2												
	DI2	Digital input DI2 (<i>10.02 DI delayed status</i> , bit 1).	3												
	DI3	Digital input DI3 (<i>10.02 DI delayed status</i> , bit 2).	4												
	DI4	Digital input DI4 (<i>10.02 DI delayed status</i> , bit 3).	5												
	DI5	Digital input DI5 (<i>10.02 DI delayed status</i> , bit 4).	6												
	DI6	Digital input DI6 (<i>10.02 DI delayed status</i> , bit 5).	7												
	-DI1	Digital input DI1 (<i>10.02 DI delayed status</i> , bit 0).	8												
	-DI2	Digital input DI2 (<i>10.02 DI delayed status</i> , bit 1).	9												
	-DI3	Digital input DI3 (<i>10.02 DI delayed status</i> , bit 2).	10												
	-DI4	Digital input DI4 (<i>10.02 DI delayed status</i> , bit 3).	11												
	-DI5	Digital input DI5 (<i>10.02 DI delayed status</i> , bit 4).	12												
	-DI6	Digital input DI6 (<i>10.02 DI delayed status</i> , bit 5).	13												
	Fieldbus adapter	Control word bit 3 received through the fieldbus interface.	14												
	Embedded fieldbus	ABB Drives profile: Control word bit 3 received through the embedded fieldbus interface DCU profile: Inverse of control word bit 6 received through the embedded fieldbus interface.	15												
	<i>Other [bit]</i>	Source selection (see <i>Terms and abbreviations</i> on page 358).	-												

No.	Name/Value	Description	Def/FbEq16
20.41	<i>Start interlock 1</i>	Selects the source of the Start interlock 1 signal. Value 0 of the source deactivates the Start interlock 1 signal and inhibits starting. Value 1 of the source activates the Start interlock 1 signal and allows starting. Note: Removal of the Start interlock setting when the drive is running results in the stopping method defined in parameter 20.45 Start interlock stop mode .	<i>DI4</i>
	Not used	0.	0
	Not used	1.	1
	DI1	Digital input DI1 (10.02 DI delayed status , bit 0).	2
	DI2	Digital input DI2 (10.02 DI delayed status , bit 1).	3
	DI3	Digital input DI3 (10.02 DI delayed status , bit 2).	4
	DI4	Digital input DI4 (10.02 DI delayed status , bit 3).	5
	DI5	Digital input DI5 (10.02 DI delayed status , bit 4).	6
	DI6	Digital input DI6 (10.02 DI delayed status , bit 5).	7
	-DI1	Digital input DI1 (10.02 DI delayed status , bit 0).	8
	-DI2	Digital input DI2 (10.02 DI delayed status , bit 1).	9
	-DI3	Digital input DI3 (10.02 DI delayed status , bit 2).	10
	-DI4	Digital input DI4 (10.02 DI delayed status , bit 3).	11
	-DI5	Digital input DI5 (10.02 DI delayed status , bit 4).	12
	-DI6	Digital input DI6 (10.02 DI delayed status , bit 5).	13
	Fieldbus adapter	This selection cannot be used to control Start interlock with ABB drives profile from the fieldbus adapter. Use <i>Other [bit]</i> and map to control word user bits. This selection is only available for 20.41 Start interlock 1 and 20.42 Start interlock 2 .	14
	Embedded fieldbus	Start interlock 1: DCU profile: Inverse of control word bit 18 received through the embedded fieldbus interface. Start interlock 2: Inverse of bit 19. This selection is only available for 20.41 Start interlock 1 and 20.42 Start interlock 2 .	15
	<i>Other [bit]</i>	Source selection (see Terms and abbreviations on page 358).	-
20.42	<i>Start interlock 2</i>	Selects the source of the Start interlock 2 signal. For the selections, see parameter 20.41 Start interlock 1 .	<i>Not used</i>
20.43	<i>Start interlock 3</i>	Selects the source of the Start interlock 3 signal. Start interlock 3 is not supported over the Fieldbus adapter or Embedded fieldbus. For the other selections than 14 and 15, see parameter 20.41 Start interlock 1 .	<i>Not used</i>
20.44	<i>Start interlock 4</i>	Selects the source of the Start interlock 4 signal. Start interlock 4 is not supported over the Fieldbus adapter or Embedded fieldbus. For the other selections than 14 and 15, see parameter 20.41 Start interlock 1 .	<i>Not used</i>
20.45	<i>Start interlock stop mode</i>	Follows motor stop mode selection, see parameter 21.03 Stop mode .	<i>Not used</i>
	Not used	Not in use.	0
	Coast	The motor coasts to a stop.	1

No.	Name/Value	Description	Def/FbEq16
	Ramp	Stop along the active deceleration ramp.	2
20.46	Run permissive text	Alternative alarm texts for the run permissive. There is also label text (free text) for the run permissive. The control panel display will display the text when the run permissive becomes unsatisfied. You edit the label text in Menu > Primary settings > Start, stop, reference > Interlocks/Permissives > Label text.	Run permissive
	Run permissive		0
	Damper end switch		1
	Valve opening		2
	Pre-lube cycle		3
	Interlock open		5
20.47	Start interlock 1 text	Alternative alarm texts for the start interlock 1. There is also label text (free text) for each start interlock. The control panel display will display that specific text when the interlock becomes unsatisfied. You edit the label text in Menu > Primary settings > Start, stop, reference > Interlocks/Permissives > Label text.	Start interlock 1
	Start interlock 1		0
	Vibration switch		1
	Firestat		2
	Freezestat		3
	Overpressure		4
	Vibration trip		5
	Smoke alarm		6
	Auxiliary open		7
	Low suction		8
	Low pressure		9
	Access door		10
	Pressure relief		11
	Motor disconnect open		12
	High static		13
	Safety option		14
	Interlock open		15
20.48	Start interlock 2 text	Alternative alarm texts for the start interlock 2. See parameter 20.47 Start interlock 1 text .	Start interlock 2
	Start interlock 2	For other selections, see parameter 20.47 Start interlock 1 text .	0
20.49	Start interlock 3 text	Alternative alarm texts for the start interlock 3. See parameter 20.47 Start interlock 1 text .	Start interlock 3
	Start interlock 3	For other selections, see parameter 20.47 Start interlock 1 text .	0
20.50	Start interlock 4 text	Alternative alarm texts for the start interlock 4. See parameter 20.47 Start interlock 1 text .	Start interlock 4
	Start interlock 4	For other selections, see parameter 20.47 Start interlock 1 text .	0

No.	Name/Value	Description	Def/FbEq16
20.51	<i>Start interlock condition</i>	Selects the condition for start interlock function. This parameter determines if the start command is needed before start interlock warnings are displayed.	<i>Start command ignored</i>
	Start command ignored	Start interlock warnings are displayed if the interlocks are missing.	0
	Start command required	Start command must be present before the start interlock warnings are displayed if the interlocks are missing.	1
21 Start/stop mode		Start and stop modes; emergency stop mode and signal source selection; DC magnetization settings.	
21.01	<i>Start mode</i>	Selects the motor start function for the vector motor control mode, ie, when <i>99.04 Motor control mode</i> is set to <i>Vector</i> . Notes: <ul style="list-style-type: none"> The start function for the scalar motor control mode is selected by parameter <i>21.19 Scalar start mode</i>. Starting into a rotating motor is not possible when DC magnetizing is selected (<i>Fast</i> or <i>Const time</i>). With permanent magnet motors, <i>Automatic</i> start mode must be used. This parameter cannot be changed while the drive is running. See also section <i>Start methods – DC magnetization</i> (page 198).	<i>Automatic</i>
	Fast	The drive pre-magnetizes the motor before start. The pre-magnetizing time is determined automatically, being typically 200 ms to 2 s depending on motor size. This mode should be selected if a high break-away torque is required.	0
	Const time	The drive pre-magnetizes the motor before start. The pre-magnetizing time is defined by parameter <i>21.02 Magnetization time</i> . This mode should be selected if constant pre-magnetizing time is required (for example, if the motor start must be synchronized with the release of a mechanical brake). This setting also guarantees the highest possible break-away torque when the pre-magnetizing time is set long enough.  WARNING! The drive will start after the set magnetizing time has passed even if motor magnetization is not completed. In applications where a full break-away torque is essential, ensure that the constant magnetizing time is long enough to allow generation of full magnetization and torque.	1
	Automatic	Automatic start guarantees optimal motor start in most cases. It includes the flying start function (starting into a rotating motor) and the automatic restart function. The drive motor control program identifies the flux as well as the mechanical state of the motor and starts the motor instantly under all conditions.	2

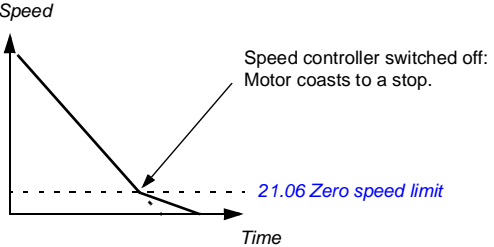
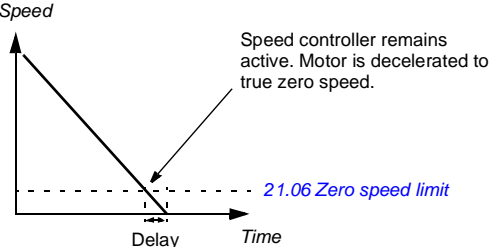

No.	Name/Value	Description	Def/FbEq16										
21.02	<i>Magnetization time</i>	<p>Defines the pre-magnetization time when</p> <ul style="list-style-type: none"> parameter <i>21.01 Start mode</i> is set to <i>Const time</i> (in vector motor control mode), or parameter <i>21.19 Scalar start mode</i> is set to <i>Const time</i> (in scalar motor control mode). <p>After the start command, the drive automatically premagnetizes the motor for the set time. To ensure full magnetizing, set this parameter to the same value as, or higher than, the rotor time constant. If not known, use the rule-of-thumb value given in the table below:</p> <table border="1"> <thead> <tr> <th>Motor rated power</th> <th>Constant magnetizing time</th> </tr> </thead> <tbody> <tr> <td>< 1 kW</td> <td>≥ 50 to 100 ms</td> </tr> <tr> <td>1 to 10 kW</td> <td>≥ 100 to 200 ms</td> </tr> <tr> <td>10 to 200 kW</td> <td>≥ 200 to 1000 ms</td> </tr> <tr> <td>200 to 1000 kW</td> <td>≥ 1000 to 2000 ms</td> </tr> </tbody> </table> <p>Note: This parameter cannot be changed while the drive is running.</p>	Motor rated power	Constant magnetizing time	< 1 kW	≥ 50 to 100 ms	1 to 10 kW	≥ 100 to 200 ms	10 to 200 kW	≥ 200 to 1000 ms	200 to 1000 kW	≥ 1000 to 2000 ms	500 ms
Motor rated power	Constant magnetizing time												
< 1 kW	≥ 50 to 100 ms												
1 to 10 kW	≥ 100 to 200 ms												
10 to 200 kW	≥ 200 to 1000 ms												
200 to 1000 kW	≥ 1000 to 2000 ms												
	0...10000 ms	Constant DC magnetizing time.	1 = 1 ms										
21.03	<i>Stop mode</i>	<p>Selects the way the motor is stopped when a stop command is received.</p> <p>Additional braking is possible by selecting flux braking (see parameter <i>97.05 Flux braking</i>).</p>	<i>Coast</i>										
	Coast	<p>Stop by switching off the output semiconductors of the drive. The motor coasts to a stop.</p> <p> WARNING! If a mechanical brake is used, ensure it is safe to stop the drive by coasting.</p>	0										
	Ramp	<p>Stop along the active deceleration ramp. See parameter group <i>23 Speed reference ramp</i> on page <i>449</i> or <i>28 Frequency reference chain</i> on page <i>457</i>.</p>	1										
	Torque limit	<p>Stop according to torque limits (parameters <i>30.19</i> and <i>30.20</i>). This mode is only possible in vector motor control mode.</p>	2										
21.04	<i>Emergency stop mode</i>	<p>Selects the way the motor is stopped when an emergency stop command is received.</p> <p>The source of the emergency stop signal is selected by parameter <i>21.05 Emergency stop source</i>.</p>	<i>Ramp stop (Off1)</i>										
	Ramp stop (Off1)	<p>With the drive running:</p> <ul style="list-style-type: none"> 1 = Normal operation. 0 = Normal stop along the standard deceleration ramp defined for the particular reference type. After the drive has stopped, it can be restarted by removing the emergency stop signal and switching the start signal from 0 to 1. <p>With the drive stopped:</p> <ul style="list-style-type: none"> 1 = Starting allowed. 0 = Starting not allowed. 	0										

No.	Name/Value	Description	Def/FbEq16
	Coast stop (Off2)	<p>With the drive running:</p> <ul style="list-style-type: none"> • 1 = Normal operation. • 0 = Stop by coasting. The drive can be restarted by restoring the start interlock signal and switching the start signal from 0 to 1. <p>With the drive stopped:</p> <ul style="list-style-type: none"> • 1 = Starting allowed. • 0 = Starting not allowed. 	1
	Eme ramp stop (Off3)	<p>With the drive running:</p> <ul style="list-style-type: none"> • 1 = Normal operation • 0 = Stop by ramping along emergency stop ramp defined by parameter 23.23 Emergency stop time. After the drive has stopped, it can be restarted by removing the emergency stop signal and switching the start signal from 0 to 1. <p>With the drive stopped:</p> <ul style="list-style-type: none"> • 1 = Starting allowed • 0 = Starting not allowed 	2
21.05	Emergency stop source	<p>Selects the source of the emergency stop signal. The stop mode is selected by parameter 21.04 Emergency stop mode.</p> <p>0 = Emergency stop active 1 = Normal operation</p> <p>Note: This parameter cannot be changed while the drive is running.</p>	<i>Inactive (true)</i>
	Active (false)	0.	0
	Inactive (true)	1.	1
	Reserved		2
	DI1	Digital input DI1 (10.02 DI delayed status , bit 0).	3
	DI2	Digital input DI2 (10.02 DI delayed status , bit 1).	4
	DI3	Digital input DI3 (10.02 DI delayed status , bit 2).	5
	DI4	Digital input DI4 (10.02 DI delayed status , bit 3).	6
	DI5	Digital input DI5 (10.02 DI delayed status , bit 4).	7
	DI6	Digital input DI6 (10.02 DI delayed status , bit 5).	8
	<i>Other [bit]</i>	Source selection (see Terms and abbreviations on page 358).	-
21.06	Zero speed limit	Defines the zero speed limit. The motor is stopped along a speed ramp (when ramped stop is selected or emergency stop time is used) until the defined zero speed limit is reached. After the zero speed delay, the motor coasts to a stop.	30.00 rpm
	0.00...30000.00 rpm	Zero speed limit.	See par. 46.01

No.	Name/Value	Description	Def/FbEq16
21.07	<i>Zero speed delay</i>	<p>Defines the delay for the zero speed delay function. The function is useful in applications where a smooth and quick restarting is essential. During the delay, the drive knows the rotor position accurately.</p> <p><u>Without zero speed delay:</u> The drive receives a stop command and decelerates along a ramp. When actual motor speed falls below the value of parameter <i>21.06 Zero speed limit</i>, inverter modulation is stopped and the motor coasts to a standstill.</p>  <p><u>With zero speed delay:</u> The drive receives a stop command and decelerates along a ramp. When actual motor speed falls below the value of parameter <i>21.06 Zero speed limit</i>, the zero speed delay function activates. During the delay the function keeps the speed controller live: the inverter modulates, motor is magnetized and the drive is ready for a quick restart.</p> 	0 ms
	0...30000 ms	Zero speed delay.	1 = 1 ms

No.	Name/Value	Description	Def/FbEq16															
21.08	<i>DC current control</i>	<p>Activates/deactivates the DC hold and post-magnetization functions. See section <i>Start methods – DC magnetization</i> (page 198).</p> <p>Note: DC magnetization causes the motor to heat up. In applications where long DC magnetization times are required, externally ventilated motors should be used. If the DC magnetization period is long, DC magnetization cannot prevent the motor shaft from rotating if a constant load is applied to the motor.</p>	0000b															
<table border="1"> <thead> <tr> <th>Bit</th> <th>Name</th> <th>Value</th> </tr> </thead> <tbody> <tr> <td>0</td> <td>DC hold</td> <td>1 = Enable DC hold. See section <i>DC hold</i> (page 199) Note: The DC hold function has no effect if the start signal is switched off.</td> </tr> <tr> <td>1</td> <td>Post magnetization</td> <td>1 = Enable post-magnetization. See section <i>Settings</i> (page 199). Note: Post-magnetization is only available when ramping is the selected stop mode (see parameter <i>21.03 Stop mode</i>).</td> </tr> <tr> <td>2</td> <td>DC brake</td> <td>1 = Enables DC injection braking after modulation has stopped. Notes: <ul style="list-style-type: none"> To enable DC brake, parameter <i>21.03 Stop mode</i> has to be set to <i>Coast</i>. DC braking current can be set with parameter <i>21.10 DC current reference</i>. DC braking time can be set with parameter <i>21.11 Post magnetization time</i>. </td> </tr> <tr> <td>3...15</td> <td>Reserved</td> <td></td> </tr> </tbody> </table>				Bit	Name	Value	0	DC hold	1 = Enable DC hold. See section <i>DC hold</i> (page 199) Note: The DC hold function has no effect if the start signal is switched off.	1	Post magnetization	1 = Enable post-magnetization. See section <i>Settings</i> (page 199). Note: Post-magnetization is only available when ramping is the selected stop mode (see parameter <i>21.03 Stop mode</i>).	2	DC brake	1 = Enables DC injection braking after modulation has stopped. Notes: <ul style="list-style-type: none"> To enable DC brake, parameter <i>21.03 Stop mode</i> has to be set to <i>Coast</i>. DC braking current can be set with parameter <i>21.10 DC current reference</i>. DC braking time can be set with parameter <i>21.11 Post magnetization time</i>. 	3...15	Reserved	
Bit	Name	Value																
0	DC hold	1 = Enable DC hold. See section <i>DC hold</i> (page 199) Note: The DC hold function has no effect if the start signal is switched off.																
1	Post magnetization	1 = Enable post-magnetization. See section <i>Settings</i> (page 199). Note: Post-magnetization is only available when ramping is the selected stop mode (see parameter <i>21.03 Stop mode</i>).																
2	DC brake	1 = Enables DC injection braking after modulation has stopped. Notes: <ul style="list-style-type: none"> To enable DC brake, parameter <i>21.03 Stop mode</i> has to be set to <i>Coast</i>. DC braking current can be set with parameter <i>21.10 DC current reference</i>. DC braking time can be set with parameter <i>21.11 Post magnetization time</i>. 																
3...15	Reserved																	
	0000h...0011h	DC magnetization selection.	1 = 1															
21.09	<i>DC hold speed</i>	Defines the DC hold speed in speed control mode. See parameter <i>21.08 DC current control</i> , and section <i>DC hold</i> (page 199).	5.00 rpm															
	0.00...1000.00 rpm	DC hold speed.	See par. <i>46.01</i>															
21.10	<i>DC current reference</i>	Defines the DC hold current in percent of the motor nominal current. See parameter <i>21.08 DC current control</i> , and section <i>Start methods – DC magnetization</i> (page 198). After 100 s post-magnetization time, the maximum magnetization current is limited to the magnetization current corresponding to the actual flux reference.	30.0%															
	0.0...100.0%	DC hold current.	1 = 1%															
21.11	<i>Post magnetization time</i>	Defines the length of time for which post-magnetization is active after stopping the motor. The magnetization current is defined by parameter <i>21.10 DC current reference</i> . See parameter <i>21.08 DC current control</i> .	0 s															
	0...3000 s	Post-magnetization time.	1 = 1 s															
21.14	<i>Pre-heating input source</i>	<p>Selects the source for controlling pre-heating for the motor. The status of the pre-heating is shown as bit 2 of <i>06.21 Drive status word 3</i>.</p> <p>Notes:</p> <ul style="list-style-type: none"> The heating function requires that STO is not triggered. The heating function requires that the drive is not faulted. 	<i>Off</i>															
	Off	0. Pre-heating is always deactivated.	0															
	On	1. Pre-heating is always activated when the drive is stopped.	1															
	DI1	Digital input DI1 (<i>10.02 DI delayed status</i> , bit 0).	2															

No.	Name/Value	Description	Def/FbEq16
	DI2	Digital input DI2 (<i>10.02 DI delayed status</i> , bit 1).	3
	DI3	Digital input DI3 (<i>10.02 DI delayed status</i> , bit 2).	4
	DI4	Digital input DI4 (<i>10.02 DI delayed status</i> , bit 3).	5
	DI5	Digital input DI5 (<i>10.02 DI delayed status</i> , bit 4).	6
	DI6	Digital input DI6 (<i>10.02 DI delayed status</i> , bit 5).	7
	Supervision 1	Bit 0 of <i>32.01 Supervision status</i> (see page 485).	8
	Supervision 2	Bit 1 of <i>32.01 Supervision status</i> (see page 485).	9
	Supervision 3	Bit 2 of <i>32.01 Supervision status</i> (see page 485).	10
	Timed function 1	Bit 0 of <i>34.01 Timed functions status</i> (see page 496).	11
	Timed function 2	Bit 1 of <i>34.01 Timed functions status</i> (see page 496).	12
	Timed function 3	Bit 2 of <i>34.01 Timed functions status</i> (see page 496).	13
	MCW user bit 0	Bit 12 of <i>06.01 Main control word</i> (see page 370).	16
	MCW user bit 1	Bit 13 of <i>06.01 Main control word</i> (see page 370).	17
	MCW user bit 2	Bit 14 of <i>06.01 Main control word</i> (see page 370).	18
	MCW user bit 3	Bit 15 of <i>06.01 Main control word</i> (see page 370).	19
	<i>Other [bit]</i>	Source selection (see <i>Terms and abbreviations</i> on page 358).	-
<i>21.15</i>	<i>Pre-heating time delay</i>	Time delay before pre-heating starts after the drive is stopped.	60 s
	10...3000 s	Pre-heating time delay.	1 = 1 s
<i>21.16</i>	<i>Pre-heating current</i>	Defines the DC current used to heat the motor. The value is in percent of the nominal motor current.	0.0%
	0.0...30.0%	Pre-heating current.	1 = 1%
<i>21.18</i>	<i>Auto restart time</i>	<p>The motor can be automatically started after a short supply power failure using the automatic restart function. See section <i>Automatic restart</i> (page 216)</p> <p>When this parameter is set to 0.0 seconds, automatic restarting is disabled. Otherwise, the parameter defines the maximum duration of the power failure after which restarting is attempted. Note that this time also includes the DC precharging delay. See also parameter <i>21.34 Force auto restart</i>.</p> <p>This parameter has effect only if parameter <i>95.04 Control board supply</i> is set to <i>External 24V</i>.</p> <p> WARNING! Before you activate the function, make sure that no dangerous situations can occur. The function restarts the drive automatically and continues operation after a supply break.</p>	10.0 s
	0.0 s	Automatic restarting disabled.	0
	0.1...10.0 s	Maximum power failure duration.	10 = 1 s

No.	Name/Value	Description	Def/FbEq16
21.19	Scalar start mode	<p>Selects the motor start function for the scalar motor control mode, ie, when <i>99.04 Motor control mode</i> is set to <i>Scalar</i>.</p> <p>Notes:</p> <ul style="list-style-type: none"> The start function for the vector motor control mode is selected by parameter <i>21.01 Start mode</i>. With permanent magnet motors, <i>Automatic</i> start mode must be used. This parameter cannot be changed while the drive is running. <p>See also section <i>Start methods – DC magnetization</i> (page 198).</p>	<i>Automatic</i>
	Normal	Immediate start from zero speed.	0
	Const time	<p>The drive pre-magnetizes the motor before start. The pre-magnetizing time is defined by parameter <i>21.02 Magnetization time</i>. This mode should be selected if constant pre-magnetizing time is required (for example, if the motor start must be synchronized with the release of a mechanical brake). This setting also guarantees the highest possible break-away torque when the pre-magnetizing time is set long enough.</p> <p>Note: This mode cannot be used to start into a rotating motor.</p> <p> WARNING! The drive will start after the set pre-magnetizing time has passed even if motor magnetization is not completed. In applications where a full break-away torque is essential, ensure that the constant magnetizing time is long enough to allow generation of full magnetization and torque.</p>	1
	Automatic	<p>The drive automatically selects the correct output frequency to start a rotating motor. This is useful for flying starts: if the motor is already rotating, the drive will start smoothly at the current frequency.</p> <p>Note: Cannot be used in multimotor systems.</p>	2
	Torque boost	<p>The drive pre-magnetizes the motor before the start. The pre-magnetizing time is defined by parameter <i>21.02 Magnetization time</i>.</p> <p>Torque boost is applied at start. Torque boost is stopped when output frequency exceeds 40% of nominal frequency or when it is equal to the reference value. See parameter <i>21.26 Torque boost current</i>.</p> <p>This mode should be selected if a high break-away torque is required.</p> <p>Note: This mode cannot be used to start into a rotating motor.</p> <p> WARNING! The drive will start after the set pre-magnetizing time has passed even if motor magnetization is not completed. In applications where a full break-away torque is essential, ensure that the constant magnetizing time is long enough to allow generation of full magnetization and torque.</p>	3
	Automatic+boost	<p>Automatic start with torque boost.</p> <p>Automatic start is performed first and the motor is magnetized. If the speed is found to be zero, torque boost is applied.</p>	4

No.	Name/Value	Description	Def/FbEq16
	Flying start	The drive automatically selects the correct output frequency to start a rotating motor. If the motor is already rotating, drive will start smoothly at the current frequency. – The mode will start the motor with vector control and switch to scalar control on the fly when the motor speed has been found. Compared to the Automatic start mode, Flying start detects the motor speed faster. Flying start requires more accurate information about motor model. Therefore standstill ID run is done automatically when the drive is started for the first time after selecting Flying start. Motor plate values should be accurate. Wrong plate values may decrease the starting performance	5
	Flying start+boost	Flying start with torque boost. Flying start is performed first and the motor is magnetized. If the speed is found to be zero, torque boost is applied.	6
21.21	<i>DC hold frequency</i>	Defines the DC hold frequency, which is used instead of parameter <i>21.09 DC hold speed</i> when the motor is in scalar frequency mode. See parameter <i>21.08 DC current control</i> , and section <i>DC hold</i> (page 199).	5.00 Hz
	0.00...1000.00 Hz	DC hold frequency.	1 = 1 Hz
21.22	<i>Start delay</i>	Defines the start delay. After the conditions for start have been fulfilled, the drive waits until the delay has elapsed and then starts the motor. During the delay, warning <i>AFE9 Start delay</i> is shown. Start delay can be used with all start modes.	0.00 s
	0.00...60.00 s	Start delay	1 = 1 s
21.23	<i>Smooth start</i>	Selects the forced current vector rotation mode at low speeds. When the smooth start mode is selected, the rate of acceleration is limited by the acceleration and deceleration ramp times. If the process driven by the permanent magnet synchronous motor has high inertia, slow ramp times are recommended. Can be used for permanent magnet synchronous motors only.	<i>Disabled</i>
	Disabled	Disabled.	0
	Enabled always	Enabled always.	1
	Start only	Enabled when starting the motor.	2
21.24	<i>Smooth start current</i>	Current used in the current vector rotation at low speeds. Increase the smooth start current if the application requires motor shaft swinging needs to be minimized. Note that accurate torque control is not possible in the current vector rotation mode. Can be used for permanent magnet synchronous motors only.	50.0%
	10.0...200.0%	Value in percent of the nominal motor current.	1 = 1%
21.25	<i>Smooth start speed</i>	Output frequency up to which the current vector rotation is used. See parameter <i>21.19 Scalar start mode</i> . Can be used for permanent magnet synchronous motors only.	10.0%
	2.0...100.0%	Value as a percentage of the nominal motor frequency.	1 = 1%

No.	Name/Value	Description	Def/FbEq16
21.26	<i>Torque boost current</i>	Defines the maximum supplied current to motor when (21.19 <i>Scalar start mode</i> is set to <i>Torque boost</i> (see page 436). Parameter value is in percent of the motor nominal current. Nominal value of the parameter is 100.0%. Torque boost is only applied at start, ending when output frequency exceeds 40% of nominal frequency or when output frequency is equal to reference. Can be used in scalar mode only.	100.0%
	15.0...300.0%	Value in percent of the nominal motor current.	1 = 1%
21.27	<i>Torque boost time</i>	Defines the minimum and maximum torque boost time. If torque boost time is less than 40% of frequency acceleration time (see parameters 28.72 and 28.74), then torque boost time is set at 40% of frequency acceleration time.	20 s
	0.0...60.0 s	Nominal motor time.	1 = 1 s
21.30	<i>Speed compensated stop mode</i>	Selects the method used to stop the drive. Speed compensated stop is active only if <ul style="list-style-type: none"> the operation mode is not torque, and parameter 21.03 <i>Stop mode</i> is <i>Ramp</i>. 	<i>Off</i>
	Off	Stop according parameter 21.03 <i>Stop mode</i> , no speed compensated stop.	0
	Speed comp FWD	If the direction of rotation is forward, speed compensation is used for constant distance braking. Speed difference (between used speed and maximum speed) is compensated by running the drive with current speed before the motor is stopped along a ramp. If the direction of rotation is reverse, the drive is stopped along a ramp.	1
	Speed comp REV	If the direction of rotation is reverse, speed compensation is used for constant distance braking. Speed difference (between used speed and maximum speed) is compensated by running the drive with current speed before the motor is stopped along a ramp. If the direction of rotation is forward, the drive is stopped along a ramp.	2
	Speed comp bipolar	Regardless of the direction of rotation, speed compensation is used for constant distance braking. Speed difference (between used speed and maximum speed) is compensated by running the drive with current speed before the motor is stopped along a ramp.	3
21.31	<i>Speed comp stop delay</i>	This delay adds distance to the total distance traveled during a stop from maximum speed. It is used to adjust the distance to match requirements so that the distance traveled is not solely determined by the deceleration rate.	0.00 s
	0.00...1000.00 s	Speed delay.	1 = 1 s
21.32	<i>Speed comp stop threshold</i>	This parameter sets a speed threshold below which the Speed compensated stop feature is disabled. In this speed region, the speed compensated stop is not attempted and the drive stops as it would, using the ramp option.	10%
	0...100%	Speed threshold as a percent of the motor nominal speed.	1 = 1%

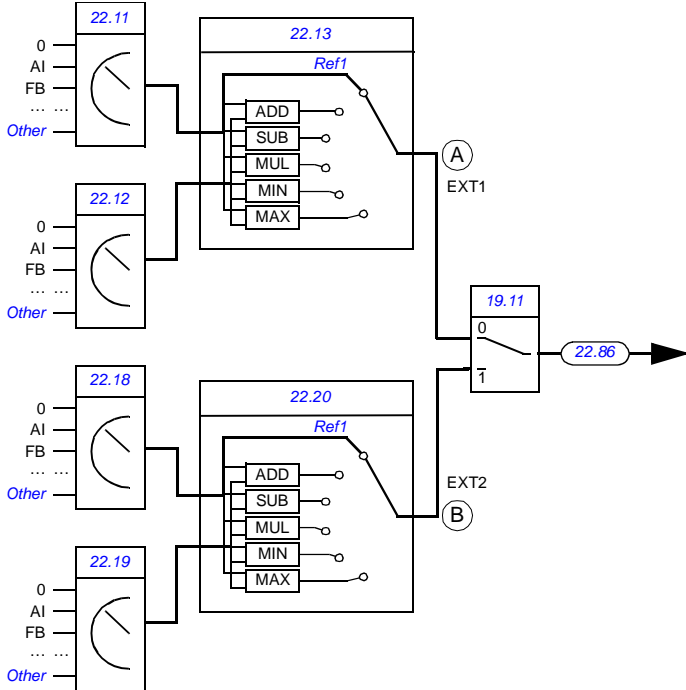

No.	Name/Value	Description	Def/FbEq16
21.34	<i>Force auto restart</i>	Forces automatic restart. The parameter is applicable only if parameter <i>95.04 Control board supply</i> is set to <i>External 24V</i> .	<i>Enable</i>
	Disable	Force auto restart disabled. Parameter <i>21.18 Auto restart time</i> is in effect if its value is more than 0.0 s.	0
	Enable	Force auto restart enabled. Parameter <i>21.18 Auto restart time</i> is ignored. The drive never trips on the undervoltage fault and the start signal is on forever. When the DC voltage is restored, the normal operation continues.	1
22 Speed reference selection		Speed reference selection; Floating point control (Motor potentiometer) settings. See control chain diagrams <i>Speed reference source selection I</i> (page 366)... <i>Speed controller</i> (page 371).	
22.01	<i>Speed ref unlimited</i>	Displays the output of the speed reference selection block. See control chain diagram <i>Speed reference source selection II</i> on page 367. This parameter is read-only.	-
	-30000.00... 30000.00 rpm	Value of the selected speed reference.	See par. <i>46.01</i>

No.	Name/Value	Description	Def/FbEq16
22.11	<i>Ext1 speed ref1</i>	<p>Selects EXT1 speed reference source 1.</p> <p>Two signal sources can be defined by this parameter and 22.12 Ext1 speed ref2. A mathematical function (22.13 Ext1 speed function) applied to the two signals creates an EXT1 reference (A in the figure below).</p> <p>A digital source selected by 19.11 Ext1/Ext2 selection can be used to switch between EXT1 reference and the corresponding EXT2 reference defined by parameters 22.18 Ext2 speed ref1, 22.19 Ext2 speed ref2 and 22.20 Ext2 speed function (B in the figure below).</p>	<i>AI1 scaled</i>

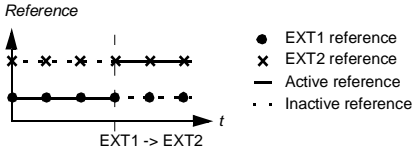
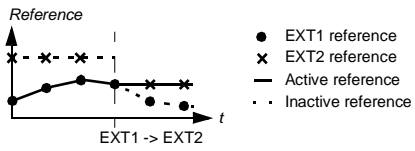

Zero	None.	0
AI1 scaled	12.12 AI1 scaled value (see page 400).	1
AI2 scaled	12.22 AI2 scaled value (see page 402).	2
Reserved		3
FB A ref1	03.05 FB A reference 1 (see page 364).	4
FB A ref2	03.06 FB A reference 2 (see page 364).	5
Reserved		6...7
EFB ref1	03.09 EFB reference 1 (see page 365).	8
EFB ref2	03.10 EFB reference 2 (see page 365).	9
Reserved		10...14

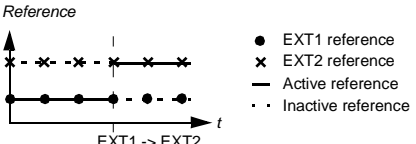
No.	Name/Value	Description	Def/FbEq16
	Motor potentiometer	22.80 Motor potentiometer ref act (output of the Motor potentiometer).	15
	PID	40.01 Process PID output actual (output of the process PID controller).	16
	Frequency input	11.38 Freq in 1 actual value (when DI5 is used as a frequency input).	17
	Control panel (ref saved)	Control panel reference (03.01 Panel reference , see page 364) saved by the control system for the location where the control returns is used as the reference. 	18
	Control panel (ref copied)	Control panel reference (03.01 Panel reference , see page 364) for the previous control location is used as the reference when the control location changes if the references for the two locations are of the same type (eg frequency/speed/torque/PID); otherwise, the actual signal is used as the new reference. 	19
	Reserved		20...22
	AI3 scaled	15.52 AI3 scaled value (see page 507).	23
	AI4 scaled	15.62 AI4 scaled value (see page 509).	24
	AI5 scaled	15.72 AI5 scaled value (see page 511).	25
	<i>Other</i>	Source selection (see Terms and abbreviations on page 358).	-
22.12	Ext1 speed ref2	Selects EXT1 speed reference source 2. For the available selections, and a diagram of reference source selection, see parameter 22.11 Ext1 speed ref1 .	<i>Zero</i>
22.13	Ext1 speed function	Selects a mathematical function between the reference sources selected by parameters 22.11 Ext1 speed ref1 and 22.12 Ext1 speed ref2 . See diagram at 22.11 Ext1 speed ref1 .	<i>Ref1</i>
	Ref1	Signal selected by 22.11 Ext1 speed ref1 is used as speed reference 1 as such (no function applied).	0
	Add (ref1 + ref2)	The sum of the reference sources is used as speed reference 1.	1
	Sub (ref1 - ref2)	The subtraction ([22.11 Ext1 speed ref1] - [22.12 Ext1 speed ref2]) of the reference sources is used as speed reference 1.	2
	Mul (ref1 × ref2)	The multiplication of the reference sources is used as speed reference 1.	3
	Min (ref1, ref2)	The smaller of the reference sources is used as speed reference 1.	4

No.	Name/Value	Description	Def/FbEq16
	Max (ref1, ref2)	The greater of the reference sources is used as speed reference 1.	5
22.18	Ext2 speed ref1	Selects EXT2 speed reference source 1. Two signal sources can be defined by this parameter and 22.19 Ext2 speed ref2. A mathematical function (22.20 Ext2 speed function) applied to the two signals creates an EXT2 reference. See diagram at 28.11 Ext1 frequency ref1.	Zero
	Zero	None.	0
	AI1 scaled	12.12 AI1 scaled value (see page 400).	1
	AI2 scaled	12.22 AI2 scaled value (see page 402).	2
	Reserved		3
	FB A ref1	03.05 FB A reference 1 (see page 364).	4
	FB A ref2	03.06 FB A reference 2 (see page 364).	5
	Reserved		6...7
	EFB ref1	03.09 EFB reference 1 (see page 365).	8
	EFB ref2	03.10 EFB reference 2 (see page 365).	9
	Reserved		10...14
	Motor potentiometer	22.80 Motor potentiometer ref act (output of the Floating point control (Motor potentiometer)).	15
	PID	40.01 Process PID output actual (output of the process PID controller).	16
	Frequency input	11.38 Freq in 1 actual value (when DI5 is used as a frequency input).	17
	Control panel (ref saved)	Control panel reference (03.01 Panel reference, see page 364) saved by the control system for the location where the control returns is used as the reference. 	18
	Control panel (ref copied)	Control panel reference (03.01 Panel reference, see page 364) for the previous control location is used as the reference when the control location changes if the references for the two locations are of the same type (eg frequency/speed/torque/PID); otherwise, the actual signal is used as the new reference. 	19
	Reserved		20...22
	AI3 scaled	15.52 AI3 scaled value (see page 507).	23
	AI4 scaled	15.62 AI4 scaled value (see page 509).	24
	AI5 scaled	15.72 AI5 scaled value (see page 511).	25

No.	Name/Value	Description	Def/FbEq16
	<i>Other</i>	Source selection (see Terms and abbreviations on page 358).	-
22.19	<i>Ext2 speed ref2</i>	Selects EXT2 speed reference source 2. For the selections, and a diagram of reference source selection, see parameter 22.18 Ext2 speed ref1 .	<i>Zero</i>
22.20	<i>Ext2 speed function</i>	Selects a mathematical function between the reference sources selected by parameters 22.18 Ext2 speed ref1 and 22.19 Ext2 speed ref2 . See diagram at 22.18 Ext2 speed ref1 .	<i>Ref1</i>
	Ref1	Signal selected by Ext2 speed ref1 is used as speed reference 1 as such (no function applied).	0
	Add (ref1 + ref2)	The sum of the reference sources is used as speed reference 1.	1
	Sub (ref1 - ref2)	The subtraction ([22.11 Ext1 speed ref1] - [22.12 Ext1 speed ref2]) of the reference sources is used as speed reference 1.	2
	Mul (ref1 x ref2)	The multiplication of the reference sources is used as speed reference 1.	3
	Min (ref1, ref2)	The smaller of the reference sources is used as speed reference 1.	4
	Max (ref1, ref2)	The greater of the reference sources is used as speed reference 1.	5
22.21	<i>Constant speed function</i>	Determines how constant speeds are selected, and whether the rotation direction signal is considered or not when applying a constant speed.	000b

Bit	Name	Information
0	Constant speed mode	1 = Packed: 7 constant speeds are selectable using the three sources defined by parameters 22.22 , 22.23 and 22.24 . 0 = Separate: Constant speeds 1, 2 and 3 are separately activated by the sources defined by parameters 22.22 , 22.23 and 22.24 respectively. In case of conflict, the constant speed with the smaller number takes priority.
1	Direction enable	1 = Start dir: To determine running direction for a constant speed, the sign of the constant speed setting (parameters 22.26...22.32) is multiplied by the direction signal (forward: +1, reverse: -1). This effectively allows the drive to have 14 (7 forward, 7 reverse) constant speeds if all values in 22.26...22.32 are positive.  WARNING: If the direction signal is reverse and the active constant speed is negative, the drive will run in the forward direction. 0 = According to Par: The running direction for the constant speed is determined by the sign of the constant speed setting (parameters 22.26...22.32).
2...15	Reserved	

0000h...FFFFh	Constant speed configuration word.	1 = 1
---------------	------------------------------------	-------

No.	Name/Value	Description	Def/FbEq16																																				
22.22	<i>Constant speed sel1</i>	When bit 0 of parameter <i>22.21 Constant speed function</i> is 0 (Separate), selects a source that activates constant speed 1. When bit 0 of parameter <i>22.21 Constant speed function</i> is 1 (Packed), this parameter and parameters <i>22.23 Constant speed sel2</i> and <i>22.24 Constant speed sel3</i> select three sources whose states activate constant speeds as follows:	<i>DI3</i>																																				
<table border="1"> <thead> <tr> <th>Source defined by par. 22.22</th> <th>Source defined by par. 22.23</th> <th>Source defined by par. 22.24</th> <th>Constant speed active</th> </tr> </thead> <tbody> <tr> <td>0</td> <td>0</td> <td>0</td> <td>None</td> </tr> <tr> <td>1</td> <td>0</td> <td>0</td> <td>Constant speed 1</td> </tr> <tr> <td>0</td> <td>1</td> <td>0</td> <td>Constant speed 2</td> </tr> <tr> <td>1</td> <td>1</td> <td>0</td> <td>Constant speed 3</td> </tr> <tr> <td>0</td> <td>0</td> <td>1</td> <td>Constant speed 4</td> </tr> <tr> <td>1</td> <td>0</td> <td>1</td> <td>Constant speed 5</td> </tr> <tr> <td>0</td> <td>1</td> <td>1</td> <td>Constant speed 6</td> </tr> <tr> <td>1</td> <td>1</td> <td>1</td> <td>Constant speed 7</td> </tr> </tbody> </table>				Source defined by par. 22.22	Source defined by par. 22.23	Source defined by par. 22.24	Constant speed active	0	0	0	None	1	0	0	Constant speed 1	0	1	0	Constant speed 2	1	1	0	Constant speed 3	0	0	1	Constant speed 4	1	0	1	Constant speed 5	0	1	1	Constant speed 6	1	1	1	Constant speed 7
Source defined by par. 22.22	Source defined by par. 22.23	Source defined by par. 22.24	Constant speed active																																				
0	0	0	None																																				
1	0	0	Constant speed 1																																				
0	1	0	Constant speed 2																																				
1	1	0	Constant speed 3																																				
0	0	1	Constant speed 4																																				
1	0	1	Constant speed 5																																				
0	1	1	Constant speed 6																																				
1	1	1	Constant speed 7																																				
	Always off	0.	0																																				
	Always on	1.	1																																				
	DI1	Digital input DI1 (<i>10.02 DI delayed status</i> , bit 0).	2																																				
	DI2	Digital input DI2 (<i>10.02 DI delayed status</i> , bit 1).	3																																				
	DI3	Digital input DI3 (<i>10.02 DI delayed status</i> , bit 2).	4																																				
	DI4	Digital input DI4 (<i>10.02 DI delayed status</i> , bit 3).	5																																				
	DI5	Digital input DI5 (<i>10.02 DI delayed status</i> , bit 4).	6																																				
	DI6	Digital input DI6 (<i>10.02 DI delayed status</i> , bit 5).	7																																				
	Reserved		8...17																																				
	Timed function 1	Bit 0 of <i>34.01 Timed functions status</i> (see page 496).	18																																				
	Timed function 2	Bit 1 of <i>34.01 Timed functions status</i> (see page 496).	19																																				
	Timed function 3	Bit 2 of <i>34.01 Timed functions status</i> (see page 496).	20																																				
	Reserved		21...23																																				
	Supervision 1	Bit 0 of <i>32.01 Supervision status</i> (see page 485).	24																																				
	Supervision 2	Bit 1 of <i>32.01 Supervision status</i> (see page 485).	25																																				
	Supervision 3	Bit 2 of <i>32.01 Supervision status</i> (see page 485).	26																																				
	<i>Other [bit]</i>	Source selection (see <i>Terms and abbreviations</i> on page 358).	-																																				
22.23	<i>Constant speed sel2</i>	When bit 0 of parameter <i>22.21 Constant speed function</i> is 0 (Separate), selects a source that activates constant speed 2. When bit 0 of parameter <i>22.21 Constant speed function</i> is 1 (Packed), this parameter and parameters <i>22.22 Constant speed sel1</i> and <i>22.24 Constant speed sel3</i> select three sources that are used to activate constant speeds. See table at parameter <i>22.22 Constant speed sel1</i> . For the selections, see parameter <i>22.22 Constant speed sel1</i> .	<i>Always off</i>																																				

No.	Name/Value	Description	Def/FbEq16
22.24	Constant speed sel3	When bit 0 of parameter 22.21 Constant speed function is 0 (Separate), selects a source that activates constant speed 3. When bit 0 of parameter 22.21 Constant speed function is 1 (Packed), this parameter and parameters 22.22 Constant speed sel1 and 22.23 Constant speed sel2 select three sources that are used to activate constant speeds. See table at parameter 22.22 Constant speed sel1 . For the selections, see parameter 22.22 Constant speed sel1 .	Always off
22.25	Constant speed sel4	When bit 0 of parameter 22.21 Constant speed function is 0 (Separate), selects a source that activates constant speed 4. For the selections, see parameter 22.22 Constant speed sel1 .	Always off
22.26	Constant speed 1	Defines constant speed 1 (the speed the motor will turn when constant speed 1 is selected).	300.00 rpm; 360.00 rpm (95.20 b0)
	-30000.00... 30000.00 rpm	Constant speed 1.	See par. 46.01
22.27	Constant speed 2	Defines constant speed 2.	600.00 rpm; 720.00 rpm (95.20 b0)
	-30000.00... 30000.00 rpm	Constant speed 2.	See par. 46.01
22.28	Constant speed 3	Defines constant speed 3.	900.00 rpm; 1080.00 rpm (95.20 b0)
	-30000.00... 30000.00 rpm	Constant speed 3.	See par. 46.01
22.29	Constant speed 4	Defines constant speed 4.	1200.00 rpm; 1440.00 rpm (95.20 b0)
	-30000.00... 30000.00 rpm	Constant speed 4.	See par. 46.01
22.30	Constant speed 5	Defines constant speed 5.	1500.00 rpm; 1800.00 rpm (95.20 b0)
	-30000.00... 30000.00 rpm	Constant speed 5.	See par. 46.01
22.31	Constant speed 6	Defines constant speed 6.	2400.00 rpm; 2880.00 rpm (95.20 b0)
	-30000.00... 30000.00 rpm	Constant speed 6.	See par. 46.01
22.32	Constant speed 7	Defines constant speed 7.	3000.00 rpm; 3600.00 rpm (95.20 b0)
	-30000.00... 30000.00 rpm	Constant speed 7.	See par. 46.01

No.	Name/Value	Description	Def/FbEq16														
22.41	<i>Speed ref safe</i>	Defines a safe speed reference value that is used with supervision functions such as <ul style="list-style-type: none"> 12.03 AI supervision function 49.05 Communication loss action 50.02 FBA A comm loss func 80.17 Maximum flow protection 80.18 Minimum flow protection. 	0.00 rpm														
	-30000.00... 30000.00 rpm	Safe speed reference.	See par. 46.01														
22.46	<i>Constant speed sel5</i>	When bit 0 of parameter 22.21 <i>Constant speed function</i> is 0 (Separate), selects a source that activates constant speed 5. For the selections, see parameter 22.22 <i>Constant speed sel1</i> .	<i>Always off</i>														
22.47	<i>Constant speed sel6</i>	When bit 0 of parameter 22.21 <i>Constant speed function</i> is 0 (Separate), selects a source that activates constant speed 6. For the selections, see parameter 22.22 <i>Constant speed sel1</i> .	<i>Always off</i>														
22.51	<i>Critical speed function</i>	Enables/disables the critical speeds function. Also determines whether the specified ranges are effective in both rotating directions or not. See also section <i>Critical speeds/frequencies</i> (page 160).	0000b														
<table border="1"> <thead> <tr> <th>Bit</th> <th>Name</th> <th>Information</th> </tr> </thead> <tbody> <tr> <td rowspan="2">0</td> <td rowspan="2">Enable</td> <td>1 = Enable: Critical speeds enabled.</td> </tr> <tr> <td>0 = Disable: Critical speeds disabled.</td> </tr> <tr> <td rowspan="2">1</td> <td rowspan="2">Sign mode</td> <td>1 = Signed: The signs of parameters 22.52...22.57 are taken into account.</td> </tr> <tr> <td>0 = Absolute: Parameters 22.52...22.57 are handled as absolute values. Each range is effective in both directions of rotation.</td> </tr> <tr> <td>2...15</td> <td>Reserved</td> <td></td> </tr> </tbody> </table>				Bit	Name	Information	0	Enable	1 = Enable: Critical speeds enabled.	0 = Disable: Critical speeds disabled.	1	Sign mode	1 = Signed: The signs of parameters 22.52...22.57 are taken into account.	0 = Absolute: Parameters 22.52...22.57 are handled as absolute values. Each range is effective in both directions of rotation.	2...15	Reserved	
Bit	Name	Information															
0	Enable	1 = Enable: Critical speeds enabled.															
		0 = Disable: Critical speeds disabled.															
1	Sign mode	1 = Signed: The signs of parameters 22.52...22.57 are taken into account.															
		0 = Absolute: Parameters 22.52...22.57 are handled as absolute values. Each range is effective in both directions of rotation.															
2...15	Reserved																
	0000h...FFFFh	Critical speeds configuration word.	1 = 1														
22.52	<i>Critical speed 1 low</i>	Defines the low limit for critical speed range 1. Note: This value must be less than or equal to the value of 22.53 <i>Critical speed 1 high</i> .	0.00 rpm														
	-30000.00... 30000.00 rpm	Low limit for critical speed 1.	See par. 46.01														
22.53	<i>Critical speed 1 high</i>	Defines the high limit for critical speed range 1. Note: This value must be greater than or equal to the value of 22.52 <i>Critical speed 1 low</i> .	0.00 rpm														
	-30000.00... 30000.00 rpm	High limit for critical speed 1.	See par. 46.01														
22.54	<i>Critical speed 2 low</i>	Defines the low limit for critical speed range 2. Note: This value must be less than or equal to the value of 22.55 <i>Critical speed 2 high</i> .	0.00 rpm														
	-30000.00... 30000.00 rpm	Low limit for critical speed 2.	See par. 46.01														
22.55	<i>Critical speed 2 high</i>	Defines the high limit for critical speed range 2. Note: This value must be greater than or equal to the value of 22.54 <i>Critical speed 2 low</i> .	0.00 rpm														
	-30000.00... 30000.00 rpm	High limit for critical speed 2.	See par. 46.01														

No.	Name/Value	Description	Def/FbEq16
22.56	<i>Critical speed 3 low</i>	Defines the low limit for critical speed range 3. Note: This value must be less than or equal to the value of 22.57 Critical speed 3 high .	0.00 rpm
	-30000.00... 30000.00 rpm	Low limit for critical speed 3.	See par. 46.01
22.57	<i>Critical speed 3 high</i>	Defines the high limit for critical speed range 3. Note: This value must be greater than or equal to the value of 22.56 Critical speed 3 low .	0.00 rpm
	-30000.00... 30000.00 rpm	High limit for critical speed 3.	See par. 46.01
22.70	<i>Motor potentiometer reference enable</i>	Determines when parameters 22.73 Motor potentiometer up source and 22.74 Motor potentiometer down source may change parameter 22.80 Motor potentiometer ref act .	<i>Selected</i>
	Not selected	Motor potentiometer Up/Down sources (22.73 and 22.74) are disabled.	0
	Selected	Motor potentiometer Up/Down sources (22.73 and 22.74) are enabled.	1
	While running	Motor potentiometer reference enable follows bit 4 (Following reference) of parameter 06.16 Drive status word 1 .	2
22.71	<i>Motor potentiometer function</i>	Activates and selects the mode of the Floating point control (Motor potentiometer).	<i>Disabled</i>
	Disabled	Floating point control (Motor potentiometer) is disabled and the Floating point control (Motor potentiometer) counter value set to 0.	0
	Enabled (init at stop /power-up)	When enabled, the Floating point control (Motor potentiometer) counter first adopts the value defined by parameter 22.72 Motor potentiometer initial value . The value can then be adjusted from the up and down sources defined by parameters 22.73 Motor potentiometer up source and 22.74 Motor potentiometer down source . A stop or a power cycle will reset the counter to the initial value (22.72).	1
	Enabled (resume always)	As Enabled (init at stop /power-up) , but the Floating point control (Motor potentiometer) counter is retained over a power cycle.	2
	Enabled (init to actual)	Whenever another reference source is selected, the value of the Floating point control (Motor potentiometer) counter follows that reference. After the source of reference returns to the Floating point control (Motor potentiometer) counter, its value can again be changed by the up and down sources (defined by 22.73 and 22.74).	3
	Enabled (resume/init to Actual)	As Enabled (init to actual) , but the motor potentiometer ref act value is retained over power cycle.	4
22.72	<i>Motor potentiometer initial value</i>	Defines an initial value (starting point) for the Floating point control (Motor potentiometer) counter. See the selections of parameter 22.71 Motor potentiometer function .	0.00
	-32768.00... 32767.00	Initial value for the counter.	1 = 1

No.	Name/Value	Description	Def/FbEq16
22.73	<i>Motor potentiometer up source</i>	Selects the source of Floating point control (Motor potentiometer) counter up signal. 0 = No change 1 = Increase Floating point control (Motor potentiometer) counter value. (If both the up and down sources are on, the potentiometer value will not change.) Note: Floating point control (Motor potentiometer) function up/down source control speed or frequency from zero to maximum speed or frequency. The running direction can be changed with parameter <i>20.04 Ext1 in2 source</i> . See the figure in section <i>Floating point control (Motor potentiometer)</i> on page 209.	<i>Not used</i>
	Not used	0.	0
	Not used	1.	1
	DI1	Digital input DI1 (<i>10.02 DI delayed status</i> , bit 0).	2
	DI2	Digital input DI2 (<i>10.02 DI delayed status</i> , bit 1).	3
	DI3	Digital input DI3 (<i>10.02 DI delayed status</i> , bit 2).	4
	DI4	Digital input DI4 (<i>10.02 DI delayed status</i> , bit 3).	5
	DI5	Digital input DI5 (<i>10.02 DI delayed status</i> , bit 4).	6
	DI6	Digital input DI6 (<i>10.02 DI delayed status</i> , bit 5).	7
	Reserved		8...17
	Timed function 1	Bit 0 of <i>34.01 Timed functions status</i> (see page 496).	18
	Timed function 2	Bit 1 of <i>34.01 Timed functions status</i> (see page 496).	19
	Timed function 3	Bit 2 of <i>34.01 Timed functions status</i> (see page 496).	20
	Reserved		21...23
	Supervision 1	Bit 0 of <i>32.01 Supervision status</i> (see page 485).	24
	Supervision 2	Bit 1 of <i>32.01 Supervision status</i> (see page 485).	25
	Supervision 3	Bit 2 of <i>32.01 Supervision status</i> (see page 485).	26
	<i>Other [bit]</i>	Source selection (see <i>Terms and abbreviations</i> on page 358).	-
22.74	<i>Motor potentiometer down source</i>	Selects the source of Floating point control (Motor potentiometer) counter down signal. 0 = No change 1 = Decrease Floating point control (Motor potentiometer) counter value. (If both the up and down sources are on, the counter value will not change.) Note: Floating point control (Motor potentiometer) function up/down source control speed or frequency from zero to maximum speed or frequency. The running direction can be changed with parameter <i>20.04 Ext1 in2 source</i> . See the figure in section <i>Floating point control (Motor potentiometer)</i> on page 209. For the selections, see parameter <i>22.73 Motor potentiometer up source</i> .	<i>Not used</i>
22.75	<i>Motor potentiometer ramp time</i>	Defines the change rate of the Floating point control (Motor potentiometer) counter. This parameter specifies the time required for the Floating point control (Motor potentiometer) to change from minimum (<i>22.76</i>) to maximum (<i>22.77</i>). The same change rate applies in both directions.	40.0 s
	0.0...3600.0 s	Counter change time.	1 = 1 s

No.	Name/Value	Description	Def/FbEq16
22.76	<i>Motor potentiometer min value</i>	Defines the minimum value of the Floating point control (Motor potentiometer) counter. Note: If vector control mode is used, value of this parameter must be changed.	-50.00
	-32768.00... 32767.00	Counter minimum.	1 = 1
22.77	<i>Motor potentiometer max value</i>	Defines the maximum value of the Floating point control (Motor potentiometer) counter. Note: If vector control mode is used, value of this parameter must be changed.	50.00
	-32768.00... 32767.00	Counter maximum.	1 = 1
22.80	<i>Motor potentiometer ref act</i>	The output of the Floating point control (Motor potentiometer) function. (The meter is configured using parameters 22.71...22.74.) This parameter is read-only.	-
	-32768.00... 32767.00	Value of the Floating point control (Motor potentiometer) counter.	1 = 1
22.86	<i>Speed reference act 6</i>	Displays the value of the speed reference (EXT1 or EXT2) that has been selected by 19.11 Ext1/Ext2 selection. See diagram at 22.11 Ext1 speed ref1 or control chain diagram Speed reference source selection I on page 366. This parameter is read-only.	-
	-30000.00... 30000.00 rpm	Speed reference after additive 2.	See par. 46.01
22.87	<i>Speed reference act 7</i>	Displays the value of speed reference before application of critical speeds. See the control chain diagram on page 367. The value is received from 22.86 Speed reference act 6 unless overridden by <ul style="list-style-type: none"> any constant speed network control reference (see page 25) control panel reference safe speed reference. This parameter is read-only.	-
	-30000.00... 30000.00 rpm	Speed reference before application of critical speeds.	See par. 46.01
23 Speed reference ramp		Speed reference ramp settings (programming of the acceleration and deceleration rates for the drive). See control chain diagram Speed reference ramping and shaping on page 368.	
23.01	<i>Speed ref ramp input</i>	Displays the used speed reference (in rpm) before it enters the ramping and shaping functions. See control chain diagram Speed reference ramping and shaping on page 368. This parameter is read-only.	-
	-30000.00... 30000.00 rpm	Speed reference before ramping and shaping.	See par. 46.01
23.02	<i>Speed ref ramp output</i>	Displays the ramped and shaped speed reference in rpm. See control chain diagram Speed reference ramping and shaping on page 368. This parameter is read-only.	-
	-30000.00... 30000.00 rpm	Speed reference after ramping and shaping.	See par. 46.01

No.	Name/Value	Description	Def/FbEq16
23.11	<i>Ramp set selection</i>	Selects the source that switches between the two sets of acceleration/deceleration ramp times defined by parameters 23.12...23.15. 0 = Acceleration time 1 and deceleration time 1 are active 1 = Acceleration time 2 and deceleration time 2 are active	<i>Acc/Dec time 1</i>
	Acc/Dec time 1	0.	0
	Acc/Dec time 2	1.	1
	DI1	Digital input DI1 (<i>10.02 DI delayed status</i> , bit 0).	2
	DI2	Digital input DI2 (<i>10.02 DI delayed status</i> , bit 1).	3
	DI3	Digital input DI3 (<i>10.02 DI delayed status</i> , bit 2).	4
	DI4	Digital input DI4 (<i>10.02 DI delayed status</i> , bit 3).	5
	DI5	Digital input DI5 (<i>10.02 DI delayed status</i> , bit 4).	6
	DI6	Digital input DI6 (<i>10.02 DI delayed status</i> , bit 5).	7
	Reserved		8...17
	FBA A	For Transparent16 and Transparent32 profiles only. DCU control word bit 10 received through the fieldbus adapter.	18
	Reserved		19
	EFB DCU CW bit 10	Only for the DCU profile. DCU control word bit 10 received through the embedded fieldbus interface.	20
	<i>Other [bit]</i>	Source selection (see <i>Terms and abbreviations</i> on page 358).	-
23.12	<i>Acceleration time 1</i>	Defines acceleration time 1 as the time required for the speed to change from zero to the speed defined by parameter 46.01 <i>Speed scaling</i> (not to parameter 30.12 <i>Maximum speed</i>). If the speed reference increases faster than the set acceleration rate, the motor speed will follow the acceleration rate. If the speed reference increases slower than the set acceleration rate, the motor speed will follow the reference. If the acceleration time is set too short, the drive will automatically prolong the acceleration in order not to exceed the drive torque limits.	20.000 s
	0.000...1800.000 s	Acceleration time 1.	10 = 1 s
23.13	<i>Deceleration time 1</i>	Defines deceleration time 1 as the time required for the speed to change from the speed defined by parameter 46.01 <i>Speed scaling</i> (not from parameter 30.12 <i>Maximum speed</i>) to zero. If the speed reference decreases slower than the set deceleration rate, the motor speed will follow the reference. If the reference changes faster than the set deceleration rate, the motor speed will follow the deceleration rate. If the deceleration rate is set too short, the drive will automatically prolong the deceleration in order not to exceed drive torque limits (or not to exceed a safe DC link voltage). If there is any doubt about the deceleration time being too short, ensure that DC overvoltage control is on (parameter 30.30 <i>Overvoltage control</i>). Note: If a short deceleration time is needed for a high inertia application, the drive should be equipped with braking equipment such as a brake chopper and brake resistor.	20.000 s
	0.000...1800.000 s	Deceleration time 1.	10 = 1 s

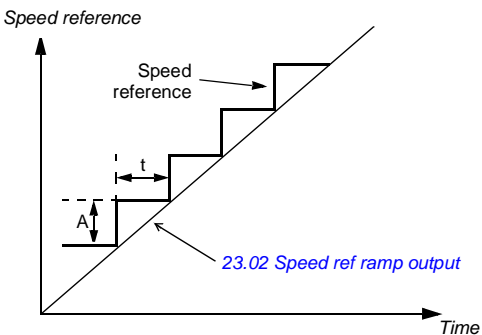
No.	Name/Value	Description	Def/FbEq16
23.14	<i>Acceleration time 2</i>	Defines acceleration time 2. See parameter 23.12 Acceleration time 1 .	60.000 s
	0.000...1800.000 s	Acceleration time 2.	10 = 1 s
23.15	<i>Deceleration time 2</i>	Defines deceleration time 2. See parameter 23.13 Deceleration time 1 .	60.000 s
	0.000...1800.000 s	Deceleration time 2.	10 = 1 s
23.23	<i>Emergency stop time</i>	Defines the time inside which the drive is stopped if an emergency stop Off3 is activated (ie. the time required for the speed to change from the speed value defined by parameter 46.01 Speed scaling or 46.02 Frequency scaling to zero). Emergency stop mode and activation source are selected by parameters 21.04 Emergency stop mode and 21.05 Emergency stop source respectively. Emergency stop can also be activated through fieldbus. Notes: <ul style="list-style-type: none"> Emergency stop Off1 uses the standard deceleration ramp as defined by parameters 23.11...23.15. The same parameter value is also used in frequency control mode (ramp parameters 28.71...28.75). 	3.000 s
	0.000...1800.000 s	Emergency stop Off3 deceleration time.	10 = 1 s
23.28	<i>Variable slope enable</i>	Activates the variable slope function, which controls the slope of the speed ramp during a speed reference change. This allows for a constantly variable ramp rate to be generated, instead of just the standard two ramps normally available. If the update interval of the signal from an external control system and the variable slope rate (23.29 Variable slope rate) are equal, speed reference (23.02 Speed ref ramp output) is a straight line.  <p>t = update interval of signal from an external control system A = speed reference change during t</p> <p>This function is only active in external control.</p>	<i>Off</i>
	Off	Variable slope disabled.	0
	On	Variable slope enabled (not available in local control).	1

No.	Name/Value	Description	Def/FbEq16
23.29	<i>Variable slope rate</i>	Defines the rate of the speed reference change when variable slope is enabled by parameter 23.28 Variable slope enable . For the best result, enter the reference update interval into this parameter.	50 ms
	2...30000 ms	Variable slope rate.	1 = 1 ms
24 Speed reference conditioning		Speed error calculation; speed error window control configuration; speed error step. See control chain diagram Speed error calculation on page 369 .	
24.01	<i>Used speed reference</i>	Displays the ramped and corrected speed reference (before speed error calculation). See control chain diagram Speed error calculation on page 369 . This parameter is read-only.	-
	-30000.00... 30000.00 rpm	Speed reference used for speed error calculation.	See par. 46.01
24.02	<i>Used speed feedback</i>	Displays the speed feedback used for speed error calculation. See control chain diagram Speed error calculation on page 369 . This parameter is read-only.	-
	-30000.00... 30000.00 rpm	Speed feedback used for speed error calculation.	See par. 46.01
24.03	<i>Speed error filtered</i>	Displays the filtered speed error. See control chain diagram Speed error calculation on page 369 . This parameter is read-only.	-
	-30000.00... 30000.00 rpm	Filtered speed error.	See par. 46.01
24.04	<i>Speed error inverted</i>	Displays the inverted (unfiltered) speed error. See control chain diagram Speed error calculation on page 369 . This parameter is read-only.	-
	-30000.0... 30000.0 rpm	Inverted speed error.	See par. 46.01
24.11	<i>Speed correction</i>	Defines a speed reference correction, ie, a value added to the existing reference between ramping and limitation. This is useful to trim the speed if necessary, for example, to adjust draw between sections of a paper machine. See control chain diagram Speed error calculation on page 369 .	0.00 rpm
	-10000.00... 10000.00 rpm	Speed reference correction.	See par. 46.01
24.12	<i>Speed error filter time</i>	Defines the time constant of the speed error low-pass filter. If the used speed reference changes rapidly, the possible interferences in the speed measurement can be filtered with the speed error filter. Reducing the ripple with this filter may cause speed controller tuning problems. A long filter time constant and fast acceleration time contradict one another. A very long filter time results in unstable control.	0 ms
	0...10000 ms	Speed error filtering time constant. 0 = filtering disabled.	1 = 1 ms

No.	Name/Value	Description	Def/FbEq16
25 Speed control		Speed controller settings. See control chain diagram Speed error calculation on page 369.	
25.01	Torque reference speed control	Displays the speed controller output that is transferred to the torque controller. See control chain diagram Speed error calculation on page 369. This parameter is read-only.	-
	-1600.0...1600.0%	Limited speed controller output torque.	See par. 46.03
25.02	Speed proportional gain	Defines the proportional gain (K_p) of the speed controller. Too high a gain may cause speed oscillation. The figure below shows the speed controller output after an error step when the error remains constant. <div style="text-align: center;"> <p>Gain = $K_p = 1$ $T_I =$ Integration time = 0 $T_D =$ Derivation time = 0</p> </div> <p>If gain is set to 1, a 10% change in error value (reference - actual value) causes the speed controller output to change by 10%, ie, the output value is input x gain.</p>	5.00
	0.00...250.00	Proportional gain for speed controller.	100 = 1

No.	Name/Value	Description	Def/FbEq16
25.03	<i>Speed integration time</i>	<p>Defines the integration time of the speed controller. The integration time defines the rate at which the controller output changes when the error value is constant and the proportional gain of the speed controller is 1. The shorter the integration time, the faster the continuous error value is corrected. This time constant must be set to the same order of magnitude as the time constant (time to respond) of the actual mechanical system being controlled, otherwise instability will result.</p> <p>Setting the integration time to zero disables the I-part of the controller. This is useful to do when tuning the proportional gain; adjust the proportional gain first, then return the integration time.</p> <p>Anti-windup (the integrator just integrates up to 100%) stops the integrator if the controller output is limited.</p> <p>The figure below shows the speed controller output after an error step when the error remains constant.</p>	2.50 s
	0.00...1000.00 s	Integration time for speed controller.	10 = 1 s

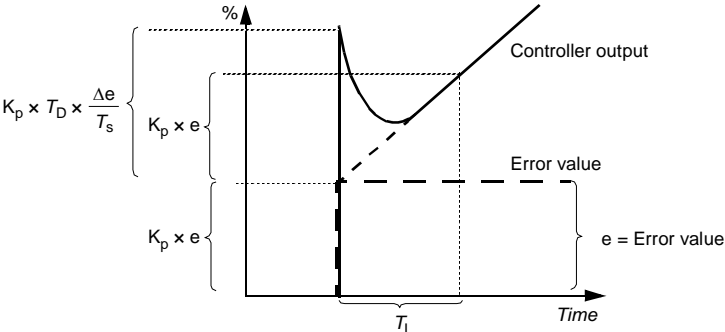
No.	Name/Value	Description	Def/FbEq16
25.04	<i>Speed derivation time</i>	<p>Defines the derivation time of the speed controller. Derivative action boosts the controller output if the error value changes. The longer the derivation time, the more the speed controller output is boosted during the change. If the derivation time is set to zero, the controller works as a PI controller, otherwise as a PID controller. The derivation makes the control more responsive for disturbances. For simple applications, derivative time is not normally required and should be left at zero.</p> <p>The speed error derivative must be filtered with a low pass filter to eliminate disturbances.</p> <p>The figure below shows the speed controller output after an error step when the error remains constant.</p>	0.000 s
<div style="text-align: center;">  <p>Gain = $K_p = 1$ T_l = Integration time > 0 T_D = Derivation time > 0 T_s = Sample time period = 250 μs Δe = Error value change between two samples</p> </div>			
0.000...10.000 s	Derivation time for speed controller.	1000 = 1 s	
25.05	<i>Derivation filter time</i>	Defines the derivation filter time constant. See parameter 25.04 Speed derivation time .	8 ms
0...10000 ms	Derivation filter time constant.	1 = 1 ms	

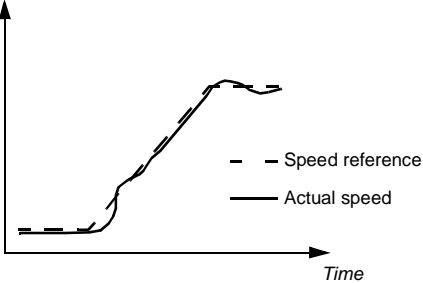
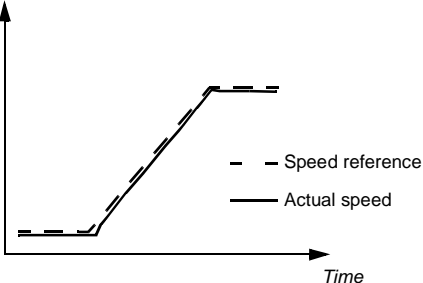
No.	Name/Value	Description	Def/FbEq16
25.06	<i>Acc comp derivation time</i>	<p>Defines the derivation time for acceleration(/deceleration) compensation. In order to compensate for a high inertia load during acceleration, a derivative of the reference is added to the output of the speed controller. The principle of a derivative action is described under parameter 25.04 Speed derivation time.</p> <p>Note: As a general rule, set this parameter to the value between 50 and 100% of the sum of the mechanical time constants of the motor and the driven machine.</p> <p>The figure below shows the speed responses when a high inertia load is accelerated along a ramp.</p> <p>No acceleration compensation:</p>  <p>Acceleration compensation:</p> 	0.00 s
	0.00...1000.00 s	Acceleration compensation derivation time.	10 = 1 s
25.07	<i>Acc comp filter time</i>	Defines the acceleration (or deceleration) compensation filter time constant. See parameters 25.04 Speed derivation time and 25.06 Acc comp derivation time .	8.0 ms
	0.0...1000.0 ms	Acceleration/deceleration compensation filter time.	1 = 1 ms
25.15	<i>Proportional gain em stop</i>	Defines the proportional gain for the speed controller when an emergency stop is active. See parameter 25.02 Speed proportional gain .	10.00
	1.00...250.00	Proportional gain upon an emergency stop.	100 = 1

No.	Name/Value	Description	Def/FbEq16
25.30	<i>Flux adaptation enable</i>	Enables/disables speed controller adaptation based on motor flux reference (<i>01.24 Flux actual %</i>). The proportional gain of the speed controller is multiplied by a coefficient of 0...1 between 0...100% flux reference respectively.	<i>Enable</i>
	Disable	Speed controller adaptation based on flux reference disabled.	0
	Enable	Speed controller adaptation based on flux reference enabled.	1
25.53	<i>Torque prop reference</i>	Displays the output of the proportional (P) part of the speed controller. See control chain diagram <i>Speed error calculation</i> on page 369. This parameter is read-only.	-
	-30000.0... 30000.0%	P-part output of speed controller.	See par. <i>46.03</i>
25.54	<i>Torque integral reference</i>	Displays the output of the integral (I) part of the speed controller. See control chain diagram <i>Speed error calculation</i> on page 369. This parameter is read-only.	-
	-30000.0... 30000.0%	I-part output of speed controller.	See par. <i>46.03</i>
25.55	<i>Torque deriv reference</i>	Displays the output of the derivative (D) part of the speed controller. See control chain diagram <i>Speed error calculation</i> on page 369. This parameter is read-only.	-
	-30000.0... 30000.0%	D-part output of speed controller.	See par. <i>46.03</i>
25.56	<i>Torque acc compensation</i>	Displays the output of the acceleration compensation function. See control chain diagram <i>Speed error calculation</i> on page 369. This parameter is read-only.	-
	-30000.0... 30000.0%	Output of acceleration compensation function.	See par. <i>46.03</i>
28 Frequency reference chain		Settings for the frequency reference chain. See the control chain diagrams on pages 364 and 365.	
28.01	<i>Frequency ref ramp input</i>	Displays the used frequency reference before ramping. See the control chain diagrams <i>Frequency reference selection</i> on page 364 and <i>Frequency reference modification</i> on page 365. This parameter is read-only.	-
	-500.00...500.00 Hz	Frequency reference before ramping.	See par. <i>46.02</i>
28.02	<i>Frequency ref ramp output</i>	Displays the final frequency reference (after selection, limitation and ramping). See control chain diagram on page 364. This parameter is read-only.	-
	-500.00...500.00 Hz	Final frequency reference.	See par. <i>46.02</i>

No.	Name/Value	Description	Def/FbEq16
28.11	<i>Ext1 frequency ref1</i>	<p>Selects EXT1 frequency reference source 1.</p> <p>Two signal sources can be defined by this parameter and 28.12 Ext1 frequency ref2. A mathematical function (28.13 Ext1 frequency function) applied to the two signals creates an EXT1 reference (A in the figure below).</p> <p>A digital source selected by 19.11 Ext1/Ext2 selection can be used to switch between EXT1 reference and the corresponding EXT2 reference defined by parameters 28.15 Ext2 frequency ref1, 28.16 Ext2 frequency ref2 and 28.17 Ext2 frequency function (B in the figure below).</p>	<i>AI1 scaled</i>

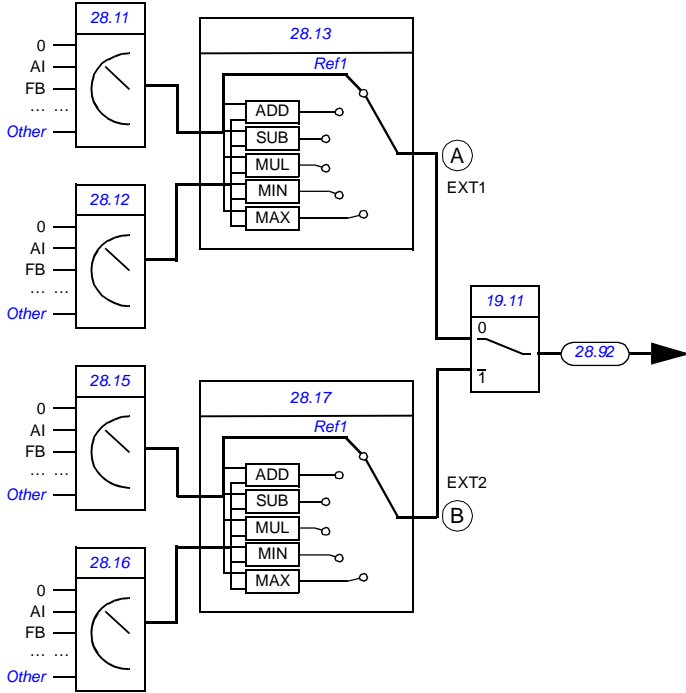

Zero	None.	0
AI1 scaled	12.12 AI1 scaled value (see page 400).	1
AI2 scaled	12.22 AI2 scaled value (see page 402).	2
Reserved		3
FB A ref1	03.05 FB A reference 1 (see page 364).	4
FB A ref2	03.06 FB A reference 2 (see page 364).	5
Reserved		6...7
EFB ref1	03.09 EFB reference 1 (see page 365).	8
EFB ref2	03.10 EFB reference 2 (see page 365).	9
Reserved		10...14

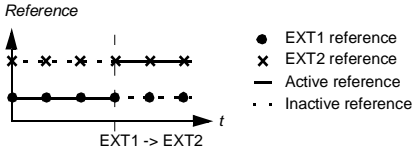
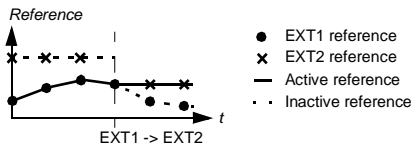
No.	Name/Value	Description	Def/FbEq16
	Motor potentiometer	22.80 Motor potentiometer ref act (output of the Floating point control (Motor potentiometer)).	15
	PID	40.01 Process PID output actual (output of the process PID controller).	16
	Frequency input	11.38 Freq in 1 actual value (when DI5 is used as a frequency input).	17
	Control panel (ref saved)	Control panel reference (03.01 Panel reference , see page 364) saved by the control system for the location where the control returns is used as the reference. 	18
	Control panel (ref copied)	Control panel reference (03.01 Panel reference , see page 364) for the previous control location is used as the reference when the control location changes if the references for the two locations are of the same type (eg frequency/speed/torque/PID); otherwise, the actual signal is used as the new reference. 	19
	Reserved		20...22
	AI3 scaled	15.52 AI3 scaled value (see page 507).	23
	AI4 scaled	15.62 AI4 scaled value (see page 509).	24
	AI5 scaled	15.72 AI5 scaled value (see page 511).	25
	<i>Other</i>	Source selection (see Terms and abbreviations on page 358).	-
28.12	Ext1 frequency ref2	Selects EXT1 frequency reference source 2. For the available selections, and a diagram of reference source selection, see parameter 28.11 Ext1 frequency ref1 .	<i>Zero</i>
28.13	Ext1 frequency function	Selects a mathematical function between the reference sources selected by parameters 28.11 Ext1 frequency ref1 and 28.12 Ext1 frequency ref2 . See diagram at 28.11 Ext1 frequency ref1 .	<i>Ref1</i>
	Ref1	Signal selected by 28.11 Ext1 frequency ref1 is used as frequency reference 1 as such (no function applied).	0
	Add (ref1 + ref2)	The sum of the reference sources is used as frequency reference 1.	1
	Sub (ref1 - ref2)	The subtraction ([28.11 Ext1 frequency ref1] - [28.12 Ext1 frequency ref2]) of the reference sources is used as frequency reference 1.	2
	Mul (ref1 × ref2)	The multiplication of the reference sources is used as frequency reference 1.	3
	Min (ref1, ref2)	The smaller of the reference sources is used as frequency reference 1.	4

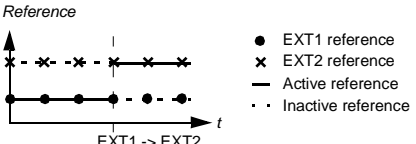
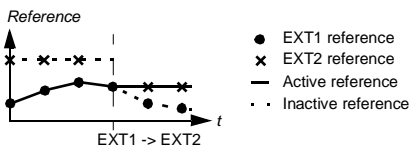
No.	Name/Value	Description	Def/FbEq16
	Max (ref1, ref2)	The greater of the reference sources is used as frequency reference 1.	5
28.15	Ext2 frequency ref1	Selects EXT2 frequency reference source 1. Two signal sources can be defined by this parameter and 28.16 Ext2 frequency ref2. A mathematical function (28.17 Ext2 frequency function) applied to the two signals creates an EXT2 reference. See diagram at 28.11 Ext1 frequency ref1.	Zero
	Zero	None.	0
	AI1 scaled	12.12 AI1 scaled value (see page 400).	1
	AI2 scaled	12.22 AI2 scaled value (see page 402).	2
	Reserved		3
	FB A ref1	03.05 FB A reference 1 (see page 364).	4
	FB A ref2	03.06 FB A reference 2 (see page 364).	5
	Reserved		6...7
	EFB ref1	03.09 EFB reference 1 (see page 365).	8
	EFB ref2	03.10 EFB reference 2 (see page 365).	9
	Reserved		10...14
	Motor potentiometer	22.80 Motor potentiometer ref act (output of the Floating point control (Motor potentiometer)).	15
	PID	40.01 Process PID output actual (output of the process PID controller).	16
	Frequency input	11.38 Freq in 1 actual value (when DI5 is used as a frequency input).	17
	Control panel (ref saved)	Control panel reference (03.01 Panel reference, see page 364) saved by the control system for the location where the control returns is used as the reference. 	18
	Control panel (ref copied)	Control panel reference (03.01 Panel reference, see page 364) for the previous control location is used as the reference when the control location changes if the references for the two locations are of the same type (eg frequency/speed/torque/PID); otherwise, the actual signal is used as the new reference. 	19
	Reserved		20...22
	AI3 scaled	15.52 AI3 scaled value (see page 507).	23
	AI4 scaled	15.62 AI4 scaled value (see page 509).	24
	AI5 scaled	15.72 AI5 scaled value (see page 511).	25

No.	Name/Value	Description	Def/FbEq16
	<i>Other</i>	Source selection (see Terms and abbreviations on page 358).	-
28.16	<i>Ext2 frequency ref2</i>	Selects EXT2 frequency reference source 2. For the available selections, and a diagram of reference source selection, see parameter 28.15 Ext2 frequency ref1 .	<i>Zero</i>
28.17	<i>Ext2 frequency function</i>	Selects a mathematical function between the reference sources selected by parameters 28.15 Ext2 frequency ref1 and 28.16 Ext2 frequency ref2 . See diagram at 28.15 Ext2 frequency ref1 .	<i>Ref1</i>
	Ref1	Signal selected by 28.15 Ext2 frequency ref1 is used as frequency reference 1 as such (no function applied).	0
	Add (ref1 + ref2)	The sum of the reference sources is used as frequency reference 1.	1
	Sub (ref1 - ref2)	The subtraction ([28.15 Ext2 frequency ref1] - [28.16 Ext2 frequency ref2]) of the reference sources is used as frequency reference 1.	2
	Mul (ref1 x ref2)	The multiplication of the reference sources is used as frequency reference 1.	3
	Min (ref1, ref2)	The smaller of the reference sources is used as frequency reference 1.	4
	Max (ref1, ref2)	The greater of the reference sources is used as frequency reference 1.	5
28.21	<i>Constant frequency function</i>	Determines how constant frequencies are selected, and whether the rotation direction signal is considered or not when applying a constant frequency.	000b

Bit	Name	Information
0	Const freq mode	1 = Packed: 7 constant frequencies are selectable using the three sources defined by parameters 28.22 , 28.23 and 28.24 . 0 = Separate: Constant frequencies 1, 2 and 3 are separately activated by the sources defined by parameters 28.22 , 28.23 and 28.24 respectively. In case of conflict, the constant frequency with the smaller number takes priority.
1	Direction enable	1 = Start dir: To determine running direction for a constant speed, the sign of the constant speed setting (parameters 22.26...22.32) is multiplied by the direction signal (forward: +1, reverse: -1). This effectively allows the drive to have 14 (7 forward, 7 reverse) constant speeds if all values in 22.26...22.32 are positive.  WARNING: If the direction signal is reverse and the active constant speed is negative, the drive will run in the forward direction. 0 = According to Par: The running direction for the constant speed is determined by the sign of the constant speed setting (parameters 22.26...22.32).
2...15	Reserved	

0000h...FFFFh	Constant frequency configuration word.	1 = 1
---------------	--	-------

No.	Name/Value	Description	Def/FbEq16																																				
28.22	Constant frequency sel1	<p>When bit 0 of parameter 28.21 Constant frequency function is 0 (Separate), selects a source that activates constant frequency 1.</p> <p>When bit 0 of parameter 28.21 Constant frequency function is 1 (Packed), this parameter and parameters 28.23 Constant frequency sel2 and 28.24 Constant frequency sel3 select three sources whose states activate constant frequencies as follows:</p>	DI3																																				
<table border="1"> <thead> <tr> <th>Source defined by par. 28.22</th> <th>Source defined by par. 28.23</th> <th>Source defined by par. 28.24</th> <th>Constant frequency active</th> </tr> </thead> <tbody> <tr> <td>0</td> <td>0</td> <td>0</td> <td>None</td> </tr> <tr> <td>1</td> <td>0</td> <td>0</td> <td>Constant frequency 1</td> </tr> <tr> <td>0</td> <td>1</td> <td>0</td> <td>Constant frequency 2</td> </tr> <tr> <td>1</td> <td>1</td> <td>0</td> <td>Constant frequency 3</td> </tr> <tr> <td>0</td> <td>0</td> <td>1</td> <td>Constant frequency 4</td> </tr> <tr> <td>1</td> <td>0</td> <td>1</td> <td>Constant frequency 5</td> </tr> <tr> <td>0</td> <td>1</td> <td>1</td> <td>Constant frequency 6</td> </tr> <tr> <td>1</td> <td>1</td> <td>1</td> <td>Constant frequency 7</td> </tr> </tbody> </table>				Source defined by par. 28.22	Source defined by par. 28.23	Source defined by par. 28.24	Constant frequency active	0	0	0	None	1	0	0	Constant frequency 1	0	1	0	Constant frequency 2	1	1	0	Constant frequency 3	0	0	1	Constant frequency 4	1	0	1	Constant frequency 5	0	1	1	Constant frequency 6	1	1	1	Constant frequency 7
Source defined by par. 28.22	Source defined by par. 28.23	Source defined by par. 28.24	Constant frequency active																																				
0	0	0	None																																				
1	0	0	Constant frequency 1																																				
0	1	0	Constant frequency 2																																				
1	1	0	Constant frequency 3																																				
0	0	1	Constant frequency 4																																				
1	0	1	Constant frequency 5																																				
0	1	1	Constant frequency 6																																				
1	1	1	Constant frequency 7																																				
	Always off	0.	0																																				
	Always on	1.	1																																				
	DI1	Digital input DI1 (10.02 DI delayed status , bit 0).	2																																				
	DI2	Digital input DI2 (10.02 DI delayed status , bit 1).	3																																				
	DI3	Digital input DI3 (10.02 DI delayed status , bit 2).	4																																				
	DI4	Digital input DI4 (10.02 DI delayed status , bit 3).	5																																				
	DI5	Digital input DI5 (10.02 DI delayed status , bit 4).	6																																				
	DI6	Digital input DI6 (10.02 DI delayed status , bit 5).	7																																				
	Reserved		8...17																																				
	Timed function 1	Bit 0 of 34.01 Timed functions status (see page 496).	18																																				
	Timed function 2	Bit 1 of 34.01 Timed functions status (see page 496).	19																																				
	Timed function 3	Bit 2 of 34.01 Timed functions status (see page 496).	20																																				
	Reserved		21...23																																				
	Supervision 1	Bit 0 of 32.01 Supervision status (see page 485).	24																																				
	Supervision 2	Bit 1 of 32.01 Supervision status (see page 485).	25																																				
	Supervision 3	Bit 2 of 32.01 Supervision status (see page 485).	26																																				
	Other [bit]	Source selection (see Terms and abbreviations on page 358).	-																																				
28.23	Constant frequency sel2	<p>When bit 0 of parameter 28.21 Constant frequency function is 0 (Separate), selects a source that activates constant frequency 2.</p> <p>When bit 0 of parameter 28.21 Constant frequency function is 1 (Packed), this parameter and parameters 28.22 Constant frequency sel1 and 28.24 Constant frequency sel3 select three sources that are used to activate constant frequencies. See table at parameter 28.22 Constant frequency sel1.</p> <p>For the selections, see parameter 28.22 Constant frequency sel1.</p>	Always off																																				

No.	Name/Value	Description	Def/FbEq16
28.24	Constant frequency sel3	When bit 0 of parameter 28.21 Constant frequency function is 0 (Separate), selects a source that activates constant frequency 3. When bit 0 of parameter 28.21 Constant frequency function is 1 (Packed), this parameter and parameters 28.22 Constant frequency sel1 and 28.23 Constant frequency sel2 select three sources that are used to activate constant frequencies. See table at parameter 28.22 Constant frequency sel1 . For the selections, see parameter 28.22 Constant frequency sel1 .	Always off
28.25	Constant frequency sel4	When bit 0 of parameter 28.21 Constant frequency function is 0 (Separate), selects a source that activates constant frequency 4. For the selections, see parameter 28.22 Constant frequency sel1 .	Always off
28.26	Constant frequency 1	Defines constant frequency 1 (the frequency the motor will turn when constant frequency 1 is selected).	5.00 Hz; 6.00 Hz (95.20 b0)
	-500.00...500.00 Hz	Constant frequency 1.	See par. 46.02
28.27	Constant frequency 2	Defines constant frequency 2.	10.00 Hz; 12.00 Hz (95.20 b0)
	-500.00...500.00 Hz	Constant frequency 2.	See par. 46.02
28.28	Constant frequency 3	Defines constant frequency 3.	15.00 Hz; 18.00 Hz (95.20 b0)
	-500.00...500.00 Hz	Constant frequency 3.	See par. 46.02
28.29	Constant frequency 4	Defines constant frequency 4.	20.00 Hz; 24.00 Hz (95.20 b0)
	-500.00...500.00 Hz	Constant frequency 4.	See par. 46.02
28.30	Constant frequency 5	Defines constant frequency 5.	25.00 Hz; 30.00 Hz (95.20 b0)
	-500.00...500.00 Hz	Constant frequency 5.	See par. 46.02
28.31	Constant frequency 6	Defines constant frequency 6.	40.00 Hz; 48.00 Hz (95.20 b0)
	-500.00...500.00 Hz	Constant frequency 6.	See par. 46.02
28.32	Constant frequency 7	Defines constant frequency 7.	50.00 Hz; 60.00 Hz (95.20 b0)
	-500.00...500.00 Hz	Constant frequency 7.	See par. 46.02

No.	Name/Value	Description	Def/FbEq16
28.41	<i>Frequency ref safe</i>	Defines a safe frequency reference value that is used with supervision functions such as <ul style="list-style-type: none"> • 12.03 AI supervision function • 49.05 Communication loss action • 50.02 FBA A comm loss func. • 80.17 Maximum flow protection • 80.18 Minimum flow protection. 	0.00 Hz
	-500.00...500.00 Hz	Safe frequency reference.	See par. 46.02
28.46	<i>Constant frequency sel5</i>	When bit 0 of parameter 28.21 Constant frequency function is 0 (Separate), selects a source that activates constant frequency 4. For the selections, see parameter 28.22 Constant frequency sel1 .	<i>Always off</i>
28.47	<i>Constant frequency sel6</i>	When bit 0 of parameter 28.21 Constant frequency function is 0 (Separate), selects a source that activates constant frequency 4. For the selections, see parameter 28.22 Constant frequency sel1 .	<i>Always off</i>
28.51	<i>Critical frequency function</i>	Enables/disables the critical frequencies function. Also determines whether the specified ranges are effective in both rotating directions or not. See also section Critical speeds/frequencies (page 160).	0000b

Bit	Name	Information
0	Crit freq	1 = Enable: Critical frequencies enabled.
		0 = Disable: Critical frequencies disabled.
1	Sign mode	1 = According to par: The signs of parameters 28.52...28.57 are taken into account.
		0 = Absolute: Parameters 28.52...28.57 are handled as absolute values. Each range is effective in both directions of rotation.

	0000h...FFFFh	Critical frequencies configuration word.	1 = 1
28.52	<i>Critical frequency 1 low</i>	Defines the low limit for critical frequency 1. Note: This value must be less than or equal to the value of 28.53 Critical frequency 1 high .	0.00 Hz
	-500.00...500.00 Hz	Low limit for critical frequency 1.	See par. 46.02
28.53	<i>Critical frequency 1 high</i>	Defines the high limit for critical frequency 1. Note: This value must be greater than or equal to the value of 28.52 Critical frequency 1 low .	0.00 Hz
	-500.00...500.00 Hz	High limit for critical frequency 1.	See par. 46.02
28.54	<i>Critical frequency 2 low</i>	Defines the low limit for critical frequency 2. Note: This value must be less than or equal to the value of 28.55 Critical frequency 2 high .	0.00 Hz
	-500.00...500.00 Hz	Low limit for critical frequency 2.	See par. 46.02



No.	Name/Value	Description	Def/FbEq16
28.55	<i>Critical frequency 2 high</i>	Defines the high limit for critical frequency 2. Note: This value must be greater than or equal to the value of 28.54 Critical frequency 2 low .	0.00 Hz
	-500.00...500.00 Hz	High limit for critical frequency 2.	See par. 46.02
28.56	<i>Critical frequency 3 low</i>	Defines the low limit for critical frequency 3. Note: This value must be less than or equal to the value of 28.57 Critical frequency 3 high .	0.00 Hz
	-500.00...500.00 Hz	Low limit for critical frequency 3.	See par. 46.02
28.57	<i>Critical frequency 3 high</i>	Defines the high limit for critical frequency 3. Note: This value must be greater than or equal to the value of 28.56 Critical frequency 3 low .	0.00 Hz
	-500.00...500.00 Hz	High limit for critical frequency 3.	See par. 46.02
28.71	<i>Freq ramp set selection</i>	Selects a source that switches between the two sets of acceleration/deceleration times defined by parameters 28.72...28.75 . 0 = Acceleration time 1 and deceleration time 1 are in force 1 = Acceleration time 2 and deceleration time 2 are in force	<i>Acc/Dec time 1</i>
	Acc/Dec time 1	0.	0
	Acc/Dec time 2	1.	1
	DI1	Digital input DI1 (10.02 DI delayed status , bit 0).	2
	DI2	Digital input DI2 (10.02 DI delayed status , bit 1).	3
	DI3	Digital input DI3 (10.02 DI delayed status , bit 2).	4
	DI4	Digital input DI4 (10.02 DI delayed status , bit 3).	5
	DI5	Digital input DI5 (10.02 DI delayed status , bit 4).	6
	DI6	Digital input DI6 (10.02 DI delayed status , bit 5).	7
	Reserved		8...17
	FBA A	For Transparent16 and Transparent32 profiles only. DCU control word bit 10 received through the fieldbus adapter.	18
	Reserved		19
	EFB DCU CW bit 0	Only for the DCU profile. DCU control word bit 10 received through the embedded fieldbus interface.	20
	<i>Other [bit]</i>	Source selection (see Terms and abbreviations on page 358).	-
28.72	<i>Freq acceleration time 1</i>	Defines acceleration time 1 as the time required for the frequency to change from zero to the frequency defined by parameter 46.02 Frequency scaling . After this frequency has been reached, the acceleration continues with the same rate to the value defined by parameter 30.14 Maximum frequency . If the reference increases faster than the set acceleration rate, the motor will follow the acceleration rate. If the reference increases slower than the set acceleration rate, the motor frequency will follow the reference. If the acceleration time is set too short, the drive will automatically prolong the acceleration in order not to exceed the drive torque limits.	30.000 s
	0.000...1800.000 s	Acceleration time 1.	10 = 1 s

No.	Name/Value	Description	Def/FbEq16
28.73	<i>Freq deceleration time 1</i>	Defines deceleration time 1 as the time required for the frequency to change from the frequency defined by parameter 46.02 Frequency scaling (not from parameter 30.14 Maximum frequency) to zero. If there is any doubt about the deceleration time being too short, ensure that DC overvoltage control (30.30 Overvoltage control) is on. Note: If a short deceleration time is needed for a high inertia application, the drive should be equipped with braking equipment such as a brake chopper and brake resistor.	30.000 s
	0.000...1800.000 s	Deceleration time 1.	10 = 1 s
28.74	<i>Freq acceleration time 2</i>	Defines acceleration time 2. See parameter 28.72 Freq acceleration time 1 .	60.000 s
	0.000...1800.000 s	Acceleration time 2.	10 = 1 s
28.75	<i>Freq deceleration time 2</i>	Defines deceleration time 2. See parameter 28.73 Freq deceleration time 1 .	60.000 s
	0.000...1800.000 s	Deceleration time 2.	10 = 1 s
28.76	<i>Freq ramp in zero source</i>	Selects a source that forces the frequency reference to zero. 0 = Force frequency reference to zero 1 = Normal operation	<i>Inactive</i>
	Active	0.	0
	Inactive	1.	1
	DI1	Digital input DI1 (10.02 DI delayed status , bit 0).	2
	DI2	Digital input DI2 (10.02 DI delayed status , bit 1).	3
	DI3	Digital input DI3 (10.02 DI delayed status , bit 2).	4
	DI4	Digital input DI4 (10.02 DI delayed status , bit 3).	5
	DI5	Digital input DI5 (10.02 DI delayed status , bit 4).	6
	DI6	Digital input DI6 (10.02 DI delayed status , bit 5).	7
	<i>Other [bit]</i>	Source selection (see Terms and abbreviations on page 358).	-
28.92	<i>Frequency ref act 3</i>	Displays the frequency reference after the function applied by parameter 28.13 Ext1 frequency function (if any), and after selection (19.11 Ext1/Ext2 selection). See control chain diagram Frequency reference selection on page 364 . This parameter is read-only.	-
	-500.00...500.00 Hz	Frequency reference after selection.	See par. 46.02
28.96	<i>Frequency ref act 7</i>	Displays the frequency reference after application of constant frequencies, control panel reference, etc. See control chain diagram Frequency reference selection on page 364 . This parameter is read-only.	-
	-500.00...500.00 Hz	Frequency reference 7.	See par. 46.02
28.97	<i>Frequency ref unlimited</i>	Displays the frequency reference after application of critical frequencies, but before ramping and limiting. See control chain diagram Frequency reference modification on page 365 . This parameter is read-only.	-
	-500.00...500.00 Hz	Frequency reference before ramping and limiting.	See par. 46.02

No.	Name/Value	Description	Def/FbEq16																																				
30 Limits		Drive operation limits.																																					
30.01	<i>Limit word 1</i>	Displays limit word 1. This parameter is read-only.	-																																				
<table border="1"> <thead> <tr> <th>Bit</th> <th>Name</th> <th>Description</th> </tr> </thead> <tbody> <tr> <td>0</td> <td>Torq lim</td> <td>1 = Drive torque is being limited by the motor control (undervoltage control, current control, load angle control or pull-out control), or by the torque limits defined by parameters.</td> </tr> <tr> <td>1...2</td> <td>Reserved</td> <td></td> </tr> <tr> <td>3</td> <td>Torq ref max</td> <td>1 = Torque reference is being limited by <i>30.20 Maximum torque 1</i>, <i>30.26 Power motoring limit</i> or <i>30.27 Power generating limit</i>.</td> </tr> <tr> <td>4</td> <td>Torq ref min</td> <td>1 = Torque reference is being limited by <i>30.19 Minimum torque 1</i>, <i>30.26 Power motoring limit</i> or <i>30.27 Power generating limit</i>.</td> </tr> <tr> <td>5</td> <td>Tlim max speed</td> <td>1 = Torque reference is being limited by the rush control because of maximum speed limit (<i>30.12 Maximum speed</i>)</td> </tr> <tr> <td>6</td> <td>Tlim min speed</td> <td>1 = Torque reference is being limited by the rush control because of minimum speed limit (<i>30.11 Minimum speed</i>)</td> </tr> <tr> <td>7</td> <td>Max speed ref lim</td> <td>1 = Speed reference is being limited by <i>30.12 Maximum speed</i></td> </tr> <tr> <td>8</td> <td>Min speed ref lim</td> <td>1 = Speed reference is being limited by <i>30.11 Minimum speed</i></td> </tr> <tr> <td>9</td> <td>Max freq ref lim</td> <td>1 = Frequency reference is being limited by <i>30.14 Maximum frequency</i></td> </tr> <tr> <td>10</td> <td>Min freq ref lim</td> <td>1 = Frequency reference is being limited by <i>30.13 Minimum frequency</i></td> </tr> <tr> <td>11...15</td> <td>Reserved</td> <td></td> </tr> </tbody> </table>				Bit	Name	Description	0	Torq lim	1 = Drive torque is being limited by the motor control (undervoltage control, current control, load angle control or pull-out control), or by the torque limits defined by parameters.	1...2	Reserved		3	Torq ref max	1 = Torque reference is being limited by <i>30.20 Maximum torque 1</i> , <i>30.26 Power motoring limit</i> or <i>30.27 Power generating limit</i> .	4	Torq ref min	1 = Torque reference is being limited by <i>30.19 Minimum torque 1</i> , <i>30.26 Power motoring limit</i> or <i>30.27 Power generating limit</i> .	5	Tlim max speed	1 = Torque reference is being limited by the rush control because of maximum speed limit (<i>30.12 Maximum speed</i>)	6	Tlim min speed	1 = Torque reference is being limited by the rush control because of minimum speed limit (<i>30.11 Minimum speed</i>)	7	Max speed ref lim	1 = Speed reference is being limited by <i>30.12 Maximum speed</i>	8	Min speed ref lim	1 = Speed reference is being limited by <i>30.11 Minimum speed</i>	9	Max freq ref lim	1 = Frequency reference is being limited by <i>30.14 Maximum frequency</i>	10	Min freq ref lim	1 = Frequency reference is being limited by <i>30.13 Minimum frequency</i>	11...15	Reserved	
Bit	Name	Description																																					
0	Torq lim	1 = Drive torque is being limited by the motor control (undervoltage control, current control, load angle control or pull-out control), or by the torque limits defined by parameters.																																					
1...2	Reserved																																						
3	Torq ref max	1 = Torque reference is being limited by <i>30.20 Maximum torque 1</i> , <i>30.26 Power motoring limit</i> or <i>30.27 Power generating limit</i> .																																					
4	Torq ref min	1 = Torque reference is being limited by <i>30.19 Minimum torque 1</i> , <i>30.26 Power motoring limit</i> or <i>30.27 Power generating limit</i> .																																					
5	Tlim max speed	1 = Torque reference is being limited by the rush control because of maximum speed limit (<i>30.12 Maximum speed</i>)																																					
6	Tlim min speed	1 = Torque reference is being limited by the rush control because of minimum speed limit (<i>30.11 Minimum speed</i>)																																					
7	Max speed ref lim	1 = Speed reference is being limited by <i>30.12 Maximum speed</i>																																					
8	Min speed ref lim	1 = Speed reference is being limited by <i>30.11 Minimum speed</i>																																					
9	Max freq ref lim	1 = Frequency reference is being limited by <i>30.14 Maximum frequency</i>																																					
10	Min freq ref lim	1 = Frequency reference is being limited by <i>30.13 Minimum frequency</i>																																					
11...15	Reserved																																						
0000h...FFFFh		Limit word 1.	1 = 1																																				

No.	Name/Value	Description	Def/FbEq16																																																			
30.02	<i>Torque limit status</i>	Displays the torque controller limitation status word. This parameter is read-only.	-																																																			
<table border="1"> <thead> <tr> <th>Bit</th> <th>Name</th> <th>Description</th> </tr> </thead> <tbody> <tr> <td>0</td> <td>Undervoltage</td> <td>*1 = Intermediate DC circuit undervoltage</td> </tr> <tr> <td>1</td> <td>Overvoltage</td> <td>*1 = Intermediate DC circuit overvoltage</td> </tr> <tr> <td>2</td> <td>Minimum torque</td> <td>*1 = Torque is being limited by 30.19 Minimum torque 1, 30.26 Power motoring limit or 30.27 Power generating limit</td> </tr> <tr> <td>3</td> <td>Maximum torque</td> <td>*1 = Torque is being limited by 30.20 Maximum torque 1, 30.26 Power motoring limit or 30.27 Power generating limit</td> </tr> <tr> <td>4</td> <td>Internal current</td> <td>1 = An inverter current limit (identified by bits 8...11) is active</td> </tr> <tr> <td>5</td> <td>Load angle</td> <td>(With permanent magnet motors and reluctance motors only) 1 = Load angle limit is active, ie, the motor cannot produce any more torque</td> </tr> <tr> <td>6</td> <td>Motor pullout</td> <td>(With asynchronous motors only) Motor pull-out limit is active, ie, the motor cannot produce any more torque</td> </tr> <tr> <td>7</td> <td colspan="2">Reserved</td> </tr> <tr> <td>8</td> <td>Thermal</td> <td>1 = Input current is being limited by the main circuit thermal limit</td> </tr> <tr> <td>9</td> <td>Max current</td> <td>*1 = Maximum output current (I_{MAX}) is being limited</td> </tr> <tr> <td>10</td> <td>User current</td> <td>*1 = Output current is being limited by 30.17 Maximum current</td> </tr> <tr> <td>11</td> <td>Thermal IGBT</td> <td>*1 = Output current is being limited by a calculated thermal current value</td> </tr> <tr> <td>12</td> <td>IGBT overtemperature</td> <td>*1 = Output current is being limited because of estimated IGBT temperature</td> </tr> <tr> <td>13</td> <td>IGBT overload</td> <td>*1 = Output current is being limited because of IGBT junction to case temperature</td> </tr> <tr> <td>14...15</td> <td colspan="2">Reserved</td> </tr> <tr> <td colspan="3">*Only one out of bits 0...3, and one out of bits 9...11 can be on simultaneously. The bit typically indicates the limit that is exceeded first.</td> </tr> </tbody> </table>				Bit	Name	Description	0	Undervoltage	*1 = Intermediate DC circuit undervoltage	1	Overvoltage	*1 = Intermediate DC circuit overvoltage	2	Minimum torque	*1 = Torque is being limited by 30.19 Minimum torque 1 , 30.26 Power motoring limit or 30.27 Power generating limit	3	Maximum torque	*1 = Torque is being limited by 30.20 Maximum torque 1 , 30.26 Power motoring limit or 30.27 Power generating limit	4	Internal current	1 = An inverter current limit (identified by bits 8...11) is active	5	Load angle	(With permanent magnet motors and reluctance motors only) 1 = Load angle limit is active, ie, the motor cannot produce any more torque	6	Motor pullout	(With asynchronous motors only) Motor pull-out limit is active, ie, the motor cannot produce any more torque	7	Reserved		8	Thermal	1 = Input current is being limited by the main circuit thermal limit	9	Max current	*1 = Maximum output current (I_{MAX}) is being limited	10	User current	*1 = Output current is being limited by 30.17 Maximum current	11	Thermal IGBT	*1 = Output current is being limited by a calculated thermal current value	12	IGBT overtemperature	*1 = Output current is being limited because of estimated IGBT temperature	13	IGBT overload	*1 = Output current is being limited because of IGBT junction to case temperature	14...15	Reserved		*Only one out of bits 0...3, and one out of bits 9...11 can be on simultaneously. The bit typically indicates the limit that is exceeded first.		
Bit	Name	Description																																																				
0	Undervoltage	*1 = Intermediate DC circuit undervoltage																																																				
1	Overvoltage	*1 = Intermediate DC circuit overvoltage																																																				
2	Minimum torque	*1 = Torque is being limited by 30.19 Minimum torque 1 , 30.26 Power motoring limit or 30.27 Power generating limit																																																				
3	Maximum torque	*1 = Torque is being limited by 30.20 Maximum torque 1 , 30.26 Power motoring limit or 30.27 Power generating limit																																																				
4	Internal current	1 = An inverter current limit (identified by bits 8...11) is active																																																				
5	Load angle	(With permanent magnet motors and reluctance motors only) 1 = Load angle limit is active, ie, the motor cannot produce any more torque																																																				
6	Motor pullout	(With asynchronous motors only) Motor pull-out limit is active, ie, the motor cannot produce any more torque																																																				
7	Reserved																																																					
8	Thermal	1 = Input current is being limited by the main circuit thermal limit																																																				
9	Max current	*1 = Maximum output current (I_{MAX}) is being limited																																																				
10	User current	*1 = Output current is being limited by 30.17 Maximum current																																																				
11	Thermal IGBT	*1 = Output current is being limited by a calculated thermal current value																																																				
12	IGBT overtemperature	*1 = Output current is being limited because of estimated IGBT temperature																																																				
13	IGBT overload	*1 = Output current is being limited because of IGBT junction to case temperature																																																				
14...15	Reserved																																																					
*Only one out of bits 0...3, and one out of bits 9...11 can be on simultaneously. The bit typically indicates the limit that is exceeded first.																																																						
0000h...FFFFh		Torque limitation status word.	1 = 1																																																			

No.	Name/Value	Description	Def/FbEq16
30.11	<i>Minimum speed</i>	<p>Defines together with 30.12 Maximum speed the allowed speed range. See the figure below.</p> <p>A positive or zero minimum speed value defines two ranges, one positive and one negative.</p> <p>⚠ WARNING! The absolute value of 30.11 Minimum speed must not be higher than the absolute value of 30.12 Maximum speed.</p> <p>⚠ WARNING! In speed control mode only. In frequency control mode, use frequency limits (30.13 and 30.14).</p>	0.00 rpm
<p>The figure contains three graphs with 'Speed' on the vertical axis and 'Time' on the horizontal axis. The origin is marked '0'.</p> <ul style="list-style-type: none"> Graph 1: Labeled '30.11 value < 0'. The vertical axis has points 30.12, 0, and 30.11. A single shaded horizontal bar labeled 'Speed range allowed' is shown between 30.11 and 30.12. Graph 2: Labeled '20.21 value = Request' and '30.11 value >= 0'. The vertical axis has points 30.12, 0, -(30.11), and -(30.12). Two shaded horizontal bars labeled 'Speed range allowed' are shown: one between 30.11 and 30.12, and another between -(30.11) and -(30.12). Graph 3: Labeled '20.21 value = Forward' and '30.11 value >= 0'. The vertical axis has points 30.12, 0, -(30.11), and -(30.12). A single shaded horizontal bar labeled 'Speed range allowed' is shown between 30.11 and 30.12. 			
	-30000.00... 30000.00 rpm	Minimum allowed speed.	See par. 46.01
30.12	<i>Maximum speed</i>	<p>Defines together with 30.11 Minimum speed the allowed speed range. See parameter 30.11 Minimum speed.</p> <p>Note: This parameter does not affect the speed acceleration and deceleration ramp times. See parameter 46.01 Speed scaling.</p>	1500.00 rpm; 1800.00 rpm (95.20 b0)
	-30000.00... 30000.00 rpm	Maximum speed.	See par. 46.01

No.	Name/Value	Description	Def/FbEq16
30.13	<p><i>Minimum frequency</i></p>	<p>Defines together with <i>30.14 Maximum frequency</i> the allowed frequency range. See the figure.</p> <p>A positive or zero minimum frequency value defines two ranges, one positive and one negative.</p> <p> WARNING! The absolute value of <i>30.13 Minimum frequency</i> must not be higher than the absolute value of <i>30.14 Maximum frequency</i>.</p> <p> WARNING! in frequency control mode only.</p> <div style="display: flex; justify-content: space-around; margin-top: 20px;"> <div data-bbox="165 391 509 598"> </div> <div data-bbox="565 391 946 598"> </div> <div data-bbox="565 606 946 813"> </div> </div>	0.00 Hz
	-500.00...500.00 Hz	Minimum frequency.	See par. 46.02
30.14	<p><i>Maximum frequency</i></p>	<p>Defines together with <i>30.13 Minimum frequency</i> the allowed frequency range. See parameter <i>30.13 Minimum frequency</i>.</p> <p>Note: This parameter does not affect the frequency acceleration and deceleration ramp times. See parameter 46.02 Frequency scaling.</p>	50.00 Hz; 60.00 Hz (95.20 b0)
	-500.00...500.00 Hz	Maximum frequency.	See par. 46.02
30.17	<p><i>Maximum current</i></p>	<p>Defines the maximum allowed motor current. This depends on the drive type; it is automatically determined on the basis of the rating.</p> <p>The system sets the default value to 90% of the rated current so you can increase the parameter value by 10% if needed.</p>	0.00 A
	0.00...30000.00 A	Maximum motor current.	1 = 1 A

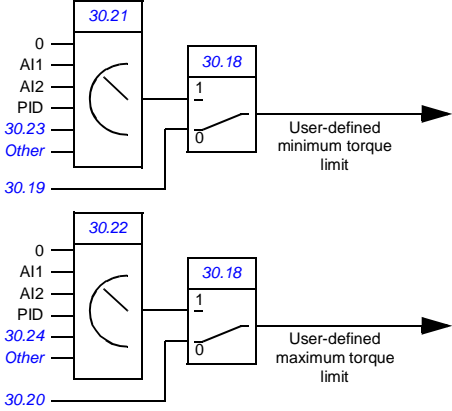
No.	Name/Value	Description	Def/FbEq16
30.18	<i>Torq lim sel</i>	<p>Selects a source that switches between two different predefined minimum torque limit sets.</p> <p>0 = minimum torque limit defined by 30.19 and maximum torque limit defined by 30.20 are active</p> <p>1 = minimum torque limit selected by 30.21 and maximum torque limit defined by 30.22 are active</p> <p>The user can define two sets of torque limits, and switch between the sets using a binary source such as a digital input.</p> <p>The first set of limits is defined by parameters 30.19 and 30.20. The second set has selector parameters for both the minimum (30.21) and maximum (30.22) limits that allows the use of a selectable analog source (such as an analog input).</p>  <p>Note: In addition to the user-defined limits, torque may be limited for other reasons (such as power limitation). See block diagram Torque limitation on page 372.</p>	<i>Torque limit set 1</i>
Torque limit set 1		0 (minimum torque limit defined by 30.19 and maximum torque limit defined by 30.20 are active).	0
Torque limit set 2		1 (minimum torque limit selected by 30.21 and maximum torque limit defined by 30.22 are active).	1
DI1		Digital input DI1 (10.02 DI delayed status , bit 0).	2
DI2		Digital input DI2 (10.02 DI delayed status , bit 1).	3
DI3		Digital input DI3 (10.02 DI delayed status , bit 2).	4
DI4		Digital input DI4 (10.02 DI delayed status , bit 3).	5
DI5		Digital input DI5 (10.02 DI delayed status , bit 4).	6
DI6		Digital input DI6 (10.02 DI delayed status , bit 5).	7
Reserved			8...10
EFB		Only for the DCU profile. DCU control word bit 15 received through the embedded fieldbus interface.	11
<i>Other [bit]</i>		Source selection (see Terms and abbreviations on page 358).	-

No.	Name/Value	Description	Def/FbEq16
30.19	<i>Minimum torque 1</i>	<p>Defines a minimum torque limit for the drive (in percent of nominal motor torque). See diagram at parameter 30.18 Torq lim sel.</p> <p>The limit is effective when</p> <ul style="list-style-type: none"> the source selected by 30.18 Torq lim sel is 0, or 30.18 is set to Torque limit set 1. <p>Note: If your application, like a pump or a fan, requires that the motor must rotate in one direction only, use speed/frequency limit (30.11 Minimum speed/30.13 Minimum frequency), or direction limit (20.21 Direction) to achieve this. Do not set parameter 30.19 Minimum torque 1 or 30.27 Power generating limit to 0%, as the drive is then not able to stop correctly.</p>	-300.0%
	-1600.0...0.0%	Minimum torque limit 1.	See par. 46.03
30.20	<i>Maximum torque 1</i>	<p>Defines a maximum torque limit for the drive (in percent of nominal motor torque). See diagram at parameter 30.18 Torq lim sel.</p> <p>The limit is effective when</p> <ul style="list-style-type: none"> the source selected by 30.18 Torq lim sel is 0, or 30.18 is set to Torque limit set 1. 	300.0%
	0.0...1600.0%	Maximum torque 1.	See par. 46.03
30.21	<i>Min torque 2 source</i>	<p>Defines the source of the minimum torque limit for the drive (in percent of nominal motor torque) when</p> <ul style="list-style-type: none"> the source selected by parameter 30.18 Torq lim sel is 1, or 30.18 is set to Torque limit set 2. <p>See diagram at 30.18 Torq lim sel.</p> <p>Note: Any positive values received from the selected source are inverted.</p>	<i>Minimum torque 2</i>
	Zero	None.	0
	AI1 scaled	12.12 AI1 scaled value (see page 400).	1
	AI2 scaled	12.22 AI2 scaled value (see page 402).	2
	Reserved		3...14
	PID	40.01 Process PID output actual (output of the process PID controller).	15
	Minimum torque 2	30.23 Minimum torque 2 .	16
	<i>Other</i>	Source selection (see Terms and abbreviations on page 358).	-
30.22	<i>Max torque 2 source</i>	<p>Defines the source of the maximum torque limit for the drive (in percent of nominal motor torque) when</p> <ul style="list-style-type: none"> the source selected by parameter 30.18 Torq lim sel is 1, or 30.18 is set to Torque limit set 2. <p>See diagram at 30.18 Torq lim sel.</p> <p>Note: Any negative values received from the selected source are inverted.</p>	<i>Maximum torque 2</i>
	Zero	None.	0
	AI1 scaled	12.12 AI1 scaled value (see page 400).	1
	AI2 scaled	12.22 AI2 scaled value (see page 402).	2
	Reserved		3...14

No.	Name/Value	Description	Def/FbEq16
	PID	40.01 Process PID output actual (output of the process PID controller).	15
	Maximum torque 2	30.24 Maximum torque 2 .	16
	<i>Other</i>	Source selection (see Terms and abbreviations on page 358).	-
30.23	Minimum torque 2	Defines the minimum torque limit for the drive (in percent of nominal motor torque) when <ul style="list-style-type: none"> the source selected by 30.18 Torq lim sel is 1, or 30.18 is set to Torque limit set 2 and <ul style="list-style-type: none"> 30.21 Min torque 2 source is set to Minimum torque 2. See diagram at 30.18 Torq lim sel .	-300.0%
	-1600.0...0.0%	Minimum torque limit 2.	See par. 46.03
30.24	Maximum torque 2	Defines the maximum torque limit for the drive (in percent of nominal motor torque) when The limit is effective when <ul style="list-style-type: none"> the source selected by 30.18 Torq lim sel is 1, or 30.18 is set to Torque limit set 2 and <ul style="list-style-type: none"> 30.22 Max torque 2 source is set to Maximum torque 2. See diagram at 30.18 Torq lim sel .	300.0%
	0.0...1600.0%	Maximum torque limit 2.	See par. 46.03
30.26	Power motoring limit	Defines the maximum allowed power fed by the inverter to the motor in percent of nominal motor power.	300.00%
	0.00...600.00%	Maximum motoring power.	1 = 1%
30.27	Power generating limit	Defines the maximum allowed power fed by the motor to the inverter in percent of nominal motor power. Note: If your application, like a pump or a fan, requires that the motor must rotate in one direction only, use speed/frequency limit (30.11 Minimum speed/30.13 Minimum frequency), or direction limit (20.21 Direction) to achieve this. Do not set parameter 30.19 Minimum torque 1 or 30.27 Power generating limit to 0%, as the drive is then not able to stop correctly.	-300.00%
	-600.00...0.00%	Maximum generating power.	1 = 1%
30.30	Overvoltage control	Enables the overvoltage control of the intermediate DC link. Fast braking of a high inertia load causes the voltage to rise to the overvoltage control limit. To prevent the DC voltage from exceeding the limit, the overvoltage controller automatically decreases the braking torque. Note: If the drive is equipped with a brake chopper and resistor, or a regenerative supply unit, the controller must be disabled.	Enable
	Disable	Overvoltage control disabled.	0
	Enable	Overvoltage control enabled.	1

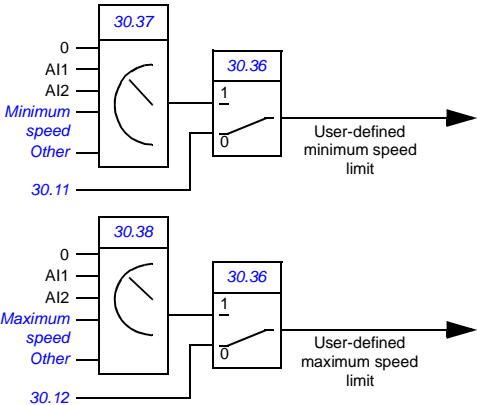
No.	Name/Value	Description	Def/FbEq16
30.31	<i>Undervoltage control</i>	Enables the undervoltage control of the intermediate DC link. If the DC voltage drops due to input power cut off, the undervoltage controller will automatically decrease the motor torque in order to keep the voltage above the lower limit. By decreasing the motor torque, the inertia of the load will cause regeneration back to the drive, keeping the DC link charged and preventing an undervoltage trip until the motor coasts to a stop. This will act as a power-loss ride-through functionality in systems with high inertia, such as a centrifuge or a fan.	<i>Enable</i>
	Disable	Undervoltage control disabled.	0
	Enable	Undervoltage control enabled.	1
30.35	<i>Thermal current limitation</i>	Enables/disables temperature-based output current limitation. The limitation should only be disabled if required by the application.	<i>Enable</i>
	Disable	Thermal current limitation disabled.	0
	Enable	Thermal current limitation enabled.	1
30.36	<i>Speed limit selection</i>	<p>Selects a source that switches between two different predefined adjustable speed limit sets.</p> <p>0 = minimum speed limit defined by 30.11 and maximum speed limit defined by 30.12 are active</p> <p>1 = minimum speed limit selected by 30.37 and maximum speed limit defined by 30.38 are active.</p> <p>The user can define two sets of speed limits, and switch between the sets using a binary source such as a digital input.</p> <p>The first set of limits is defined by parameters 30.11 <i>Minimum speed</i> and 30.12 <i>Maximum speed</i>. The second set has selector parameters for both the minimum (30.37) and maximum (30.38) limits that allows the use of a selectable analog source (such as an analog input).</p> 	<i>Not selected</i>
	Not selected	Adjustable speed limits are disabled. (Minimum speed limit defined by 30.11 <i>Minimum speed</i> and maximum speed limit defined by 30.12 <i>Maximum speed</i> are active).	0

No.	Name/Value	Description	Def/FbEq16
	Selected	Adjustable speed limits are enabled. (Minimum speed limit defined by 30.37 Minimum speed source and maximum speed limit defined by 30.38 Maximum speed source are active).	1
	Ext1 active	Adjustable speed limits are enabled if EXT1 is active.	2
	Ext2 active	Adjustable speed limits are enabled if EXT2 is active.	3
	Reserved		4
	DI1	Digital input DI1 (10.02 DI delayed status , bit 0).	5
	DI2	Digital input DI2 (10.02 DI delayed status , bit 1).	6
	DI3	Digital input DI3 (10.02 DI delayed status , bit 2).	7
	DI4	Digital input DI4 (10.02 DI delayed status , bit 3).	8
	DI5	Digital input DI5 (10.02 DI delayed status , bit 4).	9
	DI6	Digital input DI6 (10.02 DI delayed status , bit 5).	10
	Reserved		11
	<i>Other [bit]</i>	Source selection (see Terms and abbreviations on page 358).	-
30.37	Minimum speed source	Defines the source of a minimum speed limit for the drive when the source is selected by 30.36 Speed limit selection . Note: In vector motor control mode only. In scalar motor control mode, use frequency limits 30.13 and 30.14 .	Minimum speed
	Zero	None.	0
	AI1 scaled	12.12 AI1 scaled value (see page 400).	1
	AI2 scaled	12.22 AI2 scaled value (see page 402).	2
	Reserved		3...10
	Minimum speed	30.11 Minimum speed .	11
	<i>Other</i>	Source selection (see Terms and abbreviations on page 358).	-
30.38	Maximum speed source	Defines the source of a maximum speed limit for the drive when the source is selected by 30.36 Speed limit selection . Note: In vector motor control mode only. In scalar motor control mode, use frequency limits 30.13 and 30.14 .	Maximum speed
	Zero	None.	0
	AI1 scaled	12.12 AI1 scaled value (see page 400).	1
	AI2 scaled	12.22 AI2 scaled value (see page 402).	2
	Reserved		3...11
	Maximum speed	30.12 Maximum speed .	12
	<i>Other</i>	Source selection (see Terms and abbreviations on page 358).	-
31 Fault functions		Configuration of external events; selection of behavior of the drive upon fault situations.	
31.01	External event 1 source	Defines the source of external event 1. See also parameter 31.02 External event 1 type . 0 = Trigger event 1 = Normal operation	Inactive (true)
	Active (false)	0.	0
	Inactive (true)	1.	1
	Reserved		2

No.	Name/Value	Description	Def/FbEq16
	DI1	Digital input DI1 (<i>10.02 DI delayed status</i> , bit 0).	3
	DI2	Digital input DI2 (<i>10.02 DI delayed status</i> , bit 1).	4
	DI3	Digital input DI3 (<i>10.02 DI delayed status</i> , bit 2).	5
	DI4	Digital input DI4 (<i>10.02 DI delayed status</i> , bit 3).	6
	DI5	Digital input DI5 (<i>10.02 DI delayed status</i> , bit 4).	7
	DI6	Digital input DI6 (<i>10.02 DI delayed status</i> , bit 5).	8
	<i>Other [bit]</i>	Source selection (see <i>Terms and abbreviations</i> on page 358).	-
31.02	<i>External event 1 type</i>	Selects the type of external event 1.	<i>Fault</i>
	Fault	The external event generates a fault.	0
	Warning	The external event generates a warning.	1
31.03	<i>External event 2 source</i>	Defines the source of external event 2. See also parameter 31.04 External event 2 type . For the selections, see parameter 31.01 External event 1 source .	<i>Inactive (true)</i>
31.04	<i>External event 2 type</i>	Selects the type of external event 2.	<i>Fault</i>
	Fault	The external event generates a fault.	0
	Warning	The external event generates a warning.	1
31.05	<i>External event 3 source</i>	Defines the source of external event 3. See also parameter 31.06 External event 3 type . For the selections, see parameter 31.01 External event 1 source .	<i>Inactive (true)</i>
31.06	<i>External event 3 type</i>	Selects the type of external event 3.	<i>Fault</i>
	Fault	The external event generates a fault.	0
	Warning	The external event generates a warning.	1
31.07	<i>External event 4 source</i>	Defines the source of external event 4. See also parameter 31.08 External event 4 type . For the selections, see parameter 31.01 External event 1 source .	<i>Inactive (true)</i>
31.08	<i>External event 4 type</i>	Selects the type of external event 4.	<i>Fault</i>
	Fault	The external event generates a fault.	0
	Warning	The external event generates a warning.	1
31.09	<i>External event 5 source</i>	Defines the source of external event 5. See also parameter 31.10 External event 5 type . For the selections, see parameter 31.01 External event 1 source .	<i>Inactive (true)</i>
31.10	<i>External event 5 type</i>	Selects the type of external event 5.	<i>Fault</i>
	Fault	The external event generates a fault.	0
	Warning	The external event generates a warning.	1

No.	Name/Value	Description	Def/FbEq16
31.11	<i>Fault reset selection</i>	<p>Selects the source of an external fault reset signal. The signal resets the drive after a fault trip if the cause of the fault no longer exists.</p> <p>0 -> 1 = Reset</p> <p>Notes:</p> <ul style="list-style-type: none"> When the start and stop command is through digital inputs (parameter 20.01 Ext1 commands or 20.06 Ext2 commands) or from local control, and you want to use fault reset from the fieldbus, selection FBA A MCW bit 7 or EFB MCW bit 7 can be used. Whenever the drive is in external control through fieldbus (start and stop command and reference are received through fieldbus), the fault can be reset from the fieldbus regardless of the selection of this parameter. 	<i>Not used</i>
	Not used	0.	0
	Not used	1.	1
	DI1	Digital input DI1 (10.02 DI delayed status , bit 0).	2
	DI2	Digital input DI2 (10.02 DI delayed status , bit 1).	3
	DI3	Digital input DI3 (10.02 DI delayed status , bit 2).	4
	DI4	Digital input DI4 (10.02 DI delayed status , bit 3).	5
	DI5	Digital input DI5 (10.02 DI delayed status , bit 4).	6
	DI6	Digital input DI6 (10.02 DI delayed status , bit 5).	7
	Reserved		8...17
	Timed function 1	Bit 0 of 34.01 Timed functions status (see page 496).	18
	Timed function 2	Bit 1 of 34.01 Timed functions status (see page 496).	19
	Timed function 3	Bit 2 of 34.01 Timed functions status (see page 496).	20
	Reserved		21...23
	Supervision 1	Bit 0 of 32.01 Supervision status (see page 485).	24
	Supervision 2	Bit 1 of 32.01 Supervision status (see page 485).	25
	Supervision 3	Bit 2 of 32.01 Supervision status (see page 485).	26
	Reserved		27...29
	FBA A MCW bit 7	Control word bit 7 received through fieldbus interface A.	30
	Reserved		31
	EFB MCW bit 7	Control word bit 7 received through the embedded fieldbus interface.	32
	<i>Other [bit]</i>	Source selection (see Terms and abbreviations on page 358).	-

No.	Name/Value	Description	Def/FbEq16																								
31.12	<i>Autoreset selection</i>	<p>Selects faults that are automatically reset. The parameter is a 16-bit word with each bit corresponding to a fault type. Whenever a bit is set to 1, the corresponding fault is automatically reset.</p> <p>Faults marked with an asterisk (*) in the table below will be reset on the inverter unit (INU) and the supply unit (LSU).</p> <p>Note: Infinite reset trials are executed if parameter <i>70.02 Override enable</i> is set to value <i>On, critical</i>.</p> <p> WARNING! Before you activate the function, make sure that no dangerous situations can occur. The function restarts the drive automatically and continues operation after a fault.</p> <p>The bits of this binary number correspond to the following faults:</p>	000Ch																								
<table border="1"> <thead> <tr> <th>Bit</th> <th>Fault</th> </tr> </thead> <tbody> <tr> <td>0</td> <td>Overcurrent*</td> </tr> <tr> <td>1</td> <td>Overvoltage*</td> </tr> <tr> <td>2</td> <td>Undervoltage*</td> </tr> <tr> <td>3</td> <td>AI supervision fault</td> </tr> <tr> <td>4...9</td> <td>Reserved</td> </tr> <tr> <td>10</td> <td>Selectable fault (see parameter <i>31.13 Selectable fault</i>)</td> </tr> <tr> <td>11</td> <td>External fault 1 (from source selected by parameter <i>31.01 External event 1 source</i>)</td> </tr> <tr> <td>12</td> <td>External fault 2 (from source selected by parameter <i>31.03 External event 2 source</i>)</td> </tr> <tr> <td>13</td> <td>External fault 3 (from source selected by parameter <i>31.05 External event 3 source</i>)</td> </tr> <tr> <td>14</td> <td>External fault 4 (from source selected by parameter <i>31.07 External event 4 source</i>)</td> </tr> <tr> <td>15</td> <td>External fault 5 (from source selected by parameter <i>31.09 External event 5 source</i>)</td> </tr> </tbody> </table>				Bit	Fault	0	Overcurrent*	1	Overvoltage*	2	Undervoltage*	3	AI supervision fault	4...9	Reserved	10	Selectable fault (see parameter <i>31.13 Selectable fault</i>)	11	External fault 1 (from source selected by parameter <i>31.01 External event 1 source</i>)	12	External fault 2 (from source selected by parameter <i>31.03 External event 2 source</i>)	13	External fault 3 (from source selected by parameter <i>31.05 External event 3 source</i>)	14	External fault 4 (from source selected by parameter <i>31.07 External event 4 source</i>)	15	External fault 5 (from source selected by parameter <i>31.09 External event 5 source</i>)
Bit	Fault																										
0	Overcurrent*																										
1	Overvoltage*																										
2	Undervoltage*																										
3	AI supervision fault																										
4...9	Reserved																										
10	Selectable fault (see parameter <i>31.13 Selectable fault</i>)																										
11	External fault 1 (from source selected by parameter <i>31.01 External event 1 source</i>)																										
12	External fault 2 (from source selected by parameter <i>31.03 External event 2 source</i>)																										
13	External fault 3 (from source selected by parameter <i>31.05 External event 3 source</i>)																										
14	External fault 4 (from source selected by parameter <i>31.07 External event 4 source</i>)																										
15	External fault 5 (from source selected by parameter <i>31.09 External event 5 source</i>)																										
	0000h...FFFFh	Automatic reset configuration word.	1 = 1																								
31.13	<i>Selectable fault</i>	Defines the fault that can be automatically reset using parameter <i>31.12 Autoreset selection</i> , bit 10. Faults are listed in chapter <i>Fault tracing</i> (page 240).	0000h																								
	0000h...FFFFh	Fault code.	1 = 1																								
31.14	<i>Number of trials</i>	<p>Defines the maximum number of automatic resets that the drive is allowed to attempt within the time specified by <i>31.15 Total trials time</i>.</p> <p>If the fault persists, subsequent reset attempts will be made at intervals defined by <i>31.16 Delay time</i>.</p> <p>The faults to be automatically reset are defined by <i>31.12 Autoreset selection</i>.</p>	5																								
	0...5	Number of automatic resets.	1 = 1																								
31.15	<i>Total trials time</i>	<p>Defines a time window for automatic fault resets. The maximum number of attempts made during any period of this length is defined by <i>31.14 Number of trials</i>.</p> <p>Note: If the fault condition remains and cannot be reset, each reset attempt will generate an event and start a new time window. In practice, if the specified number of resets (<i>31.14</i>) at specified intervals (<i>31.16</i>) take longer than the value of <i>31.15</i>, the drive will continue to attempt resetting the fault until the cause is eventually removed.</p>	30.0 s																								
	1.0...600.0 s	Time for automatic resets.	10 = 1 s																								

No.	Name/Value	Description	Def/FbEq16
31.16	<i>Delay time</i>	Defines the time that the drive will wait after a fault before attempting an automatic reset. See parameter 31.12 Autoreset selection .	5.0 s
	0.0...120.0 s	Autoreset delay.	10 = 1 s
31.19	<i>Motor phase loss</i>	Selects how the drive reacts when a motor phase loss is detected. In scalar motor control mode: <ul style="list-style-type: none"> The supervision activates above 10% of the motor nominal frequency. If any of the phase currents stays very small for a certain time limit, the output phase loss fault is given. If the motor nominal current is below 1/6 of the drive nominal current or there is no motor connected, ABB recommends to disable the motor output phase loss function. 	<i>Fault</i>
	No action	No action taken.	0
	Fault	Drive trips on fault 3381 Output phase loss .	1
31.20	<i>Earth fault</i>	Selects how the drive reacts when an earth fault or current unbalance is detected in the motor or the motor cable.	<i>Fault</i>
	No action	No action taken.	0
	Warning	The drive generates an A2B3 Earth leakage warning.	1
	Fault	The drive trips on fault 2330 Earth leakage .	2
31.21	<i>Supply phase loss</i>	Selects how the drive reacts when a supply phase loss is detected.	<i>Fault</i>
	No action	No action taken. The output current is limited to 50% when supply phase loss is detected. No fault or warning is given.	0
	Fault	Drive trips on fault 3130 Input phase loss .	1

No.	Name/Value	Description	Def/FbEq16																								
31.22	<i>STO indication run/stop</i>	<p>Selects which indications are given when one or both Safe torque off (STO) signals are switched off or lost. The indications also depend on whether the drive is running or stopped when this occurs.</p> <p>The tables at each selection below show the indications generated with that particular setting.</p> <p>Notes:</p> <ul style="list-style-type: none"> This parameter does not affect the operation of the STO function itself. The STO function will operate regardless of the setting of this parameter: a running drive will stop upon removal of one or both STO signals, and will not start until both STO signals are restored and all faults reset. The loss of only one STO signal always generates a fault as it is interpreted as a malfunction. <p>For more information on the STO, see chapter <i>The Safe torque off function</i> in the <i>Hardware manual</i> of the drive.</p>	<i>Fault/Fault</i>																								
	Fault/Fault	<table border="1" data-bbox="340 564 848 815"> <thead> <tr> <th colspan="2">Inputs</th> <th rowspan="2">Indication (running or stopped)</th> </tr> <tr> <th>IN1</th> <th>IN2</th> </tr> </thead> <tbody> <tr> <td>0</td> <td>0</td> <td>Fault <i>5091 Safe torque off</i></td> </tr> <tr> <td>0</td> <td>1</td> <td>Faults <i>5091 Safe torque off</i> and <i>FA81 Safe torque off 1</i></td> </tr> <tr> <td>1</td> <td>0</td> <td>Faults <i>5091 Safe torque off</i> and <i>FA82 Safe torque off 2</i></td> </tr> <tr> <td>1</td> <td>1</td> <td>(Normal operation)</td> </tr> </tbody> </table>	Inputs		Indication (running or stopped)	IN1	IN2	0	0	Fault <i>5091 Safe torque off</i>	0	1	Faults <i>5091 Safe torque off</i> and <i>FA81 Safe torque off 1</i>	1	0	Faults <i>5091 Safe torque off</i> and <i>FA82 Safe torque off 2</i>	1	1	(Normal operation)	0							
Inputs		Indication (running or stopped)																									
IN1	IN2																										
0	0	Fault <i>5091 Safe torque off</i>																									
0	1	Faults <i>5091 Safe torque off</i> and <i>FA81 Safe torque off 1</i>																									
1	0	Faults <i>5091 Safe torque off</i> and <i>FA82 Safe torque off 2</i>																									
1	1	(Normal operation)																									
	Fault/Warning	<table border="1" data-bbox="340 884 848 1198"> <thead> <tr> <th colspan="2">Inputs</th> <th colspan="2">Indication</th> </tr> <tr> <th>IN1</th> <th>IN2</th> <th>Running</th> <th>Stopped</th> </tr> </thead> <tbody> <tr> <td>0</td> <td>0</td> <td>Fault <i>5091 Safe torque off</i></td> <td>Warning <i>A5A0 Safe torque off</i></td> </tr> <tr> <td>0</td> <td>1</td> <td>Faults <i>5091 Safe torque off</i> and <i>FA81 Safe torque off 1</i></td> <td>Warning <i>A5A0 Safe torque off</i> and fault <i>FA81 Safe torque off 1</i></td> </tr> <tr> <td>1</td> <td>0</td> <td>Faults <i>5091 Safe torque off</i> and <i>FA82 Safe torque off 2</i></td> <td>Warning <i>A5A0 Safe torque off</i> and fault <i>FA82 Safe torque off 2</i></td> </tr> <tr> <td>1</td> <td>1</td> <td colspan="2">(Normal operation)</td> </tr> </tbody> </table>	Inputs		Indication		IN1	IN2	Running	Stopped	0	0	Fault <i>5091 Safe torque off</i>	Warning <i>A5A0 Safe torque off</i>	0	1	Faults <i>5091 Safe torque off</i> and <i>FA81 Safe torque off 1</i>	Warning <i>A5A0 Safe torque off</i> and fault <i>FA81 Safe torque off 1</i>	1	0	Faults <i>5091 Safe torque off</i> and <i>FA82 Safe torque off 2</i>	Warning <i>A5A0 Safe torque off</i> and fault <i>FA82 Safe torque off 2</i>	1	1	(Normal operation)		1
Inputs		Indication																									
IN1	IN2	Running	Stopped																								
0	0	Fault <i>5091 Safe torque off</i>	Warning <i>A5A0 Safe torque off</i>																								
0	1	Faults <i>5091 Safe torque off</i> and <i>FA81 Safe torque off 1</i>	Warning <i>A5A0 Safe torque off</i> and fault <i>FA81 Safe torque off 1</i>																								
1	0	Faults <i>5091 Safe torque off</i> and <i>FA82 Safe torque off 2</i>	Warning <i>A5A0 Safe torque off</i> and fault <i>FA82 Safe torque off 2</i>																								
1	1	(Normal operation)																									

No.	Name/Value	Description	Def/FbEq16																								
	Fault/Event	<table border="1"> <thead> <tr> <th colspan="2">Inputs</th> <th colspan="2">Indication</th> </tr> <tr> <th>IN1</th> <th>IN2</th> <th>Running</th> <th>Stopped</th> </tr> </thead> <tbody> <tr> <td>0</td> <td>0</td> <td>Fault <i>5091 Safe torque off</i></td> <td>Event <i>B5A0 STO event</i></td> </tr> <tr> <td>0</td> <td>1</td> <td>Faults <i>5091 Safe torque off</i> and <i>FA81 Safe torque off 1</i></td> <td>Event <i>B5A0 STO event</i> and fault <i>FA81 Safe torque off 1</i></td> </tr> <tr> <td>1</td> <td>0</td> <td>Faults <i>5091 Safe torque off</i> and <i>FA82 Safe torque off 2</i></td> <td>Event <i>B5A0 STO event</i> and fault <i>FA82 Safe torque off 2</i></td> </tr> <tr> <td>1</td> <td>1</td> <td colspan="2">(Normal operation)</td> </tr> </tbody> </table>	Inputs		Indication		IN1	IN2	Running	Stopped	0	0	Fault <i>5091 Safe torque off</i>	Event <i>B5A0 STO event</i>	0	1	Faults <i>5091 Safe torque off</i> and <i>FA81 Safe torque off 1</i>	Event <i>B5A0 STO event</i> and fault <i>FA81 Safe torque off 1</i>	1	0	Faults <i>5091 Safe torque off</i> and <i>FA82 Safe torque off 2</i>	Event <i>B5A0 STO event</i> and fault <i>FA82 Safe torque off 2</i>	1	1	(Normal operation)		2
Inputs		Indication																									
IN1	IN2	Running	Stopped																								
0	0	Fault <i>5091 Safe torque off</i>	Event <i>B5A0 STO event</i>																								
0	1	Faults <i>5091 Safe torque off</i> and <i>FA81 Safe torque off 1</i>	Event <i>B5A0 STO event</i> and fault <i>FA81 Safe torque off 1</i>																								
1	0	Faults <i>5091 Safe torque off</i> and <i>FA82 Safe torque off 2</i>	Event <i>B5A0 STO event</i> and fault <i>FA82 Safe torque off 2</i>																								
1	1	(Normal operation)																									
	Warning/Warning	<table border="1"> <thead> <tr> <th colspan="2">Inputs</th> <th rowspan="2">Indication (running or stopped)</th> </tr> <tr> <th>IN1</th> <th>IN2</th> </tr> </thead> <tbody> <tr> <td>0</td> <td>0</td> <td>Warning <i>A5A0 Safe torque off</i></td> </tr> <tr> <td>0</td> <td>1</td> <td>Warning <i>A5A0 Safe torque off</i> and fault <i>FA81 Safe torque off 1</i></td> </tr> <tr> <td>1</td> <td>0</td> <td>Warning <i>A5A0 Safe torque off</i> and fault <i>FA82 Safe torque off 2</i></td> </tr> <tr> <td>1</td> <td>1</td> <td>(Normal operation)</td> </tr> </tbody> </table>	Inputs		Indication (running or stopped)	IN1	IN2	0	0	Warning <i>A5A0 Safe torque off</i>	0	1	Warning <i>A5A0 Safe torque off</i> and fault <i>FA81 Safe torque off 1</i>	1	0	Warning <i>A5A0 Safe torque off</i> and fault <i>FA82 Safe torque off 2</i>	1	1	(Normal operation)	3							
Inputs		Indication (running or stopped)																									
IN1	IN2																										
0	0	Warning <i>A5A0 Safe torque off</i>																									
0	1	Warning <i>A5A0 Safe torque off</i> and fault <i>FA81 Safe torque off 1</i>																									
1	0	Warning <i>A5A0 Safe torque off</i> and fault <i>FA82 Safe torque off 2</i>																									
1	1	(Normal operation)																									
	Event/Event	<table border="1"> <thead> <tr> <th colspan="2">Inputs</th> <th rowspan="2">Indication (running or stopped)</th> </tr> <tr> <th>IN1</th> <th>IN2</th> </tr> </thead> <tbody> <tr> <td>0</td> <td>0</td> <td>Event <i>B5A0 STO event</i></td> </tr> <tr> <td>0</td> <td>1</td> <td>Event <i>B5A0 STO event</i> and fault <i>FA81 Safe torque off 1</i></td> </tr> <tr> <td>1</td> <td>0</td> <td>Event <i>B5A0 STO event</i> and fault <i>FA82 Safe torque off 2</i></td> </tr> <tr> <td>1</td> <td>1</td> <td>(Normal operation)</td> </tr> </tbody> </table>	Inputs		Indication (running or stopped)	IN1	IN2	0	0	Event <i>B5A0 STO event</i>	0	1	Event <i>B5A0 STO event</i> and fault <i>FA81 Safe torque off 1</i>	1	0	Event <i>B5A0 STO event</i> and fault <i>FA82 Safe torque off 2</i>	1	1	(Normal operation)	4							
Inputs		Indication (running or stopped)																									
IN1	IN2																										
0	0	Event <i>B5A0 STO event</i>																									
0	1	Event <i>B5A0 STO event</i> and fault <i>FA81 Safe torque off 1</i>																									
1	0	Event <i>B5A0 STO event</i> and fault <i>FA82 Safe torque off 2</i>																									
1	1	(Normal operation)																									
	No indication/No indication	<table border="1"> <thead> <tr> <th colspan="2">Inputs</th> <th rowspan="2">Indication (running or stopped)</th> </tr> <tr> <th>IN1</th> <th>IN2</th> </tr> </thead> <tbody> <tr> <td>0</td> <td>0</td> <td>None</td> </tr> <tr> <td>0</td> <td>1</td> <td>Fault <i>FA81 Safe torque off 1</i></td> </tr> <tr> <td>1</td> <td>0</td> <td>Fault <i>FA82 Safe torque off 2</i></td> </tr> <tr> <td>1</td> <td>1</td> <td>(Normal operation)</td> </tr> </tbody> </table>	Inputs		Indication (running or stopped)	IN1	IN2	0	0	None	0	1	Fault <i>FA81 Safe torque off 1</i>	1	0	Fault <i>FA82 Safe torque off 2</i>	1	1	(Normal operation)	5							
Inputs		Indication (running or stopped)																									
IN1	IN2																										
0	0	None																									
0	1	Fault <i>FA81 Safe torque off 1</i>																									
1	0	Fault <i>FA82 Safe torque off 2</i>																									
1	1	(Normal operation)																									
31.23	<i>Wiring or earth fault</i>	Selects how the drive reacts to incorrect input power and motor cable connection (ie. input power cable is connected to drive motor connection).	<i>Fault</i>																								
	No action	No action taken.	0																								
	Fault	Drive trips on fault <i>3181 Wiring or earth fault</i> .	1																								

No.	Name/Value	Description	Def/FbEq16
31.24	<i>Stall function</i>	Selects how the drive reacts to a motor stall condition. A stall condition is defined as follows: <ul style="list-style-type: none"> The drive exceeds the stall current limit (31.25 Stall current limit), and the output frequency is below the level set by parameter 31.27 Stall frequency limit or the motor speed is below the level set by parameter 31.26 Stall speed limit, and the conditions above have been true longer than the time set by parameter 31.28 Stall time. 	<i>No action</i>
	No action	None (stall supervision disabled).	0
	Warning	Drive generates warning A780 Motor stall .	1
	Fault	Drive trips on fault 7121 Motor stall .	2
31.25	<i>Stall current limit</i>	Stall current limit in percent of the nominal current of the motor. See parameter 31.24 Stall function .	200.0%
	0.0...1600.0%	Stall current limit.	10 = 1%
31.26	<i>Stall speed limit</i>	Stall speed limit in rpm. See parameter 31.24 Stall function .	150.00 rpm; 180.00 rpm (95.20 b0)
	0.00...10000.00 rpm	Stall speed limit.	See par. 46.01
31.27	<i>Stall frequency limit</i>	Stall frequency limit. See parameter 31.24 Stall function . Note: Setting the limit below 10 Hz is not recommended.	15.00 Hz; 18.00 Hz (95.20 b0)
	0.00...1000.00 Hz	Stall frequency limit.	See par. 46.02
31.28	<i>Stall time</i>	Stall time. See parameter 31.24 Stall function .	20 s
	0...3600 s	Stall time.	1 = 1 s

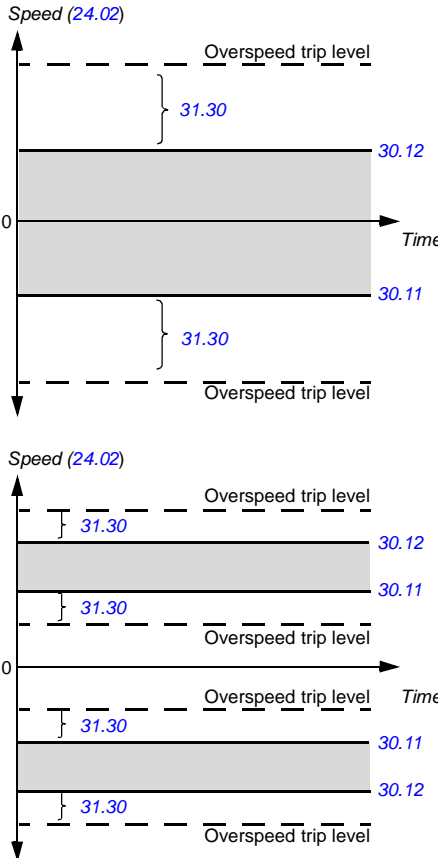
No.	Name/Value	Description	Def/FbEq16
31.30	<i>Overspeed trip margin</i>	<p>Defines, together with 30.11 Minimum speed and 30.12 Maximum speed, the maximum allowed speed of the motor (overspeed protection). If the speed (24.02 Used speed feedback) exceeds the speed limit defined by parameter 30.11 or 30.12 by more than the value of this parameter, the drive trips on the 7310 Overspeed fault.</p> <p>WARNING! This function only supervises the speed in vector motor control mode. The function is not effective in scalar motor control mode.</p> <p>Example: If the maximum speed is 1420 rpm and speed trip margin is 300 rpm, the drive trips at 1720 rpm.</p> 	500.00 rpm
	0.00...10000.00 rpm	Overspeed trip margin.	See par. 46.01

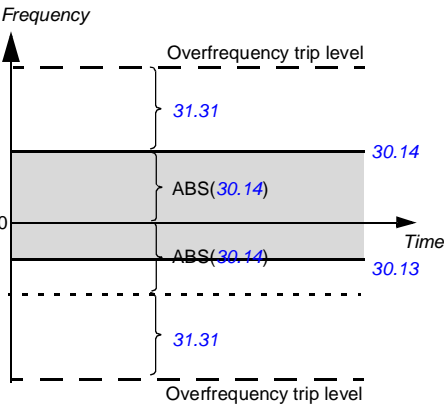
No.	Name/Value	Description	Def/FbEq16
31.31	<i>Frequency trip margin</i>	<p>Defines, together with 30.13 Minimum frequency and 30.14 Maximum frequency, the maximum allowed frequency of the motor (overfrequency protection). The absolute value of this overfrequency trip level is calculated by adding the value of this parameter to the higher of the absolute values of 30.13 Minimum frequency and 30.14 Maximum frequency.</p> <p>If the output frequency (01.06 Output frequency) exceeds the overfrequency trip level (ie. the absolute value of the output frequency exceeds the absolute value of the overfrequency trip level), the drive trips on fault 73F0 Overfrequency.</p> <p>WARNING! This function only supervises the frequency in scalar motor control mode.</p> <p> Frequency</p>  <p>The graph shows Frequency on the vertical axis and Time on the horizontal axis. A horizontal dashed line at the top is labeled 'Overfrequency trip level'. A horizontal solid line below it is labeled '30.14'. A shaded rectangular area between the '30.14' line and a lower solid line is labeled 'ABS(30.14)'. Below that, another solid line is labeled 'ABS(30.14)'. A horizontal dashed line at the bottom is labeled '30.13'. A bracket on the left side of the graph, spanning from the '30.13' line to the 'Overfrequency trip level' line, is labeled '31.31'. The origin is marked '0'.</p>	15.00 Hz
	0.00...10000.00 Hz	Overfrequency trip margin.	1 = 1 Hz
31.32	<i>Emergency ramp supervision</i>	<p>Parameters 31.32 Emergency ramp supervision and 31.33 Emergency ramp supervision delay, together with the derivative of 24.02 Used speed feedback, provide a supervision function for emergency stop modes Off1 and Off3.</p> <p>The supervision is based on either</p> <ul style="list-style-type: none"> observing the time within which the motor stops, or comparing the actual and expected deceleration rates. <p>If this parameter is set to 0%, the maximum stop time is directly set in parameter 31.33. Otherwise, 31.32 defines the maximum allowed deviation from the expected deceleration rate, which is calculated from parameters 23.11...23.15 (Off1) or 23.23 Emergency stop time (Off3). If the actual deceleration rate (24.02) deviates too much from the expected rate, the drive trips on fault 73B0 Emergency ramp failed, sets bit 8 of 06.17 Drive status word 2, and coasts to a stop.</p> <p>If 31.32 is set to 0% and 31.33 is set to 0 s, the emergency stop ramp supervision is disabled.</p> <p>See also parameter 21.04 Emergency stop mode.</p>	0%
	0...300%	Maximum deviation from expected deceleration rate.	1 = 1%

No.	Name/Value	Description	Def/FbEq16																					
31.33	<i>Emergency ramp supervision delay</i>	If parameter 31.32 Emergency ramp supervision is set to 0%, this parameter defines the maximum time an emergency stop (mode Off1 or Off3) is allowed to take. If the motor has not stopped when the time elapses, the drive trips on fault 73B0 Emergency ramp failed , sets bit 8 of 06.17 Drive status word 2 , and coasts to a stop. If 31.32 is set to a value other than 0%, this parameter defines a delay between the receipt of the emergency stop command and the activation of the supervision. It is recommended to specify a short delay to allow the speed change rate to stabilize.	0 s																					
	0...100 s	Maximum ramp-down time, or supervision activation delay.	1 = 1 s																					
31.40	<i>Disable warning messages</i>	Selects warnings to be suppressed. This parameter is a 16-bit word with each bit corresponding to a warning. Whenever a bit is set to 1, the corresponding warning is suppressed.	0000h																					
		<table border="1"> <thead> <tr> <th>Bit</th> <th>Name</th> <th>Description</th> </tr> </thead> <tbody> <tr> <td>0</td> <td>Reserved</td> <td></td> </tr> <tr> <td>1</td> <td>DC link undervoltage</td> <td>1 = Warning A3A2 DC link undervoltage is suppressed.</td> </tr> <tr> <td>2...4</td> <td>Reserved</td> <td></td> </tr> <tr> <td>5</td> <td>Emergency stop off2</td> <td>1 = Warning AFE1 Emergency stop (off2) is suppressed.</td> </tr> <tr> <td>4</td> <td>Emergency stop off1, off3</td> <td>1 = Warning AFE2 Emergency stop (off1 or off3) is suppressed.</td> </tr> <tr> <td>7...15</td> <td>Reserved</td> <td></td> </tr> </tbody> </table>	Bit	Name	Description	0	Reserved		1	DC link undervoltage	1 = Warning A3A2 DC link undervoltage is suppressed.	2...4	Reserved		5	Emergency stop off2	1 = Warning AFE1 Emergency stop (off2) is suppressed.	4	Emergency stop off1, off3	1 = Warning AFE2 Emergency stop (off1 or off3) is suppressed.	7...15	Reserved		
Bit	Name	Description																						
0	Reserved																							
1	DC link undervoltage	1 = Warning A3A2 DC link undervoltage is suppressed.																						
2...4	Reserved																							
5	Emergency stop off2	1 = Warning AFE1 Emergency stop (off2) is suppressed.																						
4	Emergency stop off1, off3	1 = Warning AFE2 Emergency stop (off1 or off3) is suppressed.																						
7...15	Reserved																							
	0000h...FFFFh	Word for disabling warnings.	1 = 1																					

32 Supervision		Configuration of signal supervision functions 1...6. Six values can be chosen to be monitored; a warning or fault is generated whenever predefined limits are exceeded. See also section Diagnostics menu (page 230).																									
32.01	<i>Supervision status</i>	Signal supervision status word. Indicates whether the values monitored by the signal supervision functions are within or outside their respective limits. Note: This word is independent of the drive actions defined by parameters 32.06 , 32.16 , 32.26 , 32.36 , 32.46 and 32.56 .	0000b																								
		<table border="1"> <thead> <tr> <th>Bit</th> <th>Name</th> <th>Description</th> </tr> </thead> <tbody> <tr> <td>0</td> <td>Supervision 1 active</td> <td>1 = Signal selected by 32.07 is outside its limits.</td> </tr> <tr> <td>1</td> <td>Supervision 2 active</td> <td>1 = Signal selected by 32.17 is outside its limits.</td> </tr> <tr> <td>2</td> <td>Supervision 3 active</td> <td>1 = Signal selected by 32.27 is outside its limits.</td> </tr> <tr> <td>3</td> <td>Supervision 4 active</td> <td>1 = Signal selected by 32.37 is outside its limits.</td> </tr> <tr> <td>4</td> <td>Supervision 5 active</td> <td>1 = Signal selected by 32.47 is outside its limits.</td> </tr> <tr> <td>5</td> <td>Supervision 6 active</td> <td>1 = Signal selected by 32.27 is outside its limits.</td> </tr> <tr> <td>6...15</td> <td>Reserved</td> <td></td> </tr> </tbody> </table>	Bit	Name	Description	0	Supervision 1 active	1 = Signal selected by 32.07 is outside its limits.	1	Supervision 2 active	1 = Signal selected by 32.17 is outside its limits.	2	Supervision 3 active	1 = Signal selected by 32.27 is outside its limits.	3	Supervision 4 active	1 = Signal selected by 32.37 is outside its limits.	4	Supervision 5 active	1 = Signal selected by 32.47 is outside its limits.	5	Supervision 6 active	1 = Signal selected by 32.27 is outside its limits.	6...15	Reserved		
Bit	Name	Description																									
0	Supervision 1 active	1 = Signal selected by 32.07 is outside its limits.																									
1	Supervision 2 active	1 = Signal selected by 32.17 is outside its limits.																									
2	Supervision 3 active	1 = Signal selected by 32.27 is outside its limits.																									
3	Supervision 4 active	1 = Signal selected by 32.37 is outside its limits.																									
4	Supervision 5 active	1 = Signal selected by 32.47 is outside its limits.																									
5	Supervision 6 active	1 = Signal selected by 32.27 is outside its limits.																									
6...15	Reserved																										
	0000h...FFFFh	Signal supervision status word.	1 = 1																								

No.	Name/Value	Description	Def/FbEq16
32.05	<i>Supervision 1 function</i>	Selects the mode of signal supervision function 1. Determines how the monitored signal (see parameter 32.07) is compared to its lower and upper limits (32.09 and 32.10 respectively). The action to be taken when the condition is fulfilled is selected by 32.06.	<i>Disabled</i>
	Disabled	Signal supervision 1 not in use.	0
	Low	Action is taken whenever signal is below 'Supervision low' limit - 0.5 * hysteresis. Action is deactivated whenever signal is above 'Supervision low' limit + 0.5 * hysteresis.	1
	High	Action is taken whenever signal is above 'Supervision High' limit + 0.5 * hysteresis. Action is deactivated whenever signal is below 'Supervision High' limit - 0.5 * hysteresis.	2
	Abs low	Action is taken whenever absolute value of signal is below absolute value of 'Supervision Low' limit - 0.5 * hysteresis. Action is deactivated whenever absolute value of signal is above absolute value of 'Supervision Low' limit + 0.5 * hysteresis.	3
	Abs high	Action is taken whenever absolute value of signal is above absolute value of 'Supervision High' limit + 0.5 * hysteresis. Action is deactivated whenever absolute value of signal is below absolute value of 'Supervision High' limit - 0.5 * hysteresis	4
	Both	Action is taken whenever signal is above 'Supervision High' limit + 0.5 * hysteresis or below 'Supervision Low' limit - 0.5*hysteresis. Action is deactivated whenever signal is in between 'Supervision High' limit - 0.5 * hysteresis and 'Supervision Low' limit + 0.5*hysteresis.	5
	Abs both	Action is taken whenever absolute value of signal is above absolute value of 'Supervision High' limit + 0.5 * hysteresis or below absolute value of 'Supervision Low' limit - 0.5*hysteresis. Action is deactivated whenever absolute value of signal is in between absolute value of 'Supervision High' limit - 0.5 * hysteresis and absolute value of 'Supervision Low' limit + 0.5*hysteresis.	6
	Hysteresis	Action is taken whenever signal is above 'Supervision High' limit + 0.5 * hysteresis. Action is deactivated whenever signal is below 'Supervision Low' limit - 0.5 * hysteresis. The status is unchanged when signal value is in between 'Supervision High' limit + 0.5 * hysteresis and 'Supervision Low' limit - 0.5 * hysteresis.	7
	Low falling	Action taken whenever the signal falls from a value higher than 'Supervision low' limit + 0.5 * hysteresis to a value which is lower than 'Supervision low' limit - 0.5 * hysteresis. Action is deactivated when the signal rises to higher than 'Supervision low' limit + 0.5*hysteresis. Note: Supervision action is also deactivated for every motor start command.	8
	High rising	Action taken whenever the signal rises from a value lower than 'Supervision high' limit - 0.5 * hysteresis to a value which is higher than 'Supervision high' limit + 0.5 * hysteresis. Action is deactivated when the signal falls to lower than 'Supervision high' limit - 0.5*hysteresis. Note: Supervision action is also deactivated for every motor start command.	9

No.	Name/Value	Description	Def/FbEq16
32.06	<i>Supervision 1 action</i>	Selects whether the drive generates a fault, warning or neither when the value monitored by signal supervision 1 exceeds its limits. Note: This parameter does not affect the status indicated by 32.01 Supervision status .	<i>No action</i>
	No action	No warning or fault generated.	0
	Warning	Drive generates warning A8B0 ABB Signal supervision 1 .	1
	Fault	Drive trips on fault 80B0 Signal supervision 1 .	2
	Fault if running	If running, the drive trips on fault 80B0 Signal supervision 1 .	3
32.07	<i>Supervision 1 signal</i>	Selects the signal to be monitored by signal supervision function 1.	<i>Frequency</i>
	Zero	None.	0
	Speed	01.01 Motor speed used (page 361).	1
	Reserved		2
	Frequency	01.06 Output frequency (page 361).	3
	Current	01.07 Motor current (page 361).	4
	Reserved		5
	Torque	01.10 Motor torque (page 361).	6
	DC voltage	01.11 DC voltage (page 361).	7
	Output power	01.14 Output power (page 362).	8
	AI1	12.11 AI1 actual value (page 400).	9
	AI2	12.21 AI2 actual value (page 402).	10
	AI3 scaled	15.52 AI3 scaled value (see page 507).	11
	AI4 scaled	15.62 AI4 scaled value (see page 509).	12
	AI5 scaled	15.72 AI5 scaled value (see page 511).	13
	Reserved		14...17
	Speed ref ramp in	23.01 Speed ref ramp input (page 449).	18
	Speed ref ramp out	23.02 Speed ref ramp output (page 449).	19
	Speed ref used	24.01 Used speed reference (page 452).	20
	Reserved		21
	Freq ref used	28.02 Frequency ref ramp output (page 457).	22
	Inverter temperature	05.11 Inverter temperature (page 367).	23
	Process PID output	40.01 Process PID output actual (page 521).	24
	Process PID feedback	40.02 Process PID feedback actual (page 521).	25
	Process PID setpoint	40.03 Process PID setpoint actual (page 521).	26
	Process PID deviation	40.04 Process PID deviation actual (page 521).	27
	<i>Other</i>	Source selection (see Terms and abbreviations on page 358).	-
32.08	<i>Supervision 1 filter time</i>	Defines a filter time constant for the signal monitored by signal supervision 1.	0.000 s
	0.000 ... 30.000 s	Signal filter time.	1000 = 1 s

No.	Name/Value	Description	Def/FbEq16
32.09	<i>Supervision 1 low</i>	Defines the lower limit for signal supervision 1.	0.00
	-21474836.00... 21474836.00	Low limit.	
32.10	<i>Supervision 1 high</i>	Defines the upper limit for signal supervision 1.	0.00
	-21474836.00... 21474836.00	Upper limit.	
32.11	<i>Supervision 1 hysteresis</i>	Defines the hysteresis for the signal monitored by signal supervision 1. This parameter applies to all selections for parameter <i>32.05 Supervision 1 function</i> , not just selection Hysteresis (7). Action is taken whenever the signal rises above the value defined by the upper limit + 0.5 · hysteresis. The action is deactivated when the signal falls below the value defined by the lower limit - 0.5 · hysteresis.	0.00
	0.00...100000.00	Hysteresis.	
32.15	<i>Supervision 2 function</i>	Selects the mode of signal supervision function 2. Determines how the monitored signal (see parameter <i>32.17</i>) is compared to its lower and upper limits (<i>32.19</i> and <i>32.20</i> respectively). The action to be taken when the condition is fulfilled is selected by <i>32.16</i> .	<i>Disabled</i>
	Disabled	Signal supervision 2 not in use.	0
	Low	Action is taken whenever signal is below 'Supervision low' limit - 0.5 * hysteresis. Action is deactivated whenever signal is above 'Supervision low' limit + 0.5 * hysteresis.	1
	High	Action is taken whenever signal is above 'Supervision High' limit + 0.5 * hysteresis. Action is deactivated whenever signal is below 'Supervision High' limit - 0.5 * hysteresis.	2
	Abs low	Action is taken whenever absolute value of signal is below absolute value of 'Supervision Low' limit - 0.5 * hysteresis. Action is deactivated whenever absolute value of signal is above absolute value of 'Supervision Low' limit + 0.5 * hysteresis.	3
	Abs high	Action is taken whenever absolute value of signal is above absolute value of 'Supervision High' limit + 0.5 * hysteresis. Action is deactivated whenever absolute value of signal is below absolute value of 'Supervision High' limit - 0.5 * hysteresis	4
	Both	Action is taken whenever signal is above 'Supervision High' limit + 0.5 * hysteresis or below 'Supervision Low' limit - 0.5*hysteresis. Action is deactivated whenever signal is in between 'Supervision High' limit - 0.5 * hysteresis and 'Supervision Low' limit + 0.5*hysteresis.	5
	Abs both	Action is taken whenever absolute value of signal is above absolute value of 'Supervision High' limit + 0.5 * hysteresis or below absolute value of 'Supervision Low' limit - 0.5*hysteresis. Action is deactivated whenever absolute value of signal is in between absolute value of 'Supervision High' limit - 0.5 * hysteresis and absolute value of 'Supervision Low' limit + 0.5*hysteresis.	6

No.	Name/Value	Description	Def/FbEq16
	Hysteresis	Action is taken whenever signal is above 'Supervision High' limit + 0.5 * hysteresis. Action is deactivated whenever signal is below 'Supervision Low' limit - 0.5 * hysteresis. The status is unchanged when signal value is in between 'Supervision High' limit + 0.5 * hysteresis and 'Supervision Low' limit - 0.5 * hysteresis.	7
	Low falling	Action taken whenever the signal falls from a value higher than 'Supervision low' limit + 0.5 * hysteresis to a value which is lower than 'Supervision low' limit - 0.5 * hysteresis. Action is deactivated when the signal rises to higher than 'Supervision low' limit + 0.5*hysteresis. Note: Supervision action is also deactivated for every motor start command.	8
	High rising	Action taken whenever the signal rises from a value lower than 'Supervision high' limit - 0.5 * hysteresis to a value which is higher than 'Supervision high' limit + 0.5 * hysteresis. Action is deactivated when the signal falls to lower than 'Supervision high' limit - 0.5*hysteresis. Note: Supervision action is also deactivated for every motor start command.	9
32.16	<i>Supervision 2 action</i>	Selects whether the drive generates a fault, warning or neither when the value monitored by signal supervision 2 exceeds its limits. Note: This parameter does not affect the status indicated by 32.01 Supervision status .	<i>No action</i>
	No action	No warning or fault generated.	0
	Warning	Drive generates warning A8B1 ABB Signal supervision 2 .	1
	Fault	Drive trips on fault 80B1 Signal supervision 2 .	2
	Fault if running	If running, the drive trips on fault 80B1 Signal supervision 2 .	3
32.17	<i>Supervision 2 signal</i>	Selects the signal to be monitored by signal supervision function 2. For the available selections, see parameter 32.07 Supervision 1 signal .	<i>Current</i>
32.18	<i>Supervision 2 filter time</i>	Defines a filter time constant for the signal monitored by signal supervision 2.	0.000 s
	0.000 ... 30.000 s	Signal filter time.	1000 = 1 s
32.19	<i>Supervision 2 low</i>	Defines the lower limit for signal supervision 2.	0.00
	-21474836.00... 21474836.00	Low limit.	
32.20	<i>Supervision 2 high</i>	Defines the upper limit for signal supervision 2.	0.00
	-21474836.00... 21474836.00	Upper limit.	
32.21	<i>Supervision 2 hysteresis</i>	Defines the hysteresis for the signal monitored by signal supervision 2. This parameter applies to all selections for parameter 32.15 Supervision 2 function , not just selection Hysteresis (7). Action is taken whenever the signal rises above the value defined by the upper limit + 0.5 * hysteresis. The action is deactivated when the signal falls below the value defined by the lower limit - 0.5 * hysteresis.	0.00
	0.00...100000.00	Hysteresis.	

No.	Name/Value	Description	Def/FbEq16
32.25	<i>Supervision 3 function</i>	Selects the mode of signal supervision function 3. Determines how the monitored signal (see parameter 32.27) is compared to its lower and upper limits (32.29 and 32.30 respectively). The action to be taken when the condition is fulfilled is selected by 32.26.	<i>Disabled</i>
	Disabled	Signal supervision 3 not in use.	0
	Low	Action is taken whenever signal is below 'Supervision low' limit - 0.5 * hysteresis. Action is deactivated whenever signal is above 'Supervision low' limit + 0.5 * hysteresis.	1
	High	Action is taken whenever signal is above 'Supervision High' limit + 0.5 * hysteresis. Action is deactivated whenever signal is below 'Supervision High' limit - 0.5 * hysteresis.	2
	Abs low	Action is taken whenever absolute value of signal is below absolute value of 'Supervision Low' limit - 0.5 * hysteresis. Action is deactivated whenever absolute value of signal is above absolute value of 'Supervision Low' limit + 0.5 * hysteresis.	3
	Abs high	Action is taken whenever absolute value of signal is above absolute value of 'Supervision High' limit + 0.5 * hysteresis. Action is deactivated whenever absolute value of signal is below absolute value of 'Supervision High' limit - 0.5 * hysteresis	4
	Both	Action is taken whenever signal is above 'Supervision High' limit + 0.5 * hysteresis or below 'Supervision Low' limit - 0.5*hysteresis. Action is deactivated whenever signal is in between 'Supervision High' limit - 0.5 * hysteresis and 'Supervision Low' limit + 0.5*hysteresis.	5
	Abs both	Action is taken whenever absolute value of signal is above absolute value of 'Supervision High' limit + 0.5 * hysteresis or below absolute value of 'Supervision Low' limit - 0.5*hysteresis. Action is deactivated whenever absolute value of signal is in between absolute value of 'Supervision High' limit - 0.5 * hysteresis and absolute value of 'Supervision Low' limit + 0.5*hysteresis.	6
	Hysteresis	Action is taken whenever signal is above 'Supervision High' limit + 0.5 * hysteresis. Action is deactivated whenever signal is below 'Supervision Low' limit - 0.5 * hysteresis. The status is unchanged when signal value is in between 'Supervision High' limit + 0.5 * hysteresis and 'Supervision Low' limit - 0.5 * hysteresis.	7
	Low falling	Action taken whenever the signal falls from a value higher than 'Supervision low' limit + 0.5 * hysteresis to a value which is lower than 'Supervision low' limit - 0.5 * hysteresis. Action is deactivated when the signal rises to higher than 'Supervision low' limit + 0.5*hysteresis. Note: Supervision action is also deactivated for every motor start command.	8
	High rising	Action taken whenever the signal rises from a value lower than 'Supervision high' limit - 0.5 * hysteresis to a value which is higher than 'Supervision high' limit + 0.5 * hysteresis. Action is deactivated when the signal falls to lower than 'Supervision high' limit - 0.5*hysteresis. Note: Supervision action is also deactivated for every motor start command.	9

No.	Name/Value	Description	Def/FbEq16
32.26	<i>Supervision 3 action</i>	Selects whether the drive generates a fault, warning or neither when the value monitored by signal supervision 3 exceeds its limits. Note: This parameter does not affect the status indicated by 32.01 Supervision status .	<i>No action</i>
	No action	No warning or fault generated.	0
	Warning	Drive generates warning A8B2 ABB Signal supervision 3 .	1
	Fault	Drive trips on fault 80B2 Signal supervision 3 .	2
	Fault if running	If running, the drive trips on fault 80B2 Signal supervision 3 .	3
32.27	<i>Supervision 3 signal</i>	Selects the signal to be monitored by signal supervision function 3. For the available selections, see parameter 32.07 Supervision 1 signal .	<i>Torque</i>
32.28	<i>Supervision 3 filter time</i>	Defines a filter time constant for the signal monitored by signal supervision 3.	0.000 s
	0.000 ... 30.000 s	Signal filter time.	1000 = 1 s
32.29	<i>Supervision 3 low</i>	Defines the lower limit for signal supervision 3.	0.00
	-21474836.00... 21474836.00	Low limit.	
32.30	<i>Supervision 3 high</i>	Defines the upper limit for signal supervision 3.	0.00
	-21474836.00... 21474836.00	Upper limit.	
32.31	<i>Supervision 3 hysteresis</i>	Defines the hysteresis for the signal monitored by signal supervision 3. This parameter applies to all selections for parameter 32.25 Supervision 3 function , not just selection Hysteresis (7). Action is taken whenever the signal rises above the value defined by the upper limit + 0.5 · hysteresis. The action is deactivated when the signal falls below the value defined by the lower limit - 0.5 · hysteresis.	0.00
	0.00...100000.00	Hysteresis.	
32.35	<i>Supervision 4 function</i>	Selects the mode of signal supervision function 4. Determines how the monitored signal (see parameter 32.37) is compared to its lower and upper limits (32.39 and 32.30 respectively). The action to be taken when the condition is fulfilled is selected by 32.36 .	<i>Disabled</i>
	Disabled	Signal supervision 4 not in use.	0
	Low	Action is taken whenever signal is below 'Supervision low' limit - 0.5 * hysteresis. Action is deactivated whenever signal is above 'Supervision low' limit + 0.5 * hysteresis.	1
	High	Action is taken whenever signal is above 'Supervision High' limit + 0.5 * hysteresis. Action is deactivated whenever signal is below 'Supervision High' limit - 0.5 * hysteresis.	2
	Abs low	Action is taken whenever absolute value of signal is below absolute value of 'Supervision Low' limit - 0.5 * hysteresis. Action is deactivated whenever absolute value of signal is above absolute value of 'Supervision Low' limit + 0.5 * hysteresis.	3

No.	Name/Value	Description	Def/FbEq16
	Abs high	Action is taken whenever absolute value of signal is above absolute value of 'Supervision High' limit + 0.5 * hysteresis. Action is deactivated whenever absolute value of signal is below absolute value of 'Supervision High' limit - 0.5 * hysteresis	4
	Both	Action is taken whenever signal is above 'Supervision High' limit + 0.5 * hysteresis or below 'Supervision Low' limit - 0.5*hysteresis. Action is deactivated whenever signal is in between 'Supervision High' limit - 0.5 * hysteresis and 'Supervision Low' limit + 0.5*hysteresis.	5
	Abs both	Action is taken whenever absolute value of signal is above absolute value of 'Supervision High' limit + 0.5 * hysteresis or below absolute value of 'Supervision Low' limit - 0.5*hysteresis. Action is deactivated whenever absolute value of signal is in between absolute value of 'Supervision High' limit - 0.5 * hysteresis and absolute value of 'Supervision Low' limit + 0.5*hysteresis.	6
	Hysteresis	Action is taken whenever signal is above 'Supervision High' limit + 0.5 * hysteresis. Action is deactivated whenever signal is below 'Supervision Low' limit - 0.5 * hysteresis. The status is unchanged when signal value is in between 'Supervision High' limit + 0.5 * hysteresis and 'Supervision Low' limit - 0.5 * hysteresis.	7
	Low falling	Action taken whenever the signal falls from a value higher than 'Supervision low' limit + 0.5 * hysteresis to a value which is lower than 'Supervision low' limit - 0.5 * hysteresis. Action is deactivated when the signal rises to higher than 'Supervision low' limit + 0.5*hysteresis. Note: Supervision action is also deactivated for every motor start command.	8
	High rising	Action taken whenever the signal rises from a value lower than 'Supervision high' limit - 0.5 * hysteresis to a value which is higher than 'Supervision high' limit + 0.5 * hysteresis. Action is deactivated when the signal falls to lower than 'Supervision high' limit - 0.5*hysteresis. Note: Supervision action is also deactivated for every motor start command.	9
32.36	<i>Supervision 4 action</i>	Selects whether the drive generates a fault, warning or neither when the value monitored by signal supervision 4 exceeds its limits. Note: This parameter does not affect the status indicated by 32.01 Supervision status .	<i>No action</i>
	No action	No warning or fault generated.	0
	Warning	Drive generates warning A8B3 ABB Signal supervision 4 .	1
	Fault	Drive trips on fault 80B3 Signal supervision 4 .	2
	Fault if running	If running, the drive trips on fault 80B3 Signal supervision 4 .	3
32.37	<i>Supervision 4 signal</i>	Selects the signal to be monitored by signal supervision function 4. For the available selections, see parameter 32.07 Supervision 1 signal .	<i>Zero</i>
32.38	<i>Supervision 4 filter time</i>	Defines a filter time constant for the signal monitored by signal supervision 4.	0.000 s
	0.000 ... 30.000 s	Signal filter time.	1000 = 1 s

No.	Name/Value	Description	Def/FbEq16
32.39	<i>Supervision 4 low</i>	Defines the lower limit for signal supervision 4.	0.00
	-21474836.00... 21474836.00	Low limit.	
32.40	<i>Supervision 4 high</i>	Defines the upper limit for signal supervision 4.	0.00
	-21474836.00... 21474836.00	Upper limit.	
32.41	<i>Supervision 4 hysteresis</i>	Defines the hysteresis for the signal monitored by signal supervision 4. This parameter applies to all selections for parameter 32.35 Supervision 4 function , not just selection Hysteresis (7). Action is taken whenever the signal rises above the value defined by the upper limit + 0.5 * hysteresis. The action is deactivated when the signal falls below the value defined by the lower limit - 0.5 * hysteresis.	0.00
	0.00...100000.00	Hysteresis.	
32.45	<i>Supervision 5 function</i>	Selects the mode of signal supervision function 5. Determines how the monitored signal (see parameter 32.47) is compared to its lower and upper limits (32.49 and 32.40 respectively). The action to be taken when the condition is fulfilled is selected by 32.46 .	<i>Disabled</i>
	Disabled	Signal supervision 5 not in use.	0
	Low	Action is taken whenever signal is below 'Supervision low' limit - 0.5 * hysteresis. Action is deactivated whenever signal is above 'Supervision low' limit + 0.5 * hysteresis.	1
	High	Action is taken whenever signal is above 'Supervision High' limit + 0.5 * hysteresis. Action is deactivated whenever signal is below 'Supervision High' limit - 0.5 * hysteresis.	2
	Abs low	Action is taken whenever absolute value of signal is below absolute value of 'Supervision Low' limit - 0.5 * hysteresis. Action is deactivated whenever absolute value of signal is above absolute value of 'Supervision Low' limit + 0.5 * hysteresis.	3
	Abs high	Action is taken whenever absolute value of signal is above absolute value of 'Supervision High' limit + 0.5 * hysteresis. Action is deactivated whenever absolute value of signal is below absolute value of 'Supervision High' limit - 0.5 * hysteresis	4
	Both	Action is taken whenever signal is above 'Supervision High' limit + 0.5 * hysteresis or below 'Supervision Low' limit - 0.5*hysteresis. Action is deactivated whenever signal is in between 'Supervision High' limit - 0.5 * hysteresis and 'Supervision Low' limit + 0.5*hysteresis.	5
	Abs both	Action is taken whenever absolute value of signal is above absolute value of 'Supervision High' limit + 0.5 * hysteresis or below absolute value of 'Supervision Low' limit - 0.5*hysteresis. Action is deactivated whenever absolute value of signal is in between absolute value of 'Supervision High' limit - 0.5 * hysteresis and absolute value of 'Supervision Low' limit + 0.5*hysteresis.	6

No.	Name/Value	Description	Def/FbEq16
	Hysteresis	Action is taken whenever signal is above 'Supervision High' limit + 0.5 * hysteresis. Action is deactivated whenever signal is below 'Supervision Low' limit - 0.5 * hysteresis. The status is unchanged when signal value is in between 'Supervision High' limit + 0.5 * hysteresis and 'Supervision Low' limit - 0.5 * hysteresis.	7
	Low falling	Action taken whenever the signal falls from a value higher than 'Supervision low' limit + 0.5 * hysteresis to a value which is lower than 'Supervision low' limit - 0.5 * hysteresis. Action is deactivated when the signal rises to higher than 'Supervision low' limit + 0.5*hysteresis. Note: Supervision action is also deactivated for every motor start command.	8
	High rising	Action taken whenever the signal rises from a value lower than 'Supervision high' limit - 0.5 * hysteresis to a value which is higher than 'Supervision high' limit + 0.5 * hysteresis. Action is deactivated when the signal falls to lower than 'Supervision high' limit - 0.5*hysteresis. Note: Supervision action is also deactivated for every motor start command.	9
32.46	<i>Supervision 5 action</i>	Selects whether the drive generates a fault, warning or neither when the value monitored by signal supervision 5 exceeds its limits. Note: This parameter does not affect the status indicated by 32.01 Supervision status .	<i>No action</i>
	No action	No warning or fault generated.	0
	Warning	Drive generates warning A8B4 ABB Signal supervision 5 .	1
	Fault	Drive trips on fault 80B4 Signal supervision 5 .	2
	Fault if running	If running, the drive trips on fault 80B4 Signal supervision 5 .	3
32.47	<i>Supervision 5 signal</i>	Selects the signal to be monitored by signal supervision function 5. For the available selections, see parameter 32.07 Supervision 1 signal .	<i>Zero</i>
32.48	<i>Supervision 5 filter time</i>	Defines a filter time constant for the signal monitored by signal supervision 5.	0.000 s
	0.000 ... 30.000 s	Signal filter time.	1000 = 1 s
32.49	<i>Supervision 5 low</i>	Defines the lower limit for signal supervision 5.	0.00
	-21474836.00... 21474836.00	Low limit.	
32.50	<i>Supervision 5 high</i>	Defines the upper limit for signal supervision 5.	0.00
	-21474836.00... 21474836.00	Upper limit.	
32.51	<i>Supervision 5 hysteresis</i>	Defines the hysteresis for the signal monitored by signal supervision 5. This parameter applies to all selections for parameter 32.45 Supervision 5 function , not just selection Hysteresis (7). Action is taken whenever the signal rises above the value defined by the upper limit + 0.5 * hysteresis. The action is deactivated when the signal falls below the value defined by the lower limit - 0.5 * hysteresis.	0.00
	0.00...100000.00	Hysteresis.	

No.	Name/Value	Description	Def/FbEq16
32.55	<i>Supervision 6 function</i>	Selects the mode of signal supervision function 6. Determines how the monitored signal (see parameter 32.57) is compared to its lower and upper limits (32.59 and 32.50 respectively). The action to be taken when the condition is fulfilled is selected by 32.56.	<i>Disabled</i>
	Disabled	Signal supervision 6 not in use.	0
	Low	Action is taken whenever signal is below 'Supervision low' limit - 0.5 * hysteresis. Action is deactivated whenever signal is above 'Supervision low' limit + 0.5 * hysteresis.	1
	High	Action is taken whenever signal is above 'Supervision High' limit + 0.5 * hysteresis. Action is deactivated whenever signal is below 'Supervision High' limit - 0.5 * hysteresis.	2
	Abs low	Action is taken whenever absolute value of signal is below absolute value of 'Supervision Low' limit - 0.5 * hysteresis. Action is deactivated whenever absolute value of signal is above absolute value of 'Supervision Low' limit + 0.5 * hysteresis.	3
	Abs high	Action is taken whenever absolute value of signal is above absolute value of 'Supervision High' limit + 0.5 * hysteresis. Action is deactivated whenever absolute value of signal is below absolute value of 'Supervision High' limit - 0.5 * hysteresis	4
	Both	Action is taken whenever signal is above 'Supervision High' limit + 0.5 * hysteresis or below 'Supervision Low' limit - 0.5*hysteresis. Action is deactivated whenever signal is in between 'Supervision High' limit - 0.5 * hysteresis and 'Supervision Low' limit + 0.5*hysteresis.	5
	Abs both	Action is taken whenever absolute value of signal is above absolute value of 'Supervision High' limit + 0.5 * hysteresis or below absolute value of 'Supervision Low' limit - 0.5*hysteresis. Action is deactivated whenever absolute value of signal is in between absolute value of 'Supervision High' limit - 0.5 * hysteresis and absolute value of 'Supervision Low' limit + 0.5*hysteresis.	6
	Hysteresis	Action is taken whenever signal is above 'Supervision High' limit + 0.5 * hysteresis. Action is deactivated whenever signal is below 'Supervision Low' limit - 0.5 * hysteresis. The status is unchanged when signal value is in between 'Supervision High' limit + 0.5 * hysteresis and 'Supervision Low' limit - 0.5 * hysteresis.	7
	Low falling	Action taken whenever the signal falls from a value higher than 'Supervision low' limit + 0.5 * hysteresis to a value which is lower than 'Supervision low' limit - 0.5 * hysteresis. Action is deactivated when the signal rises to higher than 'Supervision low' limit + 0.5*hysteresis. Note: Supervision action is also deactivated for every motor start command.	8
	High rising	Action taken whenever the signal rises from a value lower than 'Supervision high' limit - 0.5 * hysteresis to a value which is higher than 'Supervision high' limit + 0.5 * hysteresis. Action is deactivated when the signal falls to lower than 'Supervision high' limit - 0.5*hysteresis. Note: Supervision action is also deactivated for every motor start command.	9

No.	Name/Value	Description	Def/FbEq16															
32.56	<i>Supervision 6 action</i>	Selects whether the drive generates a fault, warning or neither when the value monitored by signal supervision 6 exceeds its limits. Note: This parameter does not affect the status indicated by 32.01 Supervision status .	<i>No action</i>															
	No action	No warning or fault generated.	0															
	Warning	Drive generates warning A8B5 ABB Signal supervision 6 .	1															
	Fault	Drive trips on fault 80B5 Signal supervision 6 .	2															
	Fault if running	If running, the drive trips on fault 80B5 Signal supervision 6 .	3															
32.57	<i>Supervision 6 signal</i>	Selects the signal to be monitored by signal supervision function 6. For the available selections, see parameter 32.07 Supervision 1 signal .	<i>Zero</i>															
32.58	<i>Supervision 6 filter time</i>	Defines a filter time constant for the signal monitored by signal supervision 6.	0.000 s															
	0.000 ... 30.000 s	Signal filter time.	1000 = 1 s															
32.59	<i>Supervision 6 low</i>	Defines the lower limit for signal supervision 6.	0.00															
	-21474836.00... 21474836.00	Low limit.																
32.60	<i>Supervision 6 high</i>	Defines the upper limit for signal supervision 6.	0.00															
	-21474836.00... 21474836.00	Upper limit.																
32.61	<i>Supervision 6 hysteresis</i>	Defines the hysteresis for the signal monitored by signal supervision 6. This parameter applies to all selections for parameter 32.55 Supervision 6 function , not just selection Hysteresis (7). Action is taken whenever the signal rises above the value defined by the upper limit + 0.5 · hysteresis. The action is deactivated when the signal falls below the value defined by the lower limit - 0.5 · hysteresis.	0.00															
	0.00...100000.00	Hysteresis.																
34 Timed functions		Configuration of the timed functions. See section Timed functions on page 162.																
34.01	<i>Timed functions status</i>	Status of the combined timers. The status of a combined timer is the logical OR of all timers connected to it. This parameter is read-only.	-															
		<table border="1"> <thead> <tr> <th>Bit</th> <th>Name</th> <th>Description</th> </tr> </thead> <tbody> <tr> <td>0</td> <td>Timed function 1</td> <td>1 = Active.</td> </tr> <tr> <td>1</td> <td>Timed function 2</td> <td>1 = Active.</td> </tr> <tr> <td>2</td> <td>Timed function 3</td> <td>1 = Active.</td> </tr> <tr> <td>3...15</td> <td>Reserved</td> <td></td> </tr> </tbody> </table>	Bit	Name	Description	0	Timed function 1	1 = Active.	1	Timed function 2	1 = Active.	2	Timed function 3	1 = Active.	3...15	Reserved		
Bit	Name	Description																
0	Timed function 1	1 = Active.																
1	Timed function 2	1 = Active.																
2	Timed function 3	1 = Active.																
3...15	Reserved																	
	0000h...FFFFh	Status of combined timers 1...3.	1 = 1															

No.	Name/Value	Description	Def/FbEq16																																										
34.02	<i>Timer status</i>	Status of timers 1...12. This parameter is read-only.	-																																										
<table border="1"> <thead> <tr> <th>Bit</th> <th>Name</th> <th>Description</th> </tr> </thead> <tbody> <tr><td>0</td><td>Timer 1</td><td>1 = Active.</td></tr> <tr><td>1</td><td>Timer 2</td><td>1 = Active.</td></tr> <tr><td>2</td><td>Timer 3</td><td>1 = Active.</td></tr> <tr><td>3</td><td>Timer 4</td><td>1 = Active.</td></tr> <tr><td>4</td><td>Timer 5</td><td>1 = Active.</td></tr> <tr><td>5</td><td>Timer 6</td><td>1 = Active.</td></tr> <tr><td>6</td><td>Timer 7</td><td>1 = Active.</td></tr> <tr><td>7</td><td>Timer 8</td><td>1 = Active.</td></tr> <tr><td>8</td><td>Timer 9</td><td>1 = Active.</td></tr> <tr><td>9</td><td>Timer 10</td><td>1 = Active.</td></tr> <tr><td>10</td><td>Timer 11</td><td>1 = Active.</td></tr> <tr><td>11</td><td>Timer 12</td><td>1 = Active.</td></tr> <tr><td>12...15</td><td>Reserved</td><td></td></tr> </tbody> </table>				Bit	Name	Description	0	Timer 1	1 = Active.	1	Timer 2	1 = Active.	2	Timer 3	1 = Active.	3	Timer 4	1 = Active.	4	Timer 5	1 = Active.	5	Timer 6	1 = Active.	6	Timer 7	1 = Active.	7	Timer 8	1 = Active.	8	Timer 9	1 = Active.	9	Timer 10	1 = Active.	10	Timer 11	1 = Active.	11	Timer 12	1 = Active.	12...15	Reserved	
Bit	Name	Description																																											
0	Timer 1	1 = Active.																																											
1	Timer 2	1 = Active.																																											
2	Timer 3	1 = Active.																																											
3	Timer 4	1 = Active.																																											
4	Timer 5	1 = Active.																																											
5	Timer 6	1 = Active.																																											
6	Timer 7	1 = Active.																																											
7	Timer 8	1 = Active.																																											
8	Timer 9	1 = Active.																																											
9	Timer 10	1 = Active.																																											
10	Timer 11	1 = Active.																																											
11	Timer 12	1 = Active.																																											
12...15	Reserved																																												
	0000h...FFFFh	Timer status.	1 = 1																																										
34.04	<i>Season/exception day status</i>	Status of seasons 1...4, exception weekday and exception holiday. Only one season can be active at a time. A day can be a workday and a holiday at the same time. This parameter is read-only.	-																																										
<table border="1"> <thead> <tr> <th>Bit</th> <th>Name</th> <th>Description</th> </tr> </thead> <tbody> <tr><td>0</td><td>Season 1</td><td>1 = Active.</td></tr> <tr><td>1</td><td>Season 2</td><td>1 = Active.</td></tr> <tr><td>2</td><td>Season 3</td><td>1 = Active.</td></tr> <tr><td>3</td><td>Season 4</td><td>1 = Active.</td></tr> <tr><td>4...9</td><td>Reserved</td><td></td></tr> <tr><td>10</td><td>Exception weekday</td><td>1 = Active.</td></tr> <tr><td>11</td><td>Exception holiday</td><td>1 = Active.</td></tr> <tr><td>12...15</td><td>Reserved</td><td></td></tr> </tbody> </table>				Bit	Name	Description	0	Season 1	1 = Active.	1	Season 2	1 = Active.	2	Season 3	1 = Active.	3	Season 4	1 = Active.	4...9	Reserved		10	Exception weekday	1 = Active.	11	Exception holiday	1 = Active.	12...15	Reserved																
Bit	Name	Description																																											
0	Season 1	1 = Active.																																											
1	Season 2	1 = Active.																																											
2	Season 3	1 = Active.																																											
3	Season 4	1 = Active.																																											
4...9	Reserved																																												
10	Exception weekday	1 = Active.																																											
11	Exception holiday	1 = Active.																																											
12...15	Reserved																																												
	0000h...FFFFh	Status of the seasons and exception weekday and holiday.	1 = 1																																										
34.10	<i>Timed functions enable</i>	Selects the source for the timed functions enable signal. 0 = Disabled. 1 = Enabled.	<i>Disabled</i>																																										
	Disabled	0.	0																																										
	Enabled	1.	1																																										
	DI1	Digital input DI1 (<i>10.02 DI delayed status</i> , bit 0).	2																																										
	DI2	Digital input DI2 (<i>10.02 DI delayed status</i> , bit 1).	3																																										
	DI3	Digital input DI3 (<i>10.02 DI delayed status</i> , bit 2).	4																																										
	DI4	Digital input DI4 (<i>10.02 DI delayed status</i> , bit 3).	5																																										
	DI5	Digital input DI5 (<i>10.02 DI delayed status</i> , bit 4).	6																																										
	DI6	Digital input DI6 (<i>10.02 DI delayed status</i> , bit 5).	7																																										

No.	Name/Value	Description	Def/FbEq16
	<i>Other [bit]</i>	Source selection (see Terms and abbreviations on page 358).	-
34.11	<i>Timer 1 configuration</i>	Defines when timer 1 is active.	0000 0111 1000 0000b

Bit	Name	Description
0	Monday	1 = Monday is an active start day.
1	Tuesday	1 = Tuesday is an active start day.
2	Wednesday	1 = Wednesday is an active start day.
3	Thursday	1 = Thursday is an active start day.
4	Friday	1 = Friday is an active start day.
5	Saturday	1 = Saturday is an active start day.
6	Sunday	1 = Sunday is an active start day.
7	Season 1	1 = Timer is active in season 1.
8	Season 2	1 = Timer is active in season 2.
9	Season 3	1 = Timer is active in season 3.
10	Season 4	1 = Timer is active in season 4.
11	Exceptions	<p>0 = Exceptions days are disabled. The timer follows only weekday and season settings (bits 0...10 in the timer configuration) and the start time and duration of the timer (see 34.12 and 34.13).</p> <p>Exception day settings, parameters 34.70...34.90, do not have any effect on this timer.</p> <p>1 = Exception days are enabled. The timer is active during the weekdays and seasons defined with bits 0...10 and the times defined by 34.12 and 34.13.</p> <p>In addition, the timer is active during the exception days defined with bit 12, bit 13 and parameters 34.70...34.90. If bit 12 and bit 13 are both zero, the timer is inactive during the exception days.</p>
12	Holidays	<p>This bit has no effect unless bit 11 = 1 (Exceptions days are enabled).</p> <p>When bits 11 and 12 are both 1, the timer is active during the weekdays and seasons defined with bits 0...10 and times defined by parameters 34.12 and 34.13.</p> <p>In addition, the timer is active when the ongoing day is defined as Exception day Holiday by parameters 34.70...34.90 and the current time matches with the time range defined by 34.12 and 34.13. During Exception days, weekday and season bits are ignored.</p>
13	Workdays	<p>This bit has no effect unless bit 11 = 1 (Exceptions enabled).</p> <p>When bits 11 and 13 are both 1, the Timer is active during the weekdays and seasons defined with bits 0...10 and the times defined by parameters 34.12 and 34.13.</p> <p>In addition, the timer is active when the ongoing day is defined as Exception day Workday by parameters 34.70...34.90 and the current time matches with the time range defined by 34.12 and 34.13. During Exception days, weekday and season bits are ignored.</p>
14...15	Reserved	

No.	Name/Value	Description	Def/FbEq16																																																																																																								
Examples of how the timer configuration defines when the Timer is active are shown below.																																																																																																											
Bits of parameter 34.11 Timer 1 configuration		<table border="1"> <thead> <tr> <th data-bbox="216 260 244 387">Monday</th> <th data-bbox="244 260 272 387">Tuesday</th> <th data-bbox="272 260 300 387">Wednesday</th> <th data-bbox="300 260 328 387">Thursday</th> <th data-bbox="328 260 356 387">Friday</th> <th data-bbox="356 260 384 387">Saturday</th> <th data-bbox="384 260 412 387">Sunday</th> <th data-bbox="412 260 440 387">Season1</th> <th data-bbox="440 260 468 387">Season2</th> <th data-bbox="468 260 496 387">Season3</th> <th data-bbox="496 260 524 387">Season4</th> <th data-bbox="524 260 552 387">Exceptions</th> <th data-bbox="552 260 580 387">Holidays</th> <th data-bbox="580 260 608 387">Workdays</th> </tr> </thead> <tbody> <tr> <td>1</td><td>1</td><td>1</td><td>1</td><td>1</td><td>1</td><td>1</td><td>1</td><td>1</td><td>1</td><td>1</td><td>0</td><td>0</td><td>0</td> <td data-bbox="571 387 1021 499">Example 1: Timer is active during the times of the day defined by other parameters <u>every Weekday</u> and <u>every Season</u>. Exception day settings (34.70...34.90) do not have any effect on the Timer.</td> </tr> <tr> <td>1</td><td>1</td><td>1</td><td>1</td><td>1</td><td>0</td><td>0</td><td>1</td><td>1</td><td>1</td><td>1</td><td>0</td><td>0</td><td>0</td> <td data-bbox="571 499 1021 611">Example 2: Timer is active during the times of the day defined by other parameters from <u>Mon to Fri</u>, every Season. Exception day settings (34.70...34.90) do not have any effect on the Timer.</td> </tr> <tr> <td>1</td><td>1</td><td>1</td><td>1</td><td>1</td><td>0</td><td>0</td><td>0</td><td>0</td><td>1</td><td>0</td><td>0</td><td>0</td><td>0</td> <td data-bbox="571 611 1021 722">Example 3: Timer is active during the times of the day defined by other parameters from Mon to Fri, <u>only during Season 3</u> (can be configured as, eg, summer). Exception day settings (34.70...34.90) do not have any effect on the Timer.</td> </tr> <tr> <td>1</td><td>1</td><td>1</td><td>1</td><td>1</td><td>0</td><td>0</td><td>1</td><td>1</td><td>1</td><td>1</td><td>1</td><td>1</td><td>0</td> <td data-bbox="571 722 1021 834">Example 4: Timer is active during the times of the day defined by other parameters from Mon to Fri, every Season. In addition, the Timer is active <u>every Exception day</u>, <u>Holidays</u>, <u>regardless what is the day or season</u>.</td> </tr> <tr> <td>1</td><td>0</td><td>1</td><td>0</td><td>1</td><td>0</td><td>1</td><td>1</td><td>1</td><td>0</td><td>0</td><td>1</td><td>0</td><td>1</td> <td data-bbox="571 834 1021 946">Example 5: Timer is active during the times of the day defined by other parameters on Mon, Wed, Fri and Sun, during Season1 and Season 2. In addition, the Timer is active every <u>Exception day</u>, <u>Workdays</u>, <u>regardless what is the day or season</u>.</td> </tr> <tr> <td>1</td><td>1</td><td>1</td><td>1</td><td>1</td><td>1</td><td>1</td><td>1</td><td>1</td><td>1</td><td>1</td><td>1</td><td>0</td><td>0</td> <td data-bbox="571 946 1021 1058">Example 6: Timer is active during the times of the day defined by other parameters every Weekday and every Season. The Timer is <u>inactive during all Exception days</u>.</td> </tr> </tbody> </table>		Monday	Tuesday	Wednesday	Thursday	Friday	Saturday	Sunday	Season1	Season2	Season3	Season4	Exceptions	Holidays	Workdays	1	1	1	1	1	1	1	1	1	1	1	0	0	0	Example 1: Timer is active during the times of the day defined by other parameters <u>every Weekday</u> and <u>every Season</u> . Exception day settings (34.70...34.90) do not have any effect on the Timer.	1	1	1	1	1	0	0	1	1	1	1	0	0	0	Example 2: Timer is active during the times of the day defined by other parameters from <u>Mon to Fri</u> , every Season. Exception day settings (34.70...34.90) do not have any effect on the Timer.	1	1	1	1	1	0	0	0	0	1	0	0	0	0	Example 3: Timer is active during the times of the day defined by other parameters from Mon to Fri, <u>only during Season 3</u> (can be configured as, eg, summer). Exception day settings (34.70...34.90) do not have any effect on the Timer.	1	1	1	1	1	0	0	1	1	1	1	1	1	0	Example 4: Timer is active during the times of the day defined by other parameters from Mon to Fri, every Season. In addition, the Timer is active <u>every Exception day</u> , <u>Holidays</u> , <u>regardless what is the day or season</u> .	1	0	1	0	1	0	1	1	1	0	0	1	0	1	Example 5: Timer is active during the times of the day defined by other parameters on Mon, Wed, Fri and Sun, during Season1 and Season 2. In addition, the Timer is active every <u>Exception day</u> , <u>Workdays</u> , <u>regardless what is the day or season</u> .	1	1	1	1	1	1	1	1	1	1	1	1	0	0	Example 6: Timer is active during the times of the day defined by other parameters every Weekday and every Season. The Timer is <u>inactive during all Exception days</u> .
Monday	Tuesday			Wednesday	Thursday	Friday	Saturday	Sunday	Season1	Season2	Season3	Season4	Exceptions	Holidays	Workdays																																																																																												
1	1			1	1	1	1	1	1	1	1	1	0	0	0	Example 1: Timer is active during the times of the day defined by other parameters <u>every Weekday</u> and <u>every Season</u> . Exception day settings (34.70...34.90) do not have any effect on the Timer.																																																																																											
1	1			1	1	1	0	0	1	1	1	1	0	0	0	Example 2: Timer is active during the times of the day defined by other parameters from <u>Mon to Fri</u> , every Season. Exception day settings (34.70...34.90) do not have any effect on the Timer.																																																																																											
1	1			1	1	1	0	0	0	0	1	0	0	0	0	Example 3: Timer is active during the times of the day defined by other parameters from Mon to Fri, <u>only during Season 3</u> (can be configured as, eg, summer). Exception day settings (34.70...34.90) do not have any effect on the Timer.																																																																																											
1	1			1	1	1	0	0	1	1	1	1	1	1	0	Example 4: Timer is active during the times of the day defined by other parameters from Mon to Fri, every Season. In addition, the Timer is active <u>every Exception day</u> , <u>Holidays</u> , <u>regardless what is the day or season</u> .																																																																																											
1	0			1	0	1	0	1	1	1	0	0	1	0	1	Example 5: Timer is active during the times of the day defined by other parameters on Mon, Wed, Fri and Sun, during Season1 and Season 2. In addition, the Timer is active every <u>Exception day</u> , <u>Workdays</u> , <u>regardless what is the day or season</u> .																																																																																											
1	1	1	1	1	1	1	1	1	1	1	1	0	0	Example 6: Timer is active during the times of the day defined by other parameters every Weekday and every Season. The Timer is <u>inactive during all Exception days</u> .																																																																																													
0000h...FFFFh	Configuration of timer 1.	1 = 1																																																																																																									
34.12	Timer 1 start time	Defines the daily start time of timer 1. The time can be changed in second steps. The timer can be started at an other time than the start time. For example, if the timer's duration is more than one day and the active session starts during the time, the timer is started at 00:00 and stopped when there is no duration left.	00:00:00																																																																																																								
00:00:00...23:59:59	Daily start time of the timer.	-																																																																																																									

No.	Name/Value	Description	Def/FbEq16
34.13	Timer 1 duration	Defines the duration of timer 1. The duration can be changed in minute steps. The duration can extend over the change of the day but if an exception day becomes active, the period is interrupted at midnight. In the same way the period started on an exception day stays active only until the end of the day, even if the duration is longer. The timer will continue after a break if there is duration left.	00 00:00
	00 00:00...07 00:00	Timer duration.	-
34.14	Timer 2 configuration	See 34.11 Timer 1 configuration .	0000 0111 1000 0000b
34.15	Timer 2 start time	See 34.12 Timer 1 start time .	00:00:00
34.16	Timer 2 duration	See 34.13 Timer 1 duration .	00 00:00
34.17	Timer 3 configuration	See 34.11 Timer 1 configuration .	0000 0111 1000 0000b
34.18	Timer 3 start time	See 34.12 Timer 1 start time .	00:00:00
34.19	Timer 3 duration	See 34.13 Timer 1 duration .	00 00:00
34.20	Timer 4 configuration	See 34.11 Timer 1 configuration .	0000 0111 1000 0000b
34.21	Timer 4 start time	See 34.12 Timer 1 start time .	00:00:00
34.22	Timer 4 duration	See 34.13 Timer 1 duration .	00 00:00
34.23	Timer 5 configuration	See 34.11 Timer 1 configuration .	0000 0111 1000 0000b
34.24	Timer 5 start time	See 34.12 Timer 1 start time .	00:00:00
34.25	Timer 5 duration	See 34.13 Timer 1 duration .	00 00:00
34.26	Timer 6 configuration	See 34.11 Timer 1 configuration .	0000 0111 1000 0000b
34.27	Timer 6 start time	See 34.12 Timer 1 start time .	00:00:00
34.28	Timer 6 duration	See 34.13 Timer 1 duration .	00 00:00
34.29	Timer 7 configuration	See 34.11 Timer 1 configuration .	0000 0111 1000 0000b
34.30	Timer 7 start time	See 34.12 Timer 1 start time .	00:00:00
34.31	Timer 7 duration	See 34.13 Timer 1 duration .	00 00:00
34.32	Timer 8 configuration	See 34.11 Timer 1 configuration .	0000 0111 1000 0000b
34.33	Timer 8 start time	See 34.12 Timer 1 start time .	00:00:00
34.34	Timer 8 duration	See 34.13 Timer 1 duration .	00 00:00
34.35	Timer 9 configuration	See 34.11 Timer 1 configuration .	0000 0111 1000 0000b
34.36	Timer 9 start time	See 34.12 Timer 1 start time .	00:00:00
34.37	Timer 9 duration	See 34.13 Timer 1 duration .	00 00:00
34.38	Timer 10 configuration	See 34.11 Timer 1 configuration .	0000 0111 1000 0000b
34.39	Timer 10 start time	See 34.12 Timer 1 start time .	00:00:00
34.40	Timer 10 duration	See 34.13 Timer 1 duration .	00 00:00

No.	Name/Value	Description	Def/FbEq16
34.41	Timer 11 configuration	See 34.11 Timer 1 configuration .	0000 0111 1000 0000b
34.42	Timer 11 start time	See 34.12 Timer 1 start time .	00:00:00
34.43	Timer 11 duration	See 34.13 Timer 1 duration .	00 00:00
34.44	Timer 12 configuration	See 34.11 Timer 1 configuration .	0000 0111 1000 0000b
34.45	Timer 12 start time	See 34.12 Timer 1 start time .	00:00:00
34.46	Timer 12 duration	See 34.13 Timer 1 duration .	00 00:00
34.60	Season 1 start date	Defines the start date of season 1 in format dd.mm, where dd is the number of the day and mm is the number of the month. The season changes at midnight. One season can be active at a time. Timers are started on exception days even if they are not inside the active season. The season start dates (1...4) must be given in increasing order to use all seasons. The default value is interpreted that the season is not configured. If the season start dates are not in increasing order and the value is something else than the default value, a season configuration warning is given.	01.01.
	01.01...31.12	Season start date.	-
34.61	Season 2 start date	Defines the start date of season 2. See 34.60 Season 1 start date .	01.01.
34.62	Season 3 start date	Defines the start date of season 3. See 34.60 Season 1 start date .	01.01.
34.63	Season 4 start date	Defines the start date of season 4. See 34.60 Season 1 start date .	01.01.
34.70	Number of active exceptions	Defines how many of the exceptions are active by specifying the last active one. All preceding exceptions are active. Exceptions 1...3 are periods (duration can be defined) and exceptions 4...16 are days (duration is always 24 hours). Example: If the value is 4, exceptions 1...4 are active, and exceptions 5...16 are not active.	3
	0...16	Number of active exception periods or days.	1 = 1

No.	Name/Value	Description	Def/FbEq16																																																			
34.71	<i>Exception types</i>	Defines the types of exceptions 1...16 as workday or holiday. Exceptions 1...3 are periods (duration can be defined) and exceptions 4...16 are days (duration is always 24 hours).	0000 0000 0000 0000b																																																			
		<table border="1"> <thead> <tr> <th>Bit</th> <th>Name</th> <th>Description</th> </tr> </thead> <tbody> <tr><td>0</td><td>Exception 1</td><td>0 = Workday. 1 = Holiday</td></tr> <tr><td>1</td><td>Exception 2</td><td>0 = Workday. 1 = Holiday</td></tr> <tr><td>2</td><td>Exception 3</td><td>0 = Workday. 1 = Holiday</td></tr> <tr><td>3</td><td>Exception 4</td><td>0 = Workday. 1 = Holiday</td></tr> <tr><td>4</td><td>Exception 5</td><td>0 = Workday. 1 = Holiday</td></tr> <tr><td>5</td><td>Exception 6</td><td>0 = Workday. 1 = Holiday</td></tr> <tr><td>6</td><td>Exception 7</td><td>0 = Workday. 1 = Holiday</td></tr> <tr><td>7</td><td>Exception 8</td><td>0 = Workday. 1 = Holiday</td></tr> <tr><td>8</td><td>Exception 9</td><td>0 = Workday. 1 = Holiday</td></tr> <tr><td>9</td><td>Exception 10</td><td>0 = Workday. 1 = Holiday</td></tr> <tr><td>10</td><td>Exception 11</td><td>0 = Workday. 1 = Holiday</td></tr> <tr><td>11</td><td>Exception 12</td><td>0 = Workday. 1 = Holiday</td></tr> <tr><td>12</td><td>Exception 13</td><td>0 = Workday. 1 = Holiday</td></tr> <tr><td>13</td><td>Exception 14</td><td>0 = Workday. 1 = Holiday</td></tr> <tr><td>14</td><td>Exception 15</td><td>0 = Workday. 1 = Holiday</td></tr> <tr><td>15</td><td>Exception 16</td><td>0 = Workday. 1 = Holiday</td></tr> </tbody> </table>	Bit	Name	Description	0	Exception 1	0 = Workday. 1 = Holiday	1	Exception 2	0 = Workday. 1 = Holiday	2	Exception 3	0 = Workday. 1 = Holiday	3	Exception 4	0 = Workday. 1 = Holiday	4	Exception 5	0 = Workday. 1 = Holiday	5	Exception 6	0 = Workday. 1 = Holiday	6	Exception 7	0 = Workday. 1 = Holiday	7	Exception 8	0 = Workday. 1 = Holiday	8	Exception 9	0 = Workday. 1 = Holiday	9	Exception 10	0 = Workday. 1 = Holiday	10	Exception 11	0 = Workday. 1 = Holiday	11	Exception 12	0 = Workday. 1 = Holiday	12	Exception 13	0 = Workday. 1 = Holiday	13	Exception 14	0 = Workday. 1 = Holiday	14	Exception 15	0 = Workday. 1 = Holiday	15	Exception 16	0 = Workday. 1 = Holiday	
Bit	Name	Description																																																				
0	Exception 1	0 = Workday. 1 = Holiday																																																				
1	Exception 2	0 = Workday. 1 = Holiday																																																				
2	Exception 3	0 = Workday. 1 = Holiday																																																				
3	Exception 4	0 = Workday. 1 = Holiday																																																				
4	Exception 5	0 = Workday. 1 = Holiday																																																				
5	Exception 6	0 = Workday. 1 = Holiday																																																				
6	Exception 7	0 = Workday. 1 = Holiday																																																				
7	Exception 8	0 = Workday. 1 = Holiday																																																				
8	Exception 9	0 = Workday. 1 = Holiday																																																				
9	Exception 10	0 = Workday. 1 = Holiday																																																				
10	Exception 11	0 = Workday. 1 = Holiday																																																				
11	Exception 12	0 = Workday. 1 = Holiday																																																				
12	Exception 13	0 = Workday. 1 = Holiday																																																				
13	Exception 14	0 = Workday. 1 = Holiday																																																				
14	Exception 15	0 = Workday. 1 = Holiday																																																				
15	Exception 16	0 = Workday. 1 = Holiday																																																				
	0000h...FFFFh	Types of exception period or days.	1 = 1																																																			
34.72	<i>Exception 1 start</i>	Defines the start date of the exception period in format dd.mm, where dd is the number of the day and mm is the number of the month. The timer started on an exception day is always stopped at 23:59:59 even if it has duration left. The same date can be configured to be holiday and workday. The date is active if any of exception days are active.	01.01.																																																			
	01.01....31.12.	Start date of exception period 1.	-																																																			
34.73	<i>Exception 1 length</i>	Defines the length of the exception period in days. Exception period is handled the same as a number of consecutive exception days.	0 d																																																			
	0...60 d	Length of exception period 1.	1 = 1 d																																																			
34.74	<i>Exception 2 start</i>	See 34.72 <i>Exception 1 start</i> .	01.01.																																																			
34.75	<i>Exception 2 length</i>	See 34.73 <i>Exception 1 length</i> .	0 d																																																			
34.76	<i>Exception 3 start</i>	See 34.72 <i>Exception 1 start</i> .	01.01.																																																			
34.77	<i>Exception 3 length</i>	See 34.73 <i>Exception 1 length</i> .	0 d																																																			
34.78	<i>Exception day 4</i>	Defines the date of exception day 4.	01.01.																																																			
	01.01....31.12.	Start date of exception day 4. The timer started on an exception day is always stopped at 23:59:59 even if it has duration left.	-																																																			
34.79	<i>Exception day 5</i>	See 34.79 <i>Exception day 4</i> .	01.01																																																			
34.80	<i>Exception day 6</i>	See 34.79 <i>Exception day 4</i> .	01.01																																																			
34.81	<i>Exception day 7</i>	See 34.79 <i>Exception day 4</i> .	01.01																																																			
34.82	<i>Exception day 8</i>	See 34.79 <i>Exception day 4</i> .	01.01																																																			

No.	Name/Value	Description	Def/FbEq16																																										
34.83	<i>Exception day 9</i>	See 34.79 <i>Exception day 4</i> .	01.01																																										
34.84	<i>Exception day 10</i>	See 34.79 <i>Exception day 4</i> .	01.01																																										
34.85	<i>Exception day 11</i>	See 34.79 <i>Exception day 4</i> .	01.01																																										
34.86	<i>Exception day 12</i>	See 34.79 <i>Exception day 4</i> .	01.01																																										
34.87	<i>Exception day 13</i>	See 34.79 <i>Exception day 4</i> .	01.01																																										
34.88	<i>Exception day 14</i>	See 34.79 <i>Exception day 4</i> .	01.01																																										
34.89	<i>Exception day 15</i>	See 34.79 <i>Exception day 4</i> .	01.01																																										
34.90	<i>Exception day 16</i>	See 34.79 <i>Exception day 4</i> .	01.01																																										
34.100	<i>Timed function 1</i>	Defines which timers are connected to combined timer 1. 0 = Not connected. 1 = Connected. See 34.01 <i>Timed functions status</i> .	0000 0000 0000 0000b																																										
<table border="1"> <thead> <tr> <th>Bit</th> <th>Name</th> <th>Description</th> </tr> </thead> <tbody> <tr><td>0</td><td>Timer 1</td><td>0 = Inactive. 1 = Active.</td></tr> <tr><td>1</td><td>Timer 2</td><td>0 = Inactive. 1 = Active.</td></tr> <tr><td>2</td><td>Timer 3</td><td>0 = Inactive. 1 = Active.</td></tr> <tr><td>3</td><td>Timer 4</td><td>0 = Inactive. 1 = Active.</td></tr> <tr><td>4</td><td>Timer 5</td><td>0 = Inactive. 1 = Active.</td></tr> <tr><td>5</td><td>Timer 6</td><td>0 = Inactive. 1 = Active.</td></tr> <tr><td>6</td><td>Timer 7</td><td>0 = Inactive. 1 = Active.</td></tr> <tr><td>7</td><td>Timer 8</td><td>0 = Inactive. 1 = Active.</td></tr> <tr><td>8</td><td>Timer 9</td><td>0 = Inactive. 1 = Active.</td></tr> <tr><td>9</td><td>Timer 10</td><td>0 = Inactive. 1 = Active.</td></tr> <tr><td>10</td><td>Timer 11</td><td>0 = Inactive. 1 = Active.</td></tr> <tr><td>11</td><td>Timer 12</td><td>0 = Inactive. 1 = Active.</td></tr> <tr><td>12...15</td><td>Reserved</td><td></td></tr> </tbody> </table>				Bit	Name	Description	0	Timer 1	0 = Inactive. 1 = Active.	1	Timer 2	0 = Inactive. 1 = Active.	2	Timer 3	0 = Inactive. 1 = Active.	3	Timer 4	0 = Inactive. 1 = Active.	4	Timer 5	0 = Inactive. 1 = Active.	5	Timer 6	0 = Inactive. 1 = Active.	6	Timer 7	0 = Inactive. 1 = Active.	7	Timer 8	0 = Inactive. 1 = Active.	8	Timer 9	0 = Inactive. 1 = Active.	9	Timer 10	0 = Inactive. 1 = Active.	10	Timer 11	0 = Inactive. 1 = Active.	11	Timer 12	0 = Inactive. 1 = Active.	12...15	Reserved	
Bit	Name	Description																																											
0	Timer 1	0 = Inactive. 1 = Active.																																											
1	Timer 2	0 = Inactive. 1 = Active.																																											
2	Timer 3	0 = Inactive. 1 = Active.																																											
3	Timer 4	0 = Inactive. 1 = Active.																																											
4	Timer 5	0 = Inactive. 1 = Active.																																											
5	Timer 6	0 = Inactive. 1 = Active.																																											
6	Timer 7	0 = Inactive. 1 = Active.																																											
7	Timer 8	0 = Inactive. 1 = Active.																																											
8	Timer 9	0 = Inactive. 1 = Active.																																											
9	Timer 10	0 = Inactive. 1 = Active.																																											
10	Timer 11	0 = Inactive. 1 = Active.																																											
11	Timer 12	0 = Inactive. 1 = Active.																																											
12...15	Reserved																																												
0000h...FFFFh		Timers connected to combined timer 1.	1 = 1																																										
34.101	<i>Timed function 2</i>	Defines which timers are connected to combined timer 2. See 34.01 <i>Timed functions status</i> .	0000 0000 0000 0000b																																										
34.102	<i>Timed function 3</i>	Defines which timers are connected to combined timer 3. See 34.01 <i>Timed functions status</i> .	0000 0000 0000 0000b																																										
34.110	<i>Boost time function</i>	Defines which combined timers (that is, timers that are connected to the combined timers) are activated with the extra time function.	0000 0000 0000 0000b																																										
<table border="1"> <thead> <tr> <th>Bit</th> <th>Name</th> <th>Description</th> </tr> </thead> <tbody> <tr><td>0</td><td>Timed function 1</td><td>0 = Inactive. 1 = Active.</td></tr> <tr><td>1</td><td>Timed function 2</td><td>0 = Inactive. 1 = Active.</td></tr> <tr><td>2</td><td>Timed function 3</td><td>0 = Inactive. 1 = Active.</td></tr> <tr><td>3...15</td><td>Reserved</td><td></td></tr> </tbody> </table>				Bit	Name	Description	0	Timed function 1	0 = Inactive. 1 = Active.	1	Timed function 2	0 = Inactive. 1 = Active.	2	Timed function 3	0 = Inactive. 1 = Active.	3...15	Reserved																												
Bit	Name	Description																																											
0	Timed function 1	0 = Inactive. 1 = Active.																																											
1	Timed function 2	0 = Inactive. 1 = Active.																																											
2	Timed function 3	0 = Inactive. 1 = Active.																																											
3...15	Reserved																																												
0000h...FFFFh		Combined timers including the extra timer.	1 = 1																																										

No.	Name/Value	Description	Def/FbEq16
34.111	<i>Boost time activation source</i>	Selects the source of extra time activation signal. 0 = Disabled. 1 = Enabled.	Off
	Off	0.	0
	On	1.	1
	DI1	Digital input DI1 (<i>10.02 DI delayed status</i> , bit 0).	2
	DI2	Digital input DI2 (<i>10.02 DI delayed status</i> , bit 1).	3
	DI3	Digital input DI3 (<i>10.02 DI delayed status</i> , bit 2).	4
	DI4	Digital input DI4 (<i>10.02 DI delayed status</i> , bit 3).	5
	DI5	Digital input DI5 (<i>10.02 DI delayed status</i> , bit 4).	6
	DI6	Digital input DI6 (<i>10.02 DI delayed status</i> , bit 5).	7
	<i>Other [bit]</i>	Source selection (see <i>Terms and abbreviations</i> on page 358).	-
34.112	<i>Boost time duration</i>	Defines the time inside which the extra time is deactivated after extra time activation signal is switched off. Example: If parameter <i>34.111 Boost time activation source</i> is set to <i>DI1</i> and <i>34.112 Boost time duration</i> is set to 00 01:30, the extra time is active for 1 hour and 30 minutes after digital input DI is deactivated.	00 00:00
	00 00:00...07 00:00	Extra time duration.	.
35 Motor thermal protection		Motor thermal protection settings such as temperature measurement configuration, load curve definition and motor fan control configuration; motor overload protection. See also section <i>Programmable protection functions</i> (page 227).	
35.01	<i>Motor estimated temperature</i>	Displays the motor temperature as estimated by the internal motor thermal protection model (see parameters <i>35.50...35.55</i>). The unit is selected by parameter <i>96.16 Unit selection</i> . This parameter is read-only.	-
	-60...1000 °C or -76...1832 °F	Estimated motor temperature.	1 = 1 unit
35.02	<i>Measured temperature 1</i>	Displays the temperature received through the source defined by parameter <i>35.11 Temperature 1 source</i> . The unit is selected by parameter <i>96.16 Unit selection</i> . Note: With PTC AI/DI Voltage divider tree, this parameter shows PTC resistance in ohms, not motor temperature even if the parameter name and unit still refer to temperature. This parameter is read-only.	-
	-60...5000 °C or -76...9032 °F, or 0...5000 ohm or [35.12] ohm or [35.14] ohm	Measured temperature 2.	1 = 1 unit

No.	Name/Value	Description	Def/FbEq16
35.03	<i>Measured temperature 2</i>	Displays the temperature received through the source defined by parameter 35.21 Temperature 2 source . The unit is selected by parameter 96.16 Unit selection . Note: With PTC AI/DI Voltage divider tree, this parameter shows PTC resistance in ohms, not motor temperature even if the parameter name and unit still refer to temperature. This parameter is read-only.	-
	-60...5000 °C or -76...9032 °F or 0...5000 ohm or [35.22] ohm or [35.24] ohm	Measured temperature 2.	1 = 1 unit
35.05	<i>Motor overload level</i>	Motor overload level as a percent of the motor overload fault limit. See section Motor overload protection (page 207). This parameter is read-only.	0.0%
	0.0...300.0%	Motor overload level. 0.0% No motor overloading 88.0% Motor overloaded to warning level 100.0% Motor overloaded to fault level.	-
35.11	<i>Temperature 1 source</i>	Selects the source from which measured temperature 1 is read. Usually this source is from a sensor connected to the motor controlled by the drive, but it could be used to measure and monitor a temperature from other parts of the process as long as a suitable sensor is used as per the selection list.	<i>Disabled</i>
	Disabled	None. Temperature monitoring function 1 is disabled.	0
	Estimated temperature	Estimated motor temperature (see parameter 35.01 Motor estimated temperature). The temperature is estimated from an internal drive calculation. It is important to set up the ambient temperature of the motor in 35.50 Motor ambient temperature .	1
	KTY84 analog I/O	KTY84 sensor connected to the analog input selected by parameter 35.14 Temperature 1 AI source and an analog output. The following settings are required: <ul style="list-style-type: none"> Set the appropriate analog input unit selection parameter in group 12 Standard AI to V (volt). In parameter group 13 Standard AO, set the source selection parameter of the analog output to Temp sensor 1 excitation. The analog output feeds a constant current through the sensor. As the resistance of the sensor increases along with its temperature, the voltage over the sensor increases. The voltage is read by the analog input and converted into degrees.	2
	Reserved		3...4

No.	Name/Value	Description	Def/FbEq16
	1 × Pt100 analog I/O	<p>Pt100 sensor connected to a standard analog input selected by parameter 35.14 Temperature 1 AI source and an analog output.</p> <p>The following settings are required:</p> <ul style="list-style-type: none"> Set the appropriate analog input unit selection parameter in group 12 Standard AI to <i>V</i> (volt). In parameter group 13 Standard AO, set the source selection parameter of the analog output to <i>Temp sensor 1 excitation</i>. <p>The analog output feeds a constant current through the sensor. As the resistance of the sensor increases along with its temperature, the voltage over the sensor increases. The voltage is read by the analog input and converted into degrees.</p>	5
	2 × Pt100 analog I/O	As selection 1 × Pt100 analog I/O , but with two sensors connected in series. Using multiple sensors improves measurement accuracy significantly.	6
	3 × Pt100 analog I/O	As selection 1 × Pt100 analog I/O , but with three sensors connected in series. Using multiple sensors improves measurement accuracy significantly.	7
	Reserved		8...10
	Direct temperature	The temperature is taken from the source selected by parameter 35.14 . The value of the source is assumed to be in the unit of temperature specified by 96.16 .	11
	KTY83 analog I/O	<p>KTY83 sensor connected to the analog input selected by parameter 35.14 Temperature 1 AI source and an analog output.</p> <p>The following settings are required:</p> <ul style="list-style-type: none"> Set the appropriate analog input unit selection parameter in group 12 Standard AI to <i>V</i> (volt). In parameter group 13 Standard AO, set the source selection parameter of the analog output to <i>Temp sensor 1 excitation</i>. <p>The analog output feeds a constant current through the sensor. As the resistance of the sensor increases along with its temperature, the voltage over the sensor increases. The voltage is read by the analog input and converted into degrees.</p>	12
	1 × Pt1000 analog I/O	<p>Pt1000 sensor connected to a standard analog input selected by parameter 35.14 Temperature 1 AI source and an analog output.</p> <p>The following settings are required:</p> <ul style="list-style-type: none"> Set the appropriate analog input unit selection parameter in group 12 Standard AI to <i>V</i> (volt). In parameter group 13 Standard AO, set the source selection parameter of the analog output to <i>Temp sensor 1 excitation</i>. <p>The analog output feeds a constant current through the sensor. As the resistance of the sensor increases along with its temperature, the voltage over the sensor increases. The voltage is read by the analog input and converted into degrees.</p>	13
	2 × Pt1000 analog I/O	As selection 1 × Pt1000 analog I/O , but with two sensors connected in series. Using multiple sensors improves measurement accuracy significantly.	14

No.	Name/Value	Description	Def/FbEq16
	3 × Pt1000 analog I/O	As selection 1 × Pt1000 analog I/O , but with three sensors connected in series. Using multiple sensors improves measurement accuracy significantly.	15
	Ni1000	<p>Ni1000 sensor connected to the analog input selected by parameter 35.14 Temperature 1 AI source and an analog output.</p> <p>The following settings are required:</p> <ul style="list-style-type: none"> • Set the appropriate analog input unit selection parameter in group 12 Standard AI to V (volt). • In parameter group 13 Standard AO, set the source selection parameter of the analog output to Temp sensor 1 excitation. <p>The analog output feeds a constant current through the sensor. As the resistance of the sensor increases along with its temperature, the voltage over the sensor increases. The voltage is read by the analog input and converted into degrees.</p>	16
	Reserved		17...20
	PTC analog I/O	<p>PTC sensor connected to the analog input selected by parameter 35.14 and an analog output.</p> <p>The required settings are the same as with selection KTY84 analog I/O. If a PTC sensor is used, the voltage read by the analog input is converted into ohms.</p> <p>Note: With this selection, the control program converts the analog signal to PTC resistance value in ohms and shows it in parameter 35.02. The parameter name and unit still refer to temperature.</p>	20
	Therm(0)	Normally closed thermistor relay connected to digital input DI6. The motor is overheated when the digital input is 0.	21
	Therm(1)	Normally open thermistor relay connected to digital input DI6. The motor is overheated when the digital input is 1.	22
	PTC AI/DI Voltage divider tree	<p>PTC sensor connected to the analog input selected by parameter 35.14, DI_n and 10 V reference.</p> <p>A special voltage divider connection must be in use instead of the normal PTC connection. The voltage divider connection uses terminals +10 V, digital input and analog input. See the <i>Hardware manual</i> of the drive for the actual connection.</p> <p>This selection makes it possible to connect the PTC when no analog output is available.</p> <p>The required settings are the same as with selection KTY84 analog I/O. In case of PTC, the voltage read by the analog input is converted into ohms.</p> <p>Note:</p> <ul style="list-style-type: none"> • The used DI must not be configured to start any action in this setup. • Make sure that the digital input that you connect to this voltage divider circuit is not used for any other purpose in the control program. <p>With this selection, the parameter 35.02 shows PTC resistance in ohms, not motor temperature, even if the parameter name and unit still refer to temperature.</p>	23

No.	Name/Value	Description	Def/FbEq16
35.12	<i>Temperature 1 fault limit</i>	Defines the fault limit for temperature supervision function 1. When measured temperature 1 exceeds the limit, the drive trips on fault 4981 External temperature 1 . The unit is selected by parameter 96.16 Unit selection .	130 °C or 266 °F or
	-60...5000 °C or -76...9032 °F	Fault limit for temperature monitoring function 1.	1 = 1 unit
35.13	<i>Temperature 1 warning limit</i>	Defines the warning limit for temperature supervision function 1. When measured temperature 1 exceeds the limit, warning A491 External temperature 1 is generated. The unit is selected by parameter 96.16 Unit selection .	110 °C or 230 °F
	-60...5000 °C or -76...9032 °F	Warning limit for temperature monitoring function 1.	1 = 1 unit
35.14	<i>Temperature 1 AI source</i>	Specifies the analog input when the setting of 35.11 Temperature 1 source requires measurement through an analog input. Note: If parameter 35.11 Temperature 1 source is set to Direct temperature , use selection <i>Other</i> here, and point to 12.12 AI1 scaled value .	<i>Not selected</i>
	Not selected	None.	0
	AI1 actual value	Analog input AI1 on the control unit.	1
	AI2 actual value	Analog input AI2 on the control unit.	2
	AI3 actual value	Analog input AI3 on the control unit.	3
	AI4 actual value	Analog input AI4 on the control unit.	4
	AI5 actual value	Analog input AI5 on the control unit.	5
	<i>Other</i>	Source selection (see Terms and abbreviations on page 358).	-
35.21	<i>Temperature 2 source</i>	Selects the source from which measured temperature 2 is read. Usually this source is from a sensor connected to the motor controlled by the drive, but it could be used to measure and monitor a temperature from other parts of the process as long as a suitable sensor is used as per the selection list.	<i>Disabled</i>
	Disabled	None. Temperature monitoring function 2 is disabled.	0
	Estimated temperature	Estimated motor temperature (see parameter 35.01 Motor estimated temperature). The temperature is estimated from an internal drive calculation. It is important to set up the ambient temperature of the motor in 35.50 Motor ambient temperature .	1
	KTY84 analog I/O	KTY84 sensor connected to the analog input selected by parameter 35.24 Temperature 2 AI source and an analog output. The following settings are required: <ul style="list-style-type: none"> Set the appropriate analog input unit selection parameter in group 12 Standard AI to V (volt). In parameter group 13 Standard AO, set the source selection parameter of the analog output to Temp sensor 2 excitation. The analog output feeds a constant current through the sensor. As the resistance of the sensor increases along with its temperature, the voltage over the sensor increases. The voltage is read by the analog input and converted into degrees.	2
	Reserved		3...4

No.	Name/Value	Description	Def/FbEq16
	1 × Pt100 analog I/O	<p>Pt100 sensor connected to a standard analog input selected by parameter 35.24 Temperature 2 AI source and an analog output.</p> <p>The following settings are required:</p> <ul style="list-style-type: none"> • Set the appropriate analog input unit selection parameter in group 12 Standard AI to <i>V</i> (volt). • In parameter group 13 Standard AO, set the source selection parameter of the analog output to Temp sensor 2 excitation. <p>The analog output feeds a constant current through the sensor. As the resistance of the sensor increases along with its temperature, the voltage over the sensor increases. The voltage is read by the analog input and converted into degrees.</p>	5
	2 × Pt100 analog I/O	As selection 1 × Pt100 analog I/O , but with two sensors connected in series. Using multiple sensors improves measurement accuracy significantly.	6
	3 × Pt100 analog I/O	As selection 1 × Pt100 analog I/O , but with three sensors connected in series. Using multiple sensors improves measurement accuracy significantly.	7
	Reserved		9...10
	Direct temperature	The temperature is taken from the source selected by parameter 35.24 . The value of the source is assumed to be in the unit of temperature specified by 96.16 .	11
	KTY83 analog I/O	<p>KTY83 sensor connected to the analog input selected by parameter 35.14 Temperature 1 AI source and an analog output.</p> <p>The following settings are required:</p> <ul style="list-style-type: none"> • Set the appropriate analog input unit selection parameter in group 12 Standard AI to <i>V</i> (volt). • In parameter group 13 Standard AO, set the source selection parameter of the analog output to Temp sensor 2 excitation. <p>The analog output feeds a constant current through the sensor. As the resistance of the sensor increases along with its temperature, the voltage over the sensor increases. The voltage is read by the analog input and converted into degrees.</p>	12
	1 × Pt1000 analog I/O	<p>Pt1000 sensor connected to a standard analog input selected by parameter 35.14 Temperature 1 AI source and an analog output.</p> <p>The following settings are required:</p> <ul style="list-style-type: none"> • Set the appropriate analog input unit selection parameter in group 12 Standard AI to <i>V</i> (volt). • In parameter group 13 Standard AO, set the source selection parameter of the analog output to Temp sensor 2 excitation. <p>The analog output feeds a constant current through the sensor. As the resistance of the sensor increases along with its temperature, the voltage over the sensor increases. The voltage is read by the analog input and converted into degrees.</p>	13
	2 × Pt1000 analog I/O	As selection 1 × Pt1000 analog I/O , but with two sensors connected in series. Using multiple sensors improves measurement accuracy significantly.	14

No.	Name/Value	Description	Def/FbEq16
	3 x Pt1000 analog I/O	As selection <i>1 x Pt1000 analog I/O</i> , but with three sensors connected in series. Using multiple sensors improves measurement accuracy significantly.	15
	Ni1000	Ni1000 sensor connected to the analog input selected by parameter <i>35.14 Temperature 1 AI source</i> and an analog output. The following settings are required: <ul style="list-style-type: none"> Set the appropriate analog input unit selection parameter in group <i>12 Standard AI to V</i> (volt). In parameter group <i>13 Standard AO</i>, set the source selection parameter of the analog output to <i>Temp sensor 2 excitation</i>. The analog output feeds a constant current through the sensor. As the resistance of the sensor increases along with its temperature, the voltage over the sensor increases. The voltage is read by the analog input and converted into degrees.	16
	Reserved		17...20
	PTC analog I/O	PTC sensor connected to the analog input selected by parameter <i>35.24</i> and an analog output. The required settings are the same as with selection <i>KTY84 analog I/O</i> . If a PTC sensor is used, the voltage ready by the analog input is converted into ohms. Note: With this selection, the control program converts the analog signal to PTC resistance value in ohms and shows it in parameter <i>35.03</i> . The parameter name and unit still refer to temperature.	20
	Therm(0)	Normally closed thermistor relay connected to digital input DI6. The motor is overheated when the digital input is 0.	21
	Therm(1)	Normally open thermistor relay connected to digital input DI6. The motor is overheated when the digital input is 1.	22
	PTC AI/DI Voltage divider tree	PTC sensor connected to the analog input selected by parameter <i>35.24</i> , DIIn and 10 V reference. A special voltage divider connection must be in use instead of the normal PTC connection. The voltage divider connection uses terminals +10 V, digital input and analog input. See the <i>Hardware manual</i> of the drive for the actual connection. This selection makes it possible to connect the PTC when no analog output is available. The required settings are the same as with selection <i>KTY84 analog I/O</i> . In case of PTC, the voltage read by the analog input is converted into ohms. Notes: <ul style="list-style-type: none"> The used DI must not be configured to start any action in this setup. Make sure that the digital input that you connect to this voltage divider circuit is not used for any other purpose in the control program. With this selection, the parameter <i>35.02</i> shows PTC resistance in ohms, not motor temperature, even if the parameter name and unit still refer to temperature.	23

No.	Name/Value	Description	Def/FbEq16
35.22	<i>Temperature 2 fault limit</i>	Defines the fault limit for temperature supervision function 2. When measured temperature 1 exceeds the limit, the drive trips on fault 4982 External temperature 2 . The unit is selected by parameter 96.16 Unit selection .	130 °C or 266 °F
	-60...5000 °C or -76...9032 °F	Fault limit for temperature monitoring function 2.	1 = 1 unit
35.23	<i>Temperature 2 warning limit</i>	Defines the warning limit for temperature supervision function 2. When measured temperature 1 exceeds the limit, warning A492 External temperature 2 is generated. The unit is selected by parameter 96.16 Unit selection .	110 °C or 230 °F
	-60...5000 °C or -76...9032 °F	Warning limit for temperature monitoring function 2.	1 = 1 unit
35.24	<i>Temperature 2 AI source</i>	Specifies the analog input when the setting of 35.11 Temperature 1 source requires measurement through an analog input.	<i>Not selected</i>
	Not selected	None.	0
	AI1 actual value	Analog input AI1 on the control unit.	1
	AI2 actual value	Analog input AI2 on the control unit.	2
	AI3 actual value	Associated with the CAIO-01 module. Visible only if bit 8 (CAIO-01) of parameter 07.36 is set high in the boot process.	3
	AI4 actual value	Associated with the CAIO-01 module. Visible only if bit 8 (CAIO-01) of parameter 07.36 is set high in the boot process.	4
	AI5 actual value	Associated with the CAIO-01 module. Visible only if bit 8 (CAIO-01) of parameter 07.36 is set high in the boot process.	5
	<i>Other</i>	Source selection (see Terms and abbreviations on page 358).	-
35.50	<i>Motor ambient temperature</i>	Defines the ambient temperature of the motor for the motor thermal protection model. The unit is selected by parameter 96.16 Unit selection . The motor thermal protection model estimates the motor temperature on the basis of parameters 35.50...35.55 . The motor temperature increases if it operates in the region above the load curve, and decreases if it operates in the region below the load curve.  WARNING! The model cannot protect the motor if the motor does not cool properly because of dust, dirt, etc.	20 °C or 68 °F
	-60...100 °C or -76 ... 212 °F	Ambient temperature.	1 = 1 unit

No.	Name/Value	Description	Def/FbEq16
35.51	<i>Motor load curve</i>	<p>Defines the maximum thermal load of the motor. If the load is above the curve, the motor can be overheated.</p> <p>The load curve is used by the motor thermal protection model to estimate the motor temperature.</p> <p>When the parameter is set to 100%, the maximum load is taken as the value of parameter 99.06 Motor nominal current (higher loads heat up the motor). The load curve level should be adjusted if the ambient temperature differs from the nominal value set in 35.50 Motor ambient temperature.</p>	110%
<p style="text-align: center;">$I =$ Motor current $I_N =$ Nominal motor current</p>			
	50...150%	Maximum load for the motor load curve.	1 = 1%
35.52	<i>Zero speed load</i>	<p>Defines the motor load curve together with parameters 35.51 Motor load curve and 35.53 Break point. Defines the maximum motor load at zero speed of the load curve. A higher value can be used if the motor has an external motor fan to boost the cooling. See the motor manufacturer's recommendations.</p> <p>See parameter 35.51 Motor load curve.</p>	70%
	25...150%	Zero speed load for the motor load curve.	1 = 1%
35.53	<i>Break point</i>	<p>Defines the motor load curve together with parameters 35.51 Motor load curve and 35.52 Zero speed load. Defines the break point frequency of the load curve, ie, the point at which the motor load curve begins to decrease from the value of parameter 35.51 Motor load curve towards the value of parameter 35.52 Zero speed load.</p> <p>See parameter 35.51 Motor load curve.</p>	45.00 Hz
	1.00...500.00 Hz	Break point for the motor load curve.	See par. 46.02

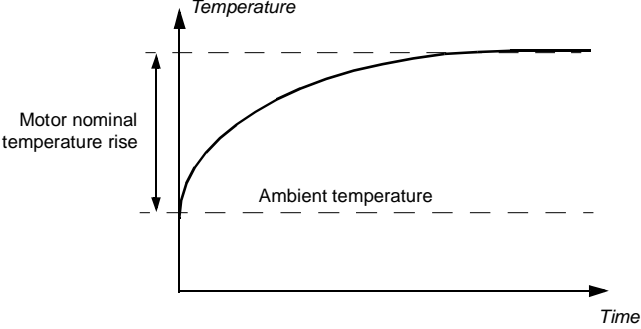
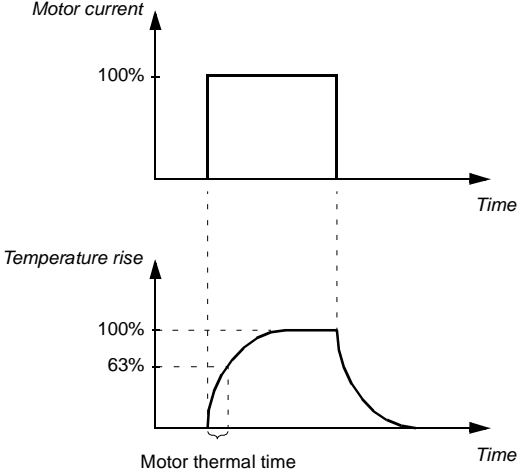
No.	Name/Value	Description	Def/FbEq16
35.54	<i>Motor nominal temperature rise</i>	<p>Defines the temperature rise of the motor above ambient when the motor is loaded with nominal current. See the motor manufacturer's recommendations.</p> <p>The unit is selected by parameter 96.16 Unit selection.</p>	80 °C or 144 °F
			
	0...300 °C or 0...540 °F	Temperature rise.	1 = 1 unit
35.55	<i>Motor thermal time constant</i>	<p>Defines the thermal time constant for use with the motor thermal protection model, defined as the time to reach 63% of the nominal motor temperature. See the motor manufacturer's recommendations.</p> <p>For thermal protection according to UL requirements for NEMA class motors, use the rule of thumb: Motor thermal time equals 35 times t_6, where t_6 (in seconds) is specified by the motor manufacturer as the time that the motor can safely operate at six times its rated current.</p>	256 s
			
	100...10000 s	Motor thermal time constant.	1 = 1 s

No.	Name/Value	Description	Def/FbEq16
35.56	<i>Motor overload action</i>	Selects the action taken when the system detects the motor overload specified by parameter <i>35.57</i> . See section <i>Motor overload protection</i> (page 207).	<i>Warning and fault</i>
	No action	No action taken.	0
	Warning only	Drive generates warning <i>A783 Motor overload</i> when the motor is overloaded to the warning level, that is, parameter <i>35.05 Motor overload level</i> reaches value 88.0%.	1
	Warning and fault	Drive generates warning <i>A783 Motor overload</i> when the motor is overloaded to the warning level, that is, parameter <i>35.05 Motor overload level</i> reaches value 88.0%. Drive trips on fault <i>7122 Motor overload</i> when the motor is overloaded to the fault level, that is, parameter <i>35.05 Motor overload level</i> reaches value 100.0%.	2
35.57	<i>Motor overload class</i>	Defines the motor overload class to be used. The class of protection is specified by the user as the time for tripping at 7.2 times (IEC 60947-4-1) or 6 times (NEMA ICS) the tripping level current. See section <i>Motor overload protection</i> (page 207).	<i>Class 20</i>
	Class 5	Motor overload class 5.	0
	Class 10	Motor overload class 10.	1
	Class 20	Motor overload class 20.	2
	Class 30	Motor overload class 30.	3
	Class 40	Motor overload class 40.	4
36 Load analyzer		Peak value and amplitude logger settings. See also section <i>Load analyzer</i> (page 225).	
36.01	<i>PVL signal source</i>	Selects the signal to be monitored by the peak value logger. The signal is filtered using the filtering time specified by parameter <i>36.02 PVL filter time</i> . The peak value is stored, along with other pre-selected signals at the time, into parameters <i>36.10...36.15</i> . The peak value logger can be reset using parameter <i>36.09 Reset loggers</i> . The logger is also reset whenever the signal source is changed. The date and time of the last reset are stored into parameters <i>36.16</i> and <i>36.17</i> respectively.	<i>Motor current</i>
	Not selected	None (peak value logger disabled).	0
	Motor speed used	<i>01.01 Motor speed used</i> (page 361).	1
	Reserved		2
	Output frequency	<i>01.06 Output frequency</i> (page 361).	3
	Motor current	<i>01.07 Motor current</i> (page 361).	4
	Reserved		5
	Motor torque	<i>01.10 Motor torque</i> (page 361).	6
	DC voltage	<i>01.11 DC voltage</i> (page 361).	7
	Output power	<i>01.14 Output power</i> (page 362).	8
	Reserved		9
	Speed ref ramp in	<i>23.01 Speed ref ramp input</i> (page 449).	10
	Speed ref ramp out	<i>23.02 Speed ref ramp output</i> (page 449).	11
	Speed ref used	<i>24.01 Used speed reference</i> (page 452).	12

No.	Name/Value	Description	Def/FbEq16
	Reserved		13
	Freq ref used	28.02 Frequency ref ramp output (page 457).	14
	Reserved		15
	Process PID out	40.01 Process PID output actual (page 521).	16
	<i>Other</i>	Source selection (see Terms and abbreviations on page 358).	-
36.02	PVL filter time	Peak value logger filtering time. See parameter 36.01 PVL signal source .	2.00 s
	0.00...120.00 s	Peak value logger filtering time.	100 = 1 s
36.06	AL2 signal source	Selects the signal to be monitored by amplitude logger 2. The signal is sampled at 200 ms intervals. The results are displayed by parameters 36.40...36.49 . Each parameter represents an amplitude range, and shows what portion of the samples fall within that range. The signal value corresponding to 100% is defined by parameter 36.07 AL2 signal scaling . Amplitude logger 2 can be reset using parameter 36.09 Reset loggers . The logger is also reset whenever the signal source or scaling is changed. The date and time of the last reset are stored into parameters 36.50 and 36.51 respectively. For the selections, see parameter 36.01 PVL signal source .	Output frequency
36.07	AL2 signal scaling	Defines the signal value that corresponds to 100% amplitude.	50.00 or 60.00 (see 95.20 bit 0)
	0.00...32767.00	Signal value corresponding to 100%.	1 = 1
36.09	Reset loggers	Resets the peak value logger and/or amplitude logger 2. (Amplitude logger 1 cannot be reset.)	Done
	Done	Reset completed or not requested (normal operation).	0
	All	Reset both the peak value logger and amplitude logger 2.	1
	PVL	Reset the peak value logger.	2
	AL2	Reset amplitude logger 2.	3
36.10	PVL peak value	Peak value recorded by the peak value logger.	0.00
	-32768.00... 32767.00	Peak value.	1 = 1
36.11	PVL peak date	The date on which the peak value was recorded.	01.01.1980
	-	Peak occurrence date.	-
36.12	PVL peak time	The time at which the peak value was recorded.	00:00:05
	-	Peak occurrence time.	-
36.13	PVL current at peak	Motor current at the moment the peak value was recorded.	0.00 A
	-32768.00... 32767.00 A	Motor current at peak.	1 = 1 A
36.14	PVL DC voltage at peak	Voltage in the intermediate DC circuit of the drive at the moment the peak value was recorded.	0.00 V
	0.00...2000.00 V	DC voltage at peak.	10 = 1 V

No.	Name/Value	Description	Def/FbEq16
36.15	<i>PVL speed at peak</i>	Motor speed at the moment the peak value was recorded.	0.00 rpm
	-30000.00... 30000.00 rpm	Motor speed at peak.	See par. 46.01
36.16	<i>PVL reset date</i>	The date on which the peak value logger was last reset.	01.01.1980
	-	Last reset date of the peak value logger.	
36.17	<i>PVL reset time</i>	The time at which the peak value logger was last reset.	00:00:05
	-	Last reset time of the peak value logger.	
36.20	<i>AL1 0 to 10%</i>	Percentage of samples recorded by amplitude logger 1 that fall between 0 and 10%. 100% corresponds to the I_{\max} value given in the ratings table in chapter Technical data in the <i>Hardware manual</i> of the drive.	0.00%
	0.00...100.00%	Amplitude logger 1 samples between 0 and 10%.	1 = 1%
36.21	<i>AL1 10 to 20%</i>	Percentage of samples recorded by amplitude logger 1 that fall between 10 and 20%.	0.00%
	0.00...100.00%	Amplitude logger 1 samples between 10 and 20%.	1 = 1%
36.22	<i>AL1 20 to 30%</i>	Percentage of samples recorded by amplitude logger 1 that fall between 20 and 30%.	0.00%
	0.00...100.00%	Amplitude logger 1 samples between 20 and 30%.	1 = 1%
36.23	<i>AL1 30 to 40%</i>	Percentage of samples recorded by amplitude logger 1 that fall between 30 and 40%.	0.00%
	0.00...100.00%	Amplitude logger 1 samples between 30 and 40%.	1 = 1%
36.24	<i>AL1 40 to 50%</i>	Percentage of samples recorded by amplitude logger 1 that fall between 40 and 50%.	0.00%
	0.00...100.00%	Amplitude logger 1 samples between 40 and 50%.	1 = 1%
36.25	<i>AL1 50 to 60%</i>	Percentage of samples recorded by amplitude logger 1 that fall between 50 and 60%.	0.00%
	0.00...100.00%	Amplitude logger 1 samples between 50 and 60%.	1 = 1%
36.26	<i>AL1 60 to 70%</i>	Percentage of samples recorded by amplitude logger 1 that fall between 60 and 70%.	0.00%
	0.00...100.00%	Amplitude logger 1 samples between 60 and 70%.	1 = 1%
36.27	<i>AL1 70 to 80%</i>	Percentage of samples recorded by amplitude logger 1 that fall between 70 and 80%.	0.00%
	0.00...100.00%	Amplitude logger 1 samples between 70 and 80%.	1 = 1%
36.28	<i>AL1 80 to 90%</i>	Percentage of samples recorded by amplitude logger 1 that fall between 80 and 90%.	0.00%
	0.00...100.00%	Amplitude logger 1 samples between 80 and 90%.	1 = 1%
36.29	<i>AL1 over 90%</i>	Percentage of samples recorded by amplitude logger 1 that exceed 90%.	0.00%
	0.00...100.00%	Amplitude logger 1 samples over 90%.	1 = 1%
36.40	<i>AL2 0 to 10%</i>	Percentage of samples recorded by amplitude logger 2 that fall between 0 and 10%.	0.00%
	0.00...100.00%	Amplitude logger 2 samples between 0 and 10%.	1 = 1%
36.41	<i>AL2 10 to 20%</i>	Percentage of samples recorded by amplitude logger 2 that fall between 10 and 20%.	0.00%
	0.00...100.00%	Amplitude logger 2 samples between 10 and 20%.	1 = 1%

No.	Name/Value	Description	Def/FbEq16
36.42	AL2 20 to 30%	Percentage of samples recorded by amplitude logger 2 that fall between 20 and 30%.	0.00%
	0.00...100.00%	Amplitude logger 2 samples between 20 and 30%.	1 = 1%
36.43	AL2 30 to 40%	Percentage of samples recorded by amplitude logger 2 that fall between 30 and 40%.	0.00%
	0.00...100.00%	Amplitude logger 2 samples between 30 and 40%.	1 = 1%
36.44	AL2 40 to 50%	Percentage of samples recorded by amplitude logger 2 that fall between 40 and 50%.	0.00%
	0.00...100.00%	Amplitude logger 2 samples between 40 and 50%.	1 = 1%
36.45	AL2 50 to 60%	Percentage of samples recorded by amplitude logger 2 that fall between 50 and 60%.	0.00%
	0.00...100.00%	Amplitude logger 2 samples between 50 and 60%.	1 = 1%
36.46	AL2 60 to 70%	Percentage of samples recorded by amplitude logger 2 that fall between 60 and 70%.	0.00%
	0.00...100.00%	Amplitude logger 2 samples between 60 and 70%.	1 = 1%
36.47	AL2 70 to 80%	Percentage of samples recorded by amplitude logger 2 that fall between 70 and 80%.	0.00%
	0.00...100.00%	Amplitude logger 2 samples between 70 and 80%.	1 = 1%
36.48	AL2 80 to 90%	Percentage of samples recorded by amplitude logger 2 that fall between 80 and 90%.	0.00%
	0.00...100.00%	Amplitude logger 2 samples between 80 and 90%.	1 = 1%
36.49	AL2 over 90%	Percentage of samples recorded by amplitude logger 2 that exceed 90%.	0.00%
	0.00...100.00%	Amplitude logger 2 samples over 90%.	1 = 1%
36.50	AL2 reset date	The date on which amplitude logger 2 was last reset.	01.01.1980
	-	Last reset date of amplitude logger 2.	
36.51	AL2 reset time	The time at which amplitude logger 2 was last reset.	00:00:05
	-	Last reset time of amplitude logger 2.	

37 User load curve		Settings for user load curve. See also section User load curve (page 230).																			
37.01	ULC output status word	Displays the status of the monitored signal. The status is shown only while the drive is running. (The status word is independent of the actions and delays selected by parameters 37.03 , 37.04 , 37.41 and 37.42 .) This parameter is read-only.	-																		
<table border="1"> <thead> <tr> <th>Bit</th> <th>Name</th> <th>Description</th> </tr> </thead> <tbody> <tr> <td>0</td> <td>Under load limit</td> <td>1 = Signal lower than the underload curve.</td> </tr> <tr> <td>1</td> <td>Within load range</td> <td>1 = Signal between the underload and overload curve.</td> </tr> <tr> <td>2</td> <td>Overload limit</td> <td>1 = Signal higher than the overload curve.</td> </tr> <tr> <td>3</td> <td>Outside load limit</td> <td>1 = Signal lower than the underload curve or higher than the overload curve.</td> </tr> <tr> <td>4...15</td> <td>Reserved</td> <td></td> </tr> </tbody> </table>		Bit	Name	Description	0	Under load limit	1 = Signal lower than the underload curve.	1	Within load range	1 = Signal between the underload and overload curve.	2	Overload limit	1 = Signal higher than the overload curve.	3	Outside load limit	1 = Signal lower than the underload curve or higher than the overload curve.	4...15	Reserved			
Bit	Name	Description																			
0	Under load limit	1 = Signal lower than the underload curve.																			
1	Within load range	1 = Signal between the underload and overload curve.																			
2	Overload limit	1 = Signal higher than the overload curve.																			
3	Outside load limit	1 = Signal lower than the underload curve or higher than the overload curve.																			
4...15	Reserved																				
0000h...FFFFh		Status of the monitored signal.	1 = 1																		

No.	Name/Value	Description	Def/FbEq16
37.02	<i>ULC supervision signal</i>	Selects the signal to be monitored. The function compares the absolute value of the signal against the load curve.	<i>Motor torque %</i>
	Not selected	No signal selected (monitoring disabled).	0
	Motor speed %	<i>01.03 Motor speed %</i> (page 361).	1
	Motor current %	<i>01.08 Motor current % of motor nom</i> (page 361).	2
	Motor torque %	<i>01.10 Motor torque</i> (page 361).	3
	Output power % of motor nominal	<i>01.15 Output power % of motor nom</i> (page 362).	4
	<i>Other</i>	Source selection (see <i>Terms and abbreviations</i> on page 358).	-
37.03	<i>ULC overload actions</i>	Selects how the drive reacts if the absolute value of the monitored signal stays continuously above the overload curve for longer than the value of <i>37.41 ULC overload timer</i> .	<i>Disabled</i>
	Disabled	No action taken.	0
	Warning	Drive generates warning <i>A8BE ULC overload warning</i> .	1
	Fault	Drive trips on fault <i>8002 ULC overload fault</i> .	2
	Warning/Fault	Drive generates warning <i>A8BE ULC overload warning</i> if the signal stays continuously above the overload curve for half of the time defined by parameter <i>37.41 ULC overload timer</i> . Drive trips on fault <i>8002 ULC overload fault</i> if the signal stays continuously above the overload curve for a time defined by parameter <i>37.41 ULC overload timer</i> .	3
37.04	<i>ULC underload actions</i>	Selects how the drive reacts if the absolute value of the monitored signal stays continuously above the overload curve for longer than the value of <i>37.42 ULC underload timer</i> .	<i>Disabled</i>
	Disabled	No action taken.	0
	Warning	Drive generates warning <i>A8BF ULC underload warning</i> .	1
	Fault	Drive trips on fault <i>8001 ULC underload fault</i> .	2
	Warning/Fault	Drive generates warning <i>A8BF ULC underload warning</i> if the signal stays continuously below the underload curve for half of the time defined by parameter <i>37.41 ULC overload timer</i> . Drive trips on fault <i>8001 ULC underload fault</i> if the signal stays continuously above the underload curve for a time defined by parameter <i>37.42 ULC underload timer</i> .	3
37.11	<i>ULC speed table point 1</i>	Defines the first of the five speed points on the X-axis of the user load curve. Speed points are used if parameter <i>99.04 Motor control mode</i> is set to <i>Vector</i> or if <i>99.04 Motor control mode</i> is set to <i>Scalar</i> and the reference unit is rpm. The five points must be in order from lowest to highest. The points are defined as positive values, but the range is symmetrically effective also in the negative direction. The monitoring is not active outside these two areas.	150.0 rpm
	-30000.0...30000.0 rpm	Speed.	1 = 1 rpm
37.12	<i>ULC speed table point 2</i>	Defines the second speed point. See parameter <i>37.11 ULC speed table point 1</i> .	750.0 rpm
	-30000.0...30000.0 rpm	Speed.	1 = 1 rpm

No.	Name/Value	Description	Def/FbEq16
37.13	ULC speed table point 3	Defines the third speed point. See parameter 37.11 ULC speed table point 1 .	1290.0 rpm
	-30000.0...30000.0 rpm	Speed.	1 = 1 rpm
37.14	ULC speed table point 4	Defines the fourth speed point. See parameter 37.11 ULC speed table point 1 .	1500.0 rpm
	-30000.0...30000.0 rpm	Speed.	1 = 1 rpm
37.15	ULC speed table point 5	Defines the fifth speed point. See parameter 37.11 ULC speed table point 1 .	1800.0 rpm
	-30000.0...30000.0 rpm	Speed.	1 = 1 rpm
37.16	ULC frequency table point 1	Defines the first of the five frequency points on the X-axis of the user load curve. Frequency points are used if parameter 99.04 Motor control mode is set to <i>Scalar</i> and the reference unit is Hz. The five points must be in order from lowest to highest. The points are defined as positive values, but the range is symmetrically effective also in the negative direction. The monitoring is not active outside these two areas.	5.0 Hz
	-500.0...500.0 Hz	Frequency.	1 = 1 Hz
37.17	ULC frequency table point 2	Defines the second frequency point. See parameter 37.16 ULC frequency table point 1 .	25.0 Hz
	-500.0...500.0 Hz	Frequency.	1 = 1 Hz
37.18	ULC frequency table point 3	Defines the third frequency point. See parameter 37.16 ULC frequency table point 1 .	43.0 Hz
	-500.0...500.0 Hz	Frequency.	1 = 1 Hz
37.19	ULC frequency table point 4	Defines the fourth frequency point. See parameter 37.16 ULC frequency table point 1 .	50.0 Hz
	-500.0...500.0 Hz	Frequency.	1 = 1 Hz
37.20	ULC frequency table point 5	Defines the fifth frequency point. See parameter 37.16 ULC frequency table point 1 .	60.0 Hz
	-500.0...500.0 Hz	Frequency.	1 = 1 Hz
37.21	ULC underload point 1	Defines the first of the five points on the Y-axis that together with the corresponding point on the X-axis (37.11 ULC speed table point 1 ... 37.15 ULC speed table point 5 or 37.15 ULC speed table point 5 ... 37.20 ULC frequency table point 5) define the underload (lower) curve. Each point of the underload curve must have a lower value than the corresponding overload point.	10.0%
	-1600.0...1600.0%	Underload point.	1 = 1%
37.22	ULC underload point 2	Defines the second underload point. See parameter 37.21 ULC underload point 1 .	15.0%
	-1600.0...1600.0%	Underload point.	1 = 1%
37.23	ULC underload point 3	Defines the third underload point. See parameter 37.21 ULC underload point 1 .	25.0%
	-1600.0...1600.0%	Underload point.	1 = 1%

No.	Name/Value	Description	Def/FbEq16
37.24	<i>ULC underload point 4</i>	Defines the fourth underload point. See parameter 37.21 ULC underload point 1 .	30.0%
	-1600.0...1600.0%	Underload point.	1 = 1%
37.25	<i>ULC underload point 5</i>	Defines the fifth underload point. See parameter 37.21 ULC underload point 1	30.0%
	-1600.0...1600.0%	Underload point.	1 = 1%
37.31	<i>ULC overload point 1</i>	Defines the first of the five points on the Y-axis that together with the corresponding point on the X-axis (37.11 ULC speed table point 1 ... 37.15 ULC speed table point 5 or 37.15 ULC speed table point 5 ... 37.20 ULC frequency table point 5) define the overload (higher) curve. Each point of the overload curve must have a higher value than the corresponding underload point.	300.0%
	-1600.0...1600.0%	Overload point.	1 = 1%
37.32	<i>ULC overload point 2</i>	Defines the second overload point. See parameter 37.31 ULC overload point 1 .	300.0%
	-1600.0...1600.0%	Overload point.	1 = 1%
37.33	<i>ULC overload point 3</i>	Defines the third overload point. See parameter 37.31 ULC overload point 1 .	300.0%
	-1600.0...1600.0%	Overload point.	1 = 1%
37.34	<i>ULC overload point 4</i>	Defines the fourth overload point. See parameter 37.31 ULC overload point 1 .	300.0%
	-1600.0...1600.0%	Overload point.	1 = 1%
37.35	<i>ULC overload point 5</i>	Defines the fifth overload point. See parameter 37.31 ULC overload point 1 .	300.0%
	-1600.0...1600.0%	Overload point.	1 = 1%
37.41	<i>ULC overload timer</i>	Defines the time for which the monitored signal must continuously stay above the overload curve before the drive takes the action selected by 37.03 ULC overload actions .	20.0 s
	0.0...10000.0 s	Overload timer.	1 = 1 s
37.42	<i>ULC underload timer</i>	Defines the time for which the monitored signal must continuously stay below the underload curve before the drive takes the action selected by 37.04 ULC underload actions .	20.0 s
	0.0...10000.0 s	Underload timer	1 = 1 s

No.	Name/Value	Description	Def/FbEq16
	40 Process PID set 1	<p>Parameter values for process PID control.</p> <p>The drive output can be controlled by the process PID. When the process PID control is enabled, the drive controls the process feedback to the reference value.</p> <p>Two different parameter sets can be defined for the process PID. One parameter set is in use at a time. The first set is made up of parameters 40.07...40.50, the second set is defined by the parameters in group 41 Process PID set 2. The binary source that defines which set is used is selected by parameter 40.57 PID set1/set2 selection.</p> <p>See also control chain diagrams PID setpoint compensation on page 374 and Direction lock on page 379.</p> <p>To set the PID customer unit, select Menu > Primary settings > PID > Unit on the control panel.</p>	
40.01	Process PID output actual	Displays the output of the process PID controller. See control chain diagram Process PID controller on page 376 . This parameter is read-only.	-
	-200000.00... 200000.00	Process PID controller output.	1 = 1
40.02	Process PID feedback actual	Displays the value of process feedback after source selection, mathematical function (parameter 40.10 Set 1 feedback function), and filtering. See control chain diagram PID setpoint compensation on page 374 . This parameter is read-only. See parameter 40.79 Set 1 units for information about the units used.	-
	-200000.00... 200000.00 set 1 units	Process feedback.	1 = 1 set 1 unit
40.03	Process PID setpoint actual	Displays the value of process PID setpoint after source selection, mathematical function (40.18 Set 1 setpoint function), limitation and ramping. See control chain diagram PID setpoint compensation on page 374 . This parameter is read-only.	-
	-200000...200000 set 1 units	Setpoint for process PID controller. See parameter 40.79 Set 1 units for information about the units used.	1 = 1 set 1 unit
40.04	Process PID deviation actual	Displays the process PID deviation. By default, this value equals setpoint - feedback, but deviation can be inverted by parameter 40.31 Set 1 deviation inversion . See control chain diagram Process PID controller on page 376 . This parameter is read-only. See parameter 40.79 Set 1 units for information about the units used.	-
	-200000.00... 200000.00 PID unit 1	PID deviation.	1 = 1 PID unit 1

No.	Name/Value	Description	Def/FbEq16																																													
40.06	<i>Process PID status word</i>	Displays status information on process PID control. This parameter is read-only.	-																																													
<table border="1"> <thead> <tr> <th>Bit</th> <th>Name</th> <th>Value</th> </tr> </thead> <tbody> <tr> <td>0</td> <td>PID active</td> <td>1 = Process PID control active.</td> </tr> <tr> <td>1</td> <td>Setpoint frozen</td> <td>1 = Process PID setpoint frozen.</td> </tr> <tr> <td>2</td> <td>Output frozen</td> <td>1 = Process PID controller output frozen.</td> </tr> <tr> <td>3</td> <td>PID sleep mode</td> <td>1 = Sleep mode active.</td> </tr> <tr> <td>4</td> <td>Sleep boost</td> <td>1 = Sleep boost active.</td> </tr> <tr> <td>5</td> <td>Reserved</td> <td></td> </tr> <tr> <td>6</td> <td>Tracking mode</td> <td>1 = Tracking function active.</td> </tr> <tr> <td>7</td> <td>Output limit high</td> <td>1 = PID output is being limited by par. 40.37.</td> </tr> <tr> <td>8</td> <td>Output limit low</td> <td>1 = PID output is being limited by par. 40.36.</td> </tr> <tr> <td>9</td> <td>Deadband active</td> <td>1 = Feedback value is in the deadband range (40.39).</td> </tr> <tr> <td>10</td> <td>PID set</td> <td>0 = Parameter set 1 in use. 1 = Parameter set 2 in use.</td> </tr> <tr> <td>11</td> <td>Reserved</td> <td></td> </tr> <tr> <td>12</td> <td>Internal setpoint active</td> <td>1 = Internal setpoint active (see par. 40.16...40.23).</td> </tr> <tr> <td>13...15</td> <td>Reserved</td> <td></td> </tr> </tbody> </table>				Bit	Name	Value	0	PID active	1 = Process PID control active.	1	Setpoint frozen	1 = Process PID setpoint frozen.	2	Output frozen	1 = Process PID controller output frozen.	3	PID sleep mode	1 = Sleep mode active.	4	Sleep boost	1 = Sleep boost active.	5	Reserved		6	Tracking mode	1 = Tracking function active.	7	Output limit high	1 = PID output is being limited by par. 40.37.	8	Output limit low	1 = PID output is being limited by par. 40.36.	9	Deadband active	1 = Feedback value is in the deadband range (40.39).	10	PID set	0 = Parameter set 1 in use. 1 = Parameter set 2 in use.	11	Reserved		12	Internal setpoint active	1 = Internal setpoint active (see par. 40.16...40.23).	13...15	Reserved	
Bit	Name	Value																																														
0	PID active	1 = Process PID control active.																																														
1	Setpoint frozen	1 = Process PID setpoint frozen.																																														
2	Output frozen	1 = Process PID controller output frozen.																																														
3	PID sleep mode	1 = Sleep mode active.																																														
4	Sleep boost	1 = Sleep boost active.																																														
5	Reserved																																															
6	Tracking mode	1 = Tracking function active.																																														
7	Output limit high	1 = PID output is being limited by par. 40.37.																																														
8	Output limit low	1 = PID output is being limited by par. 40.36.																																														
9	Deadband active	1 = Feedback value is in the deadband range (40.39).																																														
10	PID set	0 = Parameter set 1 in use. 1 = Parameter set 2 in use.																																														
11	Reserved																																															
12	Internal setpoint active	1 = Internal setpoint active (see par. 40.16...40.23).																																														
13...15	Reserved																																															
	0000h...FFFFh	Process PID control status word.	1 = 1																																													
40.07	<i>Process PID operation mode</i>	Activates/deactivates process PID control. Note: Process PID control is only available in external control; see section <i>Local control vs. external control</i> (page 107).	<i>Off</i>																																													
	Off	Process PID control inactive.	0																																													
	On	Process PID control active.	1																																													
	On when drive running	Process PID control is active when the drive is running.	2																																													
40.08	<i>Set 1 feedback 1 source</i>	Selects the primary source of process feedback. See control chain diagram <i>PID setpoint compensation</i> on page 374.	<i>AI2 scaled</i>																																													
	Not selected	None.	0																																													
	AI1 scaled	12.12 AI1 scaled value (see page 400).	1																																													
	AI2 scaled	12.22 AI2 scaled value (see page 402).	2																																													
	Freq in scaled	11.39 Freq in 1 scaled value (see page 394).	3																																													
	Reserved		4...7																																													
	AI1 percent	12.101 AI1 percent value (see page 403).	8																																													
	AI2 percent	12.102 AI2 percent value (see page 403).	9																																													
	Feedback data storage	40.91 Feedback data storage (see page 537). (Selection not available for parameter 71.08 Feedback 1 source .)	10																																													
	Actual flow	Parameter 80.01 Actual flow .	11																																													
	Actual flow %	Parameter 80.02 Actual flow .	12																																													
	AI3 scaled	15.52 AI3 scaled value (see page 507).	13																																													
	AI4 scaled	15.62 AI4 scaled value (see page 509).	14																																													
	AI5 scaled	15.72 AI5 scaled value (see page 511).	15																																													

No.	Name/Value	Description	Def/FbEq16
	AI3 percent	15.53 AI3 percent value (see page 507).	16
	AI4 percent	15.63 AI4 percent value (see page 509).	17
	AI5 percent	15.73 AI5 scaled value (see page 511).	18
	<i>Other</i>	Source selection (see Terms and abbreviations on page 358).	-
40.09	Set 1 feedback 2 source	Selects the second source of process feedback. The second source is used only if the setpoint function requires two inputs. For the available selections, see parameter 40.08 Set 1 feedback 1 source .	<i>Not selected</i>
40.10	Set 1 feedback function	Defines how process feedback is calculated from the two feedback sources selected by parameters 40.08 Set 1 feedback 1 source and 40.09 Set 1 feedback 2 source . The result of the function (for any selection) is multiplied by parameter 40.90 Set 1 feedback multiplier . (That is why in selections 12 and 13, the multiplier k is constant 1.)	<i>In1</i>
	In1	Source 1.	0
	In1+In2	Sum of sources 1 and 2.	1
	In1-In2	Source 2 subtracted from source 1.	2
	In1*In2	Source 1 multiplied by source 2.	3
	In1/In2	Source 1 divided by source 2.	4
	MIN(In1,In2)	Smaller of the two sources.	5
	MAX(In1,In2)	Greater of the two sources.	6
	AVE(In1,In2)	Average of the two sources.	7
	sqrt(In1)	Square root of source 1.	8
	sqrt(In1-In2)	Square root of (source 1 - source 2).	9
	sqrt(In1+In2)	Square root of (source 1 + source 2).	10
	sqrt(In1)+sqrt(In2)	Square root of source 1 + square root of source 2.	11
40.11	Set 1 feedback filter time	Defines the filter time constant for process feedback.	0.000 s
	0.000...30.000 s	Feedback filter time.	1 = 1 s
40.14	Set 1 setpoint scaling	Defines, together with parameter 40.15 Set 1 output scaling , a general scaling factor for the process PID control chain. If the parameter is set to zero, automatic setpoint scaling is activated, where suitable setpoint scale is calculated according to selected setpoint source. Actual setpoint scale is shown in parameter 40.61 Setpoint scaling actual . The scaling can be utilized when, for example, the process setpoint is input in Hz, and the output of the PID controller is used as an rpm value in speed control. In this case, this parameter might be set to 50, and parameter 40.15 to the nominal motor speed at 50 Hz. In effect, the output of the PID controller = [40.15] when deviation (setpoint - feedback) = [40.14] and [40.32] = 1. Note: The scaling is based on the ratio between 40.14 and 40.15 . For example, the values 50 and 1500 would produce the same scaling as 1 and 30.	0.00
	-200000.00... 200000.00	Process setpoint base.	1 = 1

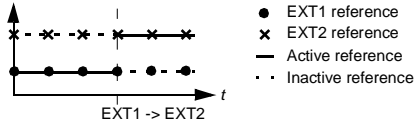
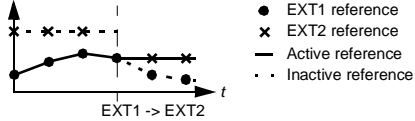
No.	Name/Value	Description	Def/FbEq16						
40.15	Set 1 output scaling	See parameter 40.14 Set 1 setpoint scaling . If the parameter is set to zero, scaling is automatic: <table border="1" data-bbox="348 236 840 339" style="margin: 10px auto;"> <thead> <tr> <th data-bbox="348 236 594 284">Operation mode (see par. 19.01)</th> <th data-bbox="594 236 840 284">Scaling</th> </tr> </thead> <tbody> <tr> <td data-bbox="348 284 594 311">Speed control</td> <td data-bbox="594 284 840 311">46.01 Speed scaling</td> </tr> <tr> <td data-bbox="348 311 594 339">Frequency control</td> <td data-bbox="594 311 840 339">46.02 Frequency scaling</td> </tr> </tbody> </table>	Operation mode (see par. 19.01)	Scaling	Speed control	46.01 Speed scaling	Frequency control	46.02 Frequency scaling	0.00
Operation mode (see par. 19.01)	Scaling								
Speed control	46.01 Speed scaling								
Frequency control	46.02 Frequency scaling								
	-200000.00... 200000.00	Process PID controller output base.	1 = 1						
40.16	Set 1 setpoint 1 source	Selects the primary source of process PID setpoint. See the control chain diagram on page 374 .	Internal setpoint						
	Not selected	None.	0						
	Reserved		1						
	Internal setpoint	Internal setpoint. See parameter 40.19 Set 1 internal setpoint sel1 .	2						
	AI1 scaled	12.12 AI1 scaled value (see page 400).	3						
	AI2 scaled	12.22 AI2 scaled value (see page 402).	4						
	Reserved		5...7						
	Motor potentiometer	22.80 Motor potentiometer ref act (output of the Floating point control (Motor potentiometer)).	8						
	Reserved		9						
	Freq in scaled	11.39 Freq in 1 scaled value (see page 394).	10						
	AI1 percent	12.101 AI1 percent value (see page 403)	11						
	AI2 percent	12.102 AI2 percent value (see page 403)	12						
	Control panel (ref saved)	Control panel reference (03.01 Panel reference , see page 364) saved by the control system for the location where the control returns is used as the reference. (Selection not available for parameter 71.16 Setpoint 1 source .) <p style="text-align: center;">Reference</p>  <ul style="list-style-type: none"> ● EXT1 reference × EXT2 reference — Active reference · · Inactive reference 	13						
	Control panel (ref copied)	Control panel reference (03.01 Panel reference , see page 364) for the previous control location is used as the reference when the control location changes if the references for the two locations are of the same type (eg frequency/speed/torque/PID); otherwise, the actual signal is used as the new reference. <p style="text-align: center;">Reference</p>  <ul style="list-style-type: none"> ● EXT1 reference × EXT2 reference — Active reference · · Inactive reference 	14						

No.	Name/Value	Description	Def/FbEq16
	FB A ref1	03.05 FB A reference 1 (see page 364).	15
	FB A ref2	03.06 FB A reference 2 (see page 364).	16
	Reserved		17...18
	EFB ref1	03.09 EFB reference 1 (see page 365).	19
	EFB ref2	03.10 EFB reference 2 (see page 365).	20
	Reserved		21...23
	Setpoint data storage	40.92 Setpoint data storage (see page 537). (Selection not available for parameter 71.16 Setpoint 1 source .)	24
	Compensated setpoint	40.70 Compensated setpoint (see page 534).	25
	Integrated panel (ref saved)		26
	Integrated panel (ref copied)		27
	AI3 scaled	15.52 AI3 scaled value (see page 507).	28
	AI4 scaled	15.62 AI4 scaled value (see page 509).	29
	AI5 scaled	15.72 AI5 scaled value (see page 511).	30
	AI3 percent	15.53 AI3 percent value (see page 507).	31
	AI4 percent	15.63 AI4 percent value (see page 509).	32
	AI5 percent	15.73 AI5 scaled value (see page 511).	33
	<i>Other</i>	Source selection (see Terms and abbreviations on page 358).	-
40.17	Set 1 setpoint 2 source	Selects the second source of process setpoint. The second source is used only if the setpoint function requires two inputs. For the available selections, see parameter 40.16 Set 1 setpoint 1 source .	<i>Not selected</i>
40.18	Set 1 setpoint function	Selects a function between the setpoint sources selected by parameters 40.16 Set 1 setpoint 1 source and 40.17 Set 1 setpoint 2 source . The result of the function (for any selection) is multiplied by parameter 40.89 Set 1 setpoint multiplier . (That is why in selections 12 and 13, the multiplier k is constant 1.)	<i>In1</i>
	In1	Source 1.	0
	In1+In2	Sum of sources 1 and 2.	1
	In1-In2	Source 2 subtracted from source 1.	2
	In1*In2	Source 1 multiplied by source 2.	3
	In1/In2	Source 1 divided by source 2.	4
	MIN(In1,In2)	Smaller of the two sources.	5
	MAX(In1,In2)	Greater of the two sources.	6
	AVE(In1,In2)	Average of the two sources.	7
	sqrt(In1)	Square root of source 1.	8
	sqrt(In1-In2)	Square root of (source 1 - source 2).	9
	sqrt(In1+In2)	Square root of (source 1 + source 2).	10
	sqrt(In1)+sqrt(In2)	Square root of source 1 + square root of source 2.	11

No.	Name/Value	Description	Def/FbEq16															
40.19	<i>Set 1 internal setpoint sel1</i>	Selects together with 40.20 Set 1 internal setpoint sel2 the internal setpoint out of the presets defined by parameters 40.21...40.24 . Note: Parameters 40.16 Set 1 setpoint 1 source and 40.17 Set 1 setpoint 2 source must be set to <i>Internal setpoint</i> .	<i>Not selected</i>															
		<table border="1"> <thead> <tr> <th>Source defined by par. 40.19</th> <th>Source defined by par. 40.20</th> <th>Setpoint preset active</th> </tr> </thead> <tbody> <tr> <td>0</td> <td>0</td> <td>0 (par. 40.24)</td> </tr> <tr> <td>1</td> <td>0</td> <td>1 (par. 40.21)</td> </tr> <tr> <td>0</td> <td>1</td> <td>2 (par. 40.22)</td> </tr> <tr> <td>1</td> <td>1</td> <td>3 (par. 40.23)</td> </tr> </tbody> </table>		Source defined by par. 40.19	Source defined by par. 40.20	Setpoint preset active	0	0	0 (par. 40.24)	1	0	1 (par. 40.21)	0	1	2 (par. 40.22)	1	1	3 (par. 40.23)
		Source defined by par. 40.19		Source defined by par. 40.20	Setpoint preset active													
		0		0	0 (par. 40.24)													
		1		0	1 (par. 40.21)													
0	1	2 (par. 40.22)																
1	1	3 (par. 40.23)																
Not selected	0.	0																
Selected	1.	1																
DI1	Digital input DI1 (10.02 DI delayed status , bit 0).	2																
DI2	Digital input DI2 (10.02 DI delayed status , bit 1).	3																
DI3	Digital input DI3 (10.02 DI delayed status , bit 2).	4																
DI4	Digital input DI4 (10.02 DI delayed status , bit 3).	5																
DI5	Digital input DI5 (10.02 DI delayed status , bit 4).	6																
DI6	Digital input DI6 (10.02 DI delayed status , bit 5).	7																
Reserved		8...17																
Timed function 1	Bit 0 of 34.01 Timed functions status (see page 496).	18																
Timed function 2	Bit 1 of 34.01 Timed functions status (see page 496).	19																
Timed function 3	Bit 2 of 34.01 Timed functions status (see page 496).	20																
Supervision 1	Bit 0 of 32.01 Supervision status (see page 485).	21																
Supervision 2	Bit 1 of 32.01 Supervision status (see page 485).	22																
Supervision 3	Bit 2 of 32.01 Supervision status (see page 485).	23																
<i>Other [bit]</i>	Source selection (see Terms and abbreviations on page 358).	-																
40.20	<i>Set 1 internal setpoint sel2</i>	Selects together with 40.19 Set 1 internal setpoint sel1 the internal setpoint used out of the three internal setpoints defined by parameters 40.21...40.23 . See table at 40.19 Set 1 internal setpoint sel1 .	<i>Not selected</i>															
		Not selected		0.	0													
		Selected		1.	1													
		DI1		Digital input DI1 (10.02 DI delayed status , bit 0).	2													
		DI2		Digital input DI2 (10.02 DI delayed status , bit 1).	3													
		DI3		Digital input DI3 (10.02 DI delayed status , bit 2).	4													
		DI4		Digital input DI4 (10.02 DI delayed status , bit 3).	5													
		DI5		Digital input DI5 (10.02 DI delayed status , bit 4).	6													
		DI6		Digital input DI6 (10.02 DI delayed status , bit 5).	7													
		Reserved			8...17													
		Timed function 1		Bit 0 of 34.01 Timed functions status (see page 496).	18													
		Timed function 2		Bit 1 of 34.01 Timed functions status (see page 496).	19													
		Timed function 3		Bit 2 of 34.01 Timed functions status (see page 496).	20													

No.	Name/Value	Description	Def/FbEq16
	Supervision 1	Bit 0 of 32.01 Supervision status (see page 485).	21
	Supervision 2	Bit 1 of 32.01 Supervision status (see page 485).	22
	Supervision 3	Bit 2 of 32.01 Supervision status (see page 485).	23
	<i>Other [bit]</i>	Source selection (see Terms and abbreviations on page 358).	-
40.21	Set 1 internal setpoint 1	Internal process setpoint 1. See parameter 40.19 Set 1 internal setpoint sel1 .	0.00 set 1 units
	-200000.00... 200000.00 set 1 units	Internal process setpoint 1.	1 = 1 set 1 unit
40.22	Set 1 internal setpoint 2	Internal process setpoint 2. See parameter 40.19 Set 1 internal setpoint sel1 .	0.00 set 1 units
	-200000.00... 200000.00 set 1 units	Internal process setpoint 2.	1 = 1 set 1 unit
40.23	Set 1 internal setpoint 3	Internal process setpoint 3. See parameter 40.19 Set 1 internal setpoint sel1 .	0.00 set 1 units
	-200000.00... 200000.00 set 1 units	Internal process setpoint 3.	1 = 1 set 1 unit
40.24	Set 1 internal setpoint 0	Internal process setpoint 0. See parameter 40.19 Set 1 internal setpoint sel1 .	0.00 set 1 units
	-200000.00... 200000.00 set 1 units	Internal process setpoint 0.	1 = 1 set 1 unit
40.26	Set 1 setpoint min	Defines a minimum limit for the process PID controller setpoint.	0.00 set 1 units
	-200000.00... 200000.00 set 1 units	Minimum limit for process PID controller setpoint.	1 = 1 set 1 unit
40.27	Set 1 setpoint max	Defines a maximum limit for the process PID controller setpoint.	200000.00 PID unit 1
	-200000.00... 200000.00 set 1 units	Maximum limit for process PID controller setpoint.	1 = 1 set 1 unit
40.28	Set 1 setpoint increase time	Defines the minimum time it takes for the setpoint to increase from 0% to 100%.	0.0 s
	0.0...1800.0 s	Setpoint increase time.	1 = 1 s
40.29	Set 1 setpoint decrease time	Defines the minimum time it takes for the setpoint to decrease from 100% to 0%.	0.0 s
	0.0...1800.0 s	Setpoint decrease time.	1 = 1 s
40.30	Set 1 setpoint freeze enable	Freezes, or defines a source that can be used to freeze, the setpoint of the process PID controller. This feature is useful when the reference is based on a process feedback connected to an analog input, and the sensor must be serviced without stopping the process. 1 = Process PID controller setpoint frozen See also parameter 40.38 Set 1 output freeze enable .	<i>Not selected</i>
	Not selected	Process PID controller setpoint not frozen.	0
	Selected	Process PID controller setpoint frozen.	1

No.	Name/Value	Description	Def/FbEq16
	DI1	Digital input DI1 (<i>10.02 DI delayed status</i> , bit 0).	2
	DI2	Digital input DI2 (<i>10.02 DI delayed status</i> , bit 1).	3
	DI3	Digital input DI3 (<i>10.02 DI delayed status</i> , bit 2).	4
	DI4	Digital input DI4 (<i>10.02 DI delayed status</i> , bit 3).	5
	DI5	Digital input DI5 (<i>10.02 DI delayed status</i> , bit 4).	6
	DI6	Digital input DI6 (<i>10.02 DI delayed status</i> , bit 5).	7
	Reserved		8...17
	Timed function 1	Bit 0 of <i>34.01 Timed functions status</i> (see page 496).	18
	Timed function 2	Bit 1 of <i>34.01 Timed functions status</i> (see page 496).	19
	Timed function 3	Bit 2 of <i>34.01 Timed functions status</i> (see page 496).	20
	Supervision 1	Bit 0 of <i>32.01 Supervision status</i> (see page 485).	21
	Supervision 2	Bit 1 of <i>32.01 Supervision status</i> (see page 485).	22
	Supervision 3	Bit 2 of <i>32.01 Supervision status</i> (see page 485).	23
	<i>Other [bit]</i>	Source selection (see <i>Terms and abbreviations</i> on page 358).	-
40.31	<i>Set 1 deviation inversion</i>	Inverts the input of the process PID controller. 0 = Deviation not inverted (Deviation = Setpoint - Feedback) 1 = Deviation inverted (Deviation = Feedback - Setpoint) See also section <i>Sleep and boost functions for process PID control</i> (page 167).	<i>Not inverted (Ref - Fbk)</i>
	Not inverted (Ref - Fbk)	0.	0
	Inverted (Fbk - Ref)	1.	1
	<i>Other [bit]</i>	Source selection (see <i>Terms and abbreviations</i> on page 358).	-
40.32	<i>Set 1 gain</i>	Defines the gain for the process PID controller. See parameter <i>40.33 Set 1 integration time</i> .	1.00
	0.01...100.00	Gain for PID controller.	100 = 1

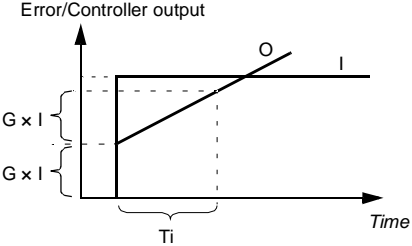
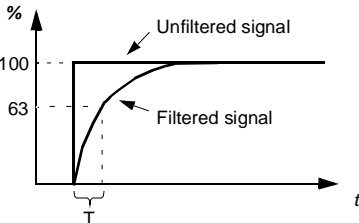
No.	Name/Value	Description	Def/FbEq16
40.33	<i>Set 1 integration time</i>	<p>Defines the integration time for the process PID controller. This time needs to be set to the same order of magnitude as the reaction time of the process being controlled, otherwise instability will result.</p>  <p>I = controller input (error) O = controller output G = gain Ti = integration time</p> <p>Note: Setting this value to 0 disables the "I" part, turning the PID controller into a PD controller.</p>	10.0 s
	0.0...9999.0 s	Integration time.	1 = 1 s
40.34	<i>Set 1 derivation time</i>	<p>Defines the derivation time of the process PID controller. The derivative component at the controller output is calculated on basis of two consecutive error values (E_{K-1} and E_K) according to the following formula: $PID\ DERIV\ TIME \times (E_K - E_{K-1}) / T_S$, in which $T_S = 2\ ms$ sample time $E = Error = Process\ reference - process\ feedback$.</p>	0.000 s
	0.000...10.000 s	Derivation time.	1000 = 1 s
40.35	<i>Set 1 derivation filter time</i>	<p>Defines the time constant of the 1-pole filter used to smooth the derivative component of the process PID controller.</p>  <p>$O = I \times (1 - e^{-t/T})$</p> <p>I = filter input (step) O = filter output t = time T = filter time constant</p>	0.0 s
	0.0...10.0 s	Filter time constant.	10 = 1 s

No.	Name/Value	Description	Def/FbEq16
40.36	<i>Set 1 output min</i>	Defines the minimum limit for the process PID controller output. Using the minimum and maximum limits, it is possible to restrict the operation range.	0.00
	-200000.00... 200000.00	Minimum limit for process PID controller output.	1 = 1
40.37	<i>Set 1 output max</i>	Defines the maximum limit for the process PID controller output. See parameter 40.36 Set 1 output min .	100.00
	-200000.00... 200000.00	Maximum limit for process PID controller output.	1 = 1
40.38	<i>Set 1 output freeze enable</i>	Freezes (or defines a source that can be used to freeze) the output of the process PID controller, keeping the output at the value it was before freeze was enabled. This feature can be used when, for example, a sensor providing process feedback must to be serviced without stopping the process. 1 = Process PID controller output frozen See also parameter 40.30 Set 1 setpoint freeze enable .	<i>Not selected</i>
	Not selected	Process PID controller output not frozen.	0
	Selected	Process PID controller output frozen.	1
	DI1	Digital input DI1 (10.02 DI delayed status , bit 0).	2
	DI2	Digital input DI2 (10.02 DI delayed status , bit 1).	3
	DI3	Digital input DI3 (10.02 DI delayed status , bit 2).	4
	DI4	Digital input DI4 (10.02 DI delayed status , bit 3).	5
	DI5	Digital input DI5 (10.02 DI delayed status , bit 4).	6
	DI6	Digital input DI6 (10.02 DI delayed status , bit 5).	7
	Reserved		8...17
	Timed function 1	Bit 0 of 34.01 Timed functions status (see page 496).	18
	Timed function 2	Bit 1 of 34.01 Timed functions status (see page 496).	19
	Timed function 3	Bit 2 of 34.01 Timed functions status (see page 496).	20
	Supervision 1	Bit 0 of 32.01 Supervision status (see page 485).	21
	Supervision 2	Bit 1 of 32.01 Supervision status (see page 485).	22
	Supervision 3	Bit 2 of 32.01 Supervision status (see page 485).	23
	<i>Other [bit]</i>	Source selection (see Terms and abbreviations on page 358).	-

No.	Name/Value	Description	Def/FbEq16
40.39	<i>Set 1 deadband range</i>	Defines a deadband around the setpoint. Whenever process feedback enters the deadband, a delay timer starts. If the feedback remains within the deadband longer than the delay (40.40 <i>Set 1 deadband delay</i>), the PID controller output is frozen. Normal operation resumes after the feedback value leaves the deadband.	0.00 set 1 unit
	0.00...200000.00 set 1 units	Deadband range.	1 = 1 set 1 unit
40.40	<i>Set 1 deadband delay</i>	Delay for the deadband. See parameter 40.39 <i>Set 1 deadband range</i> .	0.0 s
	0.0...3600.0 s	Delay for deadband area.	1 = 1 s
40.43	<i>Set 1 sleep level</i>	Defines the start limit for the sleep function. If the value is 0.0, set 1 sleep mode is disabled. The sleep function compares PID output (parameter 40.01 <i>Process PID output actual</i>) to the value of this parameter. If PID output remains below this value longer than the sleep delay defined by 40.44 <i>Set 1 sleep delay</i> , the drive enters the sleep mode and stops the motor.	0.0
	0.0...200000.0	Sleep start level.	1 = 1
40.44	<i>Set 1 sleep delay</i>	Defines a delay before the sleep function actually becomes enabled, to prevent nuisance sleeping. The delay timer starts when the sleep mode is enabled by parameter 40.43 <i>Set 1 sleep level</i> , and resets when the sleep mode is disabled.	60.0 s
	0.0...3600.0 s	Sleep start delay.	1 = 1 s
40.45	<i>Set 1 sleep boost time</i>	Defines a boost time for the sleep boost step. See parameter 40.46 <i>Set 1 sleep boost step</i> .	0.0 s
	0.0...3600.0 s	Sleep boost time.	1 = 1 s
40.46	<i>Set 1 sleep boost step</i>	When the drive is entering sleep mode, the process setpoint is increased by this value for the time defined by parameter 40.45 <i>Set 1 sleep boost time</i> . If active, sleep boost is aborted when the drive wakes up.	0.00 set 1 units
	0.00...200000.00 set 1 units	Sleep boost step.	1 = 1 set 1 unit

No.	Name/Value	Description	Def/FbEq16
40.47	<i>Set 1 wake-up deviation</i>	Defines the wake-up level as deviation between process setpoint and feedback. When the deviation exceeds the value of this parameter, and remains there for the duration of the wake-up delay (40.48 <i>Set 1 wake-up delay</i>), the drive wakes up. See also parameter 40.31 <i>Set 1 deviation inversion</i> .	0.00 set 1 unit
	-200000.00... 200000.00 set 1 units	Wake-up level (as deviation between process setpoint and feedback).	1 = 1 set 1 unit
40.48	<i>Set 1 wake-up delay</i>	Defines a wake-up delay for the sleep function to prevent nuisance wake-ups. See parameter 40.47 <i>Set 1 wake-up deviation</i> . The delay timer starts when the deviation exceeds the wake-up level (40.47 <i>Set 1 wake-up deviation</i>), and resets if the deviation falls below the wake-up level.	0.50 s
	0.00...60.00 s	Wake-up delay.	1 = 1 s
40.49	<i>Set 1 tracking mode</i>	Activates (or selects a source that activates) tracking mode. In tracking mode, the value selected by parameter 40.50 <i>Set 1 tracking ref selection</i> is substituted for the PID controller output. See also section <i>Tracking</i> (page 169). 1 = Tracking mode enabled	<i>Not selected</i>
	Not selected	0.	0
	Selected	1.	1
	DI1	Digital input DI1 (10.02 <i>DI delayed status</i> , bit 0).	2
	DI2	Digital input DI2 (10.02 <i>DI delayed status</i> , bit 1).	3
	DI3	Digital input DI3 (10.02 <i>DI delayed status</i> , bit 2).	4
	DI4	Digital input DI4 (10.02 <i>DI delayed status</i> , bit 3).	5
	DI5	Digital input DI5 (10.02 <i>DI delayed status</i> , bit 4).	6
	DI6	Digital input DI6 (10.02 <i>DI delayed status</i> , bit 5).	7
	Reserved		8...17
	Timed function 1	Bit 0 of 34.01 <i>Timed functions status</i> (see page 496).	18
	Timed function 2	Bit 1 of 34.01 <i>Timed functions status</i> (see page 496).	19
	Timed function 3	Bit 2 of 34.01 <i>Timed functions status</i> (see page 496).	20
	Supervision 1	Bit 0 of 32.01 <i>Supervision status</i> (see page 485).	21
	Supervision 2	Bit 1 of 32.01 <i>Supervision status</i> (see page 485).	22
	Supervision 3	Bit 2 of 32.01 <i>Supervision status</i> (see page 485).	23
	<i>Other [bit]</i>	Source selection (see <i>Terms and abbreviations</i> on page 358).	-
40.50	<i>Set 1 tracking ref selection</i>	Selects the value source for tracking mode. See parameter 40.49 <i>Set 1 tracking mode</i> .	<i>Not selected</i>
	Not selected	None.	0
	AI1 scaled	12.12 <i>AI1 scaled value</i> (see page 400).	1
	AI2 scaled	12.22 <i>AI2 scaled value</i> (see page 402).	2
	FB A ref1	03.05 <i>FB A reference 1</i> (see page 364).	3
	FB A ref2	03.06 <i>FB A reference 2</i> (see page 364).	4
	<i>Other</i>	Source selection (see <i>Terms and abbreviations</i> on page 358).	-

No.	Name/Value	Description	Def/FbEq16
40.57	<i>PID set1/set2 selection</i>	Selects the source that determines whether process PID parameter set 1 (parameters 40.07...40.50) or set 2 (group 41 Process PID set 2) is used.	<i>PID set 1</i>
	PID set 1	0. Process PID parameter set 1 in use.	0
	PID set 2	1. Process PID parameter set 2 in use.	1
	DI1	Digital input DI1 (10.02 DI delayed status, bit 0).	2
	DI2	Digital input DI2 (10.02 DI delayed status, bit 1).	3
	DI3	Digital input DI3 (10.02 DI delayed status, bit 2).	4
	DI4	Digital input DI4 (10.02 DI delayed status, bit 3).	5
	DI5	Digital input DI5 (10.02 DI delayed status, bit 4).	6
	DI6	Digital input DI6 (10.02 DI delayed status, bit 5).	7
	Reserved		8...17
	Timed function 1	Bit 0 of 34.01 Timed functions status (see page 496).	18
	Timed function 2	Bit 1 of 34.01 Timed functions status (see page 496).	19
	Timed function 3	Bit 2 of 34.01 Timed functions status (see page 496).	20
	Supervision 1	Bit 0 of 32.01 Supervision status (see page 485).	21
	Supervision 2	Bit 1 of 32.01 Supervision status (see page 485).	22
	Supervision 3	Bit 2 of 32.01 Supervision status (see page 485).	23
	<i>Other [bit]</i>	Source selection (see <i>Terms and abbreviations</i> on page 358).	-
40.58	<i>Set 1 increase prevention</i>	Activates increase prevention of PID integration term for PID set 1	<i>No</i>
	No	Increase prevention not in use.	0
	Limiting	The process PID integration term is not increased.	1
	<i>Other [bit]</i>	Source selection (see <i>Terms and abbreviations</i> on page 358).	-
40.59	<i>Set 1 decrease prevention</i>	Activates decrease prevention of PID integration term for PID set 1.	<i>No</i>
	No	Decrease prevention not in use.	0
	Limiting	The process PID integration term is not decreased.	1
	<i>Other [bit]</i>	Source selection (see <i>Terms and abbreviations</i> on page 358).	-
40.60	<i>Set 1 PID activation source</i>	Selects a source that enables/disables process PID control. See also parameter 40.07 Process PID operation mode. 0 = Process PID control disabled. 1 = Process PID control enabled.	<i>On</i>
	Off	0.	0
	On	1.	1
	Follow Ext1/Ext2 selection	Process PID control is disabled when external control location EXT1 is active, and enabled when external control location EXT2 is active. See also parameter 19.11 Ext1/Ext2 selection.	2
	DI1	Digital input DI1 (10.02 DI delayed status, bit 0).	3
	DI2	Digital input DI2 (10.02 DI delayed status, bit 1).	4
	DI3	Digital input DI3 (10.02 DI delayed status, bit 2).	5
	DI4	Digital input DI4 (10.02 DI delayed status, bit 3).	6
	DI5	Digital input DI5 (10.02 DI delayed status, bit 4).	7

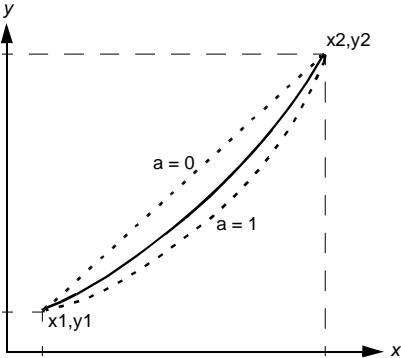
No.	Name/Value	Description	Def/FbEq16
	DI6	Digital input DI6 (<i>10.02 DI delayed status</i> , bit 5).	8
	<i>Other [bit]</i>	Source selection (see <i>Terms and abbreviations</i> on page 358).	-
40.61	<i>Setpoint scaling actual</i>	Actual setpoint scaling. See parameter <i>40.14 Set 1 setpoint scaling</i> .	100.00
	-200000.00... 200000.00	Scaling.	1 = 1
40.62	<i>PID internal setpoint actual</i>	Displays the value of the internal setpoint. See control chain diagram <i>PID setpoint compensation</i> on page 374. This parameter is read-only.	-
	-200000.00... 200000.00 set 1 units	Process PID internal setpoint.	1 = 1 set 1 unit
40.70	<i>Compensated setpoint</i>	<p>Compensated setpoint determined for the input specified by parameter <i>40.71 Set 1 compensation input source</i>.</p> <p>The determination of the compensated setpoint is based on the curve specified by points (x1, y1), (x2, y2) and the non-linearity of the curve specified with parameters <i>40.71...40.76</i>. The compensated setpoint curve will be a mixture of a straight line between the points and a squared line between the points:</p>  <p>x = value from <i>40.71 Set 1 compensation input source</i> y = <i>40.70 Compensated setpoint</i> a = <i>40.76 Set 1 compensation non-linearity</i> Compensated setpoint curve = $a * \text{squared function} + (1 - a) * \text{linear function}$</p>	-
	-21474836.48... 21474835.20 set 1 units	Compensated setpoint value.	1 = 1 set 1 unit
40.71	<i>Set 1 compensation input source</i>	Selects the source for set 1 compensation input.	<i>Not selected</i>
	Not selected	None.	0
	Reserved		1
	Internal setpoint	Internal setpoint. See parameter <i>40.19 Set 1 internal setpoint sel1</i> .	2

No.	Name/Value	Description	Def/FbEq16
	AI1 scaled	12.12 AI1 scaled value (see page 400).	3
	AI2 scaled	12.22 AI2 scaled value (see page 402).	4
	Reserved		5...7
	Motor potentiometer	22.80 Motor potentiometer ref act (output of the Floating point control (Motor potentiometer)).	8
	Reserved		9
	Freq in scaled	11.39 Freq in 1 scaled value (see page 394).	10
	AI1 percent	12.101 AI1 percent value (see page 403).	11
	AI2 percent	12.102 AI2 percent value (see page 403).	12
	Reserved		13...14
	FB A ref1	03.05 FB A reference 1 (see page 364).	15
	FB A ref2	03.06 FB A reference 2 (see page 364).	16
	Reserved		17...18
	EFB ref1	03.09 EFB reference 1 (see page 365).	19
	EFB ref2	03.10 EFB reference 2 (see page 365).	20
	Reserved		21...23
	Setpoint data storage	40.92 Setpoint data storage (see page 537).	24
	<i>Other</i>	Source selection (see Terms and abbreviations on page 358).	-
40.72	Set 1 compensation input 1	Point x1 on the setpoint compensation curve, see parameter 40.71 Compensated setpoint .	0.00
	-200000.00... 200000.00	Setpoint value.	1 = 1
40.73	Set 1 compensated output 1	Point y1 (= the compensated output of parameter 40.72 Set 1 compensation input 1) on the setpoint compensation curve, see parameter 40.70 Compensated setpoint .	0.00 set 1 units
	-200000.00... 200000.00 set 1 units	Compensated setpoint value.	1 = 1 set 1 unit
40.74	Set 1 compensation input 2	Point x2 on the setpoint compensation curve, see parameter 40.71 Compensated setpoint .	0.00
	-200000.00... 200000.00	Setpoint value.	1 = 1
40.75	Set 1 compensated output 2	Point y2 (= the compensated output of parameter 40.74 Set 1 compensation input 2) on the setpoint compensation curve, see parameter 40.70 Compensated setpoint .	0.00 set 1 units
	-200000.00... 200000.00 set 1 units	Compensated setpoint value.	1 = 1 set 1 unit
40.76	Set 1 compensation non-linearity	Describes the non-linearity of the setpoint compensation curve, see parameter 40.70 Compensated setpoint .	0%
	0...100%	Percentage.	1 = 1%
40.79	Set 1 units	Unit used for PID set 1.	User text
	User text	User editable text. User text default is "PID unit 1".	0

No.	Name/Value	Description	Def/FbEq16
	%	Percent.	4
	bar	Bar.	74
	kPa	Kilo pascal.	75
	Pa	Pascal.	77
	psi	Pound per square inch.	76
	CFM	Cubic feet per minute.	26
	inH ₂ O	Inch of water.	58
	°C	Degree Celsius.	150
	°F	Degree Fahrenheit.	151
	mbar	Millibar.	44
	m ³ /h	Cubic meter per hour.	78
	dm ³ /h	Cubic decimeter per hour.	21
	l/s	Liter per second.	79
	l/min	Liter per minute.	37
	l/h	Liter per hour.	38
	m ³ /s	Cubic meter per second.	88
	m ³ /min	Cubic meter per minute.	40
	km ³ /h	Cubic kilometer per minute.	131
	gal/s	Gallon per second.	47
	ft ³ /s	Cubic feet per second.	50
	ft ³ /min	Cubic feet per minute.	51
	ft ³ /h	Cubic feet per hour.	52
	ppm	Parts per million.	34
	inHg	Inch of mercury.	29
	kCFM	Cubic kilo feet per minute.	126
	inWC	Inch of water.	65
	gpm	Gallon per minute.	80
	gal/min	Gallon per minute.	48
	in wg	Inch water gauge.	59
	MPa	Megapascal.	94
	ftWC	Feet of water.	125
40.80	<i>Set 1 PID output min source</i>	Selects the source for set 1 PID output minimum.	<i>Set1 output min</i>
	None	Not selected.	0
	Set1 output min	40.36 Set 1 output min.	1
	<i>Other [bit]</i>	Source selection (see Terms and abbreviations on page 358).	-
40.81	<i>Set 1 PID output max source</i>	Selects the source for set 1 PID output maximum.	<i>Set1 output max</i>
	None	Not selected.	0
	Set1 output max	40.37 Set 1 output max.	1
	<i>Other [bit]</i>	Source selection (see Terms and abbreviations on page 358).	-

No.	Name/Value	Description	Def/FbEq16
40.89	<i>Set 1 setpoint multiplier</i>	Defines the multiplier with which the result of the function specified by parameter <i>40.18 Set 1 setpoint function</i> is multiplied.	1.00
	-200000.00... 200000.00	Multiplier.	1 = 1
40.90	<i>Set 1 feedback multiplier</i>	Defines the multiplier with which the result of the function specified by parameter <i>40.10 Set 1 feedback function</i> is multiplied.	1.00
	-200000.00... 200000.00	Multiplier.	1 = 1
40.91	<i>Feedback data storage</i>	Storage parameter for receiving a process feedback value, for example, through the embedded fieldbus interface. The value can be sent to the drive as Modbus I/O data. Set the target selection parameter of that particular data (<i>58.101...58.114</i>) to <i>Feedback data storage</i> . In <i>40.08 Set 1 feedback 1 source</i> (or <i>40.09 Set 1 feedback 2 source</i>), select <i>Feedback data storage</i> .	0.00
	-327.68...327.67	Storage parameter for process feedback.	100 = 1
40.92	<i>Setpoint data storage</i>	Storage parameter for receiving a process setpoint value, for example, through the embedded fieldbus interface. The value can be sent to the drive as Modbus I/O data. Set the target selection parameter of that particular data (<i>58.101...58.114</i>) to <i>Setpoint data storage</i> . In <i>40.16 Set 1 setpoint 1 source</i> (or <i>40.17 Set 1 setpoint 2 source</i>), select <i>Setpoint data storage</i> .	0.00
	-327.68...327.67	Storage parameter for process setpoint.	100 = 1
40.96	<i>Process PID output %</i>	Percentage scaled signal of parameter <i>40.01 Process PID feedback actual</i> .	0.00%
	-100.00...100.00%	Percentage.	100 = 1%
40.97	<i>Process PID feedback %</i>	Percentage scaled signal of parameter <i>40.02 Process PID feedback actual</i> .	0.00%
	-100.00...100.00%	Percentage.	100 = 1%
40.98	<i>Process PID setpoint %</i>	Percentage scaled signal of parameter <i>40.03 Process PID setpoint actual</i> .	0.00%
	-100.00...100.00%	Percentage.	100 = 1%
40.99	<i>Process PID deviation %</i>	Percentage scaled signal of parameter <i>40.04 Process PID deviation actual</i> .	0.00%
	-100.00...100.00%	Percentage.	100 = 1%
41 Process PID set 2		A second set of parameter values for process PID control. The selection between this set and first set (parameter group <i>40 Process PID set 1</i>) is made by parameter <i>40.57 PID set1/set2 selection</i> . See also parameters <i>40.01...40.06</i> , and control chain diagrams <i>PID setpoint compensation</i> and <i>Direction lock</i> on pages <i>374</i> and <i>379</i> , respectively.	
41.08	<i>Set 2 feedback 1 source</i>	See parameter <i>40.08 Set 1 feedback 1 source</i> .	<i>A12 percent</i>
41.09	<i>Set 2 feedback 2 source</i>	See parameter <i>40.09 Set 1 feedback 2 source</i> .	<i>Not selected</i>
41.10	<i>Set 2 feedback function</i>	See parameter <i>40.10 Set 1 feedback function</i> .	<i>In1</i>

No.	Name/Value	Description	Def/FbEq16
41.11	Set 2 feedback filter time	See parameter 40.11 Set 1 feedback filter time .	0.000 s
41.14	Set 2 setpoint scaling	See parameter 40.14 Set 1 setpoint scaling .	0.00
41.15	Set 2 output scaling	See parameter 40.15 Set 1 output scaling .	0.00
41.16	Set 2 setpoint 1 source	See parameter 40.16 Set 1 setpoint 1 source .	Internal setpoint
41.17	Set 2 setpoint 2 source	See parameter 40.17 Set 1 setpoint 2 source .	Not selected
41.18	Set 2 setpoint function	See parameter 40.18 Set 1 setpoint function .	In1
41.19	Set 2 internal setpoint sel1	See parameter 40.19 Set 1 internal setpoint sel1 .	Not selected
41.20	Set 2 internal setpoint sel2	See parameter 40.20 Set 1 internal setpoint sel2 .	Not selected
41.21	Set 2 internal setpoint 1	See parameter 40.21 Set 1 internal setpoint 1 .	0.00 set 2 units
41.22	Set 2 internal setpoint 2	See parameter 40.22 Set 1 internal setpoint 2 .	0.00 set 2 units
41.23	Set 2 internal setpoint 3	See parameter 40.23 Set 1 internal setpoint 3 .	0.00 set 2 units
41.24	Set 2 internal setpoint 0	See parameter 40.24 Set 1 internal setpoint 0 .	0.00 set 2 units
41.26	Set 2 setpoint min	See parameter 40.26 Set 1 setpoint min .	0.00 set 2 units
41.27	Set 2 setpoint max	See parameter 40.27 Set 1 setpoint max .	200000.00 set 2 units
41.28	Set 2 setpoint increase time	See parameter 40.28 Set 1 setpoint increase time .	0.0 s
41.29	Set 2 setpoint decrease time	See parameter 40.29 Set 1 setpoint decrease time .	0.0 s
41.30	Set 2 setpoint freeze enable	See parameter 40.30 Set 1 setpoint freeze enable .	Not selected
41.31	Set 2 deviation inversion	See parameter 40.31 Set 1 deviation inversion .	Not inverted (Ref - Fbk)
41.32	Set 2 gain	See parameter 40.32 Set 1 gain .	1.00
41.33	Set 2 integration time	See parameter 40.33 Set 1 integration time .	60.0 s
41.34	Set 2 derivation time	See parameter 40.34 Set 1 derivation time .	0.000 s
41.35	Set 2 derivation filter time	See parameter 40.35 Set 1 derivation filter time .	0.0 s
41.36	Set 2 output min	See parameter 40.36 Set 1 output min .	0.00
41.37	Set 2 output max	See parameter 40.37 Set 1 output max .	100.00
41.38	Set 2 output freeze enable	See parameter 40.38 Set 1 output freeze enable .	Not selected

No.	Name/Value	Description	Def/FbEq16
41.39	<i>Set 2 deadband range</i>	See parameter <i>40.39 Set 1 deadband range</i> .	0.00 set 2 units
41.40	<i>Set 2 deadband delay</i>	See parameter <i>40.40 Set 1 deadband delay</i> .	0.0 s
41.43	<i>Set 2 sleep level</i>	See parameter <i>40.43 Set 1 sleep level</i> .	0.0
41.44	<i>Set 2 sleep delay</i>	See parameter <i>40.44 Set 1 sleep delay</i> .	60.0 s
41.45	<i>Set 2 sleep boost time</i>	See parameter <i>40.45 Set 1 sleep boost time</i> .	0.0 s
41.46	<i>Set 2 sleep boost step</i>	See parameter <i>40.46 Set 1 sleep boost step</i> .	0.00 set 2 units
41.47	<i>Set 2 wake-up deviation</i>	See parameter <i>40.47 Set 1 wake-up deviation</i> .	0.00 set 2 units
41.48	<i>Set 2 wake-up delay</i>	See parameter <i>40.48 Set 1 wake-up delay</i> .	0.50 s
41.49	<i>Set 2 tracking mode</i>	See parameter <i>40.49 Set 1 tracking mode</i> .	<i>Not selected</i>
41.50	<i>Set 2 tracking ref selection</i>	See parameter <i>40.50 Set 1 tracking ref selection</i> .	<i>Not selected</i>
41.58	<i>Set 2 increase prevention</i>	See parameter <i>40.58 Set 1 increase prevention</i> .	<i>No</i>
41.59	<i>Set 2 decrease prevention</i>	See parameter <i>40.59 Set 1 decrease prevention</i> .	<i>No</i>
41.60	<i>Set 2 PID activation source</i>	See parameter <i>40.60 Set 1 PID activation source</i> .	<i>On</i>
41.71	<i>Set 2 compensation input source</i>	See parameter <i>40.71 Set 1 compensation input source</i> .	<i>Not selected</i>
41.72	<i>Set 2 compensation input 1</i>	See parameter <i>40.72 Set 1 compensation input 1</i> .	0.00
41.73	<i>Set 2 compensated output 1</i>	See parameter <i>40.73 Set 1 compensated output 1</i> .	0.00 set 2 units
41.74	<i>Set 2 compensation input 2</i>	See parameter <i>40.74 Set 1 compensation input 2</i> .	0.00
41.75	<i>Set 2 compensated output 2</i>	See parameter <i>40.75 Set 1 compensated output 2</i> .	0.00 set 2 units
41.76	<i>Set 2 compensation non-linearity</i>	See parameter <i>40.76 Set 1 compensation non-linearity</i> .	0%
41.79	<i>Set 2 units</i>	See parameter <i>40.79 Set 1 units</i> .	<i>bar</i>
41.80	<i>Set 2 PID output min source</i>	Selects the source for set 2 PID output minimum.	<i>Set2 output min</i>
	None	None.	0
	Set2 output min	<i>41.36 Set 2 output min</i> .	1
	<i>Other [bit]</i>	Source selection (see <i>Terms and abbreviations</i> on page 358).	-
41.81	<i>Set 2 PID output max source</i>	Selects the source for set 2 PID output maximum.	<i>Set2 output max</i>
	None	None.	0

No.	Name/Value	Description	Def/FbEq16
	Set2 output max	41.37 Set 2 output max.	1
	<i>Other [bit]</i>	Source selection (see Terms and abbreviations on page 358).	-
41.89	<i>Set 2 setpoint multiplier</i>	See parameter 40.89 Set 1 setpoint multiplier .	1.00
41.90	<i>Set 2 feedback multiplier</i>	Defines the multiplier k used in formulas of parameter 41.10 Set 2 feedback function . See parameter 40.90 Set 1 feedback multiplier .	1.00
43 Brake chopper			
		Settings for the internal brake chopper. Note: These parameters apply to internal brake chopper only. When using external brake, you must disable brake chopper function by setting parameter 43.06 Brake chopper function to value Disabled .	
43.01	<i>Braking resistor temperature</i>	Displays the estimated temperature of the brake resistor, or how close the brake resistor is to being too hot. The value is given in percent where 100% is the eventual temperature the resistor would reach when loaded long enough with its rated maximum load capacity (43.09 Brake resistor Pmax cont). The temperature calculation is based on the values of parameters 43.08 , 43.09 and 43.10 , and on the assumption that the resistor is installed as instructed by the manufacturer (ie it cools down as expected). This parameter is read-only.	-
	0.0...120.0%	Estimated brake resistor temperature.	1 = 1%
43.06	<i>Brake chopper function</i>	Enables brake chopper control and selects the brake resistor overload protection method (calculation or measurement). Note: Before enabling brake chopper control, ensure that <ul style="list-style-type: none"> a brake resistor is connected overvoltage control is switched off (parameter 30.30 Overvoltage control) the supply voltage range (parameter 95.01 Supply voltage) has been selected correctly. Note: When using external brake chopper, set this parameter to value Disabled .	Disabled
	Disabled	Brake chopper control disabled.	0
	Enabled with thermal model	Brake chopper control enabled with brake resistor protection based on the thermal model. If you select this, you must also specify the values needed by the model, ie, parameters 43.08 ... 43.12 . See the resistor data sheet.	1
	Enabled without thermal model	Brake chopper control enabled without resistor overload protection based on the thermal model. This setting can be used, for example, if the resistor is equipped with a thermal switch that is wired to open the main contactor of the drive if the resistor overheats. For more information, see chapter <i>Resistor braking</i> in the <i>Hardware manual</i> of the drive.	2

No.	Name/Value	Description	Def/FbEq16
	Overvoltage peak protection	Brake chopper control enabled in an overvoltage condition. This setting is intended for situations where <ul style="list-style-type: none"> the braking chopper is not needed for runtime operation, ie, to dissipate the inertial energy of the motor, the motor is able to store a considerable amount magnetic energy in its windings, and the motor might, deliberately or inadvertently, be stopped by coasting. In such a situation, the motor would potentially discharge enough magnetic energy towards the drive to cause damage. To protect the drive, the brake chopper can be used with a small resistor dimensioned merely to handle the magnetic energy (not the inertial energy) of the motor. With this setting, the brake chopper is activated only whenever the DC voltage exceeds the overvoltage limit. During normal use, the brake chopper is not operating.	3
43.07	<i>Brake chopper run enable</i>	Selects the source for quick brake chopper on/off control. 0 = Brake chopper IGBT pulses are cut off 1 = Normal brake chopper IGBT modulation allowed.	On
	Off	0.	0
	On	1.	1
	<i>Other [bit]</i>	Source selection (see Terms and abbreviations on page 358).	-
43.08	<i>Brake resistor thermal tc</i>	Defines the thermal time constant for the brake resistor thermal model.	0 s
	0...10000 s	Brake resistor thermal time constant, ie, the rated time to achieve 63% temperature.	1 = 1 s
43.09	<i>Brake resistor Pmax cont</i>	Defines the maximum continuous load of the brake resistor that will eventually raise the resistor temperature to the maximum allowed value (= continuous heat dissipation capacity of the resistor in kW) but not above it. The value is used in the resistor overload protection based on the thermal model. See parameter 43.06 Brake chopper function and the data sheet of the brake resistor used.	0.00 kW
	0.00...10000.00 kW	Maximum continuous load of the brake resistor.	1000 = 1 kW
43.10	<i>Brake resistance</i>	Defines the resistance value of the brake resistor. The value is used for the brake resistor protection based on the thermal model. See parameter 43.06 Brake chopper function .	0.0 ohm
	0.0...1000.0 ohm	Brake resistor resistance value.	1000 = 1 ohm
43.11	<i>Brake resistor fault limit</i>	Defines the fault limit for the brake resistor protection based on the thermal model. See parameter 43.06 Brake chopper function . When the limit is exceeded, the drive trips on fault 7183 BR excess temperature . The value is given in percent of the temperature the resistor reaches when loaded with the power defined by parameter 43.09 Brake resistor Pmax cont .	105%
	0...150%	Brake resistor temperature fault limit.	100= 1%

No.	Name/Value	Description	Def/FbEq16
43.12	<i>Brake resistor warning limit</i>	Defines the warning limit for the brake resistor protection based on the thermal model. See parameter 43.06 Brake chopper function . When the limit is exceeded, the drive generates warning A793 BR excess temperature . The value is given in percent of the temperature the resistor reaches when loaded with the power defined by parameter 43.09 Brake resistor Pmax cont .	95%
	0...150%	Brake resistor temperature warning limit.	100 = 1%
45 Energy efficiency		Settings for the energy saving calculators as well as peak and energy loggers. See also section Diagnostics menu (page 230).	
45.01	<i>Saved GW hours</i>	Energy saved in GWh compared to direct-on-line motor connection. This parameter is incremented when 45.02 Saved MW hours rolls over. This parameter is read-only (see parameter 45.21 Energy calculations reset).	-
	0...65535 GWh	Energy savings in GWh.	1 = 1 GWh
45.02	<i>Saved MW hours</i>	Energy saved in MWh compared to direct-on-line motor connection. This parameter is incremented when 45.03 Saved kW hours rolls over. When this parameter rolls over, parameter 45.01 Saved GW hours is incremented. This parameter is read-only (see parameter 45.21 Energy calculations reset).	-
	0...999 MWh	Energy savings in MWh.	1 = 1 MWh
45.03	<i>Saved kW hours</i>	Energy saved in kWh compared to direct-on-line motor connection. If the internal brake chopper of the drive is enabled, all energy fed by the motor to the drive is assumed to be converted into heat, but the calculation still records savings made by controlling the speed. If the chopper is disabled, then regenerated energy from the motor is also recorded here. When this parameter rolls over, parameter 45.02 Saved MW hours is incremented. This parameter is read-only (see parameter 45.21 Energy calculations reset).	-
	0.0...999.9 kWh	Energy savings in kWh.	10 = 1 kWh
45.04	<i>Saved energy</i>	Energy saved in kWh compared to direct-on-line motor connection. If the internal brake chopper of the drive is enabled, all energy fed by the motor to the drive is assumed to be converted into heat. This parameter is read-only (see parameter 45.21 Energy calculations reset).	-
	0.0...214748368.0 kWh	Energy savings in kWh.	1 = 1 kWh

No.	Name/Value	Description	Def/FbEq16
45.05	<i>Saved money x1000</i>	Monetary savings in thousands compared to direct-on-line motor connection. This parameter is incremented when 45.06 Saved money rolls over. If you have not set the currency during the first start-up, you can specify it in Main menu > Primary settings > Clock, region display > Units > Currency . This parameter is read-only (see parameter 45.21 Energy calculations reset).	-
	0...4294967295 thousands (unit x 1000)	Monetary savings in thousands of units.	
45.06	<i>Saved money</i>	Monetary savings compared to direct-on-line motor connection. This value is a calculated by multiplying the saved energy in kWh by the currently active energy tariff (45.14 Tariff selection). When this parameter rolls over, parameter 45.05 Saved money x1000 is incremented. If you have not set the currency during the first start-up, you can specify it in Main menu > Primary settings > Clock, region display > Units > Currency . This parameter is read-only (see parameter 45.21 Energy calculations reset).	-
	0.00...999.99 units	Monetary savings.	1 = 1 unit
45.07	<i>Saved amount</i>	Monetary savings compared to direct-on-line motor connection. This value is a calculated by multiplying the saved energy in kWh by the currently active energy tariff (45.14 Tariff selection). If you have not set the currency during the first start-up, you can specify it in Main menu > Primary settings > Clock, region display > Units > Currency . This parameter is read-only (see parameter 45.21 Energy calculations reset).	-
	0.00... 21474830.0 units	Monetary savings.	1 = 1 unit
45.08	<i>CO2 reduction in kilotons</i>	Reduction in CO ₂ emissions in metric kilotons compared to direct-on-line motor connection. This value is incremented when parameter 45.09 CO2 reduction in tons rolls over. This parameter is read-only (see parameter 45.21 Energy calculations reset).	-
	0...65535 metric kilotons	Reduction in CO ₂ emissions in metric kilotons.	1 = 1 metric kiloton
45.09	<i>CO2 reduction in tons</i>	Reduction in CO ₂ emissions in metric tons compared to direct-on-line motor connection. This value is calculated by multiplying the saved energy in MWh by the value of parameter 45.18 CO2 conversion factor (by default, 0.5 metric tons/MWh). When this parameter rolls over, parameter 45.08 CO2 reduction in kilotons is incremented. This parameter is read-only (see parameter 45.21 Energy calculations reset).	-
	0.0...999.9 metric tons	Reduction in CO ₂ emissions in metric tons.	1 = 1 metric ton

No.	Name/Value	Description	Def/FbEq16
45.10	<i>Total saved CO2</i>	Reduction in CO ₂ emissions in metric tons compared to direct-on-line motor connection. This value is calculated by multiplying the saved energy in MWh by the value of parameter 45.18 CO2 conversion factor (by default, 0.5 metric tons/MWh). This parameter is read-only (see parameter 45.21 Energy calculations reset).	-
	0.0...214748304.0 metric tons	Reduction in CO ₂ emissions in metric tons.	1 = 1 metric ton
45.11	<i>Energy optimizer</i>	Enables/disables the energy optimization function. The function optimizes the motor flux so that total energy consumption and motor noise level are reduced when the drive operates below the nominal load. The total efficiency (motor and drive) can be improved by 1...20% depending on load torque and speed. Note: With a permanent magnet motor and a synchronous reluctance motor, energy optimization is always enabled regardless of this parameter.	<i>Enable</i>
	Disable	Energy optimization disabled.	0
	Enable	Energy optimization enabled.	1
45.12	<i>Energy tariff 1</i>	Defines energy tariff 1 (price of energy per kWh). Depending on the setting of parameter 45.14 Tariff selection , either this value or 45.13 Energy tariff 2 is used for reference when monetary savings are calculated. If you have not set the currency during the first start-up, you can specify it in Main menu > Primary settings > Clock, region display > Units > Currency . Note: Tariffs are read only at the instant of selection, and are not applied retroactively.	0.100 units
	0.000... 4294966.296 units	Energy tariff 1.	
45.13	<i>Energy tariff 2</i>	Defines energy tariff 2 (price of energy per kWh). See parameter 45.12 Energy tariff 1 .	0.200 units
	0.000... 4294966.296 units	Energy tariff 2.	
45.14	<i>Tariff selection</i>	Selects (or defines a source that selects) which pre-defined energy tariff is used. 0 = 45.12 Energy tariff 1 . 1 = 45.13 Energy tariff 2 .	<i>Energy tariff 1</i>
	Energy tariff 1	0.	0
	Energy tariff 2	1.	1
	DI1	Digital input DI1 (10.02 DI delayed status , bit 0).	2
	DI2	Digital input DI2 (10.02 DI delayed status , bit 1).	3
	DI3	Digital input DI3 (10.02 DI delayed status , bit 2).	4
	DI4	Digital input DI4 (10.02 DI delayed status , bit 3).	5
	DI5	Digital input DI5 (10.02 DI delayed status , bit 4).	6
	DI6	Digital input DI6 (10.02 DI delayed status , bit 5).	7
	<i>Other [bit]</i>	Source selection (see Terms and abbreviations on page 358).	-

No.	Name/Value	Description	Def/FbEq16
45.18	<i>CO2 conversion factor</i>	Defines a factor for conversion of saved energy into CO ₂ emissions (kg/kWh or tn/MWh).	0.500 tn/MWh (metric ton)
	0.000...65.535 tn/MWh	Factor for conversion of saved energy into CO ₂ emissions.	1 = 1 tn/MWh
45.19	<i>Comparison power</i>	Actual power that the motor absorbs when connected direct-on-line and operating the application. The value is used for reference when energy savings are calculated. Note: The accuracy of the energy savings calculation is directly dependent on the accuracy of this value. If nothing is entered here, then the nominal motor power is used by the calculation, but that may inflate the energy savings reported as many motors do not absorb nameplate power.	0.75 kW
	0.00...10000000.0 0 kW	Motor power.	1 = 1 kW
45.21	<i>Energy calculations reset</i>	Resets the savings counter parameters 45.01...45.10.	<i>Done</i>
	Done	Reset not requested (normal operation), or reset complete.	0
	Reset	Reset the savings counter parameters. The value reverts automatically to <i>Done</i> .	1
45.24	<i>Hourly peak power value</i>	Value of the peak power during the last hour, that is, the most recent 60 minutes after the drive has been powered up. The parameter is updated once every 10 minutes unless the hourly peak is found in the most recent 10 minutes. In that case, the values is shown immediately.	0.00 kW
	-3000.00... 3000.00 kW	Peak power value.	10 = 1 kW
45.25	<i>Hourly peak power time</i>	Time of the peak power value during the last hour.	00:00:00
		Time.	-
45.26	<i>Hourly total energy (resettable)</i>	Total energy consumption during the last hour, that is, the most recent 60 minutes. You can reset the value by setting it to zero.	0.00 kWh
	-3000.00... 3000.00 kWh	Total energy.	10 = 1 kWh
45.27	<i>Daily peak power value (resettable)</i>	Value of the peak power since midnight of the present day. You can reset the value by setting it to zero.	0.00 kW
	-3000.00... 3000.00 kW	Peak power value.	10 = 1 kW
45.28	<i>Daily peak power time</i>	Time of the peak power since midnight of the present day.	00:00:00
		Time.	-
45.29	<i>Daily total energy (resettable)</i>	Total energy consumption since midnight of the present day. You can reset the value by setting it to zero.	0.00 kWh
	-30000.00... 30000.00 kWh	Total energy.	1 = 1 kWh
45.30	<i>Last day total energy</i>	Total energy consumption during the previous day, that is, between midnight of the previous day and midnight of the present day	0.00 kWh
	-30000.00... 30000.00 kWh	Total energy.	1 = 1 kWh

No.	Name/Value	Description	Def/FbEq16
45.31	<i>Monthly peak power value (resettable)</i>	Value of the peak power during the present month, that is, since midnight of the first day of the present month. You can reset the value by setting it to zero.	0.00 kW
	-30000.00... 30000.00 kWh	Peak power value.	10 = 1 kW
45.32	<i>Monthly peak power date</i>	Date of the peak power during the present month.	1.1.1980
		Date.	-
45.33	<i>Monthly peak power time</i>	Time of the peak power during the present month.	00:00:00
		Time.	-
45.34	<i>Monthly total energy (resettable)</i>	Total energy consumption from the beginning of the present month. You can reset the value by setting it to zero.	0.00 kWh
	-1000000.00... 1000000.00 kWh	Total energy.	1 = 100 kWh
45.35	<i>Last month total energy</i>	Total energy consumption during the previous month, that is, between midnight of the first day or the previous month and midnight of the first day of the present month.	0.00 kWh
	-1000000.00... 1000000.00 kWh		1 = 100 kWh
45.36	<i>Lifetime peak power value</i>	Value of the peak power over the drive lifetime.	0.00 kW
	-3000.00... 3000.00 kW	Peak power value.	10 = 1 kW
45.37	<i>Lifetime peak power date</i>	Date of the peak power over the drive lifetime.	1.1.1980
		Date.	-
45.38	<i>Lifetime peak power time</i>	Time of the peak power over the drive lifetime.	00:00:00
		Time.	-
46 Monitoring/scaling settings		Speed supervision settings; actual signal filtering; general scaling settings.	
46.01	<i>Speed scaling</i>	Defines the maximum speed value used to define the acceleration ramp rate and the initial speed value used to define the deceleration ramp rate (see parameter group 23 Speed reference ramp). The speed acceleration and deceleration ramp times are therefore related to this value (not to parameter 30.12 Maximum speed). Also defines the 16-bit scaling of speed-related parameters. The value of this parameter corresponds to 20000, for example, in fieldbus communication.	1500.00 rpm; 1800.00 rpm (95.20 b0)
	0.10...30000.00 rpm	Acceleration/deceleration terminal/initial speed.	1 = 1 rpm

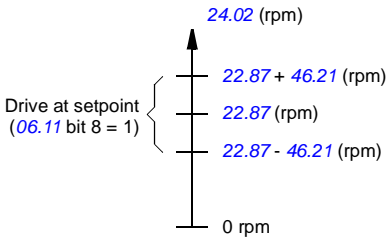
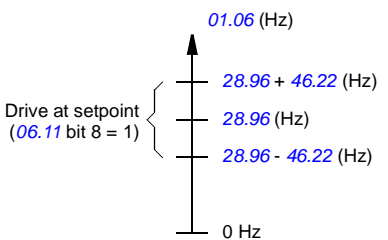

No.	Name/Value	Description	Def/FbEq16
46.02	<i>Frequency scaling</i>	Defines the maximum frequency value used to define the acceleration ramp rate and the initial frequency value used to define deceleration ramp rate (see parameter group 28 Frequency reference chain). The frequency acceleration and deceleration ramp times are therefore related to this value (not to parameter 30.14 Maximum frequency). Also defines the 16-bit scaling of frequency-related parameters. The value of this parameter corresponds to 20000, for example, in fieldbus communication.	50.00 Hz; 60.00 Hz (95.20 b0)
	0.10...1000.00 Hz	Acceleration/deceleration terminal/initial frequency.	10 = 1 Hz
46.03	<i>Torque scaling</i>	Defines the 16-bit scaling of torque parameters. The value of this parameter (in percent of nominal motor torque) corresponds to 10000, for example, in fieldbus communication.	100.0%
	0.1...1000.0%	Torque corresponding to 10000 on fieldbus.	10 = 1%
46.04	<i>Power scaling</i>	Defines the 16-bit scaling of power parameters. The value of this parameter corresponds to 10000, for example, in fieldbus communication. The unit is selected by parameter 96.16 Unit selection . For 32-bit scaling see parameter 46.43 Power decimals .	1000.00 unit
	0.10...30000.00 kW or 0.10...40214.48 hp	Power corresponding to 10000 on fieldbus.	1 = 1 unit
46.05	<i>Current scaling</i>	Defines the 16-bit scaling of current parameters. The value of this parameter corresponds to 10000, for example, in fieldbus communication. For 32-bit scaling see parameter 46.44 Current decimals .	10000 A
	0...30000 A	Current corresponding to 10000 on fieldbus.	1 = 1 A
46.06	<i>Speed ref zero scaling</i>	Defines a speed corresponding to a zero reference received from fieldbus (either the embedded fieldbus interface, or interface FBA A). For example, with a setting of 500, the fieldbus reference range of 0...20000 would correspond to a speed of 500... [46.01] rpm. Note: This parameter is effective only with the ABB Drives communication profile.	0.00 rpm
	0.00...30000.00 rpm	Speed corresponding to minimum fieldbus reference.	1 = 1 rpm
46.07	<i>Frequency ref zero scaling</i>	Defines a frequency corresponding to a zero reference received from fieldbus (either the embedded fieldbus interface, or interface FBA). For example, with a setting of 30, the fieldbus reference range of 0...20000 would correspond to a speed of 30... [46.02] Hz. Note: This parameter is effective only with the ABB Drives communication profile.	0.00 Hz
	0.00...1000.00 Hz	Frequency corresponding to minimum fieldbus reference.	10 = 1 Hz
46.11	<i>Filter time motor speed</i>	Defines a filter time for signals 01.01 Motor speed used and 01.02 Motor speed estimated .	500 ms
	2...20000 ms	Motor speed signal filter time.	1 = 1 ms
46.12	<i>Filter time output frequency</i>	Defines a filter time for signal 01.06 Output frequency .	500 ms
	2...20000 ms	Output frequency signal filter time.	1 = 1 ms



No.	Name/Value	Description	Def/FbEq16
46.13	<i>Filter time motor torque</i>	Defines a filter time for signal <i>01.10 Motor torque</i> .	100 ms
	2...20000 ms	Motor torque signal filter time.	1 = 1 ms
46.14	<i>Filter time power</i>	Defines a filter time for signal <i>01.14 Output power</i> .	100 ms
	2...20000 ms	Output power signal filter time.	1 = 1 ms
46.21	<i>At speed hysteresis</i>	<p>Defines the “at setpoint” limits for speed control of the drive. When the difference between reference (<i>22.87 Speed reference act 7</i>) and the speed (<i>24.02 Used speed feedback</i>) is smaller than <i>46.21 At speed hysteresis</i>, the drive is considered to be “at setpoint”. This is indicated by bit 8 of <i>06.11 Main status word</i>.</p> 	50.00 rpm
	0.00...30000.00 rpm	Limit for “at setpoint” indication in speed control.	See par. <i>46.01</i>
46.22	<i>At frequency hysteresis</i>	<p>Defines the “at setpoint” limits for frequency control of the drive. When the absolute difference between reference (<i>28.96 Frequency ref ramp input</i>) and actual frequency (<i>01.06 Output frequency</i>) is smaller than <i>46.22 At frequency hysteresis</i>, the drive is considered to be “at setpoint”. This is indicated by bit 8 of <i>06.11 Main status word</i>.</p> 	2.00 Hz
	0.00...1000.00 Hz	Limit for “at setpoint” indication in frequency control.	See par. <i>46.02</i>
46.31	<i>Above speed limit</i>	<p>Defines the trigger level for “above limit” indication in speed control. When actual speed exceeds the limit, bit 10 of <i>06.17 Drive status word 2</i> is set. Additionally, as default, bit 10 in <i>06.11 Main status word</i> is set.</p>	1500.00 rpm; 1800.00 rpm (95.20 b0)
	0.00...30000.00 rpm	“Above limit” indication trigger level for speed control.	See par. <i>46.01</i>

No.	Name/Value	Description	Def/FbEq16
46.32	<i>Above frequency limit</i>	Defines the trigger level for "above limit" indication in frequency control. When actual frequency exceeds the limit, bit 10 of 06.17 Drive status word 2 is set. Additionally, as default, bit 10 in 06.11 Main status word is set.	50.00 Hz; 60.00 Hz (95.20 b0)
	0.00...1000.00 Hz	"Above limit" indication trigger level for frequency control.	See par. 46.02
46.41	<i>kWh pulse scaling</i>	Defines the trigger level for the "kWh pulse" on for 50 ms. The output of the pulse is bit 9 of 05.22 Diagnostic word 3 .	1.000 kWh
	0.001... 1000.000 kWh	"kWh pulse" on trigger level.	1 = 1 kWh
46.43	<i>Power decimals</i>	Defines the number of decimals shown for parameter 99.10 Motor nominal power on the control panel and Drive composer PC tool. It also defines 32-bit scaling of power parameters. The value of this parameter corresponds to the number of decimals assumed in the 32-bit integer fieldbus communication. For 16-bit scaling, see parameter 46.04 Power scaling .	2
	0...3	Number of decimals.	1 = 1
46.44	<i>Current decimals</i>	Defines the number of decimals shown for parameter 99.06 Motor nominal current on the control panel and Drive composer PC tool. It also defines 32-bit scaling of current parameters. The value of this parameter corresponds to the number of decimals assumed in the 32-bit integer fieldbus communication. For 16-bit scaling, see parameter 46.05 Current scaling .	2
	0...3	Number of decimals.	1 = 1

47 Data storage		Data storage parameters that can be written to and read from using other parameters' source and target settings. Note that there are different storage parameters for different data types. See also section Data storage parameters (page 232).	
47.01	<i>Data storage 1 real32</i>	Data storage parameter 1.	0.000
	-2147483.000... 2147483.000	32-bit data.	
47.02	<i>Data storage 2 real32</i>	Data storage parameter 2.	0.000
	-2147483.000... 2147483.000	32-bit data.	
47.03	<i>Data storage 3 real32</i>	Data storage parameter 3.	0.000
	-2147483.000... 2147483.000	32-bit data.	
47.04	<i>Data storage 4 real32</i>	Data storage parameter 4.	0.000
	-2147483.000... 2147483.000	32-bit data.	

No.	Name/Value	Description	Def/FbEq16
47.05	<i>Data storage 5</i> <i>real32</i>	Data storage parameter 5.	0.000
	-2147483.000... 2147483.000	32-bit data.	
47.06	<i>Data storage 6</i> <i>real32</i>	Data storage parameter 6.	0.000
	-2147483.000... 2147483.000	32-bit data.	
47.07	<i>Data storage 7</i> <i>real32</i>	Data storage parameter 7.	0.000
	-2147483.000... 2147483.000	32-bit data.	
47.08	<i>Data storage 8</i> <i>real32</i>	Data storage parameter 8.	0.000
	-2147483.000... 2147483.000	32-bit data.	
47.11	<i>Data storage 1</i> <i>int32</i>	Data storage parameter 9.	0
	-2147483648... 2147483647	32-bit data.	
47.12	<i>Data storage 2</i> <i>int32</i>	Data storage parameter 10.	0
	-2147483648... 2147483647	32-bit data.	
47.13	<i>Data storage 3</i> <i>int32</i>	Data storage parameter 11.	0
	-2147483648... 2147483647	32-bit data.	
47.14	<i>Data storage 4</i> <i>int32</i>	Data storage parameter 12.	0
	-2147483648... 2147483647	32-bit data.	
47.21	<i>Data storage 1</i> <i>int16</i>	Data storage parameter 17.	0
	-32768...32767	16-bit data.	1 = 1
47.22	<i>Data storage 2</i> <i>int16</i>	Data storage parameter 18.	0
	-32768...32767	16-bit data.	1 = 1
47.23	<i>Data storage 3</i> <i>int16</i>	Data storage parameter 19.	0
	-32768...32767	16-bit data.	1 = 1
47.24	<i>Data storage 4</i> <i>int16</i>	Data storage parameter 20.	0
	-32768...32767	16-bit data.	1 = 1
47.25	<i>Data storage 5</i> <i>int16</i>	Data storage parameter 21.	0
	-32768...32767	16-bit data.	1 = 1

No.	Name/Value	Description	Def/FbEq16
47.26	Data storage 6 int16	Data storage parameter 22.	0
	-32768...32767	16-bit data.	1 = 1
47.27	Data storage 7 int16	Data storage parameter 23.	0
	-32768...32767	16-bit data.	1 = 1
47.28	Data storage 8 int16	Data storage parameter 24.	0
	-32768...32767	16-bit data.	1 = 1
49 Panel port communication		Communication settings for the control panel port on the drive.	
49.01	Node ID number	Defines the node ID of the drive. All devices connected to the network must have a unique node ID. Note: For networked drives, it is advisable to reserve ID 1 for spare/replacement drives.	1
	1...32	Node ID.	1 = 1
49.03	Baud rate	Defines the transfer rate of the link.	115.2 kbps
	38.4 kbps	38.4 kbit/s.	1
	57.6 kbps	57.6 kbit/s.	2
	86.4 kbps	86.4 kbit/s.	3
	115.2 kbps	115.2 kbit/s.	4
	230.4 kbps	230.4 kbit/s.	5
49.04	Communication loss time	Sets a timeout for control panel (or PC tool) communication. If a communication break lasts longer than the timeout, the action specified by parameter 49.05 Communication loss action is taken.	10.0 s
	0.3...3000.0 s	Control panel/PC tool communication timeout.	10 = 1 s
49.05	Communication loss action	Selects how the drive reacts to a control panel (or PC tool) communication break.	Fault
	No action	No action taken.	0
	Fault	Drive trips on fault 7081 Control panel loss .	1
	Last speed	Drive generates warning A7EE Panel loss and freezes the speed to the level the drive was operating at. The speed is determined on the basis of actual speed using 850 ms low-pass filtering.  WARNING! Make sure that it is safe to continue operation in case of a communication break.	2
	Speed ref safe	Drive generates warning A7EE Panel loss and sets the speed to the speed defined by parameter 22.41 Speed ref safe (or 28.41 Frequency ref safe when frequency reference is being used).  WARNING! Make sure that it is safe to continue operation in case of a communication break.	3
49.06	Refresh settings	Applies the settings of parameters 49.01...49.05 . Note: Refreshing may cause a communication break, so reconnecting the drive may be required.	Done
	Done	Refresh done or not requested.	0

No.	Name/Value	Description	Def/FbEq16
	Configure	Refresh parameters 49.01...49.05 . The value reverts automatically to <i>Done</i> .	1
50 Fieldbus adapter (FBA)		Fieldbus communication configuration. See also chapter <i>Fieldbus control through a fieldbus adapter</i> (page 347).	
50.01	FBA A enable	Enables/disables communication between the drive and fieldbus adapter A, and specifies the slot the adapter is installed into.	<i>Disable</i>
	Disable	Communication between drive and fieldbus adapter A disabled.	0
	Enable	Communication between drive and fieldbus adapter A enabled. The adapter is in slot 1.	1
50.02	FBA A comm loss func	Selects how the drive reacts upon a fieldbus communication break. The time delay is defined by parameter 50.03 FBA A comm loss t out .	<i>No action</i>
	No action	No action taken.	0
	Fault	Drive trips on fault 7510 FBA A communication . This only occurs if control is expected from the fieldbus (FBA A selected as source of start/stop/reference in the currently active control location).	1
	Last speed	Drive generates warning A7C1 FBA A communication and freezes the speed to the level the drive was operating at. This only occurs if control is expected from the fieldbus. The speed is determined on the basis of actual speed using 850 ms low-pass filtering.  WARNING! Make sure that it is safe to continue operation in case of a communication break.	2
	Speed ref safe	Drive generates warning A7C1 FBA A communication and sets the speed to the value defined by parameter 22.41 Speed ref safe (when speed reference is being used) or 28.41 Frequency ref safe (when frequency reference is being used). This only occurs if control is expected from the fieldbus.  WARNING! Make sure that it is safe to continue operation in case of a communication break.	3
	Fault always	Drive trips on fault 7510 FBA A communication . This occurs even though no control is expected from the fieldbus.	4
	Warning	Drive generates warning A7C1 FBA A communication . This only occurs if control is expected from the fieldbus.  WARNING! Make sure that it is safe to continue operation in case of a communication break.	5
50.03	FBA A comm loss t out	Defines the time delay before the action defined by parameter 50.02 FBA A comm loss func is taken. Time count starts when the communication link fails to update the message. Notes: <ul style="list-style-type: none"> • There is a 60-second boot-up delay immediately after power-up. During the delay, the communication break monitoring is disabled (but communication itself can be active). • This timer starts after the value of parameter 51.31 D2FBA A comm status becomes <i>Off-line</i>. This timer only delays the function selected in 50.02 FBA A comm loss func. 	0.3 s
	0.3...6553.5 s	Time delay.	10 = 1 s

No.	Name/Value	Description	Def/FbEq16						
50.04	<i>FBA A ref1 type</i>	Selects the type and scaling of reference 1 received from fieldbus adapter A. The scaling of the reference is defined by parameters 46.01 ... 46.04 , depending on which reference type is selected by this parameter.	<i>Speed or frequency</i>						
	Speed or frequency	Type and scaling is chosen automatically according to the currently active operation mode as follows: <table border="1" data-bbox="400 331 893 434"> <thead> <tr> <th>Operation mode (see par. 19.01)</th> <th>Reference 1 type</th> </tr> </thead> <tbody> <tr> <td>Speed control</td> <td><i>Speed</i></td> </tr> <tr> <td>Frequency control</td> <td><i>Frequency</i></td> </tr> </tbody> </table>	Operation mode (see par. 19.01)	Reference 1 type	Speed control	<i>Speed</i>	Frequency control	<i>Frequency</i>	0
Operation mode (see par. 19.01)	Reference 1 type								
Speed control	<i>Speed</i>								
Frequency control	<i>Frequency</i>								
	Transparent	No scaling is applied (the 16-bit scaling is 1 = 1 unit). Note: All decimal information is lost, for example, 1.23 = 1.	1						
	General	Generic reference with a 16-bit scaling of 100 = 1 (that is, integer and two decimals). Note: All data after two decimals is lost, for example, 1.234 = 123.	2						
	Torque	The scaling is defined by parameter 46.03 Torque scaling .	3						
	Speed	The scaling is defined by parameter 46.01 Speed scaling .	4						
	Frequency	The scaling is defined by parameter 46.02 Frequency scaling .	5						
50.05	<i>FBA A ref2 type</i>	Selects the type and scaling of reference 2 received from fieldbus adapter A. The scaling of the reference is defined by parameters 46.01 ... 46.04 , depending on which reference type is selected by this parameter.	<i>Speed or frequency</i>						
	Speed or frequency	Type and scaling is chosen automatically according to the currently active operation mode as follows: <table border="1" data-bbox="400 874 893 976"> <thead> <tr> <th>Operation mode (see par. 19.01)</th> <th>Reference 2 type</th> </tr> </thead> <tbody> <tr> <td>Speed control</td> <td><i>Speed</i></td> </tr> <tr> <td>Frequency control</td> <td><i>Frequency</i></td> </tr> </tbody> </table> <p>Select Speed (selection 4) or Frequency (selection 5) manually.</p>	Operation mode (see par. 19.01)	Reference 2 type	Speed control	<i>Speed</i>	Frequency control	<i>Frequency</i>	0
Operation mode (see par. 19.01)	Reference 2 type								
Speed control	<i>Speed</i>								
Frequency control	<i>Frequency</i>								
	Transparent	No scaling is applied (the 16-bit scaling is 1 = 1 unit). Note: All decimal information is lost, for example, 1.23 = 1.	1						
	General	Generic reference with a 16-bit scaling of 100 = 1 (that is, integer and two decimals). Note: All data after two decimals is lost, for example, 1.234 = 123.	2						
	Torque	The scaling is defined by parameter 46.03 Torque scaling .	3						
	Speed	The scaling is defined by parameter 46.01 Speed scaling .	4						
	Frequency	The scaling is defined by parameter 46.02 Frequency scaling .	5						
50.06	<i>FBA A SW sel</i>	Selects the source of the Status word to be sent to the fieldbus network through fieldbus adapter A.	<i>Auto</i>						
	Auto	Source of the Status word is chosen automatically.	0						
	Transparent mode	The source selected by parameter 50.09 FBA A SW transparent source is transmitted as the Status word to the fieldbus network through fieldbus adapter A.	1						

No.	Name/Value	Description	Def/FbEq16						
50.07	<i>FBA A actual 1 type</i>	Selects the type and scaling of actual value 1 transmitted to the fieldbus network through fieldbus adapter A. The scaling of the value is defined by parameters 46.01...46.04, depending on which actual value type is selected by this parameter.	<i>Speed or frequency</i>						
	Speed or frequency	Type and scaling is chosen automatically according to the currently active operation mode as follows: <table border="1" data-bbox="348 352 841 456"> <thead> <tr> <th>Operation mode (see par. 19.01)</th> <th>Actual value 1 type</th> </tr> </thead> <tbody> <tr> <td>Speed control</td> <td><i>Speed</i></td> </tr> <tr> <td>Frequency control</td> <td><i>Frequency</i></td> </tr> </tbody> </table>	Operation mode (see par. 19.01)	Actual value 1 type	Speed control	<i>Speed</i>	Frequency control	<i>Frequency</i>	0
Operation mode (see par. 19.01)	Actual value 1 type								
Speed control	<i>Speed</i>								
Frequency control	<i>Frequency</i>								
	Transparent	The value selected by parameter 50.10 <i>FBA A act1 transparent source</i> is sent as actual value 1. No scaling is applied (the 16-bit scaling is 1 = 1 unit). Note: All decimal information is lost, for example, 1.23 = 1.	1						
	General	The value selected by parameter 50.10 <i>FBA A act1 transparent source</i> is sent as actual value 1 with a 16-bit scaling of 100 = 1 unit (that is, integer and two decimals). Note: All data after two decimals is lost, for example, 1.234 = 123.	2						
	Torque	The scaling is defined by parameter 46.03 <i>Torque scaling</i> .	3						
	Speed	01.01 <i>Motor speed used</i> is sent as actual value 1. The scaling is defined by parameter 46.01 <i>Speed scaling</i> .	4						
	Frequency	01.06 <i>Output frequency</i> is sent as actual value 1. The scaling is defined by parameter 46.02 <i>Frequency scaling</i> .	5						
50.08	<i>FBA A actual 2 type</i>	Selects the type and scaling of actual value 2 transmitted to the fieldbus network through fieldbus adapter A. The scaling of the value is defined by parameters 46.01...46.04, depending on which actual value type is selected by this parameter.	<i>Speed or frequency</i>						
	Speed or frequency	Type and scaling is chosen automatically according to the currently active operation mode as follows: <table border="1" data-bbox="348 1031 841 1134"> <thead> <tr> <th>Operation mode (see par. 19.01)</th> <th>Actual value 2 type</th> </tr> </thead> <tbody> <tr> <td>Speed control</td> <td><i>Speed</i></td> </tr> <tr> <td>Frequency control</td> <td><i>Frequency</i></td> </tr> </tbody> </table> <p>Select Speed (selection 4) or Frequency (selection 5) manually.</p>	Operation mode (see par. 19.01)	Actual value 2 type	Speed control	<i>Speed</i>	Frequency control	<i>Frequency</i>	0
Operation mode (see par. 19.01)	Actual value 2 type								
Speed control	<i>Speed</i>								
Frequency control	<i>Frequency</i>								
	Transparent	The value selected by parameter 50.10 <i>FBA A act1 transparent source</i> is sent as actual value 1. No scaling is applied (the 16-bit scaling is 1 = 1 unit). Note: All decimal information is lost, for example, 1.23 = 1.	1						
	General	The value selected by parameter 50.10 <i>FBA A act1 transparent source</i> is sent as actual value 1 with a 16-bit scaling of 100 = 1 unit (that is, integer and two decimals). Note: All data after two decimals is lost, for example, 1.234 = 123.	2						
	Torque	01.10 <i>Motor torque</i> is sent as actual value 1. The scaling is defined by parameter 46.03 <i>Torque scaling</i> .	3						

No.	Name/Value	Description	Def/FbEq16
	Speed	<i>01.01 Motor speed used</i> is sent as actual value 1. The scaling is defined by parameter <i>46.01 Speed scaling</i> .	4
	Frequency	<i>01.06 Output frequency</i> is sent as actual value 1. The scaling is defined by parameter <i>46.02 Frequency scaling</i> .	5
<i>50.09</i>	<i>FBA A SW transparent source</i>	Selects the source of the fieldbus status word when parameter <i>50.06 FBA A SW sel</i> is set to <i>Transparent mode</i> .	<i>Not selected</i>
	Not selected	No source selected.	-
	<i>Other</i>	Source selection (see <i>Terms and abbreviations</i> on page 358).	-
<i>50.10</i>	<i>FBA A act1 transparent source</i>	When parameter <i>50.07 FBA A actual 1 type</i> is set to <i>Transparent</i> , this parameter selects the source of actual value 1 transmitted to the fieldbus network through fieldbus adapter A.	<i>Not selected</i>
	Not selected	No source selected.	-
	<i>Other</i>	Source selection (see <i>Terms and abbreviations</i> on page 358).	-
<i>50.11</i>	<i>FBA A act2 transparent source</i>	When parameter <i>50.08 FBA A actual 2 type</i> is set to <i>Transparent</i> , this parameter selects the source of actual value 2 transmitted to the fieldbus network through fieldbus adapter A.	<i>Not selected</i>
	Not selected	No source selected.	-
	<i>Other</i>	Source selection (see <i>Terms and abbreviations</i> on page 358).	-
<i>50.12</i>	<i>FBA A debug mode</i>	This parameter enables debug mode. Displays raw (unmodified) data received from and sent to fieldbus adapter A in parameters <i>50.13...50.18</i> .	<i>Disable</i>
	Disable	Debug mode disabled.	0
	Fast	Debug mode enabled. Cyclical data update is as fast as possible which increases CPU load on the drive.	1
<i>50.13</i>	<i>FBA A control word</i>	Displays the raw (unmodified) control word sent by the master (PLC) to fieldbus adapter A if debugging is enabled by parameter <i>50.12 FBA A debug mode</i> . This parameter is read-only.	-
	0000000h... FFFFFFFFh	Control word sent by master to fieldbus adapter A.	-
<i>50.14</i>	<i>FBA A reference 1</i>	Displays raw (unmodified) reference REF1 sent by the master (PLC) to fieldbus adapter A if debugging is enabled by parameter <i>50.12 FBA A debug mode</i> . This parameter is read-only.	-
	-2147483648... 2147483647	Raw REF1 sent by master to fieldbus adapter A.	-
<i>50.15</i>	<i>FBA A reference 2</i>	Displays raw (unmodified) reference REF2 sent by the master (PLC) to fieldbus adapter A if debugging is enabled by parameter <i>50.12 FBA A debug mode</i> . This parameter is read-only.	-
	-2147483648... 2147483647	Raw REF2 sent by master to fieldbus adapter A.	-
<i>50.16</i>	<i>FBA A status word</i>	Displays the raw (unmodified) status word sent by fieldbus adapter A to the master (PLC) if debugging is enabled by parameter <i>50.12 FBA A debug mode</i> . This parameter is read-only.	-
	0000000h... FFFFFFFFh	Status word sent by fieldbus adapter A to master.	-

No.	Name/Value	Description	Def/FbEq16
50.17	<i>FBA A actual value 1</i>	Displays raw (unmodified) actual value ACT1 sent by fieldbus adapter A to the master (PLC) if debugging is enabled by parameter 50.12 FBA A debug mode . This parameter is read-only.	-
	-2147483648... 2147483647	Raw ACT1 sent by fieldbus adapter A to master.	
50.18	<i>FBA A actual value 2</i>	Displays raw (unmodified) actual value ACT2 sent by fieldbus adapter A to the master (PLC) if debugging is enabled by parameter 50.12 FBA A debug mode . This parameter is read-only.	-
	-2147483648... 2147483647	Raw ACT2 sent by fieldbus adapter A to master.	
51 FBA A settings		Fieldbus adapter A configuration.	
51.01	<i>FBA A type</i>	Displays the type of the connected fieldbus adapter module. 0 = None. Module is not found or is not properly connected, or is disabled by parameter 50.01 FBA A enable . 1 = PROFIBUS-DP 32 = CANopen 37 = DeviceNet 128 = Ethernet 132 = PROFINet IO 135 = EtherCAT 136 = ETH Pwrlink (Ethernet Powerlink) 485 = RS-485 comm 101 = ControlNet 47808 = BACnet/IP 2222 = Ethernet/IP 502 = Modbus/TCP This parameter is read-only.	-
51.02	<i>FBA A Par2</i>	Parameters 51.02 ... 51.26 are adapter module-specific. For more information, see the documentation of the fieldbus adapter module. Note that not all of these parameters are necessarily in use.	0
	0...65535	Fieldbus adapter configuration parameter.	1 = 1

51.26	<i>FBA A Par26</i>	See parameter 51.02 FBA A Par2 .	-
	0...65535	Fieldbus adapter configuration parameter.	1 = 1
51.27	<i>FBA A par refresh</i>	Validates any changed fieldbus adapter module configuration settings. After refreshing, the value reverts automatically to Done . Note: This parameter cannot be changed while the drive is running.	Done
	Done	Refreshing done.	0
	Configure	Refreshing.	1
51.28	<i>FBA A par table ver</i>	Displays the parameter table revision of the fieldbus adapter module mapping file (stored in the memory of the drive). In format axyz, where ax = major table revision number; yz = minor table revision number. This parameter is read-only.	-
		Parameter table revision of adapter module.	-

No.	Name/Value	Description	Def/FbEq16
51.29	<i>FBA A drive type code</i>	Displays the drive type code in the fieldbus adapter module mapping file (stored in the memory of the drive). This parameter is read-only.	-
	0...65535	Drive type code stored in the mapping file.	1 = 1
51.30	<i>FBA A mapping file ver</i>	Displays the fieldbus adapter module mapping file revision stored in the memory of the drive in decimal format. This parameter is read-only.	-
	0...65535	Mapping file revision.	1 = 1
51.31	<i>D2FBA A comm status</i>	Displays the status of the fieldbus adapter module communication. Note: After the FBA detects a comm loss, it will wait for a time delay before changing this comm status parameter to <i>Off-line</i> . If this time delay exists for an FBA module, then it will be in module specific section. See parameters 51.02...51.26 for more information.	<i>Not configured</i>
	Not configured	Adapter is not configured.	0
	Initializing	Adapter is initializing.	1
	Time out	A timeout has occurred in the communication between the adapter and the drive.	2
	Configuration error	Adapter configuration error: mapping file not found in the file system of the drive, or mapping file upload has failed more than three times.	3
	Off-line	Fieldbus communication is off-line.	4
	On-line	Fieldbus communication is on-line, or fieldbus adapter has been configured not to detect a communication break. For more information, see the documentation of the fieldbus adapter.	5
	Reset	Adapter is performing a hardware reset.	6
51.32	<i>FBA A comm SW ver</i>	Displays the common program revision of the adapter module in format axyz, where a = major revision number, xy = minor revision number, z = correction number or letter. Example: 190A = revision 1.90A.	-
		Common program revision of adapter module.	-
51.33	<i>FBA A appl SW ver</i>	Displays the application program revision of the adapter module in format axyz, where a = major revision number, xy = minor revision number, z = correction number or letter. Example: 190A = revision 1.90A.	-
		Application program version of adapter module.	-
52 FBA A data in		Selection of data to be transferred from drive to fieldbus controller through fieldbus adapter A. Note: 32-bit values require two consecutive parameters. Whenever a 32-bit value is selected in a data parameter, the next parameter is automatically reserved.	
52.01	<i>FBA A data in 1</i>	Parameters 52.01...52.12 select data to be transferred from the drive to the fieldbus controller through fieldbus adapter A.	<i>None</i>
	None	None.	0
	CW 16bit	Control Word (16 bits)	1
	Ref1 16bit	Reference REF1 (16 bits)	2
	Ref2 16bit	Reference REF2 (16 bits)	3

No.	Name/Value	Description	Def/FbEq16
	SW 16bit	Status Word (16 bits)	4
	Act1 16bit	Actual value ACT1 (16 bits)	5
	Act2 16bit	Actual value ACT2 (16 bits)	6
	Reserved		7...10
	CW 32bit	Control Word (32 bits)	11
	Ref1 32bit	Reference REF1 (32 bits)	12
	Ref2 32bit	Reference REF2 (32 bits)	13
	SW 32bit	Status Word (32 bits)	14
	Act1 32bit	Actual value ACT1 (32 bits)	15
	Act2 32bit	Actual value ACT2 (32 bits)	16
	Reserved		17...23
	SW2 16bit	Status Word 2 (16 bits)	24
	<i>Other</i>	Source selection (see <i>Terms and abbreviations</i> on page 358).	-
...
52.12	FBA A data in12	See parameter 52.01 FBA A data in1 .	<i>None</i>

53 FBA A data out		Selection of data to be transferred from fieldbus controller to drive through fieldbus adapter A. Note: 32-bit values require two consecutive parameters. Whenever a 32-bit value is selected in a data parameter, the next parameter is automatically reserved.	
53.01	FBA A data out1	Parameters 53.01 ... 53.12 select data to be transferred from the fieldbus controller to the drive through fieldbus adapter A.	<i>None</i>
	None	None.	0
	CW 16bit	Control Word (16 bits)	1
	Ref1 16bit	Reference REF1 (16 bits)	2
	Ref2 16bit	Reference REF2 (16 bits)	3
	Reserved		7...10
	CW 32bit	Control Word (32 bits)	11
	Ref1 32bit	Reference REF1 (32 bits)	12
	Ref2 32bit	Reference REF2 (32 bits)	13
	Reserved		14...20
	CW2 16bit	Control Word 2 (16 bits)	21
	<i>Other</i>	Source selection (see <i>Terms and abbreviations</i> on page 358).	-
...
53.12	FBA A data out12	See parameter 53.01 FBA A data out1 .	<i>None</i>

58 Embedded fieldbus		Configuration of the embedded fieldbus (EFB) interface. See also chapter <i>Modbus RTU control through the embedded fieldbus interface (EFB)</i> (page 271).	
58.01	Protocol enable	Enables/disables the embedded fieldbus interface and selects the protocol to use.	<i>None</i>
	None	None (communication disabled).	0
	Modbus RTU	Embedded fieldbus interface is enabled and uses the Modbus RTU protocol.	1



No.	Name/Value	Description	Def/FbEq16
	BACnet MSTP	Embedded fieldbus interface is enabled and uses the BACnet MS/TP protocol.	2
	Reserved		3...4
	None / IPC communication	Embedded fieldbus interface is enabled and is used for IPC communication.	4
	N2	Embedded fieldbus interface is enabled and uses the N2 protocol.	5
	Reserved		6
	GP1	Generic Protocol 1. Contact ABB technical support for details.	7
58.02	Protocol ID	Displays the protocol ID and revision. First 4 bits specify the protocol ID and last 12 bits specify the revision. This parameter is read-only.	-
		Protocol ID and revision.	
58.03	Node address	Defines the node address of the drive on the fieldbus link. Values 1...247 are allowable. Also called Station ID, MAC Address or Device Address. Two devices with the same address are not allowed on-line. Changes to this parameter take effect after the control unit is rebooted or the new settings validated by parameter 58.06 Communication control (Refresh settings) .	1
	0...255	Node address (values 1...247 are allowed).	1 = 1
58.04	Baud rate	Selects the transfer rate of the fieldbus link. When using selection Autodetect , the parity setting of the bus must be known and configured in parameter 58.05 Parity . When parameter 58.04 Baud rate is set to Autodetect , the EFB settings must be refreshed with parameter 58.06 . The bus is monitored for a period of time and the detected baud rate is set as the value of this parameter. Changes to this parameter take effect after the control unit is rebooted or the new settings validated by parameter 58.06 Communication control (Refresh settings) .	Modbus RTU: 19.2 kbps BACnet MS/TP: Autodetect N2: 9.6 kbps
	Autodetect	Baud rate detected automatically.	0
	4.8 kbps	4.8 kbit/s.	1
	9.6 kbps	9.6 kbit/s.	2
	19.2 kbps	19.2 kbit/s.	3
	38.4 kbps	38.4 kbit/s.	4
	57.6 kbps	57.6 kbit/s.	5
	76.8 kbps	76.8 kbit/s.	6
	115.2 kbps	115.2 kbit/s.	7
58.05	Parity	<u>Modbus RTU, N2 only:</u> Selects the type of parity bit and number of stop bits. Changes to this parameter take effect after the control unit is rebooted or the new settings validated by parameter 58.06 Communication control (Refresh settings) . Note: For BACnet MS/TP, the BACnet standard defines the parity as 8 NONE 1 .	8 EVEN 1
	8 NONE 1	Eight data bits, no parity bit, one stop bit.	0
	8 NONE 2	Eight data bits, no parity bit, two stop bits.	1
	8 EVEN 1	Eight data bits, even parity bit, one stop bit.	2

No.	Name/Value	Description	Def/FbEq16
	8 ODD 1	Eight data bits, odd parity bit, one stop bit.	3
<i>58.06</i>	<i>Communication control</i>	Takes changed EFB settings in use, or activates silent mode.	<i>Enabled</i>
	Enabled	Normal operation.	0
	Refresh settings	Refreshes settings (parameters <i>58.01...58.05</i> , <i>58.14...58.17</i> , <i>58.25</i> , <i>58.28...58.34</i>) and takes changed EFB configuration settings in use. Reverts automatically to <i>Enabled</i> .	1
	Silent mode	Activates silent mode (no messages are transmitted). Silent mode can be terminated by activating the <i>Refresh settings</i> selection of this parameter.	2
<i>58.07</i>	<i>Communication diagnostics</i>	Displays the status of the EFB communication. This parameter is read-only. Note that the name is only visible when the error is present (bit value is 1).	-

Bit	Name	Description
0	Init failed	1 = EFB initialization failed
1	Addr config err	1 = Node address not allowed by protocol
2	Silent mode	1 = Drive not allowed to transmit
		0 = Drive allowed to transmit
3	Autobauding	1 = Automatic detection of baud rate is in use (see parameter <i>58.04</i>)
4	Wiring error	1 = Errors detected (A/B wires possibly swapped)
5	Parity error	1 = Error detected: check parameters <i>58.04</i> and <i>58.05</i>
6	Baud rate error	1 = Error detected: check parameters <i>58.05</i> and <i>58.04</i>
7	No bus activity	1 = 0 bytes received during last 5 seconds
8	No packets	1 = 0 packets (addressed to any device) detected during last 5 seconds
9	Noise or addressing error	1 = Errors detected (interference, or another device with the same address on line)
10	Comm loss	1 = 0 packets addressed to the drive received within timeout (<i>58.16</i>)
11	CW/Ref loss	1 = No control word or references received within timeout (<i>58.16</i>)
12	Reserved	
13	Protocol 1	1 = Duplicate ID detected on the network. Used for BACnet.
14	Reserved	
15	Internal error	1 = One or more communication errors have occurred between the drive and the control system. This bit indicates that an invalid or unsupported request has been made. The presence of this bit does not prevent further communication nor indicate a hardware issue.

0000h...FFFFh	EFB communication status.	1 = 1	
<i>58.08</i>	<i>Received packets</i>	Displays a count of valid packets addressed to the drive. During normal operation, this number increases constantly. Can be reset from the control panel by pressing the Reset softkey for 3 seconds.	-
0...4294967295	Number of received packets addressed to the drive.		

No.	Name/Value	Description	Def/FbEq16
58.09	<i>Transmitted packets</i>	Displays a count of valid packets transmitted by the drive. During normal operation, this number increases constantly. Can be reset from the control panel by pressing the Reset softkey for 3 seconds.	-
	0...4294967295	Number of transmitted packets.	
58.10	<i>All packets</i>	Displays a count of valid packets addressed to any device on the bus. During normal operation, this number increases constantly. Can be reset from the control panel by pressing the Reset softkey for 3 seconds.	-
	0...4294967295	Number of all received packets.	
58.11	<i>UART errors</i>	Displays a count of character errors received by the drive. An increasing count indicates a configuration problem on the bus. Can be reset from the control panel by pressing the Reset softkey for 3 seconds.	-
	0...4294967295	Number of UART errors.	
58.12	<i>CRC errors</i>	Displays a count of packets with a CRC error received by the drive. An increasing count indicates interference on the bus. Can be reset from the control panel by pressing the Reset softkey for 3 seconds.	-
	0...4294967295	Number of CRC errors.	
58.13	<i>Token counter</i>	<u>BACnet MS/TP only</u> : Contains a count of the number of times this device has received the token. Used for diagnostic purposes.	0
	0...4294967295	Counter.	1 = 1
58.14	<i>Communication loss action</i>	Selects how the drive reacts to an EFB communication break. Changes to this parameter take effect after the control unit is rebooted or the new settings validated by parameter 58.06 Communication control (Refresh settings) . See also parameters 58.15 Communication loss mode and 58.16 Communication loss time .	<i>No action</i>
	No action	No action taken (monitoring disabled).	0
	Fault	Drive monitors communication loss when start/stop is expected from the EFB on the currently active control location. The drive trips on fault 6681 EFB comm loss if control in the currently active control location is expected from the EFB or reference is coming from the EFB, and the communication is lost.	1
	Last speed	Drive generates warning A7CE EFB comm loss and freezes the speed to the level the drive was operating at. The speed is determined on the basis of actual speed using 850 ms low-pass filtering. This occurs if control or reference is expected from the EFB.  WARNING! Make sure that it is safe to continue operation in case of a communication break.	2

No.	Name/Value	Description	Def/FbEq16
	Speed ref safe	Drive generates warning A7CE EFB comm loss and sets the speed to the speed defined by parameter 22.41 Speed ref safe (or 28.41 Frequency ref safe when frequency reference is being used). This occurs if control or reference is expected from the EFB.  WARNING! Make sure that it is safe to continue operation in case of a communication break.	3
	Fault always	Drive continuously monitors for communication loss. Drive trips on fault 6681 EFB comm loss . This happens even though the drive is in a control location where the EFB start/stop or reference is not used.	4
	Warning	Drive generates warning A7CE EFB comm loss . This occurs even though no control is expected from the EFB.  WARNING! Make sure that it is safe to continue operation in case of a communication break.	5
58.15	Communication loss mode	Defines which message types reset the timeout counter for detecting an EFB communication loss. Changes to this parameter take effect after the control unit is rebooted or the new settings validated by parameter 58.06 Communication control (Refresh settings) . See also parameters 58.14 Communication loss action and 58.16 Communication loss time .	Cw / Ref1 / Ref2
	Any message	Any message addressed to the drive resets the timeout.	1
	Cw / Ref1 / Ref2	A write of the control word or a reference resets the timeout.	2
58.16	Communication loss time	Sets a timeout for EFB communication. If a communication break lasts longer than the timeout, the action specified by parameter 58.14 Communication loss action is taken. Changes to this parameter take effect after the control unit is rebooted or the new settings validated by parameter 58.06 Communication control (Refresh settings) . See also parameter 58.15 Communication loss mode . Note: There is a 30-second boot-up delay immediately after power-up.	30.0 s
	0.0...6000.0 s	EFB communication timeout.	1 = 1 s
58.17	Transmit delay	<u>Modbus RTU, N2 only:</u> Defines a minimum response delay in addition to any fixed delay imposed by the protocol. Changes to this parameter take effect after the control unit is rebooted or the new settings validated by parameter 58.06 Communication control (Refresh settings) .	0 ms
	0...65535 ms	Minimum response delay.	1 = 1 ms
58.18	EFB control word	<u>Modbus RTU, BACnet MS/TP only:</u> Displays the raw (unmodified) control word sent by the Modbus controller to the drive. For debugging purposes. This parameter is read-only.	-
	0000000h... FFFFFFFFh	Control word sent by Modbus controller to the drive.	1 = 1
58.19	EFB status word	<u>Modbus RTU, BACnet MS/TP only:</u> Displays the raw (unmodified) status word for debugging purposes. This parameter is read-only.	-
	0000000h... FFFFFFFFh	Status word sent by the drive to the Modbus controller.	1 = 1

No.	Name/Value	Description	Def/FbEq16						
58.25	<i>Control profile</i>	<u>Modbus RTU only</u> : Defines the communication profile used by the Modbus protocol. Changes to this parameter take effect after the control unit is rebooted or the new settings validated by parameter 58.06 Communication control (Refresh settings) . See section About the control profiles on page 280. Note: If you want to use the ABB drives limited profile, set parameter 96.79 Legacy control profile accordingly (supported in firmware revisions 2.15 or later).	ABB Drives						
	ABB Drives	ABB Drives control profile (with a 16-bit control word)	0						
	DCU Profile	DCU control profile (with a 16 or 32-bit control word)	5						
58.26	<i>EFB ref1 type</i>	<u>Modbus RTU only</u> : Selects the type and scaling of reference 1 received through the embedded fieldbus interface. The scaled reference is displayed by 03.09 EFB reference 1 .	Speed or frequency						
	Speed or frequency	Type and scaling is chosen automatically according to the currently active operation mode as follows. <table border="1" data-bbox="400 587 893 691"> <thead> <tr> <th>Operation mode (see par. 19.01)</th> <th>Reference 1 type</th> </tr> </thead> <tbody> <tr> <td>Speed control</td> <td><i>Speed</i></td> </tr> <tr> <td>Frequency control</td> <td><i>Frequency</i></td> </tr> </tbody> </table>	Operation mode (see par. 19.01)	Reference 1 type	Speed control	<i>Speed</i>	Frequency control	<i>Frequency</i>	0
Operation mode (see par. 19.01)	Reference 1 type								
Speed control	<i>Speed</i>								
Frequency control	<i>Frequency</i>								
	Transparent	No scaling is applied.	1						
	General	Generic reference without a specific unit. Scaling: 1 = 100.	2						
	Torque	Torque reference. The scaling is defined by parameter 46.03 Torque scaling .	3						
	Speed	Speed reference. The scaling is defined by parameter 46.01 Speed scaling .	4						
	Frequency	Frequency reference. The scaling is defined by parameter 46.02 Frequency scaling .	5						
58.27	<i>EFB ref2 type</i>	<u>Modbus RTU only</u> : Selects the type and scaling of reference 2 received through the embedded fieldbus interface. The scaled reference is displayed by 03.10 EFB reference 2 .	Speed or frequency						
58.28	<i>EFB act1 type</i>	<u>Modbus RTU only</u> : Selects the type of actual value 1.	Speed or frequency						
	Speed or frequency	Type and scaling is chosen automatically according to the currently active operation mode as follows. <table border="1" data-bbox="400 1150 893 1254"> <thead> <tr> <th>Operation mode (see par. 19.01)</th> <th>Actual 1 type</th> </tr> </thead> <tbody> <tr> <td>Speed control</td> <td><i>Speed</i></td> </tr> <tr> <td>Frequency control</td> <td><i>Frequency</i></td> </tr> </tbody> </table>	Operation mode (see par. 19.01)	Actual 1 type	Speed control	<i>Speed</i>	Frequency control	<i>Frequency</i>	0
Operation mode (see par. 19.01)	Actual 1 type								
Speed control	<i>Speed</i>								
Frequency control	<i>Frequency</i>								
	Transparent	No scaling is applied.	1						
	General	Generic reference without a specific unit. Scaling: 1 = 100.	2						
	Torque	Scaling is defined by parameter 46.03 Torque scaling .	3						
	Speed	Scaling is defined by parameter 46.01 Speed scaling .	4						
	Frequency	Scaling is defined by parameter 46.02 Frequency scaling .	5						

No.	Name/Value	Description	Def/FbEq16
58.29	<i>EFB act2 type</i>	<u>Modbus RTU only</u> : Selects the type of actual value 2. For the selections, see parameter <i>58.28 EFB act1 type</i> .	<i>Transparent</i>
58.30	<i>EFB status word transparent source</i>	<u>N2 only</u> : Selects the source of actual value 1 when parameter <i>58.28 EFB act1 type</i> is set to <i>Transparent</i> .	<i>Not selected</i>
	Not selected	None.	0
	<i>Other</i>	Source selection (see <i>Terms and abbreviations</i> on page 358).	-
58.31	<i>EFB act1 transparent source</i>	<u>Modbus RTU only</u> : Selects the source of actual value 1 when parameter <i>58.28 EFB act1 type</i> is set to <i>Transparent</i> .	<i>Not selected</i>
	Not selected	None.	0
	<i>Other</i>	Source selection (see <i>Terms and abbreviations</i> on page 358).	-
58.32	<i>EFB act2 transparent source</i>	<u>Modbus RTU, N2 only</u> : Selects the source of actual value 2 when parameter <i>58.29 EFB act2 type</i> is set to <i>Transparent</i> .	<i>Not selected</i>
	Not selected	None.	0
	<i>Other</i>	Source selection (see <i>Terms and abbreviations</i> on page 358).	-
58.33	<i>Addressing mode</i>	<u>Modbus RTU only</u> : Defines the mapping between parameters and holding registers in the 400101...465535 Modbus register range. Changes to this parameter take effect after the control unit is rebooted or the new settings validated by parameter <i>58.06 Communication control (Refresh settings)</i> .	<i>Mode 0</i>
	Mode 0	<u>16-bit values (groups 1...99, indexes 1...99)</u> : Register address = 400000 + 100 × parameter group + parameter index. For example, parameter 22.80 would be mapped to register 400000 + 2200 + 80 = 402280. <u>32-bit values (groups 1...99, indexes 1...99)</u> : Register address = 420000 + 200 × parameter group + 2 × parameter index. For example, parameter 22.80 would be mapped to register 420000 + 4400 + 160 = 424560.	0
	Mode 1	<u>16-bit values (groups 1...255, indexes 1...255)</u> : Register address = 400000 + 256 × parameter group + parameter index. For example, parameter 22.80 would be mapped to register 400000 + 5632 + 80 = 405712.	1
	Mode 2	<u>32-bit values (groups 1...127, indexes 1...255)</u> : Register address = 400000 + 512 × parameter group + 2 × parameter index. For example, parameter 22.80 would be mapped to register 400000 + 11264 + 160 = 411424.	2
58.34	<i>Word order</i>	<u>Modbus RTU only</u> : Selects in which order 16-bit registers of 32-bit parameters are transferred. For each register, the first byte contains the high order byte and the second byte contains the low order byte. Changes to this parameter take effect after the control unit is rebooted or the new settings validated by parameter <i>58.06 Communication control (Refresh settings)</i> .	<i>LO-HI</i>
	HI-LO	The first register contains the high order word, the second contains the low order word.	0
	LO-HI	The first register contains the low order word, the second contains the high order word.	1

No.	Name/Value	Description	Def/FbEq16
58.40	<i>Device object ID</i>	BACnet MS/TP only: The Device object ID must be unique across all BACnet devices in the building network. Valid values are in range 0...4194303. The default Device object ID (4194303) indicates that the Device object ID is uninitialized per the BACnet specification and it must be set to a unique value in the valid range. Changes to this parameter take effect after the control unit is rebooted or the new settings validated by parameter 58.06 Communication control (Refresh settings) .	4194303
	0...4194303	ID.	
58.41	<i>Max master</i>	BACnet MS/TP only: The highest master address for devices on the BACnet MS/TP bus. Changes to this parameter take effect after the control unit is rebooted or the new settings validated by parameter 58.06 Communication control (Refresh settings) .	127
	0...127	Address.	1 = 1
58.42	<i>Max info frames</i>	BACnet MS/TP only: The maximum number of information frames the device may transmit before it must pass the token. Changes to this parameter take effect after the control unit is rebooted or the new settings validated by parameter 58.06 Communication control (Refresh settings) .	1
	0...10	Maximum number information frames.	1 = 1
58.43	<i>Max APDU retries</i>	BACnet MS/TP only: Number of retries to send when no response is seen to confirmed requests. Changes to this parameter take effect after the control unit is rebooted or the new settings validated by parameter 58.06 Communication control (Refresh settings) .	3
	0...10	Number of retries.	1 = 1
58.44	<i>APDU timeout</i>	BACnet MS/TP only: The amount of time in seconds between retransmissions when an expected acknowledgement has not been received. Changes to this parameter take effect after the control unit is rebooted or the new settings validated by parameter 58.06 Communication control (Refresh settings) .	10 s
	0...60 s	Timeout.	1 = 1
58.47	<i>AV21 & AV22 unit</i>	BACnet MS/TP only: This parameter is used to configure the unit for BACnet objects <i>analog value 21</i> and <i>analog value 22</i> .	Percent
	Percent	This setting matches what existed in the drive prior to this feature.	0
	AO unit	This selection causes the BACnet objects to use whatever unit is configured for an analog output in group 13 Standard AO . Note that analog output 2 is always in mA.	1
58.101	<i>Data I/O 1</i>	Modbus RTU, BACnet MS/TP only: Defines the address in the drive which the Modbus master accesses when it reads from or writes to the register address corresponding to Modbus register 1 (400001). The master defines the type of the data (input or output). The value is transmitted in a Modbus frame consisting of two 16-bit words. If the value is 16-bit, it is transmitted in the LSW (least significant word). If the value is 32-bit, the subsequent parameter is also reserved for it and must be set to <i>None</i> .	<i>CW 16bit</i>
	None	No mapping, register is always zero.	0

No.	Name/Value	Description	Def/FbEq16
	CW 16bit	<i>ABB Drives</i> profile: 16-bit ABB drives control word; <i>DCU Profile</i> : lower 16 bits of the DCU control word.	1
	Ref1 16bit	Reference REF1 (16 bits).	2
	Ref2 16bit	Reference REF2 (16 bits).	3
	SW 16bit	<i>ABB Drives</i> profile: 16-bit ABB drives status word; <i>DCU Profile</i> : lower 16 bits of the DCU status word.	4
	Act1 16bit	Actual value ACT1 (16 bits).	5
	Act2 16bit	Actual value ACT2 aha(16 bits).	6
	Reserved		7...10
	CW 32bit	Control Word (32 bits).	11
	Ref1 32bit	Reference REF1 (32 bits).	12
	Ref2 32bit	Reference REF2 (32 bits).	13
	SW 32bit	Status Word (32 bits).	14
	Act1 32bit	Actual value ACT1 (32 bits).	15
	Act2 32bit	Actual value ACT2 (32 bits).	16
	Reserved		17...20
	CW2 16bit	<i>ABB Drives</i> profile: not used; <i>DCU Profile</i> : upper 16 bits of the DCU control word.	21
	SW2 16bit	<i>ABB Drives</i> profile: not used / always zero; <i>DCU Profile</i> : upper 16 bits of the DCU status word.	24
	Reserved		25...30
	RO/DIO control word	Parameter 10.99 RO/DIO control word .	31
	AO1 data storage	Parameter 13.91 AO1 data storage .	32
	AO2 data storage	Parameter 13.92 AO2 data storage .	33
	Reserved		34...39
	Feedback data storage	Parameter 40.91 Feedback data storage .	40
	Setpoint data storage	Parameter 40.92 Setpoint data storage .	41
	<i>Other</i>	Source selection (see Terms and abbreviations on page 358).	-
58.102	Data I/O 2	<u>Modbus RTU, BACnet MS/TP only</u> : Defines the address in the drive which the Modbus master accesses when it reads from or writes to register address 400002. For the selections, see parameter 58.101 Data I/O 1 .	Ref1 16bit
58.103	Data I/O 3	<u>Modbus RTU, BACnet MS/TP only</u> : Defines the address in the drive which the Modbus master accesses when it reads from or writes to register address 400003. For the selections, see parameter 58.101 Data I/O 1 .	Ref2 16bit
58.104	Data I/O 4	<u>Modbus RTU, BACnet MS/TP only</u> : Defines the address in the drive which the Modbus master accesses when it reads from or writes to register address 400004. For the selections, see parameter 58.101 Data I/O 1 .	SW 16bit
58.105	Data I/O 5	<u>Modbus RTU, BACnet MS/TP only</u> : Defines the address in the drive which the Modbus master accesses when it reads from or writes to register address 400005. For the selections, see parameter 58.101 Data I/O 1 .	Act1 16bit

No.	Name/Value	Description	Def/FbEq16
58.106	Data I/O 6	<u>Modbus RTU, BACnet MS/TP only</u> : Defines the address in the drive which the Modbus master accesses when it reads from or writes to register address 400006. For the selections, see parameter 58.101 Data I/O 1 .	<i>Act2 16bit</i>
58.107	Data I/O 7	<u>Modbus RTU, BACnet MS/TP only</u> : Parameter selector for Modbus register address 400007. For the selections, see parameter 58.101 Data I/O 1 .	<i>None</i>
...
58.114	Data I/O 14	<u>Modbus RTU, BACnet MS/TP only</u> : Parameter selector for Modbus register address 400014. For the selections, see parameter 58.101 Data I/O 1 .	<i>None</i>

70 Override																																										
		Enabling/disabling of the Override function, Override activation signal and Override speed/frequency. See control chain diagram Override on page 380 .																																								
70.01	<i>Override status</i>	Shows the override status. This parameter is read-only.	-																																							
<table border="1"> <thead> <tr> <th>Bit</th> <th>Name</th> <th>Description</th> </tr> </thead> <tbody> <tr> <td>0</td> <td>Override enabled</td> <td>0 = Override is disabled; 1 = Override is enabled.</td> </tr> <tr> <td>1</td> <td>Override active</td> <td>0 = Override is inactive; 1 = Drive is active.</td> </tr> <tr> <td>2</td> <td>Override direction is forward</td> <td>0 = Override direction is not forward; 1 = Override direction is forward.</td> </tr> <tr> <td>3</td> <td>Override direction is reverse</td> <td>0 = Override direction is not reverse; 1 = Override direction is reverse.</td> </tr> <tr> <td>4</td> <td>Override stop mode is active</td> <td>0 = Override stop mode is not active; 1 = Override stop mode is active.</td> </tr> <tr> <td>5...6</td> <td>Reserved</td> <td></td> </tr> <tr> <td>7</td> <td>Run permissive</td> <td>0 = Prevents running; 1 = Permits running.</td> </tr> <tr> <td>8</td> <td>Start interlock 1</td> <td>0 = Prevents starting; 1 = Permits starting.</td> </tr> <tr> <td>9</td> <td>Start interlock 2</td> <td>0 = Prevents starting; 1 = Permits starting.</td> </tr> <tr> <td>10</td> <td>Start interlock 3</td> <td>0 = Prevents starting; 1 = Permits starting.</td> </tr> <tr> <td>11</td> <td>Start interlock 4</td> <td>0 = Prevents starting; 1 = Permits starting.</td> </tr> <tr> <td>12...15</td> <td>Reserved</td> <td></td> </tr> </tbody> </table>				Bit	Name	Description	0	Override enabled	0 = Override is disabled; 1 = Override is enabled.	1	Override active	0 = Override is inactive; 1 = Drive is active.	2	Override direction is forward	0 = Override direction is not forward; 1 = Override direction is forward.	3	Override direction is reverse	0 = Override direction is not reverse; 1 = Override direction is reverse.	4	Override stop mode is active	0 = Override stop mode is not active; 1 = Override stop mode is active.	5...6	Reserved		7	Run permissive	0 = Prevents running; 1 = Permits running.	8	Start interlock 1	0 = Prevents starting; 1 = Permits starting.	9	Start interlock 2	0 = Prevents starting; 1 = Permits starting.	10	Start interlock 3	0 = Prevents starting; 1 = Permits starting.	11	Start interlock 4	0 = Prevents starting; 1 = Permits starting.	12...15	Reserved	
Bit	Name	Description																																								
0	Override enabled	0 = Override is disabled; 1 = Override is enabled.																																								
1	Override active	0 = Override is inactive; 1 = Drive is active.																																								
2	Override direction is forward	0 = Override direction is not forward; 1 = Override direction is forward.																																								
3	Override direction is reverse	0 = Override direction is not reverse; 1 = Override direction is reverse.																																								
4	Override stop mode is active	0 = Override stop mode is not active; 1 = Override stop mode is active.																																								
5...6	Reserved																																									
7	Run permissive	0 = Prevents running; 1 = Permits running.																																								
8	Start interlock 1	0 = Prevents starting; 1 = Permits starting.																																								
9	Start interlock 2	0 = Prevents starting; 1 = Permits starting.																																								
10	Start interlock 3	0 = Prevents starting; 1 = Permits starting.																																								
11	Start interlock 4	0 = Prevents starting; 1 = Permits starting.																																								
12...15	Reserved																																									
70.02	<i>Override enable</i>	Enables the Override function.	<i>Off</i>																																							
	Off	Override disabled.	0																																							
	On	Override enabled.	1																																							
	On, critical	Allows for an infinite number of fault resets. To be able use this selection, first set parameter 70.20 Override fault handling to value Autoreset . Note: Using Critical Override might void the warranty if the function is not used correctly.	2																																							
70.03	<i>Override activation source</i>	Selects the source of the Override activation. Value 0 of the source deactivates the Override. Value 1 of the source activates the Override.	<i>Not used</i>																																							
	Not used	0.	0																																							
	DI1	Digital input DI1 (10.02 DI delayed status , bit 0).	1																																							
	DI2	Digital input DI2 (10.02 DI delayed status , bit 1).	2																																							

No.	Name/Value	Description	Def/FbEq16
	DI3	Digital input DI3 (<i>10.02 DI delayed status</i> , bit 2).	3
	DI4	Digital input DI4 (<i>10.02 DI delayed status</i> , bit 3).	4
	DI5	Digital input DI5 (<i>10.02 DI delayed status</i> , bit 4).	5
	DI6	Digital input DI6 (<i>10.02 DI delayed status</i> , bit 5).	6
	-DI1	Digital input DI1 (<i>10.02 DI delayed status</i> , bit 0).	7
	-DI2	Digital input DI2 (<i>10.02 DI delayed status</i> , bit 1).	8
	-DI3	Digital input DI3 (<i>10.02 DI delayed status</i> , bit 2).	9
	-DI4	Digital input DI4 (<i>10.02 DI delayed status</i> , bit 3).	10
	-DI5	Digital input DI5 (<i>10.02 DI delayed status</i> , bit 4).	11
	-DI6	Digital input DI6 (<i>10.02 DI delayed status</i> , bit 5).	12
	Constant speed	Bit 7 of <i>06.19 Speed control status word</i> (see page 374).	13
	<i>Other [bit]</i>	Source selection (see <i>Terms and abbreviations</i> on page 358).	-
70.04	<i>Override reference source</i>	Selects the source for the speed used in the Override mode.	
	Constant speed	Constant speed used as the reference.	0
	AI1	<i>12.12 AI1 scaled value</i> (page 400).	1
	AI2	<i>12.22 AI2 scaled value</i> (page 402).	2
	Override speed/freq	Parameter <i>70.06 Override frequency</i> or <i>70.07 Override speed</i> is used as the reference.	3
	Motor potentiometer	<i>22.80 Motor potentiometer ref act</i> (output of the Floating point control (Motor potentiometer)).	4
	Stop	The output of the drive is shut off and the motor no longer runs. Override is displayed on the control panel but the motor does not run. Drive follows the specified stop type.	5
	Process PID set 1	<i>40.01 Process PID output actual</i> (page 521).	
70.05	<i>Override direction</i>	Selects the source of the motor direction used in the Override mode.	<i>Forward</i>
	Forward	Direction is forward.	0
	Reverse	Direction is reverse.	1
	DI1	Digital input DI1 (<i>10.02 DI delayed status</i> , bit 0).	2
	DI2	Digital input DI2 (<i>10.02 DI delayed status</i> , bit 1).	3
	DI3	Digital input DI3 (<i>10.02 DI delayed status</i> , bit 2).	4
	DI4	Digital input DI4 (<i>10.02 DI delayed status</i> , bit 3).	5
	DI5	Digital input DI5 (<i>10.02 DI delayed status</i> , bit 4).	6
	DI6	Digital input DI6 (<i>10.02 DI delayed status</i> , bit 5).	7
	-DI1	Digital input DI1 (<i>10.02 DI delayed status</i> , bit 0).	8
	-DI2	Digital input DI2 (<i>10.02 DI delayed status</i> , bit 1).	9
	-DI3	Digital input DI3 (<i>10.02 DI delayed status</i> , bit 2).	10
	-DI4	Digital input DI4 (<i>10.02 DI delayed status</i> , bit 3).	11
	-DI5	Digital input DI5 (<i>10.02 DI delayed status</i> , bit 4).	12
	-DI6	Digital input DI6 (<i>10.02 DI delayed status</i> , bit 5).	13
	<i>Other [bit]</i>	Source selection (see <i>Terms and abbreviations</i> on page 358).	-

No.	Name/Value	Description	Def/FbEq16																					
70.06	<i>Override frequency</i>	Defines the frequency used as reference in the Override mode if <i>70.04 Override reference source</i> is set to <i>Override speed/freq</i> and the drive is in frequency mode.	0.0 Hz																					
	-500.0...500.0 Hz	Override frequency.	1 = 1 Hz																					
70.07	<i>Override speed</i>	Defines the speed used in as reference the Override mode if <i>70.04 Override reference source</i> is set to <i>Override speed/freq</i> and the drive is in speed mode.	0.0 rpm																					
	30000.0... 30000.0 rpm	Override speed.	1 = rpm																					
70.10	<i>Override enables selection</i>	Selects which start interlock and run permissive input signals configured in the drive parameters will not allow the Override function to run the motor or will stop running the motor. The drive remains in Override mode nevertheless.	00000b																					
<table border="1"> <thead> <tr> <th>Bit</th> <th>Name</th> <th>Description</th> </tr> </thead> <tbody> <tr> <td>0</td> <td>Run permissive</td> <td>1 = The Override is not allowed to run the motor or the motor will be stopped, if the source defined by parameter <i>20.40 Run permissive</i> is 0.</td> </tr> <tr> <td>1</td> <td>Start interlock 1</td> <td>1 = The Override is not allowed to start the motor or the motor will be stopped, if the source defined by parameter <i>20.41 Start interlock 1</i> is 0.</td> </tr> <tr> <td>2</td> <td>Start interlock 2</td> <td>1 = The Override is not allowed to start the motor or the motor will be stopped, if the source defined by parameter <i>20.42 Start interlock 2</i> is 0.</td> </tr> <tr> <td>3</td> <td>Start interlock 3</td> <td>1 = The Override is not allowed to start the motor or the motor will be stopped, if the source defined by parameter <i>20.43 Start interlock 3</i> is 0.</td> </tr> <tr> <td>4</td> <td>Start interlock 4</td> <td>1 = The Override is not allowed to start the motor or the motor will be stopped, if the source defined by parameter <i>20.44 Start interlock 4</i> is 0.</td> </tr> <tr> <td>5...15</td> <td>Reserved</td> <td></td> </tr> </tbody> </table>				Bit	Name	Description	0	Run permissive	1 = The Override is not allowed to run the motor or the motor will be stopped, if the source defined by parameter <i>20.40 Run permissive</i> is 0.	1	Start interlock 1	1 = The Override is not allowed to start the motor or the motor will be stopped, if the source defined by parameter <i>20.41 Start interlock 1</i> is 0.	2	Start interlock 2	1 = The Override is not allowed to start the motor or the motor will be stopped, if the source defined by parameter <i>20.42 Start interlock 2</i> is 0.	3	Start interlock 3	1 = The Override is not allowed to start the motor or the motor will be stopped, if the source defined by parameter <i>20.43 Start interlock 3</i> is 0.	4	Start interlock 4	1 = The Override is not allowed to start the motor or the motor will be stopped, if the source defined by parameter <i>20.44 Start interlock 4</i> is 0.	5...15	Reserved	
Bit	Name	Description																						
0	Run permissive	1 = The Override is not allowed to run the motor or the motor will be stopped, if the source defined by parameter <i>20.40 Run permissive</i> is 0.																						
1	Start interlock 1	1 = The Override is not allowed to start the motor or the motor will be stopped, if the source defined by parameter <i>20.41 Start interlock 1</i> is 0.																						
2	Start interlock 2	1 = The Override is not allowed to start the motor or the motor will be stopped, if the source defined by parameter <i>20.42 Start interlock 2</i> is 0.																						
3	Start interlock 3	1 = The Override is not allowed to start the motor or the motor will be stopped, if the source defined by parameter <i>20.43 Start interlock 3</i> is 0.																						
4	Start interlock 4	1 = The Override is not allowed to start the motor or the motor will be stopped, if the source defined by parameter <i>20.44 Start interlock 4</i> is 0.																						
5...15	Reserved																							
70.20	<i>Override fault handling</i>	Faults are grouped into high priority faults and low priority faults. The following faults are high priority, and they are displayed and they will stop the drive: <i>2310 Overcurrent, 2330 Earth leakage, 2340 Short circuit, 3210 DC link overvoltage, 5090 STO hardware failure, 5091 Safe torque off, FA81 Safe torque off 1, FA82 Safe torque off 2.</i> Other faults are low priority faults. Active low priority faults are reset when the drive enters Override mode. Low priority faults are ignored when the drive is in Override mode.	<i>Fault on high priority</i>																					
	Fault on high priority	Fault on high priority faults. The fault must be reset from the control panel or from a digital input.	0																					
	Autoreset	Fault on high priority faults (except STO related faults) with automatic fault reset and run. See the list of high priority faults above. See parameter <i>70.21 Override auto reset trials</i> .	1																					

No.	Name/Value	Description	Def/FbEq16
70.21	<i>Override auto reset trials</i>	Defines the number of automatic fault resets the drive performs during Override operation. When the parameter is set to 0, reset trials are made continuously during the Override operation. A value of 1...5 defines a specific number of automatic reset trials.	5
	0...5	Number of automatic reset trials.	1 = 1
70.22	<i>Override auto reset time</i>	Defines the time the drive will wait after a fault before attempting an automatic fault reset.	5.0 s
	5.0...120.0 s	Auto reset delay time.	10 = 1 s
70.40	<i>Override log 1 start date</i>	Displays the start date of the last Override activation.	01.01.1980
		Start date.	
70.41	<i>Override log 1 start time</i>	Displays the start time of the last Override activation.	00:00:00
		Start time.	
70.42	<i>Override log 1 end date</i>	Displays the end date of the last Override situation. If the drive is in Override mode, the parameter shows the current date.	01.01.1980
		End date.	
70.43	<i>Override log 1 end time</i>	Displays the end time of the last Override situation. If the drive is in Override mode, the parameter shows the current time.	00:00:00
		End time.	
70.44	<i>Override log 1 fault 1</i>	Displays the last fault, if any, that occurred during the last operation of Override.	0
		Fault description.	
70.45	<i>Override log 1 fault 2</i>	Displays the second last fault, if any, that occurred during the last operation of Override.	0
		Fault description.	
70.46	<i>Override log 1 fault 3</i>	Displays the third last fault, if any, that occurred during the last operation of Override.	0
		Fault description.	
70.47	<i>Override log 1 warning 1</i>	Displays the last warning, if any, that occurred during the last operation of Override.	0
		Warning description.	
70.48	<i>Override log 1 warning 2</i>	Displays the second last warning, if any, that occurred during the last operation of Override.	0
		Warning description.	
70.49	<i>Override log 1 warning 3</i>	Displays the third last warning, if any, that occurred during the last operation of Override.	0
		Warning description.	
70.50	<i>Override log 2 start date</i>	Displays the start date of the second last Override activation.	01.01.1980
		Start date.	
70.51	<i>Override log 2 start time</i>	Displays the start time of the second last Override activation.	00:00:00
		Start time.	

No.	Name/Value	Description	Def/FbEq16
70.52	<i>Override log 2 end date</i>	Displays the end date of the second last Override situation.	01.01.1980
		End date.	
70.53	<i>Override log 2 end time</i>	Displays the end time of the second last Override situation.	00:00:00
		End time.	
70.54	<i>Override log 2 fault 1</i>	Displays the last fault, if any, that occurred during the second last operation of Override.	0
		Fault description.	
70.55	<i>Override log 2 fault 2</i>	Displays the second last fault, if any, that occurred during the second last operation of Override.	0
		Fault description.	
70.56	<i>Override log 2 fault 3</i>	Displays the third last fault, if any, that occurred during the second last operation of Override.	0
		Fault description.	
70.57	<i>Override log 2 warning 1</i>	Displays the last warning, if any, that occurred during the second last operation of Override.	0
		Warning description.	
70.58	<i>Override log 2 warning 2</i>	Displays the second last warning, if any, that occurred during second the last operation of Override.	0
		Warning description.	
70.59	<i>Override log 2 warning 3</i>	Displays the third last warning, if any, that occurred during the second last operation of Override.	0
		Warning description.	
70.60	<i>Override log 3 start date</i>	Displays the start date of the third last Override activation.	01.01.1980
		Start date.	
70.61	<i>Override log 3 end date</i>	Displays the start time of the third last Override activation.	00:00:00
		Start time.	
70.62	<i>Override log 3 end time</i>	Displays the end date of the third last Override situation.	01.01.1980
		End date.	
70.63	<i>Override log 3 end time</i>	Displays the end time of the third last Override situation.	00:00:00
		End time.	
70.64	<i>Override log 3 fault 1</i>	Displays the last fault, if any, that occurred during the third last operation of Override.	0
		Fault description.	
70.65	<i>Override log 3 fault 2</i>	Displays the second last fault, if any, that occurred during the third last operation of Override	0
		Fault description.	
70.66	<i>Override log 3 fault 3</i>	Displays the third last fault, if any, that occurred during the third last operation of Override.	0
		Fault description.	

No.	Name/Value	Description	Def/FbEq16
70.67	Override log 3 warning 1	Displays the last warning, if any, that occurred during the third last operation of Override.	0
		Warning description.	
70.68	Override log 3 warning 2	Displays the second last warning, if any, that occurred during third the last operation of Override.	0
		Warning description.	
70.69	Override log 3 warning 3	Displays the third last warning, if any, that occurred during the third last operation of Override.	0
		Warning description.	

71 External PID1

Configuration of external PID.
See control chain diagrams [External PID setpoint and feedback source selection](#), and [External PID controller](#) on pages 377 and 378, respectively.

71.01	External PID act value	See parameter 40.01 Process PID output actual .	-
71.02	Feedback act value	See parameter 40.02 Process PID feedback actual .	-
71.03	Setpoint act value	See parameter 40.03 Process PID setpoint actual .	-
71.04	Deviation act value	See parameter 40.04 Process PID deviation actual .	-
71.06	PID status word	Displays status information on process external PID control. This parameter is read-only.	-

Bit	Name	Value
0	PID active	1 = Process PID control active.
1	Reserved	
2	Output frozen	1 = Process PID controller output frozen. Bit is set if parameter 71.38 Output freeze enable is TRUE, or the deadband function is active (bit 9 is set).
3...6	Reserved	
7	Output limit high	1 = PID output is being limited by par. 71.37 .
8	Output limit low	1 = PID output is being limited by par. 71.36 .
9	Deadband active	1 = Deadband is active.
10...11	Reserved	
12	Internal setpoint active	1 = Internal setpoint active (see par. 71.16...71.23)
13...15	Reserved	

0000h...FFFFh	Process PID control status word.	1 = 1	
71.07	PID operation mode	See parameter 40.07 Process PID operation mode .	Off
71.08	Feedback 1 source	See parameter 40.08 Set 1 feedback 1 source .	Not selected
71.11	Feedback filter time	See parameter 40.11 Set 1 feedback filter time .	0.000 s

No.	Name/Value	Description	Def/FbEq16
71.14	<i>Setpoint scaling</i>	Defines, together with parameter <i>71.15 Output scaling</i> , a general scaling factor for the external PID control chain. The scaling can be utilized when, for example, the process setpoint is input in Hz, and the output of the PID controller is used as an rpm value in speed control. In this case, this parameter might be set to 50, and parameter <i>71.15</i> to the nominal motor speed at 50 Hz. In effect, the output of the PID controller [<i>71.15</i>] when deviation (setpoint - feedback) = [<i>71.14</i>] and [<i>71.32</i>] = 1. Note: The scaling is based on the ratio between <i>71.14</i> and <i>71.15</i> . For example, the values 50 and 1500 would produce the same scaling as 1 and 3.	100.00
	-200000.00... 200000.0	Process setpoint base.	1 = 1
71.15	<i>Output scaling</i>	See parameter <i>71.14 Setpoint scaling</i> .	100.00
	-200000.00... 200000.0	Process PID controller output base.	1 = 1
71.16	<i>Setpoint 1 source</i>	See parameter <i>40.16 Set 1 setpoint 1 source</i> .	<i>Not selected</i>
71.19	<i>Internal setpoint sel1</i>	See parameter <i>40.19 Set 1 internal setpoint sel1</i> .	<i>Not selected</i>
71.20	<i>Internal setpoint sel2</i>	See parameter <i>40.20 Set 1 internal setpoint sel2</i> .	<i>Not selected</i>
71.21	<i>Internal setpoint 1</i>	See parameter <i>40.21 Set 1 internal setpoint 1</i> .	0.00%
71.22	<i>Internal setpoint 2</i>	See parameter <i>40.22 Set 1 internal setpoint 2</i> .	0.00%
71.23	<i>Internal setpoint 3</i>	See parameter <i>40.23 Set 1 internal setpoint 3</i> .	0.00%
71.26	<i>Setpoint min</i>	See parameter <i>40.26 Set 1 setpoint min</i> .	0.00%
71.27	<i>Setpoint max</i>	See parameter <i>40.27 Set 1 setpoint max</i> .	200000.00%
71.31	<i>Deviation inversion</i>	See parameter <i>40.31 Set 1 deviation inversion</i> .	<i>Not inverted (Ref - Fbk)</i>
71.32	<i>Gain</i>	See parameter <i>40.32 Set 1 gain</i> .	1.00
71.33	<i>Integration time</i>	See parameter <i>40.33 Set 1 integration time</i> .	60.0 s
71.34	<i>Derivation time</i>	See parameter <i>40.34 Set 1 derivation time</i> .	0.000 s
71.35	<i>Derivation filter time</i>	See parameter <i>40.35 Set 1 derivation filter time</i> .	0.0 s
71.36	<i>Output min</i>	See parameter <i>40.36 Set 1 output min</i> .	-200000.00%
71.37	<i>Output max</i>	See parameter <i>40.37 Set 1 output max</i> .	200000.00%
71.38	<i>Output freeze enable</i>	See parameter <i>40.38 Set 1 output freeze enable</i> .	<i>Not selected</i>
71.39	<i>Deadband range</i>	The control program compares the absolute value of parameter <i>71.04 Deviation act value</i> to the deadband range defined by this parameter. If the absolute value is within the deadband range for the time period defined by parameter <i>71.40 Deadband delay</i> , PID's deadband mode is activated and <i>71.06 PID status word</i> bit 9 <i>Deadband active</i> is set. Then PID's output is frozen and <i>71.06 PID status word</i> bit 2 <i>Output frozen</i> is set. If the absolute value is equal or greater than the deadband range, PID's deadband mode is deactivated.	0.0%
	0.0...200000.0 %	Range	1 = 1%

No.	Name/Value	Description	Def/FbEq16
71.40	Deadband delay	Defines the deadband delay for the deadband function. See parameter 71.39 Deadband range .	0.0 s
	0.0...3600.0 s	Delay	1 = 1 s
71.58	Increase prevention	Activates increase prevention of PID integration term for Ext PID 1.	No
	No	Increase prevention not in use.	0
	Limiting	The Ext PID integration term is not increased.	1
	Process PID min lim	The Ext PID integration term is not increased when the output of the PID process has reached its minimum limit. In this setup, the external PID is used as a source for the PID process. This parameter is valid for the PID set 1.	2
	Process PID max lim	The Ext PID integration term is not increased when the output of the PID process has reached its maximum limit. In this setup, the external PID is used as a source for the PID process.	3
	Other [bit]	Source selection (see Terms and abbreviations on page 358).	-
71.59	Decrease prevention	Activates decrease prevention of PID integration term for Ext PID 1.	No
	No	Increase prevention not in use.	0
	Limiting	The Ext PID integration term is not decreased.	1
	Process PID min lim	The Ext PID integration term is not decreased when the output of the PID process has reached its minimum limit. In this setup, the external PID is used as a source for the PID process.	2
	Process PID max lim	The Ext PID integration term is not decreased when the output of the PID process has reached its maximum limit. In this setup, the external PID is used as a source for the PID process.	3
	Other [bit]	Source selection (see Terms and abbreviations on page 358).	-
71.62	Internal setpoint actual	See parameter 40.62 PID internal setpoint actual .	0.00%
71.79	External PID units	See parameter 40.79 Set 1 units .	%

No.	Name/Value	Description	Def/FbEq16																								
76 Multipump configuration		PFC (Pump and fan control), multipump and autochange configuration parameters. See sections <i>Single pump and fan control (PFC/SPFC)</i> on page 132, <i>Application example 1: Supply fan, Basic speed follower</i> on page 140 and <i>Intelligent pump control (IPC)</i> on page 120. Note: Parameters are dynamically hidden based on selection of pumping mode (<i>76.21 Multipump configuration</i>) and number of motors (<i>76.25 Number of motors</i>).																									
76.01	<i>PFC status</i>	Displays the running/stopped status of the PFC motors. PFC1, PFC2, PFC3, PFC4, PFC5 and PFC6 always correspond to the 1st...6th motor of the PFC system. If <i>76.74 Autochange auxiliary PFC</i> auxiliary PFC is set to <i>Aux motors only</i> , PFC1 represents the motor connected to the drive and PFC2 the first auxiliary motor (the 2nd motor of the system). If <i>76.74</i> is set to <i>All motors</i> , PFC1 is the first motor, PFC2 the 2nd. The drive can be connected to any of these motors depending on the Autochange functionality. * PFC5 and PFC6 will be supported in firmware versions 2.15 or later.	-																								
<table border="1"> <thead> <tr> <th>Bit</th> <th>Name</th> <th>Value</th> </tr> </thead> <tbody> <tr> <td>0</td> <td>PFC 1 running</td> <td>0 = Stop, 1 = Start</td> </tr> <tr> <td>1</td> <td>PFC 2 running</td> <td>0 = Stop, 1 = Start</td> </tr> <tr> <td>2</td> <td>PFC 3 running</td> <td>0 = Stop, 1 = Start</td> </tr> <tr> <td>3</td> <td>PFC 4 running</td> <td>0 = Stop, 1 = Start</td> </tr> <tr> <td>4</td> <td>PFC 5 running *</td> <td>0 = Stop, 1 = Start</td> </tr> <tr> <td>5</td> <td>PFC 6 running *</td> <td>0 = Stop, 1 = Start</td> </tr> <tr> <td>6...15</td> <td>Reserved</td> <td></td> </tr> </tbody> </table>				Bit	Name	Value	0	PFC 1 running	0 = Stop, 1 = Start	1	PFC 2 running	0 = Stop, 1 = Start	2	PFC 3 running	0 = Stop, 1 = Start	3	PFC 4 running	0 = Stop, 1 = Start	4	PFC 5 running *	0 = Stop, 1 = Start	5	PFC 6 running *	0 = Stop, 1 = Start	6...15	Reserved	
Bit	Name	Value																									
0	PFC 1 running	0 = Stop, 1 = Start																									
1	PFC 2 running	0 = Stop, 1 = Start																									
2	PFC 3 running	0 = Stop, 1 = Start																									
3	PFC 4 running	0 = Stop, 1 = Start																									
4	PFC 5 running *	0 = Stop, 1 = Start																									
5	PFC 6 running *	0 = Stop, 1 = Start																									
6...15	Reserved																										
0000h...FFFFh		Status of the PFC relay outputs.	1 = 1																								
76.02	<i>Multipump system status</i>	Displays the status of the multipump system in text format. Provides a quick PFC or IPC system overview, for example, if the parameter is added to the Home view on the control panel.	<i>PFC disabled</i>																								
PFC disabled		PFC (Pump and fan control) is disabled.	0																								
PFC enabled (not started)		PFC is enabled but not started.	1																								
SPFC enabled (not started)		SPFC (Soft pump and fan control) is enabled but not started.	2																								
MPFC enabled		Multipump and fan control functionality is enabled.	3																								
Invalid configuration		PFC configuration is invalid.	4																								
PFC inactive (local control)		PFC is inactive because the drive is in local control.	5																								
PFC inactive (invalid operation mode)		PFC is inactive because of an invalid operation mode.	6																								
Drive motor interlocked		The motor connected to the drive is interlocked (not available). Warning <i>D503 VSD controlled PFC motor interlocked</i> (page 251) is generated.	7																								

No.	Name/Value	Description	Def/FbEq16
	All motors interlocked	All motors are interlocked (not available). Warning <i>D502 All motors interlocked</i> (page 251) is generated.	8
	PFC inactive (ext1 active)	PFC is inactive because external control location EXT1 is in use. PFC is supported in EXT2 only.	9
	Running with VSD	The drive is controlling one pump/fan motor, no auxiliary motors are used.	100
	Running with VSD + 1 Aux	One auxiliary motor has been taken in use.	101
	Running with VSD + 2 Aux	Two auxiliary motor have been taken in use.	102
	Running with VSD + 3 Aux	Three auxiliary motor have been taken in use.	103
	Starting Aux1	Auxiliary motor 1 is being started.	200
	Starting Aux2	Auxiliary motor 2 is being started.	201
	Starting Aux3	Auxiliary motor 3 is being started.	202
	Stopping Aux1	Auxiliary motor 1 is being stopped.	300
	Stopping Aux2	Auxiliary motor 2 is being stopped.	301
	Stopping Aux3	Auxiliary motor 3 is being stopped.	302
	Autochange active	Autochange, that is, automatic rotation of the start order is active.	400
	No auxiliary motors available to be started	No auxiliary motors are available to be started, for example, all are already running, or a motor in not available due to maintenance.	500
	Regulator bypass active	Direct-on-line pumps are automatically started and stopped.	600
	MPFC connection ok	Multipump and fan control connection is OK.	700
	Interlocked	Pump is interlocked.	701
	Not ready	IPC is not ready.	702
	Standby	Drive is in standby mode.	703
	Master	Drive is master, running.	704
	Master (limited)	Drive is master, one or more pumps are offline or inhibited.	705
	Follower	Drive is follower.	706
	Follower (limited)	Drive is follower, one or more pumps are offline or inhibited.	707
	Follower (starting)	Drive is follower, starting.	708
	Master (stop delay)	Drive is master, waiting until stop delay time has passed.	709
	Master (start delay)	Drive is master, waiting until start delay time has passed.	710
	Master (wait start ack)	Waiting for master pump.	711
	Master (starting follower)	Drive is master, follower is starting.	712
	Master (wait switch ack)	Waiting for master pump.	713
	Master (stopping follower)	Drive is master, follower is stopping.	714
	Master (offline)	Drive is master, offline.	715

No.	Name/Value	Description	Def/FbEq16
	Not ready (node error)	Duplicate node(s) with same ID detected.	716
	Follower (stopping)	Pump is a follower and stopping	717
	Not ready (Off mode)	Drive is in Off mode.	718
	Not ready (Hand mode)	Drive is in Hand mode.	719
	Not ready (Hand mode (EXT1))	EXT1 selected as external control source.	720
	Standby (offline)	Drive is in standby mode, no remote pumps are connected	721
	Master (autochange)	Drive is master, master is changing.	722
	Master (PID sleep)	Drive is master, PID is sleeping.	723
	IPC version error	FW versions are not compatible between drives.	724
	Synchronizing settings	Synchronizing settings.	725
	Master (sleep)	Level control, No pumps are running, pump is the next master.	726
	Not ready	No nodes defined.	727
	Master (decaking)	Drive is master, decaking.	728
	Not ready (pumping mode)	Node settings mismatch.	729
	Not ready (level conflict)	Conflict in pump start or stop levels. One possible reason for this can be if parameter 30.13 Minimum frequency is higher than parameter 76.41 Stop point 1 .	730
	Master (waiting run permissive)	Drive is master, waiting for the run permissive before starting.	733
	Follower (waiting run permissive)	Drive is follower, waiting for the run permissive before starting.	734
	PID sleep	PID sleep is in use, and the pump can be stopped in during low demand.	800
	PID sleep boost	PID sleep with extended sleep time is in use, and the pump can be stopped in during low demand.	801
76.11	Pump/fan status 1	Shows the status of pump or fan 1.	-
76.12	Pump/fan status 2	See parameter 76.11 Pump/fan status 1 .	-
76.13	Pump/fan status 3	See parameter 76.11 Pump/fan status 1 .	-
76.14	Pump/fan status 4	See parameter 76.11 Pump/fan status 1 .	-
76.15	Pump/fan status 5	See parameter 76.11 Pump/fan status 1 .	-
76.16	Pump/fan status 6	See parameter 76.11 Pump/fan status 1 .	-
76.17	Pump/fan status 7	See parameter 76.11 Pump/fan status 1 . Only for IPC.	-
76.18	Pump/fan status 8	See parameter 76.11 Pump/fan status 1 . Only for IPC.	-
76.21	Multipump configuration	Selects the multi-pump/fan mode.	Off
	Off	Disabled.	0

No.	Name/Value	Description	Def/FbEq16
	IPC	IPC enabled. See <i>Intelligent pump control (IPC)</i> on page 120.	1
	PFC	PFC enabled. One pump at a time is controlled by the drive. The remaining pumps are direct-on-line pumps that are started and stopped by the drive logic. The frequency (group 28 <i>Frequency reference chain</i>) / speed (group 22 <i>Speed reference selection</i>) reference must be defined as PID for the PFC functionality to work properly. See <i>Single pump and fan control (PFC/SPFC)</i> on page 132.	2
	SPFC	SPFC enabled. See section <i>Soft pump and fan control (SPFC)</i> on page 133.	3
76.22	<i>Multipump node number</i>	Node number of the drive on inverter-to-inverter link. Note: <ul style="list-style-type: none"> Each drive on the link has a unique node number. Node numbers of the drives must be sequential starting from 1, so that if there are, for example, four nodes, they must be 1, 2, 3 and 4. If the drive is not given a priority class, the node number is also used in determining the starting order of the pumps. 	0
	0	No communication.	
	1...8	IPC node number.	
76.23	<i>Master enable</i>	Selects if this pump operate as a master drive of the IPC system. The master drive must have sensor connection in order to control the process.	<i>Enabled</i>
	Disabled	The drive can only be a follower on a inverter-to-inverter link.	0
	Enabled	The drive can be a master on a inverter-to-inverter link.	1
	<i>Other [bit]</i>	Source selection (see <i>Terms and abbreviations</i> on page 358). Allows connection to any bit source. For example AI supervision can be connected via parameter 04.40 by selecting an appropriate warning to any available bit.	
76.24	<i>IPC communication port</i>	Multipump feature can be used over embedded fieldbus interface, or fieldbus adapter interface with FMBA-01 adapter. Using the FMBA-01 adapter allows embedded fieldbus to be used for other purposes, for example, BACnet MS/TP connection to building automation system. If parameters have been incorrectly defined, the drive generates warning <i>A6E7 IPC configuration warning</i> .	<i>EFB</i>
	EFB	Embedded fieldbus interface is used for IPC communication. Set parameter 76.21 <i>Multipump configuration</i> to value <i>IPC</i> and parameter 58.01 <i>Protocol enable</i> to value <i>None / IPC communication</i> .	0
	FBA	Fieldbus adapter interface with FMBA-01 adapter is used for IPC communication. Connect FMBA-01 adapter to slot 1. Set parameter 50.01 <i>FBA A enable</i> to value <i>Disable</i> .	1
76.25	<i>Number of motors</i>	Total number of motors used in the application, including the motor connected directly to the drive.	1
	1...8	Number of motors. For PFC 1...6, for IPC 1...8.	1 = 1
76.26	<i>Min number of motors allowed</i>	Minimum number of motors running simultaneously.	1

No.	Name/Value	Description	Def/FbEq16
	0...8	Minimum number of motors. When using the Intelligent Pump Control (IPC) functionality, the minimum value is 1. For PFC 0...6, for IPC 1...8.	1 = 1
76.27	<i>Max number of motors allowed</i>	Maximum number of motors running simultaneously.	1
	1...8	Maximum number of motors. For PFC 1...6, for IPC 1...8.	1 = 1
76.30	<i>Start point 1</i>	<p>Defines the start speed or frequency (Hz/rpm) for the first auxiliary motor. As the motor speed or frequency exceeds the limit defined by this parameter, a new auxiliary motor is started.</p> <p>To avoid nuisance starts of the second auxiliary motor, the speed of the variable speed motor should be higher than the start speed for the duration defined by parameter 76.55 Start delay. If the speed decreases below the start speed, the auxiliary motor is not started.</p> <p>To maintain the process conditions during the start of the second auxiliary motor, a speed hold on time can be defined with parameter 76.57 PFC speed hold on. Certain pump types do not produce significant flow with low frequencies. The speed hold on time can be used to compensate the time needed to accelerate the second auxiliary motor to a speed where it produces flow. The start of the second auxiliary motor is not aborted if the speed of the first auxiliary motor decreases</p>	Vector: 1300 rpm; Scalar 48 Hz; 58 Hz (95.20 b0)
	0.00...32767.00 rpm/Hz	Speed/frequency	1 = 1 unit

No.	Name/Value	Description	Def/FbEq16
76.31	<i>Start point 2</i>	Defines the start speed or frequency (Hz/rpm) for the second auxiliary motor. See parameter <i>76.31 Start point 1</i> .	Vector: 1300 rpm; Scalar 48 Hz; 58 Hz (95.20 b0)
76.32	<i>Start point 3</i>	Defines the start speed or frequency (Hz/rpm) for the third auxiliary motor. See parameter <i>76.31 Start point 1</i> .	Vector: 1300 rpm; Scalar 48 Hz; 58 Hz (95.20 b0)
76.33	<i>Start point 4</i>	Defines the start speed or frequency (Hz/rpm) for the fourth follower pump/auxiliary motor. See parameter <i>76.30 Start point 1</i> .	Vector: 1300 rpm; Scalar 48 Hz; 58 Hz (95.20 b0)
76.34	<i>Start point 5</i>	Defines the start speed or frequency (Hz/rpm) for the fifth follower pump/auxiliary motor. See parameter <i>76.30 Start point 1</i> .	Vector: 1300 rpm; Scalar 48 Hz; 58 Hz (95.20 b0)
76.35	<i>Start point 6</i>	Defines the start speed or frequency (Hz/rpm) for the sixth follower pump/auxiliary motor. See parameter <i>76.30 Start point 1</i> . For IPC only.	Vector: 1300 rpm; Scalar 48 Hz; 58 Hz (95.20 b0)
76.36	<i>Start point 7</i>	Defines the start speed or frequency (Hz/rpm) for the seventh follower pump/auxiliary motor. See parameter <i>76.30 Start point 1</i> . For IPC only.	Vector: 1300 rpm; Scalar 48 Hz; 58 Hz (95.20 b0)
76.41	<i>Stop point 1</i>	Defines the stop speed or frequency (Hz/rpm) for the first auxiliary motor. When the speed or frequency of the motor connected directly to the drive falls below this value and one auxiliary motor is running, the stop delay defined by parameter <i>76.56 Stop delay</i> is started. If the speed is still at the same level or lower when the stop delay elapses, the first auxiliary motor stops. The running speed of the drive is increased by [<i>Start point 1 - Stop point 1</i>] after the auxiliary motor stops.	Vector: 800 rpm; Scalar 25 Hz; 30 Hz (95.20 b0)
	0.00...32767.00 rpm/Hz	Speed/frequency	1 = 1 unit
76.42	<i>Stop point 2</i>	Defines the stop speed or frequency (Hz/rpm) for the second auxiliary motor. See parameter <i>76.41 Stop point 1</i> .	Vector: 800 rpm; Scalar 25 Hz; 30 Hz (95.20 b0)

No.	Name/Value	Description	Def/FbEq16
76.43	<i>Stop point 3</i>	Defines the stop speed or frequency (Hz/rpm) for the third auxiliary motor. See parameter 76.41 Stop point 1 .	Vector: 800 rpm; Scalar 25 Hz; 30 Hz (95.20 b0)
76.44	<i>Stop point 4</i>	Defines the stop speed or frequency (Hz/rpm) for the fourth follower pump/auxiliary motor. See parameter 76.41 Stop point 1 .	Vector: 800 rpm; Scalar 25 Hz; 30 Hz (95.20 b0)
76.45	<i>Stop point 5</i>	Defines the stop speed or frequency (Hz/rpm) for the fifth follower pump/auxiliary motor. See parameter 76.41 Stop point 1 .	Vector: 800 rpm; Scalar 25 Hz; 30 Hz (95.20 b0)
76.46	<i>Stop point 6</i>	Defines the stop speed or frequency (Hz/rpm) for the sixth follower pump/auxiliary motor. See parameter 76.41 Stop point 1 . For IPC only	Vector: 800 rpm; Scalar 25 Hz; 30 Hz (95.20 b0)
76.47	<i>Stop point 7</i>	Defines the stop speed or frequency (Hz/rpm) for the seventh follower pump/auxiliary motor. See parameter 76.41 Stop point 1 . For IPC only	Vector: 800 rpm; Scalar 25 Hz; 30 Hz (95.20 b0)
76.55	<i>Start delay</i>	Defines the delay time for starting the auxiliary motors. See parameter 76.31 Start point 1 .	10.00 s
	0.00...12600.00 s	Time delay.	1 = 1 s
76.56	<i>Stop delay</i>	Defines the delay time for starting the auxiliary motors. See parameter 76.31 Stop point 1 .	10.00 s
	0.00...12600.00 s	Time delay.	1 = 1 s
76.57	<i>PFC speed hold on</i>	Hold time for auxiliary motor switch-on. See parameter 76.31 Start point 1 .	0.00 s
	0.00...1000.00 s	Time.	1 = 1 s
76.58	<i>PFC speed hold off</i>	Hold time for auxiliary motor switch-off. See parameter 76.31 Stop point 1 .	0.00 s
	0.00...1000.00 s	Time.	1 = 1 s
76.59	<i>PFC contactor delay</i>	Start delay for the motor that is directly controlled by the drive. This does not affect the starting of the auxiliary motors.  WARNING! There must always be a delay set if the motors are equipped with star-delta starters. The delay must be set longer than the time setting of the starter. After the motor is switched on by the relay output of the drive, there must be enough time for the star-delta starter to first switch to star and then back to delta before the motor is connected to the drive.	0.50 s
	0.20...600.00 s	Time delay.	1 = 1 s

No.	Name/Value	Description	Def/FbEq16
76.60	<i>PFC ramp acceleration time</i>	Defines the acceleration time for the drive motor speed compensation, when an auxiliary motor is stopped. This ramp time is also used for the drive motor to accelerate after an autochange has occurred. The parameter sets the ramp-up time as seconds from zero to maximum frequency (not from the previous reference to the new reference).	1.00 s
	0.00...1800.00 s	Time.	1 = 1 s
76.61	<i>PFC ramp deceleration time</i>	Defines the deceleration time for the drive motor speed compensation, when an auxiliary motor is started. This ramp time is also used for the drive motor to decelerate after an autochange has occurred. The parameter sets the ramp-up time as seconds from maximum to zero frequency (not from the previous reference to the new reference).	1.00 s
	0.00...1800.00 s	Time.	1 = 1 s
76.62	<i>IPC smooth acceleration time</i>	Defines the ramp time of a new starting pump. A pump that is started by current master follows the speed until all the pumps rotate at the same speed and master role is changed. The smooth acceleration time must be longer than the time defined with parameter 40.33 Set 1 integration time .	20.00 s
	3.00...1800.00 s	IPC smooth acceleration time in seconds.	1 = 1 s
76.63	<i>IPC smooth deceleration time</i>	Defines the ramp time that is used to stop the pump. A pump that is stopped by current master follows the speed until it is stopped completely. The smooth deceleration time must be longer than the time defined with parameter 40.33 Set 1 integration time .	20.00 s
	3.00...1800.00 s	IPC smooth deceleration time in seconds.	1 = 1 s
76.64	<i>Run permissive timeout</i>	Defines the maximum time the drive waits between it receives a command to start and the condition defined in parameter 20.40 Run permissive to be satisfied. The drive trips on fault D40C Multipump run permissive timeout if the timer expires before it receives the run permissive. The next pump is started if available. Setting this parameter to 0 prevents a command to start without the run permissive satisfied (i.e. parameter 76.02 Multipump system status remains at <i>Not ready</i> while the permissive is not satisfied).	0.0 s
	0.00...300.00 s	The maximum delay.	1 = 1 s
76.70	<i>PFC Autochange</i>	Defines the way the autochange is triggered. In all cases except Even wear , the start order is moved one step forward each time the autochange occurs. If the start order initially is 1-2-3-4, after the first autochange the order will be 2-3-4-1, etc. For Even wear , the start order will be determined so that the running times of all motors remain within the defined limit. If IPC is used with values Not selected or Selected , the system will automatically select the Even wear value. Note: Autochange only occurs when the speed of the drive is below the speed defined by parameter 76.73 Autochange level . See also section Autochange on page 135	Even wear (for IPC) Not selected (for PFC)
	Not selected	Autochange disabled.	0

No.	Name/Value	Description	Def/FbEq16
	Selected	Rising edge starts the autochange if autochange conditions are met.	1
	DI1	Autochange triggered by the rising edge of digital input DI1 (<i>10.02 DI delayed status</i> , bit 0).	2
	DI2	Autochange triggered by the rising edge of digital input DI2 (<i>10.02 DI delayed status</i> , bit 1).	3
	DI3	Autochange triggered by the rising edge of digital input DI3 (<i>10.02 DI delayed status</i> , bit 2).	4
	DI4	Autochange triggered by the rising edge of digital input DI4 (<i>10.02 DI delayed status</i> , bit 3).	5
	DI5	Autochange triggered by the rising edge of digital input DI5 (<i>10.02 DI delayed status</i> , bit 4).	6
	DI6	Autochange triggered by the rising edge of digital input DI6 (<i>10.02 DI delayed status</i> , bit 5).	7
	Timed function 1	Autochange triggered by timed function 1 (bit 0 of <i>34.01 Timed functions status</i> (see page 496)).	8
	Timed function 2	Autochange triggered by timed function 2 (bit 1 of <i>34.01 Timed functions status</i> (see page 496)).	9
	Timed function 3	Autochange triggered by timed function 3 (bit 2 of <i>34.01 Timed functions status</i> (see page 496)).	10
	Fixed interval	Autochange is done when the interval determined in the parameter <i>76.71 PFC Autochange interval</i> has elapsed.	11
	All stop	Autochange is done when all the motors are stopped. The PID sleep feature (parameters <i>40.43 Set 1 sleep level ... 40.48 Set 1 wake-up delay</i>) must be used for the drive to stop when the process demand is low.	12
	Even wear	The running time of the motors are balanced by the drive. When the difference in running time between the motors with the least and most running hours exceeds the time defined by parameter <i>76.72 Maximum wear imbalance</i> , the autochange occurs. The running hours of the motors can be found in group <i>77 Multipump maintenance and monitoring</i> .	13
	<i>Other [bit]</i>	Source selection (see <i>Terms and abbreviations</i> on page 358).	-
<i>76.71</i>	<i>PFC Autochange interval</i>	Specifies the interval that is used in setting <i>Fixed interval</i> of parameter <i>76.70 PFC Autochange</i> .	1.00 h
	0.00... 100000.00 h	Time.	1 = 1 h
<i>76.72</i>	<i>Maximum wear imbalance</i>	Specifies the maximum wear imbalance, or difference in running times between any motor, used by the <i>Even wear</i> setting of parameter <i>76.70 PFC Autochange</i> .	10.00 h
	0.00...1000000.00 h	Time.	1 = 1 h
<i>76.73</i>	<i>Autochange level</i>	Upper speed limit for the Autochange to occur. The Autochange occurs when: <ul style="list-style-type: none"> the condition defined in <i>76.70 PFC Autochange</i> is fulfilled and, the speed of the drive motor <i>01.03 Motor speed %</i> is below the speed limit defined in this parameter. Note: When the value is selected as 0%, this speed limit check is disabled.	100.0%

No.	Name/Value	Description	Def/FbEq16
	0.0...300.0%	Speed/frequency in percentage of the nominal speed or frequency of the drive motor.	1 = 1%
76.74	<i>Autochange auxiliary PFC</i>	Selects whether only auxiliary motors or all motors are included in the Autochange function.	<i>Aux motors only</i>
	All motors	All motors, including the one connected to the drive participates in the autochange. The Autochange logic will connect the drive to each of the motors according to setting of parameter <i>76.70 PFC Autochange</i> . Note: The first motor (PFC1) also requires the appropriate hardware contactor connections and PFC1 must be defined in one of the relay output source parameters.	0
	Aux motors only	Only auxiliary (direct-on-line) motors are affected by the autochange function. Note: PFC1 refers to the motor that is fixed to the drive and must not be selected in any of the relay output source parameters. Only the starting order of the auxiliary motors will be rotated.	1
76.76	<i>Max stationary time</i>	Defines the maximum time that a low priority pump can be stationary. The IPC system uses pump priorities to start/stop the pumps. This parameter sets the upper limit for stationary time so that the pump blockage can be avoided.	0.0 h
	0.0...214748368.0 h	Maximum stationary time in hours.	1 = 1 h
76.77	<i>Pump priority</i>	Selects the priority of the pump in an IPC system. Note: Parameter <i>76.76 Max stationary time</i> defines the maximum time that a low priority pump can be stationary.	<i>Normal</i>
	High	High priority pump. The IPC system prefers high priority pump.	1
	Normal	Normal priority pump.	3
	Low	Low priority pump. The low priority pump runs as little as possible. It is started only when the demand requires full pumping capacity.	5
76.81	<i>PFC 1 interlock</i>	Defines if the PFC motor 1 can be started. An interlocked PFC motor cannot be started. 0 = Interlocked (not available) 1 = Available.	<i>Available. PFC motor is available</i>
	Interlocked. PFC motor is not in use	PFC motor is interlocked and not available.	0
	Available. PFC motor is available	PFC motor is available.	1
	DI1	Digital input DI1 (<i>10.02 DI delayed status</i> , bit 0).	2
	DI2	Digital input DI2 (<i>10.02 DI delayed status</i> , bit 1).	3
	DI3	Digital input DI3 (<i>10.02 DI delayed status</i> , bit 2).	4
	DI4	Digital input DI4 (<i>10.02 DI delayed status</i> , bit 3).	5
	DI5	Digital input DI5 (<i>10.02 DI delayed status</i> , bit 4).	6
	DI6	Digital input DI6 (<i>10.02 DI delayed status</i> , bit 5).	7
	Timed function 1	Bit 0 of <i>34.01 Timed functions status</i> (see page 496).	8
	Timed function 2	Bit 1 of <i>34.01 Timed functions status</i> (see page 496).	9
	Timed function 3	Bit 2 of <i>34.01 Timed functions status</i> (see page 496).	10

No.	Name/Value	Description	Def/FbEq16															
	<i>Other [bit]</i>	Source selection (see <i>Terms and abbreviations</i> on page 358).	-															
76.82	<i>PFC 2 interlock</i>	See parameter <i>76.81 PFC 1 interlock</i> .	<i>Available. PFC motor is available</i>															
76.83	<i>PFC 3 interlock</i>	See parameter <i>76.81 PFC 1 interlock</i> .	<i>Available. PFC motor is available</i>															
76.84	<i>PFC 4 interlock</i>	See parameter <i>76.81 PFC 1 interlock</i> .	<i>Available. PFC motor is available</i>															
76.85	<i>PFC 5 interlock</i>	See parameter <i>76.81 PFC 1 interlock</i> .	<i>Available. PFC motor is available</i>															
76.86	<i>PFC 6 interlock</i>	See parameter <i>76.81 PFC 1 interlock</i> .	<i>Available. PFC motor is available</i>															
76.95	<i>Regulator bypass control</i>	Defines if direct-on-line pumps are automatically started and stopped. This setting can be used in applications with a low number of sensors and low accuracy requirements.	<i>Disable</i>															
	Disable	Automatic starting and stopping is disabled.	0															
	Enable	Automatic starting and stopping is enabled.	1															
	<i>Other [bit]</i>	Source selection (see <i>Terms and abbreviations</i> on page 358).	-															
76.101	<i>IPC parameter synchronization</i>	Defines parameter synchronization in IPC system.	<i>Enable</i>															
	Disable	Parameter synchronization is disabled.	1															
	Enable	Parameter synchronization is enabled.	2															
76.102	<i>IPC synchronization settings</i>	Selects the settings that are synchronized between drives in inverter-to-inverter communication bus. The process PID and IPC parameters are synchronized. Note: This parameter does not synchronize AI parameters.	0b0110															
<table border="1"> <thead> <tr> <th>Bit</th> <th>Name</th> <th>Value</th> </tr> </thead> <tbody> <tr> <td>0</td> <td>AI parameters</td> <td>Parameter group <i>12 Standard AI</i>.</td> </tr> <tr> <td>1</td> <td>Process PID set 1 parameters</td> <td>Parameter group <i>40 Process PID set 1</i>. <i>Parameters 19.11 Ext1/Ext2 selection, 20.06 Ext2 commands, 20.08 Ext2 in1 source, 22.18 Ext2 speed ref1 and 28.15 Ext2 frequency ref1.</i></td> </tr> <tr> <td>2</td> <td>IPC parameters</td> <td>Parameter group <i>76 Multipump configuration and 77 Multipump maintenance and monitoring</i>.</td> </tr> <tr> <td>3...15</td> <td>Reserved</td> <td></td> </tr> </tbody> </table>				Bit	Name	Value	0	AI parameters	Parameter group <i>12 Standard AI</i> .	1	Process PID set 1 parameters	Parameter group <i>40 Process PID set 1</i> . <i>Parameters 19.11 Ext1/Ext2 selection, 20.06 Ext2 commands, 20.08 Ext2 in1 source, 22.18 Ext2 speed ref1 and 28.15 Ext2 frequency ref1.</i>	2	IPC parameters	Parameter group <i>76 Multipump configuration and 77 Multipump maintenance and monitoring</i> .	3...15	Reserved	
Bit	Name	Value																
0	AI parameters	Parameter group <i>12 Standard AI</i> .																
1	Process PID set 1 parameters	Parameter group <i>40 Process PID set 1</i> . <i>Parameters 19.11 Ext1/Ext2 selection, 20.06 Ext2 commands, 20.08 Ext2 in1 source, 22.18 Ext2 speed ref1 and 28.15 Ext2 frequency ref1.</i>																
2	IPC parameters	Parameter group <i>76 Multipump configuration and 77 Multipump maintenance and monitoring</i> .																
3...15	Reserved																	
	0000h...FFFFh	Synchronization settings	1 = 1															
76.105	<i>IPC synchronization checksum</i>	Displays the calculated parameter checksum (CRC) of the parameter groups selected with parameter <i>76.102 IPC synchronization settings</i> . If the value of this parameter is same on all the drives, then the configuration is also synchronized correctly.	-															
	0000h...FFFFh	Checksum.	1 = 1															

No.	Name/Value	Description	Def/FbEq16
77 Multipump maintenance and monitoring			
77.10	<i>PFC runtime change</i>	Enables the reset, or arbitrary setting, of <i>77.11 Pump/fan 1 running time</i> <i>77.18 Pump 8 running time</i> .	<i>Done</i>
	Done	The parameter automatically reverts back to this value.	0
	Set any PFC run time	Enables the setting of <i>77.11 Pump/fan 1 running time</i> <i>77.18 Pump 8 running time</i> .	1
	Reset PFC1 run time	Resets parameter <i>77.11 Pump/fan 1 running time</i> .	2
	Reset PFC2 run time	Resets parameter <i>77.12 Pump/fan 2 running time</i> .	3
	Reset PFC3 run time	Resets parameter <i>77.13 Pump/fan 3 running time</i> .	4
	Reset PFC4 run time	Resets parameter <i>77.14 Pump/fan 4 running time</i> .	4
	Reset PFC5 run time	Resets parameter <i>77.15 Pump/fan 5 running time</i>	
	Reset PFC6 run time	Resets parameter <i>77.16 Pump/fan 6 running time</i> .	7
77.11	<i>Pump/fan 1 running time</i>	Running time counter of pump/fan 1. Can be set or reset by parameter <i>77.10 PFC runtime change</i> .	0.00 h
	0.00... 42949672.95 h	Time	1 = 1 h
77.12	<i>Pump/fan 2 running time</i>	See parameter <i>77.11 Pump/fan 1 running time</i> .	0.00 h
77.13	<i>Pump/fan 3 running time</i>	See parameter <i>77.11 Pump/fan 1 running time</i> .	0.00 h
77.14	<i>Pump/fan 4 running time</i>	See parameter <i>77.11 Pump/fan 1 running time</i> .	0.00 h
77.15	<i>Pump/fan 5 running time</i>	See parameter <i>77.11 Pump/fan 1 running time</i> .	0.00 h
77.16	<i>Pump/fan 6 running time</i>	See parameter <i>77.11 Pump/fan 1 running time</i> .	0.00 h
77.17	<i>Pump 7 running time</i>	Running time counter of pump 7. For IPC only.	0.00 h
77.18	<i>Pump 8 running time</i>	Running time counter of pump 8. For IPC only.	0.00 h
77.20	<i>IPC online pumps</i>	Displays the pumps which can establish connection through inverter-to-inverter communication. For example, in a three pump system, drive 1 and drive 2 can see each other but drive 3 cannot see other drives. Drive 1 = 0011b, Drive 2 = 0011b, Drive 3 = 0100b	-

No.	Name/Value	Description	Def/FbEq16																														
		<table border="1"> <thead> <tr> <th>Bit</th> <th>Name</th> <th>Descriptions</th> </tr> </thead> <tbody> <tr> <td>0</td> <td>Node 1</td> <td>Pump 1 is online.</td> </tr> <tr> <td>1</td> <td>Node 2</td> <td>Pump 2 is online.</td> </tr> <tr> <td>2</td> <td>Node 3</td> <td>Pump 3 is online.</td> </tr> <tr> <td>3</td> <td>Node 4</td> <td>Pump 4 is online.</td> </tr> <tr> <td>4</td> <td>Node 5</td> <td>Pump 5 is online.</td> </tr> <tr> <td>5</td> <td>Node 6</td> <td>Pump 6 is online.</td> </tr> <tr> <td>6</td> <td>Node 7</td> <td>Pump 7 is online.</td> </tr> <tr> <td>7</td> <td>Node 8</td> <td>Pump 8 is online.</td> </tr> <tr> <td>8...15</td> <td>Reserved</td> <td></td> </tr> </tbody> </table>	Bit	Name	Descriptions	0	Node 1	Pump 1 is online.	1	Node 2	Pump 2 is online.	2	Node 3	Pump 3 is online.	3	Node 4	Pump 4 is online.	4	Node 5	Pump 5 is online.	5	Node 6	Pump 6 is online.	6	Node 7	Pump 7 is online.	7	Node 8	Pump 8 is online.	8...15	Reserved		
Bit	Name	Descriptions																															
0	Node 1	Pump 1 is online.																															
1	Node 2	Pump 2 is online.																															
2	Node 3	Pump 3 is online.																															
3	Node 4	Pump 4 is online.																															
4	Node 5	Pump 5 is online.																															
5	Node 6	Pump 6 is online.																															
6	Node 7	Pump 7 is online.																															
7	Node 8	Pump 8 is online.																															
8...15	Reserved																																
	0000h...FFFFh	Pump status	1 = 1																														
77.21	<i>IPC comm loss status</i>	<p>Displays the drives communication loss status. You can override default communication loss actions by setting start interlock or constant speed based on the bit values.</p> <p>Note: Bits will reset to zero when communication is restored.</p> <table border="1"> <thead> <tr> <th>Bit</th> <th>Name</th> <th>Descriptions</th> </tr> </thead> <tbody> <tr> <td>0</td> <td>Running master in comm loss</td> <td>The running master drive has lost the connection to other drives. By default, this drive continues as a running master.</td> </tr> <tr> <td>1</td> <td>Running follower (master enable) in comm loss</td> <td>The running follower drive which is set as master enabled drive has lost the connection to other drives. By default, this drive will be a master (offline).</td> </tr> <tr> <td>2</td> <td>Standby master enabled in comm loss</td> <td>The master enabled drive which is in standby mode has lost the connection to other drives. By default, this drive remains in standby mode if already running drives can maintain the process.</td> </tr> <tr> <td>3</td> <td>Standby master disabled in comm loss</td> <td>The master disabled drive which is in standby mode has lost the connection to other drives. By default, this drive remains in standby mode.</td> </tr> <tr> <td>4...15</td> <td>Reserved</td> <td></td> </tr> </tbody> </table>	Bit	Name	Descriptions	0	Running master in comm loss	The running master drive has lost the connection to other drives. By default, this drive continues as a running master.	1	Running follower (master enable) in comm loss	The running follower drive which is set as master enabled drive has lost the connection to other drives. By default, this drive will be a master (offline).	2	Standby master enabled in comm loss	The master enabled drive which is in standby mode has lost the connection to other drives. By default, this drive remains in standby mode if already running drives can maintain the process.	3	Standby master disabled in comm loss	The master disabled drive which is in standby mode has lost the connection to other drives. By default, this drive remains in standby mode.	4...15	Reserved		-												
Bit	Name	Descriptions																															
0	Running master in comm loss	The running master drive has lost the connection to other drives. By default, this drive continues as a running master.																															
1	Running follower (master enable) in comm loss	The running follower drive which is set as master enabled drive has lost the connection to other drives. By default, this drive will be a master (offline).																															
2	Standby master enabled in comm loss	The master enabled drive which is in standby mode has lost the connection to other drives. By default, this drive remains in standby mode if already running drives can maintain the process.																															
3	Standby master disabled in comm loss	The master disabled drive which is in standby mode has lost the connection to other drives. By default, this drive remains in standby mode.																															
4...15	Reserved																																
	0000h...FFFFh	Communication loss status	1 = 1																														

No.	Name/Value	Description	Def/FbEq16
80 Flow calculation		Actual flow calculation. Note: Parameters are dynamically hidden based on selection of flow calculation mode. Parameters are visible according to the selection of parameter 80.13 Flow feedback function .	
80.01	Actual flow	Actual system flow that is either calculated from the pressure difference, measured directly or estimated from the pump curves. The calculation method is selected with parameter 80.13 Flow feedback function . See control chain diagram PID flow calculation on page 373. Note: By default the flow unit will be m ³ /h. However, the unit can be changed according to the parameter 81.21 Flow unit .	-
	-200000.00... 200000.00 flow units	Actual flow.	1 = 1 flow units
80.02	Actual flow	Shows the percentage of parameter 80.01 Actual flow from 80.15 Maximum flow .	-
	-100.00...100.00%	Flow percentage of maximum flow.	100 = 1%
80.03	Total volume	Shows the cumulative calculated volume that has been pumped since the last 80.29 Total volume reset . Notes: <ul style="list-style-type: none"> By default the unit will be m³. However, the unit can be changed according to the parameter 81.21 Flow unit. This value is scaled by 80.20 Volume unit multiplier. If 80.20 is set to 1000, the true volume is 1000 times greater than the value displayed. 	-
	0.00... 21474836.00 units	Total calculated volume.	-
80.04	Specific energy	Shows the ratio of pump flow rate and power input. Note: By default the flow unit will be m ³ /kWh. However, the unit can be changed according to the parameter 81.21 Flow unit .	-
	0.00... 32767.95 units	Specific energy of the pump.	1 = 1 units
80.05	Estimated pump head	Shows the estimated head produced by the pump. Note: By default the unit will be m. However, the unit can be changed according to the parameter 81.22 Length unit .	-
	0.00...32767.00 m	Estimated pump head.	1 = 1 m
80.11	Flow feedback 1 source	Selects the source for the flow feedback 1.	<i>Not selected</i>
	Not selected	Feedback not used.	0
	AI1 scaled	12.12 AI1 scaled value (see page 400).	1
	AI2 scaled	12.22 AI2 scaled value (see page 402).	2
	Freq in scaled	11.39 Freq in 1 scaled value (see page 394).	3
	AI1 percent	12.101 AI1 percent value (see page 403).	8
	AI2 percent	12.102 AI2 percent value (see page 403).	9
	Feedback data storage	40.91 Feedback data storage (see page 537).	10
	Reserved		11...12

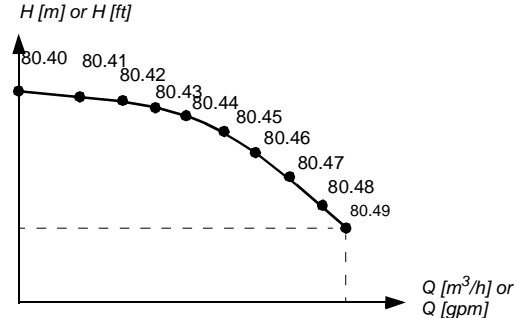
No.	Name/Value	Description	Def/FbEq16
	AI3 scaled	15.52 AI3 scaled value (see page 507).	13
	AI4 scaled	15.62 AI4 scaled value (see page 509).	14
	AI5 scaled	15.72 AI5 scaled value (see page 511).	15
	AI3 percent	15.53 AI3 percent value (see page 507).	16
	AI4 percent	15.63 AI4 percent value (see page 509).	17
	AI5 percent	15.73 AI5 scaled value (see page 511).	18
	<i>Other</i>	Source selection (see Terms and abbreviations on page 358).	-
80.12	Flow feedback 2 source	Selects the source for the flow feedback 2. For the selections, see parameter 80.11 Flow feedback 1 source .	<i>Not selected</i>
80.13	Flow feedback function	Selects a function between the flow feedback sources selected by parameters 80.11 Flow feedback 1 source and 80.12 Flow feedback 2 source . The result of the function (for any selection) is multiplied by parameter 80.14 Flow feedback multiplier .	<i>In1</i>
	In1	Use 80.11 Flow feedback 1 source directly as the flow value.	0
	In2	Use 80.12 Flow feedback 2 source directly as the flow value.	1
	Reserved		2...7
	sqrt(In1)	Flow is calculated as a square root of a differential pressure measurement: $k\sqrt{\Delta P}$ The differential pressure value is selected with 80.11 Flow feedback 1 source .	8
	sqrt(In1-In2)	Flow is calculated as a square root of two measured absolute pressure measurements: $k\sqrt{(P_1 - P_2)}$ The pressure measurement sources are selected with 80.11 Flow feedback 1 source and 80.12 Flow feedback 2 source .	9
	HQ curve	The HQ curve is used for flow calculation. You can configure pressure sensor settings with parameter group 81 Sensor settings . The figure below shows the HQ performance curve of the pump for the flow calculation function. 	100

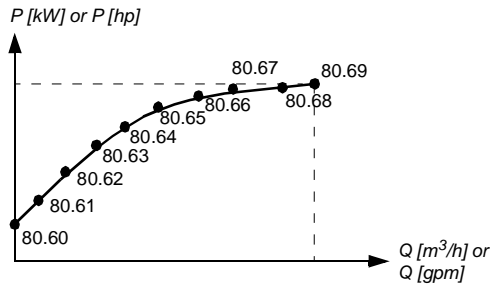
No.	Name/Value	Description	Def/FbEq16
	PQ curve	<p>The PQ curve is used for flow calculation. You can configure pressure sensor settings with parameter group 81 Sensor settings. The figure below shows the PQ performance curve of the pump for the flow calculation function.</p> 	101
80.14	Flow feedback multiplier	Defines the multiplier (k) used with the flow calculation. The output value of 80.13 Flow feedback function is multiplied by this value.	1.00
	-200000.00... 200000.00	Multiplier.	1 = 1
80.15	Maximum flow	<p>Defines the nominal maximum flow of the system. This value is used to calculate the actual flow percentage value so that the value 100% for 80.02 corresponds to the value of this parameter.</p> <p>Note: By default the flow unit will be m³/h. However, the unit can be changed according to the parameter 81.21 Flow unit.</p>	1000.00 m ³ /h
	-200000.00... 200000.00 m ³ /h	Limit for maximum flow protection.	1 = 1 m ³ /h
80.16	Minimum flow	<p>Defines the nominal minimum flow of the system.</p> <p>Note: By default the flow unit will be m³/h. However, the unit can be changed according to the parameter 81.21 Flow unit.</p>	1.00 m ³ /h
	-200000.00... 200000.00 m ³ /h	Limit for minimum flow protection.	1 = 1 m ³ /h
80.17	Maximum flow protection	Selects the action for maximum flow protection function. See parameters 22.41 Speed ref safe and 28.41 Frequency ref safe .	<i>No action</i>
	No action	Maximum flow protection is disabled.	0
	Warning	Drive generates warning D50C Maximum flow protection .	1
	Fault	Drive trips on fault D406 Maximum flow protection .	2
	Speed ref safe	Speed reference safe is activated.	3
80.18	Minimum flow protection	Selects the action for minimum flow protection function. See parameters 22.41 Speed ref safe and 28.41 Frequency ref safe .	<i>No action</i>
	No action	Minimum flow protection is disabled.	0
	Warning	Drive generates warning D50D Minimum flow protection .	1
	Fault	Drive trips on fault D407 Minimum flow protection .	2
	Speed ref safe	Speed reference safe is activated.	3

No.	Name/Value	Description	Def/FbEq16
80.19	<i>Flow check delay</i>	Defines the time after motor start when the flow protection is active.	5.00 s
	0.00...3600.00 s	Flow check delay.	1 = 1 s
80.20	<i>Volume unit multiplier</i>	The cumulative calculated volume is divided by this value before it is shown in 80.03 Total volume and 80.08 Incremental volume . This is useful for applications with a very large flow to ensure the limit of 21,474,836.00 is not reached.	1
	1 or 1000	The volume unit multiplier.	1 = 1
80.21	<i>Flow pump nominal speed</i>	Definition speed of the pump curve used, normally the pump's nominal speed. Used as reference speed for sensorless flow calculation, see section Sensorless flow calculation on page 156. Only visible in vector control mode.	Value of 99.09 Motor nominal speed
	0.0...30000.0 rpm	Pump speed.	1 = 1 rpm
80.22	<i>Pump inlet diameter</i>	Defines the pump inlet pipe diameter. Note: By default the unit will be m. However, the unit can be changed according to the parameter 81.22 Length unit .	0.100 m
	0.010... 32767.000 length units	Pump inlet pipe diameter.	1 = 1 length unit
80.23	<i>Pump outlet diameter</i>	Defines the pump outlet pipe diameter. Note: By default the unit will be m. However, the unit can be changed according to the parameter 81.22 Length unit .	0.100 m
	0.010... 32767.000 length units	Pump outlet pipe diameter.	1 = 1 length unit
80.26	<i>Calculation minimum speed</i>	Defines the speed limit below which flow is not calculated.	5.00 Hz
	0.00...32767.00 Hz/rpm	Minimum speed limit for flow calculation.	1 = 1 unit
80.28	<i>Density</i>	Defines the density of the fluid to be pumped for the flow calculation function. Note: By default the unit will be kg/m ³ . However, the unit can be changed according to the parameter 81.23 Density unit .	1000.00 kg/m ³
	0.00... 32767.00 density units	Fluid density.	1 = 1 density unit
80.29	<i>Total volume reset</i>	Resets signal 80.03 Total volume .	<i>Not selected</i>
	Not selected	Total volume reset is not selected.	0
	Reset	Resets 80.03 Total volume to zero and sets 80.31 Total volume reset date and 80.32 Total volume reset time . Note: The value reverts automatically to <i>Not selected</i> after the volume is reset.	1
	Other	Source selection (see Terms and abbreviations on page 358). Note: The selected signal must pulse for the volume to begin accumulating; a maintained high signal will keep the volume at zero.	-
80.31	<i>Total volume reset date</i>	Displays the date when signal 80.03 Total volume was reset to zero.	1/1/1980
	-	The total volume reset date.	-

No.	Name/Value	Description	Def/FbEq16
80.32	<i>Total volume reset time</i>	Displays the time when signal <i>80.03 Total volume</i> was reset to zero.	00:00:00
-	-	The total volume reset time.	-
80.40	<i>H curve H1</i>	Defines the head at point 1 of the HQ and QH performance curves. Note: By default the unit will be m. However, the unit can be changed according to the parameter <i>81.22 Length unit</i> .	0.00 length units
	0.00...32767.00 length units	Head at point 1 of the HQ and QH curves.	1 = 1 length unit
80.41	<i>H curve H2</i>	Defines the head at point 2 of the H performance curve. See parameter <i>80.40 H curve H1</i> (page 592).	0.00 length units
80.42	<i>H curve H3</i>	Defines the head at point 3 of the H performance curve. See parameter <i>80.40 H curve H1</i> (page 592).	0.00 length units
80.43	<i>H curve H4</i>	Defines the head at point 4 of the H performance curve. See parameter <i>80.40 H curve H1</i> (page 592).	0.00 length units
80.44	<i>H curve H5</i>	Defines the head at point 5 of the H performance curve. See parameter <i>80.40 H curve H1</i> (page 592).	0.00 length units
80.45	<i>H curve H6</i>	Defines the head at point 6 of the H performance curve. See parameter <i>80.40 H curve H1</i> (page 592).	0.00 length units
80.46	<i>H curve H7</i>	Defines the head at point 7 of the H performance curve. See parameter <i>80.40 H curve H1</i> (page 592).	0.00 length units
80.47	<i>H curve H8</i>	Defines the head at point 8 of the H performance curve. See parameter <i>80.40 H curve H1</i> (page 592).	0.00 length units
80.48	<i>H curve H9</i>	Defines the head at point 9 of the H performance curve. See parameter <i>80.40 H curve H1</i> (page 592).	0.00 length units
80.49	<i>H curve H10</i>	Defines the head at point 10 of the H performance curve. See parameter <i>80.40 H curve H1</i> (page 592).	0.00 length units
80.50	<i>P curve P1</i>	Defines the power input of pump at point 1 on the P performance curve. Note: By default the unit will be kW. However, the unit can be changed according to the parameter <i>96.16 Unit selection</i> bit 00 <i>Power unit</i> .	0.00 kW
	0.00...32767.00 kW or Hp	Power input of pump at point 1.	1 = 1 unit
80.51	<i>P curve P2</i>	Defines the power input of pump at point 2 on the PQ and HQ performance curves. See parameter <i>80.50 P curve P1</i> (page 592).	0.00 kW
80.52	<i>P curve P3</i>	Defines the power input of pump at point 3 on the PQ and HQ performance curves. See parameter <i>80.50 P curve P1</i> (page 592).	0.00 kW
80.53	<i>P curve P4</i>	Defines the power input of pump at point 4 on the PQ and HQ performance curves. See parameter <i>80.50 P curve P1</i> (page 592).	0.00 kW
80.54	<i>P curve P5</i>	Defines the power input of pump at point 5 on the PQ and HQ performance curves. See parameter <i>80.50 P curve P1</i> (page 592).	0.00 kW
80.55	<i>P curve P6</i>	Defines the power input of pump at point 6 on the PQ and HQ performance curves. See parameter <i>80.50 P curve P1</i> (page 592).	0.00 kW

No.	Name/Value	Description	Def/FbEq16
80.56	<i>P curve P7</i>	Defines the power input of pump at point 7 on the PQ and HQ performance curves. See parameter <i>80.50 P curve P1</i> (page 592).	0.00 kW
80.57	<i>P curve P8</i>	Defines the power input of pump at point 8 on the PQ and HQ performance curves. See parameter <i>80.50 P curve P1</i> (page 592).	0.00 kW
80.58	<i>P curve P9</i>	Defines the power input of pump at point 9 on the PQ and HQ performance curves. See parameter <i>80.50 P curve P1</i> (page 592).	0.00 kW
80.59	<i>P curve P10</i>	Defines the power input of pump at point 10 on the PQ and HQ performance curves. See parameter <i>80.50 P curve P1</i> (page 592).	0.00 kW
80.60	<i>Q value Q1</i>	Defines the flow rate at point 1 on the PQ and HQ performance curves. Note: By default the flow unit will be m ³ /h. However, the unit can be changed according to the parameter <i>81.21 Flow unit</i> .	0.00 units
	0.00... 200000.00 units	Flow rate at point 1 of the PQ curve.	1 = 1 unit
80.61	<i>Q value Q2</i>	Defines the flow rate at point 2 on the PQ and HQ performance curves. See parameter <i>80.60 Q value Q1</i> (page 593).	0.00 units
80.62	<i>Q value Q3</i>	Defines the flow rate at point 3 on the PQ and HQ performance curves. See parameter <i>80.60 Q value Q1</i> (page 593).	0.00 units
80.63	<i>Q value Q4</i>	Defines the flow rate at point 4 on the PQ and HQ performance curves. See parameter <i>80.60 Q value Q1</i> (page 593).	0.00 units
80.64	<i>Q value Q5</i>	Defines the flow rate at point 5 on the PQ and HQ performance curves. See parameter <i>80.60 Q value Q1</i> (page 593).	0.00 units
80.65	<i>Q value Q6</i>	Defines the flow rate at point 6 on the PQ and HQ performance curves. See parameter <i>80.60 Q value Q1</i> (page 593).	0.00 units
80.66	<i>Q value Q7</i>	Defines the flow rate at point 7 on the PQ and HQ performance curves. See parameter <i>80.60 Q value Q1</i> (page 593).	0.00 units
80.67	<i>Q value Q8</i>	Defines the flow rate at point 8 on the PQ and HQ performance curves. See parameter <i>80.60 Q value Q1</i> (page 593).	0.00 units
80.68	<i>Q value Q9</i>	Defines the flow rate at point 9 on the PQ and HQ performance curves. See parameter <i>80.60 Q value Q1</i> (page 593).	0.00 units
80.69	<i>Q value Q10</i>	Defines the flow rate at point 10 on the PQ and HQ performance curves. See parameter <i>80.60 Q value Q1</i> (page 593).	0.00 units
81 Sensor settings		Sensor settings for inlet and outlet pressure protection function.	
81.01	<i>Actual inlet pressure</i>	Shows the actual inlet pressure. Note: By default the parameter unit will be bar. However, the unit can be changed according to the parameter <i>81.20 Pressure unit</i> .	-

No.	Name/Value	Description	Def/FbEq16
	0.00...32767.00 pressure units	Actual inlet pressure.	1 = 1 pressure unit
81.02	<i>Actual outlet pressure</i>	Shows the actual outlet pressure. Note: By default the parameter unit will be bar. However, the unit can be changed according to the parameter 81.20 Pressure unit .	-
	0.00...32767.00 pressure units	Actual outlet pressure.	1 = 1 pressure unit
81.10	<i>Inlet pressure source</i>	Selects the primary source used for pump inlet pressure measurement.	<i>Not selected</i>
	Not selected	None.	0
	AI1 scaled	Parameter 12.12 AI1 scaled value .	1
	AI2 scaled	Parameter 12.22 AI2 scaled value .	2
	Freq in scaled	Parameter 11.39 Freq in 1 scaled value .	3
	AI1 percent	Parameter 12.101 AI1 percent value .	8
	AI2 percent	Parameter 12.102 AI2 percent value .	9
	Feedback data storage	Parameter 40.91 Feedback data storage .	10
	Reserved		11...12
	AI3 scaled	15.52 AI3 scaled value (see page 507).	13
	AI4 scaled	15.62 AI4 scaled value (see page 509).	14
	AI5 scaled	15.72 AI5 scaled value (see page 511).	15
	AI3 percent	15.53 AI3 percent value (see page 507).	16
	AI4 percent	15.63 AI4 percent value (see page 509).	17
	AI5 percent	15.73 AI5 scaled value (see page 511).	18
	<i>Other</i>	Source selection (see Terms and abbreviations on page 358).	-
81.11	<i>Outlet pressure source</i>	Selects the primary source used for pump outlet pressure measurement. For the available selections, see parameter 81.10 Inlet pressure source .	<i>Not selected</i>
81.12	<i>Sensors height difference</i>	Defines the height difference between inlet and outlet pressure sensors for flow calculation. Note: By default the unit will be m. However, the unit can be changed according to the parameter 81.22 Length unit .	0.00 length units
	0.00...32767.00 length units	Sensors height difference.	1 = 1 length unit
81.20	<i>Pressure unit</i>	Selects the unit of pressure.	<i>bar</i>
	bar	Pressure.	0
	kPa	Kilo pascal.	1
	psi	Pound per square inch.	2
	Pa	Pascal.	3
81.21	<i>Flow unit</i>	Selects the unit of flow. The selection also affects volume and specific energy units.	<i>m³/h</i>
	m ³ /h	Cubic meter per hour (volume unit is m ³).	0
	l/s	Liters per second (volume unit is l).	1
	gpm	US gallon per minute (volume unit is gal).	2

No.	Name/Value	Description	Def/FbEq16
81.22	<i>Length unit</i>	Selects the unit of estimated head points, sensors height difference and pump inlet/outlet diameters.	<i>meters</i>
	centimeters	Length unit in centimeter.	69
	meters	Length unit in meter.	72
	Inches	Length unit in inch.	73
	feet	Length unit in feet.	27
81.23	<i>Density unit</i>	Selects the unit of density.	<i>kg/m3</i>
	kg/m ³	Kilograms per cubic meter.	0
	kg/l	Kilograms per liter.	1
	lb/gal	Pounds per US gallon.	2
82 Pump protections			
		Settings for pump protection functions soft pipe fill and dry pump protection (dry run protection). See sections <i>Soft pipe fill</i> (page 155) and <i>Dry pump protection</i> (page 158).	
82.20	<i>Dry run protection</i>	Selects dry run protection mode. See section <i>Dry pump protection</i> (page 158).	<i>No action</i>
	No action	Dry run protection is disabled.	0
	Warning	Dry run protection generates warning <i>D50A Running dry</i> .	1
	Fault	Dry run protection generates fault <i>D404 Running dry</i> .	2
	Fault if running	Dry run protection generates a fault if the source signal is high when running.	3
82.21	<i>Dry run source</i>	Selects the source for dry run protection.	<i>Under load curve</i>
	Under load curve	Activates dry run protection (parameter <i>37.01 ULC output status word</i> , bit 0). See section <i>Diagnostics</i> (page 230).	0
	DI1	Digital input DI1.	1
	DI2	Digital input DI2.	2
	DI3	Digital input DI3.	3
	DI4	Digital input DI4.	4
	DI5	Digital input DI5.	5
	DI6	Digital input DI6.	6
	Supervision 1	Activates dry run protection.	7
	Supervision 2	Activates dry run protection.	8
	Supervision 3	Activates dry run protection.	9
82.25	<i>Soft pipe fill supervision</i>	Selects the drive action in case the system does not reach the setpoint in time defined with parameter <i>82.26 Time-out limit</i> . The time is calculated with the last reference change in parameter <i>40.03 Process PID setpoint actual</i> . See section <i>Soft pipe fill</i> (page 155).	<i>No action</i>
	No action	Soft pipe fill time-out is disabled.	0
	Warning	Soft pipe fill supervision function generates warning <i>D50B Pipe fill-timeout</i> .	1

No.	Name/Value	Description	Def/FbEq16
	Fault	Soft pipe fill supervision function generates fault <i>D405 Pipe fill-timeout</i> .	2
82.26	<i>Time-out limit</i>	Defines the delay time at which setpoint must be reached after last change in PID reference ramp output.	60.0 s
	0.0...1800.0 s	Time-out limit in seconds.	1 = 1 s
82.30	<i>Outlet minimum pressure protection</i>	Enables outlet minimum pressure protection function.	<i>Disabled</i>
	Disabled	Outlet minimum pressure protection function is disabled.	0
	Warning	Outlet minimum pressure protection function generates warning <i>D50E Outlet minimum pressure</i> when the outlet minimum pressure is below the level defined with parameter <i>82.31 Outlet minimum pressure warning level</i> for a time set in <i>82.45 Pressure check delay</i> .	1
	Fault	Outlet minimum pressure protection function generates fault <i>D408 Outlet minimum pressure</i> when the outlet minimum pressure is below the level defined with parameter <i>82.32 Outlet minimum pressure fault level</i> for a time set in parameter <i>82.45 Pressure check delay</i> .	2
	Warning/Fault	Outlet minimum pressure protection function first generates a warning when the pressure is below the level defined with parameter <i>82.31 Outlet minimum pressure warning level</i> for a time set in parameter <i>82.45 Pressure check delay</i> . If the pressure continues to fall below the level defined with parameter <i>82.32 Outlet minimum pressure fault level</i> , outlet minimum pressure fault is generated.	3
82.31	<i>Outlet minimum pressure warning level</i>	Defines the level at which drive should generate the outlet minimum pressure warning. Note: By default the parameter unit will be bar. However, the unit can be changed according to the parameter <i>81.20 Pressure unit</i> .	0.00 bar
	0.00...32767.00 bar	Outlet minimum pressure warning level.	1 = 1 bar
82.32	<i>Outlet minimum pressure fault level</i>	Defines the level at which drive should generate the outlet minimum pressure fault. Note: By default the parameter unit will be bar. However, the unit can be changed according to the parameter <i>81.20 Pressure unit</i> .	0.00 bar
	0.00...32767.00 bar	Outlet minimum pressure fault level.	1 = 1 bar
82.35	<i>Outlet maximum pressure protection</i>	Enables outlet maximum pressure protection function.	<i>Disabled</i>
	Disabled	Outlet maximum pressure protection is disabled.	0
	Warning	Outlet maximum pressure protection function generates warning <i>D50F Outlet maximum pressure</i> when the pressure is above the level defined with parameter <i>82.37 Outlet maximum pressure warning level</i> for a time set in parameter <i>82.45 Pressure check delay</i> .	1
	Fault	Outlet maximum pressure protection function generates fault <i>D409 Outlet maximum pressure</i> when the pressure is above the level defined with parameter <i>82.38 Outlet maximum pressure fault level</i> for a time set in parameter <i>82.45 Pressure check delay</i> .	2

No.	Name/Value	Description	Def/FbEq16
	Warning/Fault	Outlet maximum pressure protection function first generates a warning when the pressure is above the level defined with parameter 82.37 Outlet maximum pressure warning level for a time set in parameter 82.45 Pressure check delay . If the pressure raises above the level defined with parameter 82.38 Outlet maximum pressure fault level , outlet maximum pressure fault is generated.	3
82.37	Outlet maximum pressure warning level	Defines the level at which drive should generate the outlet maximum pressure warning. Note: By default the parameter unit will be bar. However, the unit can be changed according to the parameter 81.20 Pressure unit .	0.00 bar
	0.00...32767.00 bar	Outlet maximum pressure warning level.	1 = 1 bar
82.38	Outlet maximum pressure fault level	Defines the level at which drive should generate the outlet maximum pressure fault. Note: By default the parameter unit will be bar. However, the unit can be changed according to the parameter 81.20 Pressure unit .	0.00 bar
	0.00...32767.00 bar	Outlet maximum pressure fault level.	1 = 1 bar
82.40	Inlet minimum pressure protection	Enables inlet minimum pressure protection function.	<i>Disabled</i>
	Disabled	Inlet minimum pressure protection is disabled.	0
	Warning	Inlet minimum pressure protection function generates warning D510 Inlet minimum pressure when the pressure is below the level defined with parameter 82.41 Inlet minimum pressure warning level for a time set in 82.45 Pressure check delay .	1
	Fault	Inlet minimum pressure protection function generates fault D40A Inlet minimum pressure when the pressure is below the level defined with parameter 82.42 Inlet minimum pressure fault level for a time set in 82.45 Pressure check delay .	2
	Warning/Fault	Inlet minimum pressure protection function first generates a warning when the pressure is below the level defined with parameter 82.41 Inlet minimum pressure warning level for a time set in 82.45 Pressure check delay . If the pressure continues to fall below the level defined with parameter 82.42 Inlet minimum pressure fault level , a fault is generated.	3
82.41	Inlet minimum pressure warning level	Defines the level at which drive should generate the inlet minimum pressure warning. Note: By default the parameter unit will be bar. However, the unit can be changed according to the parameter 81.20 Pressure unit .	0.00 bar
	0.00...32767.00 bar	Inlet minimum pressure warning level.	1 = 1 bar
82.42	Inlet minimum pressure fault level	Defines the level at which drive should generate the inlet minimum pressure fault. Note: By default the parameter unit will be bar. However, the unit can be changed according to the parameter 81.20 Pressure unit .	0.00 bar
	0.00...32767.00 bar	Inlet minimum pressure fault level.	1 = 1 bar

No.	Name/Value	Description	Def/FbEq16												
82.45	<i>Pressure check delay</i>	Defines the delay time at which the pressure supervisions are inactive. You can adjust check delay for a system in which the pressure does not increase immediately after starting the motor.	3.00 s												
	0.00...3600.00 s	Pressure check delay time.	1 = 1 s												
82.51	<i>Pump autoreset selection</i>	Selects pump protection faults that are automatically reset. The parameter is a 16-bit word with each bit corresponding to a fault type. Whenever a bit is set to 1, the corresponding fault is automatically reset after <i>82.52 Pump autoreset delay time</i> . WARNING! Before you activate the function, make sure that no dangerous situations can occur. The function restarts the drive automatically and continues operation after a fault.	0												
<table border="1"> <thead> <tr> <th>Bit</th> <th>Name</th> <th>Descriptions</th> </tr> </thead> <tbody> <tr> <td>0</td> <td>Dry run</td> <td>Enables autoreset of the Dry run fault condition</td> </tr> <tr> <td>1</td> <td>Cavitation detected</td> <td>Enables autoreset of a cavitation fault</td> </tr> <tr> <td>2...15</td> <td>Reserved</td> <td></td> </tr> </tbody> </table>				Bit	Name	Descriptions	0	Dry run	Enables autoreset of the Dry run fault condition	1	Cavitation detected	Enables autoreset of a cavitation fault	2...15	Reserved	
Bit	Name	Descriptions													
0	Dry run	Enables autoreset of the Dry run fault condition													
1	Cavitation detected	Enables autoreset of a cavitation fault													
2...15	Reserved														
	0...65535	Bit mask	1 = 1												
82.52	<i>Pump autoreset delay time</i>	Defines the time that the drive will wait after a pump protection fault before attempting an automatic reset.	60.0 min												
	0.0...3276.0 min	Wait time	10 = 1 min												
84 Advanced damper control		Settings for the advanced damper control. Damper control functionality can have: <ul style="list-style-type: none"> • one discharge air damper (DA damper), or • one discharge air damper (DA damper) and one outside air damper (OA damper). Open end and closed end switches can be configured for each damper. There are three possible actions if timeout is encountered. Notes: <ul style="list-style-type: none"> • Group 84 replaces parameter <i>20.40 Run permissive</i> logic, and it is not recommended to enable <i>20.40</i> and <i>84.01 Advanced damper configuration</i> at the same time. • Group 84 in Override mode (group <i>70 Override</i>) will function the same as in non-override mode. Parameter <i>70.10 Override enables selection</i> bit 0 has no effect on group 84. 													
84.01	<i>Advanced damper configuration</i>	Selects the advanced damper configuration.	<i>Disabled</i>												
	Disabled	Disables advanced damper.	0												

No.	Name/Value	Description	Def/FbEq16
	DA damper, no pre-pressure	<p>Drive controls one discharge air (DA) damper using one of the relay outputs (see selection bit 63 for parameters 10.24, 10.27, and 10.30).</p> <p>When start is requested (start command or override), the drive will command the discharge damper to open. When the damper is fully open and confirmed to be open through open end switch (see parameter 84.03), the drive will continue to start rotating the motor.</p> <p>When stop is requested (that is, there is no start command, or the drive is faulted, or start inhibit is active, and override is not active), the drive will keep the relay output active and follow the stop mode (see parameter 21.03).</p> <p>While the motor is slowing down, once the output frequency is less than 30.13 Minimum frequency (in scalar control mode) or motor speed is less than 30.11 Minimum speed (in vector control mode), the drive will de-energize the relay output to command the damper to close.</p>	1
	DA damper, w/ pre-pressure	<p>Drive controls one discharge air (DA) damper using one of the relay outputs (see selection bit 63 for parameters 10.24, 10.27, and 10.30).</p> <p>When start is requested (start command or override), the drive will run at 30.13 Minimum frequency (in scalar control mode) or 30.11 Minimum speed (in vector control mode), and once that minimum is reached, the drive will command the discharge damper to open. When the damper is fully open and confirmed to be open through open end switch (see parameter 84.03), the drive will follow the commanded reference.</p> <p>When stop is requested (that is, there is no start command, or drive is faulted, or start inhibit is active, and override is not active), the drive will keep the relay output active and follow the stop mode (see parameter 21.03).</p> <p>While the motor is slowing down, once the output frequency is less than 30.13 Minimum frequency (in scalar control mode) or motor speed is less than 30.11 Minimum speed (in vector control mode), the drive will de-energize the relay output to command the damper to close.</p>	2

No.	Name/Value	Description	Def/FbEq16
	OA+DA dprs, w/ pre-pressure	<p>Drive controls one discharge air (DA) damper and one outside air (OA) damper using two of the relay outputs (see selection bits 63 and 64 for parameters 1 10.24, 10.27, and 10.30).</p> <p>When start is requested (start command or override), the drive will command the OA damper to open. When the OA damper is fully open and confirmed to be open through open end switch (see parameter 84.13), the drive will run at 30.13 Minimum frequency (in scalar control mode) or 30.11 Minimum speed (in vector control mode). Once that minimum is reached, the drive will command the DA damper to open. When the DA damper is fully open and confirmed to be open through open end switch (see parameter 84.03), the drive will follow the commanded reference.</p> <p>When stop is requested (that is, there is no start command, or drive is faulted, or start inhibit is active, and override is not active), the drive will keep the outputs of both relays active and follow the stop mode (see parameter 21.03).</p> <p>While the motor is slowing down, once the output frequency is less than 30.13 Minimum frequency (in scalar control mode) or motor speed is less than 30.11 Minimum speed (in vector control mode), the drive will de-energize the DA damper relay output to command the DA damper to close. Once the DA damper is confirmed to be closed through the closed end switch (see parameter 84.06), the drive will de-energize the OA damper relay output to command the OA damper to close.</p>	3

84.02 *DA damper control status word* Status of the dampers, damper commands and if timeout detected. -

Bit	Name	Description
0	DA damper closed	1 = Discharge air damper is closed.
1	DA damper opening	1 = Discharge air damper is opening.
2	DA damper closing	1 = Discharge air damper is closing.
3	DA damper command	1 = Discharge air damper is commanded to open.
4	OA damper closed	1 = Outside air damper is closed.
5	OA damper opening	1 = Outside air damper is opening.
6	OA damper closing	1 = Outside air damper is closing.
7	OA damper command	1 = Outside air damper is commanded to open.
8...14	Reserved	
15	Damper control timeout	1 = Damper control timeout detected.

0000h...FFFFh Damper control status word. 1 = 1

84.03 <i>DA damper open input</i>	Selects which digital input (or its inverse) is wired to the open end switch of the DA damper.	<i>Not used</i>
Not used	Open end switch is not used.	0
Not used	Open end switch is not used.	1
DI1	DI1 wired to the open end switch.	2
DI2	DI2 wired to the open end switch.	3
DI3	DI3 wired to the open end switch.	4
DI4	DI4 wired to the open end switch.	5
DI5	DI5 wired to the open end switch.	6

No.	Name/Value	Description	Def/FbEq16
	DI6	DI6 wired to the open end switch.	7
	-DI1	Inverse of DI1 wired to the open end switch.	8
	-DI2	Inverse of DI2 wired to the open end switch.	9
	-DI3	Inverse of DI3 wired to the open end switch.	10
	-DI4	Inverse of DI4 wired to the open end switch.	11
	-DI5	Inverse of DI5 wired to the open end switch.	12
	-DI6	Inverse of DI6 wired to the open end switch.	13
	<i>Other [bit]</i>	Source selection (see <i>Terms and abbreviations</i> on page 358).	-
<i>84.04</i>	<i>DA damper open timeout</i>	Time the drive will wait after commanding the DA damper to open till the DA damper open end switch confirms the open position of the damper (see parameter <i>84.03</i>). If the open end switch input is set to any other selection than <i>Not used</i> when timeout is detected, one of three different actions can be selected (see parameter <i>84.05</i>). Otherwise, the open end switch is set to <i>Not used</i> , and timeout would only indicate that a timer has expired.	30 s
	0...90 s	Timeout.	1 = 1 s
<i>84.05</i>	<i>DA damper open timeout action</i>	Selects the action the drive will take if the DA damper was commanded to open and the operation timed out.	<i>Warning</i>
	No action	Drive will do the following: <ul style="list-style-type: none"> • set the timeout detected bit in the damper control status word (parameter <i>80.02</i>, bit 15), • If the open end switch is not used (see parameter <i>84.03</i>), the drive will continue working as if the open end switch signal had been received. Otherwise, the drive will wait in its current state till it receives the open end switch signal. 	0
	Warning	Drive will do the following: <ul style="list-style-type: none"> • set the timeout detected bit in the damper control status word (parameter <i>80.02</i>, bit 15), • generate a damper control warning (see warning <i>D504</i>, aux code 01), • lastly, the drive will wait in its current state till it receives the open end switch signal. 	1
	Fault	Drive will do the following: <ul style="list-style-type: none"> • set the timeout detected bit in the damper control status word (parameter <i>80.02</i>, bit 15), • trip on a damper control fault (see fault <i>D40B</i>, aux code 01), • lastly, the drive will start the damper shutdown sequence. 	2
<i>84.06</i>	<i>DA damper closed input</i>	Selects which digital input (or its inverse) is wired to the closed end switch of the DA damper.	<i>Not used</i>
	Not used	Closed end switch is not used.	0
	Not used	Closed end switch is not used.	1
	DI1	DI1 wired to the closed end switch.	2
	DI2	DI2 wired to the closed end switch.	3
	DI3	DI3 wired to the closed end switch.	4
	DI4	DI4 wired to the closed end switch.	5
	DI5	DI5 wired to the closed end switch.	6
	DI6	DI6 wired to the closed end switch.	7

No.	Name/Value	Description	Def/FbEq16
	-DI1	Inverse of DI1 wired to the closed end switch.	8
	-DI2	Inverse of DI2 wired to the closed end switch.	9
	-DI3	Inverse of DI3 wired to the closed end switch.	10
	-DI4	Inverse of DI4 wired to the closed end switch.	11
	-DI5	Inverse of DI5 wired to the closed end switch.	12
	-DI6	Inverse of DI6 wired to the closed end switch.	13
	<i>Other [bit]</i>	Source selection (see <i>Terms and abbreviations</i> on page 358).	-
84.07	<i>DA damper closed timeout</i>	Time the drive will wait after commanding the DA damper to close till the DA damper closed end switch confirms the closed position of the damper (see parameter 84.06). If the closed end switch input is set to any other selection than <i>Not used</i> when timeout is detected, one of three different actions can be selected (see parameter 84.08). Otherwise, the closed end switch is set to <i>Not used</i> and timeout would only indicate that a timer has expired.	20 s
	0...90 s	Timeout.	1 = 1 s
84.08	<i>DA damper closed timeout action</i>	Selects the action the drive will take if the DA damper was commanded to close and the operation timed out.	<i>No action</i>
	No action	Drive will do the following: <ul style="list-style-type: none"> • set the timeout detected bit in the damper control status word (parameter 80.02, bit 15), • If the closed end switch is not used (see parameter 84.06), the drive will continue working as if the closed end switch signal had been received. Otherwise, the drive will wait in its current state till it receives the closed end switch signal. 	0
	Warning	Drive will do the following: <ul style="list-style-type: none"> • set the timeout detected bit in the damper control status word (parameter 80.02, bit 15), • generate a damper control warning (see warning D504, aux code 02), • lastly, the drive will wait in its current state till it receives the closed end switch signal. 	1
	Fault	Drive will do the following: <ul style="list-style-type: none"> • set the timeout detected bit in the damper control status word (parameter 80.02, bit 15), • trip on a damper control fault (see fault D40B, aux code 02), • lastly, the drive will start the damper shutdown sequence. 	2
84.13	<i>OA damper open input</i>	Selects which digital input (or its inverse) is wired to the open end switch of the OA damper. For the other selections, see parameter 84.03.	<i>Not used</i>
	Not used	Open end switch is not used.	0
84.14	<i>OA damper open timeout</i>	Time the drive will wait after commanding the OA damper to open till the OA damper open end switch confirms the open position of the damper (see parameter 84.13). If the open end switch input is set to any other selection than <i>Not used</i> when timeout is detected, one of three different actions can be selected (see parameter 84.15). Otherwise, the open end switch is set to <i>Not used</i> and timeout would only indicate that a timer has expired.	30 s
	0...90 s	Timeout.	1 = 1 s

No.	Name/Value	Description	Def/FbEq16
84.15	<i>OA damper open timeout action</i>	Selects the action the drive will take if the OA damper was commanded to open and the operation timed out.	<i>Warning</i>
	No action	Drive will do the following: <ul style="list-style-type: none"> • set the timeout detected bit in the damper control status word (parameter <i>80.02</i>, bit 15) • If open end switch is not used (see parameter <i>84.13</i>), the drive will continue working as if the open end switch signal had been received. Otherwise, the drive will wait in its current state till it receives the open end switch signal. 	0
	Warning	Drive will do the following: <ul style="list-style-type: none"> • set the timeout detected bit in the damper control status word (parameter <i>80.02</i>, bit 15) • generate a damper control warning (see warning <i>D504</i>, aux code 03), • lastly, the drive will wait in its current state till it receives the closed end switch signal. 	1
	Fault	Drive will do the following: <ul style="list-style-type: none"> • set the timeout detected bit in the damper control status word (parameter <i>80.02</i>, bit 15) • trip on a damper control fault (see fault <i>D40B</i>, aux code 03), • lastly, the drive will start the damper shutdown sequence. 	2
84.16	<i>OA damper closed input</i>	Selects which digital input (or its inverse) is wired to the closed end switch of the OA damper. For the other selections, see parameter <i>84.06</i> .	<i>Not used</i>
	Not used	Closed end switch is not used.	0
84.17	<i>OA damper closed timeout</i>	Time the drive will wait after commanding the OA damper to close till the OA damper closed end switch confirms the closed position of the damper (see parameter <i>84.16</i>). If the closed end switch input is set to any other selection than <i>Not used</i> when timeout is detected, one of three different actions can be selected (see parameter <i>84.18</i>). Otherwise, the closed end switch is set to <i>Not used</i> and timeout would only indicate that a timer has expired.	20 s
	0...90 s	Timeout.	1 = 1 s
84.18	<i>OA damper closed timeout action</i>	Selects the action the drive will take if the OA damper was commanded to close and the operation timed out.	<i>No action</i>
	No action	Drive will do the following: <ul style="list-style-type: none"> • set the timeout detected bit in the damper control status word (parameter <i>80.02</i>, bit 15), • If the closed end switch is not used (see parameter <i>84.16</i>), the drive will continue working as if the closed end switch signal had been received. Otherwise, the drive will wait in its current state till it receives the closed end switch signal. 	0
	Warning	Drive will do the following: <ul style="list-style-type: none"> • set the timeout detected bit in the damper control status word (parameter <i>80.02</i>, bit 15) • generate a damper control warning (see warning <i>D504</i>, aux code 04), • lastly, the drive will wait in its current state till it receives the closed end switch signal. 	1

No.	Name/Value	Description	Def/FbEq16
	Fault	Drive will do the following: <ul style="list-style-type: none"> • set the timeout detected bit in the damper control status word (parameter 80.02, bit 15) • trip on a damper control fault (see fault D40B, aux code 04), • lastly, the drive will start the damper shutdown sequence. 	2
<hr/>			
95 HW configuration		Various hardware-related settings.	
95.01	Supply voltage	Selects the supply voltage range. This parameter is used by the drive to determine the nominal voltage of the supply network. The parameter also affects the DC voltage control functions of the drive (see section DC voltage control on page 198).  WARNING! An incorrect setting may cause the motor to rush uncontrollably, or the brake chopper or resistor to overload. Notes: <ul style="list-style-type: none"> • The selections shown depend on the hardware of the drive. If only one voltage range is valid for the drive in question, it is selected by default. • This parameter cannot be changed while the drive is running. 	<i>Automatic / not selected</i>
	Automatic / not selected	If the drive supports only one voltage range, then this parameter is set to the supported value automatically: <ul style="list-style-type: none"> • For voltage class -1 and -2 drives, this parameter is set to 208...240 V. • For voltage class -6, this parameter is set to 525...600 V. In voltage class -4 drives, the supply voltage is automatically selected between 380...415 V and 440...480 V once after every CU boot. Supply voltage category 380...415 V is internally used if 95.03 Estimated AC supply voltage is less than 415 V + 10%, otherwise category 440...480 V is assumed. Note that category is internally selected without changing value of 95.01 from 0.	0
	208...240 V	208...240 V	1
	380...415 V	380...415 V	2
	440...480 V	440...480 V	3
95.02	Adaptive voltage limits	Enables adaptive voltage limits. Adaptive voltage limits can be used if, for example, an IGBT supply unit is used to raise the DC voltage level. If the communication between the inverter and IGBT supply unit is active, the voltage limits are related to the DC voltage reference from the IGBT supply unit. Otherwise the limits are calculated based on the measured DC voltage at the end of the pre-charging sequence. This function is also useful if the AC supply voltage to the drive is high, as the warning levels are raised accordingly.	<i>Enable</i>
	Disable	Adaptive voltage limits disabled.	0
	Enable	Adaptive voltage limits enabled.	1

No.	Name/Value	Description	Def/FbEq16												
95.03	<i>Estimated AC supply voltage</i>	AC supply voltage estimated by calculation. Estimation is done every time the drive is powered up and is based on the rise speed of voltage level of the DC bus while the drive charges the DC bus.	-												
	0...65535 V	Voltage.	10 = 1 V												
95.04	<i>Control board supply</i>	Specifies how the control board of the drive is powered.	<i>Internal 24V</i>												
	Internal 24V	The drive control board is powered from the drive power unit it is connected to.	0												
	External 24V	The drive control board is powered from an external power supply.	1												
95.15	<i>Special HW settings</i>	<p>Contains hardware-related settings that can be enabled and disabled by toggling the specific bits.</p> <p>Note:</p> <ul style="list-style-type: none"> The installation of the hardware specified by this parameter may require derating of drive output, or impose other limitations. See (ATEX) the <i>Hardware manual</i> of the drive. 	0000h												
		<table border="1"> <thead> <tr> <th>Bit</th> <th>Name</th> <th>Information</th> </tr> </thead> <tbody> <tr> <td>0</td> <td>EX motor</td> <td> <p>1 = The driven motor is an Ex (ATEX) motor provided by ABB for potentially explosive atmospheres. This sets the required minimum switching frequency for ABB Ex (ATEX) motors.</p> <p>Notes:</p> <ul style="list-style-type: none"> For non-ABB Ex (ATEX) motors, use parameters 97.01 and 97.02 to define the correct minimum switching frequency. If you have a multimotor system, contact your local ABB representative. </td> </tr> <tr> <td>1</td> <td>ABB Sine filter</td> <td>1 = An ABB sine filter is connected to the output of the drive.</td> </tr> <tr> <td>2...15</td> <td>Reserved</td> <td></td> </tr> </tbody> </table>	Bit	Name	Information	0	EX motor	<p>1 = The driven motor is an Ex (ATEX) motor provided by ABB for potentially explosive atmospheres. This sets the required minimum switching frequency for ABB Ex (ATEX) motors.</p> <p>Notes:</p> <ul style="list-style-type: none"> For non-ABB Ex (ATEX) motors, use parameters 97.01 and 97.02 to define the correct minimum switching frequency. If you have a multimotor system, contact your local ABB representative. 	1	ABB Sine filter	1 = An ABB sine filter is connected to the output of the drive.	2...15	Reserved		
Bit	Name	Information													
0	EX motor	<p>1 = The driven motor is an Ex (ATEX) motor provided by ABB for potentially explosive atmospheres. This sets the required minimum switching frequency for ABB Ex (ATEX) motors.</p> <p>Notes:</p> <ul style="list-style-type: none"> For non-ABB Ex (ATEX) motors, use parameters 97.01 and 97.02 to define the correct minimum switching frequency. If you have a multimotor system, contact your local ABB representative. 													
1	ABB Sine filter	1 = An ABB sine filter is connected to the output of the drive.													
2...15	Reserved														
	0000h...FFFFh	Hardware options configuration word.	1 = 1												

No.	Name/Value	Description	Def/FbEq16															
95.20	<i>HW options word 1</i>	Specifies hardware-related options that require differentiated parameter defaults. This parameter is not affected by a parameter restore. For motor disconnect in vector mode, make sure to: 1. set parameter 95.26 value to <i>Disable</i> 2. enable 31.12 bit 5. This is because when using output contactor in vector control mode, the drive may occasionally trip to Overspeed/Overfrequency fault.	-															
<table border="1"> <thead> <tr> <th>Bit</th> <th>Name</th> <th>Value</th> </tr> </thead> <tbody> <tr> <td>0</td> <td>Supply frequency 60 Hz</td> <td>See section <i>Differences in the default values between 50 Hz and 60 Hz supply frequency settings</i> on page 629. 0 = 50 Hz. 1 = 60 Hz.</td> </tr> <tr> <td>1...12</td> <td>Reserved</td> <td></td> </tr> <tr> <td>13</td> <td>du/dt filter activation</td> <td>When active, an external du/dt filter is connected to the drive/inverter output. The setting will limit the output switching frequency, and force the fan of the drive/inverter module to full speed. 0 = du/dt filter inactive. 1 = du/dt filter active.</td> </tr> <tr> <td>14...15</td> <td>Reserved</td> <td></td> </tr> </tbody> </table>				Bit	Name	Value	0	Supply frequency 60 Hz	See section <i>Differences in the default values between 50 Hz and 60 Hz supply frequency settings</i> on page 629. 0 = 50 Hz. 1 = 60 Hz.	1...12	Reserved		13	du/dt filter activation	When active, an external du/dt filter is connected to the drive/inverter output. The setting will limit the output switching frequency, and force the fan of the drive/inverter module to full speed. 0 = du/dt filter inactive. 1 = du/dt filter active.	14...15	Reserved	
Bit	Name	Value																
0	Supply frequency 60 Hz	See section <i>Differences in the default values between 50 Hz and 60 Hz supply frequency settings</i> on page 629. 0 = 50 Hz. 1 = 60 Hz.																
1...12	Reserved																	
13	du/dt filter activation	When active, an external du/dt filter is connected to the drive/inverter output. The setting will limit the output switching frequency, and force the fan of the drive/inverter module to full speed. 0 = du/dt filter inactive. 1 = du/dt filter active.																
14...15	Reserved																	
	0000h...FFFFh	Hardware options configuration word.	1 = 1															
95.26	<i>Motor disconnect detection</i>	<p>Detects if motor is disconnected and shows a warning of disconnected motor. When this parameter is enabled, the drive will do the following:</p> <ol style="list-style-type: none"> 1. The drive detects if the motor is disconnected from the drive (all three phases). 2. When a motor disconnection is detected, the drive will stay running and waits for the motor to be connected again. The drive shows warning A784 Motor disconnect on the control panel. 3. When motor connection is again detected, the motor returns back to the last active reference before the disconnection was detected. 4. The warning message disappears from the panel. <p>For motor disconnect in vector mode, make sure to:</p> <ol style="list-style-type: none"> 1. set parameter 95.26 value to <i>Disable</i> 2. enable 31.12 bit 5. This is because when using output contactor in vector control mode, the drive may occasionally trip to Overspeed/Overfrequency fault. <p>Note: This feature is only available in scalar control mode. This parameter does not affect vector control mode behavior.</p>	<i>Disable</i>															
	Disable	Detecting of disconnecting motor disabled.	0															
	Enable	Detecting of disconnecting motor enabled.	1															

No.	Name/Value	Description	Def/FbEq16
95.200	<i>Cooling fan mode</i>	Cooling fan operation mode.	<i>Auto</i>
	Auto	Fan runs normally: Fan on/off, fan speed reference can autochange according to the drive state.	0
	Always on	Fan always runs at 100% speed reference.	1
96 System		Language selection; access levels; macro selection; parameter save and restore; control unit reboot; user parameter sets; unit selection; parameter checksum calculation; user lock.	
96.01	<i>Language</i>	Selects the language of the parameter interface and other displayed information when viewed on the control panel. Notes: <ul style="list-style-type: none"> • Not all languages listed below are necessarily supported. • This parameter does not affect the languages visible in the Drive composer PC tool. (Those are specified under View > Settings > Drive default language.) 	<i>English</i>
	Not selected	None.	0
	English	English.	1033
	Deutsch	German.	1031
	Italiano	Italian.	1040
	Español	Spanish.	3082
	Portugues	Portuguese.	2070
	Nederlands	Dutch.	1043
	Français	French.	1036
	Dansk	Danish.	1030
	Suomi	Finnish.	1035
	Svenska	Swedish.	1053
	Russki	Russian.	1049
	Polski	Polish.	1045
	Türkçe	Turkish.	1055
96.02	<i>Pass code</i>	Pass codes can be entered into this parameter to activate further access levels (see parameter 96.03 Access level status) or to configure the user lock. Entering "358" toggles the parameter lock, which prevents the changing of all other parameters through the control panel or the Drive composer PC tool. Entering the user pass code (by default, "10000000") enables parameters 96.100...96.102 , which can be used to define a new user pass code and to select the actions that are to be prevented. Entering an invalid pass code will close the user lock if open, ie, hide parameters 96.100...96.102 . After entering the code, check that the parameters are in fact hidden. If they are not, enter another (random) pass code. Note: You must change the default user pass code to maintain a high level of cybersecurity. <u>Store the code in a safe place – ABB CANNOT UNLOCK THE DRIVE ONCE YOU CHANGE THE PASS CODE.</u> See also section User lock (page 233).	
	0...99999999	Pass code.	-

No.	Name/Value	Description	Def/FbEq16																						
96.03	<i>Access level status</i>	Shows which access levels have been activated by pass codes entered into parameter 96.02 Pass code .	0001b																						
<table border="1"> <thead> <tr> <th>Bit</th> <th>Name</th> </tr> </thead> <tbody> <tr> <td>0</td> <td>End user</td> </tr> <tr> <td>1</td> <td>Service</td> </tr> <tr> <td>2</td> <td>Advanced programmer</td> </tr> <tr> <td>3...9</td> <td>Reserved</td> </tr> <tr> <td>10</td> <td>Override parameter lock</td> </tr> <tr> <td>11</td> <td>OEM access level 1</td> </tr> <tr> <td>12</td> <td>OEM access level 2</td> </tr> <tr> <td>13</td> <td>OEM access level 3</td> </tr> <tr> <td>14</td> <td>Parameter lock</td> </tr> <tr> <td>15</td> <td>Reserved</td> </tr> </tbody> </table>				Bit	Name	0	End user	1	Service	2	Advanced programmer	3...9	Reserved	10	Override parameter lock	11	OEM access level 1	12	OEM access level 2	13	OEM access level 3	14	Parameter lock	15	Reserved
Bit	Name																								
0	End user																								
1	Service																								
2	Advanced programmer																								
3...9	Reserved																								
10	Override parameter lock																								
11	OEM access level 1																								
12	OEM access level 2																								
13	OEM access level 3																								
14	Parameter lock																								
15	Reserved																								
	0000h...FFFFh	Active access levels.	1 = 1																						
96.04	<i>Macro select</i>	Selects the control macro. See chapter Default I/O configuration (page 101) for more information. After a selection is made, the parameter reverts automatically to <i>Done</i> .	<i>Done</i>																						
	Done	Macro selection complete; normal operation.	0																						
	HVAC default	Factory default (page 103). For scalar motor control. You cannot select HVAC default with this parameter but only in the Primary settings menu, see section Selecting default configurations page 101.	1																						
96.05	<i>Macro active</i>	Shows which control macro is currently selected. See chapter Default I/O configuration (page 101) for more information. To change the macro, use parameter 96.04 Macro select .	<i>HVAC default</i>																						
	HVAC default	Factory default (page 103). For scalar motor control.	1																						
96.06	<i>Parameter restore</i>	Restores the original settings of the control program, ie, parameter default values. Note: This parameter cannot be changed while the drive is running.	<i>Done</i>																						
	Done	Restoring is completed.	0																						
	Restore defaults	Restores all editable parameter values to default values, except <ul style="list-style-type: none"> • motor data and ID run results • I/O extension module settings • end user texts, such as customized warnings and faults • control panel/PC communication settings • fieldbus adapter settings • control macro selection and the parameter defaults implemented by it • parameter 95.01 Supply voltage • differentiated defaults implemented by parameter 95.20 HW options word 1 • user lock configuration parameters 96.100...96.102. 	8																						

No.	Name/Value	Description	Def/FbEq16
	Clear all	Restores all editable parameter values to default values, except <ul style="list-style-type: none"> • end user texts, such as customized warnings and faults • control panel/PC communication settings • parameter 95.01 Supply voltage • differentiated defaults implemented by parameter 95.20 HW options word 1 • user lock configuration parameters 96.100...96.102. • group 49 Panel port communication parameters. 	62
	Reset all fieldbus settings	Restores all fieldbus and communication related settings to default values. Note: Fieldbus, control panel and PC tool communication are interrupted during the restore.	32
	Reset home view	Restores the home view layout back to show the values of the default parameters defined by the control macro in use	512
	Reset end user texts	Restores all end user texts to default values, including the contact info, customized fault and warning texts, PID unit and currency unit. Note: PID unit is reset only if it is user editable text, that is, parameter 40.79 Set 1 units is set to <i>User text</i> .	1024
	Reset motor data	Restores all motor nominal values and motor ID run results to default values.	2
	All to factory defaults	Restores settings and all editable parameters back to initial factory values, except <ul style="list-style-type: none"> • differentiated defaults implemented by parameter 95.20 HW options word 1. 	34560
96.07	Parameter save manually	Saves the valid parameter values to the permanent memory on the drive control unit to ensure that operation can continue after cycling the power. Save the parameters with this parameter <ul style="list-style-type: none"> • to store values sent from the fieldbus • when using external +24 V DC power supply to the control unit: to save parameter changes before you power down the control unit. The supply has a very short hold-up time when powered off. Note: A new parameter value is saved automatically when changed from the PC tool or control panel but not when altered through a fieldbus adapter connection.	<i>Done</i>
	Done	Save completed.	0
	Save	Save in progress.	1
96.08	Control board boot	Changing the value of this parameter to 1 reboots the control unit (without requiring a power off/on cycle of the complete drive module). The value reverts to 0 automatically.	<i>No action</i>
	No action	1 = No action.	0
	Reboot	1 = Reboot the control unit.	1
96.10	User set status	Shows the status of the user parameter sets. This parameter is read-only. See also section Data storage parameters (page 232).	-
	n/a	No user parameter sets have been saved.	0
	Loading	A user set is being loaded.	1
	Saving	A user set is being saved.	2

No.	Name/Value	Description	Def/FbEq16
	Faulted	Invalid or empty parameter set.	3
	User1 IO active	User set 1 has been selected by parameters 96.12 User set I/O mode in1 and 96.13 User set I/O mode in2 .	4
	User2 IO active	User set 2 has been selected by parameters 96.12 User set I/O mode in1 and 96.13 User set I/O mode in2 .	5
	User3 IO active	User set 3 has been selected by parameters 96.12 User set I/O mode in1 and 96.13 User set I/O mode in2 .	6
	User4 IO active	User set 4 has been selected by parameters 96.12 User set I/O mode in1 and 96.13 User set I/O mode in2 .	7
	Reserved		8...19
	User1 backup	User set 1 has been saved or loaded.	20
	User2 backup	User set 2 has been saved or loaded.	21
	User3 backup	User set 3 has been saved or loaded.	22
	User4 backup	User set 4 has been saved or loaded.	23
96.11	User set save/load	<p>Enables the saving and restoring of up to four custom sets of parameter settings. See section User parameter sets (page 226).</p> <p>The set that was in use before powering down the drive is in use after the next power-up.</p> <p>Notes:</p> <ul style="list-style-type: none"> Hardware configuration settings, such as I/O extension module and fieldbus configuration parameters (groups 14...16, 47, 51...58 and 92...93, and parameter 50.01 FBA A enable), and forced input/output values (such as 10.03 DI force selection and 10.04 DI forced data) are not included in user parameter sets. Parameter changes made after loading a set are not automatically stored – they must be saved using this parameter. If no sets have been saved, attempting to load a set will create all sets from the currently active parameter settings. Switching between sets is only possible with the drive stopped. 	<i>No action</i>
	No action	Load or save operation complete; normal operation.	0
	User set I/O mode	Load user parameter set using parameters 96.12 User set I/O mode in1 and 96.13 User set I/O mode in2 .	1
	Load set 1	Load user parameter set 1.	2
	Load set 2	Load user parameter set 2.	3
	Load set 3	Load user parameter set 3.	4
	Load set 4	Load user parameter set 4.	5
	Reserved		6...17
	Save to set 1	Save user parameter set 1.	18
	Save to set 2	Save user parameter set 2.	19
	Save to set 3	Save user parameter set 3.	20
	Save to set 4	Save user parameter set 4.	21

No.	Name/Value	Description	Def/FbEq16															
96.12	<i>User set I/O mode in1</i>	When parameter 96.11 <i>User set save/load</i> is set to <i>User set I/O mode</i> , selects the user parameter set together with parameter 96.13 <i>User set I/O mode in2</i> as follows:	<i>Not selected</i>															
		<table border="1"> <thead> <tr> <th>Status of source defined by par. 96.12</th> <th>Status of source defined by par. 96.13</th> <th>User parameter set selected</th> </tr> </thead> <tbody> <tr> <td>0</td> <td>0</td> <td>Set 1</td> </tr> <tr> <td>1</td> <td>0</td> <td>Set 2</td> </tr> <tr> <td>0</td> <td>1</td> <td>Set 3</td> </tr> <tr> <td>1</td> <td>1</td> <td>Set 4</td> </tr> </tbody> </table>		Status of source defined by par. 96.12	Status of source defined by par. 96.13	User parameter set selected	0	0	Set 1	1	0	Set 2	0	1	Set 3	1	1	Set 4
		Status of source defined by par. 96.12		Status of source defined by par. 96.13	User parameter set selected													
		0		0	Set 1													
		1		0	Set 2													
0	1	Set 3																
1	1	Set 4																
Not selected	0.	0																
Selected	1.	1																
DI1	Digital input DI1 (<i>10.02 DI delayed status</i> , bit 0).	2																
DI2	Digital input DI2 (<i>10.02 DI delayed status</i> , bit 1).	3																
DI3	Digital input DI3 (<i>10.02 DI delayed status</i> , bit 2).	4																
DI4	Digital input DI4 (<i>10.02 DI delayed status</i> , bit 3).	5																
DI5	Digital input DI5 (<i>10.02 DI delayed status</i> , bit 4).	6																
DI6	Digital input DI6 (<i>10.02 DI delayed status</i> , bit 5).	7																
Reserved		8...17																
Timed function 1	Bit 0 of <i>34.01 Timed functions status</i> (see page 496).	18																
Timed function 2	Bit 1 of <i>34.01 Timed functions status</i> (see page 496).	19																
Timed function 3	Bit 2 of <i>34.01 Timed functions status</i> (see page 496).	20																
Reserved		21...23																
Supervision 1	Bit 0 of <i>32.01 Supervision status</i> (see page 485).	24																
Supervision 2	Bit 1 of <i>32.01 Supervision status</i> (see page 485).	25																
Supervision 3	Bit 2 of <i>32.01 Supervision status</i> (see page 485).	26																
<i>Other [bit]</i>	Source selection (see <i>Terms and abbreviations</i> on page 358).	-																
96.13	<i>User set I/O mode in2</i>	See parameter 96.12 <i>User set I/O mode in1</i> .	<i>Not selected</i>															

No.	Name/Value	Description	Def/FbEq16																					
96.16	<i>Unit selection</i>	Selects the unit of parameters indicating power, temperature and torque.	0000b																					
<table border="1"> <thead> <tr> <th>Bit</th> <th>Name</th> <th>Information</th> </tr> </thead> <tbody> <tr> <td>0</td> <td>Power unit</td> <td>0 = kW 1 = hp</td> </tr> <tr> <td>1</td> <td>Reserved</td> <td></td> </tr> <tr> <td>2</td> <td>Temperature unit</td> <td>0 = °C 1 = °F</td> </tr> <tr> <td>3</td> <td>Reserved</td> <td></td> </tr> <tr> <td>4</td> <td>Torque unit</td> <td>0 = Nm (N·m) 1 = lbft (lb·ft)</td> </tr> <tr> <td>5...15</td> <td>Reserved</td> <td></td> </tr> </tbody> </table>				Bit	Name	Information	0	Power unit	0 = kW 1 = hp	1	Reserved		2	Temperature unit	0 = °C 1 = °F	3	Reserved		4	Torque unit	0 = Nm (N·m) 1 = lbft (lb·ft)	5...15	Reserved	
Bit	Name	Information																						
0	Power unit	0 = kW 1 = hp																						
1	Reserved																							
2	Temperature unit	0 = °C 1 = °F																						
3	Reserved																							
4	Torque unit	0 = Nm (N·m) 1 = lbft (lb·ft)																						
5...15	Reserved																							
	0000h...FFFFh	Unit selection word.	1 = 1																					
96.20	<i>Time sync primary source</i>	Defines the first priority external source for synchronization of the drive's time and date. The date and time can also be directly set into parameters 96.24 ... 96.26 , in which case this parameter is ignored.	<i>Embedded FB</i>																					
	Reserved		1...2																					
	Fieldbus A	Fieldbus interface A, FENA/FPNO can get the time from SNTP server and set it as time for the drive.	3																					
	Reserved		4...5																					
	Embedded FB	Embedded fieldbus interface. EFB BACnet MS/ TP Timesync service can be used for setting the time for the drive.	6																					
	Reserved		7																					
	Panel link	Control panel, or Drive composer PC tool connected to the control panel. You can set the time using the control panel, or a PC tool connected to the panel link.	8																					
	Ethernet tool link	Drive composer PC tool through a FENA module. You can set the time manually using DCP over Ethernet. The time can be set in the same way when you do it with USB and panel.	9																					
96.24	<i>Full days since 1st Jan 1980</i>	The number of full days passed since beginning of the year 1980. This parameter, together with 96.25 Time in minutes within 24h and 96.26 Time in ms within one minute makes it possible to set the date and time in the drive via the parameter interface from a fieldbus or application program. This may be necessary if the fieldbus protocol does not support time synchronization.	12055 days																					
	1...59999 days	Days since beginning of 1980.	1 = 1 day																					
96.25	<i>Time in minutes within 24h</i>	The number of full minutes passed since midnight. For example, the value 860 corresponds to 2:20 pm. See parameter 96.24 Full days since 1st Jan 1980 .	0 min																					
	1...1439 min	Minutes since midnight.	1 = 1 min																					
96.26	<i>Time in ms within one minute</i>	The number of milliseconds passed since the previous minute. See parameter 96.24 Full days since 1st Jan 1980 .	0 ms																					
	0...59999 ms	Number of milliseconds since last minute.	1 = 1 ms																					
96.39	<i>Event configuration</i>	Selects the events that will be logged in the event logger.	1111 1111b																					

No.	Name/Value	Description	Def/FbEq16																											
<table border="1"> <thead> <tr> <th>Bit</th> <th>Name</th> <th>Information</th> </tr> </thead> <tbody> <tr> <td>0</td> <td>Power applied</td> <td>1 = Enabled = Event B5A2 will be logged 0 = Disabled = Event will not be logged</td> </tr> <tr> <td>1</td> <td>Hand mode selected</td> <td>1 = Enabled = Event B681 will be logged 0 = Disabled = Event will not be logged</td> </tr> <tr> <td>2</td> <td>Off mode selected</td> <td>1 = Enabled = Event B682 will be logged 0 = Disabled = Event will not be logged</td> </tr> <tr> <td>3</td> <td>Auto mode selected</td> <td>1 = Enabled = Event B683 will be logged 0 = Disabled = Event will not be logged</td> </tr> <tr> <td>4</td> <td>Auto start command</td> <td>1 = Enabled = Event B687 will be logged 0 = Disabled = Event will not be logged</td> </tr> <tr> <td>5</td> <td>Auto stop command</td> <td>1 = Enabled = Event B688 will be logged 0 = Disabled = Event will not be logged</td> </tr> <tr> <td>6</td> <td>Modulating started</td> <td>1 = Enabled = Event B689 will be logged 0 = Disabled = Event will not be logged</td> </tr> <tr> <td>7</td> <td>Modulating stopped</td> <td>1 = Enabled = Event B68A will be logged 0 = Disabled = Event will not be logged</td> </tr> </tbody> </table>				Bit	Name	Information	0	Power applied	1 = Enabled = Event B5A2 will be logged 0 = Disabled = Event will not be logged	1	Hand mode selected	1 = Enabled = Event B681 will be logged 0 = Disabled = Event will not be logged	2	Off mode selected	1 = Enabled = Event B682 will be logged 0 = Disabled = Event will not be logged	3	Auto mode selected	1 = Enabled = Event B683 will be logged 0 = Disabled = Event will not be logged	4	Auto start command	1 = Enabled = Event B687 will be logged 0 = Disabled = Event will not be logged	5	Auto stop command	1 = Enabled = Event B688 will be logged 0 = Disabled = Event will not be logged	6	Modulating started	1 = Enabled = Event B689 will be logged 0 = Disabled = Event will not be logged	7	Modulating stopped	1 = Enabled = Event B68A will be logged 0 = Disabled = Event will not be logged
Bit	Name	Information																												
0	Power applied	1 = Enabled = Event B5A2 will be logged 0 = Disabled = Event will not be logged																												
1	Hand mode selected	1 = Enabled = Event B681 will be logged 0 = Disabled = Event will not be logged																												
2	Off mode selected	1 = Enabled = Event B682 will be logged 0 = Disabled = Event will not be logged																												
3	Auto mode selected	1 = Enabled = Event B683 will be logged 0 = Disabled = Event will not be logged																												
4	Auto start command	1 = Enabled = Event B687 will be logged 0 = Disabled = Event will not be logged																												
5	Auto stop command	1 = Enabled = Event B688 will be logged 0 = Disabled = Event will not be logged																												
6	Modulating started	1 = Enabled = Event B689 will be logged 0 = Disabled = Event will not be logged																												
7	Modulating stopped	1 = Enabled = Event B68A will be logged 0 = Disabled = Event will not be logged																												
0...59999		Bitmask of logged events.	1 = 1																											
96.51	Clear fault and event logger	Clears all events from the drive's fault and event logs. See section Warning/fault history on page 238.	Done																											
	Done	0 = No action	0																											
	Reset	1 = Clear the loggers.	1																											
96.54	Checksum action	<p>Selects how the drive reacts</p> <ul style="list-style-type: none"> when 96.55 Checksum control word, bit 8 = 1 (Approved checksum A): if the parameter checksum 96.68 Actual checksum A does not match 96.71 Approved checksum A, and/or when 96.55 Checksum control word, bit 9 = 1 (Approved checksum B): if the parameter checksum 96.69 Actual checksum B does not match 96.72 Approved checksum B. 	No action																											
	No action	No action taken. (The checksum feature is not in use.)	0																											
	Pure event	Drive generates an event log entry B686 Checksum mismatch .	1																											
	Warning	Drive generates warning A686 Checksum mismatch .	2																											
	Warning and prevent start	Drive generates warning A686 Checksum mismatch . Starting the drive is prevented.	3																											
	Fault	Drive trips on fault 6200 Checksum mismatch .	4																											

No.	Name/Value	Description	Def/FbEq16																								
96.55	<i>Checksum control word</i>	<p>Bits 8...9 select which comparison(s) are made:</p> <ul style="list-style-type: none"> Bit 8 = 1 (<i>Approved checksum A</i>): 96.68 <i>Actual checksum A</i> is compared to 96.71 <i>Approved checksum A</i>, and/or Bit 9 = 1 (<i>Approved checksum A</i>): if 96.69 <i>Actual checksum B</i> is compared to 96.72 <i>Approved checksum B</i>. <p>Bits 12...13 select approved (reference) checksum parameter(s) into which the actual checksum(s) from parameter(s) are copied:</p> <ul style="list-style-type: none"> Bit 12 = 1 (<i>Set approved checksum A</i>): Value of 96.68 <i>Actual checksum A</i> is copied into 96.71 <i>Approved checksum A</i>, and/or Bit 13 = 1 (<i>Set approved checksum B</i>): Value of 96.69 <i>Actual checksum B</i> copied into 96.72 <i>Approved checksum B</i>. 	0000h																								
<table border="1"> <thead> <tr> <th>Bit</th> <th>Name</th> <th>Description</th> </tr> </thead> <tbody> <tr> <td>0...7</td> <td>Reserved</td> <td></td> </tr> <tr> <td>8</td> <td>Approved checksum A</td> <td>1 = Enabled: Checksum A (96.71) is observed. 0 = Disabled.</td> </tr> <tr> <td>9</td> <td>Approved checksum B</td> <td>1 = Enabled: Checksum B (96.72) is observed. 0 = Disabled.</td> </tr> <tr> <td>10...11</td> <td>Reserved</td> <td></td> </tr> <tr> <td>12</td> <td>Set approved checksum A</td> <td>1 = Set: Copy value of 96.68 into 96.71. 0 = Done (copy has been made).</td> </tr> <tr> <td>13</td> <td>Set approved checksum B</td> <td>1 = Set: Copy value of 96.69 into 96.72. 0 = Done (copy has been made).</td> </tr> <tr> <td>14...15</td> <td>Reserved</td> <td></td> </tr> </tbody> </table>				Bit	Name	Description	0...7	Reserved		8	Approved checksum A	1 = Enabled: Checksum A (96.71) is observed. 0 = Disabled.	9	Approved checksum B	1 = Enabled: Checksum B (96.72) is observed. 0 = Disabled.	10...11	Reserved		12	Set approved checksum A	1 = Set: Copy value of 96.68 into 96.71. 0 = Done (copy has been made).	13	Set approved checksum B	1 = Set: Copy value of 96.69 into 96.72. 0 = Done (copy has been made).	14...15	Reserved	
Bit	Name	Description																									
0...7	Reserved																										
8	Approved checksum A	1 = Enabled: Checksum A (96.71) is observed. 0 = Disabled.																									
9	Approved checksum B	1 = Enabled: Checksum B (96.72) is observed. 0 = Disabled.																									
10...11	Reserved																										
12	Set approved checksum A	1 = Set: Copy value of 96.68 into 96.71. 0 = Done (copy has been made).																									
13	Set approved checksum B	1 = Set: Copy value of 96.69 into 96.72. 0 = Done (copy has been made).																									
14...15	Reserved																										
	0000h...FFFFh	Checksum control word.	1 = 1																								
96.68	<i>Actual checksum A</i>	<p>Displays the actual parameter configuration checksum. Checksum A calculation does not include</p> <ul style="list-style-type: none"> fieldbus settings. <p>The parameters included in the calculation are user editable parameters in parameter groups 10...13, 15, 19...25, 28, 30...32, 34...37, 40...41, 43, 45...46, 70...74, 76, 80, 94...99.</p> <p>See also section <i>Parameter checksum calculation</i> (page 232).</p>	-																								
	00000000h...FFFFFFFFh	Actual checksum.	-																								
96.69	<i>Actual checksum B</i>	<p>Displays the actual parameter configuration checksum B. Checksum B calculation does not include</p> <ul style="list-style-type: none"> fieldbus settings motor data settings energy data settings. <p>The parameters included in the calculation are user editable parameters in parameter groups 10...13, 15, 19...25, 28, 30...32, 34, 35...37, 40...41, 43, 46, 70...74, 76, 80, 94...97.</p> <p>See also section <i>Parameter checksum calculation</i> (page 232).</p>	-																								
	00000000h...FFFFFFFFh	Actual checksum.	-																								

No.	Name/Value	Description	Def/FbEq16
96.70	<i>Disable adaptive program</i>	Enables/disables the adaptive program (if present). See also section <i>Adaptive programming</i> (page 113).	Yes
	No	Adaptive program enabled.	0
	Yes	Adaptive program disabled.	1
96.71	<i>Approved checksum A</i>	Approved (reference) checksum A.	0h
	0000000h... FFFFFFFFh	Approved checksum A.	-
96.72	<i>Approved checksum B</i>	Approved (reference) checksum B.	0h
	0000000h... FFFFFFFFh	Approved checksum B.	-
96.78	<i>550 Compatibility mode</i>	Enables/disables a Modbus user to access a select set of parameters using legacy register numbering. See the supported parameters in section <i>Parameters supported by Modbus legacy compatibility</i> on page 630. Note: This parameter will be replaced by parameters <i>96.78 Legacy Modbus mapping</i> and <i>96.79 Legacy control profile</i> in firmware versions 2.15 or later.	Disable
	Disable	Using legacy register numbering disabled.	0
	Enable	Using legacy register numbering enabled.	1
	Enabled, DCU profile only	Using legacy control profile enabled. For use with some external option modules, for example, FDNA-01.	2
96.78	<i>Legacy Modbus mapping</i>	This parameter enables ACx550 Modbus register mapping on ACx580 drives, for registers currently supported. Enabling this parameter will change the drive's Modbus register mapping to match that of the ACx550. This parameter is typically used in situations where an ACx580 drive is replacing an ACx550 drive that had been communicating via Modbus to an external controller. Activation of this parameter allows the ACx580 drive to emulate the ACx550 drive for certain Modbus registers and eliminates the need to adjust the external controller's code for those Modbus registers. This sets parameter <i>58.33 Addressing mode</i> value to <i>Mode 0</i> .	Disable
	Disable	The ACx580 drive will use the Modbus register mapping defined for the ACx580 drive.	0
	Enable	The ACx580 drive will use the Modbus register mapping defined for the ACx550 drive (for the currently supported registers).	1

No.	Name/Value	Description	Def/FbEq16
96.79	<i>Legacy control profile</i>	<p>This parameter enables ACx550 control profiles on ACx580 drives. Note that if the parameter selection changes, also parameter 58.25 Control profile changes to a matching selection and the parameter is locked.</p> <p>This feature is useful when replacing an existing ACx580 drive with a new ACx580 drive when it is not easy to change the control program.</p> <p>This parameter is typically used in situations where an ACx580 drive is replacing an ACx550 drive that had been communicating with an external controller via Modbus. This parameter allows the ACx580 drive to use the same control profiles as the ACx550 drive and eliminates the need to adjust the external controller's code for drive control.</p>	<i>Not selected</i>
	Not selected	The ACx580 drive will use whichever profile is selected by parameter 58.25 Control profile .	0
	DCU profile	The ACx580 drive will use the DCU profile from the ACx550 application. Parameter 58.25 Control profile value will be set to DCU Profile .	1
	ABB drives full	This selection is the same as setting parameter 58.25 Control profile value to ABB Drives .	2
	ABB drives limited	The ACx580 drive will use the ABB drives limited profile from the ACx550 application. Parameter 58.25 Control profile value is set to ABB Drives .	3
96.100	<i>Change user pass code</i>	<p>(Visible when user lock is open)</p> <p>To change the current user pass code, enter a new code into this parameter as well as 96.101 Confirm user pass code. A warning will be active until the new pass code is confirmed. To cancel changing the pass code, close the user lock without confirming. To close the lock, enter an invalid pass code in parameter 96.02 Pass code, activate parameter 96.08 Control board boot, or cycle the power.</p> <p>See also section Parameter checksum calculation (page 232).</p>	10000000
	10000000... 99999999	New user pass code.	-
96.101	<i>Confirm user pass code</i>	<p>(Visible when user lock is open)</p> <p>Confirms the new user pass code entered in 96.100 Change user pass code.</p>	
	10000000... 99999999	Confirmation of new user pass code.	-

No.	Name/Value	Description	Def/FbEq16																																							
96.102	User lock functionality	<p>(Visible when user lock is open)</p> <p>Selects the actions or functionalities to be prevented by the user lock. Note that the changes made will take effect only when the user lock is closed. See parameter 96.02 Pass code.</p> <p>Note: We recommend you select all the actions and functionalities unless otherwise required by the application.</p>	1000b																																							
<table border="1"> <thead> <tr> <th>Bit</th> <th>Name</th> <th>Information</th> </tr> </thead> <tbody> <tr> <td>0</td> <td>Disable ABB access levels</td> <td>1 = ABB access levels (service, advanced programmer, etc.; see 96.03) disabled</td> </tr> <tr> <td>1</td> <td>Freeze parameter lock state</td> <td>1 = Changing the parameter lock state prevented, ie, pass code 358 has no effect</td> </tr> <tr> <td>2</td> <td>Disable file download</td> <td>1 = Loading of files to drive prevented. This applies to <ul style="list-style-type: none"> firmware upgrades parameter restore loading an adaptive program changing home view of control panel editing drive texts editing the favorite parameters list on control panel configuration settings made through control panel such as time/date formats and enabling/disabling clock display. </td> </tr> <tr> <td>3</td> <td colspan="2">Reserved</td> </tr> <tr> <td>4</td> <td>Disable backups</td> <td>0 = Backups are enabled. 1 = Backups are disabled.</td> </tr> <tr> <td>5</td> <td>Override lock</td> <td>1 = Override locked. Group 70 Override parameters and reference or control chain parameters that have been selected to be used for override are write protected.</td> </tr> <tr> <td>6</td> <td>Protect application</td> <td>1 = Creating a backup and restoring from a backup prevented.</td> </tr> <tr> <td>7</td> <td>Disable panel Bluetooth</td> <td>1 = Bluetooth disabled on ACH-AP-W control panel. If the drive is part of a panel bus, Bluetooth is disabled on all control panels.</td> </tr> <tr> <td>8</td> <td>Protect AP</td> <td>0 = backup operation is allowed and AP will be part of the backup file. 1 = backup operation is allowed but AP is protected and will not be part of the backup file. Note: Access to AP is prevented when this bit is set.</td> </tr> <tr> <td>9...10</td> <td colspan="2">Reserved</td> </tr> <tr> <td>11</td> <td>Disable OEM access level 1</td> <td>1 = OEM access level 1 disabled</td> </tr> <tr> <td>12</td> <td>Disable OEM access level 2</td> <td>1 = OEM access level 2 disabled</td> </tr> </tbody> </table>				Bit	Name	Information	0	Disable ABB access levels	1 = ABB access levels (service, advanced programmer, etc.; see 96.03) disabled	1	Freeze parameter lock state	1 = Changing the parameter lock state prevented, ie, pass code 358 has no effect	2	Disable file download	1 = Loading of files to drive prevented. This applies to <ul style="list-style-type: none"> firmware upgrades parameter restore loading an adaptive program changing home view of control panel editing drive texts editing the favorite parameters list on control panel configuration settings made through control panel such as time/date formats and enabling/disabling clock display. 	3	Reserved		4	Disable backups	0 = Backups are enabled. 1 = Backups are disabled.	5	Override lock	1 = Override locked. Group 70 Override parameters and reference or control chain parameters that have been selected to be used for override are write protected.	6	Protect application	1 = Creating a backup and restoring from a backup prevented.	7	Disable panel Bluetooth	1 = Bluetooth disabled on ACH-AP-W control panel. If the drive is part of a panel bus, Bluetooth is disabled on all control panels.	8	Protect AP	0 = backup operation is allowed and AP will be part of the backup file. 1 = backup operation is allowed but AP is protected and will not be part of the backup file. Note: Access to AP is prevented when this bit is set.	9...10	Reserved		11	Disable OEM access level 1	1 = OEM access level 1 disabled	12	Disable OEM access level 2	1 = OEM access level 2 disabled
Bit	Name	Information																																								
0	Disable ABB access levels	1 = ABB access levels (service, advanced programmer, etc.; see 96.03) disabled																																								
1	Freeze parameter lock state	1 = Changing the parameter lock state prevented, ie, pass code 358 has no effect																																								
2	Disable file download	1 = Loading of files to drive prevented. This applies to <ul style="list-style-type: none"> firmware upgrades parameter restore loading an adaptive program changing home view of control panel editing drive texts editing the favorite parameters list on control panel configuration settings made through control panel such as time/date formats and enabling/disabling clock display. 																																								
3	Reserved																																									
4	Disable backups	0 = Backups are enabled. 1 = Backups are disabled.																																								
5	Override lock	1 = Override locked. Group 70 Override parameters and reference or control chain parameters that have been selected to be used for override are write protected.																																								
6	Protect application	1 = Creating a backup and restoring from a backup prevented.																																								
7	Disable panel Bluetooth	1 = Bluetooth disabled on ACH-AP-W control panel. If the drive is part of a panel bus, Bluetooth is disabled on all control panels.																																								
8	Protect AP	0 = backup operation is allowed and AP will be part of the backup file. 1 = backup operation is allowed but AP is protected and will not be part of the backup file. Note: Access to AP is prevented when this bit is set.																																								
9...10	Reserved																																									
11	Disable OEM access level 1	1 = OEM access level 1 disabled																																								
12	Disable OEM access level 2	1 = OEM access level 2 disabled																																								
0000h...FFFFh		Selection of actions to be prevented by user lock.	1 = 1																																							

No.	Name/Value	Description	Def/FbEq16
97 Motor control			
97.01	<i>Switching frequency reference</i>	<p>Defines the switching frequency of the drive that is used as long as the drive stays below the thermal limit. See section <i>Switching frequency</i> on page 200.</p> <p>Higher switching frequency results in lower acoustic motor noise. Lower switching frequency generates less switching losses and reduce EMC emissions.</p> <p>Notes:</p> <ul style="list-style-type: none"> If you have a multimotor system, contact your local ABB representative. With an ABB EX motor, follow the instructions given in the ABB EX motor documentation. 	4 kHz
	2 kHz	2 kHz.	2
	4 kHz	4 kHz.	4
	8 kHz	8 kHz.	8
	12 kHz	12 kHz.	12
97.02	<i>Minimum switching frequency</i>	<p>Lowest switching frequency value that is allowed. Depends on the frame size.</p> <p>When drive is reaching the thermal limit, it will automatically start to reduce the switching frequency until the minimum allowed value is reached. Once the minimum has been reached, the drive will automatically start limiting the output current to keep the temperature below the thermal limit. Inverter temperature is shown by parameter <i>05.11 Inverter temperature</i>.</p> <p>Note:</p> <ul style="list-style-type: none"> With an ABB EX motor, follow the instructions given in the ABB EX motor documentation. 	2 kHz
	1.5 kHz	1.5 kHz. Not for all frame sizes.	1
	2 kHz	2 kHz.	2
	4 kHz	4 kHz.	4
	8 kHz	8 kHz.	8
	12 kHz	12 kHz.	12
97.03	<i>Slip gain</i>	<p>Defines the slip gain which is used to improve the estimated motor slip. 100% means full slip gain; 0% means no slip gain. The default value is 100%. Other values can be used if a static speed error is detected despite having the setting at full slip gain.</p> <p>Example (with nominal load and nominal slip of 40 rpm): A 1000 rpm constant speed reference is given to the drive. Despite having full slip gain (= 100%), a manual tachometer measurement from the motor axis gives a speed value of 998 rpm. The static speed error is 1000 rpm - 998 rpm = 2 rpm. To compensate the error, the slip gain should be increased to 105% (2 rpm / 40 rpm = 5%).</p>	100%
	0...200%	Slip gain.	1 = 1%

No.	Name/Value	Description	Def/FbEq16
97.04	<i>Voltage reserve</i>	<p>Defines the minimum allowed voltage reserve. When the voltage reserve has decreased to the set value, the drive enters the field weakening area.</p> <p>Note: This is an expert level parameter and should not be adjusted without appropriate skill.</p> <p>If the intermediate circuit DC voltage $U_{dc} = 550 \text{ V}$ and the voltage reserve is 5%, the RMS value of the maximum output voltage in steady-state operation is</p> $0.95 \times 550 \text{ V} / \sqrt{2} = 369 \text{ V}$ <p>The dynamic performance of the motor control in the field weakening area can be improved by increasing the voltage reserve value, but the drive enters the field weakening area earlier.</p>	-2%
	-5...50%	Voltage reserve.	1 = 1%
97.05	<i>Flux braking</i>	<p>Defines the level of flux braking power. (Other stopping and braking modes can be configured in parameter group 21 Start/stop mode).</p> <p>Note: This is an expert level parameter and should not be adjusted without appropriate skill.</p>	<i>Disabled</i>
	Disabled	Flux braking is disabled.	0
	Moderate	Flux level is limited during the braking. Deceleration time is longer compared to full braking.	1
	Full	<p>Maximum braking power. Almost all available current is used to convert the mechanical braking energy to thermal energy in the motor.</p> <p> WARNING! Using full flux braking heats up the motor especially in cyclic operation. Make sure that the motor can withstand this if you have a cyclic application.</p>	2
97.08	<i>Optimizer minimum torque</i>	<p>This parameter can be used to improve the control dynamics of a synchronous reluctance motor or a salient permanent magnet synchronous motor.</p> <p>As a rule of thumb, define a level to which the output torque must rise with minimum delay. This will increase the motor current and improve the torque response at low speeds.</p>	0.0%
	0.0 ... 1600.0%	Optimizer torque limit.	10 = 1%
97.11	<i>TR tuning</i>	<p>Rotor time constant tuning.</p> <p>This parameter can be used to improve torque accuracy in closed-loop control of an induction motor. Normally, the motor identification run provides sufficient torque accuracy, but manual fine-tuning can be applied in exceptionally demanding applications to achieve optimal performance.</p> <p>Note: This is an expert level parameter and should not be adjusted without appropriate skill.</p>	100%
	25...400%	Rotor time constant tuning.	1 = 1%

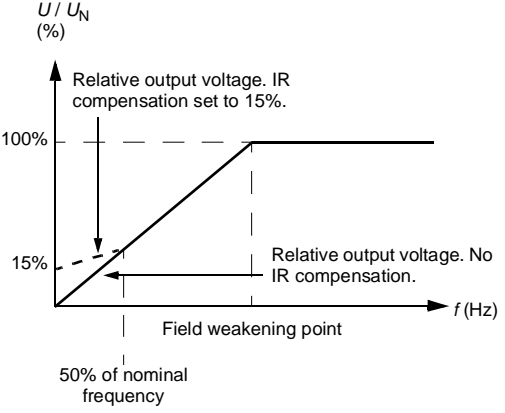
No.	Name/Value	Description	Def/FbEq16																		
97.13	<i>IR compensation</i>	<p>Defines the relative output voltage boost at zero speed (IR compensation). The function is useful in applications with a high break-away torque where vector control cannot be applied.</p>  <p>Typical IR compensation values are shown below.</p> <table border="1" data-bbox="341 726 845 805"> <thead> <tr> <th colspan="6">3-phase $U_N = 400\text{ V (380...415 V)}$ drives</th> </tr> <tr> <th>P_N (kW)</th> <td>3</td> <td>7.5</td> <td>15</td> <td>37</td> <td>132</td> </tr> <tr> <th>IR compensation (%)</th> <td>2.3</td> <td>1.7</td> <td>1.3</td> <td>1.1</td> <td>0.6</td> </tr> </thead> </table> <p>See also section <i>IR compensation for scalar motor control</i> on page 193.</p>	3-phase $U_N = 400\text{ V (380...415 V)}$ drives						P_N (kW)	3	7.5	15	37	132	IR compensation (%)	2.3	1.7	1.3	1.1	0.6	%
3-phase $U_N = 400\text{ V (380...415 V)}$ drives																					
P_N (kW)	3	7.5	15	37	132																
IR compensation (%)	2.3	1.7	1.3	1.1	0.6																
	0.00...50.00%	Voltage boost at zero speed in percent of nominal motor voltage.	1 = 1%																		
97.15	<i>Motor model temperature adaptation</i>	Enables the motor model temperature adaptation. Estimated motor temperature can be used to adapt temperature dependent parameters (for example, resistances) of motor model.	<i>Disabled</i>																		
	Disabled	Temperature adaptation disabled.	0																		
	Estimated temperature	Temperature adaptation with motor temperature estimate (parameter <i>35.01 Motor estimated temperature</i>).	1																		
97.16	<i>Stator temperature factor</i>	Tunes the motor temperature dependence of stator parameters (stator resistance).	50%																		
	0...200%	Tuning factor.	1 = 1%																		
97.17	<i>Rotor temperature factor</i>	Tunes the motor temperature dependence of rotor parameters (eg. rotor resistance).	100%																		
	0...200%	Tuning factor.	1 = 1%																		
97.20	<i>U/f ratio</i>	<p>Selects the form for the U/f (voltage to frequency) ratio below field weakening point. For scalar control only.</p> <p>Note:</p> <ul style="list-style-type: none"> The U/f function cannot be used with energy optimization; if <i>45.11 Energy optimizer</i> is set to <i>Enable</i>, parameter <i>97.20 U/f ratio</i> is ignored. 	<i>Squared</i>																		
	Linear	Linear ratio for constant torque applications.	0																		

No.	Name/Value	Description	Def/FbEq16
	Squared	Squared ratio for centrifugal pump and fan applications. With squared U/f ratio the noise level is lower for most operating frequencies. Not recommended for permanent magnet motors.	1
97.48	<i>UDC stabilizer</i>	Enables or disables the DC bus voltage stabilizer.	<i>Disabled</i>
	Disabled	DC bus voltage stabilizer disabled.	0
	Enabled min	DC bus voltage stabilizer enabled, minimum stabilization.	50
	Enabled mild	DC bus voltage stabilizer enabled, mild stabilization.	100
	Enabled medium	DC bus voltage stabilizer enabled, medium stabilization.	300
	Enabled strong	DC bus voltage stabilizer enabled, strong stabilization.	500
	Enabled max	DC bus voltage stabilizer enabled, maximum stabilization.	800
97.49	<i>Slip gain for scalar</i>	Sets gain for slip compensation in percent when the drive is operating in scalar control mode. A squirrel-cage motor slips under load. Increasing the frequency as the motor torque increases compensates for the slip. Note: This parameter is only effective in scalar motor control mode (parameter <i>99.04 Motor control mode</i> is set to <i>Scalar</i>).	0%
	0...200%	0% = No slip compensation. 0...200% = Increasing slip compensation. 100% means full slip compensation according to parameter <i>99.08 Motor nominal frequency</i> and <i>99.09 Motor nominal speed</i> .	1 = 1%
97.94	<i>IR comp max frequency</i>	Sets the frequency at which IR compensation set by parameter <i>97.13 IR compensation</i> reaches 0 V. Unit is percent of the motor nominal frequency.	50.0%
	1.0...200.0%	Frequency.	1 = 1%
97.135	<i>UDC ripple</i>	Calculates ripple voltage.	-
	0.0...200.0 V	Voltage	1 = 1 V

98 User motor parameters		Motor values supplied by the user that are used in the motor model. These parameters are useful for non-standard motors, or to just get more accurate motor control of the motor on site. A better motor model always improves the shaft performance.	
98.01	<i>User motor model mode</i>	Activates the motor model parameters <i>98.02...98.12</i> and <i>98.14</i> . Notes: <ul style="list-style-type: none"> Parameter value is automatically set to zero when ID run is selected by parameter <i>99.13 ID run requested</i>. The values of parameters <i>98.02...98.12</i> are then updated according to the motor characteristics identified during the ID run. Measurements made directly from the motor terminals during the ID run are likely to produce slightly different values than those on a data sheet from a motor manufacturer. This parameter cannot be changed while the drive is running. 	<i>Not selected</i>
	Not selected	Parameters <i>98.02...98.12</i> inactive.	0
	Motor parameters	The values of parameters <i>98.02...98.12</i> are used as the motor model.	1

No.	Name/Value	Description	Def/FbEq16
98.02	<i>Rs user</i>	Defines the stator resistance R_S of the motor model. With a star-connected motor, R_S is the resistance of one winding. With a delta-connected motor, R_S is one-third of the resistance of one winding.	0.00000 p.u.
	0.00000...0.50000 p.u.	Stator resistance in per unit.	
98.03	<i>Rr user</i>	Defines the rotor resistance R_R of the motor model. Note: This parameter is valid only for asynchronous motors.	0.00000 p.u.
	0.00000...0.50000 p.u.	Rotor resistance in per unit.	
98.04	<i>Lm user</i>	Defines the main inductance L_M of the motor model. Note: This parameter is valid only for asynchronous motors.	0.00000 p.u.
	0.00000...10.0000 0 p.u.	Main inductance in per unit.	
98.05	<i>SigmaL user</i>	Defines the leakage inductance σL_S . Note: This parameter is valid only for asynchronous motors.	0.00000 p.u.
	0.00000...1.00000 p.u.	Leakage inductance in per unit.	
98.06	<i>Ld user</i>	Defines the direct axis (synchronous) inductance. Note: This parameter is valid only for permanent magnet motors.	0.00000 p.u.
	0.00000...10.0000 0 p.u	Direct axis inductance in per unit.	
98.07	<i>Lq user</i>	Defines the quadrature axis (synchronous) inductance. Note: This parameter is valid only for permanent magnet motors.	0.00000 p.u.
	0.00000...10.0000 0 p.u	Quadrature axis inductance in per unit.	
98.08	<i>PM flux user</i>	Defines the permanent magnet flux. Note: This parameter is valid only for permanent magnet motors.	0.00000 p.u.
	0.00000... 2.00000 p.u	Permanent magnet flux in per unit.	
98.09	<i>Rs user SI</i>	Defines the stator resistance R_S of the motor model.	0.00000 ohm
	0.00000...100.000 00 ohm	Stator resistance.	100 = 1 ohm
98.10	<i>Rr user SI</i>	Defines the rotor resistance R_R of the motor model. Note: This parameter is valid only for asynchronous motors.	0.00000 ohm
	0.00000...100.000 00 ohm	Rotor resistance.	100 = 1 ohm
98.11	<i>Lm user SI</i>	Defines the main inductance L_M of the motor model. Note: This parameter is valid only for asynchronous motors.	0.00 mH
	0.00...100000.00 mH	Main inductance.	1 = 1 mH
98.12	<i>SigmaL user SI</i>	Defines the leakage inductance σL_S . Note: This parameter is valid only for asynchronous motors.	0.00 mH
	0.00...100000.00 mH	Leakage inductance.	1 = 1 mH

No.	Name/Value	Description	Def/FbEq16
98.13	<i>Ld user SI</i>	Defines the direct axis (synchronous) inductance. Note: This parameter is valid only for permanent magnet motors.	0.00 mH
	0.00...100000.00 mH	Direct axis inductance.	1 = 1 mH
98.14	<i>Lq user SI</i>	Defines the quadrature axis (synchronous) inductance. Note: This parameter is valid only for permanent magnet motors.	0.00 mH
	0.00...100000.00 mH	Quadrature axis inductance.	1 = 1 mH
99 Motor data			
99.03	<i>Motor type</i>	Selects the motor type. Note: This parameter cannot be changed while the drive is running.	<i>Asynchronous motor</i>
	Asynchronous motor	Standard squirrel cage AC induction motor (asynchronous induction motor).	0
	Permanent magnet motor	Permanent magnet motor. Three-phase AC synchronous motor with permanent magnet rotor and sinusoidal BackEMF voltage. Note: With permanent magnet motors special attention must be paid on setting the motor nominal values correctly in parameter group <i>99 Motor data</i> . You must use vector control. If the nominal BackEMF voltage of the motor is not available, a full ID run should be performed for improving performance.	1
	SynRM	Synchronous reluctance motor. Three-phase AC synchronous motor with salient pole rotor without permanent magnets. With synchronous reluctance motors you must use vector control.	2
	PMSynRM	Permanent Magnet Assisted Synchronous Reluctance Motor	3
99.04	<i>Motor control mode</i>	Selects the motor control mode.	<i>Scalar</i>
	Vector	Vector control. Vector control has better accuracy than scalar control but cannot be used in all situations (see selection <i>Scalar</i> below). Requires motor identification run (ID run). See parameter <i>99.13 ID run requested</i> . Notes: <ul style="list-style-type: none"> In vector control the drive performs a standstill ID run at the first start if ID run has not been previously performed. A new start command is required after standstill ID run. To achieve a better motor control performance, you can perform a normal ID run without load. See also section <i>Operating modes of the drive</i> (page 111).	0

No.	Name/Value	Description	Def/FbEq16
	Scalar	<p>Scalar control. Suitable for most applications, if top performance is not required.</p> <p>Motor identification run is not required.</p> <p>Note: Scalar control must be used in the following situations:</p> <ul style="list-style-type: none"> with multimotor systems 1) if the load is not equally shared between the motors, 2) if the motors are of different sizes, or 3) if the motors are going to be changed after the motor identification (ID run) if the nominal current of the motor is less than 1/6 of the nominal output current of the drive if the drive is used with no motor connected (for example, for test purposes). <p>Note: Correct motor operation requires that the magnetizing current of the motor does not exceed 90% of the nominal current of the inverter.</p> <p>See also section Operating modes of the drive (page 111).</p>	1
99.06	Motor nominal current	<p>Defines the nominal motor current. Must be equal to the value on the motor rating plate. If multiple motors are connected to the drive, enter the total current of the motors.</p> <p>Notes:</p> <ul style="list-style-type: none"> Correct motor operation requires that the magnetizing current of the motor does not exceed 90% of the nominal current of the drive. This parameter cannot be changed while the drive is running. <p>For 16-bit scaling, see parameter 46.05 Current scaling.</p>	0.0 A
	0.0...6400.0 A	Nominal current of the motor. The allowable range is $1/6 \dots 2 \times I_N$ of the drive ($0 \dots 2 \times I_N$ with scalar control mode).	1 = 10.01 A
99.07	Motor nominal voltage	<p>Defines the nominal motor voltage supplied to the motor. This setting must match the value on the rating plate of the motor.</p> <p>Notes:</p> <ul style="list-style-type: none"> With permanent magnet motors, the nominal voltage is the BackEMF voltage at nominal speed of the motor. If the voltage is given as voltage per rpm, for example, 60 V per 1000 rpm, the voltage for a nominal speed of 3000 rpm is $3 \times 60 \text{ V} = 180 \text{ V}$. The stress on the motor insulation is always dependent on the drive supply voltage. This also applies to the case where the motor voltage rating is lower than that of the drive and the supply. This parameter cannot be changed while the drive is running. 	0.0 V
	0.0...960.0 V	Nominal voltage of the motor.	10 = 1 V
99.08	Motor nominal frequency	<p>Defines the nominal motor frequency. This setting must match the value on the rating plate of the motor.</p> <p>Note: This parameter cannot be changed while the drive is running.</p>	50.00 Hz
	0.00...500.00 Hz	Nominal frequency of the motor.	10 = 1 Hz
99.09	Motor nominal speed	<p>Defines the nominal motor speed. The setting must match the value on the rating plate of the motor.</p> <p>Note: This parameter cannot be changed while the drive is running.</p>	0 rpm
	0...30000 rpm	Nominal speed of the motor.	1 = 1 rpm

No.	Name/Value	Description	Def/FbEq16
99.10	<i>Motor nominal power</i>	Defines the nominal motor power. The setting must match the value on the rating plate of the motor. If multiple motors are connected to the drive, enter the total power of the motors. The unit is selected by parameter 96.16 Unit selection . Note: This parameter cannot be changed while the drive is running. For 16-bit scaling, see parameter 46.04 Power scaling .	0.00 kW or hp
	0.00... 10000.00 kW or 0.00... 13404.83 hp	Nominal power of the motor.	1 = 10.01 unit
99.11	<i>Motor nominal cos ?</i>	Defines the cosphi of the motor for a more accurate motor model. The value is not obligatory, but is useful with an asynchronous motor, especially when performing a standstill identification run. With a permanent magnet or synchronous reluctance motor, this value is not needed. Notes: <ul style="list-style-type: none"> Do not enter an estimated value. If you do not know the exact value, leave the parameter at zero. This parameter cannot be changed while the drive is running. 	0.00
	0.00...1.00	Cosphi of the motor.	100 = 1
99.12	<i>Motor nominal torque</i>	Defines the nominal motor shaft torque for a more accurate motor model. Not obligatory. The unit is selected by parameter 96.16 Unit selection . Note: This parameter cannot be changed while the drive is running.	0.000 N·m or lb·ft
	0.000... 4000000.000 N·m or 0.000... 2950248.597 lb·ft	Nominal motor torque.	1 = 100 unit

No.	Name/Value	Description	Def/FbEq16
99.13	<i>ID run requested</i>	<p>Selects the type of the motor identification routine (ID run) performed at the next start of the drive. During the ID run, the drive will identify the characteristics of the motor for optimum motor control.</p> <p>If no ID run has been performed yet (or if default parameter values have been restored using parameter 96.06 Parameter restore), this parameter is automatically set to <i>Standstill</i>, signifying that an ID run must be performed.</p> <p>After the ID run, the drive stops and this parameter is automatically set to <i>None</i>.</p> <p>Notes:</p> <ul style="list-style-type: none"> To ensure that the ID run can work properly, the drive limits in group 30 (maximum speed and minimum speed, and maximum torque and minimum torque) must be large enough (the range specified by the limits must be wide enough. If, for example, speed limits are less than the motor nominal speed, the ID run cannot be completed. With a permanent magnet or synchronous reluctance motor, a <i>Normal</i>, <i>Reduced</i> or <i>Standstill</i> ID run requires that the motor shaft is NOT locked and the load torque is less than 10%. With scalar control mode (99.04 Motor control mode = Scalar), the ID run is not requested automatically. However, an ID run can be performed for more accurate torque estimation. Once the ID run is activated, it can be canceled by stopping the drive. The ID run must be performed every time any of the motor parameters (99.04, 99.06...99.12) have been changed. Ensure that the Safe Torque Off and emergency stop circuits (if any) are closed during the ID run. Mechanical brake (if present) is not opened by the logic for the ID run. This parameter cannot be changed while the drive is running. 	<i>None</i>
	None	No motor ID run is requested. This mode can be selected only if the ID run (<i>Normal</i> / <i>Reduced</i> / <i>Standstill</i>) has already been performed once.	0
	Normal	<p>Normal ID run. Guarantees good control accuracy for all cases. The ID run takes about 90 seconds. This mode should be selected whenever it is possible.</p> <p>Notes:</p> <ul style="list-style-type: none"> If the load torque will be higher than 20% of motor nominal torque, or if the machinery is not able to withstand the nominal torque transient during the ID run, then the driven machinery must be de-coupled from the motor during a Normal ID run. Check the direction of rotation of the motor before starting the ID run. During the run, the motor will rotate in the forward direction. <p> WARNING! The motor will run at up to approximately 50...100% of the nominal speed during the ID run. ENSURE THAT IT IS SAFE TO RUN THE MOTOR BEFORE PERFORMING THE ID RUN!</p>	1

No.	Name/Value	Description	Def/FbEq16
	Reduced	<p>Reduced ID run. This mode should be selected instead of the <i>Normal</i> ID run if</p> <ul style="list-style-type: none"> mechanical losses are higher than 20% (ie. the motor cannot be de-coupled from the driven equipment), or if flux reduction is not allowed while the motor is running (ie. in case of a motor with an integrated brake supplied from the motor terminals). <p>With this ID run mode, the resultant motor control in the field weakening area or at high torques is not necessarily as accurate as motor control following a Normal ID run. Reduced ID run is completed faster than the Normal ID run (< 90 seconds).</p> <p>Note: Check the direction of rotation of the motor before starting the ID run. During the run, the motor will rotate in the forward direction.</p> <p> WARNING! The motor will run at up to approximately 50...100% of the nominal speed during the ID run. ENSURE THAT IT IS SAFE TO RUN THE MOTOR BEFORE PERFORMING THE ID RUN!</p>	2
	Standstill	<p>Standstill ID run. The motor is injected with DC current. With an AC induction (asynchronous) motor, the motor shaft is not rotated. With a permanent magnet motor, the shaft can rotate up to half a revolution.</p> <p>Note: This mode should be selected only if the <i>Normal</i> or <i>Reduced</i> ID run is not possible due to the restrictions caused by the connected mechanics (for example, with lift or crane applications).</p>	3
	Reserved		4...7
	Adaptive	<p>Adaptive ID run. Improves the motor model accuracy during normal operation of the drive.</p> <p>The drive performs a Standstill ID run first. Motor parameters are then updated with better accuracy during an adaptation sequence when following user's driving profile. When the adaptation is complete, parameters <i>99.14 Last ID run performed</i> changes from Standstill to Adaptive. Motor parameters are updated automatically and the user is not required to update any other parameter.</p> <p>Note: For vector control only.</p>	8
<i>99.14</i>	<i>Last ID run performed</i>	Shows the type of ID run that was performed last. For more information about the different modes, see the selections of parameter <i>99.13 ID run requested</i> .	<i>None</i>
	None	No ID run has been performed.	0
	Normal	<i>Normal</i> ID run.	1
	Reduced	<i>Reduced</i> ID run.	2
	Standstill	<i>Standstill</i> ID run.	3
	Reserved		4...7
	Adaptive	<i>Adaptive</i> ID run.	8
<i>99.15</i>	<i>Motor polepairs calculated</i>	Calculated number of pole pairs in the motor.	-
	0...1000	Number of pole pairs.	1 = 1

No.	Name/Value	Description	Def/FbEq16
99.16	<i>Motor phase order</i>	<p>Switches the rotation direction of motor. This parameter can be used if the motor turns in the wrong direction (for example, because of the wrong phase order in the motor cable), and correcting the cabling is considered impractical.</p> <p>Note:</p> <ul style="list-style-type: none"> Changing this parameter does not affect speed reference polarities, so positive speed reference will rotate the motor forward. The phase order selection just ensures that "forward" is in fact the correct direction. 	<i>U V W</i>
	U V W	Normal.	0
	U W V	Reversed rotation direction.	1

Differences in the default values between 50 Hz and 60 Hz supply frequency settings

Parameter *95.20 HW options word 1 bit 0 Supply frequency 60 Hz* changes the drive parameter default values according to the supply frequency, 50 Hz or 60 Hz. The bit is set according to the market before the drive is delivered.

If you need to change from 50 Hz to 60 Hz, or vice versa, change the value of the bit and then do a complete reset to the drive. After that you have to reselect the macro to be used.

The table below shows the parameters whose default values depend on the supply frequency setting. The supply frequency setting, with the type designation of the drive, also affects Group *99 Motor data* parameter values though these parameters are not listed in the table.

No.	Name	95.20 HW options word 1 bit Supply frequency 60 Hz = 50 Hz	95.20 HW options word 1 bit Supply frequency 60 Hz = 60 Hz
11.45	<i>Freq in 1 at scaled max</i>	1500.000	1800.000
12.20	<i>AI1 scaled at AI1 max</i>	50.000	60.000
13.18	<i>AO1 source max</i>	50.0	60.0
22.26	<i>Constant speed 1</i>	300.00 rpm	360.00 rpm
22.27	<i>Constant speed 2</i>	600.00 rpm	720.00 rpm
22.28	<i>Constant speed 3</i>	900 .00 rpm	1080.00 rpm
22.29	<i>Constant speed 4</i>	1200.00 rpm	1440.00 rpm
22.30	<i>Constant speed 5</i>	1500.00 rpm	1800.00 rpm
22.31	<i>Constant speed 6</i>	2400.00 rpm	2880.00 rpm
22.32	<i>Constant speed 7</i>	3000.00 rpm	3600.00 rpm
28.26	<i>Constant frequency 1</i>	5.00 Hz	6.00 Hz
28.27	<i>Constant frequency 2</i>	10.00 Hz	12.00 Hz
28.28	<i>Constant frequency 3</i>	15.00 Hz	18.00 Hz
28.29	<i>Constant frequency 4</i>	20.00 Hz	24.00 Hz
28.30	<i>Constant frequency 5</i>	25.00 Hz	30.00 Hz
28.31	<i>Constant frequency 6</i>	40.00 Hz	48.00 Hz
28.32	<i>Constant frequency 7</i>	50.00 Hz	60.00 Hz
30.12	<i>Maximum speed</i>	1500.00 rpm	1800.00 rpm
30.14	<i>Maximum frequency</i>	50.00 Hz	60.00 Hz
31.26	<i>Stall speed limit</i>	150.00 rpm	180.00 rpm
31.27	<i>Stall frequency limit</i>	15.00 Hz	18.00 Hz
31.30	<i>Overspeed trip margin</i>	500.00 rpm	500.00 rpm
46.01	<i>Speed scaling</i>	1500.00 rpm	1800.00 rpm
46.02	<i>Frequency scaling</i>	50.00 Hz	60.00 Hz
46.31	<i>Above speed limit</i>	1500.00 rpm	1800.00 rpm
46.32	<i>Above frequency limit</i>	50.00 Hz	60.00 Hz

Parameters supported by Modbus legacy compatibility

Legacy compatibility mode is a way to communicate with a legacy drive in such a way that it looks like the legacy drive over Modbus RTU or Modbus TCP. This mode can be enabled by changing parameter [96.78 Legacy Modbus mapping](#) to *Enable*.

In the legacy compatibility mode all supported parameters can be read as if the drive were a legacy drive. Some parameters are read only and do not support writes. See the table below to see which parameters support writes.

Legacy parameter	Name	Read/Write	Legacy parameter	Name	Read/Write
01.01	SPEED & DIR	Read only	01.34	COMM RO WORD	Read only
01.02	SPEED	Read only	01.35	COMM VALUE 1	Read only
01.03	OUTPUT FREQ	Read only	01.36	COMM VALUE 2	Read only
01.04	CURRENT	Read only	01.41	MWH COUNTER	Read only
01.05	TORQUE	Read only	01.43	DRIVE ON TIME	Read only
01.06	POWER	Read only	01.45	MOTOR TEMP	Read only
01.07	DC BUS VOLTAGE	Read only	01.50	CB TEMP	Read only
01.09	OUTPUT VOLTAGE	Read only	01.74	SAVED KWH	Read only
01.10	DRIVE TEMP	Read only	01.75	SAVED MWH	Read only
01.11	EXTERNAL REF 1	Read only	01.77	SAVED AMOUNT 2	Read only
01.13	CTRL LOCATION	Read only	01.78	SAVED CO2	Read only
01.14	RUN TIME	Read only	03.01	FB CMD WORD 1	Read only
01.15	KWH COUNTER	Read only	03.02	FB CMD WORD 2	Read only
01.18	DI 1-3 STATUS	Read only	03.03	FB STS WORD 1	Read only
01.19	DI 4-6 STATUS	Read only	03.04	FB STS WORD 2	Read only
01.20	AI 1	Read only	03.05	FAULT WORD 1	Read only
01.21	AI 2	Read only	03.06	FAULT WORD 2	Read only
01.22	RO 1-3 STATUS	Read only	03.07	FAULT WORD 3	Read only
01.23	RO 4-6 STATUS	Read only	03.08	ALARM WORD 1	Read only
01.24	AO 1	Read only	03.09	ALARM WORD 2	Read only
01.25	AO 2	Read only	04.01	LAST FAULT	Read only
01.26	PID 1 OUTPUT	Read only	04.12	PREVIOUS FAULT 1	Read only
01.27	PID 2 OUTPUT	Read only	04.13	PREVIOUS FAULT 2	Read only
01.28	PID 1 SETPNT	Read only	10.01	EXT1 COMMANDS	Read/Write
01.29	PID 2 SETPNT	Read only	10.02	EXT2 COMMANDS	Read/Write
01.30	PID 1 FBK	Read only	10.03	DIRECTION	Read/Write
01.31	PID 2 FBK	Read only	10.04	JOGGING SEL	Read/Write
01.32	PID 1 DEVIATION	Read only	11.02	EXT1/EXT2 SEL	Read/Write
01.33	PID 2 DEVIATION	Read only	11.03	REF1 SELECT	Read/Write

Legacy parameter	Name	Read/Write
11.04	REF1 MIN	Read/Write
11.05	REF1 MAX	Read/Write
11.06	REF2 SEL	Read/Write
11.07	REF2 MIN	Read/Write
11.08	REF2 MAX	Read/Write
12.01	CONST SPEED SEL	Read/Write
12.02	CONST SPEED 1	Read/Write
12.03	CONST SPEED 2	Read/Write
12.04	CONST SPEED 3	Read/Write
12.05	CONST SPEED 4	Read/Write
12.06	CONST SPEED 5	Read/Write
12.07	CONST SPEED 6	Read/Write
15.02	CONST SPEED 7	Read/Write
15.03	AO1 CONTENT MAX	Read/Write
15.04	MINIMUM AO1	Read/Write
15.05	MAXIMUM AO1	Read/Write
15.08	AO2 CONTENT MIN	Read/Write
15.09	AO2 CONTENT MAX	Read/Write
15.10	MINIMUM AO2	Read/Write
15.11	MAXIMUM AO2	Read/Write
16.01	RUN ENABLE	Read/Write
16.02	PARAMETER LOCK	Read/Write
16.03	PASS CODE	Read/Write
16.08	START ENABLE 1	Read/Write
16.09	START ENABLE 2	Read/Write
20.01	MINIMUM SPEED	Read/Write
20.02	MAXIMUM SPEED	Read/Write
20.03	MAX CURRENT	Read/Write
20.06	UNDERVOLT CRTL	Read/Write
20.07	MINIMUM FREQ	Read/Write
20.08	MAXIMUM FREQ	Read/Write
20.13	MIN TORQUE SEL	Read/Write
20.14	MAX TORQUE SEL	Read/Write
20.15	MIN TORQUE 1	Read/Write
20.16	MIN TORQUE 2	Read/Write
20.17	MAX TORQUE 1	Read/Write
20.18	MAX TORQUE 2	Read/Write
21.02	STOP FUNCTION	Read/Write
21.03	DC MAGN TIME	Read/Write

Legacy parameter	Name	Read/Write
21.05	DC HOLD SPEED	Read/Write
21.06	DC CURR REF	Read/Write
21.09	EMERG STOP SEL	Read/Write
21.12	ZERO SPEED DELAY	Read/Write
21.13	START DELAY	Read/Write
22.02	ACCELER TIME 1	Read/Write
22.03	DECELER TIME 1	Read/Write
22.04	RAMP SHAPE 1	Read/Write
22.05	ACCELER TIME 2	Read/Write
22.06	DECELER TIME 2	Read/Write
22.07	RAMP SHAPE 2	Read/Write
22.08	EMERG DEC TIME	Read/Write
23.01	PROP GAIN	Read/Write
23.02	INTEGRATION TIME	Read/Write
23.03	DERIVATION TIME	Read/Write
23.04	ACC COMPENSATION	Read/Write
30.02	PANEL COMM ERR	Read/Write
30.03	EXTERNAL REF 1	Read/Write
30.04	EXTERNAL REF 2	Read/Write
30.05	MOT THERM POT	Read/Write
30.06	MOT THERM TIME	Read/Write
30.07	MOT LOAD CURVE	Read/Write
30.08	ZERO SPEED LOAD	Read/Write
30.09	BREAK POINT FREQ	Read/Write
30.10	STALL FUNCTION	Read/Write
30.11	STALL FREQUENCY	Read/Write
30.12	STALL TIME	Read/Write
30.17	EARTH FAULT	Read/Write
30.18	COMM FAULT FUNC	Read/Write
30.19	COMM FAULT TIME	Read/Write
30.22	AI2 FAULT LIMIT	Read/Write
30.23	WIRING FAULT	Read/Write
33.01	FIRMWARE	Read only
33.02	LOADING PACKAGE	Read only
33.03	TEST DATE	Read only
33.04	DRIVE RATING	Read only
40.01	GAIN	Read/Write
40.02	INTEGRATION TIME	Read/Write
40.03	DERIVATION TIME	Read/Write

Legacy parameter	Name	Read/Write
40.04	PID DERIV FILTER	Read/Write
40.08	0% VALUE	Read/Write
40.09	100% VALUE	Read/Write
40.10	SET POINT SEL	Read/Write
40.11	INTERNAL SETPNT	Read/Write
40.12	SETPOINT MIN	Read/Write
40.13	SETPOINT MAX	Read/Write
40.14	FBK SEL	Read/Write
40.15	FBK MULTIPLIER	Read/Write
40.16	ACT 1 INPUT	Read/Write
40.17	ACT 2 INPUT	Read/Write
40.24	PID SLEEP DELAY	Read/Write
40.25	WAKE-UP DEV	Read/Write
40.26	WAKE-UP DELAY	Read/Write
40.27	PID 1 PARAM SET	Read/Write
41.01	GAIN	Read/Write
41.02	INTEGRATION TIME	Read/Write
41.03	DERIVATION TIME	Read/Write
41.04	PID DERIV FILTER	Read/Write
41.08	0% VALUE	Read/Write
41.09	100% VALUE	Read/Write
41.10	SET POINT SEL	Read/Write

Legacy parameter	Name	Read/Write
41.11	INTERNAL SETPNT	Read/Write
41.12	SETPOINT MIN	Read/Write
41.13	SETPOINT MAX	Read/Write
41.14	FBK SEL	Read/Write
41.15	FBK MULTIPLIER	Read/Write
41.16	ACT 1 INPUT	Read/Write
41.17	ACT 2 INPUT	Read/Write
41.24	PID SLEEP DELAY	Read/Write
41.25	WAKE-UP DEV	Read/Write
41.26	WAKE-UP DELAY	Read/Write
42.11	INTERNAL SETPNT	Read/Write
53.05	EFB CTRL PROFILE	Read/Write
99.01	LANGUAGE	Read/Write
99.04	MOTOR CTRL MODE	Read/Write
99.05	MOTOR NOM VOLT	Read/Write
99.06	MOTOR NOM CURR	Read/Write
99.07	MOTOR NOM FREQ	Read/Write
99.08	MOTOR NOM SPEED	Read/Write
99.09	MOTOR NOM POWER	Read/Write
99.10	ID RUN	Read/Write
99.15	MOTOR COS PHI	Read/Write



Additional parameter data

What this chapter contains

This chapter lists the parameters with some additional data such as their ranges and 32-bit fieldbus scaling. For parameter descriptions, see chapter [Parameters](#) (page 357).

Terms and abbreviations

Term	Definition
Actual signal	Signal measured or calculated by the drive. Usually can only be monitored but not adjusted; some counter-type signals can however be reset.
Analog src	Analog source: the parameter can be set to the value of another parameter by choosing “Other”, and selecting the source parameter from a list. In addition to the “Other” selection, the parameter may offer other pre-selected settings.
Binary src	Binary source: the value of the parameter can be taken from a specific bit in another parameter value (“Other”). Sometimes the value can be fixed to 0 (false) or 1 (true). In addition, the parameter may offer other pre-selected settings.
Data	Data parameter
FbEq32	32-bit fieldbus equivalent: The scaling between the value shown on the control panel and the integer used in communication when a 32-bit value is selected for transmission to an external system. The corresponding 16-bit scalings are listed in chapter Parameters (page 357).
List	Selection list.

Term	Definition
No.	Parameter number.
PB	Packed Boolean (bit list).
Real	Real number.
Type	Parameter type. See Analog src , Binary src , List , PB , Real .

Fieldbus addresses

Refer to the *User's manual* of the fieldbus adapter.

Parameter groups 1...9

No.	Name	Type	Range	Unit	FbEq32
01 Actual values					
01.01	Motor speed used	Real	-30000.00...30000.00	rpm	100 = 1 rpm
01.02	Motor speed estimated	Real	-30000.00...30000.00	rpm	100 = 1 rpm
01.03	Motor speed %	Real	-1000.00...1000.00	%	100 = 1%
01.06	Output frequency	Real	-500.00...500.00	Hz	100 = 1 Hz
01.07	Motor current	Real	0.00...30000.00	A	100 = 1 A
01.08	Motor current % of motor nom	Real	0.0...1000.0	%	10 = 1%
01.09	Motor current % of drive nom	Real	0.0...1000.0	%	10 = 1%
01.10	Motor torque	Real	-1600.0...1600.0	%	10 = 1%
01.11	DC voltage	Real	0.00...2000.00	V	100 = 1 V
01.13	Output voltage	Real	0...2000	V	1 = 1 V
01.14	Output power	Real	-32768.00...32767.00	kW	100 = 1 kW
01.15	Output power % of motor nom	Real	-300.00...300.00	%	100 = 1%
01.17	Motor shaft power	Real	-32768.00...32767.00	kW or hp	100 = 1 unit
01.18	Inverter GWh counter	Real	0...65535	GWh	1 = 1 GWh
01.19	Inverter MWh counter	Real	0...1000	MWh	1 = 1 MWh
01.20	Inverter kWh counter	Real	0...1000	kWh	1 = 1 kWh
01.24	Flux actual %	Real	0...200	%	1 = 1%
01.30	Nominal torque scale	Real	0.000...4000000	N·m or lb-ft	1000 = 1 unit
01.50	Current hour kWh	Real	0.00...1000000.00	kWh	100 = 1 kWh
01.51	Previous hour kWh	Real	0.00...1000000.00	kWh	100 = 1 kWh
01.52	Current day kWh	Real	0.00...1000000.00	kWh	100 = 1 kWh
01.53	Previous day kWh	Real	0.00...1000000.00	kWh	100 = 1 kWh
01.54	Cumulative inverter energy	Real	-200000000.0... 200000000.0	kWh	1 = 1 kWh
01.55	Inverter GWh counter (resettable)	Real	0...65535	GWh	1 = 1 GWh
01.56	Inverter MWh counter (resettable)	Real	0...1000	MWh	1 = 1 MWh
01.57	Inverter kWh counter (resettable)	Real	0...1000	kWh	1 = 1 kWh
01.58	Cumulative inverter energy (resettable)	Real	-200000000.0... 200000000.0	kWh	1 = 1 kWh
01.61	Abs motor speed used	Real	0.00...30000.00	rpm	100 = 1 rpm
01.62	Abs motor speed %	Real	0.00...1000.00%	%	100 = 1%
01.63	Abs output frequency	Real	0.00...500.00 Hz	Hz	100 = 1 Hz
01.64	Abs motor torque	Real	0.0...1600.0	%	10 = 1%
01.65	Abs output power	Real	0.00...32767.00	kW	100 = 1 kW
01.66	Abs output power % motor nom	Real	0.00...300.00	%	100 = 1%
01.68	Abs motor shaft power	Real	0.00...32767.00	kW or hp	100 = 1 unit
01.72	U-phase RMS current	Real	0.00...30000.00	A	100 = 1 A

No.	Name	Type	Range	Unit	FbEq32
01.73	V-phase RMS current	<i>Real</i>	0.00...30000.00	A	100 = 1 A
01.74	W-phase RMS current	<i>Real</i>	0.00...30000.00	A	100 = 1 A
03 Input references					
03.01	Panel reference	<i>Real</i>	-100000.00...100000.00	-	100 = 1
03.02	Panel reference remote	<i>Real</i>	-100000.00...100000.00	-	100 = 1
03.05	FB A reference 1	<i>Real</i>	-100000.00...100000.00	-	100 = 1
03.06	FB A reference 2	<i>Real</i>	-100000.00...100000.00	-	100 = 1
03.09	EFB reference 1	<i>Real</i>	-30000.00...30000.00	-	100 = 1
03.10	EFB reference 2	<i>Real</i>	-30000.00...30000.00	-	100 = 1
04 Warnings and faults					
04.01	Tripping fault	<i>Data</i>	0000h...FFFFh	-	1 = 1
04.02	Active fault 2	<i>Data</i>	0000h...FFFFh	-	1 = 1
04.03	Active fault 3	<i>Data</i>	0000h...FFFFh	-	1 = 1
04.06	Active warning 1	<i>Data</i>	0000h...FFFFh	-	1 = 1
04.07	Active warning 2	<i>Data</i>	0000h...FFFFh	-	1 = 1
04.08	Active warning 3	<i>Data</i>	0000h...FFFFh	-	1 = 1
04.11	Latest fault	<i>Data</i>	0000h...FFFFh	-	1 = 1
04.12	2nd latest fault	<i>Data</i>	0000h...FFFFh	-	1 = 1
04.13	3rd latest fault	<i>Data</i>	0000h...FFFFh	-	1 = 1
04.16	Latest warning	<i>Data</i>	0000h...FFFFh	-	1 = 1
04.17	2nd latest warning	<i>Data</i>	0000h...FFFFh	-	1 = 1
04.18	3rd latest warning	<i>Data</i>	0000h...FFFFh	-	1 = 1
04.40	Event word 1	<i>PB</i>	0000h...FFFFh	-	1 = 1
04.41	Event word 1 bit 0 code	<i>Data</i>	0000h...FFFFh	-	1 = 1
04.43	Event word 1 bit 1 code	<i>Data</i>	0000h...FFFFh	-	1 = 1
04.45, 04.47, 04.49,	
04.71	Event word 1 bit 15 code	<i>Data</i>	0000h...FFFFh	-	1 = 1
05 Diagnostics					
05.01	On-time counter	<i>Real</i>	0...65535	d	1 = 1 d
05.02	Run-time counter	<i>Real</i>	0...65535	d	1 = 1 d
05.03	Hours run	<i>Real</i>	0.0...429496729.5	h	10 = 1 h
05.04	Fan on-time counter	<i>Real</i>	0...65535	d	1 = 1 d
05.08	Cabinet temperature	<i>Real</i>	-40...120	°C or °F	10 = 1 unit
05.10	Control board temperature	<i>Real</i>	-100...300	°C or °F	10 = 1 unit
05.11	Inverter temperature	<i>Real</i>	-40.0...160.0	%	10 = 1 %
05.20	Diagnostic word 1	<i>PB</i>	0000h...FFFFh	-	1 = 1
05.21	Diagnostic word 2	<i>PB</i>	0000h...FFFFh	-	1 = 1
05.22	Diagnostic word 3	<i>PB</i>	0000h...FFFFh	-	1 = 1
05.80	Motor speed at fault	<i>Real</i>	-30000...30000.00	rpm	100 = 1 rpm

No.	Name	Type	Range	Unit	FbEq32
05.81	Output frequency at fault	<i>Real</i>	-500.00...500.00	Hz	100 = 1 Hz
05.82	DC voltage at fault	<i>Real</i>	0.00...2000.00	V	100 = 1 V
05.83	Motor current at fault	<i>Real</i>	0.00...30000.00	A	100 = 1 A
05.84	Motor torque at fault	<i>Real</i>	-1600.0...1600.0	%	10 = 1%
05.85	Main status word at fault	<i>PB</i>	0000h...FFFFh	-	1 = 1
05.86	DI delayed status at fault	<i>PB</i>	0000h...FFFFh	-	1 = 1
05.87	Inverter temperature at fault	<i>Real</i>	-40.0...160.0	%	10 = 1%
05.88	Reference used at fault	<i>Real</i>	-500.00...500.00 or -30000.00...30000.00	Hz or rpm	100 = 1 unit
05.89	HVAC status word at fault	<i>PB</i>	0000h...FFFFh	-	1 = 1
05.99	BIO-01 DIP switch status	<i>PB</i>	0000h...FFFFh	-	1 = 1
06 Control and status words					
06.01	Main control word	<i>PB</i>	0000h...FFFFh	-	1 = 1
06.11	Main status word	<i>PB</i>	0000h...FFFFh	-	1 = 1
06.16	Drive status word 1	<i>PB</i>	0000h...FFFFh	-	1 = 1
06.17	Drive status word 2	<i>PB</i>	0000h...FFFFh	-	1 = 1
06.18	Start inhibit status word	<i>PB</i>	0000h...FFFFh	-	1 = 1
06.19	Speed control status word	<i>PB</i>	0000h...FFFFh	-	1 = 1
06.20	Constant speed status word	<i>PB</i>	0000h...FFFFh	-	1 = 1
06.21	Drive status word 3	<i>PB</i>	0000h...FFFFh	-	1 = 1
06.22	HVAC status word	<i>PB</i>	0000h...FFFFh	-	1 = 1
06.29	MSW bit 10 selection	<i>Binary src</i>	-	-	1 = 1
06.30	MSW bit 11 selection	<i>Binary src</i>	-	-	1 = 1
06.31	MSW bit 12 selection	<i>Binary src</i>	-	-	1 = 1
06.32	MSW bit 13 selection	<i>Binary src</i>	-	-	1 = 1
06.33	MSW bit 14 selection	<i>Binary src</i>	-	-	1 = 1
07 System info					
07.03	Drive rating id	<i>List</i>	0...999	-	1 = 1
07.04	Firmware name	<i>List</i>	-	-	1 = 1
07.05	Firmware version	<i>Data</i>	-	-	1 = 1
07.06	Loading package name	<i>List</i>	-	-	1 = 1
07.07	Loading package version	<i>Data</i>	-	-	1 = 1
07.11	Cpu usage	<i>Real</i>	0...100	%	1 = 1%
07.25	Customization package name	<i>Data</i>	-	-	1 = 1
07.26	Customization package version	<i>Data</i>	-	-	1 = 1
07.30	Adaptive program status	<i>PB</i>	0000h...FFFFh	-	1 = 1
07.31	AP sequence state	<i>Data</i>	0...20	-	1 = 1

No.	Name	Type	Range	Unit	FbEq32
07.35	Drive configuration	<i>PB</i>	0000h...FFFFh	-	1 = 1
07.36	Drive configuration 2	<i>PB</i>	0000h...FFFFh	-	1 = 1

Parameter groups 10...99

No.	Name	Type	Range	Unit	FbEq32
10 Standard DI, RO					
10.01	DI status	<i>PB</i>	0000h...FFFFh	-	1 = 1
10.02	DI delayed status	<i>PB</i>	0000h...FFFFh	-	1 = 1
10.03	DI force selection	<i>PB</i>	0000h...FFFFh	-	1 = 1
10.04	DI forced data	<i>PB</i>	0000h...FFFFh	-	1 = 1
10.05	DI1 ON delay	<i>Real</i>	0.0...3000.0	s	10 = 1 s
10.06	DI1 OFF delay	<i>Real</i>	0.0...3000.0	s	10 = 1 s
10.07	DI2 ON delay	<i>Real</i>	0.0...3000.0	s	10 = 1 s
10.08	DI2 OFF delay	<i>Real</i>	0.0...3000.0	s	10 = 1 s
10.09	DI3 ON delay	<i>Real</i>	0.0...3000.0	s	10 = 1 s
10.10	DI3 OFF delay	<i>Real</i>	0.0...3000.0	s	10 = 1 s
10.11	DI4 ON delay	<i>Real</i>	0.0...3000.0	s	10 = 1 s
10.12	DI4 OFF delay	<i>Real</i>	0.0...3000.0	s	10 = 1 s
10.13	DI5 ON delay	<i>Real</i>	0.0...3000.0	s	10 = 1 s
10.14	DI5 OFF delay	<i>Real</i>	0.0...3000.0	s	10 = 1 s
10.15	DI6 ON delay	<i>Real</i>	0.0...3000.0	s	10 = 1 s
10.16	DI6 OFF delay	<i>Real</i>	0.0...3000.0	s	10 = 1 s
10.21	RO status	<i>PB</i>	0000h...FFFFh	-	1 = 1
10.22	RO force selection	<i>PB</i>	0000h...FFFFh	-	1 = 1
10.23	RO forced data	<i>PB</i>	0000h...FFFFh	-	1 = 1
10.24	RO1 source	<i>Binary src</i>	-	-	1 = 1
10.25	RO1 ON delay	<i>Real</i>	0.0...3000.0	s	10 = 1 s
10.26	RO1 OFF delay	<i>Real</i>	0.0...3000.0	s	10 = 1 s
10.27	RO2 source	<i>Binary src</i>	-	-	1 = 1
10.28	RO2 ON delay	<i>Real</i>	0.0...3000.0	s	10 = 1 s
10.29	RO2 OFF delay	<i>Real</i>	0.0...3000.0	s	10 = 1 s
10.30	RO3 source	<i>Binary src</i>	-	-	1 = 1
10.31	RO3 ON delay	<i>Real</i>	0.0...3000.0	s	10 = 1 s
10.32	RO3 OFF delay	<i>Real</i>	0.0...3000.0	s	10 = 1 s
10.99	RO/DIO control word	<i>PB</i>	0000h...FFFFh	-	1 = 1
10.101	RO1 toggle counter	<i>Real</i>	0...4294967000	-	1 = 1
10.102	RO2 toggle counter	<i>Real</i>	0...4294967000	-	1 = 1
10.103	RO3 toggle counter	<i>Real</i>	0...4294967000	-	1 = 1
11 Standard DIO, FI, FO					
11.02	DIO delayed status	<i>PB</i>	0000h...FFFFh	-	1 = 1
11.03	DIO force selection	<i>PB</i>	0000h...FFFFh	-	1 = 1
11.04	DIO force data	<i>PB</i>	0000h...FFFFh	-	1 = 1

No.	Name	Type	Range	Unit	FbEq32
11.05	DIO1 configuration	List	0, 2	-	1 = 1
11.06	DIO1 output source	PB	0000h...FFFFh	-	1 = 1
11.07	DIO1 ON delay	Real	0.0...3000.0	s	10 = 1 s
11.08	DIO1 OFF delay	Real	0.0...3000.0	s	10 = 1 s
11.17	DI4 configuration	List	0...1	-	1 = 1
11.21	DI5 configuration	List	0...1	-	1 = 1
11.38	Freq in 1 actual value	Real	0...16000	Hz	1 = 1 Hz
11.39	Freq in 1 scaled value	Real	-32768.000...32767.000	-	1000 = 1
11.42	Freq in 1 min	Real	0...16000	Hz	1 = 1 Hz
11.43	Freq in 1 max	Real	0...16000	Hz	1 = 1 Hz
11.44	Freq in 1 at scaled min	Real	-32768.000...32767.000	-	1000 = 1
11.45	Freq in 1 at scaled max	Real	-32768.000...32767.000	-	1000 = 1
11.46	Freq in 2 actual value	Real	0...16000	Hz	1 = 1 Hz
11.47	Freq in 2 scaled value	Real	-32768.000...32767.000	-	1000 = 1
11.50	Freq in 2 min	Real	0...16000	Hz	1 = 1 Hz
11.51	Freq in 2 max	Real	0...16000	Hz	1 = 1 Hz
11.52	Freq in 2 at scaled min	Real	-32768.000...32767.000	-	1000 = 1
11.53	Freq in 2 at scaled max	Real	-32768.000...32767.000	-	1000 = 1
11.54	Freq out 1 actual value	Real	0...16000	Hz	1 = 1 Hz
11.55	Freq out 1 source	Analog src	-	-	1 = 1
11.58	Freq out 1 src min	Real	-32768.000...32767.000	-	1 = 1
11.59	Freq out 1 src max	Real	-32768.000...32767.000	-	1 = 1
11.60	Freq out 1 at src min	Real	0...16000	Hz	1 = 1 Hz
11.61	Freq out 1 at src max	Real	0...16000	Hz	1 = 1 Hz
12 Standard AI					
12.02	AI force selection	PB	0000h...FFFFh	-	1 = 1
12.03	AI supervision function	List	0...4	-	1 = 1
12.04	AI supervision selection	PB	0000h...FFFFh	-	1 = 1
12.05	AI supervision force	PB	0000h...FFFFh	-	1 = 1
12.11	AI1 actual value	Real	0.000...22.000 mA or 0.000...11.000 V	mA or V	1000 = 1 unit
12.12	AI1 scaled value	Real	-32768.000...32767.000	-	1000 = 1
12.13	AI1 forced value	Real	0.000...20.000 mA or 0.000...10.000 V	mA or V	1000 = 1 unit
12.15	AI1 unit selection	List	2, 10	-	1 = 1
12.16	AI1 filter time	Real	0.000...30.000	s	1000 = 1 s
12.17	AI1 min	Real	0.000...20.000 mA or 0.000...10.000 V	mA or V	1000 = 1 unit
12.18	AI1 max	Real	0.000...22.000 mA or 0.000...11.000 V	mA or V	1000 = 1 unit
12.19	AI1 scaled at AI1 min	Real	-32768.000...32767.000	-	1000 = 1
12.20	AI1 scaled at AI1 max	Real	-32768.000...32767.000	-	1000 = 1

No.	Name	Type	Range	Unit	FbEq32
12.21	AI2 actual value	<i>Real</i>	0.000...22.000 mA or 0.000...11.000 V	mA or V	1000 = 1 unit
12.22	AI2 scaled value	<i>Real</i>	-32768.000...32767.000	-	1000 = 1
12.23	AI2 forced value	<i>Real</i>	0.000...20.000 mA or 0.000...10.000 V	mA or V	1000 = 1 unit
12.25	AI2 unit selection	<i>List</i>	2, 10	-	1 = 1
12.26	AI2 filter time	<i>Real</i>	0.000...30.000	s	1000 = 1 s
12.27	AI2 min	<i>Real</i>	0.000...20.000 mA or 0.000...10.000 V	mA or V	1000 = 1 unit
12.28	AI2 max	<i>Real</i>	0.000...22.000 mA or 0.000...11.000 V	mA or V	1000 = 1 unit
12.29	AI2 scaled at AI2 min	<i>Real</i>	-32768.000...32767.000	-	1000 = 1
12.30	AI2 scaled at AI2 max	<i>Real</i>	-32768.000...32767.000	-	1000 = 1
12.101	AI1 percent value	<i>Real</i>	0.00...100.00	%	100 = 1%
12.102	AI2 percent value	<i>Real</i>	0.00...100.00	%	100 = 1%
12.110	AI dead band	<i>Real</i>	0.00...100.00	%	100 = 1%
13 Standard AO					
13.02	AO force selection	<i>PB</i>	0000h...FFFFh	-	1 = 1
13.11	AO1 actual value	<i>Real</i>	0.000...22.000 mA or 0.000...11000 V	mA or V	1000 = 1 unit
13.12	AO1 source	<i>Analog src</i>	-	-	1 = 1
13.13	AO1 forced value	<i>Real</i>	0.000...22.000 mA or 0.000...11000 V	mA or V	1000 = 1 unit
13.15	AO1 unit selection	<i>List</i>	2, 10	-	1 = 1
13.16	AO1 filter time	<i>Real</i>	0.000...30.000	s	1000 = 1 s
13.17	AO1 source min	<i>Real</i>	-32768.0...32767.0	-	10 = 1
13.18	AO1 source max	<i>Real</i>	-32768.0...32767.0	-	10 = 1
13.19	AO1 out at AO1 src min	<i>Real</i>	0.000...22.000 mA or 0.000...11000 V	mA or V	1000 = 1 unit
13.20	AO1 out at AO1 src max	<i>Real</i>	0.000...22.000 mA or 0.000...11000 V	mA or V	1000 = 1 unit
13.21	AO2 actual value	<i>Real</i>	0.000...22.000	mA	1000 = 1 mA
13.22	AO2 source	<i>Analog src</i>	-	-	1 = 1
13.23	AO2 forced value	<i>Real</i>	0.000...22.000	mA	1000 = 1 mA
13.26	AO2 filter time	<i>Real</i>	0.000...30.000	s	1000 = 1 s
13.27	AO2 source min	<i>Real</i>	-32768.0...32767.0	-	10 = 1
13.28	AO2 source max	<i>Real</i>	-32768.0...32767.0	-	10 = 1
13.29	AO2 out at AO2 src min	<i>Real</i>	0.000...22.000	mA	1000 = 1 mA
13.30	AO2 out at AO2 src max	<i>Real</i>	0.000...22.000	mA	1000 = 1 mA
13.91	AO1 data storage	<i>Real</i>	-327.68...327.67	-	100 = 1
13.92	AO2 data storage	<i>Real</i>	-327.68...327.67	-	100 = 1

No.	Name	Type	Range	Unit	FbEq32
15 I/O extension module					
15.01	Extension module type	<i>List</i>	0, 5...6	-	1 = 1
15.02	Detected extension module	<i>List</i>	0, 5...6	-	1 = 1
15.04	RO/DO status	<i>PB</i>	0000h...FFFFh	-	1 = 1
15.05	RO/DO force selection	<i>PB</i>	0000h...FFFFh	-	1 = 1
15.06	RO/DO forced data	<i>PB</i>	0000h...FFFFh	-	1 = 1
15.07	RO4 source	<i>Binary src</i>	-	-	1 = 1
15.08	RO4 ON delay	<i>Real</i>	0.0...3000.0	s	10 = 1 s
15.09	RO4 OFF delay	<i>Real</i>	0.0...3000.0	s	10 = 1 s
15.10	RO5 source	<i>Binary src</i>	-	-	1 = 1
15.11	RO5 ON delay	<i>Real</i>	0.0...3000.0	s	10 = 1 s
15.12	RO5 OFF delay	<i>Real</i>	0.0...3000.0	s	10 = 1 s
15.13	RO6 source	<i>Binary src</i>	-	-	1 = 1
15.14	RO6 ON delay	<i>Real</i>	0.0...3000.0	s	10 = 1 s
15.15	RO6 OFF delay	<i>Real</i>	0.0...3000.0	s	10 = 1 s
15.16	RO7 source	<i>Binary src</i>	-	-	1 = 1
15.17	RO7 ON delay	<i>Real</i>	0.0...3000.0	s	10 = 1 s
15.18	RO7 OFF delay	<i>Real</i>	0.0...3000.0	s	10 = 1 s
15.22	DO1 configuration	<i>List</i>	0, 2	-	1 = 1
15.23	DO1 source	<i>Binary src</i>	-	-	1 = 1
15.24	DO1 ON delay	<i>Real</i>	0.0...3000.0	s	10 = 1 s
15.25	DO1 OFF delay	<i>Real</i>	0.0...3000.0	s	10 = 1 s
15.32	Freq out 1 actual value	<i>Real</i>	0...16000	Hz	1 = 1 Hz
15.33	Freq out 1 source	<i>Analog src</i>	-	-	1 = 1
15.34	Freq out 1 src min	<i>Real</i>	-32768.0...32767.0	-	1000 = 1
15.35	Freq out 1 src max	<i>Real</i>	-32768.0...32767.0	-	1000 = 1
15.36	Freq out 1 at src min	<i>Real</i>	0...16000	Hz	1 = 1 Hz
15.37	Freq out 1 at src max	<i>Real</i>	0...16000	Hz	1 = 1 Hz
19 Operation mode					
19.01	Actual operation mode	<i>List</i>	1...6, 10, 20	-	1 = 1
19.11	Ext1/Ext2 selection	<i>Binary src</i>	-	-	1 = 1
19.18	HAND/OFF disable source	<i>Binary src</i>	-	-	1 = 1
19.19	HAND/OFF disable action	<i>List</i>	0...2	-	1 = 1
20 Start/stop/direction					
20.01	Ext1 commands	<i>List</i>	0...6, 11...12, 14	-	1 = 1

No.	Name	Type	Range	Unit	FbEq32
20.02	Ext1 start trigger type	List	0...1	-	1 = 1
20.03	Ext1 in1 source	Binary src	-	-	1 = 1
20.04	Ext1 in2 source	Binary src	-	-	1 = 1
20.05	Ext1 in3 source	Binary src	-	-	1 = 1
20.06	Ext2 commands	List	0...6, 11...12, 14	-	1 = 1
20.07	Ext2 start trigger type	List	0...1	-	1 = 1
20.08	Ext2 in1 source	Binary src	-	-	1 = 1
20.09	Ext2 in2 source	Binary src	-	-	1 = 1
20.10	Ext2 in3 source	Binary src	-	-	1 = 1
20.21	Direction	List	0...2	-	1 = 1
20.30	Enable signal warning function	PB	0000h...FFFFh	-	1 = 1
20.40	Run permissive	Binary src	-	-	1 = 1
20.41	Start interlock 1	Binary src	-	-	1 = 1
20.42	Start interlock 2	Binary src	-	-	1 = 1
20.43	Start interlock 3	Binary src	-	-	1 = 1
20.44	Start interlock 4	Binary src	-	-	1 = 1
20.45	Start interlock stop mode	List	0...2	-	1 = 1
20.46	Run permissive text	List	0...3, 5	-	1 = 1
20.47	Start interlock 1 text	List	0...1, 4...5, 8...9, 11...12, 14...15	-	1 = 1
20.48	Start interlock 2 text	List	0...1, 4...5, 8...9, 11...12, 14...15	-	1 = 1
20.49	Start interlock 3 text	List	0...1, 4...5, 8...9, 11...12, 14...15	-	1 = 1
20.50	Start interlock 4 text	List	0...1, 4...5, 8...9, 11...12, 14...15	-	1 = 1
20.51	Start interlock condition	List	0...1	-	1 = 1
21 Start/stop mode					
21.01	Start mode	List	0...2	-	1 = 1
21.02	Magnetization time	Real	0...10000	ms	1 = 1 ms
21.03	Stop mode	List	0...2	-	1 = 1
21.04	Emergency stop mode	List	0...2	-	1 = 1
21.05	Emergency stop source	Binary src	-	-	1 = 1
21.06	Zero speed limit	Real	0.00...30000.00	rpm	100 = 1 rpm

No.	Name	Type	Range	Unit	FbEq32
21.07	Zero speed delay	<i>Real</i>	0...30000	ms	1 = 1 ms
21.08	DC current control	<i>PB</i>	0000b...0011b	-	1 = 1
21.09	DC hold speed	<i>Real</i>	0.00...1000.00	rpm	100 = 1 rpm
21.10	DC current reference	<i>Real</i>	0.0...100.0	%	10 = 1%
21.11	Post magnetization time	<i>Real</i>	0...3000	s	1 = 1 s
21.14	Pre-heating input source	<i>Binary src</i>	-	-	1 = 1
21.15	Pre-heating time delay	<i>Real</i>	0...3000	s	1 = 1 s
21.16	Pre-heating current	<i>Real</i>	0.0...30.0	%	10 = 1%
21.18	Auto restart time	<i>Real</i>	0.0, 0.1...10.0	s	10 = 1 s
21.19	Scalar start mode	<i>List</i>	0...6	-	1 = 1
21.21	DC hold frequency	<i>Real</i>	0.00...1000.00	Hz	100 = 1 Hz
21.22	Start delay	<i>Real</i>	0.00...60.00	s	100 = 1 s
21.23	Smooth start	<i>Real</i>	0...2	-	1 = 1
21.24	Smooth start current	<i>Real</i>	10.0...200.0	%	100 = 1%
21.25	Smooth start speed	<i>Real</i>	2.0...100.0	%	100 = 1%
21.26	Torque boost current	<i>Real</i>	15.0...300.0	%	100 = 1%
21.27	Torque boost time	<i>Real</i>	0.0...60.0	s	10 = 1 s
21.30	Speed compensated stop mode	<i>Real</i>	0...3	-	1 = 1
21.31	Speed comp stop delay	<i>Real</i>	0.00...1000.00	s	100 = 1 s
21.32	Speed comp stop threshold	<i>Real</i>	0...100	%	1 = 1%
21.34	Force auto restart	<i>List</i>	0...1	-	1 = 1
22 Speed reference selection					
22.01	Speed ref unlimited	<i>Real</i>	-30000.00...30000.00	rpm	100 = 1 rpm
22.11	Ext1 speed ref1	<i>Analog src</i>	-	-	1 = 1
22.12	Ext1 speed ref2	<i>Analog src</i>	-	-	1 = 1
22.13	Ext1 speed function	<i>List</i>	0...5	-	1 = 1
22.18	Ext2 speed ref1	<i>Analog src</i>	-	-	1 = 1
22.19	Ext2 speed ref2	<i>Analog src</i>	-	-	1 = 1
22.20	Ext2 speed function	<i>List</i>	0...5	-	1 = 1
22.21	Constant speed function	<i>PB</i>	0000h...FFFFh	-	1 = 1
22.22	Constant speed sel1	<i>Binary src</i>	-	-	1 = 1
22.23	Constant speed sel2	<i>Binary src</i>	-	-	1 = 1
22.24	Constant speed sel3	<i>Binary src</i>	-	-	1 = 1
22.25	Constant speed sel4	<i>Binary src</i>	-	-	1 = 1

No.	Name	Type	Range	Unit	FbEq32
22.26	Constant speed 1	<i>Real</i>	-30000.00...30000.00	rpm	100 = 1 rpm
22.27	Constant speed 2	<i>Real</i>	-30000.00...30000.00	rpm	100 = 1 rpm
22.28	Constant speed 3	<i>Real</i>	-30000.00...30000.00	rpm	100 = 1 rpm
22.29	Constant speed 4	<i>Real</i>	-30000.00...30000.00	rpm	100 = 1 rpm
22.30	Constant speed 5	<i>Real</i>	-30000.00...30000.00	rpm	100 = 1 rpm
22.31	Constant speed 6	<i>Real</i>	-30000.00...30000.00	rpm	100 = 1 rpm
22.32	Constant speed 7	<i>Real</i>	-30000.00...30000.00	rpm	100 = 1 rpm
22.41	Speed ref safe	<i>Real</i>	-30000.00...30000.00	rpm	100 = 1 rpm
22.46	Constant speed sel5	<i>Binary src</i>	-	-	1 = 1
22.47	Constant speed sel6	<i>Binary src</i>	-	-	1 = 1
22.51	Critical speed function	<i>PB</i>	00b...11b	-	1 = 1
22.52	Critical speed 1 low	<i>Real</i>	-30000.00...30000.00	rpm	100 = 1 rpm
22.53	Critical speed 1 high	<i>Real</i>	-30000.00...30000.00	rpm	100 = 1 rpm
22.54	Critical speed 2 low	<i>Real</i>	-30000.00...30000.00	rpm	100 = 1 rpm
22.55	Critical speed 2 high	<i>Real</i>	-30000.00...30000.00	rpm	100 = 1 rpm
22.56	Critical speed 3 low	<i>Real</i>	-30000.00...30000.00	rpm	100 = 1 rpm
22.57	Critical speed 3 high	<i>Real</i>	-30000.00...30000.00	rpm	100 = 1 rpm
22.70	Motor potentiometer reference enable	<i>List</i>	0...2	-	1 = 1
22.71	Motor potentiometer function	<i>List</i>	0...4	-	1 = 1
22.72	Motor potentiometer initial value	<i>Real</i>	-32768.00...32767.00	-	100 = 1
22.73	Motor potentiometer up source	<i>Binary src</i>	-	-	1 = 1
22.74	Motor potentiometer down source	<i>Binary src</i>	-	-	1 = 1
22.75	Motor potentiometer ramp time	<i>Real</i>	0.0...3600.0	s	10 = 1 s
22.76	Motor potentiometer min value	<i>Real</i>	-32768.00...32767.00	-	100 = 1
22.77	Motor potentiometer max value	<i>Real</i>	-32768.00...32767.00	-	100 = 1
22.80	Motor potentiometer ref act	<i>Real</i>	-32768.00...32767.00	-	100 = 1
22.86	Speed reference act 6	<i>Real</i>	-30000.00...30000.00	rpm	100 = 1 rpm
22.87	Speed reference act 7	<i>Real</i>	-30000.00...30000.00	rpm	100 = 1 rpm
23 Speed reference ramp					
23.01	Speed ref ramp input	<i>Real</i>	-30000.00...30000.00	rpm	100 = 1 rpm
23.02	Speed ref ramp output	<i>Real</i>	-30000.00...30000.00	rpm	100 = 1 rpm
23.11	Ramp set selection	<i>Binary src</i>	-	-	1 = 1
23.12	Acceleration time 1	<i>Real</i>	0.000...1800.000	s	1000 = 1 s
23.13	Deceleration time 1	<i>Real</i>	0.000...1800.000	s	1000 = 1 s
23.14	Acceleration time 2	<i>Real</i>	0.000...1800.000	s	1000 = 1 s
23.15	Deceleration time 2	<i>Real</i>	0.000...1800.000	s	1000 = 1 s

No.	Name	Type	Range	Unit	FbEq32
23.23	Emergency stop time	<i>Real</i>	0.000...1800.000	s	1000 = 1 s
23.28	Variable slope enable	<i>List</i>	0...1	-	1 = 1
23.29	Variable slope rate	<i>Real</i>	2...30000	ms	1 = 1 ms
24 Speed reference conditioning					
24.01	Used speed reference	<i>Real</i>	-30000.00...30000.00	rpm	100 = 1 rpm
24.02	Used speed feedback	<i>Real</i>	-30000.00...30000.00	rpm	100 = 1 rpm
24.03	Speed error filtered	<i>Real</i>	-30000.0...30000.0	rpm	100 = 1 rpm
24.04	Speed error inverted	<i>Real</i>	-30000.0...30000.0	rpm	100 = 1 rpm
24.11	Speed correction	<i>Real</i>	-10000.00...10000.00	rpm	100 = 1 rpm
24.12	Speed error filter time	<i>Real</i>	0...10000	ms	1 = 1 ms
25 Speed control					
25.01	Torque reference speed control	<i>Real</i>	-1600.0...1600.0	%	10 = 1%
25.02	Speed proportional gain	<i>Real</i>	0.00...250.00	-	100 = 1
25.03	Speed integration time	<i>Real</i>	0.00...1000.00	s	100 = 1 s
25.04	Speed derivation time	<i>Real</i>	0.000...10.000	s	1000 = 1 s
25.05	Derivation filter time	<i>Real</i>	0...10000	ms	1 = 1 ms
25.06	Acc comp derivation time	<i>Real</i>	0.00...1000.00	s	100 = 1 s
25.07	Acc comp filter time	<i>Real</i>	0.0...1000.0	ms	10 = 1 ms
25.15	Proportional gain em stop	<i>Real</i>	1.00...250.00	-	100 = 1
25.30	Flux adaptation enable	<i>Real</i>	0.25...1.00	-	100 = 1
25.53	Torque prop reference	<i>Real</i>	-30000.0...30000.0	%	10 = 1%
25.54	Torque integral reference	<i>Real</i>	-30000.0...30000.0	%	10 = 1%
25.55	Torque deriv reference	<i>Real</i>	-30000.0...30000.0	%	10 = 1%
25.56	Torque acc compensation	<i>Real</i>	-30000.0...30000.0	%	10 = 1%
28 Frequency reference chain					
28.01	Frequency ref ramp input	<i>Real</i>	-500.00...500.00	Hz	100 = 1 Hz
28.02	Frequency ref ramp output	<i>Real</i>	-500.00...500.00	Hz	100 = 1 Hz
28.11	Ext1 frequency ref1	<i>Analog src</i>	-	-	1 = 1
28.12	Ext1 frequency ref2	<i>Analog src</i>	-	-	1 = 1
28.13	Ext1 frequency function	<i>List</i>	0...5	-	1 = 1
28.15	Ext2 frequency ref1	<i>Analog src</i>	-	-	1 = 1
28.16	Ext2 frequency ref2	<i>Analog src</i>	-	-	1 = 1
28.17	Ext2 frequency function	<i>List</i>	0...5	-	1 = 1
28.21	Constant frequency function	<i>PB</i>	00b...11b	-	1 = 1
28.22	Constant frequency sel1	<i>Binary src</i>	-	-	1 = 1
28.23	Constant frequency sel2	<i>Binary src</i>	-	-	1 = 1

No.	Name	Type	Range	Unit	FbEq32
28.24	Constant frequency sel3	<i>Binary src</i>	-	-	1 = 1
28.25	Constant frequency sel4	<i>Binary src</i>	-	-	1 = 1
28.26	Constant frequency 1	<i>Real</i>	-500.00...500.00	Hz	100 = 1 Hz
28.27	Constant frequency 2	<i>Real</i>	-500.00...500.00	Hz	100 = 1 Hz
28.28	Constant frequency 3	<i>Real</i>	-500.00...500.00	Hz	100 = 1 Hz
28.29	Constant frequency 4	<i>Real</i>	-500.00...500.00	Hz	100 = 1 Hz
28.30	Constant frequency 5	<i>Real</i>	-500.00...500.00	Hz	100 = 1 Hz
28.31	Constant frequency 6	<i>Real</i>	-500.00...500.00	Hz	100 = 1 Hz
28.32	Constant frequency 7	<i>Real</i>	-500.00...500.00	Hz	100 = 1 Hz
28.41	Frequency ref safe	<i>Real</i>	-500.00...500.00	Hz	100 = 1 Hz
28.46	Constant frequency sel5	<i>Binary src</i>	-	-	1 = 1
28.47	Constant frequency sel6	<i>Binary src</i>	-	-	1 = 1
28.51	Critical frequency function	<i>PB</i>	00b...11b	-	1 = 1
28.52	Critical frequency 1 low	<i>Real</i>	-500.00...500.00	Hz	100 = 1 Hz
28.53	Critical frequency 1 high	<i>Real</i>	-500.00...500.00	Hz	100 = 1 Hz
28.54	Critical frequency 2 low	<i>Real</i>	-500.00...500.00	Hz	100 = 1 Hz
28.55	Critical frequency 2 high	<i>Real</i>	-500.00...500.00	Hz	100 = 1 Hz
28.56	Critical frequency 3 low	<i>Real</i>	-500.00...500.00	Hz	100 = 1 Hz
28.57	Critical frequency 3 high	<i>Real</i>	-500.00...500.00	Hz	100 = 1 Hz
28.71	Freq ramp set selection	<i>Binary src</i>	-	-	1 = 1
28.72	Freq acceleration time 1	<i>Real</i>	0.000...1800.000	s	1000 = 1 s
28.73	Freq deceleration time 1	<i>Real</i>	0.000...1800.000	s	1000 = 1 s
28.74	Freq acceleration time 2	<i>Real</i>	0.000...1800.000	s	1000 = 1 s
28.75	Freq deceleration time 2	<i>Real</i>	0.000...1800.000	s	1000 = 1 s
28.76	Freq ramp in zero source	<i>Binary src</i>	-	-	1 = 1
28.92	Frequency ref act 3	<i>Real</i>	-500.00...500.00	Hz	100 = 1 Hz
28.96	Frequency ref act 7	<i>Real</i>	-500.00...500.00	Hz	100 = 1 Hz
28.97	Frequency ref unlimited	<i>Real</i>	-500.00...500.00	Hz	100 = 1 Hz
30 Limits					
30.01	Limit word 1	<i>PB</i>	0000h...FFFFh	-	1 = 1
30.02	Torque limit status	<i>PB</i>	0000h...FFFFh	-	1 = 1
30.11	Minimum speed	<i>Real</i>	-30000.00...30000.00	rpm	100 = 1 rpm
30.12	Maximum speed	<i>Real</i>	-30000.00...30000.00	rpm	100 = 1 rpm
30.13	Minimum frequency	<i>Real</i>	-500.00...500.00	Hz	100 = 1 Hz
30.14	Maximum frequency	<i>Real</i>	-500.00...500.00	Hz	100 = 1 Hz
30.17	Maximum current	<i>Real</i>	0.00...30000.00	A	100 = 1 A

No.	Name	Type	Range	Unit	FbEq32
30.18	Torq lim sel	<i>Binary src</i>	-	-	1 = 1
30.19	Minimum torque 1	<i>Real</i>	-1600.0...0.0	%	10 = 1%
30.20	Maximum torque 1	<i>Real</i>	0.0...1600.0	%	10 = 1%
30.21	Min torque 2 source	<i>Analog src</i>	-	-	1 = 1
30.22	Max torque 2 source	<i>Analog src</i>	-	-	1 = 1
30.23	Minimum torque 2	<i>Real</i>	-1600.0...0.0	%	10 = 1%
30.24	Maximum torque 2	<i>Real</i>	0.0...1600.0	%	10 = 1%
30.26	Power motoring limit	<i>Real</i>	0.00...600.00	%	100 = 1%
30.27	Power generating limit	<i>Real</i>	-600.00...0.00	%	100 = 1%
30.30	Overvoltage control	<i>List</i>	0...1	-	1 = 1
30.31	Undervoltage control	<i>List</i>	0...1	-	1 = 1
30.35	Thermal current limitation	<i>List</i>	0...1	-	1 = 1
30.36	Speed limit selection	<i>Binary src</i>	-	-	1 = 1
30.37	Minimum speed source	<i>Analog src</i>	-	-	1 = 1
30.38	Maximum speed source	<i>Analog src</i>	-	-	1 = 1
31 Fault functions					
31.01	External event 1 source	<i>Binary src</i>	-	-	1 = 1
31.02	External event 1 type	<i>List</i>	0...1	-	1 = 1
31.03	External event 2 source	<i>Binary src</i>	-	-	1 = 1
31.04	External event 2 type	<i>List</i>	0...1	-	1 = 1
31.05	External event 3 source	<i>Binary src</i>	-	-	1 = 1
31.06	External event 3 type	<i>List</i>	0...1	-	1 = 1
31.07	External event 4 source	<i>Binary src</i>	-	-	1 = 1
31.08	External event 4 type	<i>List</i>	0...1	-	1 = 1
31.09	External event 5 source	<i>Binary src</i>	-	-	1 = 1
31.10	External event 5 type	<i>List</i>	0...1	-	1 = 1
31.11	Fault reset selection	<i>Binary src</i>	-	-	1 = 1
31.12	Autoreset selection	<i>PB</i>	0000h...FFFFh	-	1 = 1
31.13	Selectable fault	<i>Real</i>	0000h...FFFFh	-	1 = 1
31.14	Number of trials	<i>Real</i>	0...5	-	1 = 1
31.15	Total trials time	<i>Real</i>	1.0...600.0	s	10 = 1 s
31.16	Delay time	<i>Real</i>	0.0...120.0	s	10 = 1 s
31.19	Motor phase loss	<i>List</i>	0...1	-	1 = 1

No.	Name	Type	Range	Unit	FbEq32
31.20	Earth fault	List	0...2	-	1 = 1
31.21	Supply phase loss	List	0...1	-	1 = 1
31.22	STO indication run/stop	List	0...5	-	1 = 1
31.23	Wiring or earth fault	List	0...1	-	1 = 1
31.24	Stall function	List	0...2	-	1 = 1
31.25	Stall current limit	Real	0.0...1600.0	%	10 = 1%
31.26	Stall speed limit	Real	0.00...10000.00	rpm	100 = 1 rpm
31.27	Stall frequency limit	Real	0.00...1000.00	Hz	100 = 1 Hz
31.28	Stall time	Real	0...3600	s	1 = 1 s
31.30	Overspeed trip margin	Real	0.00...10000.00	rpm	100 = 1 rpm
31.31	Frequency trip margin	Real	0.00...10000.00	Hz	100 = 1 Hz
31.32	Emergency ramp supervision	Real	0...300	%	1 = 1%
31.33	Emergency ramp supervision delay	Real	0...100	s	1 = 1 s
31.40	Disable warning messages	PB	0000h...FFFFh	-	1 = 1
	Fault action	List	0...1	-	1 = 1
32 Supervision					
32.01	Supervision status	PB	0000h...FFFFh	-	1 = 1
32.05	Supervision 1 function	List	0...7	-	1 = 1
32.06	Supervision 1 action	List	0...3	-	1 = 1
32.07	Supervision 1 signal	Analog src	-	-	1 = 1
32.08	Supervision 1 filter time	Real	0.000...30.000	s	1000 = 1 s
32.09	Supervision 1 low	Real	-21474836.00... 21474836.00	-	100 = 1
32.10	Supervision 1 high	Real	-21474836.00... 21474836.00	-	100 = 1
32.11	Supervision 1 hysteresis	Real	0.00...100000.00	-	100 = 1
32.15	Supervision 2 function	List	0...7	-	1 = 1
32.16	Supervision 2 action	List	0...3	-	1 = 1
32.17	Supervision 2 signal	Analog src	-	-	1 = 1
32.18	Supervision 2 filter time	Real	0.000...30.000	s	1000 = 1 s
32.19	Supervision 2 low	Real	-21474836.00... 21474836.00	-	100 = 1
32.20	Supervision 2 high	Real	-21474836.00... 21474836.00	-	100 = 1
32.21	Supervision 2 hysteresis	Real	0.00...100000.00	-	100 = 1
32.25	Supervision 3 function	List	0...7	-	1 = 1
32.26	Supervision 3 action	List	0...3	-	1 = 1
32.27	Supervision 3 signal	Analog src	-	-	1 = 1
32.28	Supervision 3 filter time	Real	0.000...30.000	s	1000 = 1 s

No.	Name	Type	Range	Unit	FbEq32
32.29	Supervision 3 low	<i>Real</i>	-21474836.00... 21474836.00	-	100 = 1
32.30	Supervision 3 high	<i>Real</i>	-21474836.00... 21474836.00	-	100 = 1
32.31	Supervision 3 hysteresis	<i>Real</i>	0.00...100000.00	-	100 = 1
32.35	Supervision 4 function	<i>List</i>	0...7	-	1 = 1
32.36	Supervision 4 action	<i>List</i>	0...3	-	1 = 1
32.37	Supervision 4 signal	<i>Analog src</i>	-	-	1 = 1
32.38	Supervision 4 filter time	<i>Real</i>	0.000...30.000	s	1000 = 1 s
32.39	Supervision 4 low	<i>Real</i>	-21474836.00... 21474836.00	-	100 = 1
32.40	Supervision 4 high	<i>Real</i>	-21474836.00... 21474836.00	-	100 = 1
32.41	Supervision 4 hysteresis	<i>Real</i>	0.00...100000.00	-	100 = 1
32.45	Supervision 5 function	<i>List</i>	0...7	-	1 = 1
32.46	Supervision 5 action	<i>List</i>	0...3	-	1 = 1
32.47	Supervision 5 signal	<i>Analog src</i>	-	-	1 = 1
32.48	Supervision 5 filter time	<i>Real</i>	0.000...30.000	s	1000 = 1 s
32.49	Supervision 5 low	<i>Real</i>	-21474836.00... 21474836.00	-	100 = 1
32.50	Supervision 5 high	<i>Real</i>	-21474836.00... 21474836.00	-	100 = 1
32.51	Supervision 5 hysteresis	<i>Real</i>	0.00...100000.00	-	100 = 1
32.55	Supervision 6 function	<i>List</i>	0...7	-	1 = 1
32.56	Supervision 6 action	<i>List</i>	0...3	-	1 = 1
32.57	Supervision 6 signal	<i>Analog src</i>	-	-	1 = 1
32.58	Supervision 6 filter time	<i>Real</i>	0.000...30.000	s	1000 = 1 s
32.59	Supervision 6 low	<i>Real</i>	-21474836.00... 21474836.00	-	100 = 1
32.60	Supervision 6 high	<i>Real</i>	-21474836.00... 21474836.00	-	100 = 1
32.61	Supervision 6 hysteresis	<i>Real</i>	0.00...100000.00	-	100 = 1
34 Timed functions					
34.01	Timed functions status	<i>PB</i>	0000h...FFFFh	-	1 = 1
34.02	Timer status	<i>PB</i>	0000h...FFFFh	-	1 = 1
34.04	Season/exception day status	<i>PB</i>	0000h...FFFFh	-	1 = 1
34.10	Timed functions enable	<i>Binary src</i>	-	-	1 = 1
34.11	Timer 1 configuration	<i>PB</i>	0000h...FFFFh	-	1 = 1
34.12	Timer 1 start time	Time	00:00:00...23:59:59	-	-
34.13	Timer 1 duration	Duration	00 00:00...07 00:00	-	-
34.14	Timer 2 configuration	<i>PB</i>	0000h...FFFFh	-	1 = 1

No.	Name	Type	Range	Unit	FbEq32
34.15	Timer 2 start time	Time	00:00:00...23:59:59	-	-
34.16	Timer 2 duration	Duration	00 00:00...07 00:00	-	-
34.17	Timer 3 configuration	<i>PB</i>	0000h...FFFFh	-	1 = 1
34.18	Timer 3 start time	Time	00:00:00...23:59:59	-	-
34.19	Timer 3 duration	Duration	00 00:00...07 00:00	-	-
34.20	Timer 4 configuration	<i>PB</i>	0000h...FFFFh	-	1 = 1
34.21	Timer 4 start time	Time	00:00:00...23:59:59	-	-
34.22	Timer 4 duration	Duration	00 00:00...07 00:00	-	-
34.23	Timer 5 configuration	<i>PB</i>	0000h...FFFFh	-	1 = 1
34.24	Timer 5 start time	Time	00:00:00...23:59:59	-	-
34.25	Timer 5 duration	Duration	00 00:00...07 00:00	-	-
34.26	Timer 6 configuration	<i>PB</i>	0000h...FFFFh	-	1 = 1
34.27	Timer 6 start time	Time	00:00:00...23:59:59	-	-
34.28	Timer 6 duration	Duration	00 00:00...07 00:00	-	-
34.29	Timer 7 configuration	<i>PB</i>	0000h...FFFFh	-	1 = 1
34.30	Timer 7 start time	Time	00:00:00...23:59:59	-	-
34.31	Timer 7 duration	Duration	00 00:00...07 00:00	-	-
34.32	Timer 8 configuration	<i>PB</i>	0000h...FFFFh	-	1 = 1
34.33	Timer 8 start time	Time	00:00:00...23:59:59	-	-
34.34	Timer 8 duration	Duration	00 00:00...07 00:00	-	-
34.35	Timer 9 configuration	<i>PB</i>	0000h...FFFFh	-	1 = 1
34.36	Timer 9 start time	Time	00:00:00...23:59:59	-	-
34.37	Timer 9 duration	Duration	00 00:00...07 00:00	-	-
34.38	Timer 10 configuration	<i>PB</i>	0000h...FFFFh	-	1 = 1
34.39	Timer 10 start time	Time	00:00:00...23:59:59	-	-
34.40	Timer 10 duration	Duration	00 00:00...07 00:00	-	-
34.41	Timer 11 configuration	<i>PB</i>	0000h...FFFFh	-	1 = 1
34.42	Timer 11 start time	Time	00:00:00...23:59:59	-	-
34.43	Timer 11 duration	Duration	00 00:00...07 00:00	-	-
34.44	Timer 12 configuration	<i>PB</i>	0000h...FFFFh	-	1 = 1
34.45	Timer 12 start time	Time	00:00:00...23:59:59	-	-
34.46	Timer 12 duration	Duration	00 00:00...07 00:00	-	-
34.60	Season 1 start date	Date	01/01...31/12	-	-
34.61	Season 2 start date	Date	01/01...31/12	-	-
34.62	Season 3 start date	Date	01/01...31/12	-	-
34.63	Season 4 start date	Date	01/01...31/12	-	-
34.70	Number of active exceptions	<i>Real</i>	0...16	-	1 = 1
34.71	Exception types	<i>PB</i>	0000h...FFFFh	-	1 = 1
34.72	Exception 1 start	Date	01/01...31/12	-	-
34.73	Exception 1 length	<i>Real</i>	0...60	d	1 = 1 d
34.74	Exception 2 start	Date	01/01...31/12	-	-

No.	Name	Type	Range	Unit	FbEq32
34.75	Exception 2 length	<i>Real</i>	0...60	d	1 = 1 d
34.76	Exception 3 start	Date	01/01...31/12	-	-
34.77	Exception 3 length	<i>Real</i>	0...60	d	1 = 1 d
34.78	Exception day 4	Date	01/01...31/12	-	-
34.79	Exception day 5	Date	01/01...31/12	-	-
34.80	Exception day 6	Date	01/01...31/12	-	-
34.81	Exception day 7	Date	01/01...31/12	-	-
34.82	Exception day 8	Date	01/01...31/12	-	-
34.83	Exception day 9	Date	01/01...31/12	-	-
34.84	Exception day 10	Date	01/01...31/12	-	-
34.85	Exception day 11	Date	01/01...31/12	-	-
34.86	Exception day 12	Date	01/01...31/12	-	-
34.87	Exception day 13	Date	01/01...31/12	-	-
34.88	Exception day 14	Date	01/01...31/12	-	-
34.89	Exception day 15	Date	01/01...31/12	-	-
34.90	Exception day 16	Date	01/01...31/12	-	-
34.100	Timed function 1	<i>PB</i>	0000h...FFFFh	-	1 = 1
34.101	Timed function 2	<i>PB</i>	0000h...FFFFh	-	1 = 1
34.102	Timed function 3	<i>PB</i>	0000h...FFFFh	-	1 = 1
34.110	Boost time function	<i>PB</i>	0000h...FFFFh	-	1 = 1
34.111	Boost time activation source	<i>Binary src</i>	-	-	1 = 1
34.112	Boost time duration	Duration	00 00:00...07 00:00	-	-
35 Motor thermal protection					
35.01	Motor estimated temperature	<i>Real</i>	-60...1000 °C or -76...1832 °F	°C or °F	1 = 1 unit
35.02	Measured temperature 1	<i>Real</i>	-60...5000 °C or -76...9032 °F, 0 ohm or [35.12] ohm	°C, °F or ohm	1 = 1 unit
35.03	Measured temperature 2	<i>Real</i>	-60...5000 °C or -76...9032 °F, 0 ohm or [35.12] ohm	°C, °F or ohm	1 = 1 unit
35.05	Motor overload level	<i>Real</i>	0.0...100.0%	%	100 = 1%
35.11	Temperature 1 source	<i>List</i>	0...2, 5...8, 11...16, 21...23, 23	-	1 = 1
35.12	Temperature 1 fault limit	<i>Real</i>	-60...5000 °C or -76...9032 °F or 0...5000 ohm	°C, °F or ohm	1 = 1 unit
35.13	Temperature 1 warning limit	<i>Real</i>	-60...5000 °C or -76...9032 °F or 0...5000 ohm	°C, °F or ohm	1 = 1 unit
35.14	Temperature 1 AI source	<i>Analog src</i>	-	-	1 = 1

No.	Name	Type	Range	Unit	FbEq32
35.21	Temperature 2 source	List	0...2, 5...8, 11...16, 21...23, 23	-	1 = 1
35.22	Temperature 2 fault limit	Real	-60...5000 °C or -76...9032 °F or 0...5000 ohm	°C, °F or ohm	1 = 1 unit
35.23	Temperature 2 warning limit	Real	-60...5000 °C or -76...9032 °F or 0...5000 ohm	°C, °F or ohm	1 = 1 unit
35.24	Temperature 2 AI source	Analog src	-	-	1 = 1
35.50	Motor ambient temperature	Real	-60...100 °C or -76 ... 212 °F	°C or °F	1 = 1 unit
35.51	Motor load curve	Real	50...150	%	1 = 1%
35.52	Zero speed load	Real	25...150	%	1 = 1%
35.53	Break point	Real	1.00 ... 500.00	Hz	100 = 1 Hz
35.54	Motor nominal temperature rise	Real	0...300 °C or 32...572 °F	°C or °F	1 = 1 unit
35.55	Motor thermal time constant	Real	100...10000	s	1 = 1 s
35.56	Motor overload action	List	0...2	-	1 = 1
35.57	Motor overload class	List	0...5	-	1 = 1
36 Load analyzer					
36.01	PVL signal source	Analog src	-	-	1 = 1
36.02	PVL filter time	Real	0.00...120.00	s	100 = 1 s
36.06	AL2 signal source	Analog src	-	-	1 = 1
36.07	AL2 signal scaling	Real	0.00...32767.00	-	100 = 1
36.09	Reset loggers	List	0...3	-	1 = 1
36.10	PVL peak value	Real	-32768.00...32767.00	-	100 = 1
36.11	PVL peak date	Data	-	-	-
36.12	PVL peak time	Data	-	-	-
36.13	PVL current at peak	Real	-32768.00...32767.00	A	100 = 1 A
36.14	PVL DC voltage at peak	Real	0.00...2000.00	V	100 = 1 V
36.15	PVL speed at peak	Real	-30000.00... 30000.00	rpm	100 = 1 rpm
36.16	PVL reset date	Data	-	-	-
36.17	PVL reset time	Data	-	-	-
36.20	AL1 0 to 10%	Real	0.00...100.00	%	100 = 1%
36.21	AL1 10 to 20%	Real	0.00...100.00	%	100 = 1%
36.22	AL1 20 to 30%	Real	0.00...100.00	%	100 = 1%
36.23	AL1 30 to 40%	Real	0.00...100.00	%	100 = 1%
36.24	AL1 40 to 50%	Real	0.00...100.00	%	100 = 1%
36.25	AL1 50 to 60%	Real	0.00...100.00	%	100 = 1%
36.26	AL1 60 to 70%	Real	0.00...100.00	%	100 = 1%
36.27	AL1 70 to 80%	Real	0.00...100.00	%	100 = 1%

No.	Name	Type	Range	Unit	FbEq32
36.28	AL1 80 to 90%	<i>Real</i>	0.00...100.00	%	100 = 1%
36.29	AL1 over 90%	<i>Real</i>	0.00...100.00	%	100 = 1%
36.40	AL2 0 to 10%	<i>Real</i>	0.00...100.00	%	100 = 1%
36.41	AL2 10 to 20%	<i>Real</i>	0.00...100.00	%	100 = 1%
36.42	AL2 20 to 30%	<i>Real</i>	0.00...100.00	%	100 = 1%
36.43	AL2 30 to 40%	<i>Real</i>	0.00...100.00	%	100 = 1%
36.44	AL2 40 to 50%	<i>Real</i>	0.00...100.00	%	100 = 1%
36.45	AL2 50 to 60%	<i>Real</i>	0.00...100.00	%	100 = 1%
36.46	AL2 60 to 70%	<i>Real</i>	0.00...100.00	%	100 = 1%
36.47	AL2 70 to 80%	<i>Real</i>	0.00...100.00	%	100 = 1%
36.48	AL2 80 to 90%	<i>Real</i>	0.00...100.00	%	100 = 1%
36.49	AL2 over 90%	<i>Real</i>	0.00...100.00	%	100 = 1%
36.50	AL2 reset date	<i>Data</i>	-	-	-
36.51	AL2 reset time	<i>Data</i>	-	-	-
37 User load curve					
37.01	ULC output status word	<i>PB</i>	0000h...FFFFh	-	1 = 1
37.02	ULC supervision signal	<i>Analog src</i>	-	-	1 = 1
37.03	ULC overload actions	<i>List</i>	0...3	-	1 = 1
37.04	ULC underload actions	<i>List</i>	0...3	-	1 = 1
37.11	ULC speed table point 1	<i>Real</i>	-30000.0...30000.0	rpm	10 = 1 rpm
37.12	ULC speed table point 2	<i>Real</i>	-30000.0...30000.0	rpm	10 = 1 rpm
37.13	ULC speed table point 3	<i>Real</i>	-30000.0...30000.0	rpm	10 = 1 rpm
37.14	ULC speed table point 4	<i>Real</i>	-30000.0...30000.0	rpm	10 = 1 rpm
37.15	ULC speed table point 5	<i>Real</i>	-30000.0...30000.0	rpm	10 = 1 rpm
37.16	ULC frequency table point 1	<i>Real</i>	-500.0...500.0	Hz	10 = 1 Hz
37.17	ULC frequency table point 2	<i>Real</i>	-500.0...500.0	Hz	10 = 1 Hz
37.18	ULC frequency table point 3	<i>Real</i>	-500.0...500.0	Hz	10 = 1 Hz
37.19	ULC frequency table point 4	<i>Real</i>	-500.0...500.0	Hz	10 = 1 Hz
37.20	ULC frequency table point 5	<i>Real</i>	-500.0...500.0	Hz	10 = 1 Hz
37.21	ULC underload point 1	<i>Real</i>	-1600.0...1600.0	%	10 = 1%
37.22	ULC underload point 2	<i>Real</i>	-1600.0...1600.0	%	10 = 1%
37.23	ULC underload point 3	<i>Real</i>	-1600.0...1600.0	%	10 = 1%
37.24	ULC underload point 4	<i>Real</i>	-1600.0...1600.0	%	10 = 1%
37.25	ULC underload point 5	<i>Real</i>	-1600.0...1600.0	%	10 = 1%
37.31	ULC overload point 1	<i>Real</i>	-1600.0...1600.0	%	10 = 1%
37.32	ULC overload point 2	<i>Real</i>	-1600.0...1600.0	%	10 = 1%
37.33	ULC overload point 3	<i>Real</i>	-1600.0...1600.0	%	10 = 1%
37.34	ULC overload point 4	<i>Real</i>	-1600.0...1600.0	%	10 = 1%
37.35	ULC overload point 5	<i>Real</i>	-1600.0...1600.0	%	10 = 1%
37.41	ULC overload timer	<i>Real</i>	0.0...10000.0	s	10 = 1 s

No.	Name	Type	Range	Unit	FbEq32
37.42	ULC underload timer	<i>Real</i>	0.0...10000.0	s	10 = 1 s
40 Process PID set 1					
40.01	Process PID output actual	<i>Real</i>	-200000.00...200000.00	%	100 = 1 %
40.02	Process PID feedback actual	<i>Real</i>	-200000.00...200000.00	PID unit 1	100 = 1 PID unit 1
40.03	Process PID setpoint actual	<i>Real</i>	-200000...200000	PID unit 1	100 = 1 PID unit 1
40.04	Process PID deviation actual	<i>Real</i>	-200000.00...200000.00	PID unit 1	100 = 1 PID unit 1
40.06	Process PID status word	<i>PB</i>	0000h...FFFFh	-	1 = 1
40.07	Process PID operation mode	<i>List</i>	0...2	-	1 = 1
40.08	Set 1 feedback 1 source	<i>Analog src</i>	-	-	1 = 1
40.09	Set 1 feedback 2 source	<i>Analog src</i>	-	-	1 = 1
40.10	Set 1 feedback function	<i>List</i>	0...13	-	1 = 1
40.11	Set 1 feedback filter time	<i>Real</i>	0.000...30.000	s	1000 = 1 s
40.14	Set 1 setpoint scaling	<i>Real</i>	-200000.00...200000.00	-	100 = 1
40.15	Set 1 output scaling	<i>Real</i>	-200000.00...200000.00	-	100 = 1
40.16	Set 1 setpoint 1 source	<i>Analog src</i>	-	-	1 = 1
40.17	Set 1 setpoint 2 source	<i>Analog src</i>	-	-	1 = 1
40.18	Set 1 setpoint function	<i>List</i>	0...13	-	1 = 1
40.19	Set 1 internal setpoint sel1	<i>Binary src</i>	-	-	1 = 1
40.20	Set 1 internal setpoint sel2	<i>Binary src</i>	-	-	1 = 1
40.21	Set 1 internal setpoint 1	<i>Real</i>	-200000.00...200000.00	PID unit 1	100 = 1 PID unit 1
40.22	Set 1 internal setpoint 2	<i>Real</i>	-200000.00...200000.00	PID unit 1	100 = 1 PID unit 1
40.23	Set 1 internal setpoint 3	<i>Real</i>	-200000.00...200000.00	PID unit 1	100 = 1 PID unit 1
40.24	Set 1 internal setpoint 0	<i>Real</i>	-200000.00...200000.00	PID unit 1	100 = 1 PID unit 1
40.26	Set 1 setpoint min	<i>Real</i>	-200000.00...200000.00	PID unit 1	100 = 1 PID unit 1
40.27	Set 1 setpoint max	<i>Real</i>	-200000.00...200000.00	PID unit 1	100 = 1 PID unit 1
40.28	Set 1 setpoint increase time	<i>Real</i>	0.0...1800.0	s	10 = 1 s
40.29	Set 1 setpoint decrease time	<i>Real</i>	0.0...1800.0	s	10 = 1 s
40.30	Set 1 setpoint freeze enable	<i>Binary src</i>	-	-	1 = 1
40.31	Set 1 deviation inversion	<i>Binary src</i>	-	-	1 = 1
40.32	Set 1 gain	<i>Real</i>	0.10...100.00	-	100 = 1

No.	Name	Type	Range	Unit	FbEq32
40.33	Set 1 integration time	<i>Real</i>	0.0...9999.0	s	10 = 1 s
40.34	Set 1 derivation time	<i>Real</i>	0.000...10.000	s	1000 = 1 s
40.35	Set 1 derivation filter time	<i>Real</i>	0.0...10.0	s	10 = 1 s
40.36	Set 1 output min	<i>Real</i>	-200000.00...200000.00	-	100 = 1
40.37	Set 1 output max	<i>Real</i>	-200000.00...200000.00	-	100 = 1
40.38	Set 1 output freeze enable	<i>Binary src</i>	-	-	1 = 1
40.39	Set 1 deadband range	<i>Real</i>	0.00...200000.00	-	100 = 1
40.40	Set 1 deadband delay	<i>Real</i>	0.0...3600.0	s	10 = 1 s
40.41	Set 1 sleep mode	<i>List</i>	0...2	-	1 = 1
40.42	Set 1 sleep enable	<i>List</i>	0...1	-	1 = 1
40.43	Set 1 sleep level	<i>Real</i>	0.0...200000.0	-	10 = 1
40.44	Set 1 sleep delay	<i>Real</i>	0.0...3600.0	s	10 = 1 s
40.45	Set 1 sleep boost time	<i>Real</i>	0.0...3600.0	s	10 = 1 s
40.46	Set 1 sleep boost step	<i>Real</i>	0.00...200000.00	PID unit 1	100 = 1 PID unit 1
40.47	Set 1 wake-up deviation	<i>Real</i>	-200000.00...200000.00	PID unit 1	100 = 1 PID unit 1
40.48	Set 1 wake-up delay	<i>Real</i>	0.00...60.00	s	100 = 1 s
40.49	Set 1 tracking mode	<i>Binary src</i>	-	-	1 = 1
40.50	Set 1 tracking ref selection	<i>Analog src</i>	-	-	1 = 1
40.57	PID set1/set2 selection	<i>Binary src</i>	-	-	1 = 1
40.58	Set 1 increase prevention	<i>Binary src</i>	-	-	1 = 1
40.59	Set 1 decrease prevention	<i>Binary src</i>	-	-	1 = 1
40.60	Set 1 PID activation source	<i>Binary src</i>	-	-	1 = 1
40.61	Setpoint scaling actual	<i>Real</i>	-200000.00...200000.00	-	100 = 1
40.62	PID internal setpoint actual	<i>Real</i>	-200000.00...200000.00	PID unit 1	100 = 1 PID unit 1
40.70	Compensated setpoint	<i>Real</i>	-21474836.48... 21474835.20	PID unit 1	100 = 1 PID unit 1
40.71	Set 1 compensation input source	<i>List</i>	0, 2...4, 8, 10...12, 15...16, 19...20, 24	-	1 = 1
40.72	Set 1 compensation input 1	<i>Real</i>	-200000.00...200000.00	-	100 = 1
40.73	Set 1 compensated output 1	<i>Real</i>	-200000.00...200000.00	-	100 = 1
40.74	Set 1 compensation input 2	<i>Real</i>	-200000.00...200000.00	-	100 = 1
40.75	Set 1 compensated output 2	<i>Real</i>	-200000.00...200000.00	-	100 = 1
40.76	Set 1 compensation non-linearity	<i>Real</i>	0...100	%	1 = 1%

No.	Name	Type	Range	Unit	FbEq32
40.79	Set 1 units	List	0, 4, 21, 26, 29, 34, 37...38, 40, 44, 47...48, 50...52, 58...59, 65, 74...80, 88, 94, 125...126, 131, 150...151	-	1 = 1
40.80	Set 1 PID output min source	List	0...1	-	1 = 1
40.81	Set 1 PID output max source	List	0...1	-	1 = 1
40.89	Set 1 setpoint multiplier	Real	-200000.00...200000.00	-	100 = 1
40.90	Set 1 feedback multiplier	Real	-200000.00...200000.00	-	100 = 1
40.91	Feedback data storage	Real	-327.68...327.67	-	100 = 1
40.92	Setpoint data storage	Real	-327.68...327.67	-	100 = 1
40.96	Process PID output %	Real	-100.00...100.00	%	100 = 1%
40.97	Process PID feedback %	Real	-100.00...100.00	%	100 = 1%
40.98	Process PID setpoint %	Real	-100.00...100.00	%	100 = 1%
40.99	Process PID deviation %	Real	-100.00...100.00	%	100 = 1%
41 Process PID set 2					
41.08	Set 2 feedback 1 source	Analog src	-	-	1 = 1
41.09	Set 2 feedback 2 source	Analog src	-	-	1 = 1
41.10	Set 2 feedback function	List	0...13	-	1 = 1
41.11	Set 2 feedback filter time	Real	0.000...30.000	s	1000 = 1 s
41.14	Set 2 setpoint scaling	Real	-200000.00...200000.00	-	100 = 1
41.15	Set 2 output scaling	Real	-200000.00...200000.00	-	100 = 1
41.16	Set 2 setpoint 1 source	Analog src	-	-	1 = 1
41.17	Set 2 setpoint 2 source	Analog src	-	-	1 = 1
41.18	Set 2 setpoint function	List	0...13	-	1 = 1
41.19	Set 2 internal setpoint sel1	Binary src	-	-	1 = 1
41.20	Set 2 internal setpoint sel2	Binary src	-	-	1 = 1
41.21	Set 2 internal setpoint 1	Real	-200000.00...200000.00	PID unit 1	100 = 1 PID unit 1
41.22	Set 2 internal setpoint 2	Real	-200000.00...200000.00	PID unit 1	100 = 1 PID unit 1
41.23	Set 2 internal setpoint 3	Real	-200000.00...200000.00	PID unit 1	100 = 1 PID unit 1
41.24	Set 2 internal setpoint 0	Real	-200000.00...200000.00	PID unit 1	100 = 1 PID unit 1
41.26	Set 2 setpoint min	Real	-200000.00...200000.00	PID unit 1	100 = 1 PID unit 1
41.27	Set 2 setpoint max	Real	-200000.00...200000.00	PID unit 1	100 = 1 PID unit 1
41.28	Set 2 setpoint increase time	Real	0.0...1800.0	s	10 = 1 s
41.29	Set 2 setpoint decrease time	Real	0.0...1800.0	s	10 = 1 s

No.	Name	Type	Range	Unit	FbEq32
41.30	Set 2 setpoint freeze enable	Binary src	-	-	1 = 1
41.31	Set 2 deviation inversion	Binary src	-	-	1 = 1
41.32	Set 2 gain	Real	0.10...100.00	-	100 = 1
41.33	Set 2 integration time	Real	0.0...9999.0	s	10 = 1 s
41.34	Set 2 derivation time	Real	0.000...10.000	s	1000 = 1 s
41.35	Set 2 derivation filter time	Real	0.0...10.0	s	10 = 1 s
41.36	Set 2 output min	Real	-200000.00...200000.00	-	100 = 1
41.37	Set 2 output max	Real	-200000.00...200000.00	-	100 = 1
41.38	Set 2 output freeze enable	Binary src	-	-	1 = 1
41.39	Set 2 deadband range	Real	0.00...200000.00	-	100 = 1
41.40	Set 2 deadband delay	Real	0.0...3600.0	s	10 = 1 s
41.41	Set 2 sleep mode	List	0...2	-	1 = 1
41.42	Set 2 sleep enable	List	0...1	-	1 = 1
41.43	Set 2 sleep level	Real	0.0...200000.0	-	10 = 1
41.44	Set 2 sleep delay	Real	0.0...3600.0	s	10 = 1 s
41.45	Set 2 sleep boost time	Real	0.0...3600.0	s	10 = 1 s
41.46	Set 2 sleep boost step	Real	0.00...200000.00	PID unit 1	100 = 1 PID unit 1
41.47	Set 2 wake-up deviation	Real	-200000.00...200000.00	PID unit 1	100 = 1 PID unit 1
41.48	Set 2 wake-up delay	Real	0.00...60.00	s	100 = 1 s
41.49	Set 2 tracking mode	Binary src	-	-	1 = 1
41.50	Set 2 tracking ref selection	Analog src	-	-	1 = 1
41.58	Set 2 increase prevention	Binary src	-	-	1 = 1
41.59	Set 2 decrease prevention	Binary src	-	-	1 = 1
41.60	Set 2 PID activation source	Binary src	-	-	1 = 1
41.71	Set 2 compensation input source	List	0, 2...4, 8, 10...12, 15...16, 19...20, 24	-	1 = 1
41.72	Set 2 compensation input 1	Real	-200000.00...200000.00	-	100 = 1
41.73	Set 2 compensated output 1	Real	-200000.00...200000.00	-	100 = 1
41.74	Set 2 compensation input 2	Real	-200000.00...200000.00	-	100 = 1
41.75	Set 2 compensated output 2	Real	-200000.00...200000.00	-	100 = 1
41.76	Set 2 compensation non-linearity	Real	0...100	%	1 = 1%
41.79	Set 2 units	List	0, 4, 21, 26, 29, 34, 37...38, 40, 44, 47...48, 50...52, 58...59, 65, 74...80, 88, 94, 125...126, 131, 150...151	-	1 = 1

No.	Name	Type	Range	Unit	FbEq32
41.80	Set 2 PID output min source	List	0...1	-	1 = 1
41.81	Set 2 PID output max source	List	0...1	-	1 = 1
41.89	Set 2 setpoint multiplier	Real	-200000.00...200000.00	-	100 = 1
41.90	Set 2 feedback multiplier	Real	-200000.00...200000.00	-	100 = 1
43 Brake chopper					
43.01	Braking resistor temperature	Real	0.0...120.0	%	10 = 1%
43.06	Brake chopper function	List	0...3	-	1 = 1
43.07	Brake chopper run enable	Binary src	-	-	1 = 1
43.08	Brake resistor thermal tc	Real	0...10000	s	1 = 1 s
43.09	Brake resistor Pmax cont	Real	0.00...10000.00	kW	100 = 1 kW
43.10	Brake resistance	Real	0.0...1000.0	ohm	10 = 1 ohm
43.11	Brake resistor fault limit	Real	0...150	%	1 = 1%
43.12	Brake resistor warning limit	Real	0...150	%	1 = 1%
45 Energy efficiency					
45.01	Saved GW hours	Real	0...65535	GWh	1 = 1 GWh
45.02	Saved MW hours	Real	0...999	MWh	1 = 1 MWh
45.03	Saved kW hours	Real	0.0...999.9	kWh	10 = 1 kWh
45.04	Saved energy	Real	0.0...214748364.0	kWh	10 = 1 kWh
45.05	Saved money x1000	Real	0...4294967295 thousands	(defina- ble)	1 = 1 currency unit
45.06	Saved money	Real	0.00...999.99	(defina- ble)	100 = 1 currency unit
45.07	Saved amount	Real	0.00...21474830.08	(defina- ble)	100 = 1 currency unit
45.08	CO2 reduction in kilotons	Real	0...65535	metric kiloton	1 = 1 metric kiloton
45.09	CO2 reduction in tons	Real	0.0...999.9	metric ton	10 = 1 metric ton
45.10	Total saved CO2	Real	0.0...214748300.8	metric ton	10 = 1 metric ton
45.11	Energy optimizer	List	0...1	-	1 = 1
45.12	Energy tariff 1	Real	0.000...4294966.296	(defina- ble)	1000 = 1 currency unit
45.13	Energy tariff 2	Real	0.000...4294966.296	(defina- ble)	1000 = 1 currency unit
45.14	Tariff selection	Binary src	-	-	1 = 1
45.18	CO2 conversion factor	Real	0.000...65.535	tn/MWh	1000 = 1 tn/MWh
45.19	Comparison power	Real	0.00...10000000.00	kW	10 = 1 kW
45.21	Energy calculations reset	List	0...1	-	1 = 1
45.24	Hourly peak power value	Real	-3000.00...3000.00	kW	1 = 1 kW
45.25	Hourly peak power time	Real	-	-	-

No.	Name	Type	Range	Unit	FbEq32
45.26	Hourly total energy (resettable)	<i>Real</i>	-3000.00...3000.00	kWh	1 = 1 kWh
45.27	Daily peak power value (resettable)	<i>Real</i>	-3000.00...3000.00	kW	1 = 1 kW
45.28	Daily peak power time	<i>Real</i>	-	-	-
45.29	Daily total energy (resettable)	<i>Real</i>	-30000.00...30000.00	kWh	1 = 1 kWh
45.30	Last day total energy	<i>Real</i>	-30000.00...30000.00	kWh	1 = 1 kWh
45.31	Monthly peak power value (resettable)	<i>Real</i>	-30000.00...30000.00	kW	1 = 1 kW
45.32	Monthly peak power date	<i>Real</i>	-	-	-
45.33	Monthly peak power time	<i>Real</i>	-	-	-
45.34	Monthly total energy (resettable)	<i>Real</i>	-1000000.00...1000000.00	kWh	1 = 1 kWh
45.35	Last month total energy	<i>Real</i>	-1000000.00...1000000.00	kWh	1 = 1 kWh
45.36	Lifetime peak power value	<i>Real</i>	-3000.00...3000.00	kW	1 = 1 kW
45.37	Lifetime peak power date	<i>Real</i>	-	-	-
45.38	Lifetime peak power time	<i>Real</i>	-	-	-
46 Monitoring/scaling settings					
46.01	Speed scaling	<i>Real</i>	0.00...30000.00	rpm	100 = 1 rpm
46.02	Frequency scaling	<i>Real</i>	0.10...1000.00	Hz	100 = 1 Hz
46.03	Torque scaling	<i>Real</i>	0.1...1000.0	%	10 = 1%
46.04	Power scaling	<i>Real</i>	0.10...30000.00	kW or hp	10 = 1 unit
46.05	Current scaling	<i>Real</i>	0...30000	A	1 = 1 A
46.06	Speed ref zero scaling	<i>Real</i>	0.00...30000.00	rpm	100 = 1 rpm
46.07	Frequency ref zero scaling	<i>Real</i>	0.00...1000.00	Hz	100 = 1 Hz
46.11	Filter time motor speed	<i>Real</i>	2...20000	ms	1 = 1 ms
46.12	Filter time output frequency	<i>Real</i>	2...20000	ms	1 = 1 ms
46.13	Filter time motor torque	<i>Real</i>	2...20000	ms	1 = 1 ms
46.14	Filter time power	<i>Real</i>	2...20000	ms	1 = 1 ms
46.21	At speed hysteresis	<i>Real</i>	0.00...30000.00	rpm	100 = 1 rpm
46.22	At frequency hysteresis	<i>Real</i>	0.00...1000.00	Hz	100 = 1 Hz
46.31	Above speed limit	<i>Real</i>	0.00...30000.00	rpm	100 = 1 rpm
46.32	Above frequency limit	<i>Real</i>	0.00...1000.00	Hz	100 = 1 Hz
46.41	kWh pulse scaling	<i>Real</i>	0.001...1000.000	kWh	1000 = 1 kWh
46.43	Power decimals	<i>Real</i>	0...3	-	1 = 1
46.44	Current decimals	<i>Real</i>	0...3	-	1 = 1
47 Data storage					
47.01	Data storage 1 real32	<i>Real</i>	-2147483.000... 2147483.000	-	1000 = 1
47.02	Data storage 2 real32	<i>Real</i>	-2147483.000... 2147483.000	-	1000 = 1
47.03	Data storage 3 real32	<i>Real</i>	-2147483.000... 2147483.000	-	1000 = 1

No.	Name	Type	Range	Unit	FbEq32
47.04	Data storage 4 real32	<i>Real</i>	-2147483.000... 2147483.000	-	1000 = 1
47.11	Data storage 1 int32	<i>Real</i>	-2147483648... 2147483647	-	1 = 1
47.12	Data storage 2 int32	<i>Real</i>	-2147483648... 2147483647	-	1 = 1
47.13	Data storage 3 int32	<i>Real</i>	-2147483648... 2147483647	-	1 = 1
47.14	Data storage 4 int32	<i>Real</i>	-2147483648... 2147483647	-	1 = 1
47.21	Data storage 1 int16	<i>Real</i>	-32768...32767	-	1 = 1
47.22	Data storage 2 int16	<i>Real</i>	-32768...32767	-	1 = 1
47.23	Data storage 3 int16	<i>Real</i>	-32768...32767	-	1 = 1
47.24	Data storage 4 int16	<i>Real</i>	-32768...32767	-	1 = 1
49 Panel port communication					
49.01	Node ID number	<i>Real</i>	1...32	-	1 = 1
49.03	Baud rate	<i>List</i>	1...5	-	1 = 1
49.04	Communication loss time	<i>Real</i>	0.3...3000.0	s	10 = 1 s
49.05	Communication loss action	<i>List</i>	0...3	-	1 = 1
49.06	Refresh settings	<i>List</i>	0...1	-	1 = 1
50 Fieldbus adapter (FBA)					
50.01	FBA A enable	<i>List</i>	0...1	-	1 = 1
50.02	FBA A comm loss func	<i>List</i>	0...5	-	1 = 1
50.03	FBA A comm loss t out	<i>Real</i>	0.3...6553.5	s	10 = 1 s
50.04	FBA A ref1 type	<i>List</i>	0...5	-	1 = 1
50.05	FBA A ref2 type	<i>List</i>	0...5	-	1 = 1
50.06	FBA A SW sel	<i>List</i>	0...1	-	1 = 1
50.07	FBA A actual 1 type	<i>List</i>	0...5	-	1 = 1
50.08	FBA A actual 2 type	<i>List</i>	0...5	-	1 = 1
50.09	FBA A SW transparent source	<i>Analog src</i>	-	-	1 = 1
50.10	FBA A act1 transparent source	<i>Analog src</i>	-	-	1 = 1
50.11	FBA A act2 transparent source	<i>Analog src</i>	-	-	1 = 1
50.12	FBA A debug mode	<i>List</i>	0...1	-	1 = 1
50.13	FBA A control word	<i>Data</i>	00000000h...FFFFFFFh	-	1 = 1
50.14	FBA A reference 1	<i>Real</i>	-2147483648... 2147483647	-	1 = 1
50.15	FBA A reference 2	<i>Real</i>	-2147483648... 2147483647	-	1 = 1
50.16	FBA A status word	<i>Data</i>	00000000h...FFFFFFFh	-	1 = 1
50.17	FBA A actual value 1	<i>Real</i>	-2147483648... 2147483647	-	1 = 1

No.	Name	Type	Range	Unit	FbEq32
50.18	FBA A actual value 2	<i>Real</i>	-2147483648... 2147483647	-	1 = 1
51 FBA A settings					
51.01	FBA A type	<i>List</i>	-	-	1 = 1
51.02	FBA A Par2	<i>Real</i>	0...65535	-	1 = 1
...	
51.26	FBA A Par26	<i>Real</i>	0...65535	-	1 = 1
51.27	FBA A par refresh	<i>List</i>	0...1	-	1 = 1
51.28	FBA A par table ver	<i>Data</i>	-	-	1 = 1
51.29	FBA A drive type code	<i>Real</i>	0...65535	-	1 = 1
51.30	FBA A mapping file ver	<i>Real</i>	0...65535	-	1 = 1
51.31	D2FBA A comm status	<i>List</i>	0...6	-	1 = 1
51.32	FBA A comm SW ver	<i>Data</i>	-	-	1 = 1
51.33	FBA A appl SW ver	<i>Data</i>	-	-	1 = 1
52 FBA A data in					
52.01	FBA A data in1	<i>Analog src</i>	-	-	1 = 1
...	
52.12	FBA A data in12	<i>Analog src</i>	-	-	1 = 1
53 FBA A data out					
53.01	FBA A data out1	<i>Analog src</i>	-	-	1 = 1
...	
53.12	FBA A data out12	<i>Analog src</i>	-	-	1 = 1
58 Embedded fieldbus					
58.01	Protocol enable	<i>List</i>	0...2, 5, 7	-	1 = 1
58.02	Protocol ID	<i>Real</i>	0000h...FFFFh	-	1 = 1
58.03	Node address	<i>Real</i>	0...255	-	1 = 1
58.04	Baud rate	<i>List</i>	0...7	-	1 = 1
58.05	Parity	<i>List</i>	0...3	-	1 = 1
58.06	Communication control	<i>List</i>	0...2	-	1 = 1
58.07	Communication diagnostics	<i>PB</i>	0000h...FFFFh	-	1 = 1
58.08	Received packets	<i>Real</i>	0...4294967295	-	1 = 1
58.09	Transmitted packets	<i>Real</i>	0...4294967295	-	1 = 1
58.10	All packets	<i>Real</i>	0...4294967295	-	1 = 1
58.11	UART errors	<i>Real</i>	0...4294967295	-	1 = 1
58.12	CRC errors	<i>Real</i>	0...4294967295	-	1 = 1
58.13	Token counter	<i>Real</i>	0...4294967295	-	1 = 1
58.14	Communication loss action	<i>List</i>	0...5	-	1 = 1
58.15	Communication loss mode	<i>List</i>	1...2	-	1 = 1

No.	Name	Type	Range	Unit	FbEq32
58.16	Communication loss time	<i>Real</i>	0.0...6000.0	s	10 = 1 s
58.17	Transmit delay	<i>Real</i>	0...65535	ms	1 = 1 ms
58.18	EFB control word	<i>PB</i>	00000000h...FFFFFFFh	-	1 = 1
58.19	EFB status word	<i>PB</i>	00000000h...FFFFFFFh	-	1 = 1
58.25	Control profile	<i>List</i>	0, 5	-	1 = 1
58.26	EFB ref1 type	<i>List</i>	0...5	-	1 = 1
58.27	EFB ref2 type	<i>List</i>	0...5	-	1 = 1
58.28	EFB act1 type	<i>List</i>	0...5	-	1 = 1
58.29	EFB act2 type	<i>List</i>	0...5	-	1 = 1
58.30	EFB status word transparent source	<i>Analog src</i>	-	-	1 = 1
58.31	EFB act1 transparent source	<i>Analog src</i>	-	-	1 = 1
58.32	EFB act2 transparent source	<i>Analog src</i>	-	-	1 = 1
58.33	Addressing mode	<i>List</i>	0...2	-	1 = 1
58.34	Word order	<i>List</i>	0...1	-	1 = 1
58.40	Device object ID	<i>Real</i>	0...4194303	-	1 = 1
58.41	Max master	<i>Real</i>	0...127	-	1 = 1
58.42	Max info frames	<i>Real</i>	0...10	-	1 = 1
58.43	Max APDU retries	<i>Real</i>	0...10	-	1 = 1
58.44	APDU timeout	<i>Real</i>	0...60	s	1 = 1 s
58.47	AV21 & AV22 unit	<i>List</i>	0...1	-	1 = 1
58.101	Data I/O 1	<i>Analog src</i>	-	-	1 = 1
58.102	Data I/O 2	<i>Analog src</i>	-	-	1 = 1
58.103	Data I/O 3	<i>Analog src</i>	-	-	1 = 1
58.104	Data I/O 4	<i>Analog src</i>	-	-	1 = 1
58.105	Data I/O 5	<i>Analog src</i>	-	-	1 = 1
58.106	Data I/O 6	<i>Analog src</i>	-	-	1 = 1
58.107	Data I/O 7	<i>Analog src</i>	-	-	1 = 1
...	
58.114	Data I/O 14	<i>Analog src</i>	-	-	1 = 1
70 Override					
70.01	Override status	<i>PB</i>	0000h...FFFFFFh	-	1 = 1
70.02	Override enable	<i>List</i>	0...1	-	1 = 1
70.03	Override activation source	<i>Binary src</i>	-	-	1 = 1

No.	Name	Type	Range	Unit	FbEq32
70.04	Override reference source	List	0...6	-	1 = 1
70.05	Override direction	Binary src	-	-	1 = 1
70.06	Override frequency	Real	-500.0...500.0	Hz	100 = 1 Hz
70.07	Override speed	Real	-30000.0...30000.0	rpm	100 = 1 rpm
70.10	Override enables selection	PB	0000h...FFFFh	-	1 = 1
70.20	Override fault handling	List	0...1	-	1 = 1
70.21	Override auto reset trials	Real	0...5	-	1 = 1
70.22	Override auto reset time	Real	5.0...120.0	s	10 = 1 s
70.40	Override log 1 start date	Real	-	-	-
70.41	Override log 1 start time	Real	-	-	-
70.42	Override log 1 end date	Real	-	-	-
70.43	Override log 1 end time	Real	-	-	-
70.44	Override log 1 fault 1	Real	-	-	-
70.45	Override log 1 fault 2	Real	-	-	-
70.46	Override log 1 fault 3	Real	-	-	-
70.47	Override log 1 warning 1	Real	-	-	-
70.48	Override log 1 warning 2	Real	-	-	-
70.49	Override log 1 warning 3	Real	-	-	-
70.50	Override log 2 start date	Real	-	-	-
70.51	Override log 2 start time	Real	-	-	-
70.52	Override log 2 end date	Real	-	-	-
70.53	Override log 2 end time	Real	-	-	-
70.54	Override log 2 fault 1	Real	-	-	-
70.55	Override log 2 fault 2	Real	-	-	-
70.56	Override log 2 fault 3	Real	-	-	-
70.57	Override log 2 warning 1	Real	-	-	-
70.58	Override log 2 warning 2	Real	-	-	-
70.59	Override log 2 warning 3	Real	-	-	-
70.60	Override log 3 start date	Real	-	-	-
70.61	Override log 3 start time	Real	-	-	-
70.62	Override log 3 end date	Real	-	-	-
70.63	Override log 3 end time	Real	-	-	-
70.64	Override log 3 fault 1	Real	-	-	-
70.65	Override log 3 fault 2	Real	-	-	-
70.66	Override log 3 fault 3	Real	-	-	-
70.67	Override log 3 warning 1	Real	-	-	-
70.68	Override log 3 warning 2	Real	-	-	-
70.69	Override log 3 warning 3	Real	-	-	-
71 External PID1					
71.01	External PID act value	Real	-200000.00...200000.00	%	100 = 1%

No.	Name	Type	Range	Unit	FbEq32
71.02	Feedback act value	<i>Real</i>	-200000.00...200000.00	PID unit 1	100 = 1 PID unit 1
71.03	Setpoint act value	<i>Real</i>	-200000.00...200000.00	PID unit 1	100 = 1 PID unit 1
71.04	Deviation act value	<i>Real</i>	-200000.00...200000.00	PID unit 1	100 = 1 PID unit 1
71.06	PID status word	<i>PB</i>	0000h...FFFFh	-	1 = 1
71.07	PID operation mode	<i>List</i>	0...2	-	1 = 1
71.08	Feedback 1 source	<i>Analog src</i>	-	-	1 = 1
71.11	Feedback filter time	<i>Real</i>	0.000...30.000	s	1000 = 1 s
71.14	Setpoint scaling	<i>Real</i>	-200000.00...200000.00	-	100 = 1
71.15	Output scaling	<i>Real</i>	-200000.00...200000.00	-	100 = 1
71.16	Setpoint 1 source	<i>Analog src</i>	-	-	1 = 1
71.19	Internal setpoint sel1	<i>Binary src</i>	-	-	1 = 1
71.20	Internal setpoint sel2	<i>Binary src</i>	-	-	1 = 1
71.21	Internal setpoint 1	<i>Real</i>	-200000.00...200000.00	PID unit 1	100 = 1 PID unit 1
71.22	Internal setpoint 2	<i>Real</i>	-200000.00...200000.00	PID unit 1	100 = 1 PID unit 1
71.23	Internal setpoint 3	<i>Real</i>	-200000.00...200000.00	PID unit 1	100 = 1 PID unit 1
71.26	Setpoint min	<i>Real</i>	-200000.00...200000.00	-	100 = 1
71.27	Setpoint max	<i>Real</i>	-200000.00...200000.00	-	100 = 1
71.31	Deviation inversion	<i>Binary src</i>	-	-	1 = 1
71.32	Gain	<i>Real</i>	0.10...100.00	-	100 = 1
71.33	Integration time	<i>Real</i>	0.0...9999.0	s	10 = 1 s
71.34	Derivation time	<i>Real</i>	0.000...10.000	s	1000 = 1 s
71.35	Derivation filter time	<i>Real</i>	0.0...10.0	s	10 = 1 s
71.36	Output min	<i>Real</i>	-200000.00...200000.00	-	10 = 1
71.37	Output max	<i>Real</i>	-200000.00...200000.00	-	10 = 1
71.38	Output freeze enable	<i>Binary src</i>	-	-	1 = 1
71.39	Deadband range	<i>Real</i>	0.0...200000.0	-	10 = 1
71.40	Deadband delay	<i>Real</i>	0.0...3600.0	s	10 = 1 s
71.58	Increase prevention	<i>Binary src</i>	-	-	1 = 1
71.59	Decrease prevention	<i>Binary src</i>	-	-	1 = 1
71.62	Internal setpoint actual	<i>Real</i>	-200000.00...200000.00	PID unit 1	100 = 1 PID unit 1

No.	Name	Type	Range	Unit	FbEq32
71.79	External PID units	List	0, 4, 21, 26, 29, 34, 37...38, 40, 44, 47...48, 50...52, 58...59, 65, 74...80, 88, 94, 125...126, 131, 150...151	-	1 = 1
76 Multipump configuration					
76.01	PFC status	PB	0000h...FFFFh	-	1 = 1
76.02	Multipump system status	List	0...9, 100...103, 200...202, 300...302, 400, 500, 600, 700...734, 800...801	-	1 = 1
76.11	Pump/fan status 1	PB	0000h...FFFFh	-	1 = 1
76.12	Pump/fan status 2	PB	0000h...FFFFh	-	1 = 1
76.13	Pump/fan status 3	PB	0000h...FFFFh	-	1 = 1
76.14	Pump/fan status 4	PB	0000h...FFFFh	-	1 = 1
76.15	Pump/fan status 5	PB	0000h...FFFFh	-	1 = 1
76.16	Pump/fan status 6	PB	0000h...FFFFh	-	1 = 1
76.17	Pump/fan status 7	PB	0000h...FFFFh	-	1 = 1
76.18	Pump/fan status 8	PB	0000h...FFFFh	-	1 = 1
76.21	Multipump configuration	List	0, 1...3	-	1 = 1
76.22	Multipump node number	Real	1...8	-	1 = 1
76.23	Master enable	List	0...1	-	1 = 1
76.24	IPC communication port	List	0...1	-	1 = 1
76.25	Number of motors	Real	1...8	-	1 = 1
76.26	Min number of motors allowed	Real	0...8	-	1 = 1
76.27	Max number of motors allowed	Real	1...8	-	1 = 1
76.30	Start point 1	Real	0.00...32767.00	rpm/Hz	1 = 1 unit
76.31	Start point 2	Real	0.00...32767.00	rpm/Hz	1 = 1 unit
76.32	Start point 3	Real	0.00...32767.00	rpm/Hz	1 = 1 unit
76.33	Start point 4	Real	0.00...32767.00	rpm/Hz/m	1 = 1 unit
76.34	Start point 5	Real	0.00...32767.00	rpm/Hz/m	1 = 1 unit
76.35	Start point 6	Real	0.00...32767.00	rpm/Hz/m	1 = 1 unit
76.36	Start point 7	Real	0.00...32767.00	rpm/Hz/m	1 = 1 unit
76.41	Stop point 1	Real	0.00...32767.00	rpm/Hz	1 = 1 unit
76.42	Stop point 2	Real	0.00...32767.00	rpm/Hz	1 = 1 unit
76.43	Stop point 3	Real	0.00...32767.00	rpm/Hz	1 = 1 unit
76.44	Stop point 4	Real	0.00...32767.00	rpm/Hz/m	1 = 1 unit
76.45	Stop point 5	Real	0.00...32767.00	rpm/Hz/m	1 = 1 unit
76.46	Stop point 6	Real	0.00...32767.00	rpm/Hz/m	1 = 1 unit
76.47	Stop point 7	Real	0.00...32767.00	rpm/Hz/m	1 = 1 unit
76.55	Start delay	Real	0.00...12600.00	s	100 = 1 s
76.56	Stop delay	Real	0.00...12600.00	s	100 = 1 s
76.57	PFC speed hold on	Real	0.00...1000.00	s	100 = 1 s
76.58	PFC speed hold off	Real	0.00...1000.00	s	100 = 1 s
76.59	PFC contactor delay	Real	0.20...600.00	s	100 = 1 s

No.	Name	Type	Range	Unit	FbEq32
76.60	PFC ramp acceleration time	<i>Real</i>	0.00...1800.00	s	100 = 1 s
76.61	PFC ramp deceleration time	<i>Real</i>	0.00...1800.00	s	100 = 1 s
76.62	IPC smooth acceleration time	<i>Real</i>	3.00...1800.00	s	100 = 1 s
76.63	IPC smooth deceleration time	<i>Real</i>	3.00...1800.00	s	100 = 1 s
76.64	Run permissive timeout	<i>Real</i>	0.00...300.00	s	100 = 1 s
76.70	PFC Autochange	<i>Binary src</i>	0...13	-	1 = 1
76.71	PFC Autochange interval	<i>Real</i>	0.00...100000.00	h	100 = 1 h
76.72	Maximum wear imbalance	<i>Real</i>	0.00...1000000.00	h	100 = 1 h
76.73	Autochange level	<i>Real</i>	0.0...300.0	%	10 = 1%
76.74	Autochange auxiliary PFC	<i>List</i>	0...1	-	1 = 1
76.76	Max stationary time	<i>Real</i>	0.0...214748368.0	h	10 = 1 h
76.77	Pump priority	<i>List</i>	1, 3, 5	-	1 = 1
76.81	PFC 1 interlock	<i>Binary src</i>	-	-	1 = 1
76.82	PFC 2 interlock	<i>Binary src</i>	-	-	1 = 1
76.83	PFC 3 interlock	<i>Binary src</i>	-	-	1 = 1
76.84	PFC 4 interlock	<i>Binary src</i>	-	-	1 = 1
76.85	PFC 5 interlock	<i>Binary src</i>	-	-	1 = 1
76.86	PFC 6 interlock	<i>Binary src</i>	-	-	1 = 1
76.95	Regulator bypass control	<i>Binary src</i>	-	-	1 = 1
76.101	IPC parameter synchronization	<i>List</i>	1...2	-	1 = 1
76.102	IPC synchronization settings	<i>PB</i>	0000h...FFFFh	-	1 = 1
76.105	IPC synchronization checksum	<i>PB</i>	0000h...FFFFh	-	1 = 1
77 Multipump maintenance and monitoring					
77.10	PFC runtime change	<i>List</i>	0...7	-	1 = 1
77.11	Pump/fan 1 running time	<i>Real</i>	0.00...42949672.95	h	100 = 1 h
77.12	Pump/fan 2 running time	<i>Real</i>	0.00...42949672.95	h	100 = 1 h
77.13	Pump/fan 3 running time	<i>Real</i>	0.00...42949672.95	h	100 = 1 h
77.14	Pump/fan 4 running time	<i>Real</i>	0.00...42949672.95	h	100 = 1 h
77.15	Pump/fan 5 running time	<i>Real</i>	0.00...42949672.95	h	100 = 1 h
77.16	Pump/fan 6 running time	<i>Real</i>	0.00...42949672.95	h	100 = 1 h
77.17	Pump 7 running time	<i>Real</i>	0.00...42949672.95	h	100 = 1 h
77.18	Pump 8 running time	<i>Real</i>	0.00...42949672.95	h	100 = 1 h
77.20	IPC online pumps	<i>PB</i>	0000h...FFFFh	-	1 = 1
77.21	IPC comm loss status	<i>PB</i>	0000h...FFFFh	-	1 = 1

No.	Name	Type	Range	Unit	FbEq32
80 Flow calculation					
80.01	Actual flow	<i>Real</i>	-10000.00...10000.00	flow unit	100 = 1 flow unit
80.02	Actual flow percentage	<i>Real</i>	-100.00...100.00	%	100 = 1%
80.03	Total volume	<i>Real</i>	0.00...21474836.00	based on flow unit	100 = 1 unit
80.04	Specific energy	<i>Real</i>	0.00...32767.95	based on flow unit	100 = 1 unit
80.05	Estimated pump head	<i>Real</i>	0.00...32767.00	length unit	100 = 1 length unit
80.11	Flow feedback 1 source	<i>Analog src</i>	-	-	1 = 1
80.12	Flow feedback 2 source	<i>Analog src</i>	-	-	1 = 1
80.13	Flow feedback function	<i>List</i>	0...1, 8...9	-	1 = 1
80.14	Flow feedback multiplier	<i>Real</i>	-200000.00...200000.00	-	100 = 1
80.15	Maximum flow	<i>Real</i>	-200000.00...200000.00	flow unit	100 = 1 flow unit
80.16	Minimum flow	<i>Real</i>	-200000.00...200000.00	flow unit	100 = 1 flow unit
80.17	Maximum flow protection	<i>List</i>	0...3	-	1 = 1
80.18	Minimum flow protection	<i>List</i>	0...3	-	1 = 1
80.19	Flow check delay	<i>Real</i>	0.00...3600.00	s	100 = 1 s
80.20	Volume unit multiplier	<i>Real</i>	1 or 1000	-	1 = 1
80.21	Flow pump nominal speed	<i>Real</i>	0.0...30000.0	rpm	1 = 1 rpm
80.22	Pump inlet diameter	<i>Real</i>	0.010...32767.000	length unit	1000 = 1 length unit
80.23	Pump outlet diameter	<i>Real</i>	0.010...32767.000	length unit	1000 = 1 length unit
80.26	Calculation minimum speed	<i>Real</i>	0.00...32767.00	rpm/Hz	100 = 1 unit
80.28	Density	<i>Real</i>	0.00...32767.00	density unit	100 = 1 density unit
80.29	Total volume reset	<i>List</i>	-	-	1 = 1
80.31	Total volume reset date	<i>Real</i>	-	-	-
80.32	Total volume reset time	<i>Real</i>	-	-	-
80.40	H curve H1	<i>Real</i>	0.00...32767.00	length unit	100 = 1 length unit
80.41	H curve H2	<i>Real</i>	0.00...32767.00	length unit	100 = 1 length unit
80.42	H curve H3	<i>Real</i>	0.00...32767.00	length unit	100 = 1 length unit
80.43	H curve H4	<i>Real</i>	0.00...32767.00	length unit	100 = 1 length unit
80.44	H curve H5	<i>Real</i>	0.00...32767.00	length unit	100 = 1 length unit
80.45	H curve H6	<i>Real</i>	0.00...32767.00	length unit	100 = 1 length unit

No.	Name	Type	Range	Unit	FbEq32
80.46	H curve H7	<i>Real</i>	0.00...32767.00	length unit	100 = 1 length unit
80.47	H curve H8	<i>Real</i>	0.00...32767.00	length unit	100 = 1 length unit
80.48	H curve H9	<i>Real</i>	0.00...32767.00	length unit	100 = 1 length unit
80.49	H curve H10	<i>Real</i>	0.00...32767.00	length unit	100 = 1 length unit
80.50	P curve P1	<i>Real</i>	0.00...32767.00	kW or Hp	100 = 1 unit
80.51	P curve P2	<i>Real</i>	0.00...32767.00	kW or Hp	100 = 1 unit
80.52	P curve P3	<i>Real</i>	0.00...32767.00	kW or Hp	100 = 1 unit
80.53	P curve P4	<i>Real</i>	0.00...32767.00	kW or Hp	100 = 1 unit
80.54	P curve P5	<i>Real</i>	0.00...32767.00	kW or Hp	100 = 1 unit
80.55	P curve P6	<i>Real</i>	0.00...32767.00	kW or Hp	100 = 1 unit
80.56	P curve P7	<i>Real</i>	0.00...32767.00	kW or Hp	100 = 1 unit
80.57	P curve P8	<i>Real</i>	0.00...32767.00	kW or Hp	100 = 1 unit
80.58	P curve P9	<i>Real</i>	0.00...32767.00	kW or Hp	100 = 1 unit
80.59	P curve P10	<i>Real</i>	0.00...32767.00	kW or Hp	100 = 1 unit
80.60	Q value Q1	<i>Real</i>	0.00...200000.00	flow unit	100 = 1 flow unit
80.61	Q value Q2	<i>Real</i>	0.00...200000.00	flow unit	100 = 1 flow unit
80.62	Q value Q3	<i>Real</i>	0.00...200000.00	flow unit	100 = 1 flow unit
80.63	Q value Q4	<i>Real</i>	0.00...200000.00	flow unit	100 = 1 flow unit
80.64	Q value Q5	<i>Real</i>	0.00...200000.00	flow unit	100 = 1 flow unit
80.65	Q value Q6	<i>Real</i>	0.00...200000.00	flow unit	100 = 1 flow unit
80.66	Q value Q7	<i>Real</i>	0.00...200000.00	flow unit	100 = 1 flow unit
80.67	Q value Q8	<i>Real</i>	0.00...200000.00	flow unit	100 = 1 flow unit
80.68	Q value Q9	<i>Real</i>	0.00...200000.00	flow unit	100 = 1 flow unit
80.69	Q value Q10	<i>Real</i>	0.00...200000.00	flow unit	100 = 1 flow unit
81 Sensor settings					
81.01	Actual inlet pressure	<i>Real</i>	0.00...32767.00	pressure unit	100 = 1 pressure unit
81.02	Actual outlet pressure	<i>Real</i>	0.00...32767.00	pressure unit	100 = 1 pressure unit
81.10	Inlet pressure source	<i>Analog src</i>	-	-	1 = 1
81.11	Outlet pressure source	<i>Analog src</i>	-	-	1 = 1

No.	Name	Type	Range	Unit	FbEq32
81.12	Sensors height difference	<i>Real</i>	0.00...32767.00	length unit	100 = 1 length unit
81.20	Pressure unit	<i>List</i>	0...3	-	1 = 1
81.21	Flow unit	<i>List</i>	0...2	-	1 = 1
81.22	Length unit	<i>List</i>	69, 72, 73, 27	-	1 = 1
81.23	Density unit	<i>List</i>	0...2	-	1 = 1
82 Pump protections					
82.20	Dry run protection	<i>List</i>	0...3	-	1 = 1
82.21	Dry run source	<i>List</i>	0...9	-	1 = 1
82.25	Soft pipe fill supervision	<i>List</i>	0...2	-	1 = 1
82.26	Time-out limit	<i>Real</i>	0.0...1800.0	s	10 = 1 s
82.30	Outlet minimum pressure protection	<i>List</i>	0...3	-	1 = 1
82.31	Outlet minimum pressure warning level	<i>Real</i>	0.00...32767.00	pressure unit	100 = 1 pressure unit
82.32	Outlet minimum pressure fault level	<i>Real</i>	0.00...32767.00	pressure unit	100 = 1 pressure unit
82.35	Outlet maximum pressure protection	<i>List</i>	0...3	-	1 = 1
82.37	Outlet maximum pressure warning level	<i>Real</i>	0.00...32767.00	pressure unit	100 = 1 pressure unit
82.38	Outlet maximum pressure fault level	<i>Real</i>	0.00...32767.00	pressure unit	100 = 1 pressure unit
82.40	Inlet minimum pressure protection	<i>List</i>	0...3	-	1 = 1
82.41	Inlet minimum pressure warning level	<i>Real</i>	0.00...32767.00	pressure unit	100 = 1 pressure unit
82.42	Inlet minimum pressure fault level	<i>Real</i>	0.00...32767.00	pressure unit	100 = 1 pressure unit
82.45	Pressure check delay	<i>Real</i>	0.00...3600.00	s	100 = 1 s
82.51	Pump autoreset selection	<i>Real</i>	0...65535	-	1 = 1
82.52	Pump autoreset delay time	<i>Real</i>	0.0...32767.0	min	10 = 1 min
84 Advanced damper control					
84.01	Advanced damper configuration	<i>List</i>	0...3	-	1 = 1
84.02	Damper control status word	<i>PB</i>	0000h...FFFFh	-	1 = 1
84.03	DA damper open input	<i>Binary src</i>	-	-	1 = 1
84.04	DA damper open timeout	<i>Real</i>	0...90	s	1 = 1 s
84.05	DA damper open timeout action	<i>List</i>	0...3	-	1 = 1
84.06	DA damper closed input	<i>Binary src</i>	-	-	1 = 1
84.07	DA damper closed timeout	<i>Real</i>	0...90	s	1 = 1 s
84.08	DA damper closed timeout action	<i>List</i>	0...3	-	1 = 1

No.	Name	Type	Range	Unit	FbEq32
84.13	OA damper open input	<i>Binary src</i>	-	-	1 = 1
84.14	OA damper open timeout	<i>Real</i>	0...90	s	1 = 1 s
84.15	OA damper open timeout action	<i>List</i>	0...3	-	1 = 1
84.16	OA damper closed input	<i>Binary src</i>	-	-	1 = 1
84.17	OA damper closed timeout	<i>Real</i>	0...90	s	1 = 1 s
84.18	OA damper closed timeout action	<i>List</i>	0...3	-	1 = 1
95 HW configuration					
95.01	Supply voltage	<i>List</i>	0...3	-	1 = 1
95.02	Adaptive voltage limits	<i>List</i>	0, 2...3	-	1 = 1
95.03	Estimated AC supply voltage	<i>Real</i>	0...65535	V	1 = 1 V
95.04	Control board supply	<i>List</i>	0...1	-	1 = 1
95.15	Special HW settings	<i>PB</i>	00000000h...FFFFFFFh	-	1 = 1
95.20	HW options word 1	<i>PB</i>	0000h...FFFFFFh	-	1 = 1
95.26	Motor disconnect detection	<i>List</i>	0...1	-	1 = 1
95.200	Cooling fan mode	<i>List</i>	0...1	-	1 = 1
96 System					
96.01	Language	<i>List</i>	-	-	1 = 1
96.02	Pass code	<i>Data</i>	0...99999999	-	1 = 1
96.03	Access level status	<i>PB</i>	00000000h...FFFFFFFh	-	1 = 1
96.04	Macro select	<i>List</i>	0...1	-	1 = 1
96.05	Macro active	<i>List</i>	1	-	1 = 1
96.06	Parameter restore	<i>List</i>	0, 2, 8, 32, 62, 512, 1024, 34560	-	1 = 1
96.07	Parameter save manually	<i>List</i>	0...1	-	1 = 1
96.08	Control board boot	<i>List</i>	0...1	-	1 = 1
96.10	User set status	<i>List</i>	0...7, 20...23	-	1 = 1
96.11	User set save/load	<i>List</i>	0...5, 18...21	-	1 = 1
96.12	User set I/O mode in1	<i>Binary src</i>	-	-	1 = 1
96.13	User set I/O mode in2	<i>Binary src</i>	-	-	1 = 1
96.16	Unit selection	<i>PB</i>	0000h...FFFFFFh	-	1 = 1
96.20	Time sync primary source	<i>List</i>	0, 3, 6, 8, 9	-	1 = 1
96.24	Full days since 1st Jan 1980	<i>Real</i>	1...59999	d	1 = 1 d
96.25	Time in minutes within 24h	<i>Real</i>	1...1439	min	1 = 1 min
96.26	Time in ms within one minute	<i>Real</i>	0...59999	ms	1 = 1 ms
96.39	Event configuration	<i>Real</i>	0...59999	-	1 = 1
96.51	Clear fault and event logger	<i>Real</i>	0...1	-	1 = 1
96.54	Checksum action	<i>List</i>	0...4	-	1 = 1

No.	Name	Type	Range	Unit	FbEq32
96.55	Checksum control word	<i>PB</i>	0000h...FFFFh	-	1 = 1
96.68	Actual checksum A	<i>PB</i>	00000000h...FFFFFFFFh	-	1 = 1
96.69	Actual checksum B	<i>PB</i>	00000000h...FFFFFFFFh	-	1 = 1
96.70	Disable adaptive program	<i>List</i>	0...1	-	1 = 1
96.71	Approved checksum A	<i>PB</i>	00000000h...FFFFFFFFh	-	1 = 1
96.72	Approved checksum B	<i>PB</i>	00000000h...FFFFFFFFh	-	1 = 1
96.78	550 Compatibility mode	<i>List</i>	0...2	-	1 = 1
96.79	Legacy control profile	<i>List</i>	0...3	-	1 = 1
96.100	Change user pass code	<i>Data</i>	10000000...99999999	-	1 = 1
96.101	Confirm user pass code	<i>Data</i>	10000000...99999999	-	1 = 1
96.102	User lock functionality	<i>PB</i>	0000h...FFFFh	-	1 = 1
97 Motor control					
97.01	Switching frequency reference	<i>List</i>	2, 4, 8, 12	kHz	1 = 1 kHz
97.02	Minimum switching frequency	<i>List</i>	1, 2, 4, 8, 12	kHz	1 = 1 kHz
97.03	Slip gain	<i>Real</i>	0...200	%	1 = 1%
97.04	Voltage reserve	<i>Real</i>	-4...50	%	1 = 1%
97.05	Flux braking	<i>List</i>	0...2	-	1 = 1
97.08	Optimizer minimum torque	<i>Real</i>	0.0...1600.0	%	10 = 1%
97.11	TR tuning	<i>Real</i>	25...400	%	1 = 1%
97.13	IR compensation	<i>Real</i>	0.00...50.00	%	100 = 1%
97.15	Motor model temperature adaptation	<i>List</i>	0...1	-	1 = 1
97.16	Stator temperature factor	<i>Real</i>	0...200	%	1 = 1%
97.17	Rotor temperature factor	<i>Real</i>	0...200	%	1 = 1%
97.20	U/F ratio	<i>List</i>	0...1	-	1 = 1
97.48	UDC stabilizer	<i>List</i>	0, 50, 100, 300, 500, 800	-	1 = 1
97.49	Slip gain for scalar	<i>Real</i>	0...200	%	1 = 1%
97.94	IR comp max frequency	<i>Real</i>	1.0...200.0	%	1 = 1%
97.135	UDC ripple	<i>Real</i>	0.0...200.0	V	10 = 1V
98 User motor parameters					
98.01	User motor model mode	<i>List</i>	0...1	-	1 = 1
98.02	Rs user	<i>Real</i>	0.0000...0.50000	p.u.	100000 = 1 p.u.
98.03	Rr user	<i>Real</i>	0.0000...0.50000	p.u.	100000 = 1 p.u.
98.04	Lm user	<i>Real</i>	0.00000...10.00000	p.u.	100000 = 1 p.u.
98.05	SigmaL user	<i>Real</i>	0.00000...1.00000	p.u.	100000 = 1 p.u.
98.06	Ld user	<i>Real</i>	0.00000...10.00000	p.u.	100000 = 1 p.u.
98.07	Lq user	<i>Real</i>	0.00000...10.00000	p.u.	100000 = 1 p.u.

No.	Name	Type	Range	Unit	FbEq32
98.08	PM flux user	<i>Real</i>	0.00000...2.00000	p.u.	100000 = 1 p.u.
98.09	Rs user SI	<i>Real</i>	0.00000...100.00000	ohm	100000 = 1 ohm
98.10	Rr user SI	<i>Real</i>	0.00000...100.00000	ohm	100000 = 1 ohm
98.11	Lm user SI	<i>Real</i>	0.00...100000.00	mH	100 = 1 mH
98.12	SigmaL user SI	<i>Real</i>	0.00...100000.00	mH	100 = 1 mH
98.13	Ld user SI	<i>Real</i>	0.00...100000.00	mH	100 = 1 mH
98.14	Lq user SI	<i>Real</i>	0.00...100000.00	mH	100 = 1 mH
99 Motor data					
99.03	Motor type	<i>List</i>	0...2	-	1 = 1
99.04	Motor control mode	<i>List</i>	0...1	-	1 = 1
99.06	Motor nominal current	<i>Real</i>	0.0...6400.0	A	10 = 1 A
99.07	Motor nominal voltage	<i>Real</i>	0.0...960.0	V	10 = 1 V
99.08	Motor nominal frequency	<i>Real</i>	0.00 ... 500.00	Hz	100 = 1 Hz
99.09	Motor nominal speed	<i>Real</i>	0 ... 30000	rpm	1 = 1 rpm
99.10	Motor nominal power	<i>Real</i>	0.00...10000.00 kW or 0.00 ... 13404.83 hp	kW or hp	100 = 1 unit
99.11	Motor nominal cos Φ	<i>Real</i>	0.00 ... 1.00	-	100 = 1
99.12	Motor nominal torque	<i>Real</i>	0.000...400000.000 N·m or 0.000...2950248.597 lb·ft	N·m or lb·ft	1000 = 1 unit
99.13	ID run requested	<i>List</i>	0...3, 8	-	1 = 1
99.14	Last ID run performed	<i>List</i>	0...3, 8	-	1 = 1
99.15	Motor polepairs calculated	<i>Real</i>	0...1000	-	1 = 1
99.16	Motor phase order	<i>List</i>	0...1	-	1 = 1

Further information

Product and service inquiries

Address any inquiries about the product to your local ABB representative, quoting the type designation and serial number of the unit in question. A listing of ABB sales, support and service contacts can be found by navigating to

<https://new.abb.com/channel-partners/search>.

Product training

For information on ABB product training, navigate to new.abb.com/service/training.

Providing feedback on ABB Drives manuals

Your comments on our manuals are welcome. Navigate to

new.abb.com/drives/manuals-feedback-form.

Document library on the Internet

You can find manuals and other product documents in PDF format on the Internet at

<https://library.abb.com/>.



abb.com/drives



3AXD50000247134D