

---

CATALOG

## **ABB drives for HVACR**

ACH480, 0.37 to 22 kW, 0.5 to 30 hp

ACH580, 0.75 to 500 kW, 1 to 700 hp



---

## **ACH480 and ACH580 series**

Leading the way in HVACR drives

**Comfort. It's something we take for granted in the buildings we live and work in. But comfort requires efficient systems to control heating, ventilation, air conditioning and refrigeration (HVACR) to ensure the air we breathe is pure and the temperature is comfortable. We also need to ensure air quality and safety in the most energy-efficient and cost-effective way in both normal and mission-critical situations.**

**ABB has been leading the way in optimizing HVACR systems using drive control to ensure that you can take comfort for granted. The new series of HVACR dedicated variable frequency drives (VFDs) provide the quality, reliability, and energy savings you expect, and are easy to use and safe to maintain. All you need to do is to set the drive up, and then focus on what counts.**

---

# Contents

04–05	The next step in HVACR drives
06–07	Premier HVACR control
08	HVACR application specific software features of the ACH480 and ACH580 drives
09	Generic software features of the ABB all-compatible drives
10	Complete HVACR drive offering
11	ACH480-04, compact drive for cabinet installations
12–13	ACH580-01, all-in-one drive for wall mounting
15	ACH580-04, high power drive module for cabinet builders needs
16–17	ACH580-07, effortless process automation in a ready-made cabinet
18	ACH580-31, the benefits of a drive without the inconvenience of harmonics
19	ACH580-34, exceptionally low harmonics in high power
20	ACH480 standard I/O interface
21	ACH580 standard I/O interface
22	ABB AC drives comply with the EU Ecodesign requirements
23	How to select a drive
24	ACH480 technical data
25	ACH580 technical data
26–29	Ratings, types and voltages
30–32	Dimensions
34–37	Cooling and fuses
38–39	Circuit breakers
40	Sine filters
41	du/dt filters
42	Input chokes and C1 filters
43	EMC – electromagnetic compatibility
44–45	Overcome challenges of harmonics
46	Control panel options and mounting kits
47	Control panel door mounting and daisy chaining
48	Easiness on a whole new level
50	ABB Ability™ Mobile Connect for drives
51	ABB Access
52	ABB SmartGuide for ACH480 and ACH580 drives
53	ABB GoSelect web-based tool
54–55	ABB Ability™ Digital Powertrain service
56–57	Communication and I/O options
58	Thermistor protection I/O option for increased safety
59	Tools for configuration, monitoring and process tuning
60	Choose the motor for your HVACR application
61	Synchronous reluctance motors
62–63	Selection guide, IE5 synchronous reluctance motors
64	ABB automation products
65–71	Summary of drive ordering codes
72–73	Our service expertise, your advantage
74	ABB Drives Life Cycle Management

## The next step in HVACR drives

We understand the complexity of air handling systems and the need to produce high levels of comfort and safety. Be assured that, regardless of the season or external conditions, we'll help make your system efficient, reliable, and informative, with ABB HVACR drives ACH480 and ACH580.

### Complete HVACR functionality

ABB HVACR drives come with complete HVACR functionality in a package tailored to your needs and share the same user interface. Fireman's override, intelligent pump control, active braking for tunnel ventilation and many other application-specific features are offered.

### Easy selection and installation

Depending on the drive model, various power and voltage ranges and all the essentials – chokes, EMC C1 and C2 filters, cabling clamps, enclosures from IP20/UL (NEMA) Type Open to IP55/UL (NEMA) Type 12 – are offered, thus simplifying selection, installation, and commissioning.

### Safe maintenance

The Safe Torque Off (STO) function is TÜV-certified to SIL 3/PL e and built in as standard in all HVACR drives to protect both people and machines. The ACH580 packaged disconnect solution provides a main disconnect switch, which further increases safety for people working on HVACR equipment.



### Motor control options to meet your application needs

ABB HVACR drives can be integrated with several types of AC motors, including induction, permanent magnet (PM) and even synchronous reluctance (SynRM) and permanent magnet assisted synchronous reluctance (PMSynRM) motors. The ability to use advanced motor technologies can reduce your energy costs even more.



### Added flexibility with I/O extensions

ABB HVACR drives have extensive I/O connections as standard and provide control flexibility with additional I/O configurations.



### Compliance with industry-specific standards and directives

The ACH580 drives exclusively offer compliance with A2L and A3 refrigerants according to IEC/UL 60335-2-40:2022 "Safety requirements for electrical heat pumps, air-conditioners and dehumidifiers" meaning the drives are not going to be a source of potential ignition and safe to operate next to HVACR equipment running on those refrigerants.

For tunnel ventilation, we offer compliance with EN 12101-3:2015 "Smoke and heat control systems. Specification of powered fans for smoke and heat control ventilators (fans)" in collaboration with fan OEMs to ensure safe system operation in mission-critical infrastructures.

### Effortless commissioning and operation

The drive's HVACR-specific software, intuitive keypad with customizable text and views, and menu-driven programming simplify set-up and operation of even complex applications. The optional Bluetooth® capability together with ABB's Drivetune smartphone app allows you to commission the drive remotely, providing access to the same menus available on the drive's HVACR control panel.

### Smooth integration into HVACR systems

BTL certified BACnet MS/TP, Modbus RTU, and N2 come as standard in every ACH480 and ACH580 drive. In addition, a wide range of optional fieldbus adapters, including BTL certified BACnet/IP, are available to enable connectivity with all major building automation and control systems.

### Clean power supply

The ACH580 ultra-low harmonic (ULH) drives secure a unity power factor and the lowest harmonic distortion in the network, for the most efficient and reliable operation. In combination with the ACH480 and the ACH580 6-pulse drives, the optimum cost/performance ratio can be achieved.

### Advanced software tools for easy configuration, startup and maintenance

Drive Composer PC tool can be simply connected to the drive's control panel via a USB interface. It supports startup, configuration, monitoring and process tuning. CCA-01 cold configuration adapter saves time as parameters for unpowered drives can already be set in the warehouse.



---

## Premier HVACR control

ABB HVACR drives are ideal for all your HVACR applications, such as air-handling units, chillers, heat pumps and cooling towers. They are suitable for use in a wide range of facilities from residential and commercial buildings to hospitals, data centers, airports and tunnels.

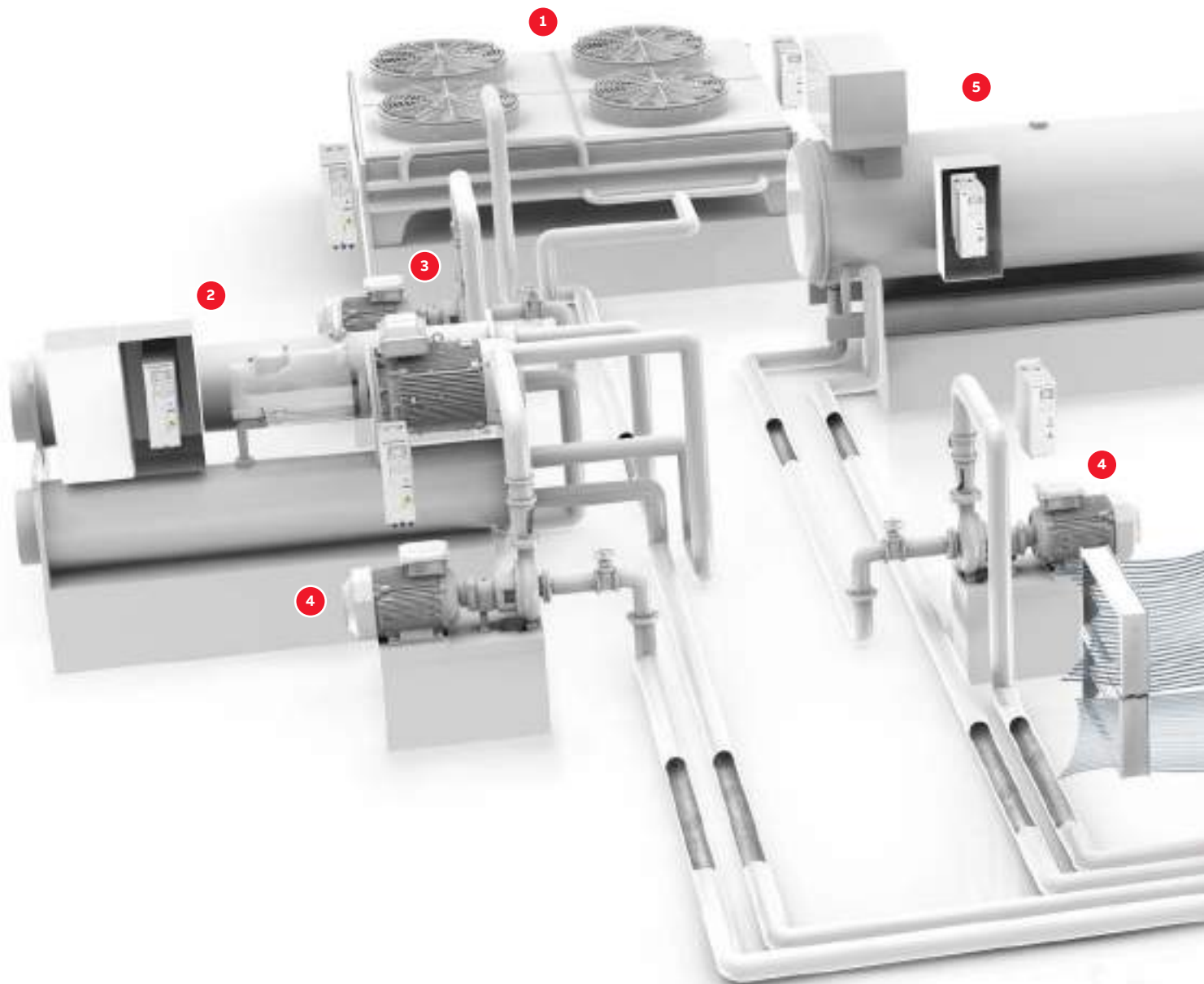

**1 Cooling tower**

Cools down the condenser water.

- The drive controls the speed of multiple fans simultaneously to achieve high energy savings, while optimising the installation cost

**2 Chiller**

Chills water or other liquid to cool down and dehumidify the indoor air.

- The drive controls the speed of the compressor for better energy efficiency
- By-pass valves can be avoided
- Less mechanical stress as there are less starts and stops, and they are soft
- Mechanical resonance speeds can be avoided
- Maximum speed is not limited by nominal supply frequency
- Less stress to supply network as inrush currents can be avoided with VFD controlled start

**3 Condenser water pump**

Circulates water between the cooling tower and the chiller.

- Energy savings can be achieved with variable frequency drives that adjust pump speed to the cooling need

**4 Chilled and hot water circulator pumps**

Circulate water (or other liquid) between heating coil and boiler or cooling coil and chiller.

- The cooling and heating loads vary a lot over time. Speed controlled circulator pumps make sure that an adequate amount of heating or cooling is distributed in the building.
- Soft start and stop of the pump reduces hydraulic stress on pipelines and valves

**5 Boiler**

Heats up the water for heating/domestic hot water supply.

- The drive controls the burner fan to adjust the amount of combustion air to the heating load

**6 Air handling unit**

Supplies, mixes, cleans, humidifies/dehumidifies, heats/cools air.

- Drives can be used to
  - control the speed of supply and return fans
  - eliminate mechanical stress
  - avoid fan resonance
  - control the speed of the rotary heat exchangers
  - control the dampers
  - monitor AHU condition including filter clogging, fan belts and heating coil freeze
- Drive-based override mode secures safe AHU operation in case of fire

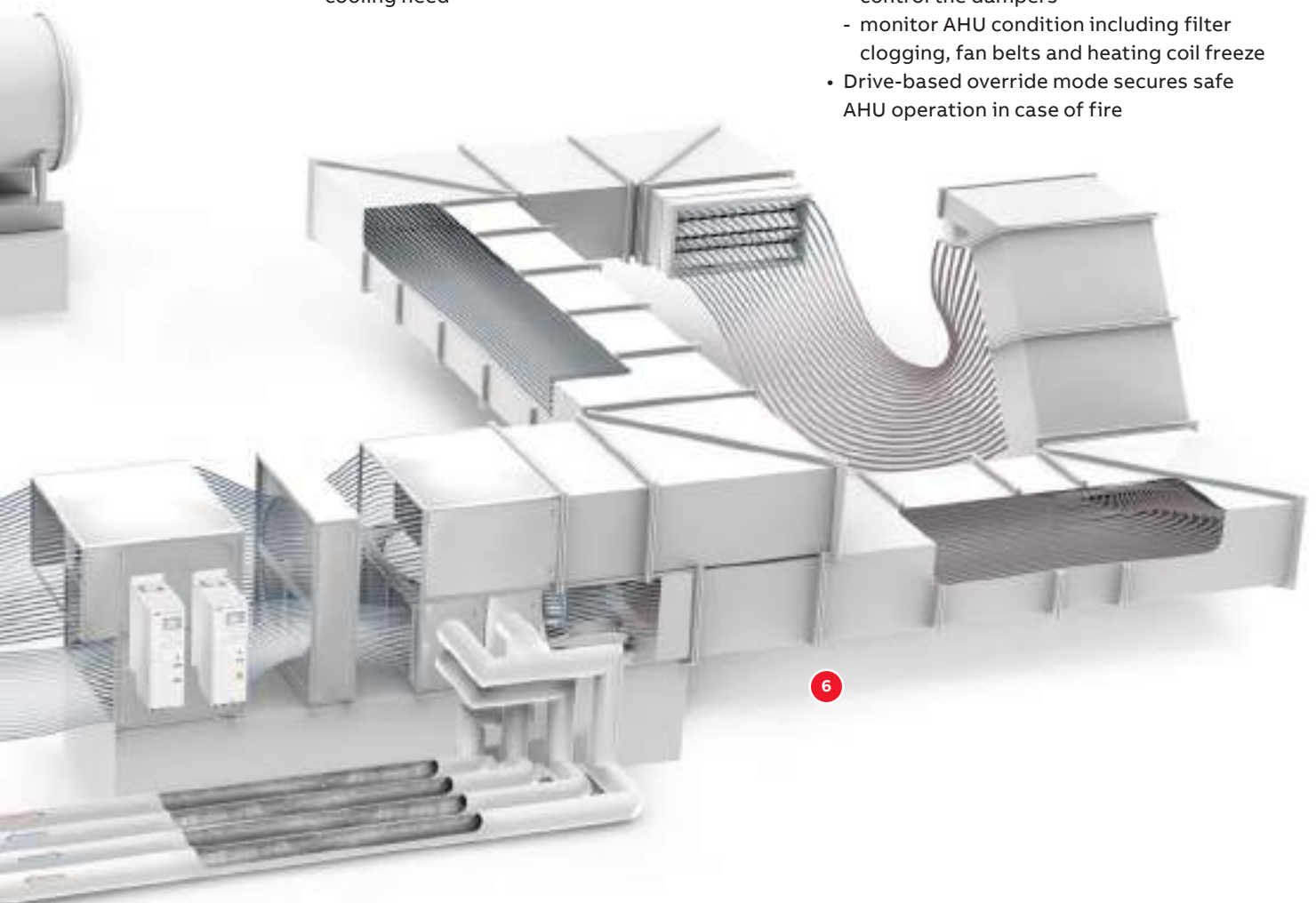

## HVACR application specific software features of the ACH480 and ACH580 drives

The ACH480 and ACH580 drives come with a range of advanced application features that provide a thorough heating, ventilation, air conditioning and refrigeration control.



### Soft start and stop

User defined ramps for softer fan/pump/compressor starts and stops eliminate mechanical and electrical stresses on the system.



### Flying start

Allows to catch free-wheeling fans and smoothly accelerate or decelerate them to a required speed, without wasting time on braking.



### Air filter monitoring

The drive alarms on a clogged filter, to maintain air quality and avoid energy losses.



### Leakage monitoring

In closed loop HVACR systems, drives can alarm on the leakage in the system, preventing flooding and property damage.



### Resonance monitoring

Mechanical resonance damages the application itself and connected piping/ductwork, while acoustic resonance makes the environment noisy. ABB drives skip resonance frequencies for better comfort and longer equipment lifetime.



### System overpressure protection

Protects water pipes/air ducts by stopping pump/fan operation when the measured pressure exceeds a threshold, e.g. due to closed valves/dampers.



### Fireman's override

In case of fire emergency, drives run fans ignoring faults and warnings, to ensure safe evacuation and mitigate the spread of smoke.



### Active braking

In tunnel ventilation, it's required to stop fans promptly in case of fire. ABB's ACH580-31/34 HVACR drives enable fast fan stop, regenerating braking energy to the network.

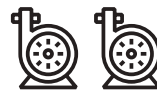

### Intelligent pump control

Maintains stable pumping process for up to 8 pumps operating in parallel. Optimizes the speed and number of pumps for required flow and pressure, even if one or more pumps fail.



### Bearing monitoring

Bearings are one of the weakest points in HVACR applications. Drives can alarm on the bearing upcoming failure, so it could be replaced timely, without HVACR process interruption.



### Motor heating

Prevents condensation and saves the motor from failure due to corrosion, which is typical for rooftop mounted air handlers.



### Pump dry run protection

Stops operation when the pressure on the pump suction side is below a threshold, to prevent pump damage from running dry.



### Frost protection

Cold temperatures outside might lead to heating coil freezing. To avoid damage, drives can alarm on a too low air temperature and shut down the system.



### Sleep/boost

Stops the pump at low demand, instead of running it slowly below its efficient operating range. Allows to save energy and extend the pump and motor lifetime by decreasing the number of starts/stops during the day.

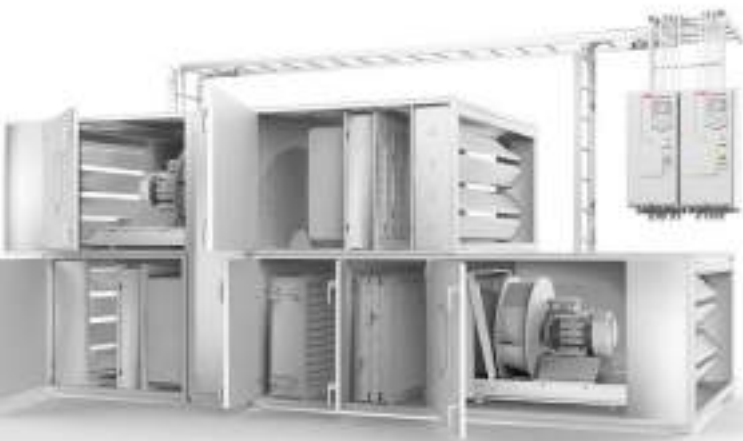



# Generic software features of the ABB all-compatible drives

The all-compatible drives platform offers features that make drive integration, commissioning, operation and diagnostics easier than ever before.

**Startup assistant** allows first-time users to quickly customize the drive according to their needs. Complemented by a built-in help function to make parameter-by-parameter setting easy.

**Motor control** is implemented in scalar and vector modes for induction, permanent magnet and synchronous reluctance or permanent magnet assisted synchronous reluctance motors. Motor protection features like thermal and overload protection are also established.

**The energy optimizer feature** optimizes the motor flux so that motor energy consumption and noise level are reduced when operating below the nominal load. The total efficiency can be improved by 1...20% depending on load torque and speed.

**Energy counter** monitors used and saved energy and displays it in kWh, currency or CO<sub>2</sub> emissions, to know how much exactly was saved.

**Drive safety and protection features** include overcurrent, DC over- and undervoltage, drive overheating and short circuit protection, motor phase loss and supply phase loss detection, local control loss detection and many more.

**People and machine safety** is ensured with drive-based Safe-Torque-Off feature, also allowing to conduct maintenance on the mechanical parts of equipment without shutting it down.

**Diagnostic assistant** helps in locating the cause of any disturbance to the drive, and suggests possible remedies. This reduces downtime by making repairs or adjustments effortless.

**A built-in process PID/loop controller** makes the drive a self-governing unit that requires no external logic input from the control room but only an external process measurement.

**Backup and restore feature** makes automatic and manual backups of the drive settings to the assistant panel. A backup can be restored to another drive.

**Adaptive programming** provides extra flexibility by offering easy alternative for simple programming needs. Download Drive Composer entry for free to start writing your application.



## Complete HVACR drive offering

No matter the construction type or power, all ABB HVACR drives offer ease of use, scalability, and quality.

— 01 Drive modules for cabinet installation, ACH480-04

— 02 Wall-mounted drives, ACH580-01 and ACH580-31 ultra-low harmonic version

— 03 Drive modules for cabinet installation, ACH580-04 and ACH580-34 ultra-low harmonic version

— 04 Cabinet-built drives, ACH580-07

### Drive modules for cabinet installation, ACH480-04

The ACH480 drive modules have a compact size making them a perfect solution for HVACR OEMs and panel builders. Available in IP20 with optional UL Type 1 kit, with power range up to 22 kW.

### Wall-mounted drives, ACH580-01 and ACH580-31 ultra-low harmonic version

ACH580 wall-mounted drives are available in IP21/UL Type 1 to IP55/UL Type 12 protection class with a power range up to 250 kW for ACH580-01 and up to 110 kW for ACH580-31 ultra-low harmonic variant. Drives offer side-by-side, flange, and horizontal mounting options.

The IP55/UL Type 12 variants are designed for applications exposed to dust, moisture, vibration, and other harsh conditions.

The ACH580-01 is a six-pulse drive that includes an optimized DC or AC choke for harmonic mitigation.

ACH580-31 ultra-low harmonic drives with embedded active front end and LCL filter keep the power network clean providing exceptionally low harmonic content. This brings improved reliability and increased energy savings, as well as extended equipment lifetime.

### Drive modules for cabinet installation, ACH580-04 and ACH580-34 ultra-low harmonic version

ACH580 drive modules are perfect for system integrators, cabinet builders, and OEMs who want to optimize cabinet design using ACH580-04 in power range 250–500 kW or ACH580-34 ultra-low harmonic version in power range 132–355 kW and protection classes IP00 (UL Type Open) and IP20 (UL Type 1), without compromising on easy installation, commissioning and maintenance.

The ACH580-04 comes with a choke for harmonic mitigation and ACH580-34 has embedded active front end and LCL filter keeping harmonics to a minimum.

### Cabinet-built drives, ACH580-07

Cabinet-built ACH580-07 drives are available in IP21 protection class as standard (UL Type 1) and optional IP42 (UL Type 1 Filtered) or IP54 (UL Type 12) in frame sizes R6 to R11. The drives feature an optimised cooling arrangement and a high-quality, global cabinet design. Available in a power range of 75–500 kW. ACH580-07 drives always have chokes for harmonic mitigation built-in.

— 01



— 02



— 03



— 04



## ACH480-04

### Compact drive for cabinet installations



- Take advantage of flexible, cost-optimised cabinet installation
- Uniform enclosure height and depth in all power sizes, DIN-rail and screw mounting, zero side clearance
- Platform reliability and robustness
- Comprehensive HVACR functionality inside

The ACH480-04 drive is designed for optimized cabinet installations. The uniform height and depth of all drives in the series saves valuable space in the cabinets, where the cabinet depth will not increase with higher drive powers.

Cabinet installations can be optimized further with the ability to share e.g. a single choke or control panel among all the drives in the cabinet.

### Protection for higher safety of the equipment and personnel

The UL Type 1 kit adds conduit box and dust hood to the standard ACH480-04 drive, making it possible to wall mount the ACH480 and comply with installation regulations in many parts of the world.



Ordering code	Frame	Description
3AXD50000176779	R1	Conduit box and a hood protecting from falling particles
3AXD50000178780	R2	
3AXD50000179220	R3	
3AXD50000179336	R4	

# ACH580-01

## All-in-one drive for wall mounting



- Take advantage of flexible, cabinet-free installation
- Save space and reduce overall costs
- Maintain process continuity in harsh conditions
- Minimize downtime and optimize HVACR operation

The ACH580-01 can be installed in normal equipment rooms, or even dusty and wet environments, thanks to the drive's wall mountable construction in both IP21 and IP55 protection

classes. The robust and protective design with all built-in ensures that no additional enclosures or components, such as filters and fans, are needed.

### High protection for operation in harsh environments

The wall-mounted IP55 ACH580-01 drive is designed for applications exposed to dust, moisture and other harsh environments. It is similar in size to the compact IP21 drives, and provides significant savings in space, maintenance, engineering, material costs, as well as in setup and commissioning time.



Option code	Description
+B056	IP55/UL Type 12 Unit

### Ready made accessories for simplified cabinet assembly

Installing ACH580-01 drive modules into Rittal VX25 cabinets is made easier with mechanical and electrical accessory kits. The ready made accessories will save time in design and building to ensure faster cabinet delivery. This will enable machine builders, system integrators and

panel builders to built drive packages using their own cabinet design with ABB technology.

For more information and ordering details, please see manual supplement 3AXD50000523191.

## Main disconnect switch for increased safety

The main disconnect switch option allows to disconnect the drive from the main supply when needed. It saves time, money and space as it is integrated in the drive. There is no need to install external isolation devices to the supply side of the drive. The option improves safety as it is always visible, when operating on the drive.

An auxiliary contact allows signaling the switch position to a PLC to avoid unnecessary alarms. The switch can be padlocked to the open position to disable drive operation during e.g. maintenance.

The ACH580-01 IP55/UL Type 12 units can be ordered with an integrated main switch and/or EMC C1 filter (R1-R5). Having the EMC C1 filter embedded to the drive, there is no need to order, install and test it separately. The integrated filter is already tested with the drive and prewired so there is no need for additional cabling.



Option code	Description
+B056	IP55/UL Type 12 unit (R1-R9)
+F278	Integrated main switch (R1-R5)
+E223	Integrated C1 filter (R1-R5)
+F316	Integrated main switch and C1 filter (R1-R5)

## IP20 option without a conduit box for cabinet installations

The option removes the conduit box from ACH580-01 frames R5-R9, making it easier to install the drive in cabinets with limited space. These IP20 units optimize the installation from cost and dimensioning point of view, and reduce waste. The option is also compatible with the flange mounting option for ACH580-01 frames R5-R9.



Option code	Description
+P944	Conduit box removal (R5-R9)

## Flange mounting

The ACH580-01 wall-mounted drive offers flange mounting as an option, separating the control electronics from the main circuit cooling airflow, saving space and ensuring optimal cooling. This results in better thermal management in panel installation. The flange mounting option enables smaller cabinets to be used as the backside of the drive is installed outside of the cabinet.

The option is compatible only with the standard IP21 units. It maintains the protection class of IP55 on the backside of the drive, while the front side of the drive is IP20. The option is also available as a loose item with an MRP code. If necessary, the conduit box can be removed from the frames R5-R9.

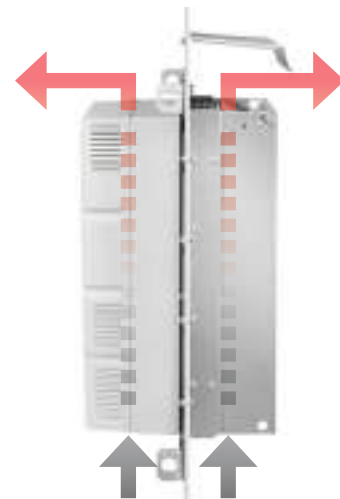

Option code	Description
+C135	Flange mounting
+P944	Conduit box removal (R5-R9)



## ACH580-04

### High power drive module for cabinet builders



- Compact drive module for cabinet mounting, saving floor space
- High power in compact size
- Easy installation, commissioning and maintenance with pedestal on wheels and ramp

ACH580-04 drive modules have been optimized for assembly into the customer's own cabinets to ensure high quality and compact installation at minimal cost.

Specifically designed for cabinet builders and systems integrators, the module variant is as standard IP00 but available as IP20 with additional finger shrouds. For optimized cabinet usage, features include power input connections on the top of the module and power output on the bottom. The control unit can be installed inside or outside of the module, enabling free location of input/output terminals. The external control unit can be mounted separately into a SELV enclosure.

Option code	Description
+B051	IP20 / UL Type 1 finger shrouds for modules
+H370	Full-size cable connection terminals for input power cables
+0H371	Drive module without full-size output cable connection terminals
+0H354	No pedestal
+0P919	No cabinet installation ramp
+P906	External control unit



# ACH580-07

Effortless process automation in a ready-made cabinet



- Easy to order with ready made standard design and variety of options
- Easy to maintain with effortlessly accessible and smartly positioned components
- EMC and thermal tested with certified results
- Adaptable to harsh environments with unique cooling system

The ACH580-07 drives are easy to use and maintain, and quickly available from the factory. An EMC filter, chokes, assistant control panel, Modbus RTU and BACnet MS/TP, STO and installation tools are included as standard, and in addition there are several options available to further fulfill your needs. Smartly positioned fans and filters ensure the longevity of the drive and its components. When it is time to do maintenance, the necessary

components are in easily accessible locations. The simple and robust design ensures reliable operation even in harsh environments.

Option code	Description
+B054	IP42 / UL Type 1 filtered for cabinet-built drives
+B055	IP54 UL Type 12 for cabinet-built drives

Empty cabinet options are available to the customers who need additional space for installation of auxiliary devices such as PLCs, relays, filters, brake resistors or by-pass systems. For more information, please contact your local ABB representative.

## Factory acceptance test (FAT)

To ensure that the cabinet solutions meet the specifications and the customer expectations, ABB offers to have a factory acceptance test (FAT) in our drives factory. Remote FAT or visual inspection is possible via online services.



## Frame sizes R6-R9

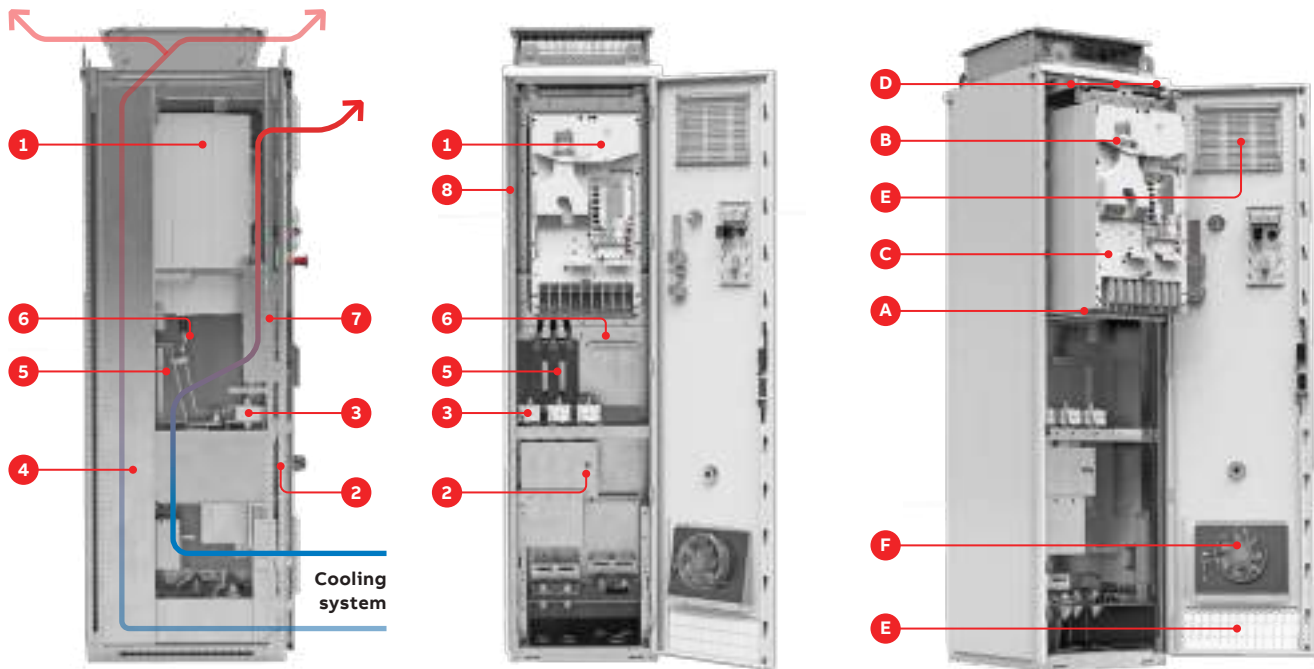

## Frame sizes R10-R11

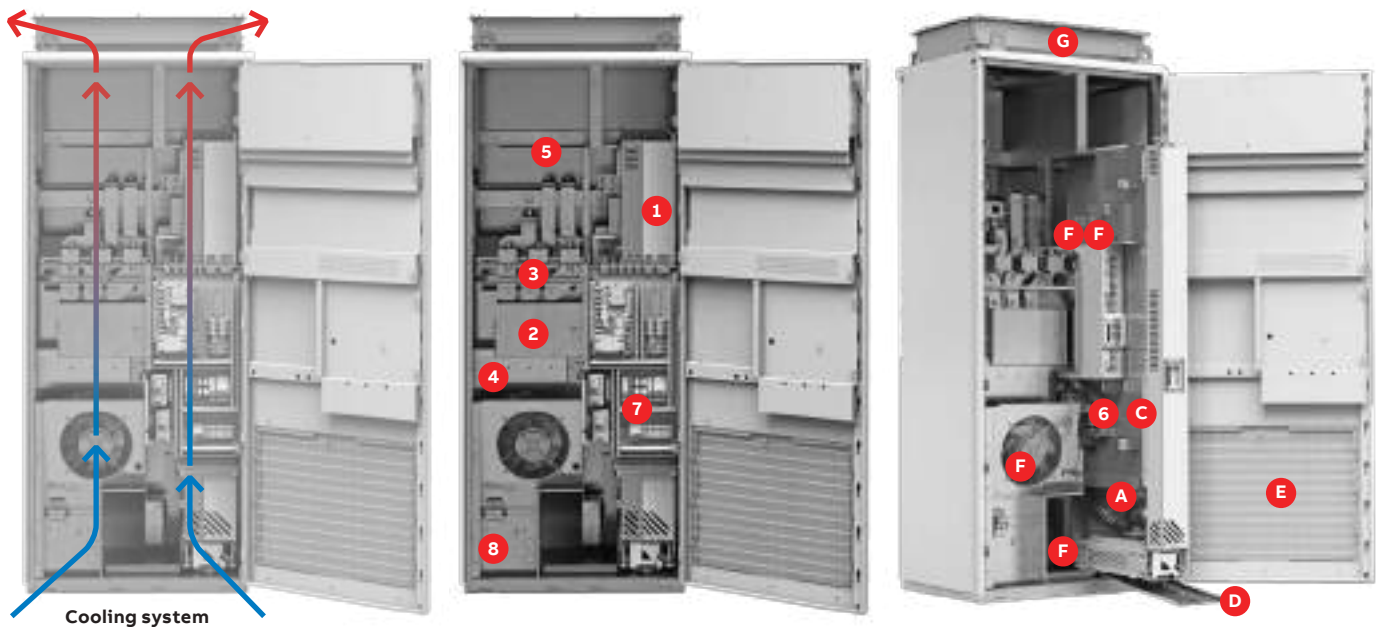

### Cabinet components

1. Module
2. Main switch or MCC8, option +F289
3. Fuses
4. Space for optional du/dt filter or cabinet resistors
5. Space for a line contactor option +F250
6. Common mode filter allocation
7. Space for safety, ATEX or external power supply options
8. Space for auxiliary motor fan starter options +M600...+M605

### Maintenance operation components

- A Main fans
- B Auxiliary fans
- C Capacitors (inside the module)
- D Rails and ramp supporting maintenance operation
- E Filters for dust and external components
- F Other supporting fans for R10 and R11
- G Roof top for R10 and R11 (only IP54)

## ACH580-31

The benefits of a drive without the inconvenience of harmonics



- Full HVACR functionality with clean power supply (THDi less than 3%)
- No overdimensioned transformers, switchgears or cables
- Simple to install – three wires in, three wires out, no external hardware required
- Active braking feature for tunnel ventilation

ACH580-31 wall-mountable ultra-low harmonic drives have full HVACR functionality and harmonic content less than 3%. It helps to keep the supply clean and meets the standards effortlessly. Everything comes as one compact package – the drive is easy to install and requires no external hardware.

The drives can be installed in wet and dusty environments, with robust IP55 enclosure. Flange mounting option allows optimal cooling or space saving in compact cabinets.



Option code	Description
+B056	IP55 / UL Type 12 for wall-mounted drive
+C135	Flange mounting

## ACH580-34

### Exceptionally low harmonics in high power



- Optimized for cabinet builder needs
- High power in compact size and clean supply (THDi less than 3%)
- Easy installation and commissioning, no external filters needed
- Easy to maintain and service with pedestal on wheels and ramp

ACH580-34 ultra-low harmonic drive modules have been optimized for assembly into the customer's own cabinets to ensure high quality and compact installation at minimal cost. The drive module is available from 132 kW to 355 kW. Installation and maintenance is made easy with wheeled pedestal and ramp that allows moving the module in and outside of the cabinet.

The module variant is IP00 but available as IP20 with additional finger shrouds. The control unit can be installed inside or outside of the module, enabling free location of input/output terminals. The external control unit can be mounted separately into a SELV enclosure.

#### Ready made accessories for simplified cabinet assembly

Installing ACH580-34 drive modules into Rittal VX25 cabinets is made easier with mechanical and electrical accessory kits. The ready made accessories will save time in design and building to ensure faster cabinet delivery. This will enable

Option code	Description
+B051	IP20 /UL Type 1 finger shrouds for modules
+H370	Full-size cable connection terminals for input power cables
+0H371	Drive module without full-size output cable connection terminals
+0H354	No pedestal
+0P919	No cabinet installation ramp
+P906	External control unit

machine builders, system integrators and panel builders to built drive packages using their own cabinet design with ABB technology.

For more information and ordering details, please see manual supplement 3AXD50000815838.

# ACH480 standard I/O interface

## Default control connections

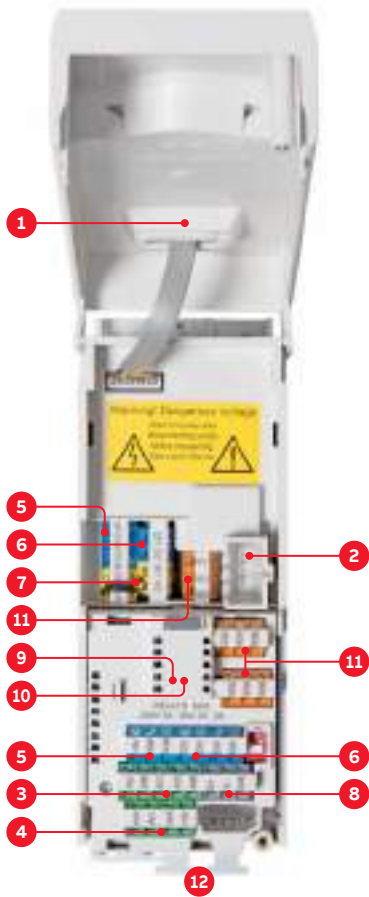

1. Panel port (PC tools, control panel)
2. ABB drive customizer port for programming the drive without mains
3. Analog inputs (2 × AI)
4. Analog outputs (2 × AO)
5. 24 V DC output
6. Digital inputs (6 × DI)
7. Safe Torque Off (STO)
8. Embedded fieldbus
9. Communication (fieldbus) options (replace some I/O)
10. I/O options
11. Relay outputs (3 × RO)
12. Mains and motor connection

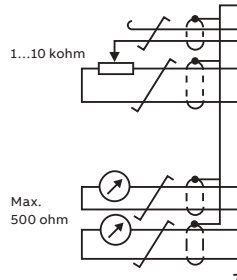

Terminal	Meaning	Default macro connections
<b>X1 Reference voltage and analog inputs and outputs</b>		
1	SCR	Signal cable shield (screen)
2	AI1	Output frequency/speed reference: 0 to 10 V
3	AGND	Analog input circuit common
4	+10 V	Reference voltage 10 V DC
5	AI2	Actual feedback: 0...20 mA
6	AGND	Analog input circuit common
7	AO1	Output frequency: 0 to 10 V
8	AO2	Motor current: 0...20 mA
9	AGND	Analog output circuit common
<b>X2 &amp; X3 Aux. voltage output and programmable digital inputs</b>		
10	+24 V	Aux. voltage output +24 V DC, max. 200 mA
11	DGND	Aux. voltage output common
12	DCOM	Digital input common for all
13	DI1	Stop (0)/Start (1)
14	DI2	Not configured
15	DI3	Constant frequency/speed selection
16	DI4	Start interlock 1 (1 = allow start)
17	DI5	Not configured
18	DI6	Not configured
<b>X6, X7, X8 Relay outputs</b>		
19	RO1C	<b>Damper control</b> 250 V AC/30 V DC 2 A Energize damper 19 connected to 21
20	RO1A	
21	RO1B	
22	RO2C	<b>Running</b> 250 V AC/30 V DC 2 A Running 22 connected to 24
23	RO2A	
24	RO2B	
25	RO3C	<b>Fault (-1)</b> 250 V AC/30 V DC 2 A Fault condition 25 connected to 26
26	RO3A	
27	RO3B	
<b>X5 Embedded fieldbus</b>		
29	B+	Embedded fieldbus (EIA-485): Modbus RTU, BACnet MS/TP, N2
30	A-	
31	DGND	
S100	TERM&BIAS	Termination switch and bias resistor switch
<b>X4 Safe Torque Off</b>		
34	SGND	Safe Torque Off. Factory connection. Both circuits must be closed for the drive to start. See chapter The Safe Torque Off function in the Hardware manual of the drive.
35	IN1	
36	IN2	
37	OUT1	
<b>X10 24 V AC/DC</b>		
42	+24 V	Aux. voltage output, same supply as for terminal 10 <sup>*)</sup>
43	DGND	Aux. voltage output common <sup>*)</sup>
44	DCOM	Digital input common for all

<sup>\*)</sup> Terminals can be used as auxiliary voltage input with BAPO-01 option.

# ACH580 standard I/O interface

## Default control connections

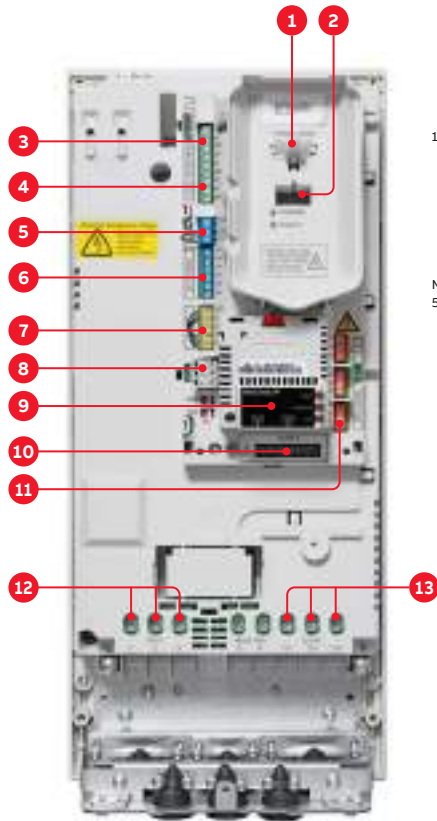

1. Panel port (PC tools, control panel)
2. ABB drive customizer port for programming the drive without mains
3. Analog inputs (2 × AI)
4. Analog outputs (2 × AO)
5. 24 V DC output
6. Digital inputs (6 × DI)
7. Safe Torque Off (STO)
8. Embedded fieldbus
9. Communication options (fieldbuses)
10. I/O extensions
11. Relay outputs (3 × RO)
12. Mains connection
13. Motor connection

Terminal	Meaning	Default connections	
<b>X1 Reference voltage and analog inputs and outputs</b>			
1	SCR	Signal cable shield (screen)	
2	AI1	Output frequency/speed reference: 0 to 10 V	
3	AGND	Analog input circuit common	
4	+10 V	Reference voltage 10 V DC	
5	AI2	Actual feedback: 0 to 20 mA	
6	AGND	Analog input circuit common	
7	AO1	Output frequency: 0 to 10 V	
8	AO2	Motor current: 0 to 20 mA	
9	AGND	Analog output circuit common	
<b>X2 &amp; X3 Aux. voltage output and programmable digital inputs</b>			
10	+24 V	Aux. voltage output +24 V DC, max. 250 mA	
11	DGND	Aux. voltage output common	
12	DCOM	Digital input common for all	
13	DI1	Stop (0)/Start (1)	
14	DI2	Not configured	
15	DI3	Constant frequency/speed selection	
16	DI4	Start interlock 1 (1 = allow start)	
17	DI5	Not configured	
18	DI6	Not configured	
<b>X6, X7, X8 Relay outputs</b>			
19	RO1C	<b>Damper control</b> 250 V AC/30 V DC 2 A	Energize damper 19 connected to 21
20	RO1A		
21	RO1B		
22	RO2C	<b>Running</b> 250 V AC/30 V DC 2 A	Running 22 connected to 24
23	RO2A		
24	RO2B		
25	RO3C	<b>Fault (-1)</b> 250 V AC/30 V DC 2 A	Fault condition 25 connected to 26
26	RO3A		
27	RO3B		
<b>X5 Embedded fieldbus</b>			
29	B+	Embedded fieldbus (EIA-485): Modbus RTU, BACnet MS/TP, N2	
30	A-		
31	DGND		
S4	TERM	Termination switch	
S5	BIAS	Bias resistors switch	
<b>X4 Safe Torque Off</b>			
34	OUT1	Safe Torque off. Factory connection. Both circuits must be closed for the drive to start. See chapter The Safe Torque Off function in the hardware manual of the drive.	
35	OUT2		
36	SGND		
37	IN1		
38	IN2		
<b>X10 24 V AC/DC</b>			
40	24 V AC/DC+ in	R6 to R11 and all ACH580-31: Ext. 24 V AC/DC input to power up the control unit when the main supply is disconnected.	
41	24 V AC/DC- in		

### Notes:

- <sup>1)</sup> Ground the outer shield of the cable 360° under the grounding clamp on the grounding shelf for the control cables.
- <sup>2)</sup> Connected with jumpers at the factory.

# ABB AC drives comply with the EU Ecodesign requirements

The Ecodesign regulation (EU) 2019/1781 is the legislative framework, that sets minimum energy efficiency requirements for low voltage induction motors and variable speed drives. AC drives and power drive systems are classified according to their power losses. From July 2021, the minimum requirement for non-regenerative AC drives in EU is IE2.

ABB’s AC drives (micro and machinery, general purpose, industrial and industry-specific drives) comply with the strictest requirements of the standard for energy efficiency and are classified as IE2.

## Energy efficiency classes for a Complete Drive Module (CDM)

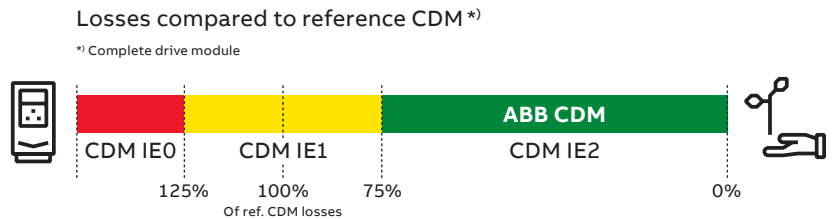

### Markings on the ABB LV AC drives

Unique identifier QR code to Ecodesign information



IE class and % loss of rated apparent power 50 Hz, 400 V

IE2 (90;100) 2,3 %

Unique QR codes are located on the rating plate and/or the front side of the drive.

### ABB EcoDesign web-based tool



- Calculates absolute and relative losses and efficiency data at standard and user-defined operating points according to EU regulation 2019/1781 for complete drive module (CDM), LV motors with VSD supply, and power drive system (PDS)
- Losses and efficiency data at operating points in graphical and table format
- Printable efficiency report with possibility to customize title and additional details
- Report can be converted to PDF or CSV format and shared via email

### The regulation was implemented in two steps:

- Step 1: July 1, 2021**
- Power range: from 0.12 to 1000 kW
  - 3-phase LV AC drives with diode rectifier
  - Drive manufacturers must declare power losses in percentage of the rated apparent output power at 8 different operating points as well as standby losses. The international IE level is given at the nominal point. Drives fulfilling the requirements will be CE marked.

### Out of scope of the regulation:

- All drives without CE marking
- Following low voltage AC drives: regenerative drives, low-harmonic drives (THD < 10%), multiple AC-output drives and single-phase drives.
- Medium voltage drives, DC drives and traction drives
- Drive cabinets with already conformity assessed modules

**Step 2: July 1, 2023**  
No changes for AC drives

# How to select a drive

This is how you build up your own ordering code using the type designation key.

**Start by identifying your supply voltage.**  
This tells you what rating table to use.  
See pages 26, 27, 28 and 29.

**Select your drive's order code** from the rating table based on your motor's nominal power rating.

**Choose your motor's power and current rating** from the ratings tables on pages 26, 27, 28 and 29.

**Ratings, types and voltages**

Drive type	Frame size	3-phase, U <sub>n</sub> 230, 230, 400, 400, 480 V			
		Nominal ratings		Light-duty use	
		P <sub>n</sub> [kW]	I <sub>n</sub> [A]	P <sub>L</sub> [kW]	I <sub>L</sub> [A]
ACH480-04-036A-2	R0	0.37	0.7	0.37	0.7
ACH480-04-036A-1	R0	0.37	0.7	0.37	0.7
ACH480-04-048A-2	R1	0.75	1.4	0.75	1.4
ACH480-04-048A-1	R1	0.75	1.4	0.75	1.4
ACH480-04-072A-2	R1	1.5	2.8	1.5	2.8
ACH480-04-072A-1	R1	1.5	2.8	1.5	2.8
ACH480-04-096A-2	R2	2.2	4.2	2.2	4.2
ACH480-04-096A-1	R2	2.2	4.2	2.2	4.2

**RATINGS, TYPES AND VOLTAGES**

Drive type	Frame size	3-phase, U <sub>n</sub> 230, 230, 400, 400, 480 V			
		Nominal ratings		Light-duty use	
		P <sub>n</sub> [kW]	I <sub>n</sub> [A]	P <sub>L</sub> [kW]	I <sub>L</sub> [A]
ACH480-04-036A-2	R0	0.37	0.7	0.37	0.7
ACH480-04-036A-1	R0	0.37	0.7	0.37	0.7
ACH480-04-048A-2	R1	0.75	1.4	0.75	1.4
ACH480-04-048A-1	R1	0.75	1.4	0.75	1.4
ACH480-04-072A-2	R1	1.5	2.8	1.5	2.8
ACH480-04-072A-1	R1	1.5	2.8	1.5	2.8
ACH480-04-096A-2	R2	2.2	4.2	2.2	4.2
ACH480-04-096A-1	R2	2.2	4.2	2.2	4.2

**Choose your options** on pages 12-13, 15-16, 18-19, 47, 57, 65-71 and add the option codes to the drive's order code. Remember to use a "+" mark before each option code.

**COMMUNICATION AND I/O OPTIONS**

Option code	HEP code	Description	Type designation
CH01	3AKD000001191	Modbus RTU (2-wire) interface	MOD-01
CH02	3AKD000001192	Modbus TCP (4-wire) interface	MOD-02
CH03	3AKD000001193	Profibus DP (4-wire) interface	MOD-03
CH04	3AKD000001194	Profibus PA (2-wire) interface	MOD-04
CH05	3AKD000001195	RS-485 (2-wire) interface	MOD-05
CH06	3AKD000001196	RS-485 (4-wire) interface	MOD-06
CH07	3AKD000001197	RS-485 (2-wire) interface with 120Ω termination	MOD-07
CH08	3AKD000001198	RS-485 (4-wire) interface with 120Ω termination	MOD-08
CH09	3AKD000001199	RS-485 (2-wire) interface with 120Ω termination and 120V isolation	MOD-09
CH10	3AKD000001200	RS-485 (4-wire) interface with 120Ω termination and 120V isolation	MOD-10

**Type designation example:**

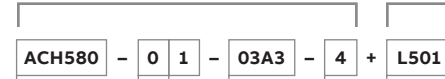

- Product series ACH480 or ACH580
- Type: 0 = standard, 1 = regen, 3 = ultra low harmonic
- Construction: 1 = wall mounted, 4 = drive module, 7 = cabinet-built
- Rating
- Voltage: 1 = 1 ph 230 V, 2 = 3 ph 230 V, 4 = 3 ph 400 V
- Options

# ACH480 technical data

<b>Mains connection</b>	
<b>Input voltage and output power range</b>	1-phase, $U_N$ 200 to 240 V, +10%/-15% from 0.37 up to 3 kW 3-phase, $U_N$ 200 to 240 V, +10%/-15% from 0.37 up to 11 kW 3-phase, $U_N$ 380 to 480 V, +10%/-15% from 0.75 up to 22 kW
<b>Frequency</b>	48 to 63 Hz
<b>Power factor</b>	0.98
<b>Efficiency class (IEC 61800-9-2)</b>	IE2
<b>Motor connection</b>	
<b>Voltage</b>	0 to $U_N$ , 3-phase
<b>Frequency</b>	0 to 500 Hz
<b>Motor control</b>	Scalar and vector
<b>Supported motor types</b>	Asynchronous, permanent magnet, synchronous reluctance, permanent magnet assisted synchronous reluctance
<b>Environmental limits</b>	
<b>Transportation and storage temperature</b>	-40 to +70 °C
<b>Operation temperature</b>	-10 to +60 °C (from +50 to +60 °C with derating)
<b>Relative humidity</b>	5 to 95% no condensation allowed
<b>Altitude</b>	Rated current available at 0 to 1000 m Reduced by 1% per 100 m over 1000 m up to 4000 m
<b>Degree of protection</b>	IP20 UL Type 1 as option
<b>Contamination level</b>	Operation at Class 3C2, Class 3S2 according to IEC 60721-3-3 Transportation at Class 2C2, Class 2S2 according to IEC 60721-3-3 Storage at Class 1C2, Class 1S2 according to IEC 60721-3-3
<b>Inputs and outputs (standard configuration)</b>	
<b>2 analog inputs</b>	Selection of Current/Voltage input mode is user programmable.
<b>Voltage signal</b>	0 (2) to 10 V, $R_{in} > 200$ k $\Omega$
<b>Current signal</b>	0 (4) to 20 mA, $R_{in} = 137$ $\Omega$
<b>Potentiometer reference value</b>	10 V $\pm$ 1% max. 10 mA
<b>2 analog outputs</b>	AO1 is user programmable for current or voltage. AO2 current
<b>Voltage signal</b>	0 to 10 V, $R_{load} > 200$ k $\Omega$
<b>Current signal</b>	0 to 20 mA, $R_{load} < 500$ $\Omega$
<b>Internal auxiliary voltage</b>	24 V DC $\pm$ 10%, max. 200 mA
<b>6 digital inputs</b>	12 to 24 V DC, 24 V AC. PNP or NPN connection (5 DIs with NPN connection).
<b>3 relay outputs</b>	Maximum switching voltage 250 V AC/30 V DC Maximum continuous current 2 A rms
<b>Supported thermistors</b>	Any of the analog inputs are configurable for PTC. Both analog outputs can be used to feed the PT100, PT1000, KTY83, KTY84 or Ni1000 sensors.
<b>External power supply</b>	1.04 A at 24 V AC/DC $\pm$ 10% as option

<b>Communication</b>	
Protocols as standard (EIA-485): BACnet MS/TP, Modbus RTU and N2. Available as 2-port plug-in options: BACnet/IP, Modbus TCP, PROFINET IO, EtherNet/IP, EtherCAT, EtherNet POWERLINK. Available as plug-in options: CANopen, DeviceNet, Profibus DP. Available as an external 2-port option: EtherNet adapter for remote monitoring.	
<b>Application functions</b>	
First start assistant Primary settings for HVACR applications Hand-Off-Auto operation mode Start interlock (de-frost) Delayed start Run permissive (damper monitoring) Override operation mode Intelligent pump control Pump dry run protection Air filter monitoring Real-time clock (scheduling) Resonance monitoring PID controllers for motor and process Motor flying start Motor preheating Energy optimizer and calculators	
<b>Protection functions</b>	
Overvoltage controller Undervoltage controller Motor and motor cable earth-leakage monitoring Motor and motor cable short-circuit protection Motor overtemperature protection Output and input switch supervision Motor overload protection Phase-loss detection (both motor and supply) Under load supervision (belt loss detection) Overload supervision Stall protection Loss of control reference	
<b>Product compliance</b>	
CE Low Voltage Directive 2014/35/EU, EN 61800-5-1:2007 Machinery Directive 2006/42/EC, EN 61800-5-2:2007 EMC Directive 2014/30/EU, EN 61800-3:2004 + A1:2012 RoHS directive 2011/65/EU Quality assurance system ISO 9001 and Environmental system ISO 14001 Waste electrical and electronic equipment directive (WEEE) 2002/96/EC Galvanic isolation according to PELV UL, EAC, RCM, cUL TÜV Nord (safety functions) UKCA Ecodesign (EU) 2019/1781	
<b>Harmonics compliance</b>	
Compliance with IEC 61000-3-12:2011 with external chokes	
<b>EMC compliance</b>	
EMC according to IEC 61800-3:2004 + A1:2012 Class C2 as standard Class C1 with external factory tested filter as option	
<b>Functional safety</b>	
STO according to EN 61800-5-2:2016, IEC 61508 Parts 1-2:2010, ISO 13849-1:2015, ISO 13849-2:2012, IEC 62061:2015 SIL 3/PL e	



# ACH580 technical data

<b>Mains connection</b>	
<b>Input voltage and output power range</b>	3-phase, $U_N$ 200 to 240 V, +10%/-15% ACH580-01: from 0.75 up to 75 kW 3-phase, $U_N$ 380 to 480 V, +10%/-15% ACH580-01: from 0.75 up to 250 kW ACH580-31: from 4 to 110 kW ACH580-34: from 132 to 355 kW 3-phase, $U_N$ 380 to 480 V, +10%/-10% ACH580-04: from 250 up to 500 kW ACH580-07: from 75 up to 500 kW
<b>Frequency</b>	48 to 63 Hz
<b>Power factor ACH580-01, ACH580-04 and ACH580-07</b>	0.98
<b>Power factor ACH580-31 and ACH580-34</b>	1.0
<b>Efficiency class (IEC 61800-9-2) ACH580-01, ACH580-04, ACH580-07</b>	IE2
<b>Motor connection</b>	
<b>Voltage</b>	0 to $U_N$ , 3-phase
<b>Frequency</b>	0 to 598 Hz
<b>Motor control</b>	Scalar and vector
<b>Supported motor types</b>	Asynchronous, permanent magnet, synchronous reluctance, permanent magnet assisted synchronous reluctance
<b>Environmental limits</b>	
<b>Transportation and storage temperature</b>	-40 to +70 °C
<b>Operation temperature</b>	ACH580-01, ACH580-31, ACH580-04 and ACH580-34: -15 to +50 °C (from +40 to +50 °C with derating) ACH580-07: 0 to +50 °C (from +40 to +50 °C with derating)
<b>Relative humidity</b>	5 to 95 % no condensation allowed
<b>Altitude</b>	Rated current available at 0 to 1000 m Reduced by 1% per 100 m over 1000 m up to 4000 m
<b>Degree of protection</b>	ACH580-01 and ACH580-31: IP21 (UL Type 1) or IP55 (UL Type 12) ACH580-04 and ACH580-34: IP00 (UL Type Open) or IP20 (UL Type 1) ACH580-07: IP21 (UL Type 1), IP42 (UL Type 1 Filtered) or IP54 (UL Type 12)
<b>Contamination level</b>	Operation: IEC 60721-3-3:2019 and ISO9223: ANSI-ISA 71.04 Chemical gases: IEC Class C3, ANSI G2 for IP21 base drive IEC Class C4, ANSI G3/GX up to 2300 Å /30d corrosivity for IP55 drive Solid particles: Class 356, no conductive dust allowed Storage: IEC 60721-3-1:2018 Chemical gases: Class 1C2 Solid particles: Class 1S3 (packaging must be Class 2S2, otherwise this is 1S2) Transportation: IEC 60721-3-2:2018 Chemical gases: Class 2C2 Solid particles: Class 2S2
<b>Inputs and outputs (standard configuration)</b>	
<b>2 analog inputs</b>	Selection of Current/Voltage input mode is user programmable.
<b>Voltage signal</b>	0 (2) to 10 V, $R_{in} > 200$ kΩ
<b>Current signal</b>	0 (4) to 20 mA, $R_{in} = 100$ Ω
<b>Potentiometer reference value</b>	10 V ±1% max. 20 mA
<b>2 analog outputs</b>	AO1 is user programmable for current or voltage. AO2 current
<b>Voltage signal</b>	0 to 10 V, $R_{load} > 100$ kΩ
<b>Current signal</b>	0 to 20 mA, $R_{load} < 500$ Ω
<b>Internal auxiliary voltage</b>	24 V DC ±10%, max. 250 mA
<b>6 digital inputs</b>	12 to 24 V DC, 24 V AC, Connectivity of PTC sensors supported by a single digital input. PNP or NPN connection (5 DI with NPN connection).

<b>3 relay outputs</b>	Maximum switching voltage 250 V AC/30 V DC Maximum continuous current 2 A rms
<b>Supported thermistors</b>	Any of the analog inputs, or digital input 6, are configurable for PTC with up to 6 sensors. Both analog outputs can be used to feed the PT100, PT1000, KTY83, KTY84 or Ni1000 sensors.
<b>External power supply</b>	
<b>Standard:</b>	ACH580-01 frames R6-R9, ACH580-04 all frames, ACH580-07 all frames, ACH580-31 all frames, ACH580-34 all frames
	1.5 A at 24 V AC/DC ±10%
<b>With option:</b>	ACH580-01 frames R1-R5
	1.04 A at 24 V AC/DC ±10%
<b>Communication</b>	
Protocols as standard (EIA-485): BACnet MS/TP, Modbus RTU and N2. Available as 2-port plug-in options: BACnet/IP, Modbus TCP, PROFINET IO, EtherNet/IP, EtherCAT, EtherNet POWERLINK. Available as plug-in options: CANopen, DeviceNet, LonWorks, Profibus DP. Available as an external 2-port option: EtherNet adapter for remote monitoring.	
<b>Application functions</b>	
First start assistant Primary settings for HVACR applications Hand-Off-Auto operation mode Start interlock (de-frost) Delayed start Run permissive (damper monitoring) Override operation mode Intelligent pump control Pump dry run protection Air filter monitoring Real-time clock (scheduling) Active braking for tunnel ventilation (ACH580-31/34) Resonance monitoring PID controllers for motor and process Motor flying start Motor preheating Energy optimizer and calculators	
<b>Protection functions</b>	
Overvoltage controller Undervoltage controller Motor and motor cable earth-leakage monitoring Motor and motor cable short-circuit protection Motor overtemperature protection Output and input switch supervision Motor overload protection Phase-loss detection (both motor and supply) Under load supervision (belt loss detection) Overload supervision Stall protection Loss of control reference	
<b>Product compliance</b>	
CE Low Voltage Directive 2014/35/EU, EN 61800-5-1:2007 Machinery Directive 2006/42/EC, EN 61800-5-2:2007 EMC Directive 2014/30/EU, EN 61800-3:2004 + A1:2012 RoHS directive 2011/65/EU Quality assurance system ISO 9001 and Environmental system ISO 14001 Waste electrical and electronic equipment directive (WEEE) 2002/96/EC Galvanic isolation according to PELV UL, EAC, RCM, cUL TÜV Nord (safety functions) UKCA Ecodesign (EU) 2019/1781 IEC 60335-2-40:2022 Safety requirements for electrical heat pumps, air-conditioners and dehumidifiers	
<b>Harmonics compliance</b>	
Built-in optimized DC choke as standard in ACH580-01/04/07 meets the requirements of IEC 61000-3-12:2011. ACH580-31/34 with active front-end helps system to comply with IEEES19 and G5/4 requirements.	
<b>EMC compliance</b>	
EMC according to IEC 61800-3:2004 + A1:2012 Class C1 with built-in filter as option for ACH580-01 up to 55 kW Class C2 as standard for ACH580-01/31 Class C3 as standard for ACH580-04/34 and ACH580-07	
<b>Functional safety</b>	
STO according to EN 61800-5-2:2016, IEC 61508 Parts 1-2:2010, ISO 13849-1:2015, ISO 13849-2:2012, IEC 62061:2015 SIL 3/PL e	

## Ratings, types and voltages

ACH480-04 drive module						
Drive type	Frame size	1-phase, $U_N = 200, 208, 220, 230, 240$ V				
		Nominal ratings		Light-duty use		
		$P_N$ (kW)	$I_N$ (A)	$P_{Ld}$ (kW)	$I_{Ld}$ (A)	
ACH480-04-02A4-1	R0	0.37	2.4	0.37	2.3	
ACH480-04-03A7-1	R0	0.55	3.7	0.55	3.5	
ACH480-04-04A8-1	R1	0.75	4.8	0.75	4.6	
ACH480-04-06A9-1	R1	1.1	6.9	1.1	6.6	
ACH480-04-07A8-1	R1	1.5	7.8	1.5	7.4	
ACH480-04-09A8-1	R2	2.2	9.8	2.2	9.3	
ACH480-04-12A2-1	R2	3	12.2	3	11.6	

ACH480-04 drive module						
Drive type	Frame size	3-phase, $U_N = 200, 208, 220, 230, 240$ V				
		Nominal ratings		Light-duty use		
		$P_N$ (kW)	$I_N$ (A)	$P_{Ld}$ (kW)	$I_{Ld}$ (A)	
ACH480-04-02A4-2	R1	0.37	2.4	0.37	2.3	
ACH480-04-03A7-2	R1	0.55	3.7	0.55	3.5	
ACH480-04-04A8-2	R1	0.75	4.8	0.75	4.6	
ACH480-04-06A9-2	R1	1.1	6.9	1.1	6.6	
ACH480-04-07A8-2	R1	1.5	7.8	1.5	7.5	
ACH480-04-09A8-2	R1	2.2	9.8	2.2	9.3	
ACH480-04-12A2-2	R2	3	12.2	3	11.6	
ACH480-04-17A5-2	R3	4	17.5	4	16.7	
ACH480-04-25A0-2	R3	5.5	25	5.5	24.2	
ACH480-04-032A-2	R4	7.5	32	7.5	30.8	
ACH480-04-048A-2	R4	11	48	11	46.2	

ACH480-04 drive module							
Drive type	Frame size	3-phase, $U_N = 380, 400, 415$ V				3-phase, $U_N = 440, 460, 480$ V	
		Nominal ratings		Light-duty use		Light-duty use	
		$P_N$ (kW)	$I_N$ (A)	$P_{Ld}$ (kW)	$I_{Ld}$ (A)	$I_{Ld}$ (A)	$P_{Ld}$ (hp)
ACH480-04-02A7-4	R1	0.75	2.6	0.75	2.5	2.1	1
ACH480-04-03A4-4	R1	1.1	3.3	1.1	3.1	3	1.5
ACH480-04-04A1-4	R1	1.5	4	1.5	3.8	3.4	2
ACH480-04-05A7-4	R1	2.2	5.6	2.2	5.3	4.8	3
ACH480-04-07A3-4	R1	3	7.2	3	6.8	6	3
ACH480-04-09A5-4	R1	4	9.4	4	8.9	7.6	5
ACH480-04-12A7-4	R2	5.5	12.6	5.5	12	11	7.5
ACH480-04-018A-4	R3	7.5	17	7.5	16.2	14	10
ACH480-04-026A-4	R3	11	25	11	23.8	21	15
ACH480-04-033A-4	R4	15	32	15	30.5	27	20
ACH480-04-039A-4	R4	18.5	38	18.5	36	34	25
ACH480-04-046A-4	R4	22	45	22	42.8	40	30
ACH480-04-050A-4	R4	22	50	22	48	42	30

ACH580-01 wall-mounted drive							
Drive type	Frame size	3-phase, $U_N = 200, 208, 220, 230, 240$ V					
		Nominal ratings			Light-duty use		
		$P_N$ (kW)	$I_N$ (A)	$P_{Ld}$ (kW)	$I_{Ld}$ (A)	$P_{Ld}$ (hp)	
ACH580-01-04A7-2	R1	0.75	4.7	0.75	4.6	1	
ACH580-01-06A7-2	R1	1.1	6.7	1.1	6.6	1.5	
ACH580-01-07A6-2	R1	1.5	7.6	1.5	7.5	2	
ACH580-01-012A-2	R1	3	12	3	11.8	3	
ACH580-01-018A-2	R1	4	16.9	4	16.7	5	
ACH580-01-025A-2	R2	5.5	24.5	5.5	24.2	7.5	
ACH580-01-032A-2	R2	7.5	31.2	7.5	30.8	10	
ACH580-01-047A-2	R3	11	46.7	11	46.2	15	
ACH580-01-060A-2	R3	15	60	15	59.4	20	
ACH580-01-076A-2	R4	18.5	76	18.5	74.8	25	
ACH580-01-091A-2	R4	22	91	22	88	30	
ACH580-01-115A-2	R5	30	115	30	114	40	
ACH580-01-144A-2	R6	37	144	37	143	50	
ACH580-01-171A-2	R7	45	171	45	169	60	
ACH580-01-213A-2	R7	55	213	55	211	75	
ACH580-01-276A-2	R8	75	276	75	273	100	

ACH580-01 wall-mounted drive							
Drive type	Frame size	3-phase, $U_N = 380, 400, 415$ V				3-phase, $U_N = 440, 460, 480$ V	
		Nominal ratings		Light-duty use		Light-duty use	
		$P_N$ (kW)	$I_N$ (A)	$P_{Ld}$ (kW)	$I_{Ld}$ (A)	$I_{Ld}$ (A)	$P_{Ld}$ (hp)
ACH580-01-02A7-4	R1	0.75	2.6	0.75	2.5	2.1	1
ACH580-01-03A4-4	R1	1.1	3.3	1.1	3.1	3	1.5
ACH580-01-04A1-4	R1	1.5	4	1.5	3.8	3.5	2
ACH580-01-05A7-4	R1	2.2	5.6	2.2	5.3	4.8	3
ACH580-01-07A3-4	R1	3	7.2	3	6.8	6	3
ACH580-01-09A5-4	R1	4	9.4	4	8.9	7.6	5
ACH580-01-12A7-4	R1	5.5	12.6	5.5	12	12	7.5
ACH580-01-018A-4	R2	7.5	17	7.5	16.2	14	10
ACH580-01-026A-4	R2	11	25	11	23.8	23	15
ACH580-01-033A-4	R3	15	32	15	30.4	27	20
ACH580-01-039A-4	R3	18.5	38	18.5	36.1	34	25
ACH580-01-046A-4	R3	22	45	22	42.8	44	30
ACH580-01-062A-4	R4	30	62	30	58	52	40
ACH580-01-073A-4	R4	37	73	37	68.4	65	50
ACH580-01-089A-4	R4	45	89	45	82.7	77	60
ACH580-01-106A-4	R5	55	106	55	100	96	75
ACH580-01-145A-4	R6	75	145	75	138	124	100
ACH580-01-169A-4	R7	90	169	90	161	156	125
ACH580-01-206A-4	R7	110	206	110	196	180	150
ACH580-01-246A-4	R8	132	246	132	234	240	200
ACH580-01-293A-4	R8	160	293	160	278	260	200
ACH580-01-363A-4	R9	200	363	200	345	361	300
ACH580-01-430A-4	R9	250	430	200	400	414	350
ACH580-01-490A-4	R9	250	490	250	480	454	400

**Nominal ratings** $I_N$  Rated current available continuously without overloadability at 40 °C. $P_N$  Typical motor power in no-overload use.**Light-duty use** $I_{Ld}$  Continuous current allowing 110%  $I_{Ld}$  for 1 minute every 10 minutes at 40 °C. $P_{Ld}$  Typical motor power in light-duty use.

The ratings for all ACH480 drives apply at +50 °C ambient temperature.

The ratings for all ACH580 drives apply at +40 °C ambient temperature.

For derating at higher altitudes, temperatures or switching frequencies, see the HW manuals, document codes: ACH480-04 3AXD50000245949, ACH580-01 3AXD50000044839, ACH580-04 3AXD50000048685, ACH580-07 3AXD50000045816, ACH580-31 3AXD50000037066 and ACH580-34 3AXD500000419708.

## Ratings, types and voltages

ACH580-04 drive module							
Drive type	Frame size	3-phase, $U_N = 380, 400, 415\text{ V}$				3-phase, $U_N = 440, 460, 480\text{ V}$	
		Nominal ratings		Light-duty use		Light-duty use	
		$P_N$ (kW)	$I_N$ (A)	$P_{Ld}$ (kW)	$I_{Ld}$ (A)	$I_{Ld}$ (A)	$P_{Ld}$ (hp)
ACH580-04-505A-4	R10	250	505	250	485	483	400
ACH580-04-585A-4	R10	315	585	315	575	573	450
ACH580-04-650A-4	R10	355	650	355	634	623	500
ACH580-04-725A-4	R11	400	725	400	715	705	600
ACH580-04-820A-4	R11	450	820	450	810	807	700
ACH580-04-880A-4	R11	500	880	500	865	807	700

ACH580-07 cabinet-built drive							
Drive type	Frame size	3-phase, $U_N = 380, 400, 415\text{ V}$				3-phase, $U_N = 440, 460, 480\text{ V}$	
		Nominal ratings		Light-duty use		Light-duty use	
		$P_N$ (kW)	$I_N$ (A)	$P_{Ld}$ (kW)	$I_{Ld}$ (A)	$I_{Ld}$ (A)	$P_{Ld}$ (hp)
ACH580-07-145A-4	R6	75	145	75	138	124	100
ACH580-07-169A-4	R7	90	169	90	161	156	125
ACH580-07-206A-4	R7	110	206	110	196	180	150
ACH580-07-246A-4	R8	132	246	132	234	240	200
ACH580-07-293A-4	R8	160	293	160	278	260	200
ACH580-07-363A-4	R9	200	363	200	345	361	300
ACH580-07-430A-4	R9	250	430	200	400	414	350
ACH580-07-505A-4	R10	250	505	250	485	483	400
ACH580-07-585A-4	R10	315	585	315	575	573	450
ACH580-07-650A-4	R10	355	650	355	634	623	500
ACH580-07-725A-4	R11	400	725	400	715	705	600
ACH580-07-820A-4	R11	450	820	450	810	807	700
ACH580-07-880A-4	R11	500	880	500	865	807	700

**ACH580-31 ultra-low harmonic wall-mounted drive**

Drive type	Frame size	3-phase, $U_N = 380, 400, 415 \text{ V}$				3-phase, $U_N = 440, 460, 480 \text{ V}$		
		Nominal ratings		Light-duty use		Light-duty use		
		$P_N$ (kW)	$I_N$ (A)	$P_{Ld}$ (kW)	$I_{Ld}$ (A)	$I_{Ld}$ (A)	$P_{Ld}$ (hp)	
ACH580-31-09A5-4	R3	4	9.4	4	8.9	7.6	5	
ACH580-31-12A7-4	R3	5.5	12.6	5.5	12	12	7.5	
ACH580-31-018A-4	R3	7.5	17	7.5	16.2	14	10	
ACH580-31-026A-4	R3	11	25	11	23.8	23	15	
ACH580-31-033A-4	R6	15	32	15	30	27	20	
ACH580-31-039A-4	R6	18.5	38	18.5	36	34	25	
ACH580-31-046A-4	R6	22	45	22	43	44	30	
ACH580-31-062A-4	R6	30	62	30	59	52	40	
ACH580-31-073A-4	R6	37	73	37	69	65	50	
ACH580-31-088A-4	R6	45	88	45	84	77	60	
ACH580-31-106A-4	R8	55	106	55	101	96	75	
ACH580-31-145A-4	R8	75	145	75	138	124	100	
ACH580-31-169A-4	R8	90	169	90	161	156	125	
ACH580-31-206A-4	R8	110	206	110	196	180	150	

**ACH580-34 ultra-low harmonic drive module**

Drive type	Frame size	3-phase, $U_N = 380, 400, 415 \text{ V}$				3-phase, $U_N = 440, 460, 480 \text{ V}$		
		Nominal ratings		Light-duty use		Light-duty use		
		$P_N$ (kW)	$I_N$ (A)	$P_{Ld}$ (kW)	$I_{Ld}$ (A)	$I_{Ld}$ (A)	$P_{Ld}$ (hp)	
ACH580-34-246A-4	R11	132	246	132	234	240	200	
ACH580-34-293A-4	R11	160	293	160	278	260	200	
ACH580-34-365A-4	R11	200	365	200	347	361	300	
ACH580-34-442A-4	R11	250	442	250	420	414	350	
ACH580-34-505A-4	R11	250	505	250	480	414	350	
ACH580-34-585A-4	R11	315	585	315	556	430	350	
ACH580-34-650A-4	R11	355	650	355	618	483	400	

**Nominal ratings**

$I_N$	Rated current available continuously without overloadability at 40 °C.
$P_N$	Typical motor power in no-overload use.

**Light-duty use**

$I_{Ld}$	Continuous current allowing 110% $I_{Ld}$ for 1 minute every 10 minutes at 40 °C.
$P_{Ld}$	Typical motor power in light-duty use.

The ratings for all ACH480 drives apply at +50 °C ambient temperature.

The ratings for all ACH580 drives apply at +40 °C ambient temperature.

For derating at higher altitudes, temperatures or switching frequencies, see the HW manuals, document codes: ACH480-04 3AXD50000245949, ACH580-01 3AXD50000044839, ACH580-04 3AXD50000048685, ACH580-07 3AXD50000045816, ACH580-31 3AXD50000037066 and ACH580-34 3AXD500000419708.

# Dimensions

## ACH480-04 drive module, IP20

Frames	Height <sup>*)</sup>		Width		Depth		Weight	
	(mm)	(in)	(mm)	(in)	(mm)	(in)	(kg)	(lb)
R1	223	8.8	73	2.9	208	8.2	1.7	3.6
R2	223	8.8	97	3.8	208	8.2	2.2	4.9
R3	220	8.7	172	6.8	208	8.2	2.5	5.5
R4	240	9.5	262	10.3	213	10.3	5.6	12.3

<sup>\*)</sup> Height of the drive with cable clamp

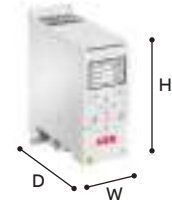

## ACH480-04 drive module, UL Type 1

Frames	Height <sup>*)</sup>		Width		Depth		Weight	
	(mm)	(in)	(mm)	(in)	(mm)	(in)	(kg)	(lb)
R1	293	11.5	73	2.9	208	8.2	2.1	4.6
R2	293	11.5	97	3.8	208	8.2	2.7	6
R3	329	13	172	6.8	208	8.2	3.2	7.1
R4	391	15.4	260	10.3	213	10.3	6.9	15.1

<sup>\*)</sup> Height of the drive with cable clamp



## ACH580-01 wall-mounted drive, IP21

Frames	Height				Width		Depth		Weight	
	H1 <sup>*)</sup>		H2 <sup>**)</sup>		(mm)	(in)	(mm)	(in)	(kg)	(lb)
	(mm)	(in)	(mm)	(in)						
R1	373	14.7	331	13	125	4.9	223	8.8	4.6	10.1
R2	473	18.6	432	17	125	4.9	229	8.9	6.6	14.6
R3	490	19.3	490	19.3	203	8	229	8.9	11.8	26
R4	636	25	636	25	203	8	257	10.2	19	41.9
R5	732	28.8	596	23.5	203	8	295	11.6	28.3	62.4
R6	727	28.6	548	21.6	252	9.9	369	14.5	42.4	93.5
R7	880	34.6	600	23.6	284	11.2	370	14.6	54	119.1
R8	965	38	680	26.8	300	11.8	393	15.5	69	152.2
R9	955	37.6	680	26.8	380	15	418	16.5	97	213.9

<sup>\*)</sup> Height of the drive with gland box

<sup>\*\*)</sup> Height of the drive without gland box



## ACH580-01 wall-mounted drive, IP55

Frames	Height <sup>*)</sup>		Width		Depth		Weight	
	(mm)	(in)	(mm)	(in)	(mm)	(in)	(kg)	(lb)
R1	403	15.9	128	5	233	9.2	4.8	10.6
R2	503	19.8	128	5	239	9.4	6.8	15
R3	490	19.3	206	8.1	237	9.3	13	28.7
R4	636	25	203	8	265	10.4	20	44.1
R5	732	28.8	203	8	320	12.6	29	64
R6	727	28.6	252	9.9	380	15	43	94.8
R7	880	34.6	284	11.2	381	15	56	123.5
R8	965	38	300	11.8	452	17.8	77	169.8
R9	955	37.6	380	15	477	18.8	103	227.1

<sup>\*)</sup> Height of the drive with gland box

H2 dimension is the same as IP21 type



## ACH580-01 wall-mounted drive, IP55 with disconnect switch or/and EMC C1

Frames	Height		Width		Depth		Weight	
	(mm)	(in)	(mm)	(in)	(mm)	(in)	(kg)	(lb)
R1	403	15.9	128	5	255	10	5.4	11.8
R2	503	19.8	128	5	257	10.1	7.5	16.4
R3	733	28.9	207	8.2	258	10.2	15	33.1
R4	879	34.6	206	8.1	286	11.3	23.3	51.5
R5	1023	40.3	203	8	342	13.5	33	64



**ACH580-01 flange mounting**

Frames	Height		Width		Offset out		Offset in		Weight	
	(mm)	(in)	(mm)	(in)	(mm)	(in)	(mm)	(in)	(kg)	(lb)
R1	461	18.2	206	8.1	133	5.2	109	4.3	4.6	10.1
R2	551	21.7	206	8.1	130	5.1	114	4.5	6.5	14.6
R3	613	24.1	290	11.4	118	4.6	116	4.6	11.8	26
R4	776	30.6	290	11.4	120	4.7	137	5.4	19	41.9
R5	776	30.6	290	11.4	124	4.9	173	6.8	28.3	62.4
R6	672	26.5	374	14.7	193	7.6	167	6.6	42.4	93.5
R7	722	28.4	406	16	194	7.6	169	6.7	54	119.1
R8	814	32.1	433	17	202	8	184	7.2	69	152.2
R9	804	31.7	502	19.8	204	8	209	8.2	97	213.9



**ACH580-04 drive module, IP00/IP20**

Frames	Height		Width		Depth		Weight	
	(mm)	(in)	(mm)	(in)	(mm)	(in)	(kg)	(lb)
R10	1462	57.6	350	13.8	529	20.8	161	355
R11	1662	65.4	350	13.8	529	20.8	199	439

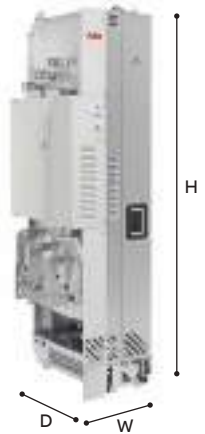

**ACH580-07 cabinet-built drive, IP21**

Frames	Height		Width		Depth		Weight	
	(mm)	(in)	(mm)	(in)	(mm)	(in)	(kg)	(lb)
R6	2145	84.4	430	16.9	673	26.5	210	463
R7	2145	84.4	430	16.9	673	26.5	220	485
R8	2145	84.4	530	20.9	673	26.5	255	562
R9	2145	84.4	530	20.9	673	26.5	275	606
R10	2145	84.4	830	32.7	698	27.5	410	904
R11	2145	84.4	830	32.7	698	27.5	440	970



**ACH580-07 cabinet-built drive, IP42**

Frames	Height		Width		Depth		Weight	
	(mm)	(in)	(mm)	(in)	(mm)	(in)	(kg)	(lb)
R6	2145	84.4	430	16.9	673	26.5	210	463
R7	2145	84.4	430	16.9	673	26.5	220	485
R8	2145	84.4	530	20.9	673	26.5	255	562
R9	2145	84.4	530	20.9	673	26.5	275	606
R10	2145	84.4	830	32.7	698	27.5	535	1179
R11	2145	84.4	830	32.7	698	27.5	581	1280

**ACH580-07 IP54 cabinet-built drive, +B055**

Frames	Height		Width		Depth		Weight	
	(mm)	(in)	(mm)	(in)	(mm)	(in)	(kg)	(lb)
R6	2145	84.4	430	16.9	673	26.5	210	463
R7	2145	84.4	430	16.9	673	26.5	220	485
R8	2145	84.4	530	20.9	673	26.5	255	562
R9	2145	84.4	530	20.9	673	26.5	275	606
R10	2315	91.14	830	32.7	698	27.5	535	1179
R11	2315	91.14	830	32.7	698	27.5	581	1280

# Dimensions

## ACH580-31 ultra-low harmonic wall-mounted drive, IP21

Frames	Height		Width		Depth		Weight	
	(mm)	(in)	(mm)	(in)	(mm)	(in)	(kg)	(lb)
R3	495	19.5	205	8.1	354	13.9	21	46
R6	771	30.4	252	9.9	392	15.5	61	134
R8	965	38	300	11.8	438	17.3	118	260



## ACH580-31 ultra-low harmonic wall-mounted drive, IP55

Frames	Height		Width		Depth		Weight	
	(mm)	(in)	(mm)	(in)	(mm)	(in)	(kg)	(lb)
R3	495	19.5	205	8.1	360	14.2	21	46
R6	771	30.4	252	9.9	448	17.6	63	139
R8	965	38	300	11.8	496	19.5	124	273



## ACH580-34 ultra-low harmonic drive module, IP00

Frames	Height		Width		Depth		Weight	
	(mm)	(in)	(mm)	(in)	(mm)	(in)	(kg)	(lb)
R11	1726	68	648	25.5	508	20	435	959

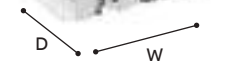





LINGSGATE MARKET

A. H. EDX Insurance Ltd



# Cooling and fuses

## Cooling

ACH480 and ACH580 drives are fitted with variable-speed cooling air fans. The cooling air must be free from corrosive materials and not exceed the maximum ambient temperature of 50 °C (60 °C with derating) for ACH480 and 40 °C for ACH580, frames R1 to R9 (50 °C with derating). The speed-controlled fans cool the drive only when needed, which reduces overall noise level and energy consumption.

## Fuse connections

Standard fuses can be used with ABB drives. For input fuses, see the table below.

ACH480-04 drive module											
Type designation	Frame size	Cooling air flow 200 to 240 V units					Recommended input protection fuses for 200 to 240 V units				
		Typical heat dissipation *)		Air flow		Max. noise level **)	IEC fuses		IEC fuses		
		(W)	(BTU/h)	(m <sup>3</sup> /h)	(ft <sup>3</sup> /min)		(A)	Fuse type	(A)	Fuse type	
<b>1-phase <math>U_N = 230 V</math></b>											
ACH480-04-02A4-1	R0	33	113	–	–	< 30	10	gG	32	gR	
ACH480-04-03A7-1	R0	49	167	–	–	< 30	10	gG	32	gR	
ACH480-04-04A8-1	R1	67	229	57	33	63	16	gG	40	gR	
ACH480-04-06A9-1	R1	93	317	57	33	63	20	gG	50	gR	
ACH480-04-07A8-1	R1	106	362	57	33	63	25	gG	63	gR	
ACH480-04-09A8-1	R2	92	314	63	37	59	32	gG	63	gR	
ACH480-04-12A2-1	R2	115	392	63	37	59	35	gG	63	gR	
<b>3-phase <math>U_N = 230 V</math></b>											
ACH480-04-02A4-2	R1	39	133	57	33	63	6	gG	25	gR	
ACH480-04-03A7-2	R1	57	194	57	33	63	10	gG	32	gR	
ACH480-04-04A8-2	R1	72	246	57	33	63	10	gG	32	gR	
ACH480-04-06A9-2	R1	111	379	57	33	63	16	gG	40	gR	
ACH480-04-07A8-2	R1	105	358	57	33	63	16	gG	40	gR	
ACH480-04-09A8-2	R1	140	478	57	33	63	16	gG	40	gR	
ACH480-04-12A2-2	R2	149	508	63	37	59	25	gG	50	gR	
ACH480-04-17A5-2	R3	265	904	128	75	66	32	gG	63	gR	
ACH480-04-25A0-2	R3	398	1358	128	75	66	50	gG	80	gR	
ACH480-04-032A-2	R4	350	1194	150	88	69	63	gG	100	gR	
ACH480-04-048A-2	R4	561	1914	150	88	69	100	gG	160	gR	

\*) Heat dissipation value is a reference for cabinet thermal design.

\*\*) The maximum noise level at full fan speed. When the drive is not operating at full load and at maximum ambient temperature the noise level is lower.

ACH480-04 drive module													
Type designation	Frame size	Cooling air flow 380 to 415 V units					Recommended input protection fuses 380 to 415 V units <sup>***)</sup>						
		Typical heat dissipation <sup>*)</sup>		Air flow		Max. noise level <sup>**)</sup>	IEC fuses		IEC fuses		UL fuses		
		(W)	(BTU/h)	(m <sup>3</sup> /h)	(ft <sup>3</sup> /min)	(dBA)	(A)	Fuse type	(A)	Fuse type	(A)	Fuse type	
ACH480-04-02A7-4	R1	44	150	57	33	63	6	gG	25	gR	6	UL class T	
ACH480-04-03A4-4	R1	55	188	57	33	63	6	gG	25	gR	6	UL class T	
ACH480-04-04A1-4	R1	62	212	57	33	63	10	gG	32	gR	10	UL class T	
ACH480-04-05A7-4	R1	91	311	57	33	63	10	gG	32	gR	10	UL class T	
ACH480-04-07A3-4	R1	100	341	57	33	63	16	gG	40	gR	20	UL class T	
ACH480-04-09A5-4	R1	140	478	57	33	63	16	gG	40	gR	20	UL class T	
ACH480-04-12A7-4	R2	165	563	63	37	59	25	gG	50	gR	25	UL class T	
ACH480-04-018A-4	R3	259	884	128	75	66	32	gG	63	gR	35	UL class T	
ACH480-04-026A-4	R3	390	1331	128	75	66	50	gG	80	gR	50	UL class T	
ACH480-04-033A-4	R4	396	1351	150	88	69	63	gG	100	gR	60	UL class T	
ACH480-04-039A-4	R4	497	1696	150	88	69	80	gG	125	gR	80	UL class T	
ACH480-04-046A-4	R4	582	1986	150	88	69	100	gG	160	gR	100	UL class T	
ACH480-04-050A-4	R4	672	2293	150	88	69	100	gG	160	gR	100	UL class T	

<sup>\*)</sup> Heat dissipation value is a reference for cabinet thermal design.

<sup>\*\*)</sup> The maximum noise level at full fan speed. When the drive is not operating at full load and at maximum ambient temperature the noise level is lower.

<sup>\*\*\*)</sup> For detailed fuse sizes and types, please see the ACH480 hardware manual, document code: 3AXD50000245949.

ACH580-01 wall-mounted drive									
Type designation	Frame size	Cooling air flow 200 to 240 V units				Recommended input protection fuses for 200 to 240 V units			
		Typical heat dissipation <sup>*)</sup>		Air flow		Max. noise level <sup>**)</sup>	IEC fuses		
		(W)	(BTU/h)	(m <sup>3</sup> /h)	(ft <sup>3</sup> /min)	(dBA)	(A)	Fuse type	
ACH580-01-04A7-2	R1	53	180	43	25	59	25	gG	
ACH580-01-06A7-2	R1	72	245	43	25	59	25	gG	
ACH580-01-07A6-2	R1	82	280	43	25	59	25	gG	
ACH580-01-012A-2	R1	143	490	43	25	59	25	gG	
ACH580-01-018A-2	R1	230	785	43	25	59	25	gG	
ACH580-01-025A-2	R2	255	870	101	59	64	40	gG	
ACH580-01-032A-2	R2	359	1240	101	59	64	40	gG	
ACH580-01-047A-2	R3	533	1820	179	105	76	63	gG	
ACH580-01-060A-2	R3	781	2660	179	105	76	63	gG	
ACH580-01-076A-2	R4	811	2760	159	94	70	100	gG	
ACH580-01-091A-2	R4	917	3140	159	94	70	125	gG	
ACH580-01-115A-2	R5	1285	4380	139	82	63	125	gG	
ACH580-01-144A-2	R6	1932	6600	435	256	67	200	gG	
ACH580-01-171A-2	R7	2000	6800	450	265	67	250	gG	
ACH580-01-213A-2	R7	2854	9700	450	265	67	315	gG	
ACH580-01-276A-2	R8	3571	12300	550	324	65	400	gG	

<sup>\*)</sup> Heat dissipation value is a reference for cabinet thermal design. According to Ecodesign regulations.

<sup>\*\*)</sup> The maximum noise level at full fan speed. When the drive is not operating at full load and at maximum ambient temperature the noise level is lower.

## Cooling and fuses

### ACH580-01 wall-mounted drive

Type designation	Frame size	Cooling air flow 380 to 480 V units				Recommended input protection fuses for 380 to 480 V units***)			
		Typical heat dissipation*)	Air flow		Max. noise level**)	IEC fuses		UL fuses	
			(W)	(m <sup>3</sup> /h)		(ft <sup>3</sup> /min)	(dBA)	(A)	Fuse type
ACH580-01-02A7-4	R1	44	43	25	59	4	gG	15	UL Class T
ACH580-01-03A4-4	R1	51	43	25	59	6	gG	15	UL Class T
ACH580-01-04A1-4	R1	60	43	25	59	6	gG	15	UL Class T
ACH580-01-05A7-4	R1	85	43	25	59	10	gG	15	UL Class T
ACH580-01-07A3-4	R1	98	43	25	59	10	gG	15	UL Class T
ACH580-01-09A5-4	R1	136	43	25	59	16	gG	15	UL Class T
ACH580-01-12A7-4	R1	213	43	25	59	16	gG	15	UL Class T
ACH580-01-018A-4	R2	240	101	59	64	25	gG	30	UL Class T
ACH580-01-026A-4	R2	383	101	59	64	32	gG	30	UL Class T
ACH580-01-033A-4	R3	492	179	105	76	40	gG	40	UL Class T
ACH580-01-039A-4	R3	523	179	105	76	50	gG	60	UL Class T
ACH580-01-046A-4	R3	672	179	105	76	63	gG	60	UL Class T
ACH580-01-062A-4	R4	776	150	88	70	80	gG	80	UL Class T
ACH580-01-073A-4	R4	858	150	88	70	100	gG	90	UL Class T
ACH580-01-089A-4	R4	1028	159	94	70	100	gG	110	UL Class T
ACH580-01-106A-4	R5	1290	139	82	63	125	gG	150	UL Class T
ACH580-01-145A-4	R6	1960	435	256	67	160	gG	200	UL Class T
ACH580-01-169A-4	R7	2021	450	265	67	250	gG	225	UL Class T
ACH580-01-206A-4	R7	2785	450	265	67	315	gG	300	UL Class T
ACH580-01-246A-4	R8	3131	550	324	65	355	gG	350	UL Class T
ACH580-01-293A-4	R8	4071	550	324	65	425	gG	400	UL Class T
ACH580-01-363A-4	R9	4834	1150	677	68	500	gG	500	UL Class T
ACH580-01-430A-4	R9	6072	1150	677	68	630	gG	600	UL Class T
ACH580-01-490A-4	R9	5831	1150	677	68	630	gG	600	UL Class T

\*) Heat dissipation value is a reference for cabinet thermal design. According to Ecodesign regulations.

\*\*) The maximum noise level at full fan speed. When the drive is not operating at full load and at maximum ambient temperature the noise level is lower.

\*\*\*) For detailed fuse sizes and types, please see the ACH580-01 HW manual, document code: 3AXD50000044839.

Note: For flange mounting, please refer to the ACH580-01 HW manual, document code: 3AXD50000044839.

### ACH580-04 drive module

Type designation	Frame size	Cooling air flow 380 to 480 V units				Recommended input protection fuses for 380 to 480 V units***)			
		Typical heat dissipation*)	Air flow		Max. noise level**)	IEC fuses		UL fuses	
			(W)	(m <sup>3</sup> /h)		(ft <sup>3</sup> /min)	(dBA)	(A)	Fuse type
ACH580-04-505A-4	R10	6492	1200	707	72	800	170M6012	600	JJS-600
ACH580-04-585A-4	R10	6840	1200	707	72	1000	170M6014	800	A4BY800
ACH580-04-650A-4	R10	8046	1200	707	72	1000	170M6014	800	A4BY800
ACH580-04-725A-4	R11	8108	1200	707	72	1250	170M6016	1000	A4BY1000
ACH580-04-820A-4	R11	9652	1200	707	72	1600	170M6269	1000	A4BY1000
ACH580-04-880A-4	R11	10887	1420	848	71	1600	170M6269	1000	A4BY1000

\*) Heat dissipation value is a reference for cabinet thermal design. According to Ecodesign regulations.

\*\*) The maximum noise level at full fan speed. When the drive is not operating at full load and at maximum ambient temperature the noise level is lower.

\*\*\*) For detailed fuse sizes and types, please see the ACH580-04 HW manual, document code: 3AXD500000448685.

**ACH580-07 cabinet-built drive**

Type designation	Frame size	Cooling air flow 380 to 480 V units					Recommended input protection fuses for 380 to 480 V units <sup>***)</sup>			
		Typical heat dissipation <sup>*)</sup>		Air flow IP21, IP42 (UL Type 1)		Max. noise level <sup>**)</sup>	IEC fuses		UL fuses	
		(W)	(BTU/Hr)	(m <sup>3</sup> /h)	(ft <sup>3</sup> /min)		(A)	Fuse type	(A)	Fuse type
ACH580-07-0145A-4	R6	2487	8485	685	403	67	250	170M3816D	250	DFJ-250
ACH580-07-0169A-4	R7	2497	8519	700	412	67	250	170M3816D	300	DFJ-300
ACH580-07-0206A-4	R7	3314	11307	700	412	67	315	170M3817D	300	DFJ-300
ACH580-07-0246A-4	R8	3806	12987	800	471	65	400	170M5408	400	170M5408
ACH580-07-0293A-4	R8	4942	16863	800	471	65	500	170M5410	500	170M5410
ACH580-07-0363A-4	R9	5868	20024	1400	824	68	630	170M6410	630	170M6410
ACH580-07-0430A-4	R9	7600	25932	1400	824	68	700	170M6411	700	170M6411
ACH580-07-0505A-4	R10	8353	28502	1900	1118	72	800	170M6412	800	170M6412
ACH580-07-0585A-4	R10	9471	32317	1900	1118	72	900	170M6413	900	170M6413
ACH580-07-0650A-4	R10	11200	38215	1900	1118	72	1000	170M6414	1000	170M6414
ACH580-07-0725A-4	R11	11386	38851	2400	1413	72	1250	170M6416	1250	170M6416
ACH580-07-0820A-4	R11	13725	46831	2400	1413	72	1250	170M6416	1250	170M6416
ACH580-07-0880A-4	R11	15300	52207	2620	1542	71	1400	170M6417	1400	170M6417

<sup>\*)</sup> Heat dissipation value is a reference for cabinet thermal design. According to Ecodesign regulations.

<sup>\*\*)</sup> The maximum noise level at full fan speed. When the drive is not operating at full load and at maximum ambient temperature the noise level is lower.

<sup>\*\*\*)</sup> For detailed fuse sizes and types, please see the ACH580-07 HW manual, document code: 3AXD50000045816.

**ACH580-31 ultra-low harmonic wall-mounted drive**

Type designation	Frame size	Cooling air flow			Recommended input protection fuses <sup>***)</sup>				
		Typical heat dissipation <sup>*)</sup>		Air flow IP21	Max. noise level <sup>**)</sup>	IEC fuses		UL fuses	
		(W)	(m <sup>3</sup> /h)	(m <sup>3</sup> /h)		(A)	Fuse type	(A)	Fuse type
ACH580-31-09A5-4	R3	265	361	361	57	10	170M1308	15	JJS-15
ACH580-31-12A7-4	R3	429	361	361	57	16	170M1309	20	JJS-20
ACH580-31-018A-4	R3	436	361	361	57	25	170M1311	25	JJS-25
ACH580-31-026A-4	R3	792	361	361	57	25	170M1311	35	JJS-35
ACH580-31-033A-4	R6	629	550	550	71	40	170M1313	40	JJS-40
ACH580-31-039A-4	R6	812	550	550	71	63	170M1315	50	JJS-50
ACH580-31-046A-4	R6	1063	550	550	71	63	170M1315	60	JJS-60
ACH580-31-062A-4	R6	1093	550	550	71	80	170M1316	80	JJS-80
ACH580-31-073A-4	R6	1419	550	550	71	100	170M1317	90	JJS-90
ACH580-31-088A-4	R6	1967	550	550	71	125	170M1318	110	JJS-110
ACH580-31-106A-4	R8	1574	860	860	68	160	170M1319	150	JJS-150
ACH580-31-145A-4	R8	2577	860	860	68	200	170M3015	200	JJS-200
ACH580-31-169A-4	R8	2963	860	860	68	250	170M3016	225	JJS-225
ACH580-31-206A-4	R8	3566	860	860	68	315	170M3017	300	JJS-300

<sup>\*)</sup> Heat dissipation value is a reference for cabinet thermal design not determining Ecodesign ratings.

<sup>\*\*)</sup> The maximum noise level at full fan speed. When the drive is not operating at full load and at maximum ambient temperature the noise level is lower.

<sup>\*\*\*)</sup> For detailed fuse sizes and types, please see the ACH580-31 HW manual, document code: 3AXD50000037066.

**ACH580-34 ultra-low harmonic drive module**

Type designation	Frame size	Cooling air flow			Recommended input protection fuses <sup>***)</sup>				
		Typical heat dissipation <sup>*)</sup>		Air flow	Max. noise level <sup>**)</sup>	IEC fuses		UL fuses	
		(W)	(m <sup>3</sup> /h)	(m <sup>3</sup> /h)		(A)	Fuse type	(A)	Fuse type
ACH580-34-246A-4	R11	5280	2100	2100	72	400	170M5408	400	170M5008
ACH580-34-293A-4	R11	6400	2100	2100	72	500	170M5410	500	170M5010
ACH580-34-365A-4	R11	8000	2100	2100	72	630	170M6410	630	170M6010
ACH580-34-442A-4	R11	10000	2100	2100	72	700	170M6411	700	170M6011
ACH580-34-505A-4	R11	10000	2100	2100	72	800	170M6412	800	170M6012
ACH580-34-585A-4	R11	12600	2100	2100	72	1000	170M6414	1000	-
ACH580-34-650A-4	R11	14200	2100	2100	72	1000	170M6414	1000	-

<sup>\*)</sup> Heat dissipation value is a reference for cabinet thermal design not determining Ecodesign ratings.

<sup>\*\*)</sup> The maximum noise level at full fan speed. When the drive is not operating at full load and at maximum ambient temperature the noise level is lower.

<sup>\*\*\*)</sup> For detailed fuse sizes and types, please see the ACH580-34 HW manual, document code: 3AXD500000419708.

# Circuit breakers

Circuit breakers are automatically-operated electrical switches for protecting electrical circuits from excess currents causing damage. The circuit breakers listed below are tested and approved for use with the ABB drives. Other circuit breakers can also be used with the drives if they provide the same electrical characteristics.

ACH480-04 drive module			
Type designation	Frame size	ABB miniature circuit breaker	
		Type	(kA) <sup>*)</sup>
<b>1-phase <math>U_N = 230\text{ V}</math></b>			
ACH480-04-02A4-1	R0	S 201P-B 10 NA	5
ACH480-04-03A7-1	R0	S 201P-B 10 NA	5
ACH480-04-04A8-1	R1	S 201P-B 16 NA	5
ACH480-04-06A9-1	R1	S 201P-B 20 NA	5
ACH480-04-07A8-1	R1	S 201P-B 25 NA	5
ACH480-04-09A8-1	R2	S 201P-B 25 NA	5
ACH480-04-12A2-1	R2	S 201P-B 32 NA	5
<b>3-phase <math>U_N = 230\text{ V}</math></b>			
ACH480-04-02A4-2	R1	S 203P-Z 6 NA	5
ACH480-04-03A7-2	R1	S 203P-Z 8 NA	5
ACH480-04-04A8-2	R1	S 203P-Z 10 NA	5
ACH480-04-06A9-2	R1	S 203P-Z 16 NA	5
ACH480-04-07A8-2	R1	S 203P-Z 16 NA	5
ACH480-04-09A8-2	R1	S 203P-Z 25 NA	5
ACH480-04-12A2-2	R2	S 203P-Z 25 NA	5
ACH480-04-17A5-2	R3	S 203P-Z 32 NA	5
ACH480-04-25A0-2	R3	S 203P-Z 50 NA	5
ACH480-04-032A-2	R4	S 203P-Z 63 NA	5
ACH480-04-048A-2	R4	Contact ABB	5
<b>3-phase, <math>U_N = 380...480\text{ V}</math> (380, 400, 415 V)</b>			
ACH480-04-02A7-4	R1	S 203P-B 6	5
ACH480-04-03A4-4	R1	S 203P-B 6	5
ACH480-04-04A1-4	R1	S 203P-B 8	5
ACH480-04-05A7-4	R1	203P-B 10	5
ACH480-04-07A3-4	R1	S 203P-B 16	5
ACH480-04-09A5-4	R1	S 203P-B 16	5
ACH480-04-12A7-4	R2	S 203P-B 25	5
ACH480-04-018A-4	R3	S 203P-B 32	5
ACH480-04-026A-4	R3	S 203P-B 50	5
ACH480-04-033A-4	R4	S 203P-B 63	5
ACH480-04-039A-4	R4	S 803S-B 80	5
ACH480-04-046A-4	R4	S 803S-B 100	5
ACH480-04-050A-4	R4	S 803S-B 100	5

<sup>\*)</sup> Maximum allowed rated conditional short-circuit current (IEC 61800-5-1) of the electrical power network.

**ACH580-01 wall-mounted drive**

Type designation	Frame size	Aux. Contr. Volt.:	Miniature circuit breaker	$T_{max}$ moulded case circuit breaker	Switch-disconnector		Main contactor ( $\leq 40$ °C)
					Main switch	Main switch UL	
			ABB type	ABB type	ABB type	ABB type	ABB type
<b>3-phase, <math>U_N = 380...480</math> V (380, 400, 415 V)</b>							
ACH580-01-02A7-4	R1	230/115	S 303P-B/C/Z 10	-	OT16F3	OT16F3	AF09-30-22-13
ACH580-01-03A4-4	R1	230/115	S 303P-B/C/Z 10	-	OT16F3	OT16F3	AF09-30-22-13
ACH580-01-04A1-4	R1	230/115	S 303P-B/C/Z 10	-	OT16F3	OT16F3	AF09-30-22-13
ACH580-01-05A7-4	R1	230/115	S 303P-B/C/Z 10	-	OT16F3	OT16F3	AF09-30-22-13
ACH580-01-07A3-4	R1	230/115	S 303P-B/C/Z 10	-	OT16F3	OT16F3	AF09-30-22-13
ACH580-01-09A5-4	R1	230/115	S 303P-B/C/Z 10	-	OT16F3	OT16F3	AF09-30-22-13
ACH580-01-12A7-4	R1	230/115	S 303P-B/C/Z 16	-	OT16F3	OT16F3	AF09-30-22-13
ACH580-01-018A-4	R2	230/115	S 303P-B/C/Z 20	-	OT25F3	OT25F3	AF09-30-22-13
ACH580-01-026A-4	R2	230/115	S 303P-B/C/Z 25	-	OT25F3	OT25F3	AF12-30-22-13
ACH580-01-033A-4	R3	230/115	S 303P-B/C/Z 32	-	OT63F3	OT63F3	AF26-30-22-13
ACH580-01-039A-4	R3	230/115	S 303P-B/C/Z 40	-	OT63F3	OT63F3	AF52-30-22-13
ACH580-01-046A-4	R3	230/115	S 303P-B/C/Z 50	-	OT63F3	OT63F3	AF52-30-22-13
ACH580-01-062A-4	R4	230/115	S 803S-B/C 80	-	OT100F	OT100F	AF52-30-22-13
ACH580-01-073A-4	R4	230/115	S 803S-B/C 80	-	OT100F	OT100F	AF52-30-22-13
ACH580-01-089A-4	R4	230/115	S 803S-B/C 100	-	OT160EV	OT200U	AF65-30-22-13
ACH580-01-106A-4	R5	230/115	S 803S-B/C 125	-	OT160EV	OT200U	AF146-30-22-13
ACH580-01-145A-4	R6	230/115	XT4 L 250 Ekip LS/I $I_n = 250$ 3p F F	Prospective SC current 65kA 1SDA068555R1	OT160EV	OT200U	AF146-30-22-13
ACH580-01-169A-4	R7	230/115	XT4 L 250 Ekip LS/I $I_n = 250$ 3p F F	Prospective SC current 65kA 1SDA068555R1	OT250E	OT400U	AF146-30-22-13
ACH580-01-206A-4	R7	230/115	T4 L 320 PR221DS-LS/I $I_n = 320$ 3p F F	Prospective SC current 65kA 1SDA0544141R1	OT250E	OT400U	AF146-30-22-13
ACH580-01-246A-4	R8	230/115	T5 L 400 PR221DS-LS/I $I_n = 400$ 3p F F	Prospective SC current 65kA 1SDA054365R1	OT400E	OT400U	AF265-30-22-13
ACH580-01-293A-4	R8	230/115	T5 L 630 PR221DS-LS/I $I_n = 630$ 3p F F	Prospective SC current 65kA 1SDA054420R1	OT400E	OT400U	AF265-30-22-13
ACH580-01-363A-4	R9	230/115	T5 L 630 PR221DS-LS/I $I_n = 630$ 3p F F	Prospective SC current 65kA 1SDA054420R1	OT630E	OT600U	AF400-30-22-70
ACH580-01-430A-4	R9	230/115	T5 L 630 PR221DS-LS/I $I_n = 630$ 3p F F	Prospective SC current 65kA 1SDA054420R1	OT630E	OT600U	AF400-30-22-70
ACH580-01-490A-4	R9	230/115	-	-	-	-	-

**ACH580-04 drive module**

Type designation	Frame size	Aux. Contr. Volt.:	Miniature circuit breaker	$T_{max}$ moulded case circuit breaker	Switch-disconnector		Main contactor ( $\leq 40$ °C)	
					Main switch	Main switch UL		
			ABB type	ABB type	ABB type	ABB type	ABB type	
<b>3-phase, <math>U_N = 380...480</math> V (380, 400, 415 V)</b>								
ACH580-04-505A-4	R10	230/115	-	(T5H 630 PR221DS-LS/I $I_n = 630$ 3p F F)	1SDA054412R1	OT630E	OT600U	-
ACH580-04-585A-4	R10	230/115	-	(T6V 800 PR221DS-LS/I $I_n = 800$ 3p F F)	1SDA069428R1	OT630E	OT600U	-
ACH580-04-650A-4	R10	230/115	-	(T6V 800 PR221DS-LS/I $I_n = 800$ 3p F F)	1SDA069428R1	OT800E	OT800U	-
ACH580-04-725A-4	R11	230/115	-	(T7H 1000 PR231/P LS/I $I_n = 1000$ A 3p F F)	1SDA062770R1	OT800E	OT800U	-
ACH580-04-820A-4	R11	230/115	-	(T7H 1000 PR231/P LS/I $I_n = 1000$ A 3p F F)	1SDA062770R1	OT1000E	OT1200U	-
ACH580-04-880A-4	R11	230/115	-	(T7H 1000 PR231/P LS/I $I_n = 1000$ A 3p F F)	1SDA062770R1	OT1000E	OT1200U	-

## Sine filters

Sine filters are low-pass filters that suppress the high frequency components of the drive output.

A sine filter consists of single- or three-phase reactors and delta- or star-connected capacitors. The sine filter provides true sinusoidal voltage waveform at the drive output by suppressing the high frequency voltage components of the drive output. Suppression of the high frequency voltage components is needed when extra-long motor cables are used, there is a step-up transformer between the drive and a motor, or when a drive is installed with an old direct-on-line motor.

### ACH580-01 wall-mounted drive

Type designation	Type code Sine filter IP00	Type code Housing case IP21 *)	$I_{cont. max}$ (A)
<b>3-phase, <math>U_N = 380...480</math> V. The power ratings are valid at nominal voltage 400 V (0.75 to 250 kW).</b>			
ACH580-01-02A7-4	B84143V0004R229	B84143Q0002R229	2.3
ACH580-01-03A4-4	B84143V0004R229	B84143Q0002R229	3.1
ACH580-01-04A1-4	B84143V0004R229	B84143Q0002R229	3.8
ACH580-01-05A7-4	B84143V0006R229	B84143Q0002R229	5.3
ACH580-01-07A3-4	B84143V0011R229	B84143Q0004R229	6.9
ACH580-01-09A5-4	B84143V0011R229	B84143Q0004R229	9.2
ACH580-01-12A7-4	B84143V0016R229	B84143Q0006R229	12.1
ACH580-01-018A-4	B84143V0025R229	B84143Q0008R229	16
ACH580-01-026A-4	B84143V0025R229	B84143Q0008R229	24
ACH580-01-033A-4	B84143V0033R229	B84143Q0008R229	31
ACH580-01-039A-4	B84143V0050R229	B84143Q0010R229	37
ACH580-01-046A-4	B84143V0050R229	B84143Q0010R229	43
ACH580-01-062A-4	B84143V0066R229	B84143Q0010R229	58
ACH580-01-073A-4	B84143V0075R229	B84143Q0010R229	64
ACH580-01-089A-4	B84143V0095R229	B84143Q0012R229	77
ACH580-01-106A-4	B84143V0130S230	B84143Q0020R229	91
ACH580-01-145A-4	B84143V0162S229	B84143Q0014R229	126
ACH580-01-169A-4	B84143V0162S229	B84143Q0014R229	153
ACH580-01-206A-4	B84143V0230S229	B84143Q0016R229	187
ACH580-01-246A-4	B84143V0230S229	B84143Q0016R229	209
ACH580-01-293A-4	B84143V0390S229	B84143Q0018R229	249
ACH580-01-363A-4	B84143V0390S229	B84143Q0018R229	297
ACH580-01-430A-4	B84143V0390S229	B84143Q0018R229	352

\*) If a sinus filter IP21 is needed please order both type codes for Housing case IP21 and Sine filter IP00.

Example: if an IP21 sine filter is needed for an ACH580-01-02A7-4 it is necessary to order both B84143V0004R229 and B84143Q0002R229.



## du/dt filters

du/dt filtering suppresses inverter output voltage spikes and rapid voltage changes that stress motor insulation. Additionally, du/dt filtering reduces capacitive leakage currents and high-frequency emissions from the motor cable as well as high-frequency losses and bearing currents in the motor. The need for du/dt filtering depends on the motor insulation. For information on the construction of the motor insulation, consult the manufacturer. More information on the du/dt filters can be found in the ACH480 and ACH580 hardware manuals.

ACH580-01 wall-mounted drive and ACH580-04 drive module										
Type designation	du/dt filter type *) 3 filters included, dimensions apply to one filter.									
	Unprotected (IP00)				Protected to IP22			Protected to IP54		
	NOCH0016-60	NOCH0030-60	NOCH0070-60	NOCH0120-60 <sup>3)</sup>	FOCH0260-70	FOCH0320-50	FOCH0610-70	FOCH0875-70	NOCH0016-62	NOCH0030-62
ACH580-01-02A7-4	x							x		x
ACH580-01-03A4-4	x							x		x
ACH580-01-04A1-4	x							x		x
ACH580-01-05A7-4	x							x		x
ACH580-01-07A3-4	x							x		x
ACH580-01-09A5-4	x							x		x
ACH580-01-12A7-4	x							x		x
ACH580-01-018A-4		x							x	x
ACH580-01-026A-4		x							x	x
ACH580-01-033A-4			x						x	x
ACH580-01-039A-4			x						x	x
ACH580-01-046A-4			x						x	x
ACH580-01-062A-4			x						x	x
ACH580-01-073A-4				x					x	x
ACH580-01-089A-4				x					x	x
ACH580-01-106A-4				x					x	x
ACH580-01-145A-4					x					
ACH580-01-169A-4					x					
ACH580-01-206A-4					x					
ACH580-01-246A-4					x					
ACH580-01-293A-4					x					
ACH580-01-363A-4						x				
ACH580-01-430A-4						x				
ACH580-04-505A-4							x			
ACH580-04-585A-4							x			
ACH580-04-650A-4							x			
ACH580-04-725A-4								x		
ACH580-04-820A-4								x		
ACH580-04-880A-4								x		

Dimensions and weights of the du/dt filters

du/dt filter	Height (mm)	Width (mm)	Depth (mm)	Weight (kg)
NOCH0016-60	195	140	115	2.4
NOCH0016-62/65	323	199	154	6
NOCH0030-60	215	165	130	4.7
NOCH0030-62/65	348	249	172	9
NOCH0070-60	261	180	150	9.5
NOCH0070-62/65	433	279	202	15.5
NOCH0120-60 <sup>3)</sup>	200	154	106	7
NOCH0120-62/65	765	308	256	45

ACH580-07 cabinet-built drive			
Type designation	du/dt filter type *) 3 filters included, dimensions apply to one filter.		
	Protected to IP54		
	BOCH-0880A-7	COF-01	COF-02
ACH580-07-0145A-4		x	
ACH580-07-0169A-4		x	
ACH580-07-0206A-4		x	
ACH580-07-0246A-4			x
ACH580-07-0293A-4			x
ACH580-07-0363A-4			x
ACH580-07-0430A-4			x
ACH580-07-0505A-4	x		
ACH580-07-0585A-4	x		
ACH580-07-0650A-4	x		
ACH580-07-0725A-4	x		
ACH580-07-0820A-4	x		
ACH580-07-0880A-4	x		

ACH480-04 drive module

Type designation	Frame size	du/dt filter type, max. ambient temp. 40 °C
ACH480-04-02A7-4	R1	ACS-CHK-B3
ACH480-04-03A4-4	R1	ACS-CHK-B3
ACH480-04-04A1-4	R1	ACS-CHK-C3
ACH480-04-05A7-4	R1	ACS-CHK-C3
ACH480-04-07A3-4	R1	NOCH0016-6x
ACH480-04-09A5-4	R1	NOCH0016-6x
ACH480-04-12A7-4	R2	NOCH0016-6x
ACH480-04-018A-4	R3	NOCH0030-6x
ACH480-04-026A-4	R3	NOCH0030-6x
ACH480-04-033A-4	R4	NOCH-0030-6x
ACH480-04-039A-4	R4	NOCH-0070-6x
ACH480-04-046A-4	R4	NOCH-0070-6x
ACH480-04-050A-4	R4	NOCH-0070-6x

Dimensions and weights of the du/dt filters

du/dt filter	Height (mm)	Width (mm)	Depth (mm)	Weight (kg)
FOCH0260-70	382	340	254	47
FOCH0320-50	662	319	293	65
FOCH0610-70	662	319	293	65
FOCH0875-70	662	319	293	65
BOCH-0880A-7	400	248	456	18
COF-01	570	296	360	23
COF-02	570	360	301	23

## Input chokes and C1 filters

ACH580 has input chokes built-in as standard. External input chokes can be used with the ACH480 drives if there is a need to optimize the line-side harmonics. To comply with European EMC Directive Category C1 (standard IEC/EN 61800-3), use optional external EMC filter. In addition, please note that Category C1 requirements can be met with conducted emissions only.

ACH480-04 drive module				
Type designation	Frame size	Input choke, max. ambient temperature 40 °C	C1 filter, max. 40 m motor cable	
<b>1-phase <math>U_N = 230\text{ V}</math></b>				
ACH480-04-02A4-1	R0	ABB CHK-A1	RFI-11	
ACH480-04-03A7-1	R0	ABB CHK-B1	RFI-12	
ACH480-04-04A8-1	R1	ABB CHK-B1	RFI-12	
ACH480-04-06A9-1	R1	ABB CHK-C1	RFI-12	
ACH480-04-07A8-1	R1	ABB CHK-C1	RFI-12	
ACH480-04-09A8-1	R2	ABB CHK-D1	–	
ACH480-04-12A2-1	R2	ABB CHK-D1	–	
<b>3-phase <math>U_N = 230\text{ V}</math></b>				
ACH480-04-02A4-2	R1	CHK-01	RFI-32	
ACH480-04-03A7-2	R1	CHK-02	RFI-32	
ACH480-04-04A8-2	R1	CHK-03	RFI-32	
ACH480-04-06A9-2	R1	CHK-03	RFI-32	
ACH480-04-07A8-2	R1	CHK-03	RFI-32	
ACH480-04-09A8-2	R1	CHK-04	RFI-32	
ACH480-04-12A2-2	R2	CHK-04	RFI-33	
ACH480-04-17A5-2	R3	CHK-04	RFI-33	
ACH480-04-25A0-2	R3	CHK-06	RFI-33	
ACH480-04-032A-2	R4	CHK-06	RFI-34	
ACH480-04-048A-2	R4	CHK-07	RFI-34	
<b>3-phase, <math>U_N = 380...480\text{ V}</math> (380, 400, 415 V)</b>				
ACH480-04-02A7-4	R1	CHK-01	RFI-32	
ACH480-04-03A4-4	R1	CHK-01	RFI-32	
ACH480-04-04A1-4	R1	CHK-02	RFI-32	
ACH480-04-05A7-4	R1	CHK-02	RFI-32	
ACH480-04-07A3-4	R1	CHK-02	RFI-32	
ACH480-04-09A5-4	R1	CHK-03	RFI-32	
ACH480-04-12A7-4	R2	CHK-03	RFI-33	
ACH480-04-018A-4	R3	CHK-04	RFI-33	
ACH480-04-026A-4	R3	CHK-04	RFI-33	
ACH480-04-033A-4	R4	CHK-05	RFI-34	
ACH480-04-039A-4	R4	CHK-06	RFI-34	
ACH480-04-046A-4	R4	CHK-06	RFI-34	
ACH480-04-050A-4	R4	CHK-07	RFI-34	

ACH580-01 wall-mounted drive			
Option code	Description		Frames
+F316	Main disconnect switch with auxiliary contact (NO) and EMC C1 filter		R1 to R5, IP55
+E223	EMC C1 filter		R1 to R5, IP55

# EMC – electromagnetic compatibility

The ABB's HVACR drives have been designed to meet the EMC requirements set in the product standard IEC/EN61800-3. The ACH480, wall-mounted ACH580-01 and ACH580-31 drives meet category C2 high frequency emission limits as standard. The single standing drive modules ACH580-04, ACH580-34 and ACH580-07 cabinet-built drives meet category C3 limits without options.

## EMC standards

The EMC product standard EN 61800-3 covers the specific EMC requirements stated for drives (tested with motor and motor cable) within the EU. EMC standards such as EN 55011 or EN 61000-6-3/4 are applicable to

industrial and domestic equipment and systems including components inside the drive. Drive units complying with the requirements of EN 61800-3 are compliant with comparable categories in EN 55011 and EN 61000-6-3/4, but not necessarily vice versa. EN 55011 and EN 61000-6-3/4 do not specify cable length or require a motor to be connected as a load. The emission limits are comparable to EMC standards according to the table below.

## Domestic environments versus public low voltage networks

1<sup>st</sup> environment includes domestic premises. It also includes establishments directly connected without an intermediate transformer to a low voltage power supply network that supplies buildings used for domestic purposes. 2<sup>nd</sup> environment includes all establishments directly connected to public low voltage power supply networks.

## Immunity and emission compatibility

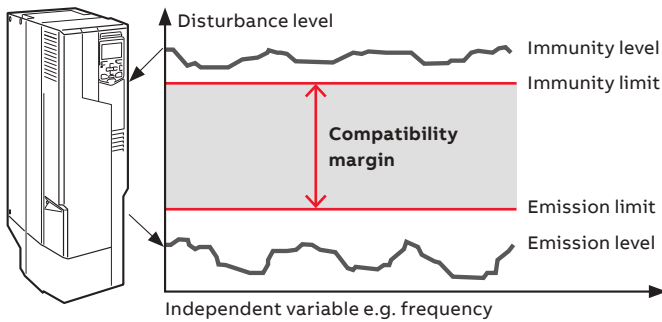

## Harmonics as part of EMC

ACH580 drives are equipped with built-in chokes which provide a sufficient level of harmonic mitigation for most operation environments and make the units compliant with EN 61000-3-12 specifying limits for harmonic currents produced by equipment connected to public low-voltage systems. The ACH580-31/34 ultra-low harmonic drive versions are available for cases where extremely low harmonic mitigation for compliance with system level standards for harmonics like IEEE519 or G5/4 is required.

## Comparison of EMC standards

EMC according to EN 61800-3 product standard before EN 61800-3:2004	EN 61800-3 product standard	EN 55011, product family standard for industrial, scientific and medical (ISM) equipment	EN 61000-6-4, generic emission standard for industrial environments	EN 61000-6-3, generic emission standard for residential, commercial and light-industrial environments
1 <sup>st</sup> environment, unrestricted distribution	Category C1	Group 1. Class B	Not applicable	Applicable
1 <sup>st</sup> environment, restricted distribution	Category C2	Group 1. Class A	Applicable	Not applicable
2 <sup>nd</sup> environment, unrestricted distribution	Category C3	Group 2. Class A	Not applicable	Not applicable
2 <sup>nd</sup> environment, restricted distribution	Category C4	Not applicable	Not applicable	Not applicable

# Overcome challenges of harmonics

Excessive content of electrical harmonics in the network leads to lower efficiency and reliability. ACH580 ultra-low harmonic drives mitigate harmonics to a minimum and perfectly suite the applications that cannot handle high harmonic content in the network.

### What are harmonics

Rotation of generators in power plants results in a sine-wave shaped current in an AC grid in the ideal case.

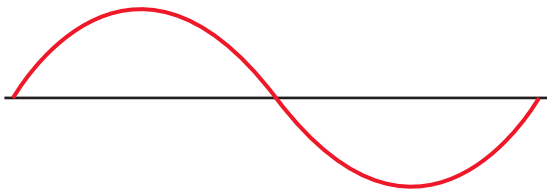

However, in reality, the network current is not pure sine wave due to harmonics - electromagnetic distortion caused by various types of electrical equipment. Current harmonics are measured as a percentage value, called total harmonic distortion (THDi).

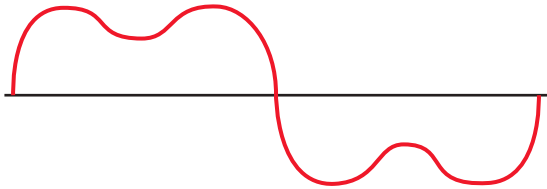

### Problems caused by harmonic distortion

High levels of harmonic distortion in an utility can create a wide range of problems. Some of the problems that may be encountered are:

- Premature failure and reduced lifespan of devices due to overheating caused by harmonics
- Nuisance trips of breakers and blowing of fuses
- Unstable operation of backup generators
- Unstable operation of sensitive electronics that require a pure sinusoidal AC waveform – interference to communication equipment
- Flickering lights

### All-in-one concept for a clean network

ABB's ACH580 ultra-low harmonic (ULH) drives for HVACR are designed with built-in harmonic mitigation technology to comply with stringent harmonics standards IEC61000-3-12, IEEE519 and G5/4. With a THDi of 3% or less, there is no need to install external components for reducing harmonics, this drive doesn't create the harmonics to fix.

	Six-pulse VFD no reactor/ choke	Six-pulse VFD Low DC bus capacitance	Six-pulse VFD + 5% reactor/choke	3-phase VFD Active front end drive *)
Typical THD <sub>i</sub>	90-120%	35-40%	35-45 %	3-5 %
VFD system price **)	\$	\$	\$\$	\$\$\$
Footprint	◻	◻	◻◻	◻◻◻
Pros	Simple and low cost solution, acceptable for installations with low quantities of small drives.	Simple and low cost solution that results in some mitigation of current harmonics (THD <sub>i</sub> ).	Standard solution in HVACR applications.	Best harmonic performance of any of the solutions.  Easy installation, only 3 wires in and 3 wires out.  Ability to boost output voltage during low-line conditions.  Unity true power factor.
Cons	High harmonic content, not recommended for installations with higher quantities of drives.  Susceptible to poor power quality.	Higher voltage distortion (THD <sub>v</sub> ), more than the six-pulse VFD with 5% reactor/choke.  More susceptible to problems caused by poor power quality.  Almost no under voltage ride-through ability.	Systems with a large quantity or large sizes of drives, may require additional harmonic mitigation.	The drive itself generates higher losses than a standard six-pulse drive with reactor.

\*) Valuations are based on ABB low harmonic drives

\*\*) System price considers VFD & installation costs

**Savings in total cost of ownership**

Installation costs are reduced with the simple three wires in and three wires out design. Maintenance costs are lowered as compared to other harmonic mitigation solutions like passive filters, multi-pulse and active filters there are less components to maintain and stock as spares. Using the ACH580 ULH allows your engineer to design your electrical system and backup generators to the right size and not oversizing for the harmonics in the network. And all-in-one concept allows to save valuable space in the building, significantly reducing installation footprint.

**Reliability for your building**

Harmonics could cause problems with other electrical equipment in the same electrical network. In the worst case it might make sensitive electrical equipment fail.

In retrofit projects, a transformer might not be able to meet the harmonic levels caused by nonlinear loads such as standard 6-pulse drives, so there is a risk of overloading the transformer.

In addition to harmonics related problems, also weak network with sags in line voltage can bring troubles to your systems resulting in motor overheating, tripping and failure.

The ACH580 ULH drive offers a reliable solution to overcome these challenges as it is able to lower the harmonic content so that sensitive equipment stay running and transformers

or generators don't fail. Also the ACH580 ULH can boost output voltage so that motor always runs with nominal voltage despite the fluctuations in line voltage.

**Complete HVACR functionality**

The ACH580 ULH comes standard with an intuitive Hand-Off-Auto control panel to configure, control, and monitor the drive. An optional Bluetooth control panel allows the drive to be configured via the control panel also remotely via the DriveTune app.

A robust software provides drive, motor, and application protection features. HVACR specific features, such as accepting four separate start interlocks, along with fan flying start or firemen's override, are also included. The drive offers BACnet MS/TP, Modbus RTU, and N2 as standard.

There are many ways to mitigate harmonics and there is no "one size fits all" solution. The table below compares the THDI of various harmonic mitigation technologies, along with other comparisons.

	Six-pulse VFD + passive filter	Matrix technology drives	Multipulse VFD	Six-pulse VFD + active filter
<b>Typical THD<sub>i</sub></b>	5-10%	5-13 %	12 pulse 10-15% 18 Pulse 5-8% due to actual system dynamics, phase unbalance and background distortion.	4-7%
<b>VFD system price **)</b>	\$\$\$	\$\$\$\$	\$\$\$\$	\$\$\$\$\$
<b>Footprint</b>	□□□□	□□□	□□□□□	□□□□
<b>Pros</b>	Assuming physical space is available, a passive harmonic filter can be added after the drive is installed, if harmonics are determined to be a problem.	Includes regenerative braking.	Traditional harmonic mitigation method.	One active filter can clean up the harmonics from multiple drives/loads.
<b>Cons</b>	Leading power factor at light loads unless the filter's capacitors are switched out of the circuit.  Risk of resonances between the filter capacitors and other capacitors in the system.  Complex wiring.	Low harmonic mode (5% THD <sub>i</sub> ) does not allow full speed control throughout the entire frequency range, as it can only modulate up to 93% voltage.  No under voltage ride-through of power circuitry due to the lack of DC bus.	Very large footprint.  Significant number of points of failure.  Optimal harmonic performance requires perfectly balanced AC power feed with little background distortion.  Complex wiring and special transformer required.  Very difficult to retrofit in the field.	Typically the most expensive solution.  The filter becomes a single point of failure for harmonic mitigation. A filter failure could result in significant/immediate harmonic related issues within the system.  Complex wiring.

## Control panel options and mounting kits

The standard delivery of the ABB HVACR drives include the HVACR control panel, which has the Hand-Off-Auto operation logic and multiple other HVACR features. A variety of different control panel accessories are available for ACH480 and ACH580 drives.



### Bluetooth control panel ACH-AP-W

The optional Bluetooth panel enables connection with the Drivetune mobile app. The app is available for free from Google Play and the Apple App store. With the Drivetune app HVACR users have all the similar functions as there is on the standard ACH-AP-H or ACH-AP-W control panels: Primary settings, I/O menu, diagnostics and full parameter list among other functions.



### Control panel mounting platform DPMP-01

This mounting platform is for flush mountings. This requires also RDUM-01 for ACH480 or CDPI-01 for ACH580 (blank control panel with the RJ-45 connector) and a control panel.



### Industrial control panel ACS-AP-I

The industrial control panel is compatible with all ABB drives, making it simple to use a single panel with different products.



### Control panel mounting platform DPMP-02 for ACH480-04, ACH580-01 and ACH580-31, DPMP-03 for ACH580-04/34

This mounting platform is for surface mountings. This requires also RDUM-01 (for ACH480) or CDPI-01 (for ACH580) (blank control panel with the RJ-45 connector) and a control panel (HVACR, Bluetooth® or industrial).



### Control panel bus adapters CDPI-01 for ACH580 CDPI-02 for ACH480

Control panel bus adapters are used to connect HVACR control panels with a RJ-45 cable to the drive from a distance, e.g. when mounting the control panel on a cabinet door. In addition, CDPI adapters can be used to daisy chain several ACH drives together to be controlled with a single control panel or PC tool.



### Door mounting kits DPMP-EXT for ACH580-01 and ACH580-31 DPMP-EXT2 for ACH480-04/34

The door mounting kit is ideal for cabinet installations. Both kits for a single drive include one DPMP-02 and either one RDUM-01 (for ACH480) or one CDPI-01 (for ACH580). Should you want to use a different control panel than the one delivered with the drive, it needs to be ordered separately.



### Control panel mounting kit for outdoor installation DPMP-04/05

Enables control panel outdoor mounting thanks to IP66 protection class, UV resistance and IK07 impact protection rating.

# Control panel door mounting and daisy chaining

Improve safety and optimize installation cost with a door mounting kit and a panel bus adapter.

Door mounting fosters easy operation and safety. It enables you to operate the drive without opening the cabinet door, saving time and keeping all the electronics isolated. And to

optimize installation costs, up to 32 drives can be connected to one control panel via panel bus adapters.

## Cabinet door

## Surface mounting platform

The platform comes with an RJ-45 cable for connecting the control panel and the panel bus adapter. There are surface mounting platform kits available for the drives, which include a surface mounting platform, a panel bus adapter and an RJ-45 cable for connecting the control panel and the panel bus adapter.

## Assistant control panel

The assistant control panel is delivered as standard with the ACH480 and ACH580 drives. Also a Bluetooth or industrial control panel can be used.

## RJ-45 cable for daisy chaining drives

## Panel bus adapter

The panel bus adapter can be ordered with an MRP code as a loose option.

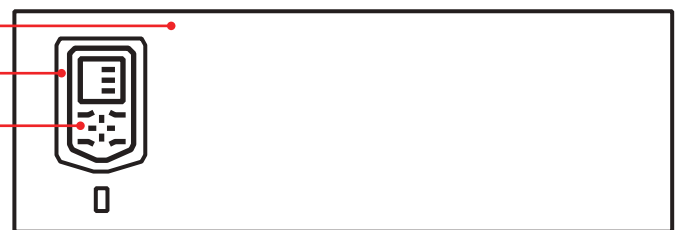

Cabinet, outside

Cabinet, inside

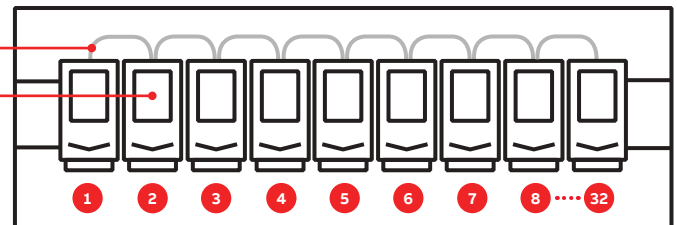

The ACH-AP-H (Hand-off-Auto) assistant control panel (plus code +J400) is included as standard in the delivery. If no code is mentioned in the ACH480 or ACH580 order,

the assistant control panel is automatically added to the delivery. It can be replaced by one of the other +Jxxx options listed in the table.

MRP code	Plus code	Description	Type designation
3AUA0000064884	+J400	Assistant control panel (Hand-Off-Auto)	ACH-AP-H
3AXD50000030358	+J429	Control panel with Bluetooth interface (Hand-Off-Auto)	ACH-AP-W
3AUA0000088311	+J425	Industrial assistant control panel	ACS-AP-I
3AXD50000009843	+J424	Blank control panel cover (no control panel delivered)	CDUM-01
3AXD50000004419	-	Panel bus adapter ACH580	CDPI-01
3AXD500000275595	-	Panel bus adapter ACH480	CDPI-02
3AUA0000108878	-	Control panel mounting platform (flush mounted, requires also panel bus adapter on the drive)	DPMP-01
3AXD50000009374	-	Control panel mounting platform (surface mounted, requires also panel bus adapter on the drive)	DPMP-02
3AXD50000016230	-	Control panel mounting platform option, only for ACH580-04/34 modules	DPMP-03
3AXD500000217717	-	Control panel mounting kit for outdoor installation	DPMP-04
3AXD500000240319	-	Control panel mounting kit for outdoor installation, only for ACH580-04/34	DPMP-05
3AXD50000010763	-	Door mounting kit for the panel (for one drive, contains both DPMP-02 and CDPI-01)	DPMP-EXT

# Easiness on a whole new level

Enjoy the simplicity with the assistant control panel's intuitive user interface, assistants and ready-made macros. The panel guides you through commissioning without a need to know any drive parameters and helps in unclear situations.



### Assistant control panel, ACH-AP-H

Set up the drive, fine-tune motor control and monitor values that matter using the assistant control panel, delivered as standard with all HVACR drives.

Hand-Off-Auto control logic allows the operator to quickly and simply override the external HVACR control when required.

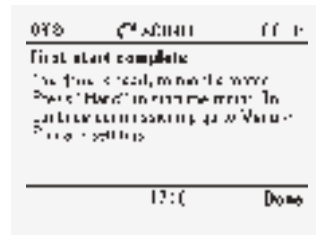
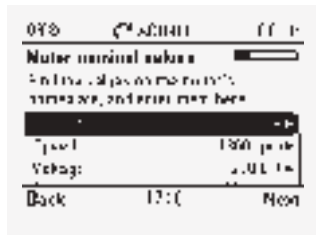
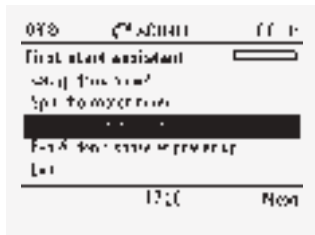

### Commission without a hassle

Select language, set time and date, name the drive, enter motor values, test rotating the motor.

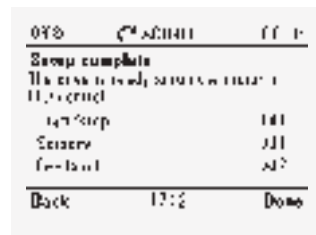
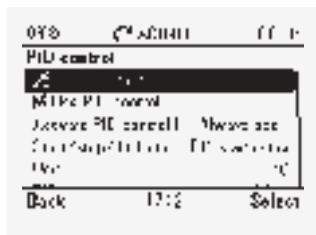
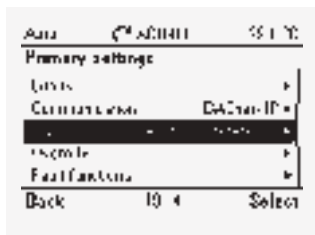

### Primary settings

Commission HVACR controllers with the intuitive PID assistant. Set the communication up. Tune the limits, commission override function, set the ramps, everything can be done with primary settings.

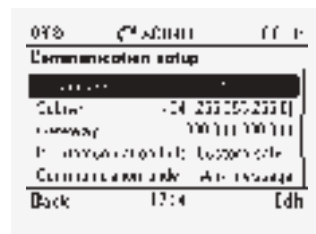
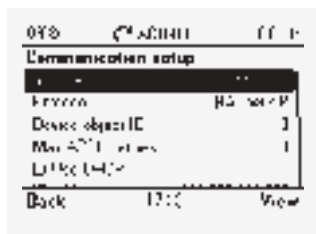
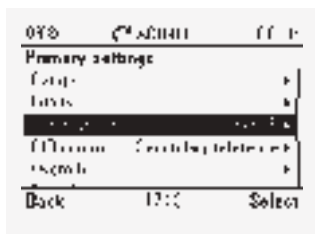

### Home view displays

Effortlessly monitor the values that are the most important to you. You can select values for monitoring from a ready-made list or choose user-defined parameters.

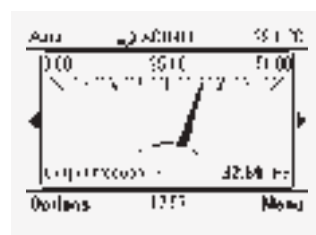
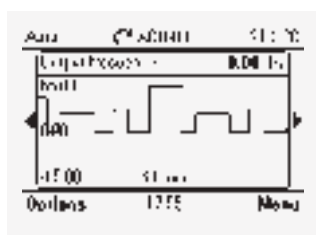
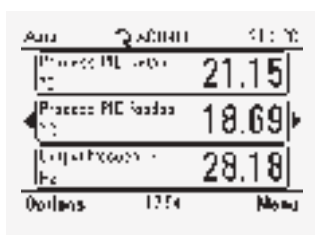

### Help button

The help button provides more information about your selection and it can be pressed in any view.





# ABB Ability™ Mobile Connect for drives

## Easy access to remote support

ABB Ability™ Mobile Connect for drives is a platform for remote drive support consisting of the Mobile Connect web portal and the Drivetune mobile app.

The platform allows ABB service partners to provide remote commissioning and troubleshooting support for personnel on-site without any complex connectivity infrastructure. Chats, sharing images and backups, viewing parameters online and sending support packages

are all possible, making your technical support process quick and efficient.

All that is needed is the Bluetooth control panel and a mobile device.

The platform is available for ABB partners and OEMs under a renewable subscription-based agreement.

[ABB Ability™ Mobile Connect for drives support portal](#)

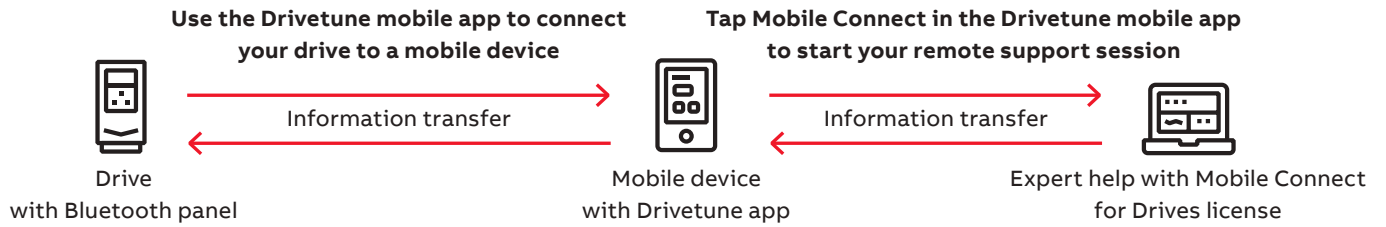

## Drivetune mobile app for managing drives via an intuitive interface

**Drivetune mobile app** is a powerful tool for performing basic drive startup and troubleshooting tasks. It is possible to connect with drives and access data available in the Internet at the same time. The wireless Bluetooth

connectivity means that users won't need to enter hazardous or difficult-to-reach work areas to access information necessary to help them commission and tune the drive.



- **Startup, commission and tune your drive and application with full parameter access**
- **Optimize performance via drive troubleshooting features**
- **Create and share backups and support packages**
- **Keep track of drives installed base**

Download Drivetune mobile app



## ABB Access

Scan the QR code to access 24/7 self-services for ABB drives, motors and PLCs

With ABB Access, you can unlock all aspects of your drives, motors or PLCs, from one central location: the palm of your hand.



### Simply scan the QR code on the ABB product to get started

ABB Access, helps you easily find up-to-date product online data. It also provides easy access to documentation and manuals. If you happen to experience issues with your ABB product, this can be fastly and easily reported online to reach expert support from ABB.

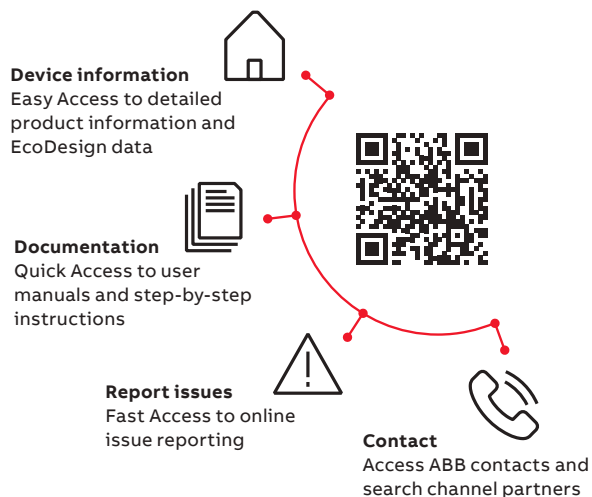

---

## ABB SmartGuide for ACH480 and ACH580 drives

Being one of the handiest ways to get short and clear visual instructions on drive installation, startup, and operation.

Mobile-friendly digital user guides provide simple and animated step-by-step instructions to assist with

wall mounting of drives, electrical installation and drive programming. The content is frequently updated and further developed, making it your comprehensive source of instructions and help.

### ACH480



Scan the QR code or click [here](#) to access the user guide.

### ACH580



Scan the QR code or click [here](#) to access the user guide.



## ABB GoSelect web-based tool

Build the optimal solution for your application quickly and easily online

ABB GoSelect is a web-based selection and dimensioning tool for motors, drives, and PLCs. Build the optimal solution for your application and efficiently create, collect, and manage documentation and reports – all in one place.

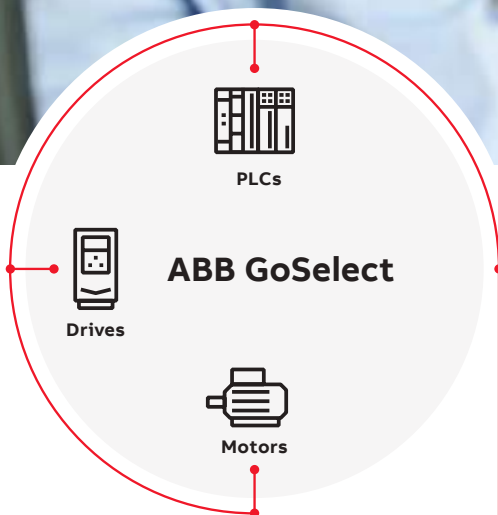

### Improved productivity

ABB GoSelect's modern, intuitive interface is easy to use. You can start by following the guided selection journey to get help finding the most suitable products. If you have already identified the right product for your application, you can proceed directly to sizing. The tool can also be used to validate the selected solution directly.



### All in one place

With ABB GoSelect you can select, dimension, and validate your solution – all-in-one convenient online portal, with or without logging in. No more searching and saving links or skipping between different tools. The tool eliminates the need to duplicate input data across multiple tools, bringing all your project documentation together in one place. No more wasted time.



### Efficient collaboration

With ABB GoSelect, the whole team can provide their input in one place in real time. You can create different alternatives in one project to make it easy to compare your options and track the project history. No more time-consuming and confusing file exchanges via email.

For more information, see:  
[goselect.motion.abb.com](https://goselect.motion.abb.com)



# ABB Ability™ Digital Powertrain service

## Condition monitoring for drives and motors



Accurate, real-time information about powertrain events. When you have the facts, you can make the right decisions.

Condition Monitoring gives you fact-based insight into your powertrain assets, such as drives and motors, via KPIs and signal data, to identify irregularities before they become problems. This helps you make proactive decisions, built on real-time information – and saves you money!

### The service can be tailored to fit your needs

Our standard package gives you industry leading monitoring capabilities – whether you want to view the drive status through ABB's Internet portal or integrate this data with your existing monitoring systems.

### The standard package includes the following services:

- Condition Monitoring
- Alarm Management
- Asset Health
- Team Support
- Backup Management

### The standard package can be supplemented with optional services:

- Condition-Based Maintenance
- Offline Data Collection
- Expert Reports
- Remote Assistance
- Condition monitoring of your entire powertrain



### Solid fact-based decision making

Get the facts, and the history, to help run your operations better and more safely.



### Always stay one step ahead of problems

Recognize early signs of possible failures and assess the risks, before they turn into serious operational issues.



### Find the root cause of process issues

Remotely access data from ABB drives built-in sensors to track the cause of problems. Get back to smooth operation quickly with data back-ups.



### Remotely analyze and optimize drives

Get critical drive information anywhere anytime – even in difficult to access sites, or when a site visit is impossible.

## NETA-21

NETA-21 connects the drive to the cloud via the Internet or local Ethernet network.

- The module comes with a built-in web server and requires no Flash/Java plugins
- In the absence of a customer local area network, it can be connected via a mobile network router (either Ethernet or USB network adapter)
- One module can be connected to several drives at the same time

NETA-21	Ordering code	Description
	3AUA0000094517	2 x panel bus interface
		max. 9 drives
		2 x Ethernet interface
		SD memory card

## Edge Industrial Gateway

The ABB Ability™ Edge Industrial Gateway uses IoT technology to simplify existing gateways. It is designed to collect all generated field device and parameter data, feeding it into one user-friendly dashboard.

This solution makes it possible to monitor all of your downstream devices via the cloud or an on-premise system, with optional wi-fi and cellular connectivity.

Edge gateway	Ordering code	Description
	1SDA115508R1	ABB Ability™ Industrial gateway
	1SDA115509R1	ABB Ability™ Industrial gateway 3G EU
	1SDA115510R1	ABB Ability™ Industrial gateway 3G US

## Customers can configure powertrains and customize the digital service plan

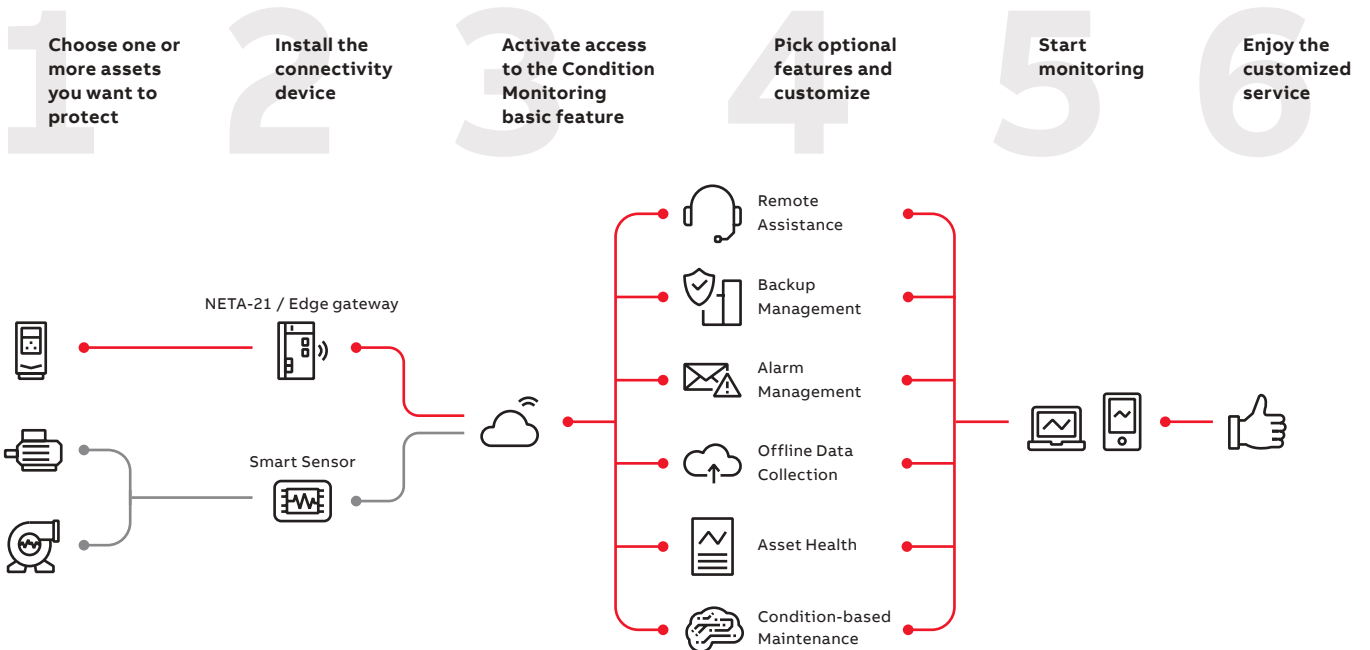

# Communication and I/O options

### Fieldbus adapter modules

The ACH480 and ACH580 drives come with Modbus RTU, BACnet MS/TP and N2 communication protocols as standard, and there is also a wide range of optional fieldbus protocols available including BACnet/IP. Fieldbus communication reduces wiring costs compared to traditional hardwired input/output connections. The fieldbus options can be installed into the slot one (1).

### Input/output extension modules

Standard inputs and outputs of ACH580 can be extended by using optional input/output extension modules installed in the slot two (2) on the drive. Standard inputs and outputs of ACH480 (RIIO-01 module) can be easily reduced by removing the module or changing it to reduced I/O module (BIO-01). The modules are easily installed in the extension slot two (2) located on the drive.



ACH580 control unit



ACH480 control unit

### ACH480 I/O options



BIO-01



RIIO-01



BAPO-01  
BREL-01

### ACH580 I/O options



CMOD-01



CMOD-02



CAIO-01



CHDI-01



CPTC-02



ACH480 I/O options			
Plus code	MRP code	Description	Type designation
-	3AXD50000033791	RIIO-01 I/O extension module coming as standard and including EIA-485 interface (BACnet MS/TP, Modbus RTU, N2), 2 analog inputs, 2 analog outputs, 4 digital inputs, 2 relay outputs, 1 auxiliary voltage output 24 V DC *)	RIIO-01
+L515	3AXD50000191635	Reduced I/O extension module including 3 digital inputs, 1 digital output and 1 analog input **)	BIO-01
+L534	3AXD50000022164	Auxiliary power extension module enables the use of an external auxiliary power supply with the drive	BAPO-01
+L511	3AXD50000022162	Relay output extension module adds 4 relay outputs to the drive	BREL-01
+OL540	-	Removes standard I/O module RIIO-01 leaving only the base unit I/O connections (2 digital inputs, 1 relay output, STO, 1 auxiliary voltage output 24 V DC)	-

\*) Standard I/O extension module RIIO-01 cannot be used together with reduced I/O extension module BIO-01 or with a fieldbus adapter.

\*\*\*) BIO-01 reduced I/O extension allows simultaneous use of fieldbus adapter.

ACH580 I/O options			
Plus code	MRP code	Description	Type designation
+L501	3AXD50000004420	External 24 V AC and DC 2 x RO and 1 x DO	CMOD-01
+L523	3AXD50000004418	External 24 V and isolated PTC interface	CMOD-02
+L512	3AXD50000004431	115/230 V digital input 6 x DI and 2 x RO	CHDI-01
+L537	3AXD50000033578	ATEX-certified PTC interface, Ex II (2) GD and external 24 V	CPTC-02
+L525	3AXD50000709243	Analogue signal extension 3 x AI and 2 x AO	CAIO-01

Note: For more information see ACH580-01 HW manual 3AXD50000044839.

#### Fieldbus options

Plus code	MRP code	Fieldbus protocol	Adapter
+K465	3AXD50000023864	BACnet/IP (2-port)	FBIP-21
+K452	3AUA0000037539	LonWorks	FLON-01
+K458	3AUA0000031336	Modbus RTU	FSCA-01
+K451	68469341	DeviceNet™	FDNA-01
+K454	68469325	PROFIBUS DP, DPV0/DPV1	FPBA-01
+K457	68469376	CANopen®	FCAN-01
+K462	3AUA0000094512	ControlNet	FCNA-01
+K469	3AUA0000072069	EtherCAT®	FECA-01
+K470	3AUA0000072120	POWERLINK	FEPL-02
+K491	3AXD50000049964	Two port Modbus/TCP	FMBT-21
+K492	3AXD50000192779	Two port PROFINET IO	FPNO-21



Note: For more information see adapter module HW manuals: FBIP-21 3AXD50000028468, FMBT-21 3AXD50000158607, FLON-01 3AUA0000041017, FSCA-01 3AUA0000109533, FDNA-01 3AFE68573360, FPBA-01 3AFE68573271, FCAN-01 3AFE68615500, FCNA-01 3AUA0000141650, FECA-01 3AUA0000068940, FEPL-02 3AUA0000123527, FEIP-21 3AXD50000158621, FMBT-21 3AXD50000158607, FPNO-21 3AXD50000158614.

# Thermistor protection I/O option for increased safety

## What is a potentially explosive atmosphere and where can it be?

Explosive atmospheres occur when flammable gases, mist, vapors or dust are mixed with air, which creates a risk of explosion. A potentially explosive area is defined as a location where there is a risk of flammable mixes. These atmospheres can be found throughout industries, from chemical, pharmaceutical and food, to power and wood processing. The electrical equipment that is installed in such locations must be designed and tested to endure these conditions and guarantee a safe function.

## What does ATEX mean?

The term ATEX comes from the French words "ATmosphères EXplosibles", and it is a combination of two EU directives: the Worker Protection Directive 1999/92/EC and the Product Directive 2014/34/ EU. The ATEX Directives are designed to protect employees, the public and the environment from accidents owing to explosive atmospheres.

ATEX provides similar guidelines to the IECEx System (a certification that verifies compliance with IEC standards related to safety in explosive atmospheres), with a few exceptions, and with certification of protective devices (e.g. drive-integrated safety functions).

## How to ensure safe operation with ABB's ATEX-certified offering and services?

Motors are directly connected to the machines in the potentially explosive atmosphere, and certain aspects need to be considered when selecting a motor together with a drive.

Thus, the installation should be compatible with a certain potentially explosive atmosphere zone, e.g. potentially explosive atmospheres can occur accidentally/ occasionally/continuously, flammable medium can be gas, dust and so on (see ATEX classification for explosive proof equipment for details).

ABB's motor and drive combinations are tested and certified for compliance with ATEX. By using an ABB motor for explosive atmospheres together with an ABB drive and an ATEX drive option, enjoy the benefits of efficient, high-performance motors with optimal control accuracy – without compromising on safety in explosive atmospheres with characteristics EX 2 (II) GD.

ABB's CPTC-02 ATEX-certified thermistor protection module for drives and safe disconnection function offer a motor thermistor connection for supervising the motor temperature and one relay output, which indicate motor overtemperature and stop it to avoid an explosion.

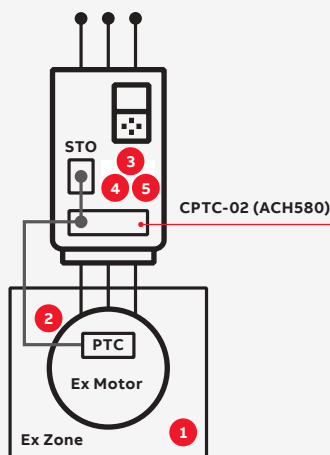

1. Motor temperature rises above the PTC sensor limit temperature
2. The sensor resistance increases very sharply and indicates overheating to the ATEX-certified module
3. The module switches the STO (Safe Torque Off) circuit off, which activates the STO function
4. The STO function disables the control voltage in the power semiconductors of the drive output stage
5. The drive is prevented from generating torque to rotate the motor – the safe state is guaranteed

CPTC-02 ATEX certified thermistor protection module, EX II (2) GD



Option code	Description	Type designation
+L537 +Q971	ATEX certified PTC interface, EX II (2) GD and Safe Disconnection Function	CPTC-02

# Tools for configuration, monitoring and process tuning

ACH480 and ACH580 have various tools to simplify the commissioning, operation and monitoring of the drives.



### Easy configuration for unpowered drives

With the CCA-01 tool, it is possible to configure drive parameters and even download new software from PC to the unpowered drives. The power is supplied by a PC USB port.



### Connection with cable

Using the BCBL-01 cable, the PC can be connected directly to the RJ-45 panel port on the drive.



### Drive Composer

The Drive Composer PC tool offers fast and harmonized setup, commissioning and monitoring. Drive Composer entry (a free version of the tool) provides startup and maintenance capabilities and gathers all drive information, such as parameter loggers, faults, and backups into a support diagnostics file.

Drive Composer pro provides additional features such as custom parameter windows, graphical control diagrams of the drive's configuration, and improved monitoring and diagnostics.



### Connection to assistant panel

When using the Assistant control panel, the Drive composer tool is connected to the drive using the mini USB connection on the panel.

### Adaptive programming

Adaptive programming enhances the existing drive application control program to precisely fit users' application needs. Adaptive programming software embedded inside the drive allows to distribute some of the machine's control logic to the drive. You can use Drive composer PC tool to set up the adaptive programming. The drives also offer sequence programming capabilities.

Ordering code	Description	Type designation
3AXD50000032449	PC cable, USB to RJ45	BCBL-01
3AXD50000019865	Cold configurator adapter, packed kit	CCA-01
3AUA0000108087	Drive Composer pro PC tool (single user license)	DCPT-01
3AUA0000145150	Drive Composer pro PC tool (10 users license)	DCPT-01
3AUA0000145151	Drive Composer pro PC tool (20 users license)	DCPT-01

Free Drive Composer entry available at <https://new.abb.com/drives/software-tools/drive-composer>

## Choose the motor for your HVACR application

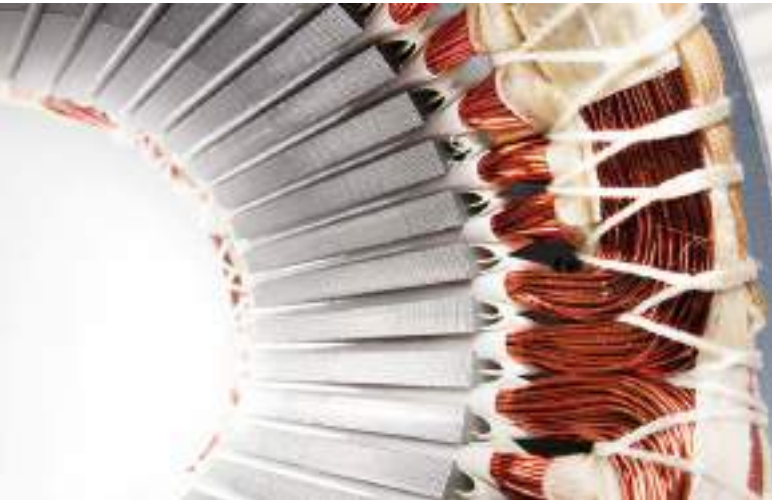

Choose the best motor for your application. A natural match for induction motors, ABB HVACR drives can also control high-efficiency motors such as permanent magnet or synchronous reluctance motors for greater efficiency.

### **Induction motors, the industry workhorse**

Pair the ACH480 or ACH580 with an induction motor (IM) for simple and reliable operation in many HVACR applications and in a wide range of environments. Further simplifying setup, the HVACR drives can be integrated with virtually any type of IM by entering the nameplate motor data only.



### **Permanent magnet motors for smooth operation**

Permanent magnet technology is used for improved motor characteristics in terms of energy efficiency and compactness. This technology is particularly well-suited for low speed control applications, as they eliminate the need to use gear boxes. Even without speed or rotor position sensors, the ACH480 or ACH580 drives control most types of permanent magnet motors.



### **IE5 SynRM for optimized energy efficiency**

Combining ABB's HVACR drive control technology with our synchronous reluctance motors will give you a motor and a drive package that ensures high energy efficiency, reduces motor temperatures, and provides a significant reduction in motor noise. The key is in the efficiency-optimized rotor design of our SynRM motors.

# Synchronous reluctance motors

Ultimate efficiency and reliability to optimize your cost of ownership



Traditional induction motor



IE5 SynRM motor

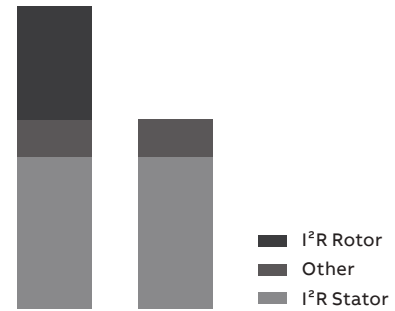

Losses IM vs SynRM

### Innovation inside

The idea is simple. Take a conventional, proven stator technology and an innovative rotor design. Then combine them with an ABB general purpose drive loaded with software with versatile features. Finally, optimize the whole package for applications such as compressors, conveyors, mixers, pumps, centrifuges, fans and many other variable and constant torque applications.

### Magnet-free design

Synchronous reluctance technology combines the performance of a permanent magnet motor with the simplicity and service-friendliness of an induction motor. The new rotor has neither magnets nor windings, and suffers virtually no power losses. And because there are no magnetic forces in the rotor, maintenance is as straightforward as with induction motors.

### Superior reliability to minimize the cost of not running

International Efficiency class IE5 synchronous reluctance motors (SynRM) have very low winding temperatures, which increases the reliability and lifetime of the winding. More importantly, a cool synchronous reluctance rotor means significantly lower bearing temperatures – an important factor because bearing failures cause about 70 percent of unplanned motor outages.

### Perfect for retrofits

The SynRM package is a perfect solution for motor retrofits. The IE5 SynRM is the same size as an IE3 induction motor, eliminating the need for mechanical modifications. The increased efficiency will, on the other hand, reduce the payback time of the investment.

### Full motor control, down to zero speed

Many processes require accurate speed control. SynRM always runs at reference speed with practically no error, without an encoder. Even the best slip compensation systems in an induction motor inverter will never match the precision of SynRM. Sometimes your application may require you to run your motor at slow speeds. If you are using SynRM and your drive cannot provide the necessary torque, it may trip. ABB drives provide full control and torque down to zero speed, even without speed sensors.

### For all applications

This is important if you are planning on using the motor with applications other than quadratic torque applications like pumps and fans. Our drives provide full SynRM motor control for constant torque applications such as extruders, conveyors and wire drawing machines.

SynRM technology	Benefit
Higher efficiency IE5	Lowest energy consumption
No rare earth metals	Environmental sustainability
Magnet-free rotor	Easy service
Lower winding and bearing temperatures	Longer life time, extended service intervals
Better controllability	Accurate speed and torque control
Lower noise level	Better working and living environment
Same size with IE3	Perfect for retrofits



# Selection guide

## IE5 synchronous reluctance motors

This table presents performance data for IE5 SynRM motor and ACH580 drive package. Variant codes and construction details are based on the M3BP motor, protection IP55, cooling IC 411, insulation class F, temperature rise class B.

Output (kW)	Motor type <sup>*)</sup>	Product code	Motor efficiency (%)	Motor nominal current (A)	Motor nominal torque (Nm)	Motor weight (kg)	Matched ACH580-01 drive	Package efficiency <sup>**)</sup> IES at nominal point (Pn) (%)	PDS <sup>***)</sup> IES2 efficiency class low limit (%)	Package efficiency above IES2 efficiency class low limit (%)	Drive frame size
<b>3000 RPM / 100 Hz</b>						<b>400 V network</b>					
5.5	M3AL132SMA4	3GAL132217--SC	92.8	12.1	17.5	41	ACH580-01-12A7-4	89.6	82.5	8.6	R1
7.5	M3AL132SMB4	3GAL132227--SC	93.1	16.5	23.9	41	ACH580-01-018A-4	90.4	83.9	7.7	R2
11	M3AL132SMC4	3GAL132237--SC	94	24.5	35	47	ACH580-01-026A-4	90.9	85.3	6.6	R2
11	M3BL160MLA4	3GBL162417--SC	93.6	25.6	35	133	ACH580-01-033A-4	90.4	85.3	6	R3
15	M3AL132SMD4	3GAL132247--SC	94.1	32.9	47.8	47	ACH580-01-039A-4	91.2	86.2	5.8	R3
15	M3BL160MLB4	3GBL162427--SC	95.1	34.6	48	133	ACH580-01-039A-4	92.2	86.2	7	R3
18.5	M3BL160MLC4	3GBL162437--SC	94.6	43.3	59	133	ACH580-01-046A-4	91.3	86.9	5.1	R3
22	M3BL180MLB4	3GBL182427--SC	95.5	50.5	70	190	ACH580-01-062A-4	92.5	87.3	6	R4
30	M3BL200MLC4	3GBL202437--SC	95.9	68.9	95.6	277	ACH580-01-073A-4	92.5	88.1	5	R4
37	M3BL200MLD4	3GBL202447--SC	96.1	84.5	118	277	ACH580-01-089A-4	93.5	88.6	5.5	R4
45	M3BL225SMB4	3GBL222227--SC	96.1	99.8	143	330	ACH580-01-106A-4	93.5	89	5.1	R5
55	M3BL250SMA4	3GBL252217--SC	96.4	123	175	396	ACH580-01-145A-4	93.6	89.4	4.7	R6
75	M3BL250SMB4	3GBL252227--SC	96.5	167	239	396	ACH580-01-169A-4	93.8	90	4.2	R7
90	M3BL250SMC4	3GBL252237--SC	96.4	198	286	454	ACH580-01-206A-4	93.4	90.2	3.5	R7
<b>1500 RPM / 50 Hz</b>											
5.5	M3AL132SMA4	3GAL132213--SC	93.7	11.7	35	63	ACH580-01-12A7-4	90.4	82.5	9.6	R1
7.5	M3AL132SMB4	3GAL132223--SC	93.7	15.7	47.8	63	ACH580-01-018A-4	91	83.9	8.5	R2
11	M3AL132SMC4	3GAL132233--SC	94.2	23.8	70	69	ACH580-01-026A-4	90.9	85.3	6.6	R2
11	M3BL160MLA4	3GBL162413--SC	94	24.2	70	160	ACH580-01-026A-4	90.8	85.3	6.4	R2
15	M3BL160MLB4	3GBL162423--SC	94.9	31.3	95	177	ACH580-01-039A-4	91.9	86.2	6.6	R3
18.5	M3BL180MLB4	3GBL182423--SC	95	42.8	118	222	ACH580-01-046A-4	91.4	86.9	5.2	R3
22	M3BL180MLC4	3GBL182433--SC	95.4	49.4	140	222	ACH580-01-062A-4	92.1	87.3	5.5	R4
30	M3BL200MLB4	3GBL202423--SC	95.9	65	191	304	ACH580-01-073A-4	92.5	88.1	5	R4
37	M3BL225SMB4	3GBL222223--SC	96.3	79.3	236	385	ACH580-01-089A-4	93.8	88.6	5.9	R4
45	M3BL225SMC4	3GBL222233--SC	96.3	98.5	286	350	ACH580-01-106A-4	93.5	89	5.1	R5
55	M3BL250SMB4	3GBL252223--SC	96.5	117	350	454	ACH580-01-145A-4	93.5	89.4	4.6	R6
75	M3BL280SMA4	3GBL282213--DC	96.2	166	478	639	ACH580-01-169A-4	93.6	90	4	R7
90	M3BL280SMB4	3GBL282223--DC	96.5	199	573	639	ACH580-01-206A-4	93.5	90.2	3.7	R7
110	M3BL280SMC4	3GBL282233--DC	96.7	241	699	697	ACH580-01-246A-4	93.9	90.5	3.8	R8
110	M3BL315SMA4	3GBL312213--DC	96.8	243	702	873	ACH580-01-246A-4	94.1	90.5	4	R8
132	M3BL315SMB4	3GBL312223--DC	96.8	290	842	925	ACH580-01-293A-4	93.8	90.7	3.4	R8
160	M3BL315SMC4	3GBL312233--DC	97.1	343	1018	965	ACH580-01-363A-4	94.2	90.9	3.6	R9
200	M3BL315MLA4	3GBL312413--DC	97.2	428	1272	1116	ACH580-01-430A-4	94.1	91.1	3.3	R9
250	M3BL315LKA4	3GBL312813--DC	97.1	552	1591	1357	ACH580-04-585A-4	94.6	91.2	3.7	R10
315	M3BL315LKC4	3GBL312833--DC	97.2	662	2006	1533	ACH580-04-725A-4	94.9	91.2	4.1	R11

<sup>\*)</sup> Motor type M3AL = aluminum motor frame  
Motor type M3BL = cast iron motor frame

<sup>\*\*)</sup> Calculated package efficiency values for ACH580-01  
<sup>\*\*\*)</sup> PDS = Power Drive System

Output (kW)	Motor type <sup>*)</sup>	Product code	Motor efficiency (%)	Motor nominal current (A)	Motor nominal torque (Nm)	Motor weight (kg)	Matched ACH580-01 drive	Package efficiency <sup>**)</sup> IES at nominal point (Pn) (%)	PDS <sup>***)</sup> IES2 efficiency class low limit (%)	Package efficiency above IES2 efficiency class low limit (%)	Drive frame size
<b>1000 RPM / 33.3 Hz</b>						<b>400 V network</b>					
7.5	M3BL160MLA4	3GBL162412--SC	93.1	16.5	72	160	ACH580-01-018A-4	90.2	83.9	7.5	R2
11	M3BL160MLB4	3GBL162422--SC	93.7	24.1	105	177	ACH580-01-026A-4	90.4	85.3	6	R2
15	M3BL180MLC4	3GBL182432--SC	94.2	34.1	143	216	ACH580-01-039A-4	90.9	86.2	5.5	R3
18.5	M3BL200MLA4	3GBL202412--SC	95.2	39.9	177	304	ACH580-01-046A-4	91.9	86.9	5.8	R3
22	M3BL200MLB4	3GBL202422--SC	95	47	210	304	ACH580-01-062A-4	91.9	87.3	5.3	R4
30	M3BL225SMB4	3GBL222222--SC	95.5	64.7	287	348	ACH580-01-073A-4	92.1	88.1	4.5	R4
37	M3BL250SMA4	3GBL252212--SC	95.6	80.5	353	428	ACH580-01-089A-4	93.3	88.6	5.3	R4
45	M3BL280SMA4	3GBL282212--DC	96.2	98.6	430	639	ACH580-01-106A-4	93.5	89	5.1	R5
55	M3BL280SMB4	3GBL282222--DC	96	119	526	639	ACH580-01-145A-4	93	89.4	4	R6
75	M3BL280SMC4	3GBL282232--DC	96.2	160	715	697	ACH580-01-169A-4	93.6	90	4	R7
75	M3BL315SMA4	3GBL312212--DC	96.5	164	717	873	ACH580-01-169A-4	93.8	90	4.2	R7
90	M3BL315SMB4	3GBL312222--DC	96.8	199	859	925	ACH580-01-206A-4	93.7	90.2	3.9	R7
110	M3BL315SMC4	3GBL312232--DC	96.8	241	1051	965	ACH580-01-246A-4	93.9	90.5	3.8	R8
132	M3BL315MLA4	3GBL312412--DC	97.1	278	1261	1116	ACH580-01-293A-4	94	90.7	3.6	R8
160	M3BL315LKA4	3GBL312812--DC	97.1	341	1527	1357	ACH580-01-363A-4	94.2	90.9	3.6	R9
200	M3BL315LKC4	3GBL312832--DC	97.3	416	1910	1533	ACH580-01-430A-4	94.3	91.1	3.5	R9

<sup>\*)</sup> Motor type M3AL = aluminum motor frame  
Motor type M3BL = cast iron motor frame

<sup>\*\*)</sup> Calculated package efficiency values for ACH580-01

<sup>\*\*\*)</sup> PDS = Power Drive System

## ABB automation products



### AC500

ABB's powerful flagship PLC offering, ideal for such applications as district energy, provides wide range of performance levels and scalability within a single simple concept where most competitors require multiple product ranges to deliver similar functionality.



### AC500-S

A PLC based modular automation solution that makes it easier than before to mix and match standard and safety I/O modules to expertly meet your safety requirements in all functional safety applications. "Extreme conditions" version is also offered.



### AC500-eCo

Meets the cost-effective demands of the small PLC market while offering total inter-operability with the core AC500 range. Web server, FTP server and Modbus-TCP for all Ethernet versions. A Pulse Train Out-put module is available for multi-axis positioning.



### AC500-XC

"Extreme conditions" modules with extended operating temperature, immunity to vibration and hazardous gases. for use at high altitudes, in humid conditions. etc. It replaces expensive cabinets with its built-in protection against dirt, water, gases and dust.



### BMS controllers

BTL-certified BACnet/IP and MS/TP controllers for building's systems support simultaneous routing of communication protocols to IP layer without the use of external gateways. Easily extend I/Os using the field level extension modules to meet the most complex HVACR strategies. Enjoy flexible programming with pre-engineered application libraries.

### Automation builder

Integrates the engineering and maintenance for PLC, drives, motion. HMI and robotics. It complies with the IEC 61131-3 standard offering all five IEC programming languages for PLC and drive configuration.

Automation Builder supports a number of languages and comes with new libraries. FTP functions, SMTP, SNMP, smart diagnostics and debugging capabilities.



### Control panels

Our control panels offer a wide range of touchscreen graphical displays from 3.5" up to 15". They are provided with user-friendly configuration software that enables tailor made customized HMI solutions. Rich sets of graphical symbols and the relevant drivers for ABB automation products are provided. Control panels for visualization of AC500 web server applications are available.



### Softstarters

ABB's softstarters increase a motor's lifetime by protecting it from electrical stresses. With everything that you need in one unit, from bypass contactor to overload protection, a single Softstarter makes for a compact and complete starting solution.



### All-compatible drives portfolio

The all-compatible drives share the same architecture: software platform, tools, user interfaces and options.

There is an optimal drive from the smallest fan to the biggest heat pump compressor, and everything in between.





# Summary of drive ordering codes

## ACH480-04

The type designation tells you the specifications and configuration of the drive.

The table shows the primary drive variants.

Sample type code: ACH480-04-12A7-4+XXXX

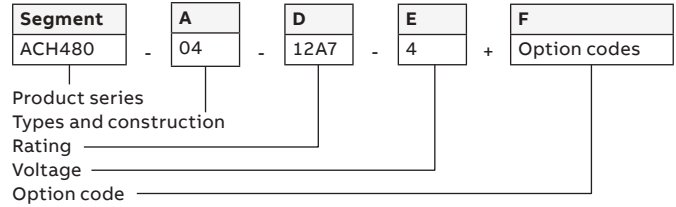

### Basic codes

Segment	Option	Description
A	Construction	04 = when no options are selected: drive module, IP20 (UL Type open), ACH-AP-H control panel with a USB port, BACnet MS/TP, Modbus RTU, N2 as part of RIIO-01 I/O standard module, internal EMC C2 filter, Safe Torque Off, brake chopper, coated boards, quick installation and start-up guide (multilingual)
D	Current rating	Refer to the rating table
E	Voltage rating	4 = 400/480 V (380 ... 480 V) 2 = 3 phase 230 V (200 ... 240 V) 1 = 1 phase 230 V (200 ... 240 V)

### Option codes

Segment	Option	Code	Description	
F	Control panel and panel options	+OJ400	No control panel	
		+J400	ACH-AP-H assistant control panel (as standard)	
		+J424	RDUM-01 blank panel with RJ-45 connector	
		+J425	ACS-AP-I industrial assistant control panel	
		+J429	ACH-AP-W assistant control panel with a Bluetooth interface	
			+J431	USB to RJ-45 cable that is used together with RDUM-01 for PC connection
	I/O (one slot available for I/O options)		+L540	I/O & BACnet MS/TP, Modbus RTU, N2 module RIIO-01 (as standard)
			+OL540	Remove the standard I/O module RIIO-01
			+L515	BIO-01 reduced I/O module (can be used together with fieldbus adapter)
	I/O (one slot available for FBA options)		+K465	BACnet/IP 2-port (FBIP-21)
			+K451	DeviceNet™ (FDNA-01)
			+K454	PROFIBUS® DP (FPBA-01)
			+K457	CANopen® (FCAN-01)
			+K458	Modbus RTU (FSCA-01)
		+K462	ControlNet™ (FCNA-01)	
		+K469	EtherCAT® (FECA-01)	
		+K470	Ethernet POWERLINK (FEPL-01)	
		+K490	EtherNet/IP™ (FEIP-21)	
		+K491	Modbus®/TCP (FMBT-21)	
	+K492	PROFINET® IO (FPNO-21)		
ABB Ability™ Condition Monitoring for drives		+K496	NETA-21 wired remote monitoring system	

Side I/O options BREL-01 (relay option: 4xRO) and BAPO-01 (External +24 DC option) are available as loose items only. Only one slot for side I/O option is available. For other options please contact local ABB.

# Summary of drive ordering codes

## ACH580-01

The type designation tells you the specifications and configuration of the drive.

The table shows the primary drive variants.

Sample type code: ACH580-01-12A7-4+XXXX

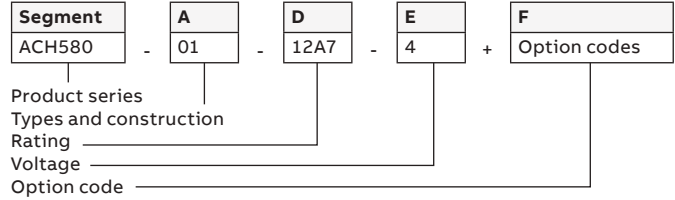

Basic codes				
Segment	Option		Description	
A	Construction	01 = when no options are selected: wall-mounted drive, IP21 (UL Type 1), ACH-AP-H control panel with a USB port, embedded BACnet MS/TP, Modbus RTU, N2, choke, internal EMC C2 filter, Safe Torque Off, braking chopper in frames R1, R2, R3, coated boards, cable lead through entry from the bottom, cable box or the conduit plate with cable entries, quick installation and start-up guide (multilingual)		
D	Current rating		Refer to the rating table	
E	Voltage rating		4 = 400/480 V (380...480 V) 2 = 230 V (200...240 V)	
Option codes				
Segment	Option	Code	Description	
F	Control panel and panel options	+J400	ACH-AP-H assistant control panel (as standard)	
		+0J400	Removes control panel	
		+J424	CDUM-01 blank control panel cover (no control panel)	
		+J425	ACS-AP-I industrial assistant control panel	
		+J429	ACH-AP-W assistant control panel with a Bluetooth interface	
		+J461	ACH-DCP-11 connectivity panel hardware (EU variant)	
			+J482	2-year condition monitoring cloud subscription by ACH-DCP-11
	I/O (one slot available for I/O options)		+L501	CMOD-01 external 24 V AC/DC and digital I/O extension (2×RO and 1×DO)
			+L512	CHDI-01 115/230 V digital input extension (6×DI and 2×RO)
			+L523	CMOD-02 external 24 V AC/DC and isolated PTC interface
			+L525	CAIO-01 analogue signal extension (3 x AI and 2 x AO)
			+L537	CPTC-02 ATEX-certified PTC interface, Ex II (2) GD and external 24 V. Requires also option +Q971.
	Safety	+Q971	ATEX-certified Safe Disconnection Function, Ex II (2) GD. Sold only with option +L537.	
	Fieldbus (One fieldbus adapter supported. Fieldbus adapters available as loose options for retrofit.)		+K465	BACnet/IP 2-port (FBIP-21)
			+K451	DeviceNet™ (FDNA-01)
			+K454	PROFIBUS® DP (FPBA-01)
			+K457	CANopen® (FCAN-01)
			+K458	Modbus RTU (FSCA-01)
			+K462	ControlNet™ (FCNA-01)
			+K469	EtherCAT® (FECA-01)
		+K470	Ethernet POWERLINK (FEPL-01)	
		+K490	EtherNet/IP™ (FEIP-21)	
		+K491	Modbus®/TCP (FMBT-21)	
	+K492	PROFINET® IO (FPNO-21)		
ABB Ability™ Condition Monitoring for drives	+K496	NETA-21 wired remote monitoring system		
IP enclosure	+B056	IP55 (UL Type 12). Factory option, retrofit not possible.		
Construction	+C135	Flange mounting kit (only available for 400V IP21 drives)		
	+H358	Cable conduit plate, blank		
	+P944	Drive without cable entry box. Version for cabinet mounting (R5-R9).		
	+F278	Main switch disconnecter (R1-R5)		
	+E223	EMC filter, category C1 for earthed network (R1-R5)		
	+F316	Main switch and EMC filter, category C1 for earthed network (R1-R5)		
	Complementary options	+P931	Extended warranty up to 36 months	
		+P932	Extended warranty up to 60 months	
+P952		European Union Country of origin		
Software	+N2000	Standard language package		
	+N2901	Europe language package		
	+N2902	Asia language package		

## ACH580-04

The type designation tells you the specifications and configuration of the drive.

The table shows the primary drive variants.

Sample type code: ACH580-04-505A-4+XXXX

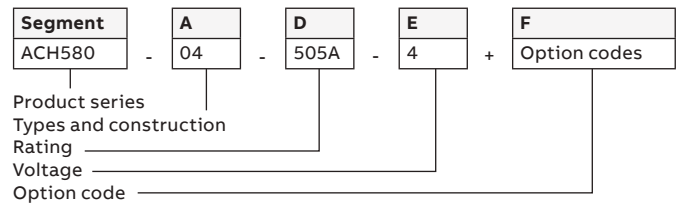

### Basic codes

Segment	Option	Description
A	Construction	04 = when no options are selected: drive module, IP00 (UL Type open), bookshelf mounting with pedestal, integrated control unit (inside the drive module), ACH-AP-H control panel with a USB port, embedded BACnet MS/TP, Modbus RTU, N2, build-in choke, extraction/installation ramp, full-size output cable connection terminals, common mode filter (+E208), DPMP-03 mounting platform, internal EMC C2 filter TN (grounded) and IT (ungrounded) systems (+E210), no DC connection busbars, Safe Torque Off, coated boards, quick installation and start-up guide (multilingual). Refer to the rating table
D	Current rating	Refer to the rating table
E	Voltage rating	4 = 400/480 V (380...480 V)

### Option codes

Segment	Option	Code	Description
F	Control panel and panel options	+J400	ACH-AP-H assistant control panel (as standard)
		+OJ400	Removes control panel
		+J425	ACS-AP-I industrial assistant control panel
		+J429	ACA-AP-W assistant control panel with a Bluetooth interface
		+J461	ACH-DCP-11 connectivity panel hardware (EU variant)
		+J482	2-year condition monitoring cloud subscription by ACH-DCP-11
	I/O (one slot available for I/O options) (L501, L523 and L512 available as retrofit options)	+L501	External 24 V DC/AC and Digital I/O extension (2xRO and 1xDO) / CMOD-01
		+L512	115/230V Digital input (6xDI and 2xRO) / CHDI-01
		+L523	External 24 V and isolated PTC interface / CMOD-02
		+L525	CAIO-01 analogue signal extension (3 x AI and 2 x AO)
		+L537	ATEX-certified PTC interface, Ex II (2) GD and external 24 V / CPTC-02. Requires also +Q971 option.
	Safety	+Q971	ATEX-certified Safe Disconnection Function, Ex II (2) GD / CPTC-02 (+Q971 option sold only together with +L537 option)
		Fieldbus (One fieldbus adapter supported. Fieldbus adapters available as loose options for retrofit.)	+K465
	+K451		DeviceNet™ (FDNA-01)
	+K454		PROFIBUS® DP (FPBA-01)
	+K457		CANopen® (FCAN-01)
	+K458		Modbus RTU (FSCA-01)
+K462	ControlNet™ (FCNA-01)		
+K469	EtherCAT® (FECA-01)		
+K470	Ethernet POWERLINK (FEPL-01)		
+K490	EtherNet/IP™ (FEIP-21)		
+K491	Modbus®/TCP (FMBT-21)		
+K492	PROFINET® IO (FPNO-21)		
ABB Ability™ Condition Monitoring for drives	+K496	NETA-21 wired remote monitoring system	
IP enclosure	+B051	IP20 Finger safe	
Construction	+J410	Control panel door mounting kit (+J410 Includes DPMP-03)	
	+H370	Full-size input terminals	
	+H381	Full power cabling panels to be attached to a cabinet, the drive module can be pulled out from the cabinet without disconnecting the power cables	
	+P906	Remote control board	
	+OH371	No full size output terminals	
	+OH534	No pedestal	
	+OP919	No cabinet installation ramp	
	Filters	+E202	EMC/RFI-filter, C2, 1 <sup>st</sup> environment (earthed networks)
+E210		EMC/RFI-filter, C3, 2 <sup>nd</sup> environment, unrestricted (earthed and unearthed networks)	
+E208		Common mode filter	
Resistor braking	+D150	Brake chopper	
Complementary options	+P931	Extended warranty up to 36 months	
	+P932	Extended warranty up to 60 months	
	+P952	European Union Country of origin	

# Summary of drive ordering codes

## ACH580-07

The type designation tells you the specifications and configuration of the drive.

The table shows the primary drive variants.

Sample type code: ACH580-07-145A-4+XXXX

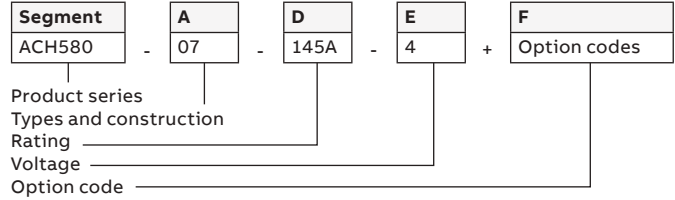

### Basic codes

Segment	Option	Description
A	Construction	07 = when no options are selected: cabinet-installed drive, IP21 (UL Type 1), ACH-AP-H control panel with a USB port, embedded BACnet MS/TP, Modbus RTU, N2, main switch, AC fuses, internal EMC C3 filter (TN grounded), common mode filter in frames R10 and R11, Safe Torque Off, bottom entry and exit of cables, USB memory containing all manuals.
D	Current rating	Refer to the rating table
E	Voltage rating	4 = 400/480 V (380...480 V)

### Option codes

Segment	Option	Code	Description
	Control panel and panel options	+J429	ACH-AP-W assistant control panel with a Bluetooth interface
		+J461	ACH-DCP-11 connectivity panel hardware (EU variant)
		+J482	2-year condition monitoring cloud subscription by ACH-DCP-11
I/O (one slot available for I/O options)		+L501	External 24 V DC/AC and Digital I/O extension (2xRO and 1xDO)
		+L504	Additional I/O-Terminal Block
		+L512	115/230V Digital input (6xDI and 2xRO)
		+L523	External 24 V and isolated PTC interface
		+L525	CAIO-01 analogue signal extension (3 x AI and 2 x AO)
		+L537	ATEX-certified thermistor protection module, Ex II (2) GD (requires ATEX-certified Safe Disconnection Function, Ex II (2) GD, add +Q971 to code)
		Safety	
+Q951	Safety option of emergency stop where Main breaker is opened during emergency		
+Q963	Safety option of emergency stop where main breaker is not opened during emergency		
Fieldbus (One fieldbus adapter supported. Fieldbus adapters available as loose options for retrofit.)		+K465	BACnet/IP 2-port (FBIP-21)
		+K451	DeviceNet™ (FDNA-01)
		+K454	PROFIBUS® DP (FPBA-01)
		+K457	CANopen® (FCAN-01)
		+K458	Modbus RTU (FSCA-01)
		+K462	ControlNet™ (FCNA-01)
		+K469	EtherCAT® (FECA-01)
		+K470	Ethernet POWERLINK (FEPL-01)
		+K490	EtherNet/IP™ (FEIP-21)
		+K491	Modbus®/TCP (FMBT-21)
+K492	PROFINET® IO (FPNO-21)		
ABB Ability™ Condition Monitoring for drives		+K496	NETA-21 wired remote monitoring system
IP enclosure		+B054	IP42 (UL Type 1)
		+B055	IP54 (UL Type 12)
Construction		+C129	Cabinet drive is UL listed
		+C180	Seismic design

<b>Option codes</b>			
<b>Segment</b>	<b>Option</b>	<b>Code</b>	<b>Description</b>
F	Filters, contactors, circuit breakers	+E205	Du/dt filter
		+E208	Common mode filter (as a default for R10-R11)
		+F250	Line contactor
		+F289	Molded case circuit breaker (UL listed, requires C129 option)
	Cabling	+H351	Top entry (additional channel for frames R6-R9, +125 mm the drive cabinet width)
			Top entry through roof (frames R10-R11)
		+H353	Top exit (additional channel for frames R6-R9, +125mm the drive cabinet width)
			Top exit (frames R10-R11) – additional 150 mm channel
		+H358	Cable conduit entry (Default in US, anywhere else specify in order)
		+C164	Plinth 100 mm (separate in package)
	+C179	Plinth 200 mm (separate in package)	
	Cabinet options	+C128	Cooling air intake through bottom of cabinet
		+C130	Channeled air outlet
		+C196	Empty cabinet 400 mm on right side
		+C197	Empty cabinet 600 mm on right side
		+C198	Empty cabinet 800 mm on right side
		+C199	Empty cabinet 400 mm on left side
		+C200	Empty cabinet 600 mm on left side
		+C201	Empty cabinet 800 mm on left side
		+G300	Cabinet heater (External supply)
		+G313	Output for motor heater
		+G327	Ready Pilot light, white
		+G328	Run Pilot light, green
		+G329	Fault Pilot light, red
	Starter for auxiliary motor fan	+M600	1...1.6 A; 1PC-s, dimensioned by fan size, Includes protective devices
		+M601	1.6...2.5 A; 1PC-s, dimensioned by fan size, Includes protective devices
		+M602	2.5...4 A; 1PC-s, dimensioned by fan size, Includes protective devices
		+M603	4...6.3 A; 1PC-s, dimensioned by fan size, Includes protective devices
		+M604	6.3...10 A; 1PC-s, dimensioned by fan size, Includes protective devices
		+M605	10...16 A; 1PC-s, dimensioned by fan size, Includes protective devices
	Complementary options	+P931	Extended warranty up to 36 months
		+P932	Extended warranty up to 60 months
Specialities	+P912	Seaworthy Packing (R10, R11: High Cube (HC) container required for reshipping)	
Software	+N2000	Standard language package	
	+N2901	Europe language package	
	+N2902	Asia language package	

# Summary of drive ordering codes

## ACH580-31

The type designation tells you the specifications and configuration of the drive.

The table shows the primary drive variants.

Sample type code: ACH580-31-12A7-4+XXXX

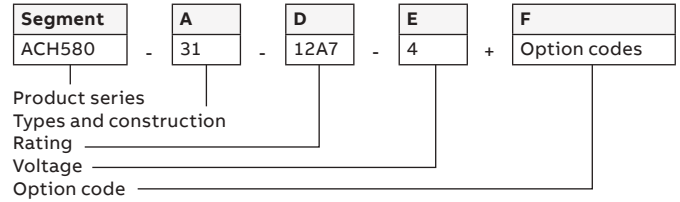

### Basic codes

Segment	Option	Description
A	Construction	31 = when no options are selected: ultra-low harmonic wall-mounted drive, IP21 (UL Type 1), ACH-AP-H control panel with a USB port, embedded BACnet MS/TP, Modbus RTU, N2, choke, internal EMC C2 filter in frames R3 and R8, internal EMC C3 filter in frame R6, internal common mode filter, Safe Torque Off, coated boards, cable entry from the bottom, cable box or the conduit plate with cable entries, quick installation and start-up guide (multilingual)
D	Current rating	Refer to the rating table
E	Voltage rating	4 = 400/480 V (380...480 V)

### Option codes

Segment	Option	Code	Description
F	Control panel and panel options	+J400	ACH-AP-H assistant control panel (as standard)
		+OJ400	Removes control panel
		+J424	CDUM-01 blank control panel cover (no control panel)
		+J425	ACS-AP-I industrial assistant control panel
		+J429	ACH-AP-W assistant control panel with a Bluetooth interface
		+J461	ACH-DCP-11 connectivity panel hardware (EU variant)
		+J482	2-year condition monitoring cloud subscription by ACH-DCP-11
	I/O (one slot available for I/O options)	+L501	CMOD-01 External 24 V AC/DC and digital I/O extension (2×RO and 1×DO)
		+L512	CHDI-01 115/230 V Digital input extension (6×DI and 2×RO)
		+L523	CMOD-02 External 24 V AC/DC and isolated PTC interface
		+L525	CAIO-01 analogue signal extension (3 x AI and 2 x AO)
		+L537	CPTC-02 ATEX-certified PTC interface, Ex II (2) GD and external 24 V. Requires also option +Q971.
	Safety	+Q971	ATEX-certified Safe Disconnection Function, Ex II (2) GD. Sold only with option +L537.
	Fieldbus (One fieldbus adapter supported. Fieldbus adapters available as loose options for retrofit.)	+K465	BACnet/IP 2-port (FBIP-21)
		+K451	DeviceNet™ (FDNA-01)
		+K454	PROFIBUS® DP (FPBA-01)
		+K457	CANopen® (FCAN-01)
		+K458	Modbus RTU (FSCA-01)
		+K462	ControlNet™ (FCNA-01)
+K469		EtherCAT® (FECA-01)	
+K470		Ethernet POWERLINK (FEPL-01)	
+K490		EtherNet/IP™ (FEIP-21)	
+K491		Modbus®/TCP (FMBT-21)	
+K492	PROFINET® IO (FPNO-21)		
IP enclosure	+B056	IP55 (UL type 12). Factory option, retrofit not possible.	
Construction	+C135	Flange mounting kit. (Only available for 400V IP21 drives)	
	+H358	Cable conduit plate, blank	
	+P944	Drive without cable entry box. Version for cabinet mounting (R5-R9).	
Complementary options	+P931	Extended warranty up to 36 months	
	+P932	Extended warranty up to 60 months	
	+P952	European Union Country of origin	
Software	+N2000	Standard language package	
	+N2901	Europe language package	
	+N2902	Asia language package	

## ACH580-34

The type designation tells you the specifications and configuration of the drive.

The table shows the primary drive variants.

Sample type code: ACH580-34-505A-4+XXXX

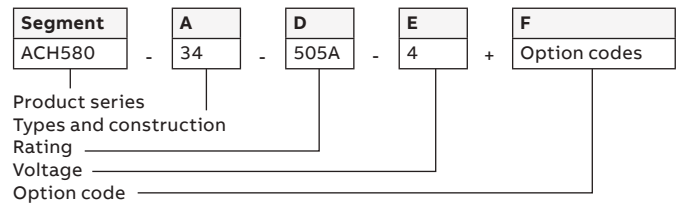

### Basic codes

Segment	Option	Description
A	Construction	34 = when no options are selected: ultra-low-harmonic drive module, IP00 (UL Type open), bookshelf mounting with pedestal, integrated control unit, ACH-AP-H control panel with a USB port, embedded BACnet MS/TP, Modbus RTU, N2, build-in LCL filter, full-size output cable connection terminals, internal EMC C3 filter (+E210), common mode filter (+E208), DC connection busbars, extraction/installation ramp, Safe Torque Off, coated boards, quick installation and start-up guides (multilingual)
D	Current rating	Refer to the rating table
E	Voltage rating	4 = 400/480 V (380...480 V)

### Option codes

Segment	Option	Code	Description
F	Control panel and panel options	+J400	ACH-AP-H assistant control panel (as standard)
		+OJ400	Removes control panel
		+J425	ACS-AP-I industrial assistant control panel
		+J429	ACA-AP-W assistant control panel with a Bluetooth interface
		+J461	ACH-DCP-11 connectivity panel hardware (EU variant)
		+J482	2-year condition monitoring cloud subscription by ACH-DCP-11
	I/O (one slot available for I/O options) (L501, L523 and L512 available as retrofit options)	+L501	External 24 V DC/AC and Digital I/O extension (2xRO and 1xDO) / CMOD-01
		+L512	115/230V Digital input (6xDI and 2xRO) / CHDI-01
		+L523	External 24 V and isolated PTC interface / CMOD-02
		+L525	CAIO-01 analogue signal extension (3 x AI and 2 x AO)
+L537		ATEX-certified PTC interface, Ex II (2) GD and external 24 V / CPTC-02. Requires also +Q971 option.	
Safety	+Q971	ATEX-certified Safe Disconnection Function, Ex II (2) GD / CPTC-02 (+Q971 option sold only together with +L537 option)	
Fieldbus (One fieldbus adapter supported. Fieldbus adapters available as loose options for retrofit.)	+K465	BACnet/IP 2-port (FBIP-21)	
	+K451	DeviceNet™ (FDNA-01)	
	+K454	PROFIBUS® DP (FPBA-01)	
	+K457	CANopen® (FCAN-01)	
	+K458	Modbus RTU (FSCA-01)	
	+K462	ControlNet™ (FCNA-01)	
	+K469	EtherCAT® (FECA-01)	
	+K470	Ethernet POWERLINK (FEPL-01)	
	+K490	EtherNet/IP™ (FEIP-21)	
	+K491	Modbus®/TCP (FMBT-21)	
+K492	PROFINET® IO (FPNO-21)		
IP enclosure	+B051	IP20 Finger safe	
Construction	+J410	Control panel door mounting kit (+J410 Includes DPMP-03)	
	+H370	Full-size input terminals	
	+H381	Full power cabling panels to be attached to a cabinet, the drive module can be pulled out from the cabinet without disconnecting the power cables	
	+P906	Remote control board	
	+OH371	No full size output terminals	
	+OP919	No cabinet installation ramp	
Filters	+E202	EMC/RFI-filter, C2, 1 <sup>st</sup> environment (earthed networks)	
	+E210	EMC/RFI-filter, C3, 2 <sup>nd</sup> environment, unrestricted (earthed and unearthed networks)	
	+E208	Common mode filter	
Complementary options	+P931	Extended warranty up to 36 months	
	+P932	Extended warranty up to 60 months	
	+P952	European Union Country of origin	

---

## Our service expertise, your advantage

ABB Motion Services helps customers around the globe by maximizing uptime, extending product life cycle, and enhancing the performance and energy efficiency of electrical motion solutions. We enable innovation and success through digitalization by securely connecting and monitoring our customers' motors and drives, increasing operational uptime, and improving efficiency. We make the difference for our customers and partners every day by keeping their operations running profitably, safely and reliably.

With a service offering tailored to your needs, ABB Motion Services maximizes the uptime and extends the life cycle of your electrical motion solutions, while optimizing their performance and maximizing your energy efficiency gains throughout the entire lifetime of your applications. We help to keep your applications turning profitably, safely, and reliably.

Digitalization enables new smart and secured ways to prevent unexpected downtime while optimizing the operation and maintenance of your assets. We securely connect and monitor your motors, drives or your entire powertrain to our easy-to-use cloud service solutions. Connecting your applications also gives you access to our in-depth service domain expertise.

We quickly respond to your service needs. Together with our partners, local field service experts, and service workshop networks, we provide and install original spare parts to help resolve any issues and minimize the impact of unexpected disruptions.

Our tailored to your needs service offerings and digital solutions will enable you to unlock new possibilities. Not only are we your premier supplier of motion equipment, we are your trusted partner and advisor offering support throughout the entire life cycle of your assets. We ensure your operations run profitably, safely and reliably and continue to drive real world results, now and in the future. Our service teams work with you, delivering the expertise needed to keep your world turning while saving energy every day.





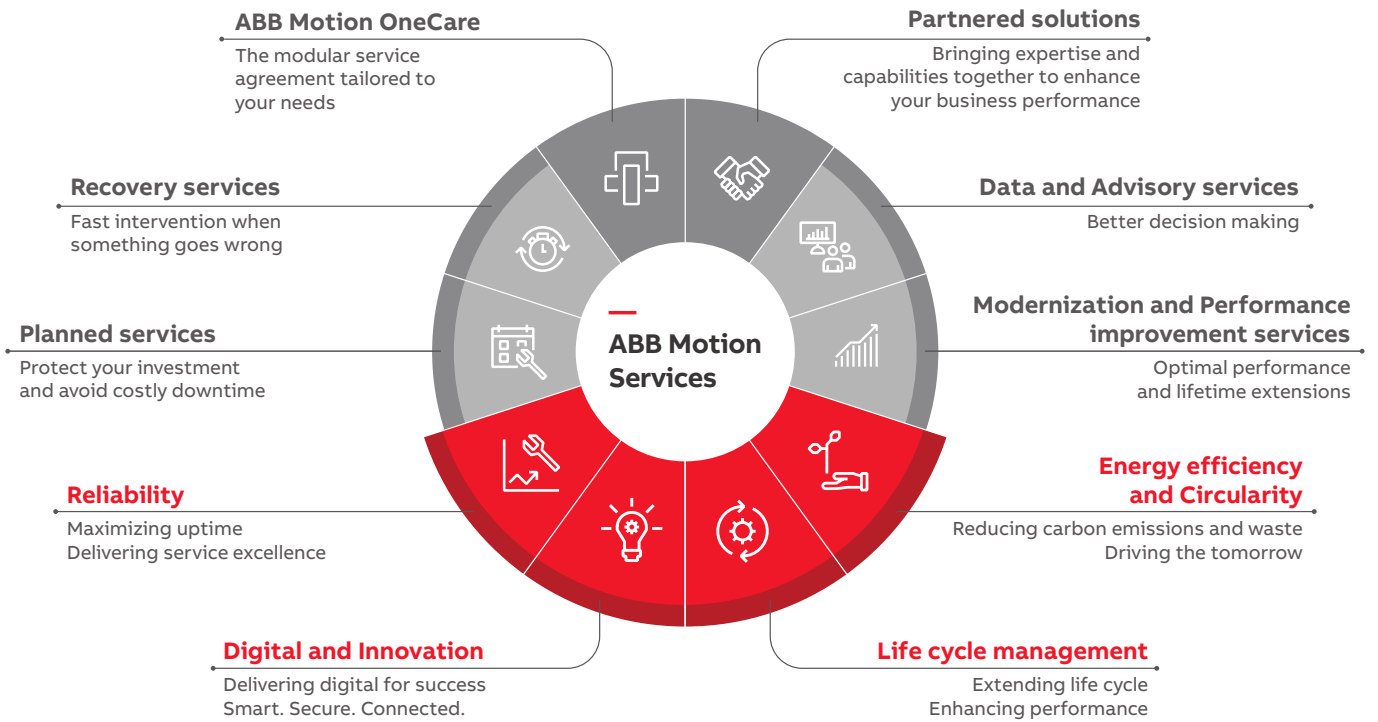

**OUR EXPERTISE**  
**YOUR ADVANTAGE**

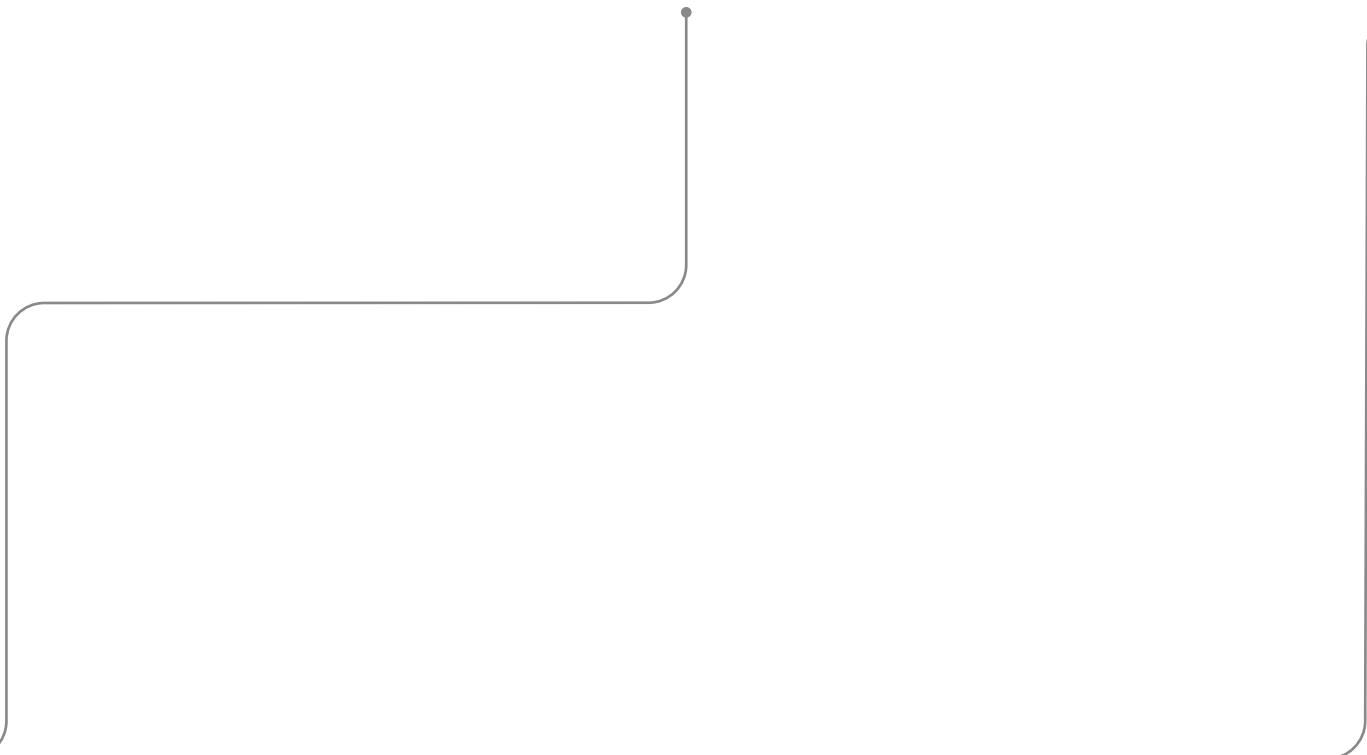

# ABB Drives Life Cycle Management

## A life time of peak performance

You're in control of every life cycle phase of your drives. At the heart of drive services is a four-phase product life cycle management model. This model defines the services recommended and available throughout drives lifespan.

Now it's easy for you to see the exact service and maintenance available for your drives.

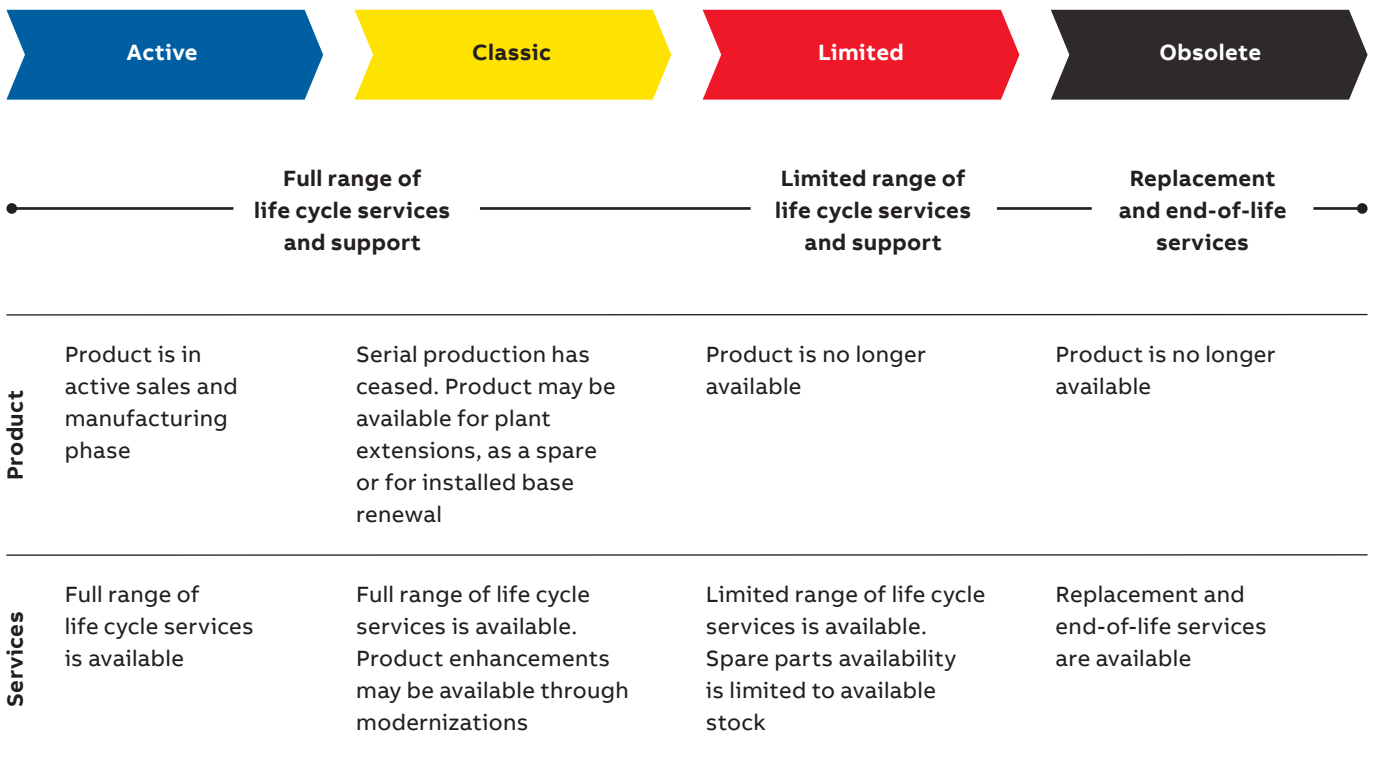





—  
For more information, please contact  
your local ABB representative or visit

**[new.abb.com/drives/HVAC](https://new.abb.com/drives/HVAC)**  
**[abb.com/dives/drivespartners](https://abb.com/dives/drivespartners)**  
**[abb.com/motors-generators](https://abb.com/motors-generators)**