



Low voltage AC drives

ABB industry specific drives

ACQ810

0.37 to 500 kW

Catalog

Tailored for water and wastewater

Protecting, supplying and recycling water, reliably, is critical. This drives series is specialized for the most commonly required pump functions. Built-in macros have been designed to meet single and multi-pump system configurations. Ensure accurate water flow control in all applications, including raw water, utilization, and wastewater treatment.

Contents

4	Reduce your pump system energy usage
6	Intelligent pump control
8	The intelligent choice for water and wastewater applications
10	How to select a drive
11	Technical specification
12	Frame sizes and available options
13	Selection guide
14	Standard software features
15	Comprehensive connectivity
17 - 18	Available filters and chokes
20	Power range: 0.37 to 1.1 kW at 230 V, 1.1 to 3 kW at 400 V - Frame A
21	Power range: 1.5 to 3 kW at 230 V, 4 to 7.5 kW at 400 V - Frame B
22	Power range: 5.5 to 11 kW at 230 V, 11 to 22 kW at 400 V - Frame C
23	Power range: 15 to 22 kW at 230 V, 30 to 45 kW at 400 V - Frame D
24	Power range: 55 to 160 kW at 400 V - Frame E0/E
25	Power range: 200 to 500 kW at 400 V - Frame G1/G2
26	Control panel
27	Flexible connectivity to automation networks
28	Remote monitoring and PC tool
29	Taking care of your drives, caring about your business
30	Combine the benefits of premium motor control and Synchronous reluctance technology
32	Ultimate efficiency and reliability to optimize your pump system cost of ownership
33	Selection guide - IE4 synchronous reluctance motors





Reduce your pump system energy usage

Redundancy

Ensure reliable operation in parallel, multi-pump systems if one or more pumps fail or require maintenance. The remaining pumps will continue to operate. Overall maintenance time and cost are decreased.

Remote monitoring

Send process data, logs and event messages independently without additional on-site devices. Remote monitoring interfaces to standard web browsers will help reduce the amount of routine site visits to reduce cost.

Auto-change

Balance the long-term operating time of all pumps in the parallel pumping system. This will help to increase the mean time between repairs and reduce service costs. The lifetime of the pumps and motors will increase.

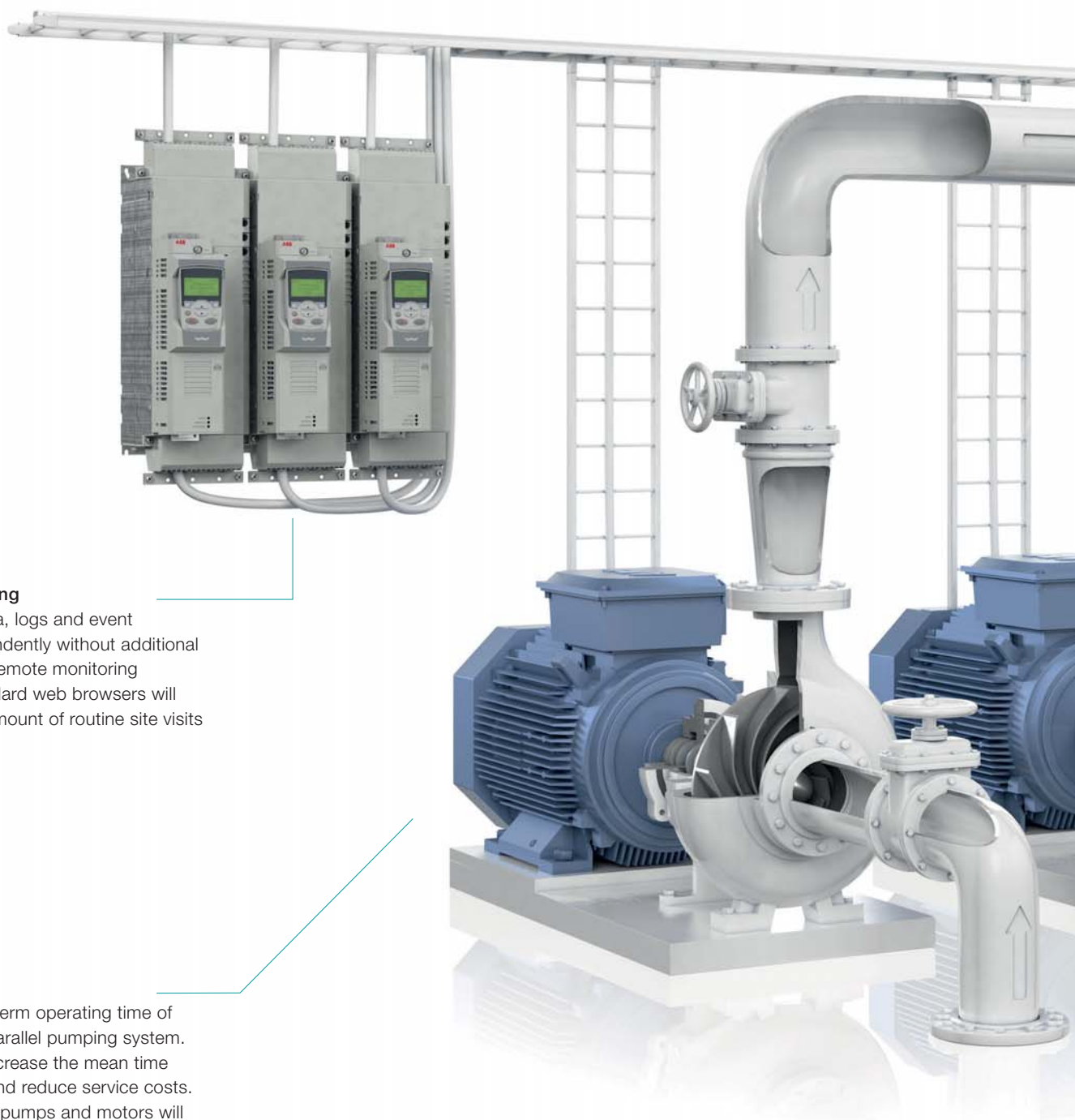

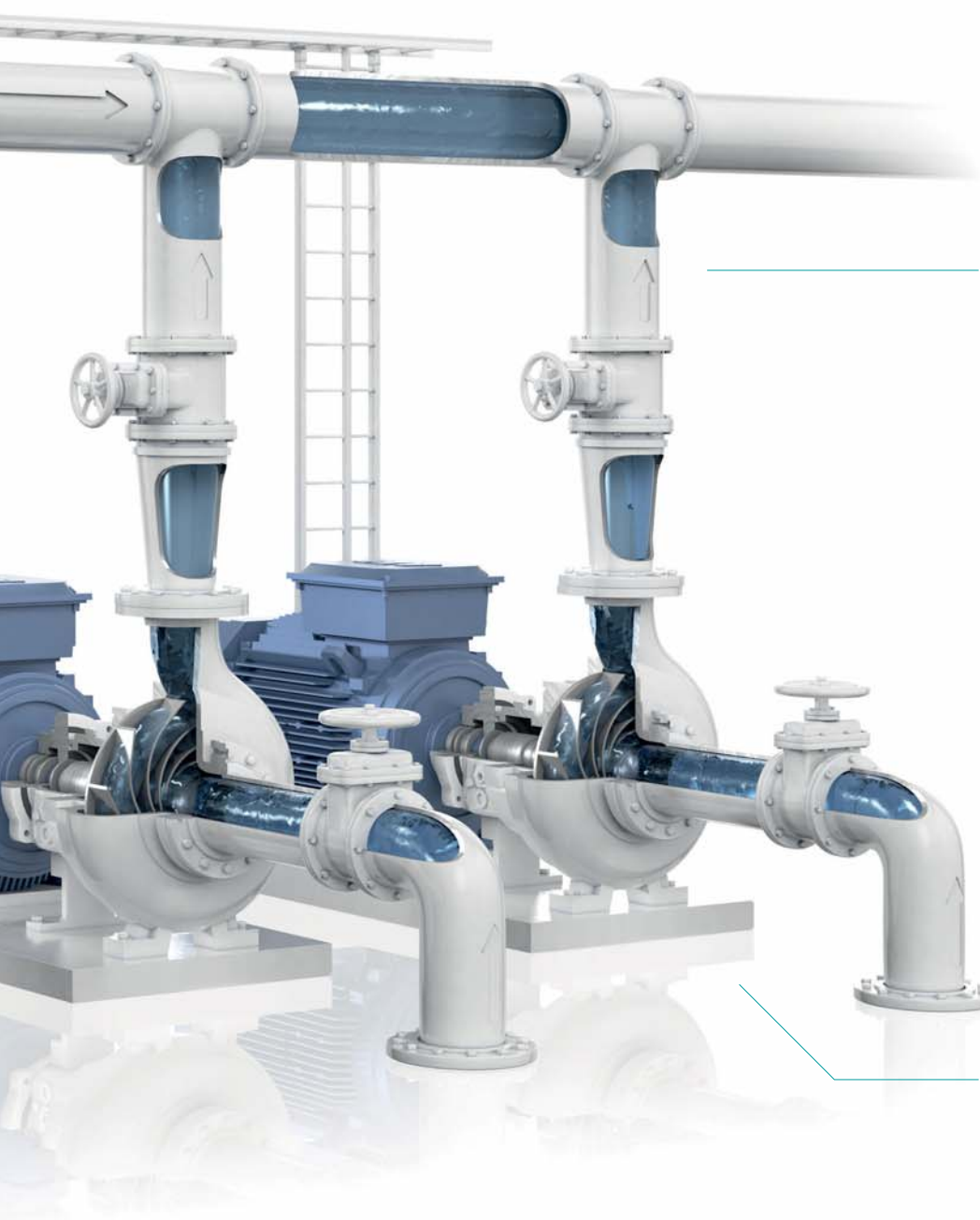

Protections

Maintain disturbance free operation through protection functions which will indicate if pre-defined conditions are altered. If the flow or pressure exceed defined limits, an appropriate alarm is generated.

Soft pipe filling

Provide a smooth build-up of flow in pipes. This avoids pressure peaks when the pipes are momentarily empty and controlled pipe filling is demanded. The lifetime of the piping and pump system is increased.

Diagnositics

In the case of a fault on your system, determine the cause in a quick, user-friendly path to resolution.

Intelligent pump control

Save energy, reduce downtime, prevent pump jamming and pipeline block and eliminate the need for external equipment



Sleep boost

Detect pressure drops in the pipeline and run the pumps to boost pressure prior to low activity periods, such as at night. The pumps will restart normal activity after a pre-set time or once the boosted pressure falls below the minimum level. Save energy while extending the life of the pump and motor by decreasing start/stop cycles during these hours.

Pump cleaning

Use to prevent pump and pipe clogging in the wastewater pumping stations. A sequence of forward and reverse runs of the pump clean the impeller. If the function runs too often an alarm is raised.

Flow calculation

Avoid costly external flow meters by accurately determining the flow rate within a process through internal calculations.



Multi-pump control

Maintain stable process conditions for several parallel pumps operating together. Optimize the speed and number of pumps needed where the required flow rate is variable.

Pump priority

Allow higher capacity pumps to be operated by the drive during daytime and smaller units at night whenever the consumption rate varies based on demand.

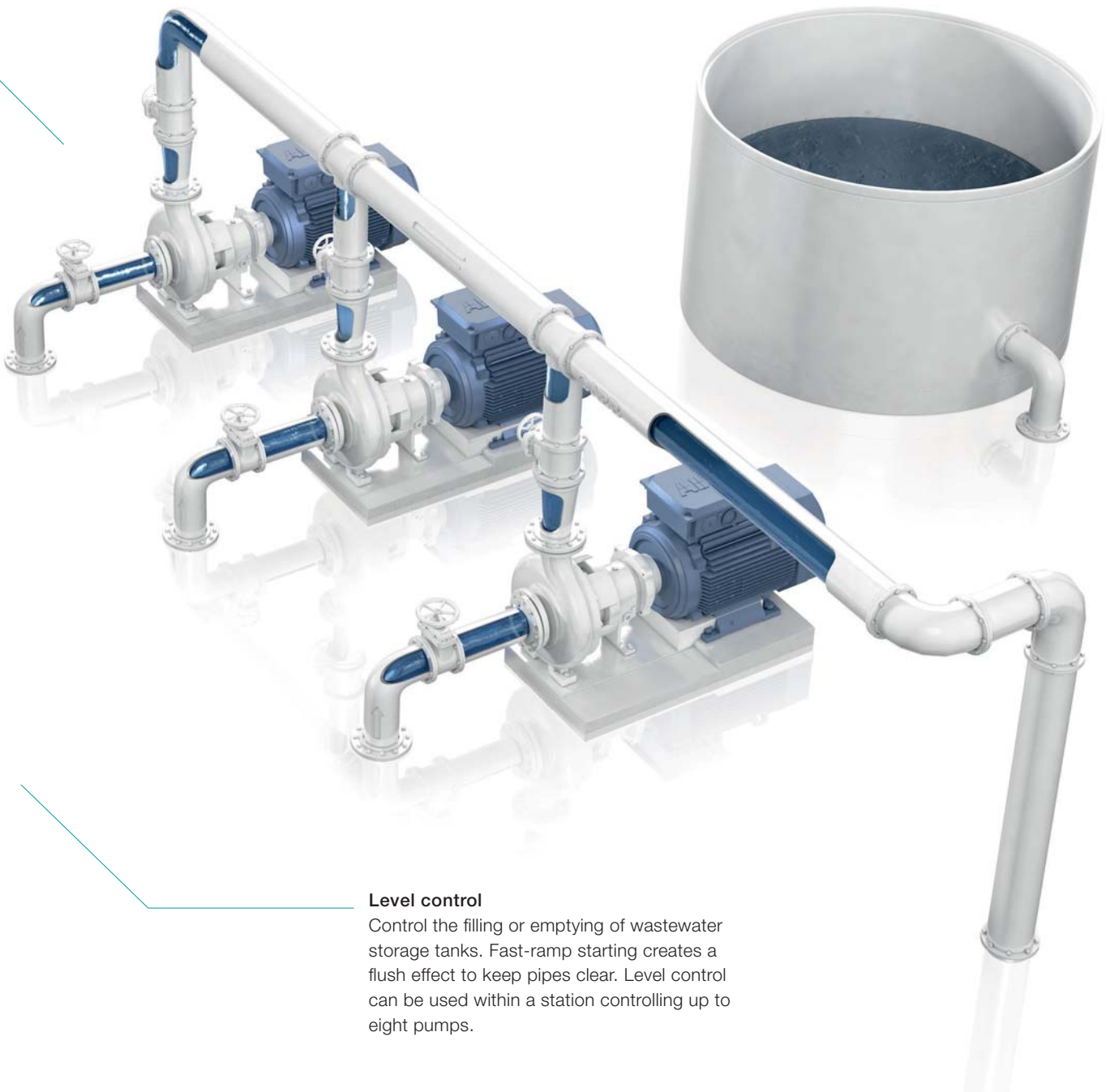

Level control

Control the filling or emptying of wastewater storage tanks. Fast-ramp starting creates a flush effect to keep pipes clear. Level control can be used within a station controlling up to eight pumps.

The intelligent choice for water and wastewater applications

Real time clock

Setup real time related functions for system control based on time-of-day variable demand.

Embedded modbus

Utilize the most common communication protocol in the water industry right out of the box.

Side-by-side mounting

A compact, narrow module design allows for cabinet mounting including DIN rail mounts on smaller frame sizes.

Remote monitoring

With a built-in web server, SREA-01 enables worldwide access to drives.



Removable memory unit

Download and upload parameters to a number of drives on startups, installations, and trouble-shooting.



Whether your system requires redundancy in multi-pump applications or built-in macros designed for the water and wastewater markets, the ACQ810 will surpass your requirements.



Startup and maintenance tools

DriveStudio and the DriveSPC programming tool for startup, configuration, daily use and process tuning of the drive to application requirements.

Flexible product configurations

Drives are built to order with a wide range of options such as EMC filters.



Communication with all major automation networks

Fieldbus adapters enable connectivity with all major automation networks.



Extended connectivity

In addition to the standard interfaces the drive has a built-in slot for additional input/output extension modules.

How to select a drive

1 Start with identifying your supply voltage.
This tells you what rating table to use.
The ACQ810 supports 240 and 400 V.

2 Choose your motor's nominal power rating from the ratings table on page 13.

4 Choose your options. An overview of the available options is located on page 12, details on each begin on page 17. Add the option codes to the end of the drive's ordering code. Remember to use a "+" before each option code.

Selection guide Page 13

Ratings 230 V					
P_n (kW)	I_n (A)	I_{cr} (A)	I_{sc} (A)	Type designation	Frame size
0.37	1.7	3	4.4	ACQ810-04-03A7-40*	A
0.55	2.5	4.2	5.5	ACQ810-04-05A7-40*	A
0.75	3.4	5.8	7.7	ACQ810-04-07A7-40*	A
1.1	5.1	8	11.1	ACQ810-04-11A7-40*	A
1.5	7	11.2	15.1	ACQ810-04-15A7-40*	A
2.2	10	15.8	21.5	ACQ810-04-22A7-40*	A
3	13.8	21.2	29	ACQ810-04-30A7-40*	A
4	18.2	28.2	38.5	ACQ810-04-40A7-40*	A
5.5	25	38	51.5	ACQ810-04-55A7-40*	A
7.5	34	52	70	ACQ810-04-75A7-40*	A
11	50	75	102	ACQ810-04-110A7-40*	A
15	69	105	141	ACQ810-04-150A7-40*	A
22	100	150	203	ACQ810-04-220A7-40*	A
30	135	205	280	ACQ810-04-300A7-40*	A
40	180	275	375	ACQ810-04-400A7-40*	A
55	250	380	515	ACQ810-04-550A7-40*	A
75	340	515	700	ACQ810-04-750A7-40*	A
110	500	750	1020	ACQ810-04-1100A7-40*	A

Ratings 400 V					
P_n (kW)	I_n (A)	I_{cr} (A)	I_{sc} (A)	Type designation	Frame size
0.37	1.7	3	4.4	ACQ810-04-03A7-40*	A
0.55	2.5	4.2	5.5	ACQ810-04-05A7-40*	A
0.75	3.4	5.8	7.7	ACQ810-04-07A7-40*	A
1.1	5.1	8	11.1	ACQ810-04-11A7-40*	A
1.5	7	11.2	15.1	ACQ810-04-15A7-40*	A
2.2	10	15.8	21.5	ACQ810-04-22A7-40*	A
3	13.8	21.2	29	ACQ810-04-30A7-40*	A
4	18.2	28.2	38.5	ACQ810-04-40A7-40*	A
5.5	25	38	51.5	ACQ810-04-55A7-40*	A
7.5	34	52	70	ACQ810-04-75A7-40*	A
11	50	75	102	ACQ810-04-110A7-40*	A
15	69	105	141	ACQ810-04-150A7-40*	A
22	100	150	203	ACQ810-04-220A7-40*	A
30	135	205	280	ACQ810-04-300A7-40*	A
40	180	275	375	ACQ810-04-400A7-40*	A
55	250	380	515	ACQ810-04-550A7-40*	A
75	340	515	700	ACQ810-04-750A7-40*	A
110	500	750	1020	ACQ810-04-1100A7-40*	A

Nominal ratings
P_n - Typical motor power
I_n - IEC standard reference for 1 minute duty in through the entire speed range
I_{cr} - IEC standard reference for 1 minute duty in through the entire speed range
I_{sc} - Maximum locked rotor current available for 10 s at 50 Hz, reference as being allowed by drive temperature
* The last number in type code is 0 or 20 when nominal supply voltage is U_n. Select number 1 when U_n is 400 V, number 2 when U_n is 230 V.
Note: The ratings apply at 40 °C ambient temperature.

Catalog | ABB industry specific drives ACQ810 | 13

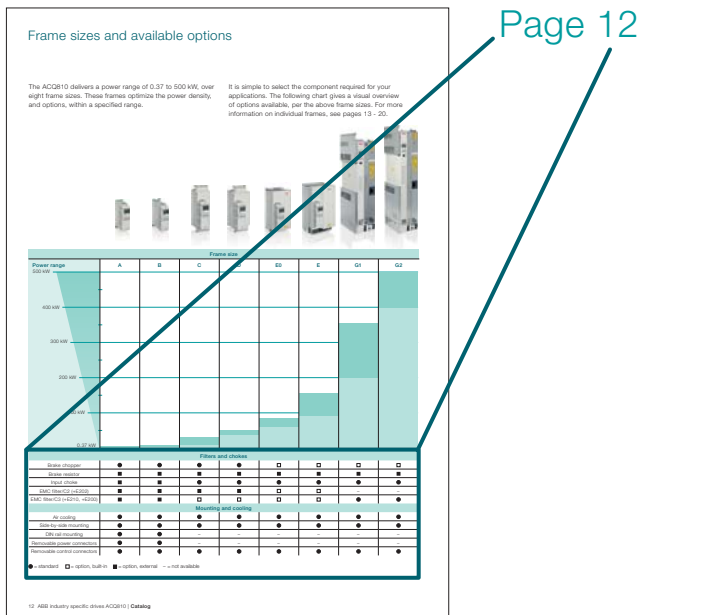

3 Select your drive's type code from the rating table based on your motor's nominal power rating.

Selection guide Page 13

Ratings 230 V					
P_n (kW)	I_n (A)	I_{cr} (A)	I_{sc} (A)	Type designation	Frame size
0.37	1.7	3	4.4	ACQ810-04-03A7-40*	A
0.55	2.5	4.2	5.5	ACQ810-04-05A7-40*	A
0.75	3.4	5.8	7.7	ACQ810-04-07A7-40*	A
1.1	5.1	8	11.1	ACQ810-04-11A7-40*	A
1.5	7	11.2	15.1	ACQ810-04-15A7-40*	A
2.2	10	15.8	21.5	ACQ810-04-22A7-40*	A
3	13.8	21.2	29	ACQ810-04-30A7-40*	A
4	18.2	28.2	38.5	ACQ810-04-40A7-40*	A
5.5	25	38	51.5	ACQ810-04-55A7-40*	A
7.5	34	52	70	ACQ810-04-75A7-40*	A
11	50	75	102	ACQ810-04-110A7-40*	A
15	69	105	141	ACQ810-04-150A7-40*	A
22	100	150	203	ACQ810-04-220A7-40*	A
30	135	205	280	ACQ810-04-300A7-40*	A
40	180	275	375	ACQ810-04-400A7-40*	A
55	250	380	515	ACQ810-04-550A7-40*	A
75	340	515	700	ACQ810-04-750A7-40*	A
110	500	750	1020	ACQ810-04-1100A7-40*	A

Ratings 400 V					
P_n (kW)	I_n (A)	I_{cr} (A)	I_{sc} (A)	Type designation	Frame size
0.37	1.7	3	4.4	ACQ810-04-03A7-40*	A
0.55	2.5	4.2	5.5	ACQ810-04-05A7-40*	A
0.75	3.4	5.8	7.7	ACQ810-04-07A7-40*	A
1.1	5.1	8	11.1	ACQ810-04-11A7-40*	A
1.5	7	11.2	15.1	ACQ810-04-15A7-40*	A
2.2	10	15.8	21.5	ACQ810-04-22A7-40*	A
3	13.8	21.2	29	ACQ810-04-30A7-40*	A
4	18.2	28.2	38.5	ACQ810-04-40A7-40*	A
5.5	25	38	51.5	ACQ810-04-55A7-40*	A
7.5	34	52	70	ACQ810-04-75A7-40*	A
11	50	75	102	ACQ810-04-110A7-40*	A
15	69	105	141	ACQ810-04-150A7-40*	A
22	100	150	203	ACQ810-04-220A7-40*	A
30	135	205	280	ACQ810-04-300A7-40*	A
40	180	275	375	ACQ810-04-400A7-40*	A
55	250	380	515	ACQ810-04-550A7-40*	A
75	340	515	700	ACQ810-04-750A7-40*	A
110	500	750	1020	ACQ810-04-1100A7-40*	A

Nominal ratings
P_n - Typical motor power
I_n - IEC standard reference for 1 minute duty in through the entire speed range
I_{cr} - IEC standard reference for 1 minute duty in through the entire speed range
I_{sc} - Maximum locked rotor current available for 10 s at 50 Hz, reference as being allowed by drive temperature
* The last number in type code is 0 or 20 when nominal supply voltage is U_n. Select number 1 when U_n is 400 V, number 2 when U_n is 230 V.
Note: The ratings apply at 40 °C ambient temperature.

Catalog | ABB industry specific drives ACQ810 | 13

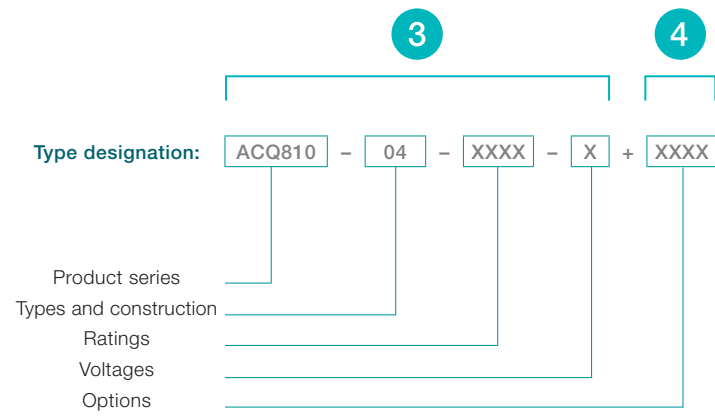

Technical specification



Mains connection		Environmental limits	
Voltage and power range	3-phase, 380 to 480 V, +10/-15% (1.1 to 500 kW) 3-phase, 200 to 240 V, +10/-10% (0.37 to 22 kW)	Degree of protection	IP20 according to EN 60529, G1 and G2 frames IP00 (optionally IP20) Open type according to UL 508
Frequency	50 to 60 Hz ± 5%	Ambient temperature	-10 to +55 °C, derating above 40 °C, no frost allowed
Motor connection		Installation altitude	0 to 4000 m (IT network: 2000 m), derating above 1000 m: 1%/100 m
Motor types	Asynchronous AC induction motors, SynRM motors	Relative humidity	Max. 95%, no condensation allowed
Voltage	3-phase, from 0 to U_N	Contamination levels	According to IEC 60721-3-3: Chemical gases: Class 3C2, Solid particles: Class 3S2, No conductive dust allowed
Output frequency	0 to 500 Hz	Protection functions	
Motor control	DTC (direct torque control)	Over/undervoltage controller Motor short-circuit protection Input phase-loss detection (both motor and line) Overcurrent protection Drive temperature/overload controller Power limits Motor thermal protection	
Inputs and outputs		Product compliance	
2 analog inputs	Selectable for current and voltage	Conformity to standards	CE, cUL, UL, CSA, GOST-R, C-Tick
Voltage signal	0 to 10 V	Harmonics	IEC/EN 61000-3-12
Current signal	0 to 20 mA	EMC (according to EN 61800-3)	Category C3 (C2 with optional filter)
2 analog outputs	0 to 20 mA	Functional safety	Safe torque off (STO according to EN 61800-5-2) IEC 61508: SIL 3 EN 62061: SILCL 3 EN ISO 13849-1: PL e
2 bidirectional digital I/Os	24 V logic levels, maximum 200 mA total output current	PC tools	
6 digital inputs	24 V logic levels	DriveStudio	Startup and maintenance tool
2 relay outputs	Maximum switching voltage 250 V AC/30 V DC, maximum continuous current 2 A rms	DriveSPC	Programming tool
Modbus/Drive to drive link	Selectable, RS-485 serial link		
I/O extensions	Digital I/O extension, FIO-01 Analog I/O extension, FIO-11 Analog and digital I/O extension, FIO-21 Relay extension FIO-31		
Communication options	DeviceNet™ adapter, FDNA-01 PROFIBUS DP adapter, FPBA-01 Ethernet (EtherNet/IP™, Modbus/TCP), FENA-11 Modbus adapter, FSCA-01 LonWorks® adapter, FLON-01		
Remote monitoring	Ethernet adapter, SREA-01		

Frame sizes and available options

The ACQ810 delivers a power range of 0.37 to 500 kW, over eight frame sizes. These frames optimize the power density and options within a specified range.

It is simple to select the drives required for your applications. The following chart gives a visual overview of options available by frame size. For more information on individual frames, see pages 22 - 27.



Frame size								
Power range	A	B	C	D	E0	E	G1	G2
500 kW								
400 kW								
300 kW								
200 kW								
100 kW								
0.37 kW								
Filters and chokes								
Input choke	■	■	●	●	●	●	●	●
EMC filter/C2 (+E202)	■	■	■	■	□	□	-	-
Mounting and cooling								
Air cooling	●	●	●	●	●	●	●	●
Side-by-side mounting	●	●	●	●	●	●	●	●
DIN rail mounting	●	●	-	-	-	-	-	-
Removable power connectors	●	●	-	-	-	-	-	-
Removable control connectors	●	●	●	●	●	●	●	●

● = standard □ = option, built-in ■ = option, external - = not available

Selection guide

Ratings 230 V

Nominal ratings				Type designation *	Frame size
P_N (kW)	I_{2N} (A)	I_{cont} (A)	I_{Max} (A)		
0.37	2.7	3	4.4	ACQ810-04-02A7-2	A
0.55	3.5	4.8	7.0	ACQ810-04-03A5-2	A
0.75	4.9	6	8.8	ACQ810-04-04A9-2	A
1.1	6.3	8	10.5	ACQ810-04-06A3-2	A
1.5	8.3	10.5	13.5	ACQ810-04-08A3-2	B
2.2	11	14	16.5	ACQ810-04-11A0-2	B
3	14.4	18	21	ACQ810-04-14A4-2	B
5.5	21	25	33	ACQ810-04-021A-2	C
7.5	28	30	36	ACQ810-04-028A-2	C
11	40	50	66	ACQ810-04-040A-2	C
15	53	61	78	ACQ810-04-053A-2	D
18.5	67	78	100	ACQ810-04-067A-2	D
22	80	94	124	ACQ810-04-080A-2	D

Ratings 400 V

Nominal ratings				Type designation *	Frame size
P_N (kW)	I_{2N} (A)	I_{cont} (A)	I_{Max} (A)		
1.1	2.7	3	4.4	ACQ810-04-02A7-4	A
1.1	3	3.6	5.3	ACQ810-04-03A0-4	A
1.5	3.5	4.8	7.0	ACQ810-04-03A5-4	A
2.2	4.9	6	8.8	ACQ810-04-04A9-4	A
3	6.3	8	10.5	ACQ810-04-06A3-4	A
4	8.3	10.5	13.5	ACQ810-04-08A3-4	B
5.5	11	14	16.5	ACQ810-04-11A0-4	B
7.5	14.4	18	21	ACQ810-04-14A4-4	B
11	21	25	33	ACQ810-04-021A-4	C
15	28	30	36	ACQ810-04-028A-4	C
18.5	35	44	53	ACQ810-04-035A-4	C
22	40	50	66	ACQ810-04-040A-4	C
30	53	61	78	ACQ810-04-053A-4	D
37	67	78	100	ACQ810-04-067A-4	D
45	80	94	124	ACQ810-04-080A-4	D
55	98	103	138	ACQ810-04-098A-4	E0
75	138	144	170	ACQ810-04-138A-4	E0
90	162	202	282	ACQ810-04-162A-4	E
110	203	225	326	ACQ810-04-203A-4	E
132	240	260	326	ACQ810-04-240A-4	E
160	286	290	348	ACQ810-04-286A-4	E
200	377	387	470	ACQ810-04-377A-4	G1
250	480	500	560	ACQ810-04-480A-4	G1
315	570	580	680	ACQ810-04-570A-4	G1
355	634	650	730	ACQ810-04-634A-4	G1
400	700	710	850	ACQ810-04-700A-4	G2
450	785	807	1020	ACQ810-04-785A-4	G2
500	857	875	1100	ACQ810-04-857A-4	G2

Nominal ratings

P_N	Typical motor power.
I_{2N}	110% overload allowed for 1 minute every 5 minutes through the entire speed range.
I_{cont}	Continuous output current with no overload capacity.
I_{max}	Maximum output current. Available for 10 s at start, otherwise as long as allowed by drive temperature.

* The last number in type code (2 or 4) refers nominal supply voltage U_N . Select number 2 when U_N is 230 V and number 4 when U_N is 400 V.

Note: The ratings apply at 40 °C ambient temperature.

Standard software features

The software of the ACQ810 drives is designed to enhance the reliability and durability of the application on which it is used. Also, several advanced functions make the drives easy to use. They can be accessed either via the user-friendly assistant control panel or DriveStudio PC tool.

Macros

Several macros which have pre-set, application-specific parameter settings are available as standard in each drive. These pre-programmed parameter settings enable fast commissioning by adjusting all the relevant parameters in just a couple of clicks.

Startup assistant

The intelligent and intuitive startup assistant allows first time users to quickly customize the drive, out of the box, according to their needs. This is complemented by a built-in help function to make parameter-by-parameter setting easy. These features allow the drive to be quickly commissioned, even without manuals.

Maintenance assistant

The maintenance assistant reminds the user about the drive's preventive maintenance schedule or routine, or that of its associated components, such as motor, cabinet air inlet filters and input contactors. It reminds users of planned maintenance needs based on running hours, operating hours or relay switching to reduce unplanned process interruptions.

Diagnostic assistant

Each ACQ810 drive is equipped with a diagnostic assistant that helps in locating the cause of any disturbance to the drive, and even suggests possible remedies. This reduces process downtime by making repairs or adjustments effortless.

Energy saving features

- A calculator showing the used and saved energy, displayed in kWh, currency (€ or \$) or volume of CO₂ emission. Data is calculated by reference values user-stored in the drive.
- An energy efficiency optimizer that adjusts the motor flux to maximize the total efficiency.
- A load analyzer showing the load profile of the drive.

Short/long menus

The user interface can be configured so that it displays only the most common parameters. This short menu allows users to quickly access parameters without having to sort through all of them.

A long menu is available, displaying the complete list of parameters, for a more advanced configuration.

Input and output mapping

This functionality allows the user to easily go through the input and output configuration of the drive.

List of changed parameters

Allows users to go through the list of changed parameters, making it quick to identify the recently modified ones.



Comprehensive connectivity

The ACQ810 drives offer a wide range of standard interfaces. In addition, the drive has two option slots that can be used for extensions including fieldbus adapter modules and input/output extension modules.

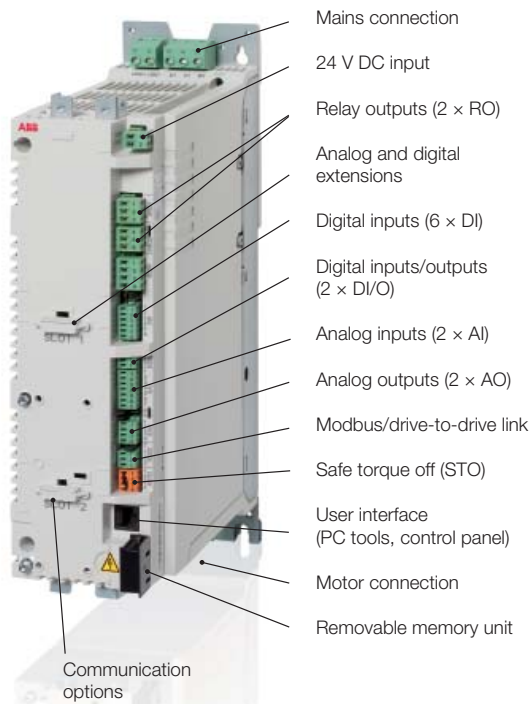

Default control connections to the JCU Control Unit

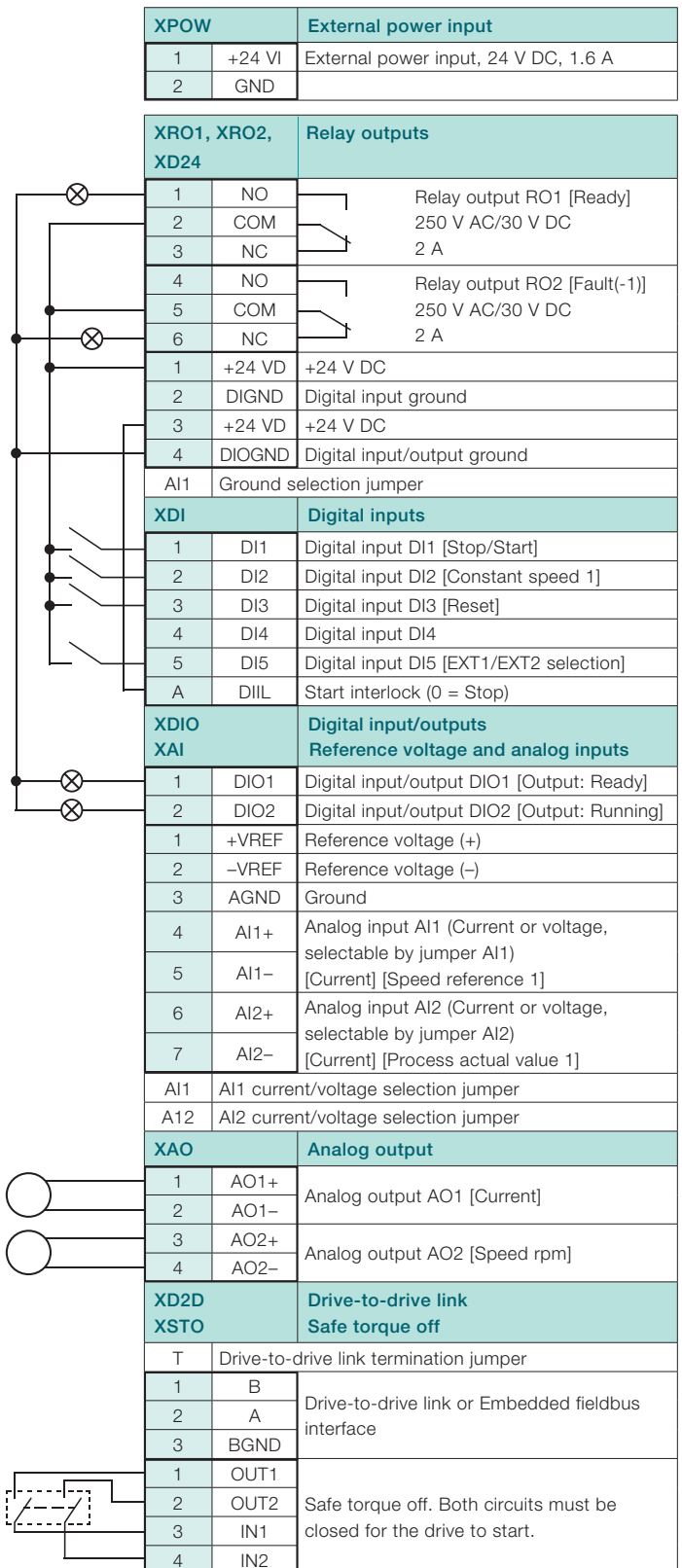

Control panel connection

Memory unit connection



Available filters and chokes

Electromagnetic Compatibility (EMC) and modules

The electrical/electronic equipment must be able to operate without problems within an electromagnetic environment. This is called immunity. The ACQ810 is designed to have adequate immunity against interference from other equipment. Likewise, the equipment must not disturb or interfere with any other product or system within its locality. This is called emission. Each ACQ810 model can be equipped with a built-in filter to reduce high frequency emission.

EMC standards

The EMC product standard EN 61800-3 (2004) covers the specific EMC requirements stated for drives (tested with motor and cable) within the EU.

EMC standards such as EN 55011 or EN 61000-6-3/4 are applicable to industrial and domestic equipment and systems including drive components inside. Drive units complying with requirements of EN 61800-3 are compliant with comparable categories in EN 55011 and EN 61000-6-3/4, but not necessarily vice versa. EN 55011 and EN 61000-6-3/4 do not specify cable length nor require a motor to be connected as a load. The emission limits are comparable according to the following EMC standards table.

EMC standards

EN61800-3 (2004) product standard	EN 55011, product family standard for industrial, scientific and medical (ISM) equipment	EN 61000-6-4, generic emission standard for industrial environments	EN 61000-6-3, generic emission standard for residential, commercial and light-industrial environment	1 st Vs 2 nd environment
Category C1 (1 st environment)	Group 1 Class B	Not applicable	Applicable	Directly connected, without intermediate transformer, to low-voltage power supply network for domestically purposed buildings
Category C2 (1 st environment)	Group 1 Class A	Applicable	Not applicable	
Category C3 (2 nd environment)	Group 2 Class A	Not applicable	Not applicable	All establishments other than those directly connected to a low-voltage power supply network for domestically purposed buildings
Category C4 (2 nd environment)	Not applicable	Not applicable	Not applicable	

Mains chokes

Mains chokes are typically used to reduce harmonics in the mains current. Frames C to G2 are equipped with built-in choke as standard. For frames A and B, the ACQ810 drives do not necessarily need a separate mains choke for operation. If, however, a separate mains choke is needed, mains chokes are available according to the tables on pages 22-27.

Low harmonic filters

A passive low harmonic filter is designed to decrease the Total Harmonic Distortion of incoming current (THDI) below 5%. The recommended filter type for the ACQ810 is the Schaffner ECOSINE™. These filters are dimensioned to achieve THDI requirement at nominal load. THDI increases at partial load and can be higher than 5% at no-load.

Low harmonic filters are not available for ACQ810-04-xxxx-2 drives. See pages 22-27 for specific low harmonic filter information per frame size.

Available filters and chokes

du/dt filters

du/dt filtering suppresses inverter output voltage spikes and rapid voltage changes that stress motor insulation.

Additionally, du/dt filtering reduces capacitive leakage currents and high frequency emission of the motor cable, as well as high frequency losses and bearing currents in the motor.

The need for du/dt filtering depends on the motor age and insulation. For information on the construction of the motor insulation, consult the motor manufacturer. If the motor does not fulfil the requirements of the filter selection table the lifetime of the motor might decrease. Insulated non-driven end (N-end) bearings and/or common mode filters are also required for motor bearing currents with motors bigger than 100 kW. For more information please see the ACQ810 hardware manual.

du/dt filter selection table

Motor type	Nominal mains voltage (U_N)	Motor insulation requirement
ABB M2 and M3 motors	$U_N \leq 500$ V	Standard insulation system.
ABB form-wound HXR and AM motors	380 V < $U_N \leq 500$ V	Standard insulation system.
ABB random-wound HXR and AM motors	380 V < $U_N \leq 500$ V	Check motor insulation system with the motor manufacturer.
Non-ABB random-wound and form-wound	$U_N \leq 420$ V	If the insulation system withstands $\hat{U}_{LL} = 1600$ V and $\Delta t = 0.2$ μ s, du/dt filtering is not required. With du/dt filtering the insulation system must withstand $\hat{U}_{LL} = 1300$ V.

U_N = Nominal mains voltage.

\hat{U}_{LL} = Peak line-to-line voltage at motor terminals.

Δt = Rise time, ie, interval during which line-to-line voltage at motor terminals changes from 10 to 90% of full voltage range.

External du/dt filters

ACQ810-04		du/dt filter type (3 filters included in kits marked *)															
		Unprotected (IP00)						Protected to IP22				Protected to IP54					
		NOCH0016-60	NOCH0030-60	NOCH0070-60	NOCH0120-60*	NOCH0260-60*	FOCH0260-70	FOCH0610-70	FOCH0875-70	NOCH0016-62	NOCH0030-62	NOCH0070-62	NOCH0120-62	NOCH0016-65	NOCH0030-65	NOCH0070-65	NOCH0120-65
230 V	400 V																
-02A7-2	-02A7-4	■							■					■			
	-03A0-4	■							■					■			
-03A5-2	-03A5-4	■							■					■			
-04A9-2	-04A9-4	■							■					■			
-06A3-2	-06A3-4	■							■					■			
-08A3-2	-08A3-4	■							■					■			
-11A0-2	-11A0-4	■							■					■			
-14A4-2	-14A4-4	■							■					■			
-021A-2	-021A-4		■							■					■		
-028A-2	-028A-4		■							■					■		
	-035A-4			■							■					■	
-040A-2	-040A-4			■							■					■	
-053A-2	-053A-4			■							■					■	
-067A-2	067A-4			■							■					■	
-080A-2	-080A-4				■							■					■
	-098A-4				■							■					■
	-138A-4				■							■					■
	-162A-4					■											
	-203A-4						■										
	-240A-4						■										
	-286A-4						■										
	-377A-4							■									
	-480A-4							■									
	-570A-4							■									
	-634A-4							■									
	-700A-4							■									
	-785A-4								■								
	-857A-4								■								

Dimensions

	mm	195	215	261	200	383	382	662	662	323	348	433	765	323	348	433	765
		in	7.7	8.5	10.3	7.9	15.1	15	26.1	26.1	12.7	13.7	17.1	30.1	12.7	13.7	17.1
Width	mm	140	165	180	154	185	340	319	319	199	249	279	308	199	249	279	308
	in	5.5	6.5	7.1	6.1	7.3	13.4	12.6	12.6	7.9	9.8	11	12.1	7.9	9.8	11	12.1
Depth	mm	115	130	150	106	111	254	282	292	154	172	202	256	154	172	202	256
	in	4.5	5.1	5.9	4.2	4.4	10	11.1	11.5	6	6.8	8	10	6	6.8	8	10
Weight	kg	2.4	4.7	9.5	7	12	47	65	65	6	9	15.5	45	6	9	15.5	45
	lb	5.28	10.34	20.9	15.4	26.4	103.4	143	143	13.2	19.8	34.1	99	13.2	19.8	34.1	99



Power range: 0.37 to 1.1 kW at 230 V, 1.1 to 3 kW at 400 V Frame A

Ratings, cooling characteristics and noise levels

P_N (kW)	I_{2N} (A)	I_{cont} (A)	I_{Max} (A)	Heat dissipation W	Air flow m ³ /h (ft ³ /min)	Noise level dBA	Type designation	Frame size
$U_N = 230 V$								
0.37	2.7	3	4.4	91	24 (14)	47	ACQ810-04-02A7-2	A
0.55	3.5	4.8	7.0	114	24 (14)	47	ACQ810-04-03A5-2	A
0.75	4.9	6	8.8	134	24 (14)	47	ACQ810-04-04A9-2	A
1.1	6.3	8	10.5	154	24 (14)	47	ACQ810-04-06A3-2	A
$U_N = 400 V$								
1.1	2.7	3	4.4	100	24 (14)	47	ACQ810-04-02A7-4	A
1.1	3	3.6	5.3	106	24 (14)	47	ACQ810-04-03A0-4	A
1.5	3.5	4.8	7.0	126	24 (14)	47	ACQ810-04-03A5-4	A
2.2	4.9	6	8.8	148	24 (14)	47	ACQ810-04-04A9-4	A
3	6.3	8	10.5	172	24 (14)	47	ACQ810-04-06A3-4	A

Nominal ratings

I_{2N} = 110% overload allowed for 1 minute every 5 minutes through the entire speed range.

I_{cont} = Continuous output current with no overload capacity.

I_{max} = Maximum output current. Available for 10 s at start, otherwise as long as allowed by drive temperature.

Note: The ratings apply at 40 °C ambient temperature.

EMC

EMC category/frame	Option code	Type
No EMC/RFI filter	+0E200	<input type="checkbox"/>
C2 filter, earthed network only ¹⁾		<input checked="" type="checkbox"/> ²⁾

= option, built-in = option, external JFI-02 filter — = not available

Notes:

¹⁾ Max. cable length 100 m (328 ft)

²⁾ External accessory, no plus code, MRP order code 68711321

Low harmonic filters

Frame size	Drive type designation	Nominal ratings P (kW)	Filter 400 V/50 Hz	Dimensions			
				Height mm	Depth mm	Width mm	Weight kg
A	ACQ810-04-02A7-4	1.1	*	-	-	-	-
A	ACQ810-04-03A5-4	1.5		-	-	-	-
A	ACQ810-04-04A9-4	2.2		-	-	-	-

* Smallest filter is for power 4 kW. This filter can be used at lower power, but the THD of the line current will increase.

Mains chokes

Frame size	Drive type designation	Type	Inductance μH	Dimensions						Weights	
				Width		Length		Depth		kg	lb
				mm	in	mm	in	mm	in		
A	ACQ810-04-02A7-2/4	CHK-01	6370	120	4.72	146	5.75	79	3.11	1.8	4.0
A	ACQ810-04-03A0-4	CHK-01	6370	120	4.72	146	5.75	79	3.11	1.8	4.0
A	ACQ810-04-03A5-2/4	CHK-01	6370	120	4.72	146	5.75	79	3.11	1.8	4.0
A	ACQ810-04-04A9-2/4	CHK-02	4610	150	5.91	175	6.89	86	3.39	3.8	8.4
A	ACQ810-04-06A3-2/4	CHK-02	4610	150	5.91	175	6.89	86	3.39	3.8	8.4
A	ACQ810-04-08A3-2/4	CHK-03	2700	150	5.91	175	6.89	86	3.39	3.8	8.4

Dimensions and weight

Height ³⁾ mm	Depth ⁴⁾ mm	Width mm	Weight kg
364 (518)	219	94	3.2

Notes: All dimensions and weights are without additional options.

³⁾ Height is the maximum measure without clamping plates.

In A and B frames the external C3 EMC-filter (height with filter in brackets).

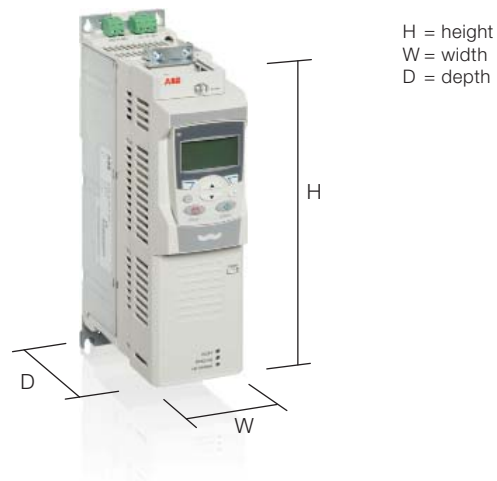

Power range: 1.5 to 3 kW at 230 V, 4 to 7.5 kW at 400 V Frame B

Ratings, cooling characteristics and noise levels

P_N (kW)	I_{2N} (A)	I_{cont} (A)	I_{Max} (A)	Heat dissipation W	Air flow m ³ /h (ft ³ /min)	Noise level dBA	Type designation	Frame size
$U_N = 230 V$								
1.5	8.3	10.5	13.5	183	48 (28)	39	ACQ810-04-08A3-2	B
2.2	11	14	16.5	215	48 (28)	39	ACQ810-04-11A0-2	B
3	14.4	18	21	274	48 (28)	39	ACQ810-04-14A4-2	B
$U_N = 400 V$								
4	8.3	10.5	13.5	212	48 (28)	39	ACQ810-04-08A3-4	B
5.5	11	14	16.5	250	48 (28)	39	ACQ810-04-11A0-4	B
7.5	14.4	18	21	318	48 (28)	39	ACQ810-04-14A4-4	B

Nominal ratings

I_{2N} = 110% overload allowed for 1 minute every 5 minutes through the entire speed range.

I_{cont} = Continuous output current with no overload capacity.

I_{max} = Maximum output current. Available for 10 s at start, otherwise as long as allowed by drive temperature.

Note: The ratings apply at 40 °C ambient temperature.

EMC

EMC category/frame	Option code	Type
No EMC/RFI filter	+0E200	<input type="checkbox"/>
C2 filter, earthed network only ¹⁾		<input checked="" type="checkbox"/> ²⁾

= option, built-in = option, external JFI-03 filter — = not available

Notes:

¹⁾ Max. cable length 100 m (328 ft)

²⁾ External accessory, no plus code, MRP order code 68711339

Low harmonic filters

Frame size	Drive type designation	Nominal ratings P (kW)	Filter 400 V/50 Hz	Dimensions			
				Height mm	Depth mm	Width mm	Weight kg
B	ACQ810-04-08A3-4	4	FN 3410-10-44	400	170	190	13
B	ACQ810-04-11A0-4	5.5	FN 3410-13-44	400	170	190	14
B	ACQ810-04-14A4-4	7.5	FN 3410-16-44	430	210	210	21

Mains chokes

Frame size	Drive type designation	Type	Inductance μH	Dimensions						Weights	
				Width		Length		Depth		kg	lb
				mm	in	mm	in	mm	in		
B	ACQ810-04-11A0-2/4	CHK-03	2700	150	5.91	175	6.89	100	3.39	5.4	11.9
B	ACQ810-04-14A4-2/4	CHK-04	1475	150	5.91	175	6.89	100	3.39	5.4	11.9

Dimensions and weight

Height ³⁾ mm	Depth ⁴⁾ mm	Width mm	Weight kg
380 (542)	297	101	5.4

Notes: All dimensions and weights are without additional options.

³⁾ Height is the maximum measure without clamping plates.

In A and B frames the external C3 EMC-filter (height with filter in brackets).

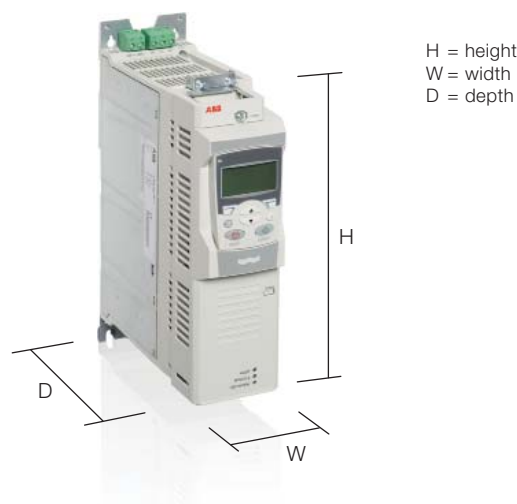

Power range: 5.5 to 11 kW at 230 V, 11 to 22 kW at 400 V

Frame C

Ratings, cooling characteristics and noise levels

P_N (kW)	I_{2N} (A)	I_{cont} (A)	I_{Max} (A)	Heat dissipation W	Air flow m ³ /h (ft ³ /min)	Noise level dBA	Type designation	Frame size
$U_N = 230 V$								
5.5	21	25	33	325	142 (84)	71	ACQ810-04-021A-2	C
7.5	28	30	36	421	142 (84)	71	ACQ810-04-028A-2	C
11	40	50	66	555	200 (118)	71	ACQ810-04-040A-2	C
$U_N = 400 V$								
11	21	25	33	375	142 (84)	71	ACQ810-04-021A-4	C
15	28	30	36	485	142 (84)	71	ACQ810-04-028A-4	C
18.5	35	44	53	541	200 (118)	71	ACQ810-04-035A-4	C
22	40	50	66	646	200 (118)	71	ACQ810-04-040A-4	C

Nominal ratings

I_{2N} =	110% overload allowed for 1 minute every 5 minutes through the entire speed range.
I_{cont} =	Continuous output current with no overload capacity.
I_{max} =	Maximum output current. Available for 10 s at start, otherwise as long as allowed by drive temperature.

Note: The ratings apply at 40 °C ambient temperature.

EMC

EMC category/frame	Option code	Type
No EMC/RFI filter	+0E200	□
C2 filter, earthed network only ¹⁾		■ ²⁾

□ = option, built-in ■ = option, external JFI-05 filter – = not available

Notes:

¹⁾ Max. cable length 100 m (328 ft)

²⁾ External accessory, no plus code, MRP order code 68711355

Low harmonic filters

Frame size	Drive type designation	Nominal ratings P (kW)	Filter 400 V/50 Hz	Dimensions			
				Height mm	Depth mm	Width mm	Weight kg
C	ACQ810-04-021A-4	11	FN 3410-24-33	520	250	280	27
C	ACQ810-04-028A-4	15	FN 3410-32-33	520	250	280	31
C	ACQ810-04-035A-4	18.5	FN 3410-38-33	520	250	280	35
C	ACQ810-04-040A-4	22	FN 3410-45-34	590	300	300	45

Mains chokes

Frame size	Drive type designation	Type	Inductance μH	Dimensions						Weights	
				Width		Length		Depth		kg	lb
				mm	in	mm	in	mm	in		
C	ACQ810-04-021A-2/4	Internal choke as standard									
C	ACQ810-04-028A-2/4										
C	ACQ810-04-035A-4										
C	ACQ810-04-040A-2/4										

Dimensions and weight

Height ³⁾ mm	Depth ⁴⁾ mm	Width mm	Weight kg
567	298	166	15.6

Notes: All dimensions and weights are without additional options.

³⁾ Height is the maximum measure without clamping plates.

EMC-filter is internal in frames C, D, E0, E, G1 and G2.

⁴⁾ Total depth with control panel

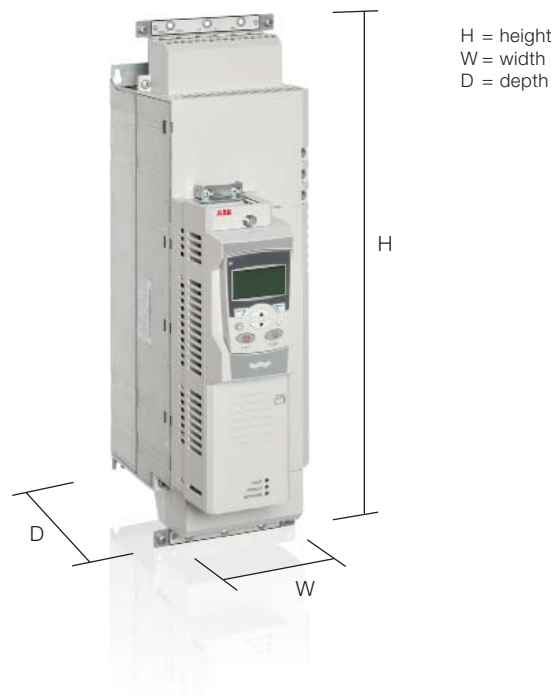

Power range: 15 to 22 kW at 230 V, 30 to 45 kW at 400 V

Frame D

Ratings, cooling characteristics and noise levels

P_N (kW)	I_{2N} (A)	I_{cont} (A)	I_{Max} (A)	Heat dissipation W	Air flow m ³ /h (ft ³ /min)	Noise level dBA	Type designation	Frame size
$U_N = 230 V$								
15	53	61	78	730	290 (171)	70	ACQ810-04-053A-2	D
18.5	67	78	100	889	290 (171)	70	ACQ810-04-067A-2	D
22	80	94	124	1054	290 (171)	70	ACQ810-04-080A-2	D
$U_N = 400 V$								
30	53	61	78	840	290 (171)	70	ACQ810-04-053A-4	D
37	67	78	100	1020	290 (171)	70	ACQ810-04-067A-4	D
45	80	94	124	1200	290 (171)	70	ACQ810-04-080A-4	D

Nominal ratings

I_{2N} = 110% overload allowed for 1 minute every 5 minutes through the entire speed range.

I_{cont} = Continuous output current with no overload capacity.

I_{max} = Maximum output current. Available for 10 s at start, otherwise as long as allowed by drive temperature.

Note: The ratings apply at 40 °C ambient temperature.

EMC

EMC category/frame	Option code	Type
No EMC/RFI filter	+0E200	—
C2 filter, earthed network only ¹⁾		■ ²⁾

□ = option, built-in ■ = option, external JFI-05 filter – = not available

Notes:

¹⁾ Max. cable length 100 m (328 ft)

²⁾ External accessory, no plus code, MRP order code 68711371

Low harmonic filters

Frame size	Drive type designation	Nominal ratings P (kW)	Filter 400 V/50 Hz	Dimensions			
				Height mm	Depth mm	Width mm	Weight kg
D	ACQ810-04-053A-4	30	FN 3410-60-34	590	300	300	54
D	ACQ810-04-067A-4	37	FN 3410-75-35	750	320	300	65
D	ACQ810-04-080A-4	45	FN 3410-90-35	750	320	300	77

Mains chokes

Frame size	Drive type designation	Type	Inductance μH	Dimensions						Weights	
				Width		Length		Depth		kg	lb
				mm	in	mm	in	mm	in		
D	ACQ810-04-053A-2/4										
D	ACQ810-04-067A-2/4										
D	ACQ810-04-080A-2/4										

Internal choke as standard

Dimensions and weight

Height ³⁾ mm	Depth ⁴⁾ mm	Width mm	Weight kg
567	298	221	21.3

Notes: All dimensions and weights are without additional options.

³⁾ Height is the maximum measure without clamping plates.
EMC-filter is internal in frames C, D, E0, E, G1 and G2.

⁴⁾ Total depth with control panel

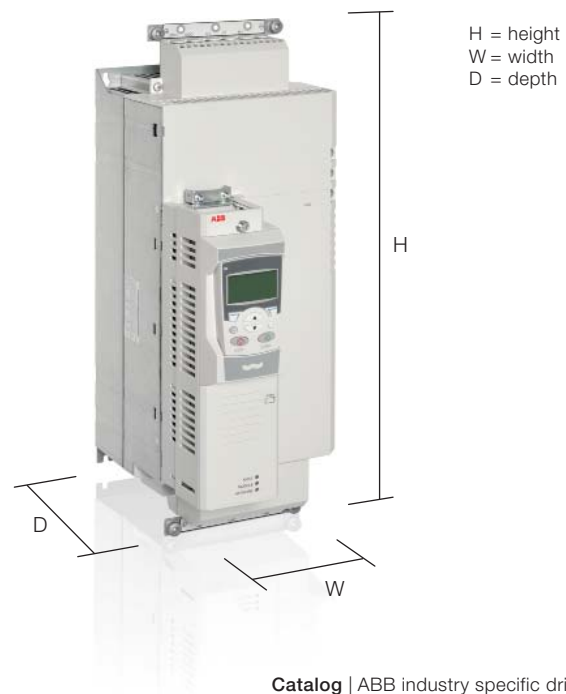

Power range: 55 to 160 kW at 400 V

Frame E0/E

Ratings, cooling characteristics and noise levels

P_N (kW)	I_{2N} (A)	I_{cont} (A)	I_{Max} (A)	Heat dissipation W	Air flow m ³ /h (ft ³ /min)	Noise level dBA	Type designation	Frame size
$U_N = 400\text{ V}$								
55	98	103	138	1190	168 (99)	65	ACQ810-04-098A-4	E0
75	138	144	170	1440	405 (238)	65	ACQ810-04-138A-4	E0
90	162	202	282	2310	405 (238)	65	ACQ810-04-162A-4	E
110	203	225	326	2810	405 (238)	65	ACQ810-04-203A-4	E
132	240	260	326	3260	405 (238)	65	ACQ810-04-240A-4	E
160	286	290	348	4200	405 (238)	65	ACQ810-04-286A-4	E

Nominal ratings

P_N	= Typical motor power.
I_{2N}	= 110% overload allowed for 1 minute every 5 minutes through the entire speed range.
I_{cont}	= Continuous output current with no overload capacity.
I_{max}	= Maximum output current. Available for 10 s at start, otherwise as long as allowed by drive temperature.

Note: The ratings apply at 40 °C ambient temperature.

EMC

EMC category/frame	Option code	Type
No EMC/RFI filter	+0E200	<input type="checkbox"/>
C2 filter, earthed network only ¹⁾	+E202	<input type="checkbox"/>

= option, built-in = option, external - = not available

Notes:

¹⁾ Max. cable length 100 m (328 ft)

Low harmonic filters

Frame size	Drive type designation	Nominal ratings P (kW)	Filter 400 V/50 Hz	Dimensions			
				Height mm	Depth mm	Width mm	Weight kg
E0	ACQ810-04-098A-4	55	FN 3410-110-35	750	320	300	86
E0	ACQ810-04-138A-4	75	FN 3410-150-40	950	450	420	118
E	ACQ810-04-162A-4	90	FN 3410-180-40	950	450	420	136
E	ACQ810-04-203A-4	110	FN 3410-210-40	950	450	420	154
E	ACQ810-04-240A-4	132	FN 3410-260-99	1000	500	450	201
E	ACQ810-04-286A-4	160	2×FN 3410-180-40	950 *	450 *	420 *	136 *

* = per one filter

Mains chokes

Frame size	Drive type designation	Type	Inductance μH	Dimensions						Weights	
				Width		Length		Depth		kg	lb
				mm	in	mm	in	mm	in		
E0	ACQ810-04-098A-4	Internal choke as standard									
E0	ACQ810-04-138A-4										
E	ACQ810-04-162A-4										
E	ACQ810-04-203A-4										
E	ACQ810-04-240A-4										
E	ACQ810-04-286A-4										

Dimensions and weights

Frame size	Height ³⁾ mm	Depth ⁴⁾ mm	Width mm	Weight kg
E0	602	376	276	34
E	700	465	312	67

Notes: All dimensions and weights are without additional options.

³⁾ Height is the maximum measure without clamping plates.

EMC-filter is internal in frames C, D, E0, E, G1 and G2.

⁴⁾ Total depth with control panel

H = height
W = width
D = depth



Power range: 200 to 500 kW at 400 V

Frame G1/G2

Ratings, cooling characteristics and noise levels

P_N (kW)	I_{2N} (A)	I_{cont} (A)	I_{Max} (A)	Heat dissipation W	Air flow m ³ /h (ft ³ /min)	Noise level dBA	Type designation	Frame size
$U_N = 400 V$								
200	377	387	470	4403	1200 (708)	72*	ACQ810-04-377A-4	G1
250	480	500	560	5602	1200 (708)	72*	ACQ810-04-480A-4	G1
315	570	580	680	6409	1200 (708)	72*	ACQ810-04-570A-4	G1
355	634	650	730	8122	1200 (708)	72*	ACQ810-04-634A-4	G1
400	700	710	850	8764	1200 (708)	72*	ACQ810-04-700A-4	G2
450	785	807	1020	9862	1200 (708)	72*	ACQ810-04-785A-4	G2
500	857	875	1100	10578	1420 (838)	71*	ACQ810-04-857A-4	G2

Nominal ratings

P_N =	Typical motor power.
I_{2N} =	110% overload allowed for 1 minute every 5 minutes through the entire speed range.
I_{cont} =	Continuous output current with no overload capacity.
I_{max} =	Maximum output current. Available for 10 s at start, otherwise as long as allowed by drive temperature.

Note: The ratings apply at 40 °C ambient temperature.

EMC

EMC category/frame	Option code	Type
C2 filter, earthed network only ¹⁾	+E202	-

□ = option, built-in ■ = option, external – = not available

Notes:

¹⁾ Max. cable length 100 m (328 ft)

Low harmonic filters

Frame size	Drive type designation	Nominal ratings P (kW)	Filter 400 V/50 Hz	Dimensions			
				Height mm	Depth mm	Width mm	Weight kg
G1	ACQ810-04-377A-4	200	2×FN 3410-210-40	950 *	450 *	420 *	154 *
G1	ACQ810-04-480A-4	250	2×FN 3410-260-99	1000 *	500 *	450 *	201 *
G1	ACQ810-04-570A-4	315	3×FN 3410-210-40	950 *	450 *	420 *	154 *
G1	ACQ810-04-634A-4	355	3×FN 3410-260-99	1000 *	500 *	450 *	201 *
G2	ACQ810-04-700A-4	400	3×FN 3410-260-99	1000 *	500 *	450 *	201 *
G2	ACQ810-04-785A-4	450	3×FN 3410-320-99	1000 *	500 *	450 *	210 *
G2	ACQ810-04-857A-4	500	3×FN 3410-320-99	1000 *	500 *	450 *	210 *

* = per one filter

Mains chokes

Frame size	Drive type designation	Type	Inductance μH	Dimensions						Weights	
				Width		Length		Depth		kg	lb
				mm	in	mm	in	mm	in		
G1	ACQ810-04-377A-4	Internal choke as standard									
G1	ACQ810-04-480A-4										
G1	ACQ810-04-570A-4										
G1	ACQ810-04-634A-4										
G2	ACQ810-04-700A-4										
G2	ACQ810-04-785A-4										
G2	ACQ810-04-857A-4										



Dimensions and weights

Frame size	Height ³⁾ mm	Depth ⁴⁾ mm	Width mm	Weight kg
G1	1462 (1560) ⁴⁾	505 (515) ⁴⁾	305 (329) ⁴⁾	161 (191) ⁴⁾
G2	1662 (1710) ⁴⁾	505 (515) ⁴⁾	305 (329) ⁴⁾	199 (229) ⁴⁾

Notes: All dimensions and weights are without additional options.

²⁾ Height is the maximum measure without clamping plates.

EMC-filter is internal in frames C, D, E0, E, G1 and G2.

³⁾ Total depth with control panel

⁴⁾ With +H381 optional cabling panel

The ACQ810 G1 and G2 frames have some useful optional features. For ordering codes and description see the table below.

Options	Description
+H381	Power cabling panels
+P905	Integrated control unit

Control panel

Assistant control panel

The assistant control panel features a multilingual alphanumeric display for easy drive configuration. It is an ideal tool for service engineers, providing the following features:

- A large alphanumeric display
- Easy navigation
- Soft and convenient keys
- Local control keys (start/stop/reference)
- Parameter setting and monitoring
- Status and history data
- Real-time clock

Assisting functionalities:

- Startup assistant
- Maintenance assistant
- Diagnostic assistant



Assistant control panel

Assistant control panel options

There are various cover assembly options for the ACQ810. The cover is mounted on the drive depending on the specific need of the customer application.

Standard control unit cover

Includes control panel and control unit front cover.

No control panel or panel holder (+0J400)

No control panel is delivered with the drive.

No control unit cover (+0C168)

Only available if +0J400 is selected.

Door mounting kit with assistant control panel (+J410)

Includes the assistant control panel and a panel holder for cabinet door mounting, with IP54 kit and 3 m (10 ft) cable.



Standard control unit cover with assistant control panel



Door mounting kit with assistant control panel (+J410)



No control panel or panel holder (+0J400)

Flexible connectivity to automation networks

Fieldbus adapter modules enable communication between drives, systems, devices, and software. Our drives for water and wastewater are compatible with a wide range of fieldbus protocols.

The plug-in fieldbus adapter module can be mounted inside the drive. Another benefit is reduced wiring costs when compared with traditional input/output connections. Fieldbus systems are also less complex than conventional systems, which results in less overall maintenance.

Drive monitoring

A set of drive parameters and/or actual signals such as torque, speed, current, etc., can be selected for cyclic data transfer, providing fast data access.

Drive diagnostics

Accurate and reliable diagnostic information can be obtained through the alarm, limit and fault words.

Drive parameter handling

The Ethernet fieldbus adapter module allows you to build an Ethernet network for drive monitoring and diagnostic and parameter handling purposes.

Cabling

Substituting the large amount of conventional drive control cabling and wiring with a single cable reduces costs and increases system reliability and flexibility.

Design

The use of fieldbus control reduces engineering time at installation due to the modular structure of the hardware and software and the simplicity of the connections to the drives.

Commissioning and assembly

The modular machine configuration allows pre-commissioning of single machine sections and provides easy and fast assembly of the complete installation.

Universal communication

The ACQ810 supports the following fieldbus protocols and I/O extensions:

Option	Option code	Description
Analog and digital extension modules		
FIO-01	+L501	4 × DI/O, 2 × RO
FIO-11	+L500	3 × AI (mA/V), 1 × AO (mA), 2 × DI/O
FIO-21	+L519	1 × AI (mA/V), 1 × AO (mA), 1 × DI, 2 × RO
FIO-31	+L511	4 × RO
Fieldbus adapter modules		
FPBA-01	+K454	PROFIBUS DP, DPV0/DPV1
FDNA-01	+K451	DeviceNet™
FENA-11	+K473	EtherNet/IP™, Modbus TCP, PROFINET IO
FSCA-01	+K458	Modbus RTU
FLON-01	+K452	LonWorks®



Remote monitoring and PC tools

SREA-01 enables remote access

With drives increasingly being installed in remote locations, it is vital that operational and process data is monitored locally in real time and transmitted to a central location for analysis. The SREA-01 Ethernet adapter performs all these remote access tasks.

Designed as an optional remote interface module for the drives, the SREA-01 can send process data, data logs and event messages independently, without a PLC or a dedicated on-site computer and has an internal web server for configuration and drive access.

Connecting multiple drives to an Ethernet or GPRS network

In addition to a standard Ethernet port, the SREA-01 has a serial port for connection to a standard GSM/GPRS modem for Internet connectivity in isolated places. The modem connection enables sending e-mail or SMS messages, uploading data files by FTP, or accessing the SREA-01 web pages.

The SREA-01 is connected to the panel port, or alternatively to the Modbus interface, of a drive. A maximum of 10 drives can be connected to a single SREA-01 module over Ethernet or EIA-485 serial communication networks. Simultaneous use of the two connection methods is possible, allowing access to different types of drives. In addition, Modbus TCP commands from a PLC to a drive are supported in the remote monitoring mode.

Collecting data logs and integrating drive data in SCADA applications

For collecting data from the drive, process or data analysis, the SREA-01 has a configurable data logger that can store values from the devices to a file with sample intervals between ten seconds and one hour. The files are stored internally for visualization with a web browser. Data in standard comma separated values (CSV) file format can be imported to applications such as Microsoft Excel for processing.

Receiving event messages and alarms and accessing the drive remotely

At any time, the internal web server of the SREA-01 provides an intuitive user interface for accessing the drives. Travel to sites can often be avoided by using a standard web browser to view and change the drive parameters, monitor the status of all connected devices, and browse the actual faults or history of the installation.

DriveStudio

User-friendly PC tool for quick drive startup, drive tuning and advanced programming tasks.

- Fast parameter navigation
- Parameter setting
- Data logging and online drive signal monitoring of multiple signal channels for drive tuning
- Backup and restore tool for drive parameter and DriveSPC program cloning
- Case sensitive help with detailed descriptions of drive parameters, events and functions
- Overview of the drive performance and status

DriveSPC

DriveSPC is a programming tool that enables modification and extension of existing drive functionality:

- Simple-to-learn function block interface showing drive firmware functions, signals and parameters
- Easy to add user-defined function block programs even on the fast time levels of the drive control
- Function block programming with standard IEC61131 function block library
- Professional programming environment with hierarchy levels, custom circuits, user parameters and copy protection of DriveSPC programs



Taking care of your drives, caring about your business

Whether a drive is a part of the product you sell or a component in your production process, reliable and efficient drive operation is key. Our global life cycle services are designed to ensure that the drives keep running exactly as you expect, wherever they are.

You will find support from your first meeting with ABB to the drive installation, commissioning and maintenance, all the way up to the eventual drive replacement and recycling. With offices in over 90 countries, we are well placed to offer you technical advice and local support.

Installation and commissioning

We offer accurate advice and timely support before and during installation. ABB-certified engineers or third-party channel companies can adjust the drive parameters to meet the precise demands of the application.

ABB drive care contract

Through this service contract the full range of services are offered to you at a fixed price. Our service contract is designed to satisfy your most demanding requirements, ranging from technical support to maintenance and repairs.



Extended warranty

30 or 42 month from delivery warranty options are available to reduce risks associated with drives failure and to allow users to recover from equipment failures as quickly as possible. Services are provided at a fixed cost and standard warranty terms and conditions applied.

Extended warranty from delivery	Option code
Warranty 30 months	+P904
Warranty 42 months	+P909

Combine the benefits of premium motor control and Synchronous reluctance technology

Energy efficiency

Motors meet IE4 efficiency levels and offers excellent partial load efficiency performance for all pumping applications.

Reliability

No permanent magnets and no cage mean less points of failure and less downtime. Unprecedented reliability through very low winding and bearing temperatures.



Footprint

Replace standard induction motors with a SynRM motor; the same power and size combinations available are available with no mechanical or footprint modifications.

Maintain with ease

Service procedures comparable to induction motors.

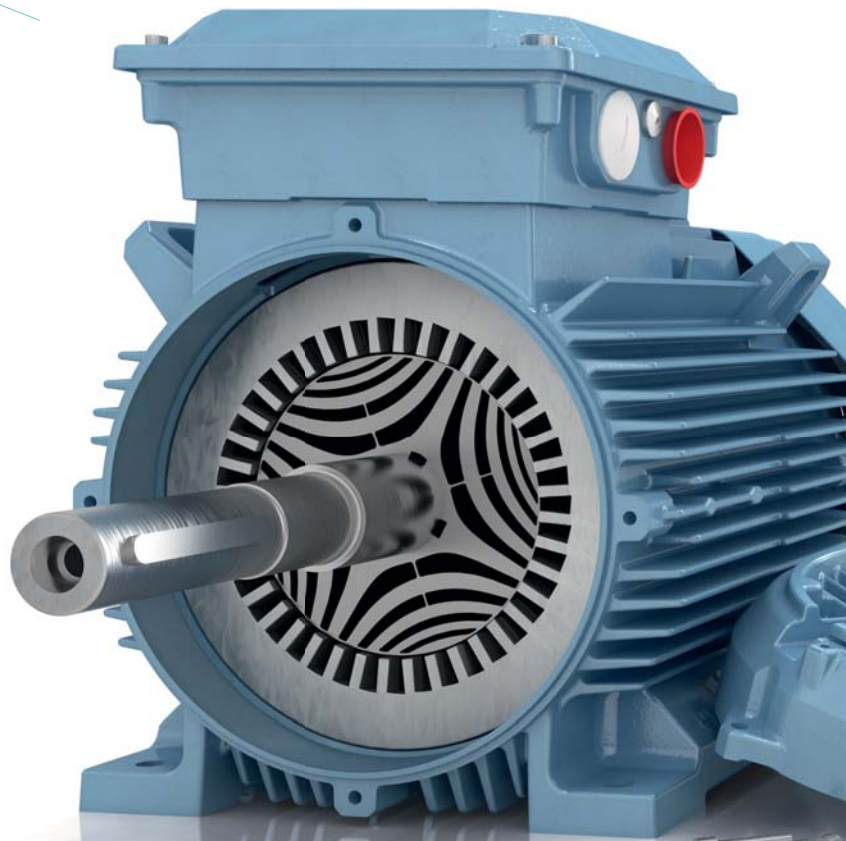

Synchronous reluctance motors provide the water industry advantages of permanent magnet motors together with the cost-efficiency, simplicity and service-friendliness of an induction motor.

Excellent control performance

Sensorless synchronous motor control provides precise speed control with torque control over the whole speed range.



Packaged efficiency

The motor and drive's efficiency levels are verified as a package, ensuring high system level efficiencies.

Proven sourcing

Variant codes and mechanical construction based on the proven M3BP cast iron process performance motors – conventional yet innovative.



Ultimate efficiency and reliability to optimize your pump system cost of ownership



Traditional IE2 induction motor



IE4 SynRM motor

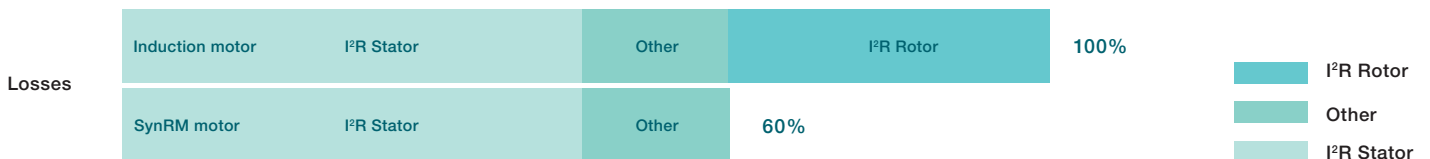

Innovation inside

The idea is simple. Take a conventional, proven stator technology and a totally new, innovative rotor design. Then combine them with a dedicated water industry drive loaded with new, application-designed software. Finally, optimize the whole package for pumping applications.

Magnet-free design

Synchronous reluctance technology combines the performance of the permanent magnet motor with the simplicity and service-friendliness of an induction motor. The new rotor has neither magnets nor windings and suffers virtually no power losses. And because of identical footprints, maintenance is as straightforward as with induction motors.

Superior reliability to minimize the cost of not running

IE4 synchronous reluctance motors have very low winding temperatures, which increases the reliability and lifetime of the winding. More importantly, the cool synchronous reluctance rotor means significantly lower bearing temperatures – an important factor because bearing failures cause about 70 percent of unplanned motor outages.



Selection guide

IE4 synchronous reluctance motors

This table presents technical performance data for IE4 SynRM motors. Variant codes and construction details are based on the M3BP motor. Protection IP55, cooling IC 411, insulation class F, temperature rise class B. Motor values are given with an ACQ810 VSD supply.

Output kW	Motor type			Product code	Speed n_N r/min	Frequency f_{el} Hz	Motor Efficiency with VSD supply	Current I_N A	Torque T_N Nm	Torque $T_{OL}/$ T_N	Max speed n_{max} r/min	Inertia J kgm ²	Weight m kg	Suggested ACQ810 frequency converter for no overload pump use*
3000 r/min					400 V network									
11	M3BL	160	MLA 4	3GBL 162 101-_SC	3000	100	92.6	25.0	35	1.5	4200	0.0579	133	ACQ810-04-021A-4
15	M3BL	160	MLB 4	3GBL 162 102-_SC	3000	100	93.3	34.8	48	1.5	4200	0.0579	133	ACQ810-04-035A-4
18.5	M3BL	160	MLC 4	3GBL 162 103-_SC	3000	100	93.7	42.8	59	1.5	4200	0.0579	133	ACQ810-04-035A-4
22	M3BL	180	MLA 4	3GBL 182 101-_SC	3000	100	94.0	50.0	70	1.5	4200	0.0702	160	ACQ810-04-040A-4
30	M3BL	200	MLA 4	3GBL 202 101-_SC	3000	100	94.5	68.8	95	1.5	4200	0.207	259	ACQ810-04-067A-4
37	M3BL	200	MLB 4	3GBL 202 102-_SC	3000	100	94.8	84.6	118	1.5	4200	0.207	259	ACQ810-04-080A-4
45	M3BL	225	SMA 4	3GBL 222 101-_SC	3000	100	95.0	103	143	1.5	4200	0.242	282	ACQ810-04-098A-4
55	M3BL	225	SMF 4	3GBL 222 102-_SC	3000	100	95.3	122	175	1.5	4200	0.242	282	ACQ810-04-138A-4
1500 r/min					400 V network									
11	M3BL	160	MLA 4	3GBL 162 104-_SC	1500	50	93.3	24.9	70	1.5	2100	0.0702	160	ACQ810-04-021A-4
15	M3BL	160	MLB 4	3GBL 162 105-_SC	1500	50	93.9	33.7	95	1.5	2100	0.0864	177	ACQ810-04-035A-4
18.5	M3BL	180	MLA 4	3GBL 182 102-_SC	1500	50	94.2	42.0	118	1.5	2100	0.0864	177	ACQ810-04-035A-4
22	M3BL	200	MLF 4	3GBL 202 106-_SC	1500	50	94.5	49.1	140	1.5	2100	0.287	304	ACQ810-04-040A-4
30	M3BL	200	MLA 4	3GBL 202 103-_SC	1500	50	94.9	66.7	191	1.5	2100	0.287	304	ACQ810-04-067A-4
37	M3BL	250	SMF 4	3GBL 252 104-_SC	1500	50	95.2	82.0	236	1.5	2100	0.575	428	ACQ810-04-080A-4
45	M3BL	250	SMG 4	3GBL 252 105-_SC	1500	50	95.4	99.5	286	1.5	2100	0.575	428	ACQ810-04-098A-4
55	M3BL	250	SMA 4	3GBL 252 102-_SC	1500	50	95.7	121	350	1.5	2100	0.633	454	ACQ810-04-138A-4
75	M3BL	280	SMA 4	3GBL 282 213-_DC	1500	50	96.0	173	478	1.7	2100	1.00	639	ACQ810-04-162A-4
90	M3BL	280	SMB 4	3GBL 282 223-_DC	1500	50	96.1	202	573	1.7	2100	1.00	639	ACQ810-04-162A-4
110	M3BL	280	SMC 4	3GBL 282 233-_DC	1500	50	96.3	245	699	1.8	2100	1.21	697	ACQ810-04-240A-4
110	M3BL	315	SMA 4	3GBL 312 213-_DC	1500	50	96.3	244	702	1.8	1800	1.64	873	ACQ810-04-240A-4
132	M3BL	315	SMB 4	3GBL 312 223-_DC	1500	50	96.4	290	842	1.9	1800	1.87	925	ACQ810-04-286A-4
160	M3BL	315	SMC 4	3GBL 312 233-_DC	1500	50	96.6	343	1018	1.7	1800	2.04	965	ACQ810-04-377A-4
200	M3BL	315	MLA 4	3GBL 312 413-_DC	1500	50	96.7	427	1272	1.7	1800	2.45	1116	ACQ810-04-480A-4
250	M3BL	315	LKA 4	3GBL 312 813-_DC	1500	50	96.7	542	1591	1.8	1800	3.04	1357	ACQ810-04-570A-4
315	M3BL	315	LKC 4	3GBL 312 833-_DC	1500	50	96.7	650	2006	1.6	1800	3.77	1533	ACQ810-04-634A-4
1000 r/min					400 V network									
7.5	M3BL	160	MLA 4	3GBL 162 106-_SC	1000	33.3	91.3	17.3	72	1.5	1400	0.0702	160	ACQ810-04-14A4-4
11	M3BL	160	MLB 4	3GBL 162 107-_SC	1000	33.3	92.3	25.0	105	1.5	1400	0.0864	177	ACQ810-04-021A-4
15	M3BL	200	MLF 4	3GBL 202 107-_SC	1000	33.3	92.9	34.0	143	1.5	1400	0.242	282	ACQ810-04-035A-4
18.5	M3BL	200	MLA 4	3GBL 202 104-_SC	1000	33.3	93.4	41.8	177	1.5	1400	0.287	304	ACQ810-04-035A-4
22	M3BL	200	MLB 4	3GBL 202 105-_SC	1000	33.3	93.7	49.5	210	1.5	1400	0.287	304	ACQ810-04-040A-4
30	M3BL	250	SMF 4	3GBL 252 106-_SC	1000	33.3	94.2	67.2	286	1.5	1400	0.499	391	ACQ810-04-067A-4
37	M3BL	250	SMA 4	3GBL 252 103-_SC	1000	33.3	94.5	82.6	353	1.5	1400	0.575	428	ACQ810-04-080A-4
45	M3BL	280	SMA 4	3GBL 282 212-_DC	1000	33.3	94.8	103	430	1.9	1400	1.00	639	ACQ810-04-098A-4
55	M3BL	280	SMB 4	3GBL 282 222-_DC	1000	33.3	95.1	123	526	1.7	1400	1.00	639	ACQ810-04-138A-4
75	M3BL	280	SMC 4	3GBL 282 232-_DC	1000	33.3	95.4	166	715	1.8	1400	1.21	697	ACQ810-04-162A-4
75	M3BL	315	SMA 4	3GBL 312 212-_DC	1000	33.3	95.4	166	717	1.8	1400	1.64	873	ACQ810-04-162A-4
90	M3BL	315	SMB 4	3GBL 312 222-_DC	1000	33.3	95.6	198	859	1.8	1400	1.87	925	ACQ810-04-162A-4
110	M3BL	315	SMC 4	3GBL 312 232-_DC	1000	33.3	95.8	241	1051	1.7	1400	2.04	965	ACQ810-04-240A-4
132	M3BL	315	MLA 4	3GBL 312 412-_DC	1000	33.3	96.0	279	1261	1.6	1400	2.45	1116	ACQ810-04-286A-4
160	M3BL	315	LKA 4	3GBL 312 812-_DC	1000	33.3	96.2	340	1527	1.7	1400	3.04	1357	ACQ810-04-377A-4
200	M3BL	315	LKC 4	3GBL 312 832-_DC	1000	33.3	96.3	418	1910	1.7	1400	3.77	1533	ACQ810-04-480A-4

* Rated current available continuously without overloading at 40 °C.

Consult ABB for motor and drive dimensioning for applications with other load characteristics.

Notes

A series of horizontal dotted lines for taking notes.

Contact us

For more information please contact your local ABB representative or visit:

www.abb.com/drives

www.abb.com/drivespartners

© Copyright 2014 ABB. All rights reserved.
Specifications subject to change without notice.



ACQ810 web page

3AUA0000160101 REV A EN 22.4.2014 #16947