ABB general purpose drive

ACS530 standard control program

Firmware manual



Related documents are listed on page [12](#).



Table of contents

**ACS530
Standard control
program**

Firmware manual

1. Introduction to the manual

2. Control panel

3. Application macros

4. Function description

5. Parameter data

6. Parameter

7. Fieldbus control

8. Fault tracing

9. Control chain diagrams

Table of contents

1. Introduction to the manual

| | |
|-----------------------------|----|
| What this chapter contains | 11 |
| Applicability | 11 |
| Target audience | 11 |
| Purpose of the manual | 11 |
| Contents of the manual | 12 |
| Related documents | 12 |
| Network Security Disclaimer | 15 |

2. Control panel

| | |
|---------------------------------------|----|
| Applicability | 17 |
| Safety | 17 |
| Related manuals | 17 |
| Attach and remove the control panel | 18 |
| Start up | 18 |
| Control panel use | 19 |
| Display | 19 |
| Options menu | 20 |
| Start and stop the drive | 20 |
| Change the rotation direction | 20 |
| Set the speed or frequency reference | 21 |
| Set the drive parameters | 22 |
| Open Diagnostics | 22 |
| Backup | 23 |
| “Main” menu | 24 |
| Submenus | 25 |
| Fault and warning messages | 28 |
| Drive and panel communication failure | 28 |
| Status light | 28 |

3. Application macros

| | |
|---------------------------------------------------------------|----|
| What this chapter contains | 29 |
| Get an Overview | 29 |
| ABB standard macro | 30 |
| Default control connections for the ABB standard macro | 31 |
| 3- wire macro | 33 |
| Default control connections for the 3-wire macro | 33 |
| Alternate macro | 35 |
| Default control connections for the Alternate macro | 36 |
| Motor potentiometer macro | 38 |
| Default control connections for the Motor potentiometer macro | 39 |
| Hand/Auto macro | 41 |
| Default control connections for the Hand/Auto macro | 42 |



6 Table of contents

| | |
|----------------------------------------------------|----|
| Hand/PID macro | 44 |
| Default control connections for the Hand/PID macro | 45 |
| PID control macro | 47 |
| Default control connections for PID control macro | 48 |
| PFC macro | 50 |
| Default control connections for the PFC macro | 51 |
| SPFC macro | 53 |
| Default control connections for the SPFC macro | 54 |
| Control panel PID macro | 56 |
| Default control connections for PID control macro | 56 |
| Parameter default values for different macros | 58 |

4. Function description



| | |
|------------------------------------------------|----|
| Contents of this chapter | 63 |
| Local control vs. external control | 63 |
| Local control | 64 |
| External control | 64 |
| Operating modes of the drive | 66 |
| Frequency control mode | 66 |
| Special control modes | 66 |
| Converter configuration and programming | 67 |
| Configuring via parameters | 67 |
| Motor control | 68 |
| Motor Type | 68 |
| Reference ramping | 68 |
| Constant frequency | 68 |
| Critical frequency | 68 |
| Scalar control | 69 |
| U/f ratio | 70 |
| DC magnetization | 70 |
| Energy optimization | 72 |
| Switching frequency | 72 |
| Application control | 74 |
| Application macros | 74 |
| Process PID control | 74 |
| Pump and fan control (PFC) | 77 |
| User lock | 78 |
| Mechanical brake control | 79 |
| Timed function | 82 |
| Override mode | 83 |
| User load curve | 84 |
| DC voltage control | 85 |
| Overvoltage control | 85 |
| Undervoltage control (power loss ride-through) | 85 |
| Voltage control and trip limits | 86 |
| Brake chopper | 87 |
| Safety and protections | 88 |
| Fixed/Standard protections | 88 |
| Emergency stop | 88 |
| Motor thermal protection | 89 |

| | |
|-----------------------------------|----|
| Programmable protection functions | 90 |
| Automatic fault resets | 91 |
| Diagnostics | 92 |
| Signal supervision | 92 |
| Energy saving calculators | 92 |
| Load analyzer | 92 |
| Other | 94 |
| Backup and restore | 94 |
| User macro | 94 |
| Data storage parameters | 95 |

5. Parameter data

| | |
|----------------------------|-----|
| What this chapter contains | 97 |
| Terms and abbreviations | 97 |
| Fieldbus addresses | 98 |
| Parameter groups 1...9 | 99 |
| Parameter groups 10...99 | 102 |



6. Parameter

| | |
|------------------------------|-----|
| What this chapter contains | 129 |
| Terms and abbreviations | 130 |
| Summary of parameter groups | 131 |
| Parameter list | 133 |
| 01 Actual values | 133 |
| 03 Input references | 136 |
| 04 Warnings and faults | 136 |
| 05 Diagnostics | 138 |
| 06 Control and status words | 141 |
| 07 System info | 144 |
| 10 Standard DI, RO | 146 |
| 11 Standard DIO, FI, FO | 150 |
| 12 Standard AI | 151 |
| 13 Standard AO | 156 |
| 15 I/O extension module | 163 |
| 19 Operation mode | 171 |
| 20 Start/stop/direction | 171 |
| 21 Start/stop mode | 181 |
| 22 Speed reference selection | 187 |
| 23 Speed reference ramp | 188 |
| 28 Frequency reference chain | 189 |
| 30 Limits | 199 |
| 31 Fault functions | 204 |
| 32 Supervision | 211 |
| 34 Timed functions | 218 |
| 35 Motor thermal protection | 224 |
| 36 Load analyzer | 234 |
| 37 User load curve | 237 |
| 40 Process PID set 1 | 240 |
| 41 Process PID set 2 | 255 |

8 Table of contents

| | |
|-----------------------------------|-----|
| 43 Brake chopper | 257 |
| 44 Mechanical brake control | 259 |
| 45 Energy efficiency | 261 |
| 46 Monitoring/scaling settings | 265 |
| 47 Data storage | 267 |
| 49 Panel port communication | 268 |
| 50 Fieldbus adapter (FBA) | 269 |
| 51 FBA A settings | 273 |
| 52 FBA A data in | 274 |
| 53 FBA A data out | 275 |
| 58 Embedded fieldbus | 275 |
| 70 Override | 282 |
| 71 External PID1 | 285 |
| 76 PFC configuration | 288 |
| 77 PFC maintenance and monitoring | 294 |
| 95 HW configuration | 295 |
| 96 System | 297 |
| 97 Motor control | 307 |
| 99 Motor data | 309 |

7. Fieldbus control

| | |
|------------------------------------------------------------------------------|-----|
| Controlled through an embedded fieldbus interface (EFB) | 311 |
| System overview | 311 |
| Connecting the fieldbus to the drive | 313 |
| Setting up the embedded fieldbus interface | 314 |
| Setting the drive control parameters | 315 |
| Basics of the embedded fieldbus interface | 317 |
| Control word and Status word | 318 |
| Reference value | 318 |
| Actual value | 318 |
| Data I/O | 318 |
| Register addressing | 318 |
| About the control profiles | 320 |
| Control word | 321 |
| Control Word for the ABB Drives profile | 321 |
| Control Word for the DCU Profile | 322 |
| Status word | 325 |
| Status Word for the ABB Drives profile | 325 |
| Status Word for the DCU Profile | 326 |
| State transition diagrams | 328 |
| State transition diagram for the ABB Drives profile | 328 |
| Reference value | 330 |
| References for the ABB Drives profile and DCU Profile | 330 |
| Actual value | 331 |
| Actual values for the ABB Drives profile and DCU Profile | 331 |
| Modbus holding register addresses | 332 |
| Modbus holding register addresses for the ABB Drives profile and DCU Profile | 332 |
| MODBUS function codes | 333 |
| Exception code | 334 |
| Coils (0xxxx reference set) | 335 |



| | |
|----------------------------------------------------------------|-----|
| Discrete inputs (1xxxx reference set) | 336 |
| Error code registers (holding registers 400090...400100) | 337 |
| Control through a fieldbus adapter | 337 |
| System overview | 337 |
| Interface basis of fieldbus adapters | 339 |
| Control word and Status word | 340 |
| Reference value | 341 |
| Actual value | 342 |
| Contents of the fieldbus Control word | 343 |
| Contents of the fieldbus Status word | 345 |
| The state diagram | 346 |
| Setting up the drive for fieldbus control | 347 |
| Parameter setting examples: FPBA (PROFIBUS DP) | 348 |

8. Fault tracing

| | |
|-----------------------------------------|-----|
| What this chapter contains | 351 |
| Safety | 351 |
| Indications | 351 |
| Warnings and faults | 351 |
| Pure events | 352 |
| Warning/fault history | 352 |
| Event logs | 352 |
| Viewing warning/fault information | 352 |
| Warning information | 353 |
| Fault messages | 364 |

9. Control chain diagrams

| | |
|----------------------------------------------------------|-----|
| What this chapter contains | 373 |
| Frequency reference selection | 374 |
| Frequency reference modification | 375 |
| Process PID setpoint and feedback source selection | 376 |
| Process PID controller | 377 |
| Direction lock | 378 |

Further information







Introduction to the manual

What this chapter contains

The chapter describes applicability, target audience and purpose of this manual. It describes the content of the manual and provides a series of manuals for reference.

Applicability

This manual applies to the ACS530 standard control program (version 2.16.0.7 or Higher versions of the software). Check system information or parameters on the control panel [07.05 Firmware version](#) (see page [144](#)).

Target audience

The reader is expected to know the fundamentals of electricity, wiring, electrical components and electrical schematic symbols.

The manual is written for readers worldwide. Both SI and imperial units are shown. Special US instructions for installations in the United States are given.

Purpose of the manual

This manual provides information needed for commissioning, using and servicing the drive.

Contents of the manual

This manual contains the following chapters:

- [Introduction to the manual](#) (The chapter, page 11) describes applicability, target audience, purpose and content of this manual.
- [Control panel](#) (page 17) contains instructions for removing and reinstalling basic type control panel and briefly describes its display, keys and key shortcuts.
- [Application macros](#) (page 29) contains a short description of each macro together with a connection diagram. Macros are pre-defined applications which will save user's time when configuring the drive.
- [Function description](#) (page 63) describes program features with lists of related user settings, actual signals, and fault and warning messages.
- [Parameter data](#) (page 97) describes parameters with some additional data.
- [Parameter](#) (page 129) describes parameters for control program, including actual signal.
- [Fieldbus control](#) (page 311) describes the communication to and from a fieldbus network using the embedded fieldbus interface of the drive.
- [Fault tracing](#) (page 351) lists the warning and fault messages with possible causes and remedies.
- [Control chain diagrams](#) (page 373) describes the parameter structure within the drive.
- [Further information](#) (inside of the back cover, page 375) describes how to make product and service inquiries, get information on product training, provide feedback on ABB Drives manuals and find documents on the Internet.

Related documents

You can find manuals and other product documents in PDF format on the Internet. See section Document library on the Internet on the inside of the back cover. For manuals not available in the Document library, contact your local ABB representative.

Drive manuals and guides

Code (English)

| | |
|---------------------------------------------------------------------------------|---------------------------------|
| <i>ACS530-01 Hardware manual, 0.75–250 kW</i> | 3AXD50000728121 |
| <i>ACS530-01 Quick Guide R1-R5</i> | 3AXD50000728169 |
| <i>ACS530-01 Quick Guide R6-R9</i> | 3AXD50000728176 |
| <i>ACS-BP-S Basic control panel user manual</i> | 3AXD50000032527 |
| <i>ACS-AP-I, -S, -W and ACH-AP-H, -W Assistant control panels user's manual</i> | 3AUA0000085685 |

Option manuals and guides

Code (English)

| | |
|-------------------------------------------------------|---------------------------------|
| <i>FCAN-01 CANopen adapter module user manual</i> | 3AFE68615500 |
| <i>FDNA-01 DeviceNet™ adapter module user manual</i> | 3AFE68573360 |
| <i>FEIP-21 Ethernet IP adapter module user manual</i> | 3AXD50000158621 |

| | |
|------------------------------------------------------------|---------------------------------|
| <i>FENA-01/-11/-21 ethernet adapter module user manual</i> | 3AUA0000093568 |
| <i>FLON-01 LonWORKS® adapter module user manual</i> | 3AUA0000041017 |
| <i>FMBA-01 Modbus adapter module user manual</i> | 3AFE68586704 |
| <i>FMBT-21 Modbus/TCP adapter module user manual</i> | 3AXD50000158607 |
| <i>FPBA-01 PROFIBUS DP adapter module user manual</i> | 3AFE68573271 |
| <i>FPNO-21 PROFINET adapter module user manual</i> | 3AXD50000158614 |
| <i>FECA-01 RS-485 adapter module user manual</i> | 3AUA0000109533 |

Tool and maintenance manuals and guides
Code (English)

| | |
|-------------------------------------------------------------------------------|--------------------------------|
| <i>Drive composer PC tool user manual</i> | 3AUA0000094606 |
| <i>Capacitor reforming instructions</i> | 3BFE64059629 |
| <i>NETA-21 remote monitoring tool user's manual</i> | 3AUA0000096939 |
| <i>NETA-21 NETA-21 remote monitoring tool installation and start-up guide</i> | 3AUA0000096881 |

The code below open online listing of the manuals applicable to the product.



ACS530-01 manuals

Terms and abbreviations

| Term/Abbreviation | Explanations |
|----------------------|----------------------------------------------------------------------------------------------------------------------------------------------------------------------------------------------------------------------------------------------------------------------------------|
| ACS-AP-X | Assistant control panel, advanced operating keypad for communication with the drive. Types supported by ACS530: ACS-AP-I, ACS-AP-S and ACS-AP-W. |
| ACS-BP-S | Basic-type control panel, basic operator keypad for communication with the drive, it is a standard configuration of drive. |
| AI | Analog input; interface for analog input signals |
| AO | Analog output; interface for analog output signals |
| Brake chopper | Conducts the surplus energy from the intermediate circuit of the drive to the brake resistor when necessary. The chopper operates when the DC bus voltage exceeds certain maximum limit. The voltage rise is typically caused by deceleration (braking) of a high inertia motor. |
| Brake resistors | Dissipates the drive surplus braking energy conducted by the brake chopper to heat. Essential part of the brake circuit. |
| Control board | Circuit board in which the control program runs. |
| DC bus | DC circuit between rectifier and inverter |
| DC bus capacitance | Energy storage which stabilizes the intermediate circuit DC voltage |
| DI | Digital input; interface for digital input signals |
| DPMP-01 | Mounting platform for ACS-AP-X control panel (embedded mounting) |
| DPMP-02/03 | Mounting platform for ACS-AP-X control panel (surface mounting) |
| Drives | Speed control equipment for controlling AC motor |
| EFB | Built-in bus communication |
| FBA | Fieldbus adapters |
| FCAN-01 | Optional CANopen adapter module |
| FCNA-01 | Optional Control Net adapter module |
| FDNA-01 | Optional DeviceNet adapter module |
| FECA-01 | Optional Ether CAT adapter module |
| FENA-01/-11/-21 | Optional Ethernet adapter module for EtherNet/IP, Modbus TCP and PROFINET IO protocols |
| FEPL-02 | Optional Ethernet POWERLINK adapter module |
| FPBA-01 | Optional PROFIBUS DP adapter module |
| FSCA-01 | Optional RS-485 adapter module |
| Frame size (size) | Refers to drive physical size, for example B0 and B1. The type designation label attached to the drive shows the frame of the drive. |
| IGBT | Insulated-gate bipolar transistor |
| Intermediate circuit | Please refer to DC bus . |
| Inverter | Converts direct current and voltage to alternating current and voltage. |
| I/O | Input/Output |
| LSW | Least significant word |

| Term/Abbreviation | Explanations |
|------------------------------------|----------------------------------------------------------------------------------------------------------------------------------------------------------------------------------------------------------------------------------------------------------------------------------------------------------------------------------------------------------------------------------------------------------------------------------------------------------------------------------------------------------------------------------------------------------------------------|
| Macro | Pre-defined default values of parameters in drive control program. Each macro is intended for a specific application. See chapter 29 on page Application macros . |
| NETA-21 | Remote monitoring tool |
| Network control | With fieldbus protocols based on the Common Industrial Protocol (CIP™), such as Device Net and Ethernet/IP, denotes the control of the converter using the Net Ctrl and Net Ref objects of the ODVA AC/DC Drive Profile. For more information, see www.odva.org , and the following manuals: <ul style="list-style-type: none"> • <i>FDNA-01 Device Net adapter module User's manual</i> (3AFE68573360 [English]),and • <i>FENA-01/-11/-21 Ethernet adapter module User's manual</i> (3AUA0000093568 [English]). |
| Parameter | User-adjustable operation instruction to the drive, or signal measured or calculated by the drive |
| PID controller | Proportional–integral–derivative controller. Drive speed control is based on PID algorithm. |
| PLC | Programmable logic controller |
| PROFIBUS, PROFIBUS DP, PROFINET IO | PI - PROFIBUS & PROFINET international registered trademark |
| RO | Relay output; interface for digital output signal. |
| Rectifier | Converts alternating current and voltage to direct current and voltage. |
| STO | STO. See the drive hardware manual. |

Network Security Disclaimer

The product design is used to connect network interfaces and transfer information and data via network interfaces. The client shall provide and guarantee continuous secure connection between the product and client network / any other network (as the case may be). The client shall develop and maintain appropriate measures, (including but not limited to fire wall, authentication, data encryption, Encryption, antivirus program and so on) to protect the product, network, system and interface from any security violation, unauthorized access, interference, intrusion, leakage and or theft of data or information. For damage or loss due to the above security violation, unauthorized access, interference, intrusion, leakage and or theft of data or information, ABB and subsidiaries shall not assume any liability.



2

Control panel

Applicability

This manual is applicable with the ACS-BP-S basic control panel, the panel software Version GPBPS 1.40.0.0 and later software versions.

The images and instructions are based on the use of the basic control panel with an ACS530 drive equipped with the Standard control program. Note that there may be differences if you use the basic control panel with other equipment or program versions.

Safety

See the appropriate drive hardware manual.

Related manuals

See the appropriate drive manual. All manuals are available in pdf format at www.abb.com/drives/documents).

Attach and remove the control panel

You can attach the control panel directly to the drive, or use a separate mounting kit.

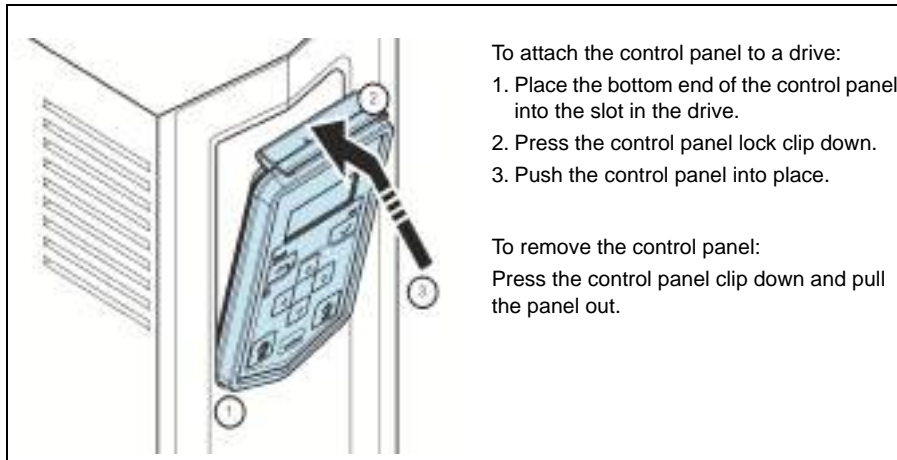

Start up

To start up the drive, you need to set the motor data, motor control, application macro and drive parameters. See the relevant drive firmware manual for start-up details.

Control panel use

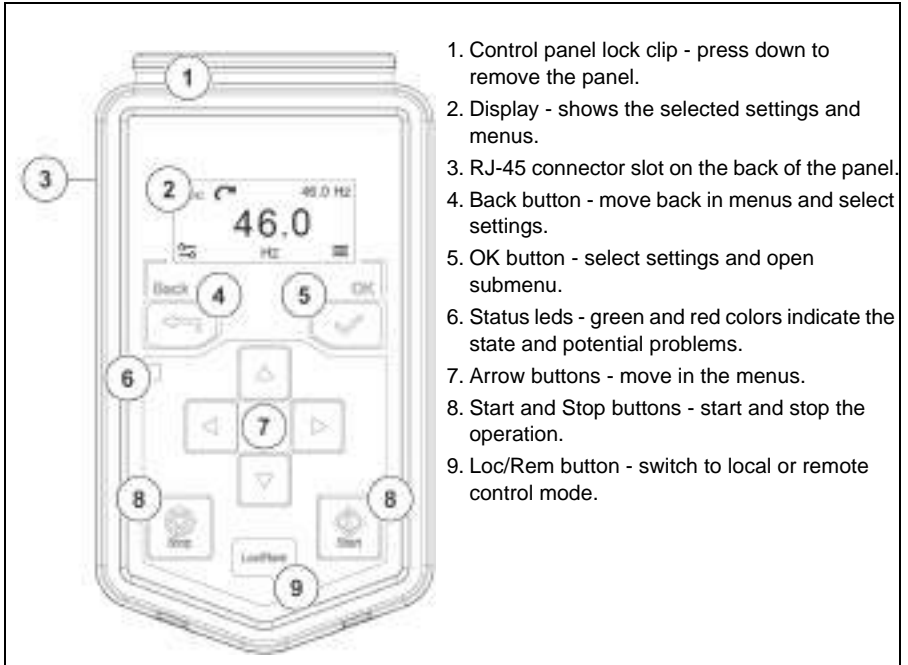

Display

"Options" menu



1. Back button: opens Options menu.
2. Options menu.
3. Control location
4. Rotation direction - forward or reverse
5. Frequency: active.
6. Frequency: target.



"Main" menu.



7. Main menu.
8. OK button: opens the Main menu.

Options menu

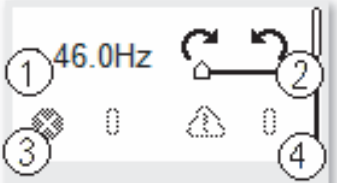



1. Reference frequency
2. Rotation direction - forward or reverse
3. Active fault
4. Active warning

Start and stop the drive

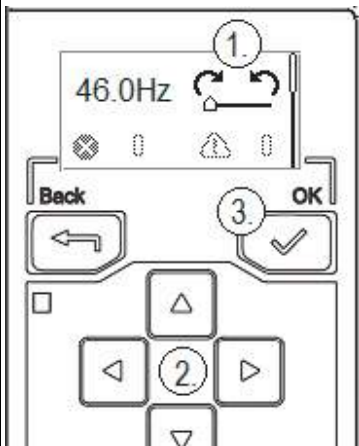

To start the drive, press the Start button on the basic control panel. To stop the drive, press the Stop button on the basic control panel.

Change the rotation direction

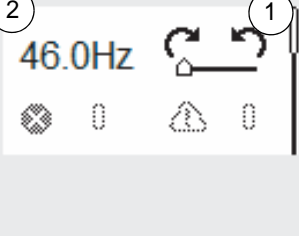

1. In *Options* menu .
2. Move to the rotation direction item with the arrow buttons.
3. Press the OK button to change the rotation direction.

Set the speed or frequency reference

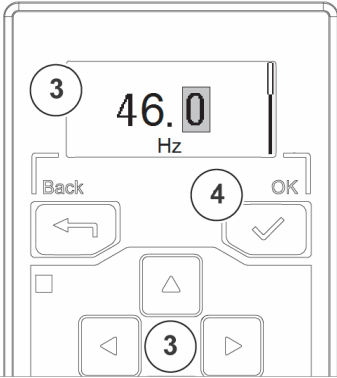
| | |
|-----------------------------------------------------------------------------------------------------------------------------------------------------------------------------------------------------------------------------------------------------------------------------------------------------------------------------------------------------------------------------------------------------------------------------------------------------------------------------------------------------------------------------------------------------------------------------------------------------------------|----------------------------------------------------------------------------------------------------------------------------------------------------------------------------------------------------------------------------------------------------------------------------|
|  <p>A screenshot of the control panel's LCD display. The display shows '46.0Hz' in large blue digits. Below it are two icons: a square with a circle and a triangle, and a triangle with a circle. To the right of the display, there are two curved arrows pointing left and right, with a small '1' in a circle next to them. To the left of the display, there is a small '2' in a circle.</p> | <ol style="list-style-type: none">1. In <i>Options</i> menu , move to the frequency reference item with the arrow buttons.2. Press the OK button to open the item. |
|  <p>A line drawing of the control panel keypad. The display shows '46.0 Hz'. Below the display are several buttons: a 'Back' button with a left arrow, an 'OK' button with a checkmark, a central button with an up arrow, and two side buttons with left and right arrows. A small square button is to the left of the up arrow button. Numbered callouts are present: '3' in a circle points to the 'Back' button, '4' in a circle points to the 'OK' button, and '3' in a circle points to the central up arrow button.</p> | <ol style="list-style-type: none">3. Press the arrow buttons to set the frequency.4. Press the OK button to confirm the change. |

Set the drive parameters

1. Select Main menu from Home view  .
2. The Main menu opens.
3. Scroll up or down in the menu to the Parameters submenu, and press the OK button.
4. Select the complete parameters list, *or*
5. Select the modified parameters list with the arrow button and press the OK button.
6. The parameters are shown in respective groups. The first two digits of the parameter name represent the parameter group. For example, parameters starting with 30 are in the Limits parameters group.

Open Diagnostics

1. Select Main menu from *Home* view  .
2. The Main menu opens.
3. Scroll to the Diagnostics item and press the OK button to open the submenu.
4. Select the warning or fault with the arrow button and press the OK button.

Backup

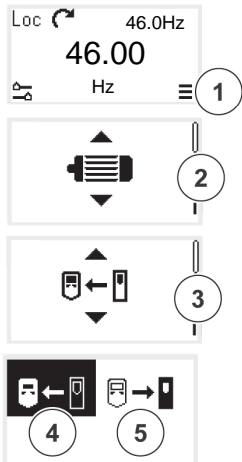

The diagram shows a sequence of four screens from a control panel interface, illustrating the steps to perform a backup. Each screen is numbered 1 through 4 in a circle.

- Screen 1:** Shows the Home view with 'Loc' and '46.0Hz' at the top, a large '46.00' in the center, and 'Hz' below it. A hamburger menu icon is on the right, with a circled '1' next to it.
- Screen 2:** Shows a main menu with a drive icon (a cylinder with a horizontal bar) in the center. A vertical line with a downward arrow points from the menu icon in Screen 1 to this screen, with a circled '2' next to it.
- Screen 3:** Shows a submenu with two options: a drive icon with a left-pointing arrow and a panel icon, and a drive icon with a right-pointing arrow and a panel icon. A vertical line with a downward arrow points from the drive icon in Screen 2 to this screen, with a circled '3' next to it.
- Screen 4:** Shows the same submenu as Screen 3, but with the drive icon with the left-pointing arrow highlighted in black. A circled '4' is below this option. A circled '5' is below the other option.

1. Select Main menu from *Home view* .
2. The Main menu opens.
3. Scroll the menu to the Backup submenu and press the OK button.
4. Select to back up from the drive to the panel, or
5. Select to restore the back up from the panel to the drive.
A progress view is shown during the backup.

“Main” menu



The image shows a vertical navigation panel with seven numbered icons. The icons are: 1. Motor data (motor icon), 2. Motor control (hill icon), 3. Application macros (I/O icon), 4. Diagnostics (circuit icon), 5. Energy efficiency (leaf icon), 6. Backup and reset (battery icon), 7. Parameters (gear icon).

1. Motor data - motor parameters
2. Motor control - motor behavior settings
3. Application macros - presetting for I/O settings and fieldbus
4. Diagnostics - faults, warnings, fault log and connection status
5. Energy efficiency - energy savings
6. Backup and reset
7. Parameters - parameters

■ Submenus

The Main menu items have a submenu where you can change settings and set actions. Some submenus also have menus and/or option lists. The content of the submenus depend on the drive type.

| Motor Data | |
|-----------------------------------------------------------------------------------|-----------|
|  | |
| 1. 3.75kW | 2. 1.90A |
| 3. 400.0V | 4. 50.0Hz |
| 5. 1480rpm | 6. 50.0Nm |
| 7. U V W | 8. 0.00 |

1. Rated Power
2. Rated Current
3. Rated Voltage
4. Nominal frequency
5. Nominal speed
6. Nominal torque
7. Phase order - U V W, U W V
8. Power factor

| Motor control | |
|-----------------------------------------------------------------------------------|--------------|
|  | |
| 1. Normal | 2. Ramp |
| 3. 5.0s | 4. 5.0 |
| 5. Max 10rpm | 6. Max 3.40A |
| 7. Min rpm | |

1. Start mode - Auto, Constant time, auto, torque boost, auto + boost
2. Stop mode - Coast, Ramp
3. Acceleration time
4. Deceleration time
5. Maximum allowed speed
6. Maximum allowed current
7. Minimum allowed speed

Connection macros

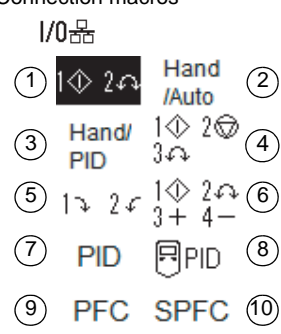

The connection macros available depends on the drive type.

1. ABB Standard (2-wire)
2. Hand/Auto
3. Hand / PID
4. 3-wire macro
5. Alternate macro
6. Motor potentiometer
7. PID
8. Control panel PID
9. PFC
10. SPFC

Diagnose

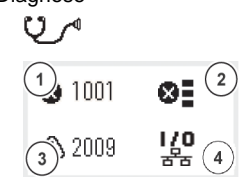

1. Active Fault - the fault code is displayed
2. Fault History - list of latest fault codes (newest first)
3. Active warnings - the warning code is shown
4. I/O status - I/O settings

Energy Efficiency

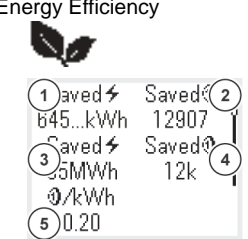

1. Saved energy in kWh
2. Saved money
3. Saved energy in MWh
4. Saved money x 1000
5. Cost per kWh

Backup

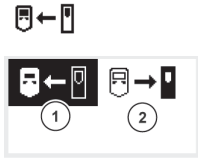

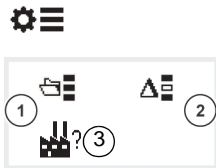

1. Backup from the drive to the control panel.
2. restore the back up from the panel to the drive.
A progress view is shown during the backup.

Parameters





1. Complete parameter list - Groups menu with complete parameters and parameter levels
2. Modified parameters list - non-default value.
3. Restore the default parameter values.



Fault and warning messages

| | |
|-----------------------------------------------------------------------------------------------------------------|----------------------------------------------------------------------------------------------------------------------------------------------------------------------------------------------------------------------------------------------------------------------------------------------------------------------------------------------|
| <p><i>A fault message</i></p>  | <p>The display shows fault messages if a problem has been detected. A fault message needs your immediate attention.</p> <ol style="list-style-type: none"> 1. Identify and eliminate the cause. 2. Refer to the relevant for more information on the fault. 3. Press <i>Reset</i> in the <i>Fault</i> view. |
| <p><i>Warning messages</i></p>  | <p>The display shows a warning message if a problem has been detected.</p> <p>To separately view the warning messages:</p> <ol style="list-style-type: none"> 1. Open the <i>Main</i> menu. 2. Select <i>Diagnostics</i>. 3. Scroll down the list if there are multiple warnings. |

Drive and panel communication failure

| | |
|-----------------------------------------------------------------------------------|----------------------------------------------------------------------------------------------------------|
|  | <p>There is a general communication failure, e.g., the drive does not respond to the panel commands.</p> |
|  | <p>The drive and panel are not compatible, e.g., the drive does not support the basic panel.</p> |

Status light

| | | |
|------------------|-------------------------------------------------------------------------------------|------------------------------------|
| Continuous green |  | The drive is functioning normally. |
| Green, blinking |  | There is a warning in the drive. |
| Red, continuous |  | There is a fault in the drive. |

3

Application macros

What this chapter contains

This chapter describes the intended use, operation and default control connections of the application macros. At the end of chapter there are tables showing those parameter default values (not the same for all macros).

Get an Overview

Control macros are sets of default parameter values suitable for a certain control configuration. When starting up the drive, the user typically selects the best-suited control macro as a starting point, then makes any necessary changes to tailor the settings to their purpose. This usually results in a much lower number of user edits compared to the traditional way of programming a drive.

Use parameter [96.04 Macro select](#) (Page 298).

ABB standard macro

This is the default macro. It is a 2-wire I/O configuration with three constant frequency references and applicable for normal control purpose. One signal is used to start or stop the motor and another to select the direction.

Default control connections for the ABB standard macro

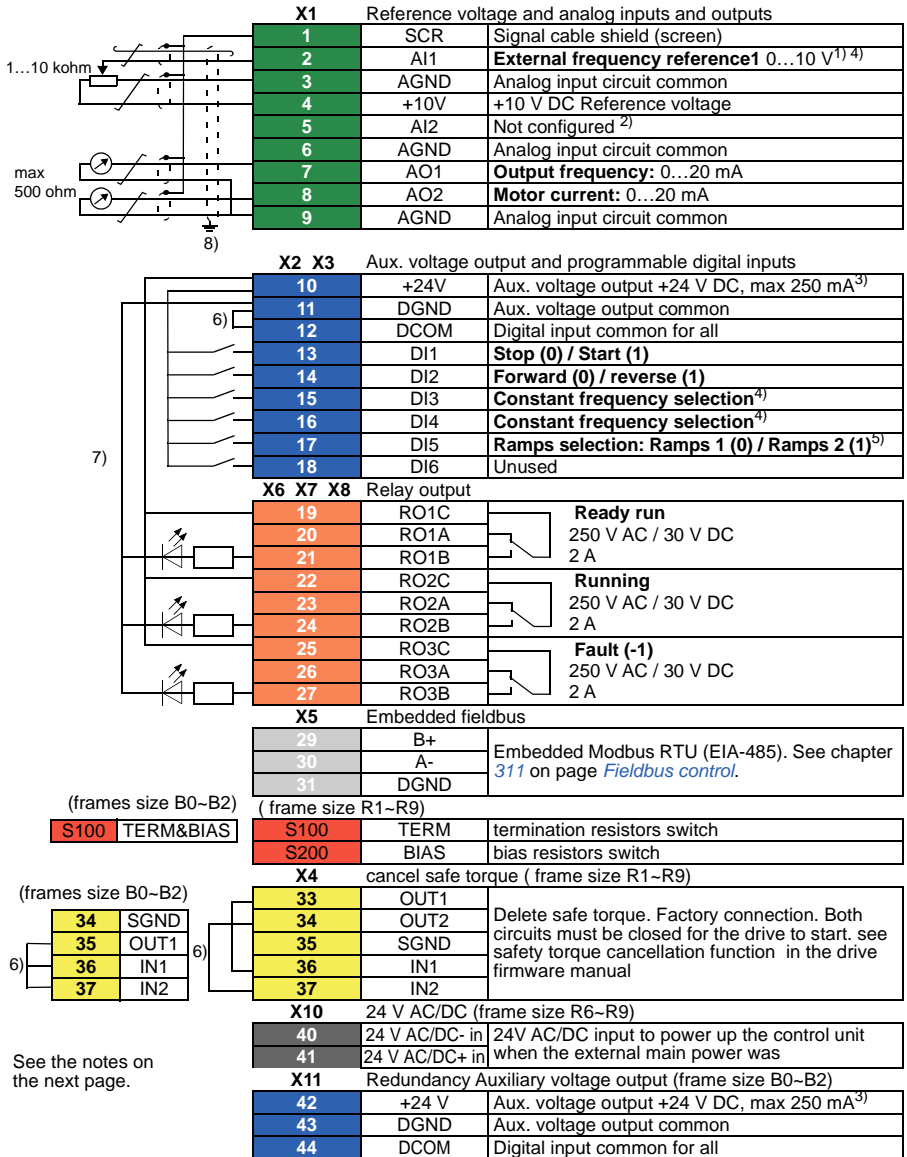

Terminal size:

B0...R9: 0.14...1.5 mm²(All terminals)

Tightening torque: 0.5...0.6 N·m (0.4 lbf·ft)

Notes:

32 Application macros

1) current [0(4)...20mA, Rin < 500 ohm] or voltage [0(2)...10V, Rin > 200 kohm] set by parameters **12.15 AI1 unit selection**.

2) current [0(4)...20mA, Rin < 500 ohm] or voltage [0(2)...10V, Rin > 200 kohm] set by parameters **12.25 AI2 unit selection**.

3) Total load capacity of Auxiliary voltage output +24V(X2:10) is 6.0W (250mA/24V).

4) Scalar control (default): See reference group 28 Frequency reference control chain.

| DI3 | DI4 | Operation/Parameter |
|-----|-----|----------------------------|
| 0 | 0 | Set frequency by AI1. |
| 1 | 0 | 28.26 constant frequency 1 |
| 0 | 1 | 28.27 constant frequency 2 |
| 1 | 1 | 28.28 constant frequency 3 |

5) Scalar control (default): See reference group 28 Frequency reference control chain.

| DI5 | Ramp set | Parameter |
|-----|----------|--------------------------------|
| 0 | 1 | 28.72 Freq acceleration time 1 |
| | | 28.73 Freq deceleration time 1 |
| 1 | 2 | 28.74 Freq acceleration time 2 |
| | | 28.75 Freq deceleration time 2 |

6) Connected with jumpers at the factory.

7) Note: Use shielded twisted-pair cables for digital signals.

8) Ground the outer shield of the cable 360 degrees under the grounding clamp on the grounding shelf for the control cables.

For cable connection and drive operation, refer to the control connection in ACS530 hardware manual.

Input signals

- Analog frequency reference (AI1)
- Start /Stop (DI1)
- Forward / reverse (DI2)
- Constant frequency selection (DI3, DI4)
- Ramps selection (DI5)

Output signals

- Analog output AO1: output frequency
 - Analog output AO2: output frequency
 - Relay output 1: Ready run
 - Relay output 2: running
 - Relay output 3: fault (-1)
-

3- wire macro

This macro is used when the drive is controlled using momentary push-buttons. To enable the macro, set the value of parameter *96.04 Macro select* to *3- wire*.

■ Default control connections for the 3-wire macro

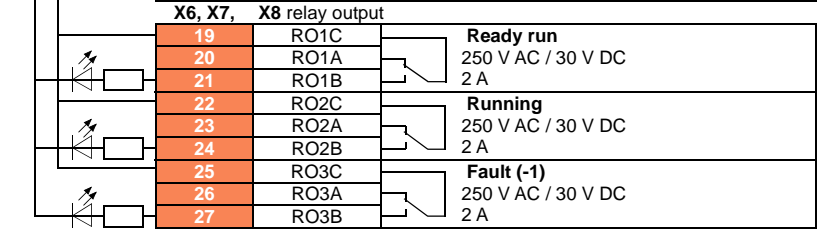
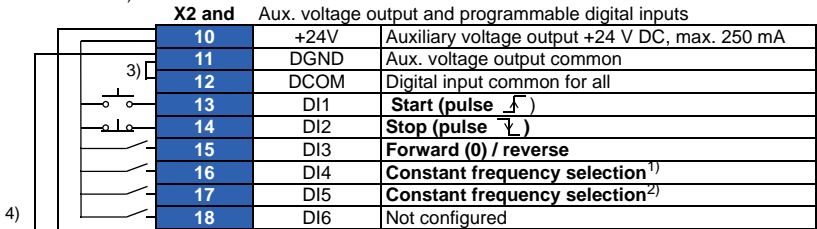
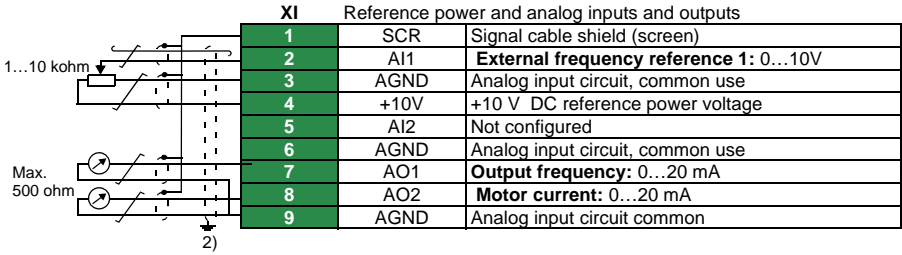

| X5 Embedded fieldbus | | |
|----------------------|------|----------------------------------------------------------------------------------|
| 29 | B+ | Embedded Modbus RTU (EIA-485). See chapter 311 on page <i>Fieldbus control</i> . |
| 30 | A- | |
| 31 | DGND | |

(frames size B0-B2)

| | |
|------|-----------|
| S100 | TERM&BIAS |
|------|-----------|

(frames size R1-R9)

| | | |
|------|------|------------------------------|
| S100 | TERM | termination resistors switch |
| S200 | BIAS | bias resistors switch |

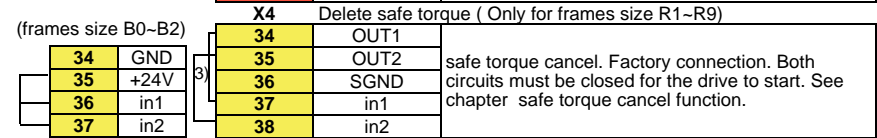

See the notes on the next page.

| X11 Redundancy auxiliary voltage output (frames size B0-B2) | | |
|--------------------------------------------------------------|-------|------------------------------------------------|
| 42 | +24 V | Auxiliary voltage output +24 V DC, max. 250 mA |
| 43 | DGND | Aux. voltage output common |
| 44 | DCOM | Digital input common for all |

Terminal size:

B0...R9: 0.14...1.5 mm²(All terminals)

Tightening torque: 0.5...0.6 N·m (0.4 lbf·ft)

Notes:

- 1) See reference group [28 Frequency reference chain](#).

| DI4 | DI5 | Operation/Parameter |
|-----|-----|--------------------------------------------|
| 0 | 0 | Set frequency through AI1 |
| 1 | 0 | 28.26 Constant frequency 1 |
| 0 | 1 | 28.27 Constant frequency 2 |
| 1 | 1 | 28.28 Constant frequency 3 |

- 2) Ground the outer shield of the cable 360 degrees under the grounding clamp on the grounding shelf for the control cables.
- 3) Connected with jumpers at the factory.
- 4) Use shielded twisted-pair cables for digital signals.

Input signals

- Analog frequency reference (AI1)
- Start, pulse (DI1)
- Stop, pulse (DI2)
- Direction selection (DI3)
- Constant frequency selection (DI4, DI5)

Output signals

- Analog output AO1: output frequency
 - Analog output AO2: output frequency
 - Relay output 1: Ready run
 - Relay output 2: running
 - Relay output 3: fault (-1)
-

Alternate macro

This macro provides an I/O configuration where one signal starts the motor in the forward direction and another signal to start the motor in the reverse direction. To enable the macro, set the value of parameter [96.04 Macro select](#) to *Alternate*.

Default control connections for the Alternate macro

| XI Reference power and analog inputs and outputs | | | |
|--------------------------------------------------|------|------------------------------------------------|--|
| 1 | SCR | Signal cable shield (screen) | |
| 2 | AI1 | External frequency reference 1:0...10 V | |
| 3 | AGND | Analog input circuit, common use | |
| 4 | +10V | +10 V DC Reference voltage | |
| 5 | AI2 | Not configured | |
| 6 | AGND | Analog input circuit, common use | |
| 7 | AO1 | Output frequency: 0...20 mA | |
| 8 | AO2 | Motor current: 0...20 mA | |
| 9 | AGND | Analog input circuit, common use | |

| X2 and X3 Aux. voltage output and programmable digital inputs | | |
|---------------------------------------------------------------|------|-------------------------------------------------------------|
| 10 | +24V | Auxiliary voltage output +24 V DC, max. 250 mA |
| 11 | DGND | Aux. voltage output common |
| 12 | DCOM | Digital input common for all |
| 13 | DI1 | Start and running forward; if DI1 = DI2: stop |
| 14 | DI2 | Start and running reverse |
| 15 | DI3 | Constant frequency selection¹⁾ |
| 16 | DI4 | Constant frequency selection¹⁾ |
| 17 | DI5 | Ramp set 1 (0) / Ramp set 2 (1)²⁾ |
| 18 | DI6 | Running is permitted, if it is 0, drive operation is |

| X6, X7, X8 relay output | | |
|-------------------------|------|------------------------------------------------|
| 19 | RO1C | Ready run 250 V AC / 30 V DC 2 A |
| 20 | RO1A | |
| 21 | RO1B | |
| 22 | RO2C | Running 250 V AC / 30 V DC 2 A |
| 23 | RO2A | |
| 24 | RO2B | |
| 25 | RO3C | Fault (-1) 250 V AC / 30 V DC 2 A |
| 26 | RO3A | |
| 27 | RO3B | |

| X5 Embedded fieldbus | | |
|----------------------|------|----------------------------------------------------------------------------------|
| 29 | B+ | Embedded Modbus RTU (EIA-485). See chapter 311 on page <i>Fieldbus control</i> . |
| 30 | A- | |
| 31 | DGND | |
| S100 | TERM | termination resistors switch |
| S200 | BIAS | bias resistors switch |

| X4 Delete safe torque (Only for frames size R1–R9) | | |
|-----------------------------------------------------|------|-------------------------------------------------------------------------------------------------------------------------------------------------------------------|
| 34 | SGND | Delete safe torque. Factory connection. Both circuits must be closed for the drive to start. see safety torque cancellation function in the drive firmware manual |
| 35 | OUT2 | |
| 36 | IN1 | |
| 37 | IN1 | |
| 38 | IN2 | |

| X10 24 V AC/DC (frames size R6–R9) | | |
|------------------------------------|----------------|-------------------------------------------------------------------------------------|
| 40 | 24 V AC/DC- in | 24V AC/DC input, to power up the control unit when the main supply is disconnected. |
| 41 | 24 V AC/DC+ in | |

| X11 (frames size B0–B2) | | |
|-------------------------|-------|------------------------------------------------|
| 42 | +24 V | Auxiliary voltage output +24 V DC, max. 250 mA |
| 43 | DGND | Aux. voltage output common |
| 44 | DCOM | Digital input common for all |

See the notes on the next page.

Terminal size:

B0...R9: 0.14...1.5 mm²(All terminals)

Tightening torque: 0.5...0.6 N-m (0.4 lbf-ft)

Notes:

- 1) See reference group [28 Frequency reference chain](#).

| DI3 | DI4 | Operation/Parameter |
|-----|-----|--------------------------------------------|
| 0 | 0 | Set frequency through AI1 |
| 1 | 0 | 28.26 Constant frequency 1 |
| 0 | 1 | 28.27 Constant frequency 2 |
| 1 | 1 | 28.28 Constant frequency 3 |

- 2) See reference group [28 Frequency reference chain](#).

| DI5 | Ramp set | Parameter |
|-----|----------|--------------------------------------------------------------------------------------------------|
| 0 | 1 | 28.72 Freq acceleration time 1 28.73 Freq deceleration time 1 |
| 1 | 2 | 28.74 Freq acceleration time 2 28.75 Freq deceleration time 2 |

- 3) Ground the outer shield of the cable 360 degrees under the grounding clamp on the grounding shelf for the control cables.
- 4) Connected with jumpers at the factory.
- 5) **Note:** Use shielded twisted-pair cables for digital signals.

Input signals

- Analog frequency reference (AI1)
- Start motor forward (DI1)
- Start motor in reverse (DI2)
- Constant frequency selection (DI3, DI4)
- Ramps selection (DI5)
- Run permissions (DI6)

Output signals

- Analog output AO1: output frequency
 - Analog output AO2: output frequency
 - Relay output 1: Ready run
 - Relay output 2: running
 - Relay output 3: fault (-1)
-

Motor potentiometer macro

This macro provides a way to adjust the speed with the help of two-push buttons, or a cost-effective interface for PLCs that vary the speed of the motor using only digital signals. To enable the macro, set the value of parameter [96.04 Macro select](#) to *Motor potentiometer*.

■ Default control connections for the Motor potentiometer macro

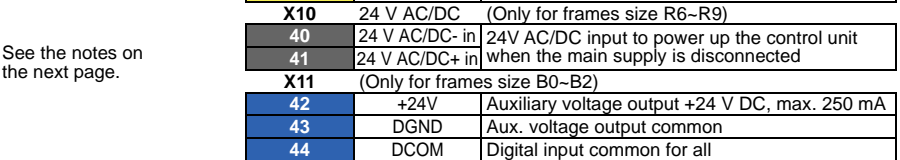
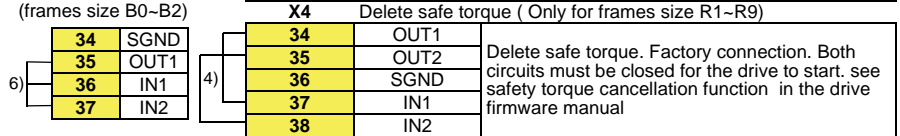
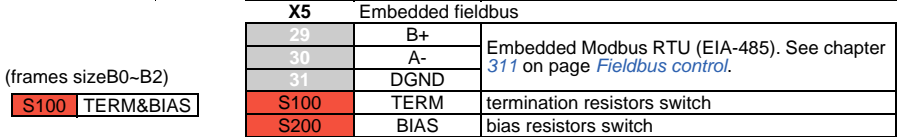
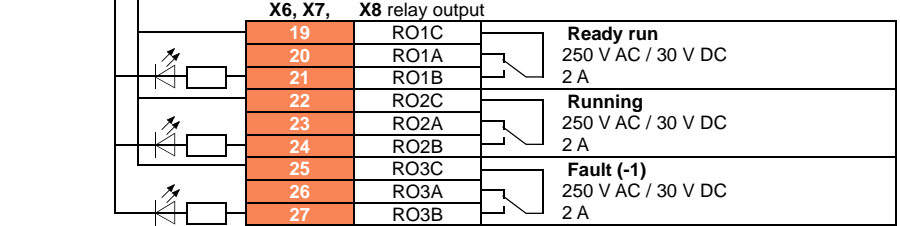
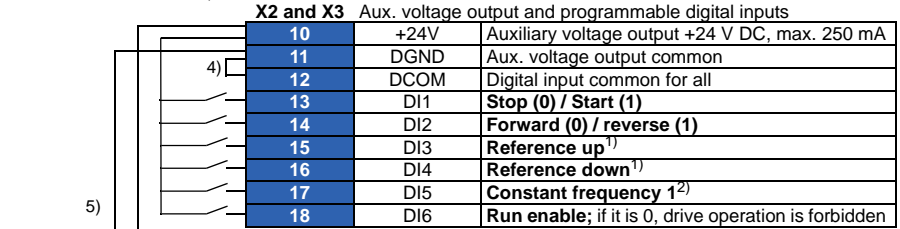
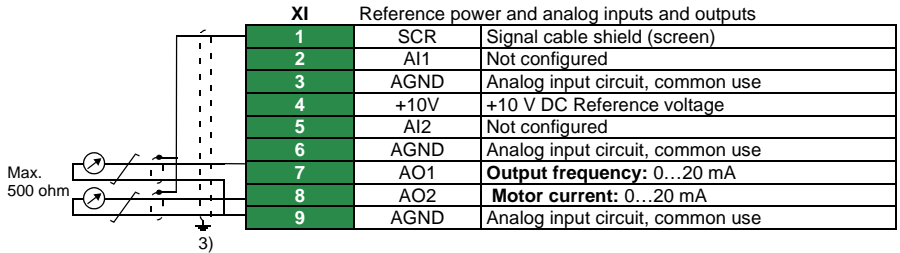

Terminal size:

B0...R9: 0.14...1.5 mm²(All terminals)
Tightening torque: 0.5...0.6 N·m (0.4 lbf·ft)

See the notes on the next page.

Notes:

- 1) If DI3 and DI4 are both active or inactive, the frequency reference is unchanged. The existing frequency reference is stored during stop and power down.
- 2) See reference [28.26 Constant frequency 1](#).
- 3) Ground the outer shield of the cable 360 degrees under the grounding clamp on the grounding shelf for the control cables.
- 4) Connected with jumpers at the factory.
- 5) Use shielded twisted-pair cables for digital signals.

Input signals

- Start/stop selection (DI1)
- Direction selection (DI2)
- Reference up (DI3)
- Reference down (DI4)
- Constant frequency 1 (DI5)
- Run permissions (DI6)

Output signals

- Analog output AO1: output frequency
 - Analog output AO2: output frequency
 - Relay output 1: Ready run
 - Relay output 2: running
 - Relay output 3: fault (-1)
-

Hand/Auto macro

This macro can be used when switching between two external control devices is needed. Both external control device have their own control and reference signals. One signal is used to switch between these two. To enable the macro, set the value of parameter [96.04 Macro select](#) to *Hand/Auto*.

■ Default control connections for the Hand/Auto macro

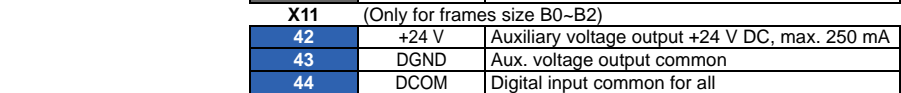
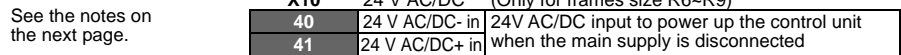
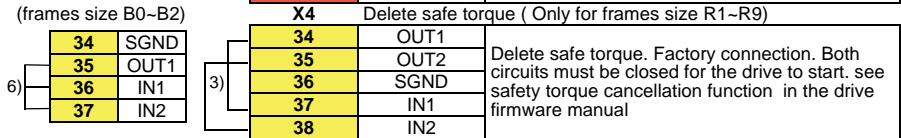
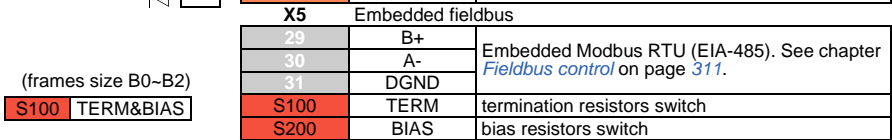
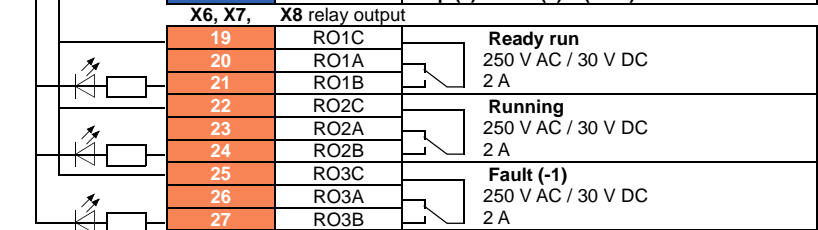
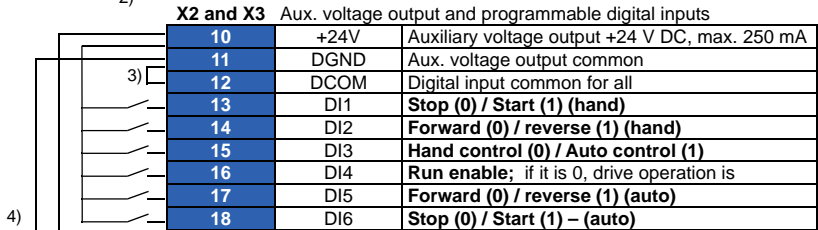
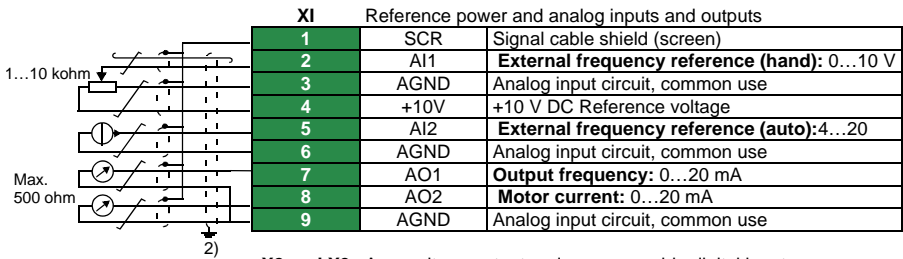

Terminal size:

B0...R9: 0.14...1.5 mm²(All terminals)

Tightening torque: 0.5...0.6 N·m (0.4 lbf·ft)

Notes:

- 1) The signal source is powered externally. See the manufacturer's instructions. To use sensors supplied by the drive auxiliary voltage output, see chapter *Electrical installation*", section *Connection examples of two-wire and three-wire sensors* in the *Hardware manual* of the drive.
- 2) Ground the outer shield of the cable 360 degrees under the grounding clamp on the grounding shelf for the control cables.
- 3) Connected with jumpers at the factory.
- 4) **Note:** Use shielded twisted-pair cables for digital signals.

Input signals

- Two frequency analog reference (AI1, AI2)
- Control location (Hand or Auto) selection (DI3)
- Start/stop selection, Hand (DI1)
- Direction selection, Hand (DI2)
- Start/stop selection, Auto (DI6)
- Direction selection, Auto (DI5)
- Run permissions (DI4)

Output signals

- Analog output AO1: output frequency
 - Analog output AO2: output frequency
 - Relay output 1: Ready run
 - Relay output 2: running
 - Relay output 3: fault (-1)
-

Hand/PID macro

This macro controls the drive with the built-in process PID controller. In addition this macro has a second control location for the direct frequency control mode. To enable the macro, set the value of parameter [96.04 Macro select](#) to *Hand/PID*.

Default control connections for the Hand/PID macro

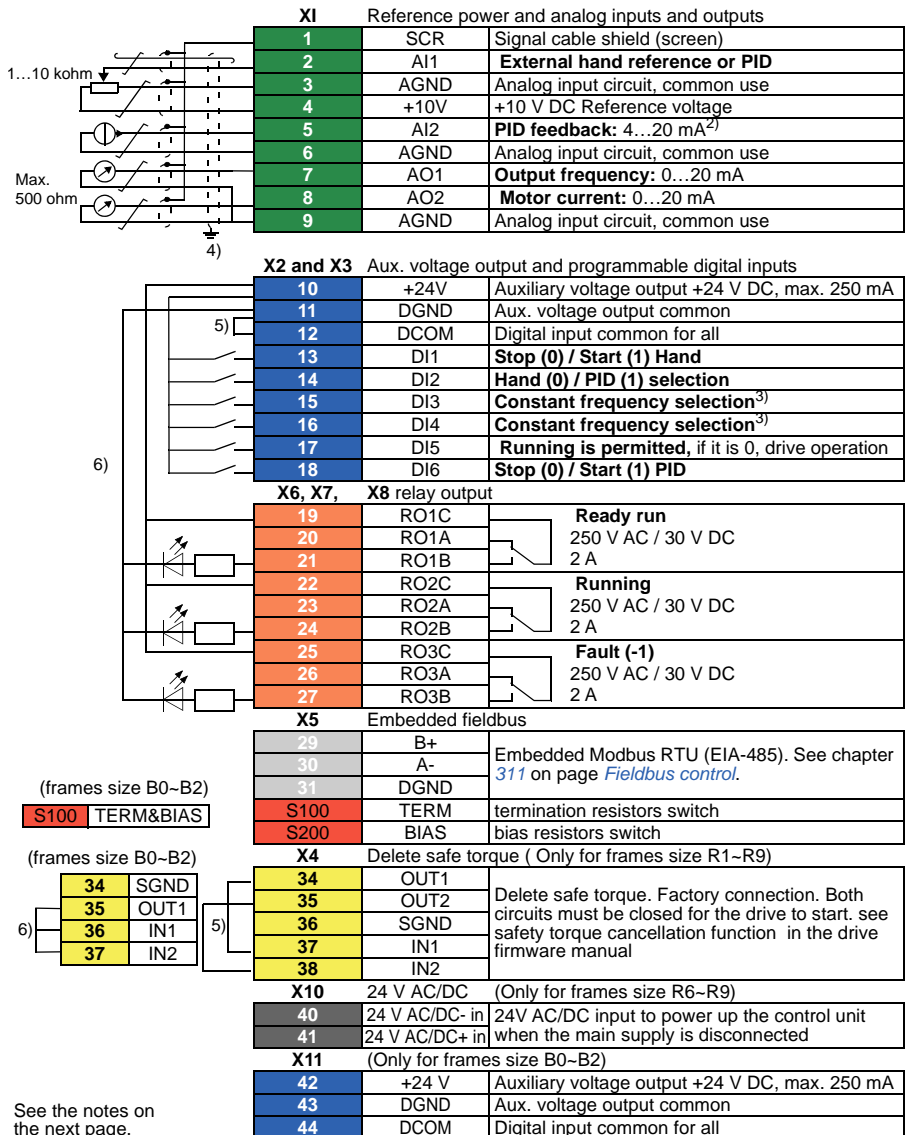

Terminal size:

B0...R9: 0.14...1.5 mm²(All terminals)

Tightening torque: 0.5...0.6 N·m (0.4 lbf·ft)

Notes:

- 1) Hand: 0...10 V -> Frequency reference.
 PID: 0...10 V -> 0...100% PID set point.
- 2) The signal source is powered externally. See the manufacturer's instructions. To use sensors supplied by the drive auxiliary voltage output, see chapter *Electrical installation, section Connection examples of two-wire and three-wire sensors* in the *Hardware manual* of the drive.
- 3) See reference group [28 Frequency reference chain](#).

| DI3 | DI4 | Operation (parameters) |
|-----|-----|--------------------------------------------|
| 0 | 0 | Set frequency through AI1 |
| 1 | 0 | 28.26 Constant frequency 1 |
| 0 | 1 | 28.27 Constant frequency 2 |
| 1 | 1 | 28.28 Constant frequency 3 |

- 4) Ground the outer shield of the cable 360 degrees under the grounding clamp on the grounding shelf for the control cables.
- 5) Connected with jumpers at the factory.
- 6) Use shielded twisted-pair cables for digital signals.

Input signals

- External hand reference or PID Reference (AI1)
- PID feedback (AI2)
- Start/stop selection, Hand (DI1)
- Control location (Hand or PID) selection (DI2)
- Constant frequency selection (DI3, DI4)
- Running enable (DI5)
- Start/stop selection, PID (DI6)

Output signals

- Analog output AO1: output frequency
- Analog output AO2: output frequency
- Relay output 1: Ready run
- Relay output 2: running
- Relay output 3: fault (-1)

PID control macro

This macro provides parameter settings for closed-loop control systems such as pressure control, flow control, etc. To enable the macro, set the value of parameter [96.04 Macro select](#) to *PID*.

Default control connections for PID control macro

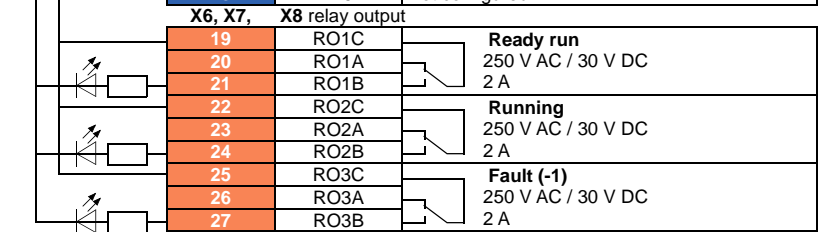
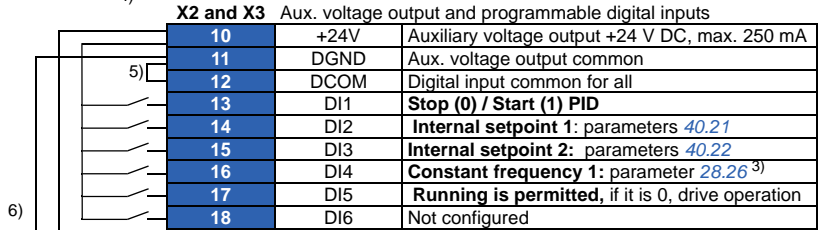
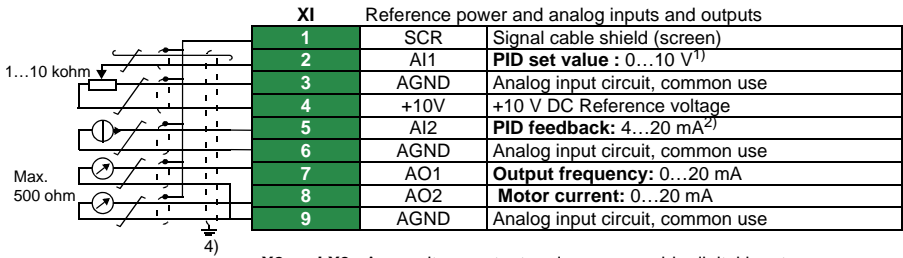

| X5 Embedded fieldbus | | |
|----------------------|------|-------------------------------------------------------------------------------------------|
| 29 | B+ | Embedded Modbus RTU (EIA-485). See chapter 311 on page Fieldbus control . |
| 30 | A- | |
| 31 | DGND | |

(frames size B0-B2)

| | |
|------|-----------|
| S100 | TERM&BIAS |
|------|-----------|

| | | |
|------|------|------------------------------|
| S100 | TERM | termination resistors switch |
| S200 | BIAS | bias resistors switch |

(frames size B0-B2)

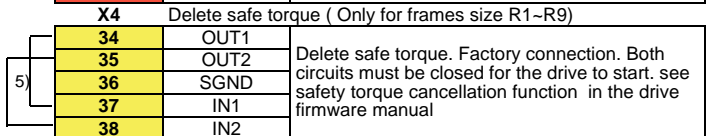
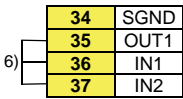

See the notes on the next page.

| X10 24 V AC/DC (Only for frames size R6-R9) | | |
|----------------------------------------------|----------------|-----------------------------------------------------------------------------------|
| 40 | 24 V AC/DC- in | 24V AC/DC input to power up the control unit when the main supply is disconnected |
| 41 | 24 V AC/DC+ in | |

| X11 (Only for frames size B0-B2) | | |
|----------------------------------|-------|------------------------------------------------|
| 42 | +24 V | Auxiliary voltage output +24 V DC, max. 250 mA |
| 43 | DGND | Aux. voltage output common |
| 44 | DCOM | Digital input common for all |

Terminal size:

B0...R9: 0.14...1.5 mm²(All terminals)

Tightening torque: 0.5...0.6 N·m (0.4 lbf·ft)

Notes:

- 1) Hand: 0...10 V -> Frequency reference.
PID: 0...10 V -> 0...100% PID set point.
- 2) The signal source is powered externally. See the manufacturer's instructions. To use sensors supplied by the drive auxiliary voltage output, see chapter *Electrical installation*, section Connection examples of two-wire and three-wire sensors in the *Hardware manual* of the drive.
- 3) If Constant frequency is activated it overrides the reference from the PID controller output.
- 4) Ground the outer shield of the cable 360 degrees under the grounding clamp on the grounding shelf for the control cables.
- 5) Connected with jumpers at the factory.
- 6) Use shielded twisted-pair cables for digital signals.

Input signals

- PID setpoint (AI1)
- PID feedback (AI2)
- Start/Stop selection, PID (DI1)
- Internal setpoint 1 (DI2)
- Internal setpoint 2 (DI3)
- Constant frequency 1 (DI4)
- Running enable (DI5)

Output signals

- Analog output AO1: output frequency
 - Analog output AO2: output frequency
 - Relay output 1: Ready run
 - Relay output 2: running
 - Relay output 3: fault (-1)
-

PFC macro

Regulate control logic of multiple pumps and fans by drive relay output. Activate PFC macro by selecting basic setting menu, or activate the macro by setting parameter [96.04 Macro select](#) to [PFC](#). **PFC function will be available only when the external 2 is selected.**

■ Default control connections for the PFC macro

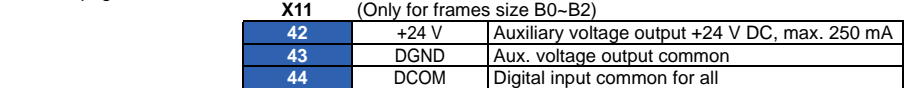
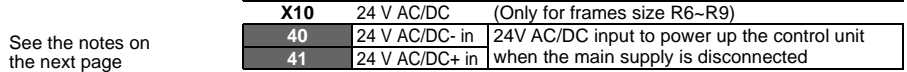
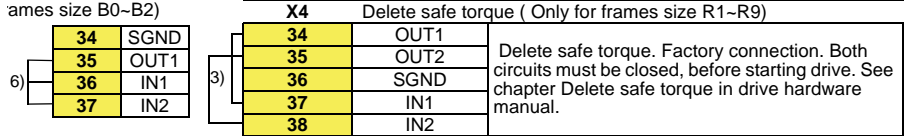
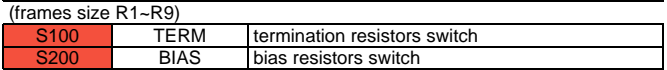
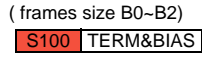
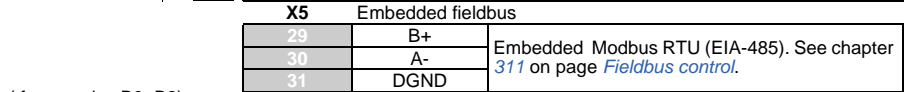
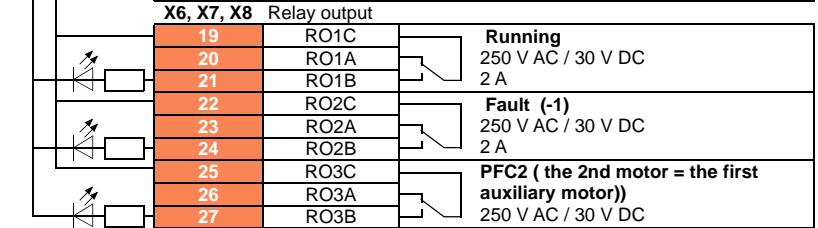
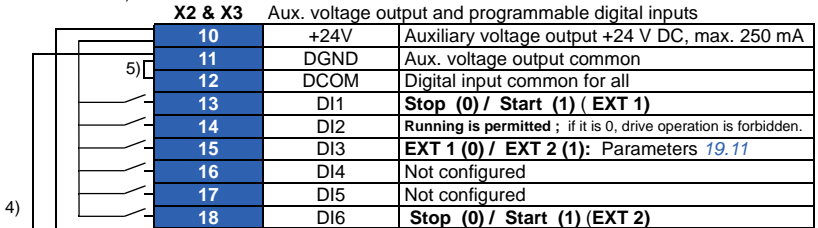
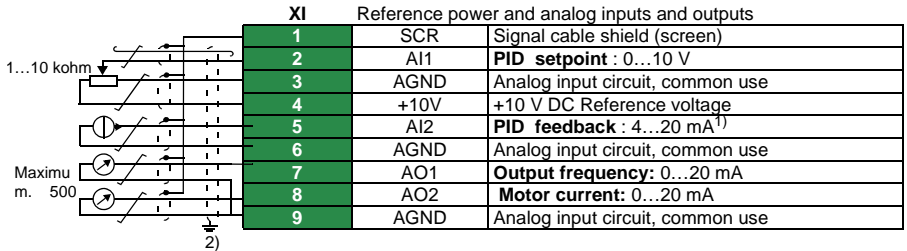

Terminal size:

B0...R9: 0.14...1.5 mm²(All terminals)
 Tightening torque: 0.5...0.6 N·m (0.4 lbf·ft)

Notes:

- 1) The signal source is powered externally. See the manufacturer's instructions. See chapter *Electrical installation in hardware manual in case of supplying power by relay with drive auxiliary voltage output*.
- 2) Ground the outer shields of cable 360 degrees by controlling grounding clamp on cable grounding shelf.
- 3) Connect jumper in factory.
- 4) **Note:** Use shielded twisted-pair cables for digital signals .

Input signals

- PID setpoint (AI1)
- PID feedback (AI2)
- Start / stop selection, EXT 1 (DI1)
- Run enable (DI2)
- EXT 1/ EXT 2 selection (DI3)
- Start / stop selection, EXT 2 (DI6) - **Activate PFC function**

Output signals

- Relay output AO1: Output frequency
 - Relay output AO2: Motor current
 - Relay output 1: Running
 - Relay output 2: Fault (-1)
 - Relay output 3: PFC2 (The 1st PFC auxiliary motor)
-

SPFC macro

Regulate control logic of multiple pumps and fans by drive relay output. activate SPFC macro by selecting basic setting menu, or activate the macro [96.04 Macro select](#) by setting parameter [SPFC macro](#). **SPFC function is valid only when choosing EXT 2**

■ Default control connections for the SPFC macro

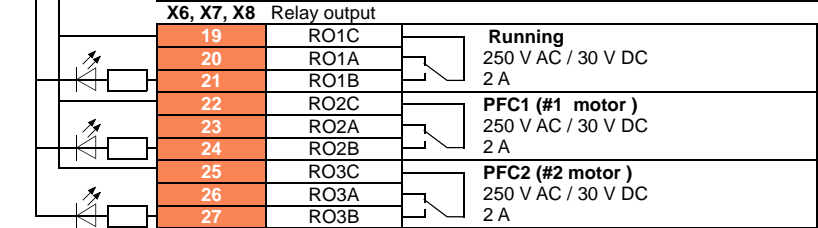
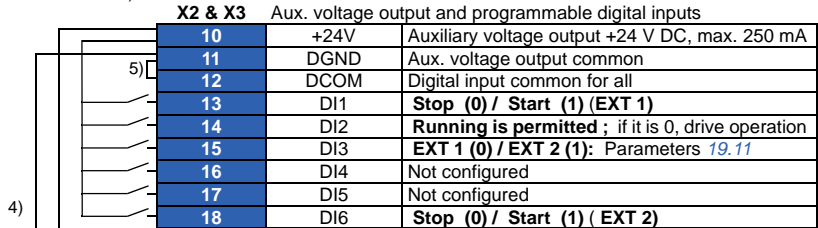
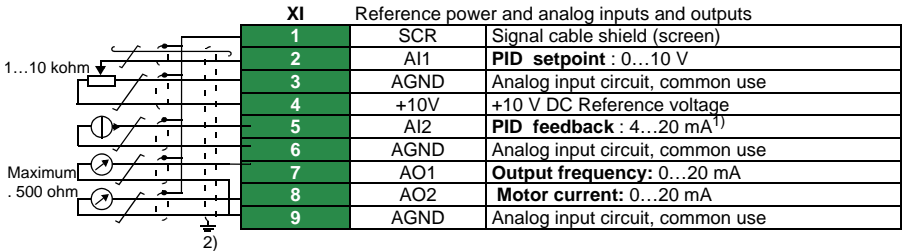

| X5 Embedded fieldbus | | |
|----------------------|------|-------------------------------------------------------------------------------------------|
| 29 | B+ | Embedded Modbus RTU (EIA-485). See chapter 311 on page Fieldbus control . |
| 30 | A- | |
| 31 | DGND | |

(frames size B0-B2)

| | |
|------|-----------|
| S100 | TERM&BIAS |
|------|-----------|

| (frames size R1-R9) | | |
|---------------------|------|------------------------------|
| S100 | TERM | termination resistors switch |
| S200 | BIAS | bias resistors switch |

(frames size B0-B2)

| | |
|----|------|
| 34 | SGND |
| 35 | OUT1 |
| 36 | IN1 |
| 37 | IN2 |

| X4 Delete safe torque (Only for frames size R1-R9) | | |
|----------------------------------------------------|------|-------------------------------------------------------------------------------------------------------------------------------------------------------|
| 34 | OUT1 | Delete safe torque. Factory connection. Both circuits must be closed, before starting drive. See chapter Delete safe torque in drive hardware manual. |
| 35 | OUT2 | |
| 36 | SGND | |
| 37 | IN1 | |
| 38 | IN2 | |

See the notes on the next page

| X10 24 V AC/DC (Only for frames size R6-R9) | | |
|---------------------------------------------|----------------|-----------------------------------------------------------------------------------|
| 40 | 24 V AC/DC- in | 24V AC/DC input to power up the control unit when the main supply is disconnected |
| 41 | 24 V AC/DC+ in | |
| X11 (Only for frames size B0-R2) | | |
| 42 | +24 V | Auxiliary voltage output +24 V DC, max. 250 mA |
| 43 | DGND | Aux. voltage output common |
| 44 | DCOM | Digital input common for all |

Terminal size:

B0...R9: 0.14...1.5 mm²(All terminals)

Tightening torque: 0.5...0.6 N·m (0.4 lbf·ft)

Notes:

- 1) Hand: 0...10 V -> Frequency reference.
PID: 0...10 V -> 0...100% PID set point.
- 2) The signal source is powered externally. See the manufacturer's instructions. To use sensors supplied by the drive auxiliary voltage output, see chapter *Electrical installation*, section Connection examples of two-wire and three-wire sensors in the *Hardware manual* of the drive.
- 3) If Constant frequency is activated it overrides the reference from the PID controller output.
- 4) Ground the outer shield of the cable 360 degrees under the grounding clamp on the grounding shelf for the control cables.
- 5) Connected with jumpers at the factory.
- 6) Use shielded twisted-pair cables for digital signals.

Input signals

- PID setpoint (AI1)
- PID feedback (AI2)
- Start/stop Selection, EXT1 (DI1)
- Run enable (DI2)
- EXT1 / EXT 2 Selection (DI3)
- Start/stop Selection, EXT 2 (DI6) - **activate SPFC function**

Output signals

- Analog output AO1: output frequency
 - Analog output AO2: output frequency
 - Relay output 1: running
 - Relay output 2: PFC 1 motor
 - Relay output 3: PFC 2 motor
-

Control panel PID macro

Default control connections for PID control macro

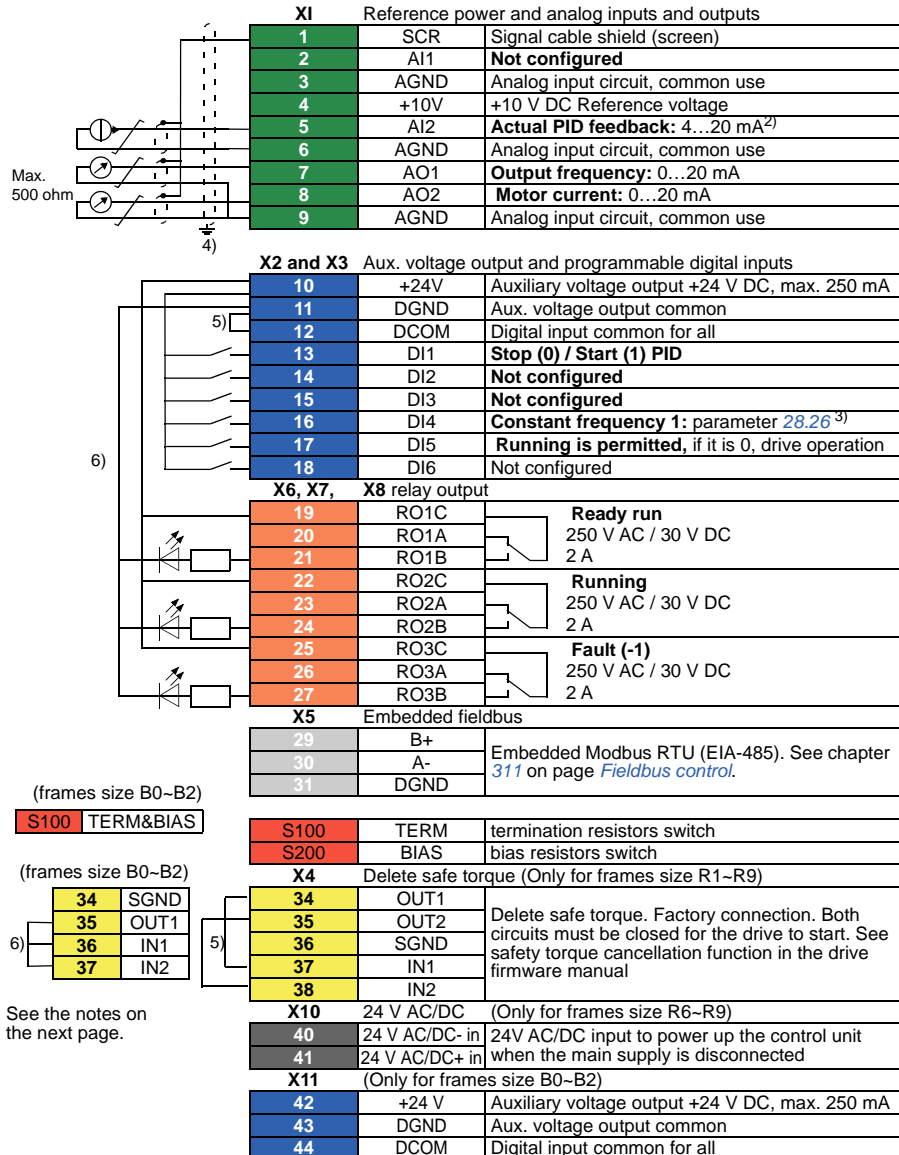

See the notes on the next page.

Terminal size:

B0...R9: 0.14...1.5 mm² (All terminals)

Tightening torque: 0.5...0.6 N·m (0.4 lbf·ft)

Notes:

- 1) Hand: 0...10 V -> Frequency reference.
PID: 0...10 V -> 0...100% PID set point.
- 2) The signal source is powered externally. See the manufacturer's instructions. To use sensors supplied by the drive auxiliary voltage output, see chapter *Electrical installation*, section Connection examples of two-wire and three-wire sensors in the *Hardware manual* of the drive.
- 3) If Constant frequency is activated it overrides the reference from the PID controller output.
- 4) Ground the outer shield of the cable 360 degrees under the grounding clamp on the grounding shelf for the control cables.
- 5) Connected with jumpers at the factory.
- 6) Use shielded twisted-pair cables for digital signals.

Input signals

- PID setpoint is from Control panel reference
- PID feedback (AI2)
- Start/Stop selection, PID (DI1)
- Constant frequency 1 (DI4)
- Running enable (DI5)

Output signals

- Analog output AO1: output frequency
 - Analog output AO2: output frequency
 - Relay output 1: Ready run
 - Relay output 2: running
 - Relay output 3: fault (-1)
-

Parameter default values for different macros

The *Parameter* chapter gives default values for all parameters of ABB standard macro (factory macro). For other macros, some parameters have different default values. The table below lists the default values of these parameters for each macro.

| 96.04 Macro select | 1 = ABB standard | 11 = 3- wire | 12 = Alternate | 13 = Motor potentiometer | 2 = Hand/Auto |
|-----------------------------|------------------------------------------|-----------------------------------------|------------------------------------------------------|------------------------------------------|------------------------------------------|
| 10.24 RO1 source | 2 = Ready run | 2 = Ready run | 2 = Ready run | 2 = Ready run | 2 = Ready run |
| 10.27 RO2 source | 7 = Running | 7 = Running | 7 = Running | 7 = Running | 7 = Running |
| 10.30 RO3 source | 15 = Fault (-1) | 15 = Fault (-1) | 15 = Fault (-1) | 15 = Fault (-1) | 15 = Fault (-1) |
| 12.20 AI1 maximum | 50.0 | 50.0 | 50.0 | 50.0 | 50.0 |
| 13.12 AO1 signal source | 2 = Output frequency | 2 = Output frequency | 2 = Output frequency | 2 = Output frequency | 2 = Output frequency |
| 13.18 AO1 signal source max | 50.0 | 50.0 | 50.0 | 50.0 | 50.0 |
| 19.11 Ext1/Ext2 sel | 0 = EXT1 | 0 = EXT1 | 0 = EXT1 | 0 = EXT1 | 5 = DI3 |
| 20.01 Ext1 commands | 2 = in1 Start forward; in2 Start reverse | 5 = in1P Start; in2 Stop; in3 Direction | 3 = in1P Start forward; in2P Start reverse; in3 Stop | 2 = in1 Start forward; in2 Start reverse | 2 = in1 Start forward; in2 Start reverse |
| 20.03 Ext1 in 1 | 2 = DI1 | 2 = DI1 | 2 = DI1 | 2 = DI1 | 2 = DI1 |
| 20.04 Ext1 in 2 | 3 = DI2 | 3 = DI2 | 3 = DI2 | 3 = DI2 | 3 = DI2 |
| 20.05 Ext1 in 3 | 0 = Not selected | 4 = DI3 | 0 = Not selected | 0 = Not selected | 0 = Not selected |
| 20.06 Ext2 commands | 0 = Not selected | 0 = Not selected | 0 = Not selected | 0 = Not selected | 2 = in1 Start forward; in2 Start |
| 20.08 Ext2 in 1 | 0 = Not selected | 0 = Not selected | 0 = Not selected | 0 = Not selected | 7 = DI6 |
| 20.09 Ext2 in 2 | 0 = Not selected | 0 = Not selected | 0 = Not selected | 0 = Not selected | 6 = DI5 |
| 20.12 Run enable 1 source | 1 = Select | 1 = Select | 7 = DI6 | 7 = DI6 | 5 = DI4 |

| 96.04 Macro select | 3 = Hand/Auto | 14 = PID | 16 = PFC | 15 = Panel PID | 18 = SPFC |
|--------------------------------|----------------------|----------------------|----------------------|-----------------------|----------------------|
| 10.24 RO1 source | 2 = Ready run | 2 = Ready run | 7 = Running | 2 = Ready run | 7 = Running |
| 10.27 RO2 source | 7 = Running | 7 = Running | 15 = Fault (-1) | 7 = Running | 43=PFC1 |
| 10.30 RO3 source | 15 = Fault (-1) | 15 = Fault (-1) | 44 = PFC2 | 15 = Fault (-1) | 44=PFC2 |
| 12.20 AI1 maximum scaled value | 50.0 | 50.0 | 50.0 | 50.0 | 50.0 |
| 13.12 AO1 signal source | 2 = Output frequency | 2 = Output frequency | 2 = Output frequency | 2 = Output frequency | 2 = Output frequency |
| 13.18 AO1 signal source max | 50.0 | 50.0 | 50.0 | 50.0 | 50.0 |
| 19.11 Ext1/Ext2 sel | 4 = DI2 | 0 = EXT1 | 5 = DI3 | 0 = EXT1 | 5 = DI3 |
| 20.01 Ext1 commands | 1 = in1 Start | 1 =in1 Start | 1 =in1 Start | 1 =in1 Start | 1 =in1 Start |
| 20.03 Ext1 in 1 | 2 = DI1 | 2 = DI1 | 2 = DI1 | 2 = DI1 | 2 = DI1 |
| 20.04 Ext1 in 2 | 0 = Not selected | 0 = Not selected | 0 = Not selected | 0 = Not selected | 0 = Not selected |
| 20.05 Ext1 in 3 | 0 = Not selected | 0 = Not selected | 0 = Not selected | 0 = Not selected | 0 = Not selected |
| 20.06 Ext2 commands | 1 = in1 Start | 0 = Not selected | 1 = in1 Start | 0 = Not selected | 1 = in1 Start |
| 20.08 Ext2 in 1 | 7 = DI6 | 0 = Not selected | 7 = DI6 | 0 = Not selected | 7 = DI6 |
| 20.09 Ext2 in 2 | 0 = Not selected | 0 = Not selected | 0 = Not selected | 0 = Not selected | 0 = Not selected |
| 20.12 Run enable 1 source | 6 = DI5 | 6 = DI5 | 3 = DI2 | 6 = DI5 | 3 = DI2 |

| 96.04 Macro select | 1 = ABB standard | 11 = 3- wire | 12 = Alternate | 13 = Motor potentiometer | 2 = Hand/Auto |
|-------------------------------------------------------|-------------------------|----------------------|-----------------------|---------------------------------|----------------------|
| 22.71 Motor potentiometer function | 0 = inhibited | 0 = inhibited | 0 = inhibited | 1 = Enabled (init at power-up) | 0 = inhibited |
| 22.73 Motor potentiometer up source | 0 = Not selected | 0 = Not selected | 0 = Not selected | 4 = DI3 | 0 = Not selected |
| 22.74 Motor potentiometer down source | 0 = Not selected | 0 = Not selected | 0 = Not selected | 5 = DI4 | 0 = Not selected |
| 28.11 Ext1 frequency ref1 | 1 = AI1 scaled value | 1 = AI1 scaled value | 1 = AI1 scaled value | 15 = Motor potentiometer | 1 = AI1 scaled value |
| 28.15 Ext1 frequency ref 2 | 0 = Zero | 0 = Zero | 0 = Zero | 0 = Zero | 2 = AI2 scaled value |
| 28.22 Constant frequency sel 1 | 4 = DI3 | 5 = DI4 | 4 = DI3 | 6 = DI5 | 0 = Not selected |
| 28.23 Constant frequency sel 2 | 5 = DI4 | 6 = DI5 | 5 = DI4 | 0 = Not selected | 0 = Not selected |
| 28.71 Freq ramp set selection | 6 = DI5 | 0 = Acc/Dec time 1 | 6 = DI5 | 0 = Acc/Dec time 1 | 0 = Acc/Dec time 1 |
| 40.07 Process PID operation mode | 0 = Off | 0 = Off | 0 = Off | 0 = Off | 0 = Off |
| 40.16 Reference group 1 set value 1 signal source | 11 = AI1 percent | 11 = AI1 percent | 11 = AI1 percent | 11 = AI1 percent | 11 = AI1 percent |
| 40.17 Reference group 1 set value 2 signal source | 0 = Not selected | 0 = Not selected | 0 = Not selected | 0 = Not selected | 0 = Not selected |
| 40.19 Reference group 1 internal setpoint selection 1 | 0 = Not selected | 0 = Not selected | 0 = Not selected | 0 = Not selected | 0 = Not selected |
| 40.20 Reference group 1 internal setpoint selection 2 | 0 = Not selected | 0 = Not selected | 0 = Not selected | 0 = Not selected | 0 = Not selected |
| 40.32 Reference group 1 gain | 1.00 | 1.00 | 1.00 | 1.00 | 1.00 |
| 40.33 Reference group 1 integration time | 60.0 | 60.0 | 60.0 | 60.0 | 60.0 |
| 76.21 PFC Configuration | 0 = Off | 0 = Off | 0 = Off | 0 = Off | 0 = Off |
| 76.25 Number of motors | 1 | 1 | 1 | 1 | 1 |
| 76.27 Maximum number of motors | 1 | 1 | 1 | 1 | 1 |

| 96.04 Macro select | 3 = Hand/Auto | 14 = PID | 16 = PFC | 15 = Panel PID | 18 = SPFC |
|-------------------------------------------------------|-------------------------------|-------------------------------|-------------------------------|-------------------------------------------|-------------------------------|
| 22.71 Motor potentiometer function | 0 = inhibited | 0 = inhibited | 0 = inhibited | 0 = inhibited | 0 = inhibited |
| 22.73 Motor potentiometer up source | 0 = Not selected | 0 = Not selected | 0 = Not selected | 0 = Not selected | 0 = Not selected |
| 22.74 Motor potentiometer down source | 0 = Not selected | 0 = Not selected | 0 = Not selected | 0 = Not selected | 0 = Not selected |
| 28.11 Ext1 frequency ref1 | 16 = PID | 16 = PID | 1 = AI1 scaled value | 16 = PID | 1 = AI1 scaled value |
| 28.15 Ext2 frequency ref1 | 16 = PID | 0 = Zero | 16 = PID | 0 = Zero | 16 = PID |
| 28.22 Constant frequency sel 1 | 4 = DI3 | 5 = DI4 | 0 = Not selected | 5 = DI4 | 0 = Not selected |
| 28.23 Constant frequency sel 2 | 5 = DI4 | 0 = Not selected | 0 = Not selected | 0 = Not selected | 0 = Not selected |
| 28.71 Freq ramp set selection | 0 = Acc/Dec time 1 | 0 = Acc/Dec time 1 | 0 = Acc/Dec time 1 | 0 = Acc/Dec time 1 | 0 = Acc/Dec time 1 |
| 40.07 Process PID operation mode | 2 = When the drive is running | 2 = When the drive is running | 2 = When the drive is running | 2 = When the drive is running | 2 = When the drive is running |
| 40.16 Reference group 1 set value 1 signal source | 11 = AI1 percent | 11 = AI1 percent | 11 = AI1 percent | 13=Control panel (reference saved) saved) | 11 = AI1 percent |
| 40.17 Reference group 1 set value 2 signal source | 0 = Not selected | 2 = Internal setpoint | 0 = Not selected | 0 = Not selected | 0 = Not selected |
| 40.19 Reference group 1 internal setpoint selection 1 | 0 = Not selected | 3 = DI2 | 0 = Not selected | 0 = Not selected | 0 = Not selected |
| 40.20 Reference group 1 internal setpoint selection 2 | 0 = Not selected | 4 = DI3 | 0 = Not selected | 0 = Not selected | 0 = Not selected |
| 40.32 Reference group 1 gain | 1.00 | 1.00 | 2.50 | 1.00 | 2.50 |
| 40.33 Reference group 1 integration time | 60.0 | 60.0 | 3.0 | 60.0 | 3.0 |
| 76.21 PFC Configuration | 0 = Off | 0 = Off | 2 = PFC | 0 = Off | 3 = SPFC |
| 76.25 Number of motors | 1 | 1 | 2 | 1 | 2 |
| 76.27 Maximum number of motors | 1 | 1 | 2 | 1 | 2 |

4

Function description

Contents of this chapter

This chapter describes some of the more important functions within the control program, how to use them and how to program them to operate.

Local control vs. external control

The ACS530 has two main control locations: external and local. The control location is selected with the Loc/Rem key on the control panel or in the PC tool.

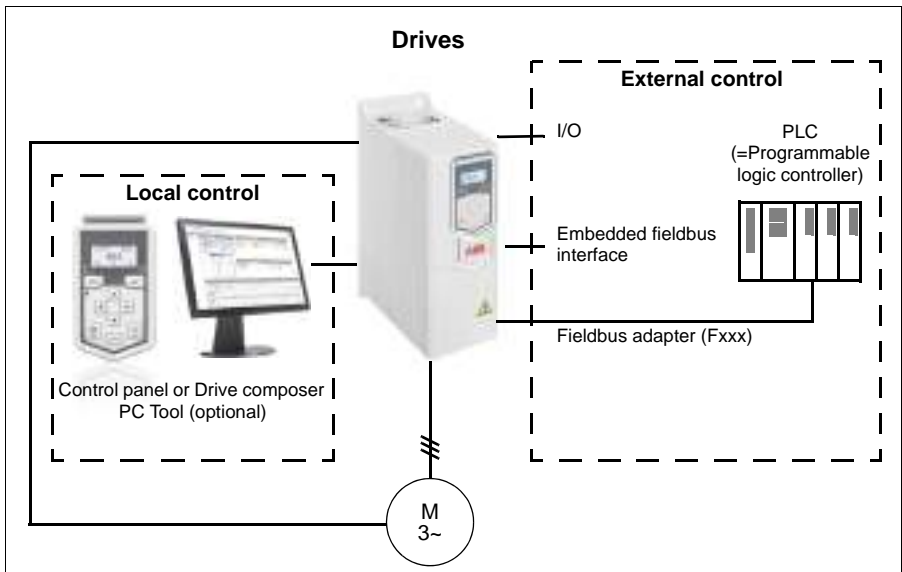

■ Local control

The control commands are given from the control panel keypad or from a PC equipped with Drive composer when the drive is in local control.

Local control is mainly used for debugging and service. The control panel always overrides the external control signal sources when used in local mode. Changing the control location to local can be prevented by parameter [19.17 Local control disable](#).

The user can select by a parameter ([49.05 Communication loss action](#)) how the drive reacts to a control panel or PC tool communication break (The parameter has no effect in external control).

■ External control

When the drive is in external control, control commands are given through:

- the I/O terminals (digital and analog inputs)
- the fieldbus interface (via the embedded fieldbus interface or an optional fieldbus adapter module)

It provides two external control locations: external 1 and external 2. The user can select the sources of the start and stop commands separately for each control location by parameters [20.01...20.10](#). The operating mode can be selected separately for each location, which enables quick switching between different operating modes. Selection between EXT1 and EXT2 is done via any binary source such as a digital input or fieldbus control word (parameter [19.11 Ext1/Ext2 sel](#)). The source of reference is selectable for each operating mode separately.

Diagram: Run enable source for EXT1

The figure below shows the parameters that select the interface for run enable for external control location [Ext1 commands](#).

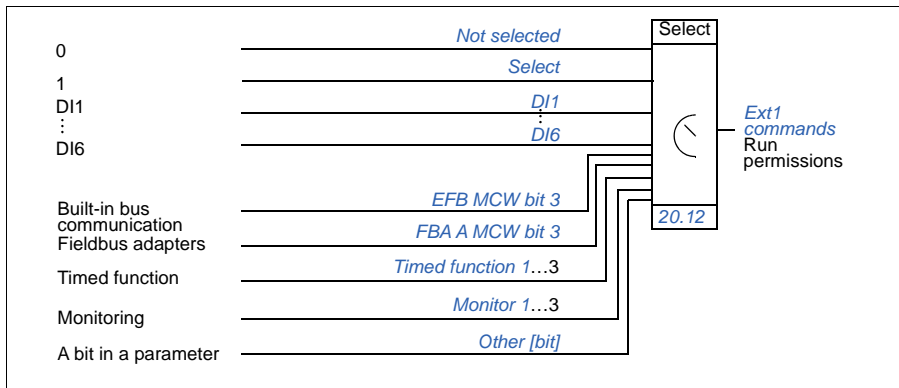

Settings

- Parameters [19.11 Ext1/Ext2 sel](#) (page 128); [20.01...20.10](#) (page 172).

Motor potentiometer

The motor potentiometer is, in effect, a counter whose value can be adjusted up and down using two digital signals selected by parameters [22.73 Motor potentiometer up source](#) and [22.74 Motor potentiometer down source](#).

When enabled by [22.71 Motor potentiometer function](#), the motor potentiometer assumes the value set by [22.72 Motor potentiometer initial value](#). Depending on the mode selected in [22.71](#), the motor potentiometer value is either retained or reset over a power cycle.

The change rate is defined in [22.75 Motor potentiometer ramp time](#) as the time it would take for the value to change from the minimum ([22.76 Motor potentiometer min value](#)) to the maximum ([22.77 Motor potentiometer max value](#)) or vice versa. If the up and down signals are simultaneously on, the motor potentiometer value does not change.

The output of the function is shown by [22.80 Motor potentiometer ref act](#), which can directly be set as the reference source in the main selector parameters, or used as an input by other source selector parameters.

The following example shows the behavior of the motor potentiometer value.

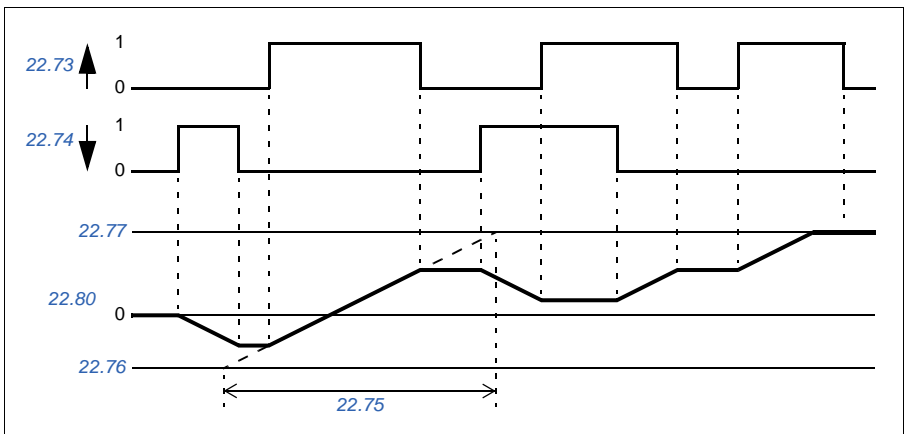

Settings

Parameters [22.71...22.80](#) (Page 187).

Operating modes of the drive

The drive can operate in several operating modes with different types of reference. The control mode is selectable for each control location (Local, EXT1 and EXT2) in parameter group [19 Operation mode](#).

The following is a general representation of the reference types and control chains. The page numbers refer to detailed diagrams in chapter [Control chain diagrams](#).

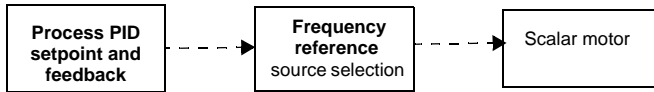

■ Frequency control mode

The motor follows a frequency reference given to the drive.

■ Special control modes

In addition to the control modes mentioned above, the following special control mode is available:

- Process PID control. For more information, see section [Process PID control](#) (page [74](#)).
- Emergency stop OFF1 and OFF3: Drive stops along the defined deceleration ramp and drive modulation stops.
- Pre-magnetization: refers to the DC magnetization of the motor before start. For more information, see section [Pre-magnetization](#) (page [70](#)).
- DC hold: Locking the rotor at (near) zero speed in the middle of normal operation. For more information, see section [DC hold](#) (page [70](#)).
- Pre-heating (motor heating): Keeping the motor warm when the drive is stopped. For more information, see section [Pre-heating \(Motor heating\)](#) (page [71](#)).

Converter configuration and programming

The drive control program performs the main control functions, including frequency control, drive logic (start/stop), I/O, feedback, communication and protection functions. Control program functions are configured and programmed with parameters.

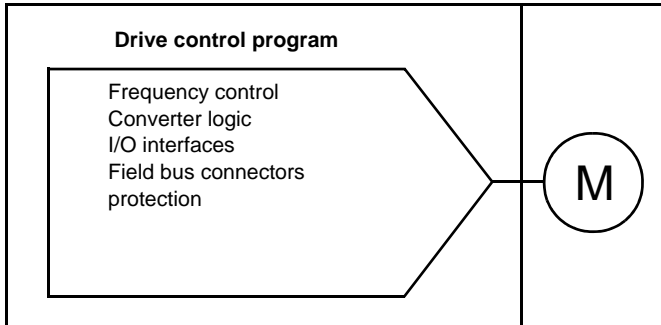

■ Configuring via parameters

Parameters can be configured by all standard drive operation and can be set via below modes:

- the control panel, as described in chapter [Control panel](#)
- Drive composer PC tool, as described in *Drive composer* user's manual (3AUA0000094606 [English]), or
- the fieldbus interface, as described in chapter [Fieldbus control](#)

All parameter settings are stored automatically to the permanent memory of the drive. However, if an external +24V DC power supply is used for the drive control unit; it is highly recommended to force a save by using parameter [96.07 Parameter save manually](#) before powering down the control unit after any parameter changes have been made.

If necessary, the default parameter values can be restored by parameter [96.06 Parameter restore](#).

Motor control

■ Motor type

The drive supports asynchronous AC induction motor.

■ Reference ramping

Acceleration and deceleration ramping times can be set individually for frequency reference.

Under a frequency reference, the ramps are defined as the time needed for the drive to accelerate or decelerate zero frequency and parameter [46.02 Frequency fieldbus scaled value](#). The user can switch between two preset ramps using a binary source, such as a digital input.

Variable slope

Variable slope controls the slope of the frequency reference ramp during a reference change. With this feature a constantly variable ramp can be used.

Variable slope is only supported in remote control.

Settings

- Frequency reference slope: reference [28.71...28.75](#) and [46.02](#).
- Motor potentiometer: parameter [22.75](#).

■ Constant frequency

Constant frequency is a predefined reference that can be quickly activated through digital inputs etc. It is possible to define up to 7 speeds for speed control and 7 constant frequencies for frequency control.



Warning: Constant frequency override the normal reference irrespective of where the reference is coming from.

Settings

- Parameter groups [28 Frequency reference chain](#) (page [189](#)).

■ Critical frequency

Critical frequency (sometimes called "skip frequency") can be predefined for applications where it is necessary to avoid certain motor speeds or speed ranges because of, for example, mechanical resonance problems.

The critical frequency function prevents the reference from dwelling within a critical band for extended times. When a changing reference (28.96 frequency reference 7 actual value) enters a critical range, the output of the function freezes (28.01 frequency reference) until the reference exits the range. Any instant change in the output is smoothed out by the ramping function further in the reference chain.

When the frequency reference is limited within some dangerous frequency range, the output frequency will be limited to the lower limit of the dangerous frequency range (in case of acceleration) or to the upper limit (in case of deceleration).

Settings

- Critical frequencies: parameters [28.51...28.57](#) (page [196](#)).

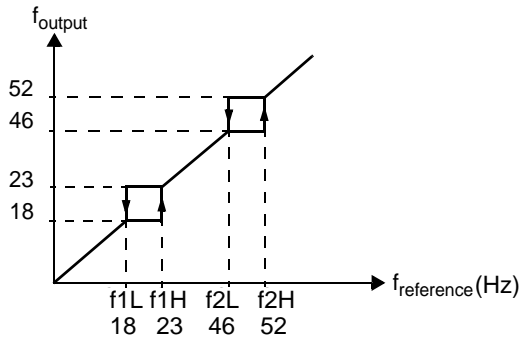

■ Scalar control

Scalar motor control is the default motor control method. In scalar control mode, the drive is controlled with a frequency reference value.

See also section [Operating modes of the drive](#) (page [66](#)).

IR compensation

The IR compensation (also known as voltage boost) is activated when the motor control mode is scalar. When the IR compensation is activated, the drive gives an extra voltage boost to the motor at low speed. The IR compensation is useful in applications that require a high break-away torque.

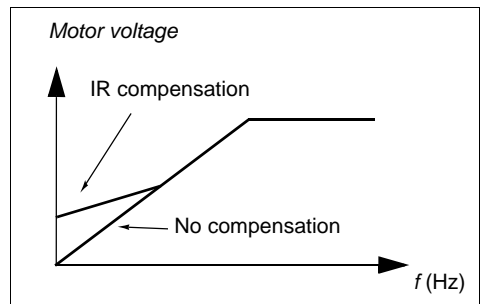

Settings

- Parameters [97.13 IR compensation](#) (page [308](#))
- Parameter groups [28 Frequency reference chain](#) (page [189](#)).

■ **U/f ratio**

The voltage/frequency function is only available in scalar control mode (using frequency control).

The function has two modes: linear and squared.

In linear mode, the ratio of voltage to frequency is constant below the field weakening point.

In squared mode (default), the ratio of the voltage to frequency increases as the square of the frequency below the field weakening point. This is typically used in centrifugal pump or fan applications. For these applications, the torque required follows the square relationship with frequency.

The voltage/frequency cannot be used with energy optimization; if parameter [45.11 Energy \(flux\) optimization](#) is set to valid, parameter [97.20 U/F ratio](#) is ignored.

Settings

- Parameter [97.20 U/F ratio](#) (page [308](#)).

■ **DC magnetization**

The drive has different magnetization functions for different phases of motor start/rotation/stop: pre-magnetization, DC hold, post-magnetization and pre-heating (motor heating).

Pre-magnetization

Pre-magnetization refers to the DC magnetization of the motor before start. Pre-magnetization can be applied to guarantee the highest possible start torque, up to 200% of the nominal torque of the motor. By adjusting the pre-magnetization time ([21.02 Magnetization time](#)), it is possible to synchronize the motor start and, for example, the release of a mechanical brake.

Settings

Parameters [21.19 Scalar start mode](#), [21.02 Magnetization time](#).

DC hold

The function makes it possible to lock the rotor at (near) zero speed in the middle of normal operation. DC hold is activated by parameter [21.08 DC current control](#). When both the reference and motor speed drop to parameter [21.21](#) reference, the drive will stop generating sinusoidal current and start to inject DC into the motor. The current is

set by parameter [21.10 DC current reference](#). When the reference exceeds parameter [21.21 DC hold frequency](#), normal drive operation continues.

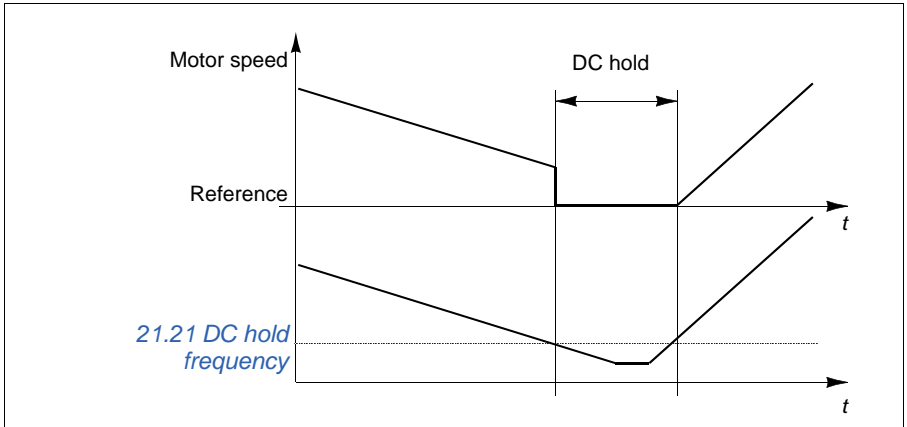

Settings

Parameter [21.08 DC current control](#).

Pre-heating (Motor heating)

The pre-heating function keeps the motor warm and prevents condensation inside the motor by feeding it with DC current when the drive has been stopped. The heating can only be activated when the drive is in the stopped state, and starting the drive stops the heating.

The heating is started 60 seconds after zero speed has been reached or modulation has been stopped to prevent excessive current if coast stop is used.

The function can be defined to be always active when the drive is stopped or it can be activated by a digital input, fieldbus, timed function or supervision function. For example, with the help of signal supervision function, the heating can be activated by a thermal measurement signal from the motor.

The pre-heating current fed to the motor can be defined as 0...30% of the nominal motor current.

The drive generates a warning when the pre-heating is active to indicate that current is being fed to the motor.

Notes:

- In applications where the motor keeps rotating for a long time after the modulation is stopped, it is recommended to use ramp stop with pre-heating to prevent a sudden pull at the rotor when the pre-heating is activated.
- The heating function requires that run enable, interlock and STO signals are active.
- The heating function requires that the drive is not faulted.
- Pre-heating uses DC hold to produce current.

Settings

- Parameters [21.14 Pre-heating input source](#) and [21.16 Pre-heating current](#) (page [184](#))

■ Energy optimization

Function optimizes the motor flux so that the total energy consumption and motor noise level are reduced when the drive operates below the nominal load. Total efficiency (motor and drive) can be improved by 1...20% depending on the load torque and speed.

Settings

- Parameter [45.11 Energy \(flux\) optimization](#) (page [262](#))

■ Switching frequency

The drive has two switching frequencies: reference switching frequency and minimum switching frequency. The drive tries to keep the highest allowed switching frequency (= reference switching frequency) if thermally possible, and then adjusts dynamically between the reference and minimum switching frequencies depending on the drive temperature. When the drive reaches the minimum switching frequency (= lowest allowed switching frequency), it starts to limit output current as the heating up continues.

For derating, see chapter Technical data, section *Switching frequency derating* in the Hardware manual of the drive.

Example 1: If you need to fix the switching frequency to a certain value as with some external filters (same as part of external filter), set both the reference and the minimum switching frequency to this value and the drive will retain this switching frequency.

Example 2: If the reference switching frequency is set to 8kHz and the minimum switching frequency is set to 4kHz, the drive maintains the highest possible switching frequency to reduce motor noise and only when the drive heats it will decrease the switching frequency. This is useful, for example, in applications where low noise is necessary but higher noise can be tolerated when the full output current is needed.

Settings

Parameters [97.01 Switching frequency reference](#) and [97.02 Minimum switching frequency](#) (page 307).

Application control

■ Application macros

Control macros are predefined parameter edits and I/O configurations. See [Application macros](#) Chapter (page 29).

■ Process PID control

There is an embedded process PID controller in the drive. The controller can be used to control process such as pressure or flow in the pipe or fluid level in the container.

In process PID control, a process reference (setpoint) is connected to the drive instead of a speed reference. An actual value (process feedback) is also brought back to the drive. The process PID control adjusts the drive speed in order to keep the measured process quantity (actual value) at the desired level (setpoint). This means that user does not need to set a frequency reference to the drive but the drive adjusts its operation according to the process PID.

The simplified block diagram below illustrates the process PID control.

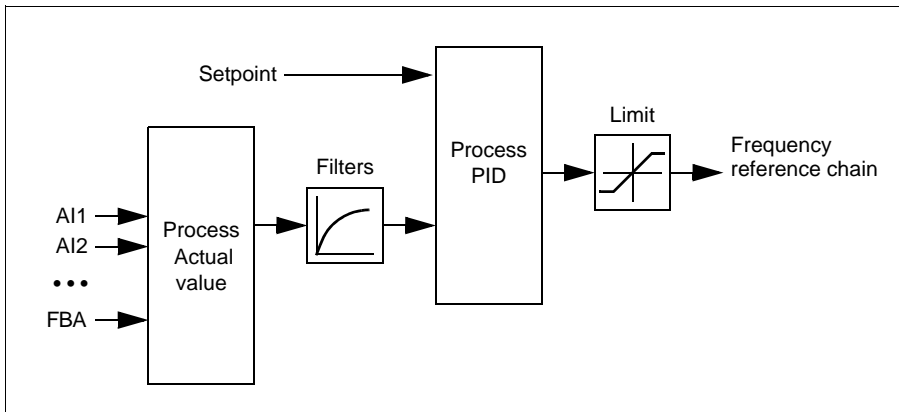

The drive contains two complete sets of process PID controller settings that can be alternated whenever necessary; see parameter [40.57 PID set1/set2 selection](#).

Note: Process PID control is only available in external control; see section [Local control vs. external control](#) (page 63).

Configuration of the process PID controller

1. PID controller during activation: **PID - PID control**
2. Selection of feedback source: **PID - feedback value**
3. Select a setpoint source **PID - setpoint**
4. Set the gain, integration time, derivation time: **PID - parameter setting**
5. Set PID output limit: **PID - PID output**
6. Select the PID controller output as the source.

Sleep and boost functions for process PID control.

The sleep function is suitable for PID control applications where the consumption varies, such as clean water pumping systems. When used, it stops the pump completely during low demand, instead of running the pump slowly below its efficient operating range. The following example visualizes the operation of the function.

Example: The drive controls a pressure boost pump. The water consumption falls at night. As a consequence, the process PID controller decreases the motor speed. However, due to natural losses in the pipes and the low efficiency of the centrifugal pump at low speeds, the motor would never stop rotating. The sleep function detects the slow rotation and stops unnecessary pumping after the sleep delay has passed. The drive shifts into sleep mode, still monitoring the pressure. The pumping resumes when the pressure falls under the predefined minimum level and the wake-up delay has passed.

The user can extend the PID sleep time by the boost functionality. The boost functionality increases the process setpoint for a predetermined time before the drive enters the sleep mode.

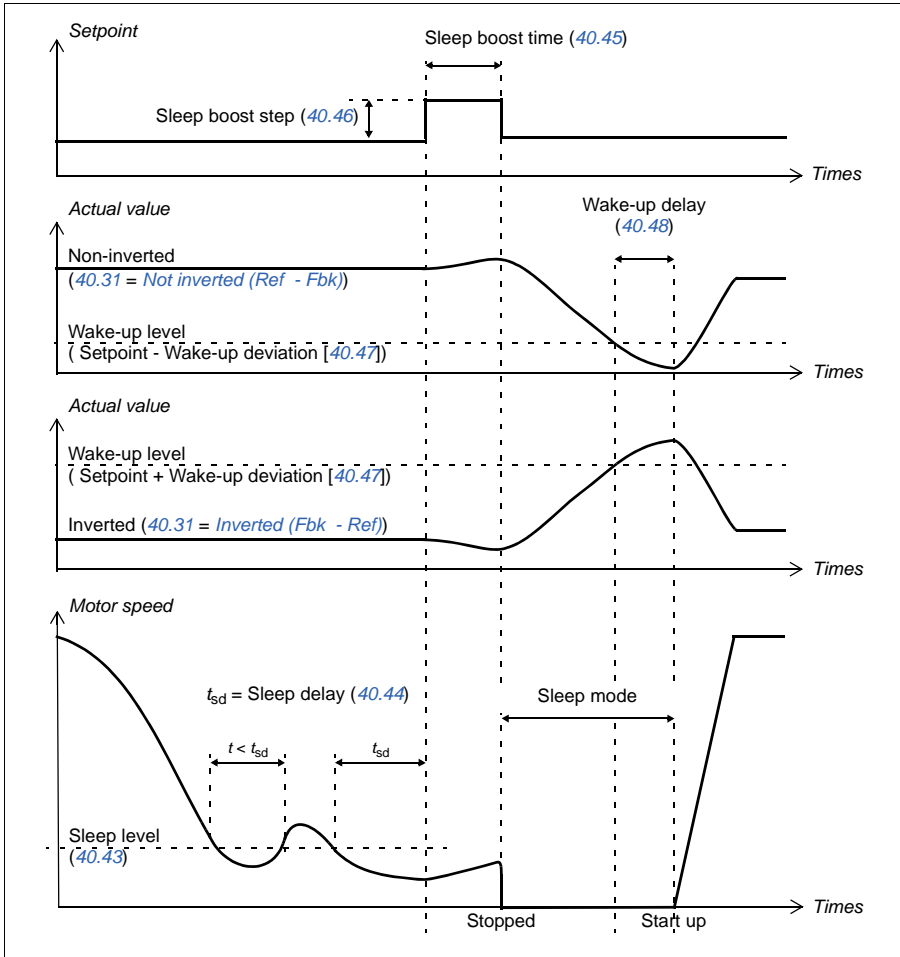

Tracking

In tracking mode, the PID block output is set directly to the value of parameter 40.50 (or 41.50) *Reference group 1 tracking reference selection*. The internal I term of the PID controller is set so that no transient is allowed to pass on to the output, so when the tracking mode is left, normal process control operation can be resumed without a significant bump.

Settings

- Parameter [96.04 Macro select](#) (macro selection)
- Parameter groups [40 Process PID set 1](#) (page 240) and [41 Process PID set 2](#) (page 255).

■ Pump and fan control (PFC)

Pump and fan control (PFC) is used in pump or fan systems consisting of one drive and multiple pumps or fans /. The drive drives a pump /an directly for frequency control and controls the start and stop of the rest pump / fan directly hung with a contactor.

The PFC control logic switches auxiliary motors on and off as required by the capacity changes of the process. In a pump application for example, the drive controls the motor of the first pump, varying the motor speed to control the output of the pump. This pump is the speed regulated pump. When the demand (represented by the process PID reference) exceeds the capacity of the first pump (a user defined speed / frequency limit), the PFC logic automatically starts an auxiliary pump. The PFC logic also reduces the speed of the first pump, controlled by the drive, to account for the addition to the total system output by the auxiliary pump. Then, PID controller adjusts the speed/frequency of the first pump in such a way that the system output meets the process needs. If the demand continues to increase, the PFC logic adds further auxiliary pumps, in a similar manner as just described.

As the process need drops, the PFC logic will make the speed of the first pump fall below a minimum limit (a user defined as a speed / frequency limit), the PFC logic automatically stops an auxiliary pump. Meanwhile, the PFC logic also increases the speed of the first pump to balance the total system output after the auxiliary pump being reduced.

The PFC control logic is effective only when the control location is EXT 2.

Autochange

The Autochange functionality has two main purposes in PFC application. The Autochange functionality has two main purposes in PFC application. The other is to prevent any pump/fan from standing still for too long, which would clog up the unit.

The Autochange can also be triggered by the Timed function.

Interlock

There is an option to define interlock signals for each motor in the PFC system. When the interlock signal of a motor is Available, the motor participates in the PFC starting sequence. If the signal is Interlocked, the motor is excluded. This feature can be used for informing the PFC logic that a motor is not available (for example due to maintenance or manual direct-on-line starting).

Soft pump and fan control (SPFC)

SPFC is a variant of PFC and it can be used to generate a smaller pressure spike when a new auxiliary motor is put into operation. SPFC can smoothly start the auxiliary motor.

The biggest difference between SPFC and PFC is grid connection method of SPFC for auxiliary motor. When meeting conditions to put new auxiliary motor into operation (see PFC description in the above), the SPFC will directly connect the motor of drive speed adjustment to the power grid, that is, the variable frequency is switched to power frequency under operating condition of motor. Then, the SPFC will connect the next motor to be started and begin to control the motor by frequency control. By the moment, the motor subject to variable frequency switching to power frequency has been connected to grid via contactor. Startup of more motors (auxiliary motors) is subject to switching in the above logic. Motor stop sequence is the same as that of PFC.

The SPFC can reduce start current of auxiliary motor connected to grid and also reduce pressure spike of pipeline and water pump.

Settings

- Parameter [96.04 Macro select](#) (page [127](#))
- Parameter group [10 Standard DI,RO](#) (page [102](#))
- Parameter group [40 Process PID set 1](#) (page [114](#))
- Parameter group [76 PFC configuration](#) (page [125](#)) and [77 PFC maintenance and monitoring](#) (page [126](#))

■ User lock

For the better network security, you should set a master password to prevent parameter value change and / or download of firmware and other files.



Warning! For damage or loss due to failure of user lock activation by new password, ABB will not assume any liability. See [Network Security Disclaimer](#) (page [15](#)).

Enter the [96.02 Passcode](#) default password to activate the user lock for the first time, 10000000. Thus, the parameter [96.100...96.102](#) could be seen. Then, enter [96.100 change user password](#) a new password and confirm password in [96.101 Confirm user password](#). In [96.102 user lock function](#) define the operation to be prevented (you should select all operations, unless otherwise required by applications).

For turning off the user lock, enter [96.02 Passcode](#) a invalid code for activation [96.08 Control board boot](#) or circulating power supply. The parameter [96.100...96.102](#) will be hidden after turning off the user lock.

The parameter [96.100...96.102](#) will be visible again after turning on the lock and entering the password [96.02 Passcode](#).

Settings

Parameter [96.02](#) (page [241](#)) and [96.100...96.102](#) (page [248](#)).

■ Mechanical brake control

A mechanical brake can be used for holding the motor and driven machinery at zero speed when the drive is stopped, or not powered. The brake control logic observes the settings of parameter group [44 Mechanical brake control](#) as well as several external signals, and moves between the states presented in the diagram on page [80](#). The tables below the state diagram detail the states and transitions. The timing diagram on page [81](#) shows an example of a close-open-close sequence.

Inputs of the brake control logic

The start command of the drive (bit 5 of [06.16 Drive status word 1](#)) is the main control source of the brake control logic.

Outputs of the brake control logic

The mechanical brake is to be controlled by bit 0 of parameter [44.01 Brake control status word](#). This bit should be selected as the source of a relay output (or a digital input/output in output mode) which is then wired to the brake actuator through a relay. See the wiring example on page [82](#).

The brake control logic, in various states, will request the drive control logic to hold the motor or ramp down the speed. These requests are visible in parameter [44.01 Brake control status word](#).

Settings

Parameter group [44 Mechanical brake control](#) (page [259](#)).

Brake state diagram

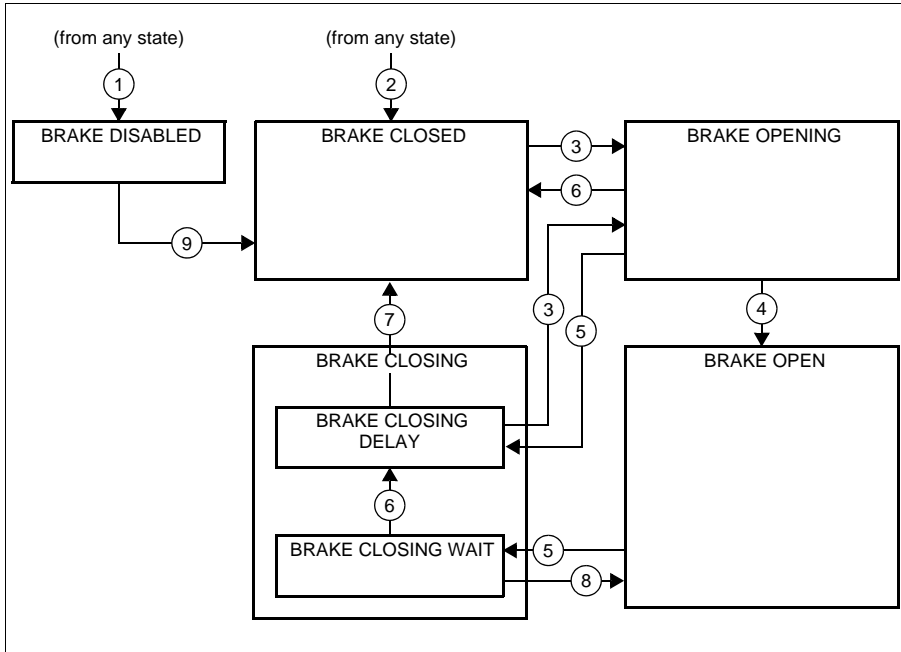

State descriptions

| State name | Description |
|----------------------------|-------------------------------------------------------------------------------------------------------------------------------------------------------------------------------------------------------------------------------------------------------------------------------------------------------------------------------------------------------------------------|
| <i>BRAKE DISABLED</i> | Brake control is disabled (Parameter <i>44.06 Brake control enable</i> = 0, <i>44.01 Brake control status word b4</i> = 0). Start signal activation (<i>44.01 Brake control status word b0</i> = 1). |
| <i>BRAKE OPENING</i> | Brake has been requested to open. (<i>44.01 Brake control status word b2</i> = 1). Start signal is activated (<i>44.01 Brake control status word b0</i> is set). The load is held in place by the speed control of the drive until <i>44.08 BRAKE OPENING DELAY</i> elapses. |
| <i>BRAKE OPEN</i> | The brake is open (<i>44.01 Brake control status word b0</i> = 1). Hold request is removed (<i>44.01 Brake control status word b2</i> = 0), and the drive is allowed to follow the reference. |
| <i>BRAKE CLOSING</i> | |
| <i>BRAKE CLOSING WAIT</i> | Brake has been requested to close. The drive logic is requested to ramp down the speed to a stop (<i>44.01 Brake control status word b3</i> = 1). The open signal is kept active (<i>44.01 Brake control status word b0</i> = 1). The brake logic will remain in this state until the motor speed is below <i>44.14 Brake close level</i> . |
| <i>BRAKE CLOSING DELAY</i> | Closing conditions have been met. The open signal is deactivated (<i>44.01 Brake control status word b0</i> → 0). The ramp-down request is maintained (<i>44.01 Brake control status word b3</i> = 1). The brake logic will remain in this state until <i>44.13 Brake close delay</i> has elapsed. At this point, the logic proceeds to <i>BRAKE CLOSED</i> state. |
| <i>BRAKE CLOSED</i> | The brake is closed (<i>44.01 Brake control status word b0</i> = 0). The drive is not necessarily modulating. |

State change conditions (n)

- 1 Brake control disabled (Parameter [44.06 Brake control enable](#)→ 0).
- 2 [06.11 Main status word](#), bit 2 = 0.
- 3 Brake has been requested to open.
- 4 [44.08 BRAKE OPENING DELAY](#) has elapsed.
- 5 Brake has been requested to close.
- 6 Motor speed is below closing speed [44.14 Brake close level](#).
- 7 [44.13 Brake close delay](#) has elapsed.
- 8 Brake has been requested to open.
- 9 Brake control enabled (Parameter [44.06 Brake control enable](#)→ 1).

Timing diagram

The simplified timing diagram below illustrates the operation of the brake control function. Refer to the state diagram above.

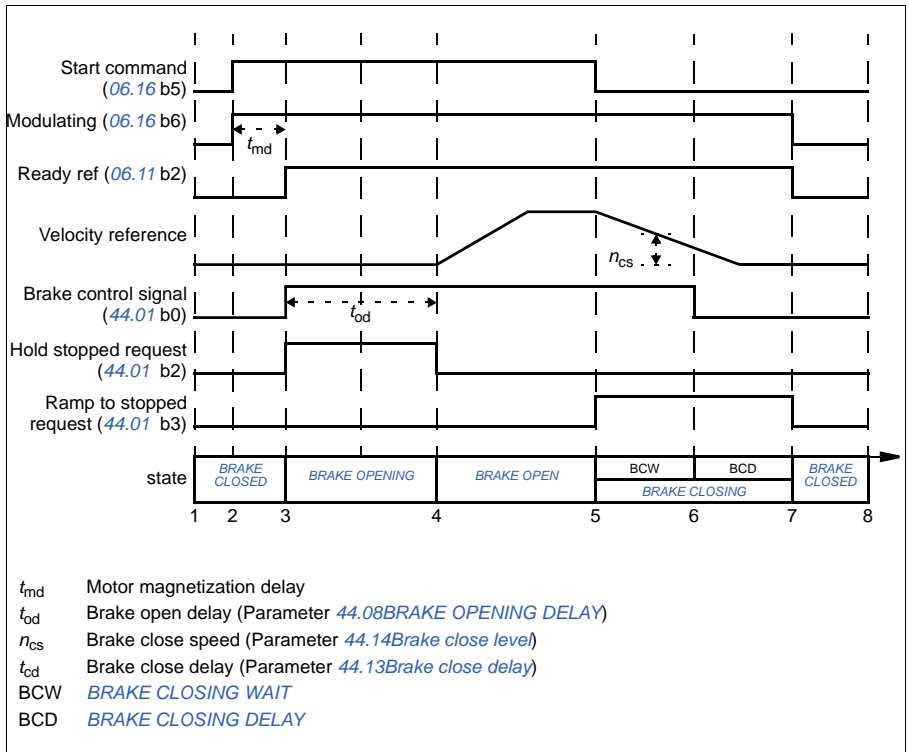

Wiring example

The figure below shows a brake control wiring example. The brake control hardware and wiring is to be sourced and installed by the customer.

Warning! Make sure that the machinery is integrated with the brake control function of drive, and that it fulfills the personnel safety regulations. Note that the frequency drive (a Complete Drive Module or a Basic Drive Module, as defined in IEC/EN 61800-2), is not considered as a safety device mentioned in the European Machinery Directive and related harmonized standards. Thus, the personnel safety of the complete machinery must not be based on a specific drive feature (such as the brake control function), but it has to be implemented as defined in the application specific regulations.

The brake is controlled by bit 0 of parameter [44.01 Brake control status word](#). In this example, Parameter [10.24 RO1 source](#) is set to Brake command (eg. bit 0 of [44.01 Brake control status word](#)).

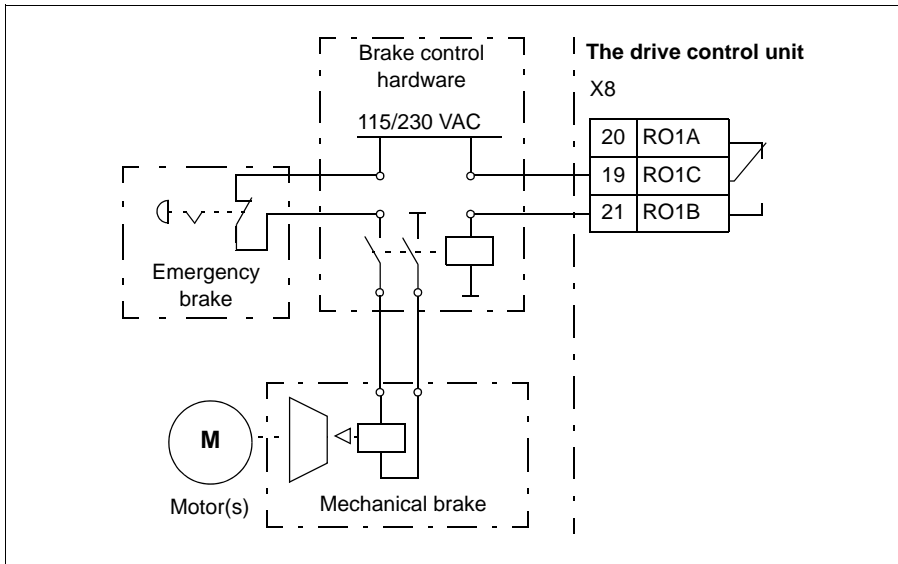

Timed function

With basic panel used in ACS530, you should synchronize the clock through the EFB or a fieldbus module. Set parameter 34.10 Timed functions enable to Disable to disable the timed functions if they are not used. You can also set the system time manually or connect an assistant control panel to the drive to synchronize the clock.

If the system time is not set, the timed functions cannot be used and fault log dates are not correct. And warning A6A7 system time not set.

Settings

Parameter group [34 Timed functions](#) (page 218).

■ Override mode

No.70 parameter group defines activation signal, operating frequency and enabling method of the override mode.

After the override mode is activated by digital input, the acceleration or deceleration will change to preset override operation frequency. After the digital input is released, if start command and enable command are available under external control, the drive will restart and accelerate to normal operating frequency. If the drive is under local control mode when the digital input is released, the drive will stop.

After the override mode is activated:

- The drive runs under preset frequency.
- The drive ignores all commands from the control panel.
- The drive ignores all commands from the communication.
- The drive ignores all digital input signals except / those of activated / inactivated override mode.
- The drive shows the alarm message “0xAFFE Drive is in override mode” (the drive runs in override mode).

The drive will ignore most of faults in the override mode, except the following faults:

| Fault code (hexadecimal) | Fault description |
|--------------------------|----------------------|
| 2310 | Over current |
| 2330 | Ground leakage |
| 2340 | Short circuit |
| 3210 | DC bus overvoltage |
| 5090 | STO hardware fault |
| 5091 | Delete safe torque |
| FA81 | Delete safe torque 1 |

| | |
|------|----------------------|
| FA82 | Delete safe torque 2 |
|------|----------------------|

Settings

Parameter group [70 Override](#) (page [282](#)).

■ User load curve

The User load curve provides a supervisory function that monitors an input signal as a function of frequency or speed, and load. It shows the status of the monitored signal and can give a warning or fault based on the violation of a user defined profile.

The user load curve consists of an overload and an underload curve, or just one of them. Each curve is formed by five points that represent the monitored signal as a function of frequency or speed.

In the example below, the user load curve is constructed from the motor nominal torque to which a 10% margin is added and subtracted. The margin curves define a working envelope for the motor so that excursions outside the envelope can be supervised, timed and detected.

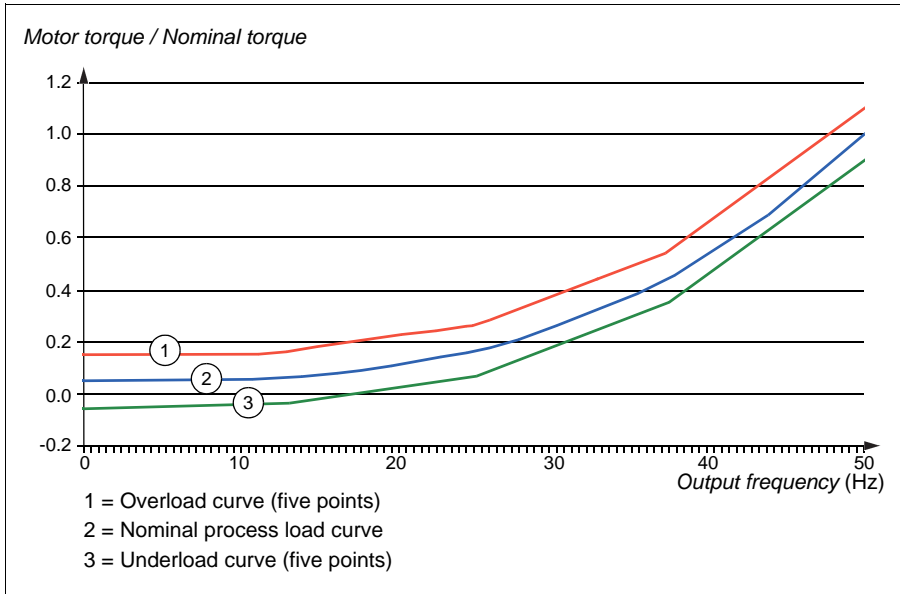

An overload warning and/or fault can be set to occur if the monitored signal stays continuously over the overload curve for a defined time. An underload warning and/or fault can be set to occur if the monitored signal stays continuously under the underload for a defined time.

Overload can be for example used to monitor for a saw blade hitting a knot or fan load profiles becoming too high.

Underload can be for example used to monitor for load dropping and breaking of conveyer belts or fan belts.

Settings and diagnostics

Parameter group: *37 User load curve* (page 237).

Events: *A6E6 ULC configuration* (page 357), *A8BE ULC overload warning* (page 361), *A8BF ULC underload warning* (page 532), *8001 ULC underload fault* (page 370), *8002 ULC overload fault* (page 370).

DC voltage control

■ **Overvoltage control**

Overvoltage control of the intermediate DC link is typically needed when the motor is in generating mode. The motor can generate when it decelerates or when the load overhauls the motor shaft, causing the shaft to turn faster than the applied speed or frequency. To prevent the DC voltage from exceeding the overvoltage control limit, the overvoltage controller automatically decreases the output torque when the limit is reached. The overvoltage controller also increases deceleration times if the limit is reached; to achieve shorter deceleration times, a brake chopper and resistor may be required.

■ **Undervoltage control (power loss ride-through)**

If grid voltage is cut off, the drive will continue to operate by utilizing the kinetic energy of the rotating motor. The drive will be fully operational as long as the motor rotates and generates energy to the drive. The drive can continue operation immediately after the break if the main contactor (if present) remained closed.

Note: Units equipped with a main contactor must be equipped with a hold circuit (e.g. UPS) to keep the contactor control circuit closed during a short supply break.

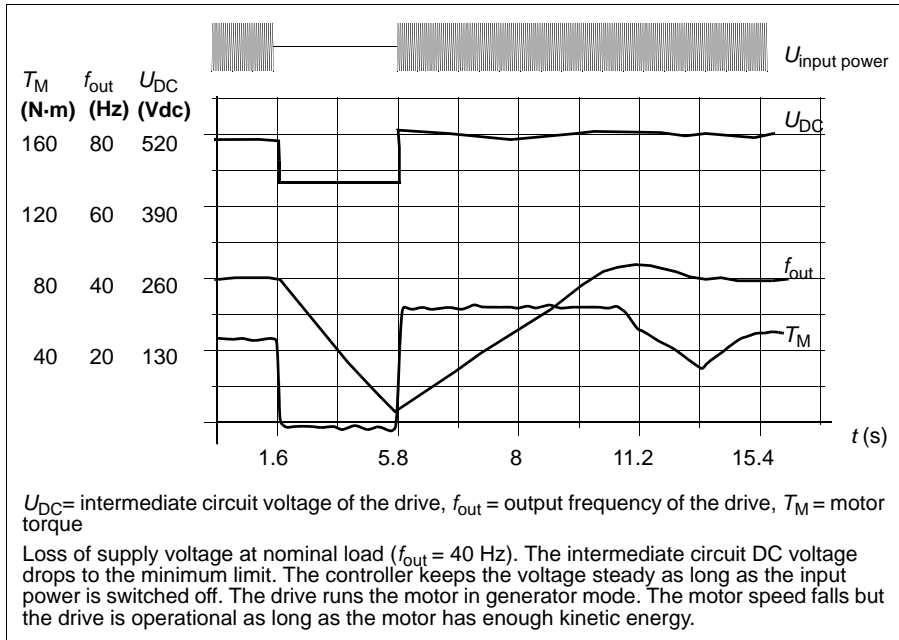

Automatic restart

It is possible to restart the drive automatically after a short (max. 5 seconds) power supply failure by using the Automatic restart function provided that the drive is allowed to run for 5 seconds without the cooling fans operating.

When enabled, the function takes the following actions upon a supply failure to enable a successful restart:

- The undervoltage fault is suppressed (but a warning is generated).
- Modulation and cooling is stopped to conserve any remaining energy.
- DC circuit pre-charging is enabled.

If the DC voltage is restored before the expiration of the period defined by parameter [21.18 Auto restart time](#) and the start signal is still on, normal operation will continue. However, if the DC voltage remains too low at that point, the drive trips on a fault, [3220 DC bus undervoltage](#).

■ Voltage control and trip limits

The control and trip limits of the intermediate DC voltage regulator are relative to the supply voltage provided by user or automatically setup. The DC voltage (U_{DC}) is

approximately 1.35 times the line-to-line supply voltage, and is displayed by parameter [01.11 DC voltage](#).

The following diagram shows the relation of selected DC voltage levels. Note that the absolute voltages vary according to drive/inverter type and AC supply voltage range.

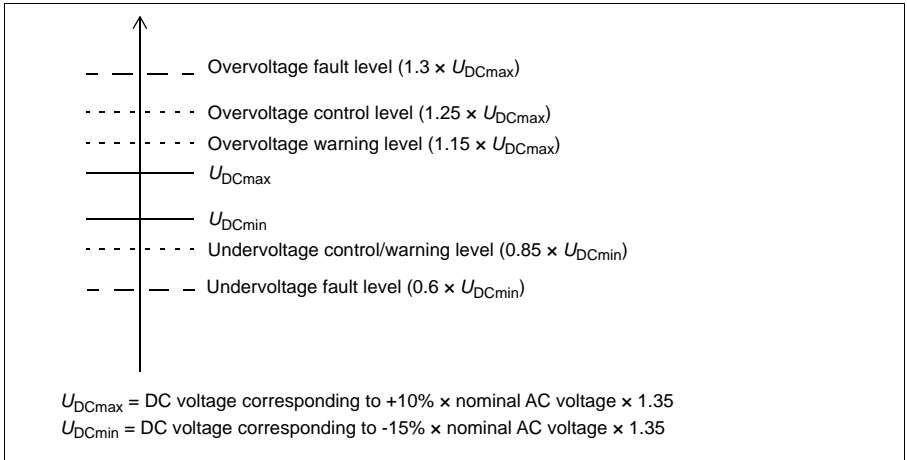

Settings

Parameter [01.11 DC voltage](#) (page 133), [30.30 Overvoltage control](#) (page 203), [30.31 Undervoltage control](#) (page 203) and [96.01 Supply volt](#) (page 297).

■ Brake chopper

A brake chopper can be used to handle the energy generated by a decelerating motor. When the DC voltage rises high enough, the chopper connects the DC circuit to an external brake resistor. The chopper operates on the pulse width modulation principle.

The internal brake choppers in the drive (in frames B0...R3) start conducting when the DC link voltage reaches approximately $1.15 \times U_{DCmax}$. 100% maximum pulse width is reached at approximately $1.2 \times U_{DCmax}$. (U_{DCmax} is the DC voltage corresponding to the maximum of the AC supply voltage range.) For information on external brake choppers, refer to their documentation.

Note: Overvoltage control needs to be disabled for the chopper to operate.

Settings

Parameter [01.11 DC voltage](#) (page 133); Parameter group [43 Brake chopper](#) (page 43 [Brake chopper](#)).

Safety and protections

■ Fixed/Standard protections

Over current

If the output current exceeds the internal over current limit, the IGBTs are shut down immediately to protect the drive.

DC overvoltage

See section [85](#) on page [Overvoltage control](#).

DC undervoltage

See section [85](#) on page [Undervoltage control \(power loss ride-through\)](#).

Converter temperature

If the temperature rises high enough, the drive first starts to limit the switching frequency and then the current to protect itself. If it is still keeps heating up, for example because of a fan failure, an overtemperature fault is generated.

Short circuit

In case of a short circuit, the IGBTs are shut down immediately to protect the drive.

■ Emergency stop

The emergency stop signal is connected to the input selected by parameter [21.05 Emergency stop source](#). An emergency stop can also be generated through a fieldbus (parameter [06.01 Main control word](#), bits 0...2).

The mode of the emergency stop is selected by parameter [21.04 Emergency stop mode](#). The following modes are available:

- Off 1: Stop along the standard deceleration ramp defined for the particular reference type in use
- Off2: free stop
- Off3: Stop by the emergency stop ramp defined by parameter [23.23 Emergency stop time](#).

Notes:

- The installer of the equipment is responsible for installing the emergency stop devices and all additional devices needed for the emergency stop function to fulfill the required emergency stop categories. For more information, contact your local ABB representative.
 - After an emergency stop signal is detected, the emergency stop function cannot be canceled even though the signal is canceled.
-

Settings

- Parameter [21.04 Emergency stop mode](#) (page 182), [21.05 Emergency stop source](#) (page 182), [23.23 Emergency stop time](#) (page 189) and [31.36 Screen auxiliary fan fault](#) (page 210).

■ Motor thermal protection

The control program features two separate motor temperature monitoring functions. The temperature data sources and warning/trip limits can be set up independently for each function.

The following 2 procedures can be implemented to prevent the motor becomes overheated:

- The motor thermal protection model (estimated temperature derived internally inside the drive), or
- sensors installed in the windings. This will result in a more accurate motor model.

Motor thermal protection model

The drive calculates the temperature of the motor on the basis of the following assumptions:

1. When power is applied to the drive for the first time, the motor is assumed to be at ambient temperature (defined by parameter [35.50 Motor ambient temperature](#)). After this, when power is applied to the drive, the motor is assumed to be at the estimated temperature.
2. Motor temperature is calculated using the user-adjustable motor thermal time and motor load curve. The load curve should be adjusted if ambient temperature exceeds 30 °C.

Note: The motor thermal model can be used when only one motor is connected to the inverter.

Temperature monitoring using Pt100 sensors

1...3 Pt100 sensors can be connected in series to an analog input and an analog output.

The analog output feeds a constant excitation current of 9.1 mA through the sensor. The sensor resistance increases as the motor temperature rises, as does the voltage over the sensor. The temperature measurement function reads the voltage through the analog input and converts it into degrees Celsius.

It is possible to adjust the motor temperature supervision limits and select how the drive reacts when over temperature is detected.

For the wiring of the sensor, see chapter *Electrical installation section AI1 and AI2 as Pt100, Pt1000, Ni1000, KTY83 and KTY84 sensor inputs (X1)* in the Hardware manual of the drive.

Settings

- Parameter group [35 Motor thermal protection](#)(page 224).

■ Programmable protection functions

External events (parameters [31.01...31.10](#))

Five different event signals from the process can be connected to selectable inputs to generate trips and warnings for drive equipments. When the signal is lost, one external event occurred (fault, warning or only log entries).

Motor phase loss detection (parameter [31.19](#))

The parameter selects how the drive reacts whenever a motor phase loss is detected.

Earth (Ground) fault detection (parameter [31.20](#))

Note that:

- an earth fault in the supply cable does not activate the protection
- in a grounded supply, the protection activates within 2 milliseconds
- in an ungrounded supply, the supply capacitance must be 1 microfarad or more
- the capacitive currents caused by shielded motor cables up to 300 meters will not activate the protection
- the protection is deactivated when the drive is stopped.

Supply phase loss detection (parameter [31.21](#))

The parameter selects how the drive reacts whenever a supply phase loss is detected.

Safe torque off detection (parameter [31.22](#))

The drive monitors the status of the Safe torque off input, and this parameter selects which indications are given when the signals are lost. (The parameter does not affect the operation of the Safe torque off function itself).

Swapped supply and motor cabling (parameter [31.23](#))

The drive can detect if the supply and motor cables have accidentally been swapped (for example, if the supply input is connected to the motor output of the drive). The parameter selects if a fault is generated or not.

Stall protection (parameters [31.24...31.28](#))

It is possible to adjust the supervision limits (current, frequency and time) and choose how the drive reacts to a motor stall condition.

Local control loss detection (parameter [49.05](#))

The parameter selects how the drive reacts to a control panel or PC tool communication break.

AI supervision (parameters [12.03](#)...[12.04](#))

The parameters select how the drive reacts when an analog input signal moves out of the minimum and/or maximum limits specified for the input.

■ Automatic fault resets

The drive can automatically reset itself after, for example, over current, overvoltage, undervoltage and external faults. Users may set auto restart for certain fault.

By default, users need to separately activate auto restart if it is off.

Settings

- Parameters [31.12](#)...[31.16](#) (page [205](#)).

Diagnostics

■ Signal supervision

Six signals can be selected to be supervised by this function. Whenever a supervised signal exceeds or falls below predefined limits, a bit in [32.01 Supervision status word](#) is activated, and a warning or fault generated.

The supervised signal is low-pass filtered.

Settings

Parameter group [32 Supervision](#) (page 211).

■ Energy saving calculators

This feature consists of the following functionalities:

- An energy optimizer that adjusts the motor flux in such a way that the total system efficiency is maximized
- A counter that monitors used and saved energy by the motor and displays them in kWh, currency or volume of CO₂ emissions, and

In addition, there are counters that show energy consumption in kWh of the current and previous hour as well as the current and previous day.

Note: The accuracy of the energy savings calculation is directly dependent on the accuracy of the reference motor power given in parameter [45.19 Comparison power](#).

Settings

- Parameter group [45 Energy efficiency](#) (page 261).
- Parameter [01.50 Current hour energy consumption](#), [01.51 Previous one hour energy consumption](#), [01.52 Today's energy consumption](#) and [01.53 Yesterday's energy consumption](#) (page 134).

■ Load analyzer

Peak value logger

The user can select a signal to be monitored by a peak value logger. The logger records the peak value of the signal along with the time the peak occurred, as well as motor current, DC voltage and motor speed at the time of the peak. The peak value is sampled at 2 ms intervals.

Amplitude loggers

The control program has two amplitude loggers.

For amplitude logger 2, the user can select a signal to be sampled at 200 ms intervals, and specify a value that corresponds to 100%. The collected samples are

sorted into 10 read-only parameters according to their amplitude. Each parameter represents an amplitude range 10 age points wide, and displays the age of the collected samples that have fallen within that range.

You can view this graphically with the assistant control panel or the Drive composer PC tool.

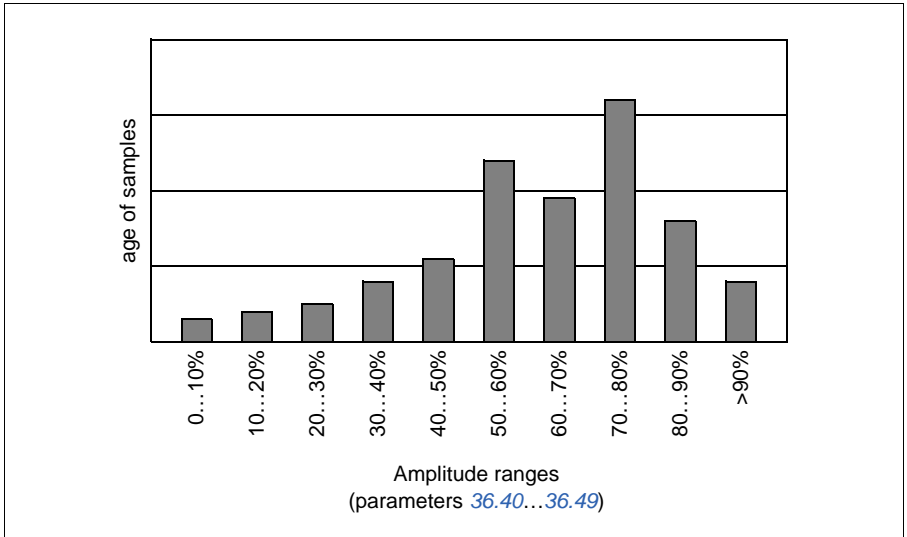

Amplitude logger 1 is fixed to monitor motor current, and cannot be reset. With amplitude logger 1, 100% corresponds to the maximum output current of the drive (I_{\max}), which is listed in the *Hardware manual* of the drive. The measured current is logged continuously. The distribution of samples is shown by parameters [36.20...36.29](#).

Settings and diagnostics

Menu - Diagnostics - Load profile

Parameter group: [36 Load analyzer](#) (page [234](#)).

- Events: -

Other

■ Backup and restore

You can make backups of the settings manually to the assistant panel. You can restore a backup to another drive, or a new drive replacing a faulty one. You can make backups and restore on the panel or with the Drive composer PC tool.

Backup

Manual backup

Make a backup when necessary, for example, after you have started up the drive or when you want to copy the settings to another drive.

Parameter changes from fieldbus interfaces are ignored unless you have forced parameter saving with parameter [96.07 Parameter save manually](#).

Restore

Previous backup of the control panel can be restored in Main Menu – Backup, as shown in the following figure on the right. Backup image is shown in the following figure on the left. The basic control panel only can restore the last backup.

Note: To restore a backup, the drive has to be in Local control.



Settings

- Parameter [96.07 Parameter save manually](#) (page [301](#)).

■ User macro

The drive supports four user macro sets that can be saved to the permanent memory and recalled using drive parameters. It is also possible to use digital inputs to switch between the user macro sets. To change a user macro set, the drive has to be stopped.

A user parameter set contains all values in parameter groups 10...99 except the following:

- Data storage parameters (Parameter group 47)
- Fieldbus communication settings (Parameter group 50...53 and 58).

As the motor settings are included in the user macro sets, make sure the settings correspond to the motor used in the application before recalling a user set. In an application where different motors are used with the drive, the motor ID run needs to be performed with each motor and the results saved to different user macro sets. The appropriate set can then be recalled when the motor is switched.

■ Data storage parameters

Twelve (eight 32-bit, four 16-bit) parameters are reserved for data storage. These parameters have nothing to do with default settings, and can be used for linking, testing and commissioning purpose. They can also be written into other parameter sources or parameter target options, or otherwise be read from them.

Settings

Parameter group [47 Data storage](#) (page [267](#)).

5

Parameter data

What this chapter contains

This chapter lists the parameters with some additional data such as their ranges and 32-bit fieldbus scaling. For parameter descriptions, see chapter [Parameter](#) (See page [129](#)).

Terms and abbreviations

| Terms | Definition |
|---------------|-------------------------------------------------------------------------------------------------------------------------------------------------------------------------------------------------------------------------------------------------------------------------------------------------------------|
| Actual signal | Signal measured or calculated by the drive. Usually can only be monitored but not adjusted; some counter-type signals can however be reset. |
| Analog src | Analog source: the parameter can be set to the value of another parameter by choosing "Other", and selecting the source parameter from a list In addition to the "other" selection, the parameter may offer other pre-selected settings. |
| Binary src | Binary source: the value of the parameter can be taken from a specific bit in another parameter value ("Other"). Sometimes the value can be fixed to 0 (false) or 1 (true). In addition, the parameter may offer other pre-selected settings. |
| Data | Data parameter |
| FbEq32 | 32-bit fieldbus equivalence: The scaling between the value shown on the panel and the integer used in communication when a 32-bit value is selected for transmission to an external system. The corresponding 16-bit scaling is listed in chapter Parameter (page 129). |
| List | Selection list. |

| Terms | Definition |
|---------------|--------------------------------------------------------------------------------------------------------------------------------------------------|
| Serial number | Parameter number. |
| PB | Packed Boolean (bit list). |
| Real | Real |
| type | Parameter type. See Analog src , Binary src , List , PB , Real . |

Fieldbus addresses

Refer to the User's Manual of the fieldbus adapter.

Parameter groups 1...9

| Serial number | Name | Type | Range | Unit | FbEq32 |
|-------------------------|-----------------------------------------|-------------|--------------------------------|--------------|---------------|
| 01 Actual values | | | | | |
| 01.01 | Motor speed | <i>Real</i> | -30000.00...30000.00 | rpm | 100 = 1 rpm |
| 01.03 | Motor speed (%) | <i>Real</i> | -1000.00...1000.00 | % | 100 = 1% |
| 01.06 | Output frequency | <i>Real</i> | -500.00...500.00 | Hz | 100 = 1 Hz |
| 01.07 | Motor current | <i>Real</i> | 0.00...30000.00 | A | 100 = 1 A |
| 01.08 | Motor nominal current (%) | <i>Real</i> | 0.0...1000.0 | % | 10 = 1% |
| 01.09 | Drive nominal current (%) | <i>Real</i> | 0.0...1000.0 | % | 10 = 1% |
| 01.10 | Motor torque (%) | <i>Real</i> | -1600.0...1600.0 | % | 10 = 1% |
| 01.11 | DC voltage | <i>Real</i> | 0.00...2000.00 | V | 100 = 1 V |
| 01.13 | Output voltage | <i>Real</i> | 0...2000 | V | 1 = 1 V |
| 01.14 | Output frequency | <i>Real</i> | -32768.00...32767.00 | kW or hp | 100 = 1 unit |
| 01.15 | Nominal output power (%) of motor | <i>Real</i> | -300.00...300.00 | % | 100 = 1% |
| 01.17 | Motor shaft power | <i>Real</i> | -32768.00...32767.00 | kW or hp | 100 = 1 unit |
| 01.18 | Inverter GWh counter | <i>Real</i> | 0...65535 | GWh | 1 = 1 GWh |
| 01.19 | Inverter MWh counter | <i>Real</i> | 0...1000 | MWh | 1 = 1 MWh |
| 01.20 | Inverter kWh counter | <i>Real</i> | 0...1000 | kWh | 1 = 1 kWh |
| 01.24 | Actual flux (%) | <i>Real</i> | 0...200 | % | 1 = 1% |
| 01.30 | Nominal torque scale | <i>Real</i> | 0-40000000.000 | N·m or lb-ft | 1000 = 1 unit |
| 01.50 | Current hour energy consumption | <i>Real</i> | 0...1000000.00 | kWh | 100 = 1 kWh |
| 01.51 | Previous one hour energy consumption | <i>Real</i> | 0...1000000.00 | kWh | 100 = 1 kWh |
| 01.52 | Today's energy consumption | <i>Real</i> | -0...1000000.00 | kWh | 100 = 1 kWh |
| 01.53 | Yesterday's energy consumption | <i>Real</i> | 0...1000000.00 | kWh | 100 = 1 kWh |
| 01.54 | Cumulative inverter energy | <i>Real</i> | -200000000.0... 200000000.0 | kWh | 1 = 1 kWh |
| 01.55 | Inverter GWh counter (resettable) | <i>Real</i> | 0...65535 | GWh | 1 = 1 GWh |
| 01.56 | Inverter MWh counter (resettable) | <i>Real</i> | 0...1000 | MWh | 1 = 1 MWh |
| 01.57 | Inverter kWh counter (resettable) | <i>Real</i> | 0...1000 | kWh | 1 = 1 kWh |
| 01.58 | Cumulative inverter energy (resettable) | <i>Real</i> | -200000000.0... 200000000.0 | kWh | 1 = 1 kWh |
| 01.61 | Absolute value of motor speed | <i>Real</i> | 0.00... 30000.00 | rpm | 100 = 1 rpm |
| 01.62 | Absolute value of motor speed (%) | <i>Real</i> | 0.00 = 1000.00% | % | 100 = 1% |
| 01.63 | Abs output frequency | <i>Real</i> | 0.00...500.00 Hz | Hz | 100 = 1 Hz |
| 01.64 | Abs motor torque | <i>Real</i> | 0.0...1600.0 | % | 10 = 1% |
| 01.65 | Abs output power | <i>Real</i> | 0.00... 32767.00 | kW | 100 = 1 kW |

100 Parameter data

| Serial number | Name | Type | Range | Unit | FbEq32 |
|-----------------------------------|-----------------------------------------------------|-------------|------------------------|----------|------------|
| 01.66 | Absolute value of nominal output power (%) of motor | <i>Real</i> | 0.00...300.00 | % | 100 = 1% |
| 01.68 | Abs motor shaft power | <i>Real</i> | 0.00... 32767.00 | kW | 100 = 1 kW |
| 03 Input references | | | | | |
| 03.01 | Panel reference | <i>Real</i> | -100000.00...100000.00 | - | 100 = 1 |
| 03.02 | Panel reference 2 | <i>Real</i> | -100000.00...100000.00 | - | 100 = 1 |
| 03.05 | FB A reference 1 | <i>Real</i> | -100000.00...100000.00 | - | 100 = 1 |
| 03.06 | FB A reference 2 | <i>Real</i> | -100000.00...100000.00 | - | 100 = 1 |
| 03.09 | EFB reference 1 | <i>Real</i> | -30000.00...30000.00 | - | 100 = 1 |
| 03.10 | EFB reference 2 | <i>Real</i> | -30000.00...30000.00 | - | 100 = 1 |
| 04 Warnings and faults | | | | | |
| 04.01 | Active fault | <i>Data</i> | 0000h...FFFFh | - | 1 = 1 |
| 04.02 | Active fault 2 | <i>Data</i> | 0000h...FFFFh | - | 1 = 1 |
| 04.03 | Active fault 3 | <i>Data</i> | 0000h...FFFFh | - | 1 = 1 |
| 04.06 | Active warning 1 | <i>Data</i> | 0000h...FFFFh | - | 1 = 1 |
| 04.07 | Active warning 2 | <i>Data</i> | 0000h...FFFFh | - | 1 = 1 |
| 04.08 | Active warning 3 | <i>Data</i> | 0000h...FFFFh | - | 1 = 1 |
| 04.11 | Latest fault | <i>Data</i> | 0000h...FFFFh | - | 1 = 1 |
| 04.12 | 2nd latest fault | <i>Data</i> | 0000h...FFFFh | - | 1 = 1 |
| 04.13 | 3rd latest fault | <i>Data</i> | 0000h...FFFFh | - | 1 = 1 |
| 04.16 | Latest warning | <i>Data</i> | 0000h...FFFFh | - | 1 = 1 |
| 04.17 | 2nd latest warning | <i>Data</i> | 0000h...FFFFh | - | 1 = 1 |
| 04.18 | 3rd latest warning | <i>Data</i> | 0000h...FFFFh | - | 1 = 1 |
| 04.40 | Event word 1 | <i>PB</i> | 0000h...FFFFh | - | 1 = 1 |
| 04.41 | Event word 1 bit 0 code | <i>Data</i> | 0000h...FFFFh | - | 1 = 1 |
| 04.43 | Event word 1 bit 1 code | <i>Data</i> | 0000h...FFFFh | - | 1 = 1 |
| 04.45, 04.47, 04.49, ... | ... | ... | ... | ... | |
| 04.71 | Event word 1 bit 15 code | <i>Data</i> | 0000h...FFFFh | - | 1 = 1 |
| 05 Diagnostics | | | | | |
| 05.01 | On-time | <i>Real</i> | 0...65535 | days | 1 = 1 day |
| 05.02 | Runtime | <i>Real</i> | 0...65535 | days | 1 = 1 day |
| 05.03 | Hours run | <i>Real</i> | 0.0...429496729.5 | h | 10 = 1 h |
| 05.04 | Fan run time | <i>Real</i> | 0...65535 | days | 1 = 1 day |
| 05.10 | Control board temperature | <i>Real</i> | -100...300 | °C or °F | 10 = 1 °C |
| 05.11 | Inverter temperature (%) | <i>Real</i> | -40.0...160.0 | % | 10 = 1% |
| 05.20 | Diagnostic word 1 | <i>PB</i> | 0000h...FFFFh | - | - |

| Serial number | Name | Type | Range | Unit | FbEq32 |
|------------------------------------|-------------------------------|-------------------|--------------------------------|------|-------------|
| 05.21 | Diagnostic word 2 | <i>PB</i> | 0000h...FFFFh | - | - |
| 05.22 | Diagnostic word 3 | <i>PB</i> | 0000h...FFFFh | - | - |
| 05.80 | Motor speed at fault | <i>Real</i> | -30000.00...30000.00 | rpm | 100 = 1 rpm |
| 05.81 | Output frequency at fault | <i>Real</i> | -500.00...500.00 | Hz | 100 = 1 Hz |
| 05.82 | DC voltage at fault | <i>Real</i> | 0.00...2000.00 | V | 100 = 1 V |
| 05.83 | Motor current at fault | <i>Real</i> | 0.00...30000.00 | A | 100 = 1 A |
| 05.84 | Motor torque at fault | <i>Real</i> | -1600.0...1600.0 | % | 10 = 1% |
| 05.85 | Main status word at fault | <i>PB</i> | 0000h...FFFFh | - | 1 = 1 |
| 05.87 | Inverter temperature at fault | <i>Real</i> | -40...160 | °C | 10 = 1 ° |
| 05.88 | Reference used at fault | <i>Real</i> | -30000.00...30000.00 | Hz | 100 = 1 Hz |
| 06 Control and status words | | | | | |
| 06.01 | Main control word | <i>PB</i> | 0000h...FFFFh | - | 1 = 1 |
| 06.11 | Main status word | <i>PB</i> | 0000h...FFFFh | - | 1 = 1 |
| 06.16 | Drive status word 1 | <i>PB</i> | 0000h...FFFFh | - | 1 = 1 |
| 06.17 | Drive status word 2 | <i>PB</i> | 0000h...FFFFh | - | 1 = 1 |
| 06.18 | Start inhibit status word | <i>PB</i> | 0000h...FFFFh | - | 1 = 1 |
| 06.19 | Speed control status word | <i>PB</i> | 0000h...FFFFh | - | 1 = 1 |
| 06.21 | Drive status word 3 | <i>PB</i> | 0000h...FFFFh | - | 1 = 1 |
| 06.29 | MSW bit 10 selection | <i>Binary src</i> | - | - | 1 = 1 |
| 06.30 | MSW bit 11 selection | <i>Binary src</i> | - | - | 1 = 1 |
| 06.31 | MSW bit 12 selection | <i>Binary src</i> | - | - | 1 = 1 |
| 06.32 | MSW bit 13 selection | <i>Binary src</i> | - | - | 1 = 1 |
| 06.33 | MSW bit 14 selection | <i>Binary src</i> | - | - | 1 = 1 |
| 07 System info | | | | | |
| 07.03 | Drive rating | <i>List</i> | 0...65535 | - | 1 = 1 |
| 07.04 | Firmware name | <i>List</i> | - | - | 1 = 1 |
| 07.05 | Firmware version | <i>Data</i> | 0.00.0.0...255.255.255. 255 | - | 1 = 1 |
| 07.06 | Loading package name | <i>List</i> | - | - | 1 = 1 |
| 07.07 | Loading package version | <i>Data</i> | 0.00.0.0...255.255.255. 255 | - | 1 = 1 |
| 07.11 | CPU usage | <i>Real</i> | 0...100 | % | 1 = 1% |
| 07.25 | Customization package name | <i>Data</i> | - | - | 1 = 1 |
| 07.26 | Customization package version | <i>Data</i> | - | - | 1 = 1 |
| 07.35 | Drive configuration | <i>PB</i> | 0000h...FFFFh | - | 1 = 1 |
| 07.36 | Drive configuration 2 | <i>PB</i> | 0000h...FFFFh | - | 1 = 1 |

Parameter groups 10...99

| Serial number | Name | type | Range | Unit | FbEq32 |
|--------------------------------|--------------------------|-------------------|------------------------------------------|------------|------------------|
| 10 Standard DI,RO | | | | | |
| 10.01 | DI status | <i>PB</i> | 0000h...FFFFh | - | 1 = 1 |
| 10.03 | DI force selection | <i>PB</i> | 0000h...FFFFh | - | 1 = 1 |
| 10.04 | DI force data | <i>PB</i> | 0000h...FFFFh | - | 1 = 1 |
| 10.21 | RO status | <i>PB</i> | 0000h...FFFFh | - | 1 = 1 |
| 10.22 | RO force selection | <i>PB</i> | 0000h...FFFFh | - | 1 = 1 |
| 10.23 | RO force value | <i>PB</i> | 0000h...FFFFh | - | 1 = 1 |
| 10.24 | RO1 source | <i>Binary src</i> | - | - | 1 = 1 |
| 10.25 | RO1 ON delay | <i>Real</i> | 0.0...3000.0 | s | 10 = 1 s |
| 10.26 | RO1 OFF delay | <i>Real</i> | 0.0...3000.0 | s | 10 = 1 s |
| 10.27 | RO2 source | <i>Binary src</i> | - | - | 1 = 1 |
| 10.28 | RO2 ON delay | <i>Real</i> | 0.0...3000.0 | s | 10 = 1s |
| 10.29 | RO2 OFF delay | <i>Real</i> | 0.0...3000.0 | s | 10 = 1s |
| 10.30 | RO3 source | <i>Binary src</i> | - | - | 1 = 1 |
| 10.31 | RO3 ON delay | <i>Real</i> | 0.0...3000.0 | s | 10 = 1s |
| 10.32 | RO3 OFF delay | <i>Real</i> | 0.0...3000.0 | s | 10 = 1s |
| 10.99 | RO/DIO control word | <i>PB</i> | 0000h...FFFFh | - | 1 = 1 |
| 10.101 | RO1 toggle counter | <i>Real</i> | 0...4294967000 | - | 1 = 1 |
| 10.102 | RO2 toggle counter | <i>Real</i> | 0...4294967000 | - | 1 = 1 |
| 10.103 | RO3 toggle counter | <i>Real</i> | 0...4294967000 | - | 1 = 1 |
| 11 Standard DIO, FI, FO | | | | | |
| 11.21 | DI5 Configuration | <i>List</i> | 0...1 | - | 1 = 1 |
| 11.38 | Freq in 1 actual value | <i>Real</i> | 0...16000 | Hz | 1 = 1 Hz |
| 11.39 | Freq in 1 scaled value | <i>Real</i> | -32768.000...32767.000 | - | 1000 = 1 |
| 11.42 | Freq in 1 min | <i>Real</i> | 0...16000 | Hz | 1 = 1 Hz |
| 11.43 | Freq in 1 max | <i>Real</i> | 0...16000 | Hz | 1 = 1 Hz |
| 11.44 | Freq in 1 at scaled min | <i>Real</i> | -32768.000...32767.000 | - | 1000 = 1 |
| 11.45 | Freq in 1 at scaled max | <i>Real</i> | -32768.000...32767.000 | - | 1000 = 1 |
| 12 Standard AI | | | | | |
| 12.02 | AI force sel | <i>PB</i> | 0000h...FFFFh | - | 1 = 1 |
| 12.03 | AI supervision function | <i>List</i> | 0...4 | - | 1 = 1 |
| 12.04 | AI supervision selection | <i>PB</i> | 0000h...FFFFh | - | 1 = 1 |
| 12.05 | AI supervision force | <i>PB</i> | 0000h...FFFFh | - | 1 = 1 |
| 12.11 | AI1 actual value | <i>Real</i> | 0.000...20.000 mA or 0.000...10.000 V | mA or V | 1000 = 1 unit |
| 12.12 | AI1 scaled value | <i>Real</i> | -32768.000...32767.000 | - | 1000 = 1 |
| 12.13 | AI1 forced value | <i>Real</i> | 0.000...20.000 mA or 0.000...10.000 V | mA or V | 1000 = 1 unit |
| 12.15 | AI1 unit selection | <i>List</i> | 2, 10 | - | 1 = 1 |
| 12.16 | AI1 filter time | <i>Real</i> | 0.000...30.000 | s | 1000 = 1s |

| Serial number | Name | type | Range | Unit | FbEq32 |
|-----------------------|--------------------------|-----------------------|------------------------------------------|------------|------------------|
| 12.17 | AI1 min | <i>Real</i> | 0.000...20.000 mA or 0.000...10.000 V | mA or V | 1000 = 1 unit |
| 12.18 | AI1 max | <i>Real</i> | 0.000...20.000 mA or 0.000...10.000 V | mA or V | 1000 = 1 unit |
| 12.19 | AI1 minimum scaled value | <i>Real</i> | -32768.000...32767.000 | - | 1000 = 1 |
| 12.20 | AI1 maximum scaled value | <i>Real</i> | -32768.000...32767.000 | - | 1000 = 1 |
| 12.21 | AI2 actual value | <i>Real</i> | 0.000...20.000 mA or 0.000...10.000 V | mA or V | 1000 = 1 unit |
| 12.22 | AI2 scaled value | <i>Real</i> | -32768.000...32767.000 | - | 1000 = 1 |
| 12.23 | AI2 forced value | <i>Real</i> | 0.000...20.000 mA or 0.000...10.000 V | mA or V | 1000 = 1 unit |
| 12.25 | AI2 unit selection | <i>List</i> | 2, 10 | - | 1 = 1 |
| 12.26 | AI2 filter time | <i>Real</i> | 0.000...30.000 | s | 1000 = 1s |
| 12.27 | AI2 min | <i>Real</i> | 0.000...20.000 mA or 0.000...10.000 V | mA or V | 1000 = 1 unit |
| 12.28 | AI2 max | <i>Real</i> | 0.000...20.000 mA or 0.000...10.000 V | mA or V | 1000 = 1 unit |
| 12.29 | AI2 minimum scaled value | <i>Real</i> | -32768.000...32767.000 | - | 1000 = 1 |
| 12.30 | AI2 maximum scaled value | <i>Real</i> | -32768.000...32767.000 | - | 1000 = 1 |
| 12.101 | AI1 percentage value | <i>Real</i> | 0.00...100.00 | % | 100 = 1% |
| 12.102 | AI2 percentage value | <i>Real</i> | 0.00...100.00 | % | 100 = 1% |
| 12.110 | AI dead band | <i>Real</i> | 0.00...100.00 | % | 0 |
| 13 Standard AO | | | | | |
| 13.02 | AO force selection | <i>PB</i> | 0000h...FFFFh | - | 1 = 1 |
| 13.11 | AO1 actual value | <i>Real</i> | 0.000...22.000 | mA | 1000 = 1 mA |
| 13.12 | AO1 signal source | <i>Analog src</i> | - | - | 1 = 1 |
| 13.13 | AO1 forced value | <i>Real</i> | 0.000...22.000 | mA | 1000 = 1 mA |
| 13.15 | AO1 unit selection | <i>List</i> | 2, 10 | - | 1 = 1 |
| 13.16 | AO1 filter time | <i>Real</i> | 0.000...30.000 | s | 1000 = 1s |
| 13.17 | AO1 signal source Min | <i>Real</i> | -32768.0...32767.0 | - | 10 = 1 |
| 13.18 | AO1 signal source max | <i>Real</i> | -32768.0...32767.0 | - | 10 = 1 |
| 13.19 | AO1 Minimum output value | <i>Real</i> | 0.000...22.000 | mA | 1000 = 1 mA |
| 13.20 | AO1 Maximum output value | <i>Real</i> | 0.000...22.000 | mA | 1000 = 1 mA |
| 13.21 | AO2 actual value | <i>Real</i> | 0.000...22.000 | mA | 1000 = 1 mA |
| 13.22 | AO2 signal source | <i>Analog src</i> | - | - | 1 = 1 |
| 13.23 | AO2 forced value | <i>Real</i> | 0.000...22.000 | mA | 1000 = 1 mA |
| 13.26 | AO2 filter time | <i>Real</i> | 0.000...30.000 | s | 1000 = 1s |

104 Parameter data

| Serial number | Name | type | Range | Unit | FbEq32 |
|--------------------------------|---------------------------|-------------------|--------------------|------|----------------|
| 13.27 | AO2 signal source min | <i>Real</i> | -32768.0...32767.0 | - | 10 = 1 |
| 13.28 | AO2 signal source max | <i>Real</i> | -32768.0...32767.0 | - | 10 = 1 |
| 13.29 | AO2 Minimum output value | <i>Real</i> | 0.000...22.000 | mA | 1000 = 1 mA |
| 13.30 | AO2 Maximum output value | <i>Real</i> | 0.000...22.000 | mA | 1000 = 1 mA |
| 13.91 | AO1 data storage | <i>Real</i> | -327.68...327.67 | - | 100=1 |
| 13.92 | AO2 data storage | <i>Real</i> | -327.68...327.67 | - | |
| 15 I/O extension module | | | | | |
| 15.01 | Extension module type | <i>List</i> | 0...4 | - | 1 = 1 |
| 15.02 | Detected extension module | <i>List</i> | 0...4 | - | 1 = 1 |
| 15.04 | RO/DO status | <i>PB</i> | 0000h...FFFFh | - | 1 = 1 |
| 15.05 | RO/DO force selection | <i>PB</i> | 0000h...FFFFh | - | 1 = 1 |
| 15.06 | RO/DO forced data | <i>PB</i> | 0000h...FFFFh | - | 1 = 1 |
| 15.07 | RO4 source | <i>Binary src</i> | - | - | 1 = 1 |
| 15.08 | RO4 ON delay | <i>Real</i> | 0.0...3000.0 | s | 10 = 1 s |
| 15.09 | RO4 OFF delay | <i>Real</i> | 0.0...3000.0 | s | 10 = 1 s |
| 15.10 | RO5 source | <i>Binary src</i> | - | - | 1 = 1 |
| 15.11 | RO5 ON delay | <i>Real</i> | 0.0...3000.0 | s | 10 = 1 s |
| 15.12 | RO5 OFF delay | <i>Real</i> | 0.0...3000.0 | s | 10 = 1 s |
| 15.22 | DO1 configuration | <i>List</i> | 0, 2 | - | 1 = 1 |
| 15.23 | DO1 source | <i>Binary src</i> | - | - | 1 = 1 |
| 15.24 | DO1 ON delay | <i>Real</i> | 0.0...3000.0 | s | 10 = 1 s |
| 15.25 | DO1 OFF delay | <i>Real</i> | 0.0...3000.0 | s | 10 = 1 s |
| 15.32 | Freq out 1 actual value | <i>Real</i> | 0...16000 | Hz | 1 = 1 Hz |
| 15.33 | Freq out 1 source | <i>Analog src</i> | - | - | 1 = 1 |
| 15.34 | Freq out 1 src min | <i>Real</i> | -32768.0...32767.0 | - | 1000 = 1 |
| 15.35 | Freq out 1 src max | <i>Real</i> | -32768.0...32767.0 | - | 1000 = 1 |
| 15.36 | Freq out 1 at src min | <i>Real</i> | 0...16000 | Hz | 1 = 1 Hz |
| 15.37 | Freq out 1 at src max | <i>Real</i> | 0...16000 | Hz | 1 = 1 Hz |
| 19 Operation mode | | | | | |
| 19.11 | Ext1/Ext2 sel | <i>Binary src</i> | - | - | 1 = 1 |
| 19.17 | Local control disable | <i>List</i> | 0...1 | - | 1 = 1 |
| 20 Start/stop/direction | | | | | |
| 20.01 | Ext1 commands | <i>List</i> | 0...6, 11...12, 14 | - | 1 = 1 |
| 20.02 | Ext1 start trigger | <i>List</i> | 0...1 | - | 1 = 1 |
| 20.03 | Ext1 in 1 | <i>Binary src</i> | - | - | 1 = 1 |
| 20.04 | Ext1 in 2 | <i>Binary src</i> | - | - | 1 = 1 |
| 20.05 | Ext1 in 3 | <i>Binary src</i> | - | - | 1 = 1 |
| 20.06 | Ext2 commands | <i>List</i> | 0...6, 11...12, 14 | - | 1 = 1 |

| Serial number | Name | type | Range | Unit | FbEq32 |
|-------------------------------------|--------------------------------------|------------|-------------------|------|-------------|
| 20.07 | Ext2 start trigger | List | 0...1 | - | 1 = 1 |
| 20.08 | Ext2 in 1 | Binary src | - | - | 1 = 1 |
| 20.09 | Ext2 in 2 | Binary src | - | - | 1 = 1 |
| 20.10 | Ext2 in 3 | Binary src | - | - | 1 = 1 |
| 20.11 | Run enable stop mode | List | 0...1 | - | 1 = 1 |
| 20.12 | Run enable 1 source | Binary src | - | - | 1 = 1 |
| 20.19 | Enable start command | Binary src | - | - | 1 = 1 |
| 20.21 | Direction | List | 0...2 | - | 1 = 1 |
| 20.22 | Enable to rotate | Binary src | - | - | 1 = 1 |
| 20.25 | Jogging enable | Binary src | - | - | 1 = 1 |
| 20.26 | Jogging 1 start source | Binary src | - | - | 1 = 1 |
| 20.27 | Jogging 2 start source | Binary src | - | - | 1 = 1 |
| 20.28 | Remote to local action | List | 0...1 | - | 1 = 1 |
| 20.30 | Enable signal warning function | PB | 0000h...FFFFh | - | 1 = 1 |
| 21 Start/stop mode | | | | | |
| 21.02 | Magnetization time | Real | 0...10000 | ms | 1 = 1 ms |
| 21.03 | Stop mode | List | 0...1 | - | 1 = 1 |
| 21.04 | Emergency stop mode | List | 0...2 | - | 1 = 1 |
| 21.05 | Emergency stop source | Binary src | - | - | 1 = 1 |
| 21.06 | Zero speed limit | Real | 0.00...30000.00 | rpm | 100 = 1 rpm |
| 21.07 | Zero speed delay | Real | 0...30000 | ms | 1 = 1 ms |
| 21.08 | DC current control | PB | 0...FFFF | - | 1 = 1 |
| 21.10 | DC current reference | Real | 0.0...100.0 | % | 10 = 1% |
| 21.11 | Post magnetization time | Real | 0...3000 | s | 1 = 1 s |
| 21.14 | Pre-heating input source | Binary src | - | - | 1 = 1 |
| 21.15 | Pre-heating time delay | Real | 10...3000 | s | 1 = 1 s |
| 21.16 | Pre-heating current | Real | 0.0...30.0 | % | 10 = 1% |
| 21.18 | Auto restart time | Real | 0.0, 0.1 ... 10.0 | s | 10 = 1s |
| 21.19 | Scalar start mode | List | 0...4 | - | 1 = 1 |
| 21.21 | DC hold frequency | Real | 0.00...1000.00 | Hz | 100 = 1 Hz |
| 21.22 | Start delay | Real | 0.00...60.00 | s | 100 = 1s |
| 21.26 | Torque raise cur | Real | 15.0...300.0 | % | 100=1% |
| 21.27 | Torque boost time | Real | 0.0...60.0 | s | 10 = 1 s |
| 21.30 | Speed compensation stop mode | Real | 0...3 | - | 1 = 1 |
| 21.31 | Speed compensation stop delay | Real | 0.00...1000.00 | s | 100 = 1s |
| 21.32 | Speed compensation stop threshold | Real | 0...100 | % | 1=1% |
| 21.34 | Force auto restart | List | 0...1 | - | 1 = 1 |
| 22 Speed reference selection | | | | | |
| 22.70 | Motor potentiometer reference enable | List | 0...2 | - | 1 = 1 |

| Serial number | Name | type | Range | Unit | FbEq32 |
|-------------------------------------|-----------------------------------|-------------------|----------------------|------|------------|
| 22.71 | Motor potentiometer function | <i>List</i> | 0...3 | - | 1 = 1 |
| 22.72 | Motor potentiometer initial value | <i>Real</i> | -32768.00...32767.00 | - | 100 = 1 |
| 22.73 | Motor potentiometer up source | <i>Binary src</i> | - | - | 1 = 1 |
| 22.74 | Motor potentiometer down source | <i>Binary src</i> | - | - | 1 = 1 |
| 22.75 | Motor potentiometer ramp time | <i>Real</i> | 0.0...3600.0 | s | 10 = 1s |
| 22.76 | Motor potentiometer min value | <i>Real</i> | -32768.00...32767.00 | - | 100 = 1 |
| 22.77 | Motor potentiometer max value | <i>Real</i> | -32768.00...32767.00 | - | 100 = 1 |
| 22.80 | Motor potentiometer ref act | <i>Real</i> | -32768.00...32767.00 | - | 100 = 1 |
| 23 Speed reference ramp | | | | | |
| 23.20 | Acc time jogging | <i>Real</i> | 0.000...1800.000 | s | 1000 = 1 s |
| 23.21 | Dec time jogging | <i>Real</i> | 0.000...1800.000 | s | 1000 = 1 s |
| 23.23 | Emergency stop time | <i>Real</i> | 0.000 ...1800.000 | s | 1000 = 1s |
| 28 Frequency reference chain | | | | | |
| 28.01 | Frequency ref ramp input | <i>Real</i> | -500.00...500.00 | Hz | 100 = 1 Hz |
| 28.02 | Frequency ref ramp output | <i>Real</i> | -500.00...500.00 | Hz | 100 = 1 Hz |
| 28.11 | Ext1 frequency ref1 | <i>Analog src</i> | - | - | 1 = 1 |
| 28.12 | Ext1 frequency ref 2 | <i>Analog src</i> | - | - | 1 = 1 |
| 28.13 | Ext1 frequency function | <i>List</i> | 0...5 | - | 1 = 1 |
| 28.15 | Ext2 frequency ref1 | <i>Analog src</i> | - | - | 1 = 1 |
| 28.16 | Ext2 frequency ref2 | <i>Analog src</i> | - | - | 1 = 1 |
| 28.17 | Ext2 frequency function | <i>List</i> | 0...5 | - | 1 = 1 |
| 28.21 | Constant frequency function | <i>PB</i> | 00b...11b | - | 1 = 1 |
| 28.22 | Constant frequency sel 1 | <i>Binary src</i> | - | - | 1 = 1 |
| 28.23 | Constant frequency sel 2 | <i>Binary src</i> | - | - | 1 = 1 |
| 28.24 | Constant frequency sel 3 | <i>Binary src</i> | - | - | 1 = 1 |
| 28.26 | Constant frequency 1 | <i>Real</i> | -500.00...500.00 | Hz | 100 = 1 Hz |
| 28.27 | Constant frequency 2 | <i>Real</i> | -500.00...500.00 | Hz | 100 = 1 Hz |
| 28.28 | Constant frequency 3 | <i>Real</i> | -500.00...500.00 | Hz | 100 = 1 Hz |
| 28.29 | Constant frequency 4 | <i>Real</i> | -500.00...500.00 | Hz | 100 = 1 Hz |
| 28.30 | Constant frequency 5 | <i>Real</i> | -500.00...500.00 | Hz | 100 = 1 Hz |
| 28.31 | Constant frequency 6 | <i>Real</i> | -500.00...500.00 | Hz | 100 = 1 Hz |
| 28.32 | Constant frequency 7 | <i>Real</i> | -500.00...500.00 | Hz | 100 = 1 Hz |
| 28.41 | Reference of safe frequency | <i>Real</i> | -500.00...500.00 | Hz | 100 = 1 Hz |
| 28.42 | Jogging 1 frequency ref | <i>Real</i> | -500.00...500.00 | Hz | 100 = 1 Hz |
| 28.43 | Jogging 2 frequency ref | <i>Real</i> | -500.00...500.00 | Hz | 100 = 1 Hz |
| 28.51 | Critical frequency function | <i>PB</i> | 00b...11b | - | 1 = 1 |
| 28.52 | Critical frequency 1 lower limit | <i>Real</i> | -500.00...500.00 | Hz | 100 = 1 Hz |

| Serial number | Name | type | Range | Unit | FbEq32 |
|---------------------------|----------------------------------|-------------------|------------------|------|------------|
| 28.53 | Critical frequency 1 upper limit | <i>Real</i> | -500.00...500.00 | Hz | 100 = 1 Hz |
| 28.54 | Critical frequency 2 lower limit | <i>Real</i> | -500.00...500.00 | Hz | 100 = 1 Hz |
| 28.55 | Critical frequency 2 upper limit | <i>Real</i> | -500.00...500.00 | Hz | 100 = 1 Hz |
| 28.56 | Critical frequency 3 lower limit | <i>Real</i> | -500.00...500.00 | Hz | 100 = 1 Hz |
| 28.57 | Critical frequency 3 upper limit | <i>Real</i> | -500.00...500.00 | Hz | 100 = 1 Hz |
| 28.71 | Freq ramp set selection | <i>Binary src</i> | - | - | 1 = 1 |
| 28.72 | Freq acceleration time 1 | <i>Real</i> | 0.000...1800.000 | s | 1000 = 1s |
| 28.73 | Freq deceleration time 1 | <i>Real</i> | 0.000...1800.000 | s | 1000 = 1s |
| 28.74 | Freq acceleration time 2 | <i>Real</i> | 0.000...1800.000 | s | 1000 = 1s |
| 28.75 | Freq deceleration time 2 | <i>Real</i> | 0.000...1800.000 | s | 1000 = 1s |
| 28.76 | Frequency ramp in Zero | <i>Binary src</i> | - | - | 1 = 1 |
| 28.82 | Acc/Dec curve time 1 | <i>Real</i> | 0.000...1800.000 | s | 1000 = 1s |
| 28.83 | Acc/Dec curve time 2 | <i>Real</i> | 0.000...1800.000 | s | 1000 = 1s |
| 28.92 | Frequency ref act 3 | <i>Real</i> | -500.00...500.00 | Hz | 100 = 1 Hz |
| 28.96 | Frequency ref act 7 | <i>Real</i> | -500.00...500.00 | Hz | 100 = 1 Hz |
| 28.97 | Non-limited frequency reference | <i>Real</i> | -500.00...500.00 | Hz | 100 = 1 Hz |
| 30 Limits | | | | | |
| 30.01 | Limit word 1 | <i>PB</i> | 0000h...FFFFh | - | 1 = 1 |
| 30.02 | Torque limit status | <i>PB</i> | 0000h...FFFFh | - | 1 = 1 |
| 30.13 | Minimum frequency | <i>Real</i> | -500.00...500.00 | Hz | 100 = 1 Hz |
| 30.14 | Maximum frequency | <i>Real</i> | -500.00...500.00 | Hz | 100 = 1 Hz |
| 30.17 | Maximum current | <i>Real</i> | 0.00...30000.00 | A | 100 = 1 A |
| 30.18 | Torq lim sel | <i>Binary src</i> | - | - | 1 = 1 |
| 30.19 | Minimum torque 1 | <i>Real</i> | -1600.0...0.0 | % | 10 = 1% |
| 30.20 | Maximum torque 1 | <i>Real</i> | 0.0...1600.0 | % | 10 = 1% |
| 30.21 | Min torque 2 source | <i>Analog src</i> | - | - | 1 = 1 |
| 30.22 | Max torque 2 source | <i>Analog src</i> | - | - | 1 = 1 |
| 30.23 | Minimum torque 2 | <i>Real</i> | -1600.0...0.0 | % | 10 = 1% |
| 30.24 | Maximum torque 2 | <i>Real</i> | 0.0...1600.0 | % | 10 = 1% |
| 30.26 | Power motoring limit | <i>Real</i> | 0.00...600.00 | % | 100 = 1% |
| 30.27 | Power generating limit | <i>Real</i> | -600.00...0.00 | % | 100 = 1% |
| 30.30 | Overvoltage control | <i>List</i> | 0...1 | - | 1 = 1 |
| 30.31 | Undervoltage control | <i>List</i> | 0...1 | - | 1 = 1 |
| 31 Fault functions | | | | | |
| 31.01 | External event 1 source | <i>Binary src</i> | - | - | 1 = 1 |
| 31.02 | External event 1 type | <i>List</i> | 0...1 | - | 1 = 1 |
| 31.03 | External event 2 source | <i>Binary src</i> | - | - | 1 = 1 |
| 31.04 | External event 2 type | <i>List</i> | 0...1 | - | 1 = 1 |
| 31.05 | External event 3 source | <i>Binary src</i> | - | - | 1 = 1 |

| Serial number | Name | type | Range | Unit | FbEq32 |
|-----------------------|----------------------------------|-------------------|--------------------------------|------|------------|
| 31.06 | External event 3 type | <i>List</i> | 0...1 | - | 1 = 1 |
| 31.07 | External event 4 source | <i>Binary src</i> | - | - | 1 = 1 |
| 31.08 | External event 4 type | <i>List</i> | 0...1 | - | 1 = 1 |
| 31.09 | External event 5 source | <i>Binary src</i> | - | - | 1 = 1 |
| 31.10 | External event 5 type | <i>List</i> | 0...1 | - | 1 = 1 |
| 31.11 | Fault reset selection | <i>Binary src</i> | - | - | 1 = 1 |
| 31.12 | Autoreset selection | <i>PB</i> | 0000h...FFFFh | - | 1 = 1 |
| 31.13 | Self-defined auto reset fault | <i>Real</i> | 0000h...FFFFh | - | 1 = 1 |
| 31.14 | Number of trials | <i>Real</i> | 0...5 | - | 1 = 1 |
| 31.15 | Trial time | <i>Real</i> | 1.0...600.0 | s | 10 = 1s |
| 31.16 | Delay time | <i>Real</i> | 0.0...120.0 | s | 10 = 1s |
| 31.19 | Motor phase loss | <i>List</i> | 0...1 | - | 1 = 1 |
| 31.20 | Ground fault | <i>List</i> | 0...2 | - | 1 = 1 |
| 31.21 | Supply phase loss | <i>List</i> | 0...1 | - | 1 = 1 |
| 31.22 | STO indication run/stop | <i>List</i> | 0...3 | - | 1 = 1 |
| 31.23 | Cross connection | <i>List</i> | 0...1 | - | 1 = 1 |
| 31.24 | Stall function | <i>List</i> | 0...2 | - | 1 = 1 |
| 31.25 | Stall current limit | <i>Real</i> | 0.0...1600.0 | % | 10 = 1% |
| 31.27 | Stall frequency limit | <i>Real</i> | 0.00...1000.00 | Hz | 100 = 1 Hz |
| 31.28 | Stall time | <i>Real</i> | 0...3600 | s | 1 = 1s |
| 31.31 | Frequency trip margin | <i>Real</i> | 0.00...10000.0 | Hz | 100 = 1 Hz |
| 31.32 | Emergency ramp supervision | <i>Real</i> | 0...300 | % | 1 = 1% |
| 31.33 | Emergency ramp supervision delay | <i>Real</i> | 0...100 | s | 1 = 1 s |
| 30.35 | Thermal current limitation | <i>List</i> | 0...1 | - | 1=1 |
| 31.36 | Screen auxiliary fan fault | <i>List</i> | 0...1 | - | 1=1 |
| 31.40 | Disable warning messages | <i>PB</i> | 0000h...FFFFh | - | 1 = 1 |
| 31.54 | Fault action | <i>List</i> | 0...1 | - | 1 = 1 |
| 32 Supervision | | | | | |
| 32.01 | Supervision status word | <i>PB</i> | 000...111b | - | 1 = 1 |
| 32.05 | Supervision 1 function | <i>List</i> | 0...7 | - | 1 = 1 |
| 32.06 | Supervision 1 action | <i>List</i> | 0...3 | - | 1 = 1 |
| 32.07 | Supervision 1 signal | <i>Analog src</i> | - | - | 1 = 1 |
| 32.08 | Supervision 1 filter time | <i>Real</i> | 0.000...30.000 | s | 1000 = 1s |
| 32.09 | Supervision 1 lower limit | <i>Real</i> | -21474836.00... 21474836.00 | - | 100 = 1 |
| 32.10 | Supervision 1 upper limit | <i>Real</i> | -21474836.00... 21474836.00 | - | 100 = 1 |
| 32.11 | Supervision 1 hysteresis | <i>Real</i> | 0.00...100000.00 | - | 100 = 1 |
| 32.15 | Supervision 2 function | <i>List</i> | 0...6 | - | 1 = 1 |
| 32.16 | Supervision 2 action | <i>List</i> | 0...2 | - | 1 = 1 |

| Serial number | Name | type | Range | Unit | FbEq32 |
|---------------|---------------------------|-------------------|--------------------------------|------|-----------|
| 32.17 | Supervision 2 signal | <i>Analog src</i> | - | - | 1 = 1 |
| 32.18 | Supervision 2 filter time | <i>Real</i> | 0.000...30.000 | s | 1000 = 1s |
| 32.19 | Supervision 2 lower limit | <i>Real</i> | -21474836.00... 21474836.00 | - | 100 = 1 |
| 32.20 | Supervision 2 upper limit | <i>Real</i> | -21474836.00... 21474836.00 | - | 100 = 1 |
| 32.21 | Supervision 2 hysteresis | <i>Real</i> | 0.00...100000.00 | - | 100 = 1 |
| 32.25 | Supervision 3 function | <i>List</i> | 0...6 | - | 1 = 1 |
| 32.26 | Supervision 3 action | <i>List</i> | 0...2 | - | 1 = 1 |
| 32.27 | Supervision 3 signal | <i>Analog src</i> | - | - | 1 = 1 |
| 32.28 | Supervision 3 filter time | <i>Real</i> | 0.000...30.000 | s | 1000 = 1s |
| 32.29 | Supervision 3 lower limit | <i>Real</i> | -21474836.00... 21474836.00 | - | 100 = 1 |
| 32.30 | Supervision 3 upper limit | <i>Real</i> | -21474836.00... 21474836.00 | - | 100 = 1 |
| 32.31 | Supervision 3 hysteresis | <i>Real</i> | 0.00...100000.00 | - | 100 = 1 |
| 32.35 | Supervision 4 function | <i>List</i> | 0...6 | - | 1 = 1 |
| 32.36 | Supervision 4 action | <i>List</i> | 0...2 | - | 1 = 1 |
| 32.37 | Supervision 4 signal | <i>Analog src</i> | - | - | 1 = 1 |
| 32.38 | Supervision 4 filter time | <i>Real</i> | 0.000...30.000 | s | 1000 = 1s |
| 32.39 | Supervision 4 lower limit | <i>Real</i> | -21474836.00... 21474836.00 | - | 100 = 1 |
| 32.40 | Supervision 4 upper limit | <i>Real</i> | -21474836.00... 21474836.00 | - | 100 = 1 |
| 32.41 | Supervision 4 hysteresis | <i>Real</i> | 0.00...100000.00 | - | 100 = 1 |
| 32.45 | Supervision 5 function | <i>List</i> | 0...6 | - | 1 = 1 |
| 32.46 | Supervision 5 action | <i>List</i> | 0...2 | - | 1 = 1 |
| 32.47 | Supervision 5 signal | <i>Analog src</i> | - | - | 1 = 1 |
| 32.48 | Supervision 5 filter time | <i>Real</i> | 0.000...30.000 | s | 1000 = 1s |
| 32.49 | Supervision 5 lower limit | <i>Real</i> | -21474836.00... 21474836.00 | - | 100 = 1 |
| 32.50 | Supervision 5 upper limit | <i>Real</i> | -21474836.00... 21474836.00 | - | 100 = 1 |
| 32.51 | Supervision 5 hysteresis | <i>Real</i> | 0.00...100000.00 | - | 100 = 1 |
| 32.55 | Supervision 6 function | <i>List</i> | 0...6 | - | 1 = 1 |
| 32.56 | Supervision 6 action | <i>List</i> | 0...2 | - | 1 = 1 |
| 32.57 | Supervision 6 signal | <i>Analog src</i> | - | - | 1 = 1 |
| 32.58 | Supervision 6 filter time | <i>Real</i> | 0.000...30.000 | s | 1000 = 1s |
| 32.59 | Supervision 6 lower limit | <i>Real</i> | -21474836.00... 21474836.00 | - | 100 = 1 |

| Serial number | Name | type | Range | Unit | FbEq32 |
|---------------------------|-----------------------------|-------------------|--------------------------------|------|-----------|
| 32.60 | Supervision 6 upper limit | <i>Real</i> | -21474836.00... 21474836.00 | - | 100 = 1 |
| 32.61 | Supervision 6 hysteresis | <i>Real</i> | 0.00...100000.00 | - | 100 = 1 |
| 34 Timed functions | | | | | |
| 34.01 | Combined timer status | <i>PB</i> | 0000h...FFFFh | - | 1 = 1 |
| 34.02 | Timer status | <i>PB</i> | 0000h...FFFFh | - | 1 = 1 |
| 34.04 | Season/exception day status | <i>PB</i> | 0000h...FFFFh | - | 1 = 1 |
| 34.10 | Timed functions enable | <i>Binary src</i> | - | - | 1 = 1 |
| 34.11 | Timer 1 configuration | <i>PB</i> | 0000h...FFFFh | - | 1 = 1 |
| 34.12 | Timer 1 start time | Times | 00:00:00...23:59:59 | s | 1 = 1 s |
| 34.13 | Timer 1 duration | Duration | 00 00:00...07 00:00 | min | 1 = 1 min |
| 34.14 | Timer 2 configuration | <i>PB</i> | 0000h...FFFFh | - | 1 = 1 |
| 34.15 | Timer 2 start time | Times | 00:00:00...23:59:59 | s | 1 = 1 s |
| 34.16 | Timer 2 duration | Duration | 00 00:00...07 00:00 | min | 1 = 1 min |
| 34.17 | Timer 3 configuration | <i>PB</i> | 0000h...FFFFh | - | 1 = 1 |
| 34.18 | Timer 3 start time | Times | 00:00:00...23:59:59 | s | 1 = 1 s |
| 34.19 | Timer 3 duration | Duration | 00 00:00...07 00:00 | min | 1 = 1 min |
| 34.20 | Timer 4 configuration | <i>PB</i> | 0000h...FFFFh | - | 1 = 1 |
| 34.21 | Timer 4 start time | Times | 00:00:00...23:59:59 | s | 1 = 1 s |
| 34.22 | Timer 4 duration | Duration | 00 00:00...07 00:00 | min | 1 = 1 min |
| 34.23 | Timer 5 configuration | <i>PB</i> | 0000h...FFFFh | - | 1 = 1 |
| 34.24 | Timer 5 start time | Times | 00:00:00...23:59:59 | s | 1 = 1 s |
| 34.25 | Timer 5 duration | Duration | 00 00:00...07 00:00 | min | 1 = 1 min |
| 34.26 | Timer 6 configuration | <i>PB</i> | 0000h...FFFFh | - | 1 = 1 |
| 34.27 | Timer 6 start time | Times | 00:00:00...23:59:59 | s | 1 = 1 s |
| 34.28 | Timer 6 duration | Duration | 00 00:00...07 00:00 | min | 1 = 1 min |
| 34.29 | Timer 7 configuration | <i>PB</i> | 0000h...FFFFh | - | 1 = 1 |
| 34.30 | Timer 7 start time | Times | 00:00:00...23:59:59 | s | 1 = 1 s |
| 34.31 | Timer 7 duration | Duration | 00 00:00...07 00:00 | min | 1 = 1 min |
| 34.32 | Timer 8 configuration | <i>PB</i> | 0000h...FFFFh | - | 1 = 1 |
| 34.33 | Timer 8 start time | Times | 00:00:00...23:59:59 | s | 1 = 1 s |
| 34.34 | Timer 8 duration | Duration | 00 00:00...07 00:00 | min | 1 = 1 min |
| 34.35 | Timer 9 configuration | <i>PB</i> | 0000h...FFFFh | - | 1 = 1 |
| 34.36 | Timer 9 start time | Times | 00:00:00...23:59:59 | s | 1 = 1 s |
| 34.37 | Timer 9 duration | Duration | 00 00:00...07 00:00 | min | 1 = 1 min |
| 34.38 | Timer 10 configuration | <i>PB</i> | 0000h...FFFFh | - | 1 = 1 |
| 34.39 | Timer 10 start time | Times | 00:00:00...23:59:59 | s | 1 = 1 s |
| 34.40 | Timer 10 duration | Duration | 00 00:00...07 00:00 | min | 1 = 1 min |
| 34.41 | Timer 11 configuration | <i>PB</i> | 0000h...FFFFh | - | 1 = 1 |
| 34.42 | Timer 11 start time | Times | 00:00:00...23:59:59 | s | 1 = 1 s |
| 34.43 | Timer 11 duration | Duration | 00 00:00...07 00:00 | min | 1 = 1 min |

| Serial number | Name | type | Range | Unit | FbEq32 |
|------------------------------------|--------------------------------|-------------------|------------------------------------|------------------|------------|
| 34.44 | Timer 12 configuration | <i>PB</i> | 0000h...FFFFh | - | 1 = 1 |
| 34.45 | Timer 12 start time | Times | 00:00:00...23:59:59 | s | 1 = 1 s |
| 34.46 | Timer 12 duration | Duration | 00 00:00...07 00:00 | min | 1 = 1 min |
| 34.60 | Season 1 start date | Date | 01.01...31.12 | d | 1 = 1 d |
| 34.61 | Season 2 start date | Date | 01.01...31.12 | d | 1 = 1 d |
| 34.62 | Season 3 start date | Date | 01.01...31.12 | d | 1 = 1 d |
| 34.63 | Season 4 start date | Date | 01.01...31.12 | d | 1 = 1 d |
| 34.70 | Number of active exceptions | <i>Real</i> | 0...16 | - | 1 = 1 |
| 34.71 | Exception types | <i>PB</i> | 0000h...FFFFh | - | 1 = 1 |
| 34.72 | Exception 1 start | Date | 01.01...31.12 | d | 1 = 1 d |
| 34.73 | Exception 1 length | <i>Real</i> | 0...60 | d | 1 = 1 d |
| 34.74 | Exception 2 start | Date | 01.01...31.12 | d | 1 = 1 d |
| 34.75 | Exception 2 length | <i>Real</i> | 0...60 | d | 1 = 1 d |
| 34.76 | Exception 3 start | Date | 01.01...31.12 | d | 1 = 1 d |
| 34.77 | Exception 3 length | <i>Real</i> | 0...60 | d | 1 = 1 d |
| 34.78 | Exception day 4 | Date | 01.01...31.12 | d | 1 = 1 d |
| 34.79 | Exception day 5 | Date | 01.01...31.12 | d | 1 = 1 d |
| 34.80 | Exception day 6 | Date | 01.01...31.12 | d | 1 = 1 d |
| 34.81 | Exception day 7 | Date | 01.01...31.12 | d | 1 = 1 d |
| 34.82 | Exception day 8 | Date | 01.01...31.12 | d | 1 = 1 d |
| 34.83 | Exception day 9 | Date | 01.01...31.12 | d | 1 = 1 d |
| 34.84 | Exception day 10 | Date | 01.01...31.12 | d | 1 = 1 d |
| 34.85 | Exception day 11 | Date | 01.01...31.12 | d | 1 = 1 d |
| 34.86 | Exception day 12 | Date | 01.01...31.12 | d | 1 = 1 d |
| 34.87 | Exception day 13 | Date | 01.01...31.12 | d | 1 = 1 d |
| 34.88 | Exception day 14 | Date | 01.01...31.12 | d | 1 = 1 d |
| 34.89 | Exception day 15 | Date | 01.01...31.12 | d | 1 = 1 d |
| 34.90 | Exception day 16 | Date | 01.01...31.12 | d | 1 = 1 d |
| 34.100 | Combined timer 1 | <i>PB</i> | 0000h...FFFFh | - | 1 = 1 |
| 34.101 | Combined timer 2 | <i>PB</i> | 0000h...FFFFh | - | 1 = 1 |
| 34.102 | Combined timer 3 | <i>PB</i> | 0000h...FFFFh | - | 1 = 1 |
| 34.110 | Extra time function | <i>PB</i> | 0000h...FFFFh | - | 1 = 1 |
| 34.111 | Extra time activation source | <i>Binary src</i> | - | - | 1 = 1 |
| 34.112 | Extra time duration | Duration | 00 00:00...07 00:00 | min | 1 = 1 min |
| 35 Motor thermal protection | | | | | |
| 35.01 | Estimated temperature of motor | <i>Real</i> | -60...1000 °C or -76...1832 °F | °C or °F | 1 = 1° |
| 35.02 | Measured temperature 1 | <i>Real</i> | -60...5000 °C or -76...9,032 °F | °C, °F or ohm | 1 = 1 unit |
| 35.03 | Measured temperature 2 | <i>Real</i> | -60...5000 °C or -76...9,032 °F | °C, °F or ohm | 1 = 1 unit |

112 Parameter data

| Serial number | Name | type | Range | Unit | FbEq32 |
|-------------------------|--------------------------------------------|-------------------|--------------------------------|---------------|-------------|
| 35.05 | Motor overload level | <i>Real</i> | 0.0...300.0 | % | 10 = 1% |
| 35.11 | Temperature 1 source | <i>List</i> | 0...1, 5...11 | - | 1 = 1 |
| 35.12 | Temperature 1 fault limit | <i>Real</i> | -60...5000 °C or -76...9032 °F | °C, °F or ohm | 1 = 1 unit |
| 35.13 | Temperature 1 warning limit | <i>Real</i> | -60...5000 °C or -76...9032 °F | °C, °F or ohm | 1 = 1 unit |
| 35.14 | Temperature 1 AI source | <i>Analog src</i> | - | - | 1 = 1 |
| 35.21 | Temperature 2 source | <i>List</i> | 0...1, 5...11 | - | 1 = 1 |
| 35.22 | Temperature 2 fault limit | <i>Real</i> | -60...5000 °C or -76...9032 °F | °C, °F or ohm | 1 = 1 unit |
| 35.23 | Temperature 2 warning limit | <i>Real</i> | -60...5000 °C or -76...9032 °F | °C, °F or ohm | 1 = 1 unit |
| 35.24 | Temperature 2 AI source | <i>Analog src</i> | - | - | 1 = 1 |
| 35.50 | Motor ambient temperature | <i>Real</i> | -60...100 °C or -75 ... 212 °F | °C | 1 = 1 ° |
| 35.51 | Motor load curve | <i>Real</i> | 50...150 | % | 1 = 1% |
| 35.52 | Zero speed load | <i>Real</i> | 50...150 | % | 1 = 1% |
| 35.53 | Load break point | <i>Real</i> | 1.00...500.00 | Hz | 100 = 1 Hz |
| 35.54 | Motor nominal temperature rise | <i>Real</i> | 0...300 °C or 32...572 °F | °C or °F | 1 = 1° |
| 35.55 | The motor thermal protection time constant | <i>Real</i> | 100...10000 | s | 1 = 1s |
| 35.56 | Motor overload action | <i>List</i> | 0...2 | - | 1 = 1 |
| 35.57 | Motor overload class | <i>List</i> | 0...4 | - | 1 = 1 |
| 36 Load analyzer | | | | | |
| 36.01 | PVL signal source | <i>Analog src</i> | - | - | 1 = 1 |
| 36.02 | PVL filter time | <i>Real</i> | 0.00...120.00 | s | 100 = 1 s |
| 36.06 | AL2 signal source | <i>Analog src</i> | - | - | 1 = 1 |
| 36.07 | AL2 signal scaling | <i>Real</i> | 0.00...32767.00 | - | 100 = 1 |
| 36.09 | Reset loggers | <i>List</i> | 0...3 | - | 1 = 1 |
| 36.10 | PVL peak value | <i>Real</i> | -32768.00...32767.00 | - | 100 = 1 |
| 36.11 | PVL peak date | <i>Data</i> | 1/1/1980...6/5/2159 | - | 1 = 1 |
| 36.12 | PVL peak time | <i>Data</i> | - | - | 1 = 1 |
| 36.13 | PVL current at peak | <i>Real</i> | -32768.00...32767.00 | A | 100 = 1 A |
| 36.14 | PVL DC voltage at peak | <i>Real</i> | 0.00...2000.00 | V | 100 = 1 V |
| 36.15 | PVL speed at peak | <i>Real</i> | -30000.00... 30000.00 | rpm | 100 = 1 rpm |
| 36.16 | PVL reset date | <i>Data</i> | 1/1/1980...6/5/2159 | - | 1 = 1 |
| 36.17 | PVL reset time | <i>Data</i> | - | - | 1 = 1 |
| 36.20 | AL1 0 to 10% | <i>Real</i> | 0.00...100.00 | % | 100 = 1% |
| 36.21 | AL1 10 to 20% | <i>Real</i> | 0.00...100.00 | % | 100 = 1% |
| 36.22 | AL1 20 to 30% | <i>Real</i> | 0.00...100.00 | % | 100 = 1% |

| Serial number | Name | type | Range | Unit | FbEq32 |
|---------------------------|-----------------------------|-------------------|---------------------|------|------------|
| 36.23 | AL1 30 to 40% | <i>Real</i> | 0.00...100.00 | % | 100 = 1% |
| 36.24 | AL1 40 to 50% | <i>Real</i> | 0.00...100.00 | % | 100 = 1% |
| 36.25 | AL1 50 to 60% | <i>Real</i> | 0.00...100.00 | % | 100 = 1% |
| 36.26 | AL1 60 to 70% | <i>Real</i> | 0.00...100.00 | % | 100 = 1% |
| 36.27 | AL1 70 to 80% | <i>Real</i> | 0.00...100.00 | % | 100 = 1% |
| 36.28 | AL1 80 to 90% | <i>Real</i> | 0.00...100.00 | % | 100 = 1% |
| 36.29 | AL1 over 90% | <i>Real</i> | 0.00...100.00 | % | 100 = 1% |
| 36.40 | AL2 0 to 10% | <i>Real</i> | 0.00...100.00 | % | 100 = 1% |
| 36.41 | AL2 10 to 20% | <i>Real</i> | 0.00...100.00 | % | 100 = 1% |
| 36.42 | AL2 20 to 30% | <i>Real</i> | 0.00...100.00 | % | 100 = 1% |
| 36.43 | AL2 30 to 40% | <i>Real</i> | 0.00...100.00 | % | 100 = 1% |
| 36.44 | AL2 40 to 50% | <i>Real</i> | 0.00...100.00 | % | 100 = 1% |
| 36.45 | AL2 50 to 60% | <i>Real</i> | 0.00...100.00 | % | 100 = 1% |
| 36.46 | AL2 60 to 70% | <i>Real</i> | 0.00...100.00 | % | 100 = 1% |
| 36.47 | AL2 70 to 80% | <i>Real</i> | 0.00...100.00 | % | 100 = 1% |
| 36.48 | AL2 80 to 90% | <i>Real</i> | 0.00...100.00 | % | 100 = 1% |
| 36.49 | AL2 over 90% | <i>Real</i> | 0.00...100.00 | % | 100 = 1% |
| 36.50 | AL2 reset date | <i>Data</i> | 1/1/1980...6/5/2159 | - | 1 = 1 |
| 36.51 | AL2 reset time | <i>Data</i> | - | - | 1 = 1 |
| 37 User load curve | | | | | |
| 37.01 | ULC output status word | <i>PB</i> | 0000h...FFFFh | - | 1 = 1 |
| 37.02 | ULC supervision signal | <i>Analog src</i> | - | - | 1 = 1 |
| 37.03 | ULC overload actions | <i>List</i> | 0...3 | - | 1 = 1 |
| 37.04 | ULC underload actions | <i>List</i> | 0...3 | - | 1 = 1 |
| 37.11 | ULC speed table point 1 | <i>Real</i> | -30000.0...30000.0 | rpm | 10 = 1 rpm |
| 37.12 | ULC speed table point 2 | <i>Real</i> | -30000.0...30000.0 | rpm | 10 = 1 rpm |
| 37.13 | ULC speed table point 3 | <i>Real</i> | -30000.0...30000.0 | rpm | 10 = 1 rpm |
| 37.14 | ULC speed table point 4 | <i>Real</i> | -30000.0...30000.0 | rpm | 10 = 1 rpm |
| 37.15 | ULC speed table point 5 | <i>Real</i> | -30000.0...30000.0 | rpm | 10 = 1 rpm |
| 37.16 | ULC frequency table point 1 | <i>Real</i> | -500.0...500.0 | Hz | 10 = 1 Hz |
| 37.17 | ULC frequency table point 2 | <i>Real</i> | -500.0...500.0 | Hz | 10 = 1 Hz |
| 37.18 | ULC frequency table point 3 | <i>Real</i> | -500.0...500.0 | Hz | 10 = 1 Hz |
| 37.19 | ULC frequency table point 4 | <i>Real</i> | -500.0...500.0 | Hz | 10 = 1 Hz |
| 37.20 | ULC frequency table point 5 | <i>Real</i> | -500.0...500.0 | Hz | 10 = 1 Hz |
| 37.21 | ULC underload point 1 | <i>Real</i> | -1600.0...1600.0 | % | 10 = 1% |
| 37.22 | ULC underload point 2 | <i>Real</i> | -1600.0...1600.0 | % | 10 = 1% |
| 37.23 | ULC underload point 3 | <i>Real</i> | -1600.0...1600.0 | % | 10 = 1% |
| 37.24 | ULC underload point 4 | <i>Real</i> | -1600.0...1600.0 | % | 10 = 1% |
| 37.25 | ULC underload point 5 | <i>Real</i> | -1600.0...1600.0 | % | 10 = 1% |
| 37.31 | ULC overload point 1 | <i>Real</i> | -1600.0...1600.0 | % | 10 = 1% |

114 Parameter data

| Serial number | Name | type | Range | Unit | FbEq32 |
|-----------------------------|-------------------------------------------------|-------------------|----------------------|-----------------|--------------|
| 37.32 | ULC overload point 2 | <i>Real</i> | -1600.0...1600.0 | % | 10 = 1% |
| 37.33 | ULC overload point 3 | <i>Real</i> | -1600.0...1600.0 | % | 10 = 1% |
| 37.34 | ULC overload point 4 | <i>Real</i> | -1600.0...1600.0 | % | 10 = 1% |
| 37.35 | ULC overload point 5 | <i>Real</i> | -1600.0...1600.0 | % | 10 = 1% |
| 37.41 | ULC overload timer | <i>Real</i> | 0.0...10000.0 | s | 10 = 1 s |
| 37.42 | ULC underload timer | <i>Real</i> | 0.0...10000.0 | s | 10 = 1 s |
| 40 Process PID set 1 | | | | | |
| 40.01 | PID output value | <i>Real</i> | -32768.00...32767.00 | rpm, % or Hz | 100 = 1 unit |
| 40.02 | PID feedback value | <i>Real</i> | -32768.00...32767.00 | rpm, % or Hz | 100 = 1 unit |
| 40.03 | PID setpoint | <i>Real</i> | -32768.00...32767.00 | rpm, % or Hz | 100 = 1 unit |
| 40.04 | PID deviation value | <i>Real</i> | -32768.00...32767.00 | rpm, % or Hz | 100 = 1 unit |
| 40.05 | Process PID trim output act | <i>Real</i> | -32768...32768 | - | 1 = 1 |
| 40.06 | PID status word | <i>PB</i> | 0000h...FFFFh | - | 1 = 1 |
| 40.07 | Process PID operation mode | <i>List</i> | 0...2 | - | 1 = 1 |
| 40.08 | Reference group 1 feedback 1 signal source | <i>Analog src</i> | - | - | 1 = 1 |
| 40.09 | Reference group 1 feedback 2 signal source | <i>Analog src</i> | - | - | 1 = 1 |
| 40.10 | Reference group 1 feedback function | <i>List</i> | 0...11 | - | 1 = 1 |
| 40.11 | Reference group 1 feedback filter time | <i>Real</i> | 0.000...30.000 | s | 1000 = 1s |
| 40.14 | Reference group 1 reference conversion | <i>Real</i> | -32768.00...32767.00 | - | 1 = 1 |
| 40.15 | Reference group 1 output conversion | <i>Real</i> | -32768.00...32767.00 | - | 1 = 1 |
| 40.16 | Reference group 1 set value 1 signal source | <i>Analog src</i> | - | - | 1 = 1 |
| 40.17 | Reference group 1 set value 2 signal source | <i>Analog src</i> | - | - | 1 = 1 |
| 40.18 | Reference group 1 set value function | <i>List</i> | 0...11 | - | 1 = 1 |
| 40.19 | Reference group 1 internal setpoint selection 1 | <i>Binary src</i> | - | - | 1 = 1 |
| 40.20 | Reference group 1 internal setpoint selection 2 | <i>Binary src</i> | - | - | 1 = 1 |
| 40.21 | Reference group 1 internal setpoint 1 | <i>Real</i> | -32768.00...32767.00 | rpm, % or Hz | 100 = 1 unit |
| 40.22 | Reference group 1 internal setpoint 2 | <i>Real</i> | -32768.00...32767.00 | rpm, % or Hz | 100 = 1 unit |
| 40.23 | Reference group 1 internal setpoint 3 | <i>Real</i> | -32768.00...32767.00 | rpm, % or Hz | 100 = 1 unit |

| Serial number | Name | type | Range | Unit | FbEq32 |
|---------------|------------------------------------------------|-------------------|------------------------|--------------------|---------------------------|
| 40.24 | Set 1 internal setpoint 0 | <i>Real</i> | -200000.00...200000.00 | PID customer units | 100 = 1 PID customer unit |
| 40.26 | Reference group 1 the minimum set value | <i>Real</i> | -32768.00...32767.00 | - | 100 = 1 |
| 40.27 | Reference group 1 the maximum set value | <i>Real</i> | -32768.00...32767.00 | - | 100 = 1 |
| 40.28 | Reference group 1 set value increase time | <i>Real</i> | 0.0...1800.0 | s | 10 = 1s |
| 40.29 | Reference group 1 setpoint decrease time | <i>Real</i> | 0.0...1800.0 | s | 10 = 1s |
| 40.30 | Reference group 1 set value keeping function | <i>Binary src</i> | - | - | 1 = 1 |
| 40.31 | Reference group 1 negated deviation value | <i>Binary src</i> | - | - | 1 = 1 |
| 40.32 | Reference group 1 gain | <i>Real</i> | 0.10...100.00 | - | 100 = 1 |
| 40.33 | Reference group 1 integration time | <i>Real</i> | 0.0...9999.0 | s | 10 = 1s |
| 40.34 | Reference group 1 derivation time | <i>Real</i> | 0.000...10.000 | s | 1000 = 1s |
| 40.35 | Reference group 1 derivation filter time | <i>Real</i> | 0.0...10.0 | s | 10 = 1s |
| 40.36 | Reference group 1 the minimum output value | <i>Real</i> | -32768.0...32767.0 | - | 10 = 1 |
| 40.37 | Reference group 1 the maximum output value | <i>Real</i> | -32768.0...32767.0 | - | 10 = 1 |
| 40.38 | Reference group 1 output keeping function | <i>Binary src</i> | - | - | 1 = 1 |
| 40.39 | Set 1 deadband range | <i>Real</i> | 0.00.....200000.00 | PID customer units | 100 = 1 PID customer unit |
| 40.40 | Set 1 deadband delay | <i>Real</i> | 0.0 ... 3600.0 | s | 10 = 1 s |
| 40.43 | Reference group 1 sleep frequency | <i>Real</i> | 0.0...32767.0 | - | 10 = 1 |
| 40.44 | Reference group 1 sleeping delay | <i>Real</i> | 0.0...3600.0 | s | 10 = 1s |
| 40.45 | Reference group 1 sleep boost time | <i>Real</i> | 0.0...3600.0 | s | 10 = 1s |
| 40.46 | Reference group 1 sleeping raise period | <i>Real</i> | 0.0...32767.0 | - | 10 = 1 |
| 40.47 | Reference group 1 wake-up deviation | <i>Real</i> | -32768.00 = 32767.00 | rpm, % or Hz | 100 = 1 unit |
| 40.48 | Reference group 1 wake-up delay | <i>Real</i> | 0.00...60.00 | s | 100 = 1s |
| 40.49 | Reference group 1 tracking mode | <i>Binary src</i> | - | - | 1 = 1 |
| 40.50 | Reference group 1 tracking reference selection | <i>Analog src</i> | - | - | 1 = 1 |

| Serial number | Name | type | Range | Unit | FbEq32 |
|-----------------------------|---------------------------------------------|------------|------------------------|-----------------|--------------|
| 40.51 | Set 1 trim mode | List | 0...3 | - | 1 = 1 |
| 40.52 | Set 1 trim selection | List | 1...3 | - | 1 = 1 |
| 40.53 | Set 1 trimmed ref pointer | Binary src | - | - | 1 = 1 |
| 40.54 | Set 1 trim mix | Real | 0.000 ... 1.000 | - | 1000 = 1 |
| 40.55 | Set 1 trim adjust | Real | -100.000 ... 100.000 | - | 1000 = 1 |
| 40.56 | Set 1 trim source | List | 1...2 | - | 1 = 1 |
| 40.57 | PID set1/set2 selection | Binary src | - | - | 1 = 1 |
| 40.58 | Reference group 1 output raise limit | List | 0...3 | - | 1 = 1 |
| 40.59 | Reference group 1 output decrease limit | List | 0...3 | - | 1 = 1 |
| 40.60 | Set 1 PID activation source | Binary src | - | - | 1 = 1 |
| 40.61 | Setpoint scaling actual | Real | -200000.00...200000.00 | - | 100 = 1 |
| 40.62 | PID internal actual setpoint | Real | -32768.00...32767.00 | rpm, % or Hz | 100 = 1 unit |
| 40.65 | Trim auto connection | List | 0...1 | - | 1 = 1 |
| 40.79 | Set 1 units | List | - | - | 1 = 1 |
| 40.80 | Set 1 PID output min source | List | 0...1 | - | 1 = 1 |
| 40.81 | Set 1 PID output max source | List | 0...1 | - | 1 = 1 |
| 40.89 | Set 1 setpoint multiplier | Real | -200000.00...200000.00 | - | 100 = 1 |
| 40.90 | Set 1 feedback multiplier | Real | -200000.00...200000.00 | - | 100 = 1 |
| 40.91 | Feedback data storage | Real | -327.68...327.67 | - | 100=1 |
| 40.92 | Setpoint data storage | Real | -327.68...327.67 | - | 100=1 |
| 40.96 | Process PID output % | Real | -100.00...100.00 | % | 100 = 1 |
| 40.97 | Process PID feedback % | Real | -100.00...100.00 | % | 100 = 1 |
| 40.98 | Process PID setpoint % | Real | -100.00...100.00 | % | 100 = 1 |
| 40.99 | Process PID deviation % | Real | -100.00...100.00 | % | 100 = 1 |
| 41 Process PID set 2 | | | | | |
| 41.08 | Reference group 2 feedback 1 signal source | Analog src | - | - | 1 = 1 |
| 41.09 | Reference group 2 feedback 2 signal source | Analog src | - | - | 1 = 1 |
| 41.10 | Reference group 2 feedback function | List | 0...11 | - | 1 = 1 |
| 41.11 | Reference group 2 feedback filter time | Real | 0.000...30.000 | s | 1000 = 1s |
| 41.14 | Reference group 2 reference conversion | Real | -32768.00...32767.00 | - | 1 = 1 |
| 41.15 | Reference group 2 output conversion | Real | -32768.00...32767.00 | - | 1 = 1 |
| 41.16 | Reference group 2 set value 1 signal source | Analog src | - | - | 1 = 1 |
| 41.17 | Reference group 2 set value 2 signal source | Analog src | - | - | 1 = 1 |

| Serial number | Name | type | Range | Unit | FbEq32 |
|---------------|-------------------------------------------------|-------------------|------------------------|--------------------|---------------------------|
| 41.18 | Reference group 2 set value function | <i>List</i> | 0...11 | - | 1 = 1 |
| 41.19 | Reference group 2 internal setpoint selection 1 | <i>Binary src</i> | - | - | 1 = 1 |
| 41.20 | Reference group 2 internal setpoint selection 2 | <i>Binary src</i> | - | - | 1 = 1 |
| 41.21 | Reference group 2 internal setpoint 1 | <i>Real</i> | -32768.0...32767.0 | rpm, % or Hz | 100 = 1 unit |
| 41.22 | Reference group 2 internal setpoint 2 | <i>Real</i> | -32768.0...32767.0 | rpm, % or Hz | 100 = 1 unit |
| 41.23 | Reference group 2 internal setpoint 3 | <i>Real</i> | -32768.0...32767.0 | rpm, % or Hz | 100 = 1 unit |
| 41.24 | Set 2 internal setpoint 0 | <i>Real</i> | -200000.00...200000.00 | PID customer units | 100 = 1 PID customer unit |
| 41.26 | Reference group 2 the minimum set value | <i>Real</i> | -32768.0...32767.0 | - | 100 = 1 |
| 41.27 | Reference group 2 the maximum set value | <i>Real</i> | -32768.0...32767.0 | - | 100 = 1 |
| 41.28 | Reference group 2 set value increase time | <i>Real</i> | 0.0...1800.0 | s | 10 = 1s |
| 41.29 | Reference group 2 setpoint decrease time | <i>Real</i> | 0.0...1800.0 | s | 10 = 1s |
| 41.30 | Reference group 2 set value keeping function | <i>Binary src</i> | - | - | 1 = 1 |
| 41.31 | Reference group 2 negated deviation value | <i>Binary src</i> | - | - | 1 = 1 |
| 41.32 | Reference group 2 gain | <i>Real</i> | 0.10...100.00 | - | 100 = 1 |
| 41.33 | Reference group 2 integration time | <i>Real</i> | 0.0...9999.0 | s | 10 = 1s |
| 41.34 | Reference group 2 derivation time | <i>Real</i> | 0.000...10.000 | s | 1000 = 1s |
| 41.35 | Reference group 2 derivation filter time | <i>Real</i> | 0.0...10.0 | s | 10 = 1s |
| 41.36 | Reference group 2 the minimum output value | <i>Real</i> | -32768.0...32767.0 | - | 10 = 1 |
| 41.37 | Reference group 2 the maximum output value | <i>Real</i> | -32768.0...32767.0 | - | 10 = 1 |
| 41.38 | Reference group 2 output keeping function | <i>Binary src</i> | - | - | 1 = 1 |
| 41.39 | Set 2 deadband range | <i>Real</i> | 0.00.....200000.00 | - | 100 = 1 PID customer unit |
| 41.40 | Set 2 deadband delay | <i>Real</i> | 0.0 ... 3600.0 | s | 10 = 1 s |
| 41.43 | Reference group 2 sleeping speed/frequency | <i>Real</i> | 0.0...32767.0 | - | 10 = 1 |
| 41.44 | Reference group 2 sleeping delay | <i>Real</i> | 0.0...3600.0 | s | 10 = 1s |

| Serial number | Name | type | Range | Unit | FbEq32 |
|------------------------------------|-----------------------------------------|-------------------|------------------------------|-----------------|--------------|
| 41.45 | Reference group 2 sleep boost time | <i>Real</i> | 0.0...3600.0 | s | 10 = 1s |
| 41.46 | Reference group 2 sleeping raise period | <i>Real</i> | 0.0...32767.0 | - | 10 = 1 |
| 41.47 | Reference group 2 wake-up deviation | <i>Real</i> | -2147483648... 2147483647 | rpm, % or Hz | 100 = 1 unit |
| 41.48 | Reference group 2 wake-up delay | <i>Real</i> | 0.00...60.00 | s | 100 = 1s |
| 41.49 | Reference group 2 tracking mode | <i>Binary src</i> | - | - | 1 = 1 |
| 41.50 | Set 2 tracking ref selection | <i>Analog src</i> | - | - | 1 = 1 |
| 41.51 | Set 2 trim mode | <i>List</i> | 0...3 | - | 1 = 1 |
| 41.52 | Set 2 trim selection | <i>List</i> | 1...3 | - | 1 = 1 |
| 41.53 | Set 2 trimmed ref pointer | <i>Analog src</i> | - | - | 1 = 1 |
| 41.54 | Set 2 trim mix | <i>Real</i> | 0.000 ... 1.000 | - | 1000 = 1 |
| 41.55 | Set 2 trim adjust | <i>Real</i> | -100.000 ... 100.000 | - | 1000 = 1 |
| 41.56 | Set 2 trim source | <i>List</i> | 1...2 | - | 1 = 1 |
| 41.58 | Reference group 2 output raise limit | <i>List</i> | - | - | 1 = 1 |
| 41.59 | Reference group 2 output decrease limit | <i>List</i> | - | - | 1 = 1 |
| 41.60 | Set 2 PID activation source | <i>Binary src</i> | - | - | 1 = 1 |
| 41.79 | Set 2 units | <i>List</i> | - | - | 1 = 1 |
| 41.80 | Set 2 PID output min source | <i>List</i> | 0...1 | - | 1 = 1 |
| 41.81 | Set 2 PID output max source | <i>List</i> | 0...1 | - | 1 = 1 |
| 41.89 | Set 2 setpoint multiplier | <i>Real</i> | -200000.00...200000.00 | - | 100 = 1 |
| 41.90 | Set 2 feedback multiplier | <i>Real</i> | -200000.00...200000.00 | - | 100 = 1 |
| 43 Brake chopper | | | | | |
| 43.01 | Brake resistor temperature | <i>Real</i> | 0.0...120.0 | % | 10 = 1% |
| 43.06 | Braking chopper enable | <i>List</i> | 0...3 | - | 1 = 1 |
| 43.07 | Braking chopper runtime enable | <i>Binary src</i> | - | - | 1 = 1 |
| 43.08 | Brake resistor thermal time | <i>Real</i> | 0...10000 | s | 1 = 1s |
| 43.09 | Brake resistor Pmax cont | <i>Real</i> | 0.00...10000.00 | kW | 100 = 1 kW |
| 43.10 | Brake resistance | <i>Real</i> | 0.0...1000.0 | ohm | 10 = 1 ohm |
| 43.11 | Brake resistor fault limit | <i>Real</i> | 0...150 | % | 1 = 1% |
| 43.12 | Brake resistor warning limit | <i>Real</i> | 0...150 | % | 1 = 1% |
| 44 Mechanical brake control | | | | | |
| 44.01 | Brake control status word | <i>PB</i> | 0000h...FFFFh | - | 1 = 1 |
| 44.06 | Brake control enable | <i>Binary src</i> | - | - | 1 = 1 |
| 44.08 | BRAKE OPENING DELAY | <i>Real</i> | 0.00...5.00 | s | 100 = 1s |
| 44.13 | Brake close delay | <i>Real</i> | 0.00...60.00 | s | 100 = 1s |

| Serial number | Name | type | Range | Unit | FbEq32 |
|-----------------------------|---------------------------------------|-------------------|----------------------------|----------------|-------------------------|
| 44.14 | Brake close level | <i>Real</i> | 0.0...1000.0 | rpm | 100 = 1 rpm |
| 45 Energy efficiency | | | | | |
| 45.01 | Saved energy (kWh) | <i>Real</i> | 0...65535 | GWh | 1 = 1 GWh |
| 45.02 | Saved energy (kWh) | <i>Real</i> | 0...999 | MWh | 1 = 1 MWh |
| 45.03 | Saved energy (kWh) | <i>Real</i> | 0.0...999.0 | kWh | 10 = 1 kWh |
| 45.04 | Totally saved energy | <i>Real</i> | 0.0...214748368.0 | kWh | 10 = 1 kWh |
| 45.05 | Saved money x1000 | <i>Real</i> | 0...4294967295 | (Optional) | 1 = 1 unit |
| 45.06 | Saved money | <i>Real</i> | 0.00...999.99 | (Optional) | 100 = 1 unit |
| 45.07 | Saved amount | <i>Real</i> | 0.00...21474830.00 | (Optional) | 100 = 1 unit |
| 45.08 | CO2 reduction (in metric tons) | <i>Real</i> | 0...65535 | metric kiloton | 1 = 1 metric kiloton |
| 45.09 | CO2 reduction (in tons) | <i>Real</i> | 0.0...999.9 | metric ton | 10 = 1 metric ton |
| 45.10 | Decreased CO2 emission | <i>Real</i> | 0.0...214748304.0 | metric ton | 10 = 1 metric ton |
| 45.11 | Energy (flux) optimization | <i>List</i> | 0...1 | - | 1 = 1 |
| 45.12 | Energy tariff 1 | <i>Real</i> | 0.000...4294966.296 | (Optional) | 1000 = 1 unit |
| 45.13 | Energy tariff 2 | <i>Real</i> | 0.000...4294966.296 | (Optional) | 1000 = 1 unit |
| 45.14 | Tariff selection | <i>Binary src</i> | - | - | 1 = 1 |
| 45.18 | CO2 conversion factor | <i>Real</i> | 0.000...65.535 | metric ton/MWh | 1000 = 1 metric ton/MWh |
| 45.19 | Comparison power | <i>Real</i> | 0.00...100000.00 | kW | 10 = 1 kW |
| 45.21 | Energy calculations reset | <i>List</i> | 0...1 | - | 1 = 1 |
| 45.24 | Hourly peak power value | <i>Real</i> | -3000.00...3000.00 | kW | 1 = 1 kW |
| 45.25 | Hourly peak power time | <i>Real</i> | | | N/A |
| 45.26 | Hourly total energy (resettable) | <i>Real</i> | -3000.00 ... 3000.00 | kWh | 1 = 1 kWh |
| 45.27 | Daily peak power value (resettable) | <i>Real</i> | -3000.00 ... 3000.00 | kW | 1 = 1 kW |
| 45.28 | Daily peak power time | <i>Real</i> | | | N/A |
| 45.29 | Daily total energy (resettable) | <i>Real</i> | -30000.00 ... 30000.00 | kWh | 1 = 1 kWh |
| 45.30 | Last day total energy | <i>Real</i> | -30000.00 ... 30000.00 | kWh | 1 = 1 kWh |
| 45.31 | Monthly peak power value (resettable) | <i>Real</i> | -3000.00 ... 3000.00 | kW | 1 = 1 kW |
| 45.32 | Monthly peak power date | <i>Real</i> | 1/1/1980...6/5/2159 | | N/A |
| 45.33 | Monthly peak power time | <i>Real</i> | - | | N/A |
| 45.34 | Monthly total energy (resettable) | <i>Real</i> | -1000000.00 ... 1000000.00 | kWh | 1 = 1 kWh |
| 45.35 | Last month total energy | <i>Real</i> | -1000000.00 ... 1000000.00 | kWh | 1 = 1 kWh |

| Serial number | Name | type | Range | Unit | FbEq32 |
|---------------------------------------|--------------------------------------------|-------------|-----------------------------------------|-------------|-----------------|
| 45.36 | Lifetime peak power value | <i>Real</i> | -3000.00 ... 3000.00 | kW | 1 = 1 kW |
| 45.37 | Lifetime peak power date | <i>Real</i> | 1/1/1980...6/5/2159 | | N/A |
| 45.38 | Lifetime peak power time | <i>Real</i> | - | | N/A |
| 46 Monitoring/scaling settings | | | | | |
| 46.01 | Speed fieldbus scaled value | <i>Real</i> | 0.00...30000.00 | rpm | 100 = 1 rpm |
| 46.02 | Frequency fieldbus scaled value | <i>Real</i> | 0.10...1000.00 | Hz | 100 = 1 Hz |
| 46.03 | Torque fieldbus scaled value | <i>Real</i> | 0.1...1000.0 | % | 10 = 1% |
| 46.04 | Power fieldbus scaled value | <i>Real</i> | 0.1...30000.0 kW or 0.1...40215.5 hp | kW or hp | 10 = 1 unit |
| 46.05 | Current fieldbus scaled value | <i>Real</i> | 0...30000 | A | 1 = 1 A |
| 46.06 | Zero-speed reference fieldbus scaled value | <i>Real</i> | 0...30000.00 | rpm | 100 = 1 rpm |
| 46.07 | Frequency ref zero scaling | <i>Real</i> | 0.00...1000.00 | Hz | 100 = 1 Hz |
| 46.11 | Motor speed filter time | <i>Real</i> | 2...20000 | ms | 1 = 1 ms |
| 46.12 | Filter time output frequency | <i>Real</i> | 2...20000 | ms | 1 = 1 ms |
| 46.13 | Filter time motor torque | <i>Real</i> | 2...20000 | ms | 1 = 1 ms |
| 46.14 | Filter time power out | <i>Real</i> | 2...20000 | ms | 1 = 1 ms |
| 46.22 | Frequency arrival hysteresis | <i>Real</i> | 0.00...1000.00 | Hz | 100 = 1 Hz |
| 46.32 | Upper limit of frequency | <i>Real</i> | 0.00...1000.00 | Hz | 100 = 1 Hz |
| 46.41 | kWh pulse scaling | <i>Real</i> | 0.001...1000.000 | kWh | 1000 = 1 kWh |
| 46.43 | Power decimals | <i>Real</i> | 0...3 | - | 1 = 1 |
| 46.44 | Current decimals | <i>Real</i> | 0...3 | - | 1 = 1 |
| 47 Data storage | | | | | |
| 47.01 | Data storage 1 real 32 | <i>Real</i> | -2147483.000... 2147483.000 | - | 1000 = 1 |
| 47.02 | Data storage 2 real 32 | <i>Real</i> | -2147483.000... 2147483.000 | - | 1000 = 1 |
| 47.03 | Data storage 3 real 32 | <i>Real</i> | -2147483.000... 2147483.000 | - | 1000 = 1 |
| 47.04 | Data storage 4 real 32 | <i>Real</i> | -2147483.000... 2147483.000 | - | 1000 = 1 |
| 47.11 | Data storage 1 int32 | <i>Real</i> | -2147483648... 2147483647 | - | 1 = 1 |
| 47.12 | Data storage 2 int32 | <i>Real</i> | -2147483648... 2147483647 | - | 1 = 1 |
| 47.13 | Data storage 3 int32 | <i>Real</i> | -2147483648... 2147483647 | - | 1 = 1 |
| 47.14 | Data storage 4 int32 | <i>Real</i> | -2147483648... 2147483647 | - | 1 = 1 |
| 47.21 | Data storage 1 int16 | <i>Real</i> | -32768...32767 | - | 1 = 1 |
| 47.22 | Data storage 2 int16 | <i>Real</i> | -32768...32767 | - | 1 = 1 |
| 47.23 | Data storage 3 int16 | <i>Real</i> | -32768...32767 | - | 1 = 1 |

| Serial number | Name | type | Range | Unit | FbEq32 |
|------------------------------------|----------------------------------------------------------|-------------------|---------------------------------------------------------|------|---------|
| 47.24 | Data storage 4 int16 | <i>Real</i> | -32768...32767 | - | 1 = 1 |
| 49 Panel port communication | | | | | |
| 49.01 | Control panel communication transmission station address | <i>Real</i> | 1...32 | - | 1 = 1 |
| 49.03 | Baud rate | <i>List</i> | 1...5 | - | 1 = 1 |
| 49.04 | Communication loss time-out | <i>Real</i> | 0.3...3000.0 | s | 10 = 1s |
| 49.05 | Communication loss action | <i>List</i> | 0...3 | - | 1 = 1 |
| 49.06 | Refresh | <i>List</i> | 0...1 | - | 1 = 1 |
| 49.20 | Basic panel home view 2 | <i>List</i> | 0, 1, 10...12, 14,16, 20, 21, 26...28, 30...33, 37...38 | - | 1 = |
| 49.21 | Basic panel home view 3 | <i>List</i> | 0, 1, 10...12, 14,16, 20, 21, 26...28, 30...33, 37...38 | - | 1 = 1 |
| 49.219 | Basic panel home view 4 | <i>List</i> | 0, 1, 10...12, 14,16, 20, 21, 26...28, 30...33, 37...38 | - | 1 = 1 |
| 49.220 | Basic panel home view 5 | <i>List</i> | 0, 1, 10...12, 14,16, 20, 21, 26...28, 30...33, 37...38 | - | 1 = 1 |
| 49.221 | Basic panel home view 6 | <i>List</i> | 0, 1, 10...12, 14,16, 20, 21, 26...28, 30...33, 37...38 | - | 1 = 1 |
| 50 Fieldbus adapter (FBA) | | | | | |
| 50.01 | FBA A Enable | <i>List</i> | 0...1 | - | 1 = 1 |
| 50.02 | FBA A communication loss function | <i>List</i> | 0...5 | - | 1 = 1 |
| 50.03 | FBA A communication loss time out | <i>Real</i> | 0.3...6553.5 | s | 10 = 1s |
| 50.04 | FBA A Reference 1 type | <i>List</i> | 0...5 | - | 1 = 1 |
| 50.05 | FBA A Reference 2 type | <i>List</i> | 0...5 | - | 1 = 1 |
| 50.06 | FBA A SW selection | <i>List</i> | 0...1 | - | 1 = 1 |
| 50.07 | FBA A Actual 1 type | <i>List</i> | 0...5 | - | 1 = 1 |
| 50.08 | FBA A Actual 2 type | <i>List</i> | 0...5 | - | 1 = 1 |
| 50.09 | FBA A SW transparent source | <i>Analog src</i> | - | - | 1 = 1 |
| 50.10 | FBA A Actual value 1 transparent value | <i>Analog src</i> | - | - | 1 = 1 |
| 50.11 | FBA A Actual value 2 transparent value | <i>Analog src</i> | - | - | 1 = 1 |
| 50.12 | FBA A debug mode | <i>List</i> | 0...1 | - | 1 = 1 |
| 50.13 | FBA A Control Word | <i>Data</i> | 0000000h...FFFFFFFh | - | 1 = 1 |
| 50.14 | FBA A reference 1 | <i>Real</i> | -2147483648... 2147483647 | - | 1 = 1 |
| 50.15 | FBA A reference 2 | <i>Real</i> | -2147483648... 2147483647 | - | 1 = 1 |

| Serial number | Name | type | Range | Unit | FbEq32 |
|-----------------------------|--------------------------------|-------------|------------------------------|------|--------|
| 50.16 | FBA A Status Word | <i>Data</i> | 00000000h...FFFFFFFFh | - | 1 = 1 |
| 50.17 | FBA A Actual value 1 | <i>Real</i> | -2147483648... 2147483647 | - | 1 = 1 |
| 50.18 | FBA A Actual value 2 | <i>Real</i> | -2147483648... 2147483647 | - | 1 = 1 |
| 51 FBA A settings | | | | | |
| 51.01 | FBA A type | <i>List</i> | 0.....47808 | - | 1 = 1 |
| 51.02 | FBA A Par 2 | <i>Real</i> | 0...65535 | - | 1 = 1 |
| ... | ... | ... | ... | ... | ... |
| 51.26 | FBA A Par 26 | <i>Real</i> | 0...65535 | - | 1 = 1 |
| 51.27 | FBA A parameter update | <i>List</i> | 0...1 | - | 1 = 1 |
| 51.28 | FBA A par table version | <i>Data</i> | 0000...FFFF | - | 1 = 1 |
| 51.29 | FBA A drive type code | <i>Real</i> | 0...65535 | - | 1 = 1 |
| 51.30 | FBA A mapping file version | <i>Real</i> | 0...65535 | - | 1 = 1 |
| 51.31 | FBA A communication status | <i>List</i> | 0...6 | - | 1 = 1 |
| 51.32 | FBA A communication SW version | <i>Data</i> | 0000...FFFF | - | 1 = 1 |
| 51.33 | FBA A application SW version | <i>Data</i> | 0000...FFFF | - | 1 = 1 |
| 52 FBA A data in | | | | | |
| 52.01 | FBA A data in 1 | <i>List</i> | - | - | 1 = 1 |
| ... | ... | ... | ... | ... | ... |
| 52.12 | FBA A data in 12 | <i>List</i> | - | - | 1 = 1 |
| 53 FBA A data out | | | | | |
| 53.01 | FBA A data out 1 | <i>List</i> | - | - | 1 = 1 |
| ... | ... | ... | ... | ... | ... |
| 53.12 | FBA A data out 12 | <i>List</i> | - | - | 1 = 1 |
| 58 Embedded fieldbus | | | | | |
| 58.01 | Protocol enable | <i>List</i> | 0...1 | - | 1 = 1 |
| 58.02 | Protocol ID | <i>Real</i> | 0000...FFFF | - | 1 = 1 |
| 58.03 | Node address | <i>Real</i> | 0...255 | - | 1 = 1 |
| 58.04 | Baud rate | <i>List</i> | 0...7 | - | 1 = 1 |
| 58.05 | Parity | <i>List</i> | 0...3 | - | 1 = 1 |
| 58.06 | Communication control | <i>List</i> | 0...2 | - | 1 = 1 |
| 58.07 | Communication diagnostics | <i>PB</i> | 0000h...FFFFh | - | 1 = 1 |
| 58.08 | Received packets | <i>Real</i> | 0...4294967295 | - | 1 = 1 |
| 58.09 | Transmitted packets | <i>Real</i> | 0...4294967295 | - | 1 = 1 |
| 58.10 | All packets | <i>Real</i> | 0...4294967295 | - | 1 = 1 |
| 58.11 | UART errors | <i>Real</i> | 0...4294967295 | - | 1 = 1 |
| 58.12 | CRC errors | <i>Real</i> | 0...4294967295 | - | 1 = 1 |
| 58.14 | Communication loss action | <i>List</i> | 0...5 | - | 1 = 1 |
| 58.15 | Communication loss mode | <i>List</i> | 1...2 | - | 1 = 1 |

| Serial number | Name | type | Range | Unit | FbEq32 |
|--------------------|-----------------------------|-------------------|----------------|------|------------|
| 58.16 | Communication loss time | <i>Real</i> | 0.0...6000.0 | s | 10 = 1s |
| 58.17 | Transmit delay | <i>Real</i> | 0...65535 | ms | 1 = 1 ms |
| 58.18 | EFB control word | <i>PB</i> | 0000h...FFFFh | - | 1 = 1 |
| 58.19 | EFB status word | <i>PB</i> | 0000h...FFFFh | - | 1 = 1 |
| 58.25 | Profile | <i>List</i> | 0...5 | - | 1 = 1 |
| 58.26 | EFB ref1 type | <i>List</i> | 0...5 | - | 1 = 1 |
| 58.27 | EFB ref 2 type | <i>List</i> | 0...5 | - | 1 = 1 |
| 58.28 | EFB actual value 1 type | <i>List</i> | 0...5 | - | 1 = 1 |
| 58.29 | EFB actual value 2 type | <i>List</i> | 0...5 | - | 1 = 1 |
| 58.31 | EFB act1 transparent source | <i>Analog src</i> | - | - | 1 = 1 |
| 58.32 | EFB act2 transparent source | <i>Analog src</i> | - | - | 1 = 1 |
| 58.33 | Addressing mode | <i>List</i> | 0...2 | - | 1 = 1 |
| 58.34 | Word order | <i>List</i> | 0...1 | - | 1 = 1 |
| 58.101 | Data I/O 1 | <i>Analog src</i> | - | - | 1 = 1 |
| 58.102 | Data I/O 2 | <i>Analog src</i> | - | - | 1 = 1 |
| 58.103 | Data I/O 3 | <i>Analog src</i> | - | - | 1 = 1 |
| 58.104 | Data I/O 4 | <i>Analog src</i> | - | - | 1 = 1 |
| 58.105 | Data I/O 5 | <i>Analog src</i> | - | - | 1 = 1 |
| 58.106 | Data I/O 6 | <i>Analog src</i> | - | - | 1 = 1 |
| 58.107 | Data I/O 7 | <i>Analog src</i> | - | - | 1 = 1 |
| ... | ... | ... | ... | ... | |
| 58.114 | Data I/O 14 | <i>Analog src</i> | - | - | 1 = 1 |
| 70 Override | | | | | |
| 70.01 | Override status | <i>PB</i> | 0000h...FFFFh | - | 1 = 1 |
| 70.02 | Override enable | <i>List</i> | 0...1 | - | 1 = 1 |
| 70.03 | Override activation source | <i>Binary src</i> | - | - | 1 = 1 |
| 70.04 | Override reference source | <i>List</i> | 0...6 | - | 1 = 1 |
| 70.05 | Override direction | <i>Binary src</i> | - | - | 1 = 1 |
| 70.06 | Override frequency | <i>Real</i> | -500.0...500.0 | Hz | 100 = 1 Hz |
| 70.40 | Override log 1 start date | <i>Real</i> | | - | |
| 70.41 | Override log 1 start time | <i>Real</i> | | - | |
| 70.42 | Override log 1 end date | <i>Real</i> | | - | |
| 70.43 | Override log 1 end time | <i>Real</i> | | - | |
| 70.44 | Override log 1 fault 1 | <i>Real</i> | | - | |

| Serial number | Name | type | Range | Unit | FbEq32 |
|-------------------------|---------------------------|-------------------|------------------------|--------------------|---------------------------|
| 70.45 | Override log 1 fault 2 | <i>Real</i> | | - | |
| 70.46 | Override log 1 fault 3 | <i>Real</i> | | - | |
| 70.47 | Override log 1 warning 1 | <i>Real</i> | | - | |
| 70.48 | Override log 1 warning 2 | <i>Real</i> | | - | |
| 70.49 | Override log 1 warning 3 | <i>Real</i> | | - | |
| 70.50 | Override log 2 start date | <i>Real</i> | | - | |
| 70.51 | Override log 2 start time | <i>Real</i> | | - | |
| 70.52 | Override log 2 end date | <i>Real</i> | | - | |
| 70.53 | Override log 2 end time | <i>Real</i> | | - | |
| 70.54 | Override log 2 fault 1 | <i>Real</i> | | - | |
| 70.55 | Override log 2 fault 2 | <i>Real</i> | | - | |
| 70.56 | Override log 2 fault 3 | <i>Real</i> | | - | |
| 70.57 | Override log 2 warning 1 | <i>Real</i> | | - | |
| 70.58 | Override log 2 warning 2 | <i>Real</i> | | - | |
| 70.59 | Override log 2 warning 3 | <i>Real</i> | | - | |
| 70.60 | Override log 3 start date | <i>Real</i> | | - | |
| 70.61 | Override log 3 start time | <i>Real</i> | | - | |
| 70.62 | Override log 3 end date | <i>Real</i> | | - | |
| 70.63 | Override log 3 end time | <i>Real</i> | | - | |
| 70.64 | Override log 3 fault 1 | <i>Real</i> | | - | |
| 70.65 | Override log 3 fault 2 | <i>Real</i> | | - | |
| 70.66 | Override log 3 fault 3 | <i>Real</i> | | - | |
| 70.67 | Override log 3 warning 1 | <i>Real</i> | | - | |
| 70.68 | Override log 3 warning 2 | <i>Real</i> | | - | |
| 70.69 | Override log 3 warning 3 | <i>Real</i> | | - | |
| 71 External PID1 | | | | | |
| 71.01 | External PID act value | <i>Real</i> | -200000.00...200000.00 | % | 100 = 1 PID customer unit |
| 71.02 | Feedback act value | <i>Real</i> | -200000.00...200000.00 | PID customer units | 100 = 1 PID customer unit |
| 71.03 | Setpoint act value | <i>Real</i> | -200000.00...200000.00 | PID customer units | 100 = 1 PID customer unit |
| 71.04 | Deviation act value | <i>Real</i> | -200000.00...200000.00 | PID customer units | 100 = 1 PID customer unit |
| 71.06 | PID status word | <i>PB</i> | 0000h...FFFFh | - | 1 = 1 |
| 71.07 | PID operation mode | <i>List</i> | 0...2 | - | 1 = 1 |
| 71.08 | Feedback 1 source | <i>Analog src</i> | - | - | 1 = 1 |
| 71.11 | Feedback filter time | <i>Real</i> | 0.000...30.000 | s | 1000 = 1 s |

| Serial number | Name | type | Range | Unit | FbEq32 |
|-----------------------------|--------------------------|-------------------|------------------------|--------------------|----------------------------|
| 71.14 | Setpoint scaling | <i>Real</i> | -200000.00...200000.00 | - | 100 = 1 |
| 71.15 | Output scaling | <i>Real</i> | -200000.00...200000.00 | - | 100 = 1 |
| 71.16 | Setpoint 1 source | <i>Analog src</i> | - | - | 1 = 1 |
| 71.19 | Internal setpoint sel1 | <i>Binary src</i> | - | - | 1 = 1 |
| 71.20 | Internal setpoint sel2 | <i>Binary src</i> | - | - | 1 = 1 |
| 71.21 | Internal setpoint 1 | <i>Real</i> | -200000.00...200000.00 | PID customer units | 100 = 1 PID customer unit |
| 71.22 | Internal setpoint 2 | <i>Real</i> | -200000.00...200000.00 | PID customer units | 100 = 1 PID customer unit |
| 71.23 | Internal setpoint 3 | <i>Real</i> | -200000.00...200000.00 | PID customer units | 100 = 1 PID customer unit |
| 71.26 | Setpoint min | <i>Real</i> | -200000.00...200000.00 | PID customer units | 100 = 1 PID customer units |
| 71.27 | Setpoint max | <i>Real</i> | -200000.00...200000.00 | PID customer units | 100 = 1 PID customer units |
| 71.31 | Deviation inversion | <i>Binary src</i> | - | - | 1 = 1 |
| 71.32 | Gain | <i>Real</i> | 0.01...100.00 | - | 100 = 1 |
| 71.33 | Integration time | <i>Real</i> | 0.0...9999.0 | s | 10 = 1 s |
| 71.34 | Derivation time | <i>Real</i> | 0.000...10.000 | s | 1000 = 1 s |
| 71.35 | Derivation filter time | <i>Real</i> | 0.0...10.0 | s | 1000 = 1 s |
| 71.36 | Output min | <i>Real</i> | -200000.00...200000.00 | - | 10 = 1 |
| 71.37 | Output max | <i>Real</i> | -200000.00...200000.00 | - | 10 = 1 |
| 71.38 | Output freeze enable | <i>Binary src</i> | - | - | 1 = 1 |
| 71.39 | Deadband range | <i>Real</i> | 0.0...200000.0 | PID customer units | 10 = 1 PID customer unit |
| 71.40 | Deadband delay | <i>Real</i> | 0.0...3600.0 | s | 1000 = 1 s |
| 71.58 | Increase prevention | <i>Binary src</i> | - | - | 1 = 1 |
| 71.59 | Decrease prevention | <i>Binary src</i> | - | - | 1 = 1 |
| 71.62 | Internal setpoint actual | <i>Real</i> | -200000.00...200000.00 | PID customer units | 100 = 1 PID customer unit |
| 71.79 | External PID units | <i>List</i> | - | - | 1 = 1 |
| 76 PFC configuration | | | | | |
| 76.01 | PFC working status | <i>PB</i> | 0000h...FFFFh | - | 1 = 1 |
| 76.02 | PFC working description | <i>PB</i> | 08...801 | - | 1 = 1 |
| 76.11 | Pump/fan status 1 | <i>PB</i> | 0000h...FFFFh | - | 1 = 1 |
| 76.12 | Pump/fan status 2 | <i>PB</i> | 0000h...FFFFh | - | 1 = 1 |
| 76.13 | Pump/fan status 3 | <i>PB</i> | 0000h...FFFFh | - | 1 = 1 |

| Serial number | Name | type | Range | Unit | FbEq32 |
|------------------------------------------|-----------------------------|-------------------|--------------------|--------------|------------|
| 76.14 | Pump/fan status 4 | <i>PB</i> | 0000h...FFFFh | - | 1 = 1 |
| 76.15 | Pump status 5 | <i>PB</i> | 0000h...FFFFh | - | 1 = 1 |
| 76.16 | Pump status 6 | <i>PB</i> | 0000h...FFFFh | - | 1 = 1 |
| 76.21 | PFC Configuration | <i>List</i> | 0...3 | - | 1 = 1 |
| 76.25 | Number of motors | <i>Real</i> | 1...4 | - | 1 = 1 |
| 76.26 | Minimum number of motors | <i>Real</i> | 0...4 | - | 1 = 1 |
| 76.27 | Maximum number of motors | <i>Real</i> | 1...4 | - | 1 = 1 |
| 76.30 | Start point 1 | <i>Real</i> | 0...32767 | rpm/Hz | 1 = 1 unit |
| 76.31 | Start point 2 | <i>Real</i> | 0...32767 | rpm/Hz | 1 = 1 unit |
| 76.32 | Start point 3 | <i>Real</i> | 0...32767 | rpm/Hz | 1 = 1 unit |
| 76.33 | Start point 4 | <i>Real</i> | 0.00...32767.00 | rpm/Hz/ m | 1 = 1 unit |
| 76.34 | Start point 5 | <i>Real</i> | 0.00...32767.00 | rpm/Hz/ m | 1 = 1 unit |
| 76.41 | Stop point 1 | <i>Real</i> | 0...32767 | rpm/Hz | 1 = 1 unit |
| 76.42 | Stop point 2 | <i>Real</i> | 0...32767 | rpm/Hz | 1 = 1 unit |
| 76.43 | Stop point 3 | <i>Real</i> | 0...32767 | rpm/Hz | 1 = 1 unit |
| 76.44 | Stop point 4 | <i>Real</i> | 0...32767 | rpm/Hz | 1 = 1 unit |
| 76.45 | Stop point 5 | <i>Real</i> | 0...32767 | rpm/Hz | 1 = 1 unit |
| 76.55 | Start delay | <i>Real</i> | 0.00...12600.00 | s | 100 = 1 s |
| 76.56 | Stop delay | <i>Real</i> | 0.00...12600.00 | s | 100 = 1 s |
| 76.57 | Speed keeping | <i>Real</i> | 0.00...1000.00 | s | 100 = 1 s |
| 76.58 | Speed delay | <i>Real</i> | 0.00...1000.00 | s | 100 = 1 s |
| 76.59 | PFC contactor delay | <i>Real</i> | 0.20...600.00 | s | 100 = 1 s |
| 76.60 | PFC ramp up time | <i>Real</i> | 0.00...1800.00 | s | 100 = 1 s |
| 76.61 | PFC ramp down time | <i>Real</i> | 0.00...1800.00 | s | 100 = 1 s |
| 76.70 | Autochange | <i>List</i> | 0...13 | - | 1 = 1 |
| 76.71 | Autochange interval | <i>Real</i> | 0.00...42949672.95 | h | 100 = 1 h |
| 76.72 | Maximum disequilibrium time | <i>Real</i> | 0.00...1000000.00 | h | 100 = 1 h |
| 76.73 | Autochange scope | <i>Real</i> | 0.0...300.0 | % | 10 = 1% |
| 76.74 | Autochange auxiliary PFC | <i>List</i> | 0...1 | - | 1 = 1 |
| 76.81 | PFC 1 interlock | <i>List</i> | - | - | 1 = 1 |
| 76.82 | PFC 2 interlock | <i>List</i> | - | - | 1 = 1 |
| 76.83 | PFC 3 interlock | <i>List</i> | - | - | 1 = 1 |
| 76.84 | PFC 4 interlock | <i>List</i> | - | - | 1 = 1 |
| 76.85 | PFC 5 interlock | <i>Binary src</i> | - | - | 1 = 1 |
| 76.86 | PFC 6 interlock | <i>Binary src</i> | - | - | 1 = 1 |
| 76.95 | Regulator bypass control | <i>List</i> | - | - | 1 = 1 |
| 77 PFC maintenance and monitoring | | | | | |
| 77.10 | PFC run time change | <i>List</i> | 0...5 | - | 1 = 1 |
| 77.11 | Pump/fan 1 run time | <i>Real</i> | 0.00...42949672.95 | h | 100 = 1 h |

| Serial number | Name | type | Range | Unit | FbEq32 |
|----------------------------|------------------------------|-------------------|--------------------|------|-----------|
| 77.12 | Pump/fan 2 run time | <i>Real</i> | 0.00...42949672.95 | h | 100 = 1 h |
| 77.13 | Pump/fan 3 run time | <i>Real</i> | 0.00...42949672.95 | h | 100 = 1 h |
| 77.14 | Pump/fan 4 run time | <i>Real</i> | 0.00...42949672.95 | h | 100 = 1 h |
| 77.15 | Pump 5 running time | <i>Real</i> | 0.00...42949672.95 | h | 100 = 1 h |
| 77.16 | Pump 6 running time | <i>Real</i> | 0.00...42949672.95 | h | 100 = 1 h |
| 95 HW configuration | | | | | |
| 95.01 | Supply volt | <i>List</i> | 0...5 | - | 1 = 1 |
| 95.02 | Adaptive voltage limits | <i>List</i> | 0...1 | - | 1 = 1 |
| 95.03 | Estimated AC supply voltage | | 0.0...1000.0 | - | 1 = 1 V |
| 95.04 | Control board supply | <i>List</i> | 0...1 | - | 1 = 1 |
| 95.15 | Special HW settings | | 0000h...FFFFh | | |
| 95.20 | HW options word 1 | <i>PB</i> | 0000h...FFFFh | - | 1 = 1 |
| 95.26 | Motor disconnect detection | <i>List</i> | 0...1 | - | 1 = 1 |
| 95.200 | Cooling fan mode | <i>List</i> | 0...1 | - | 1 = 1 |
| 96 System | | | | | |
| 96.01 | Language | <i>List</i> | 0...2052 | - | 1 = 1 |
| 96.02 | Passcode | <i>Data</i> | - | - | 1 = 1 |
| 96.03 | Access level status | <i>PB</i> | 0b0000...111b | - | 1 = 1 |
| 96.04 | Macro select | <i>List</i> | 0...32 | - | 1 = 1 |
| 96.05 | Macro active | <i>List</i> | 1...32 | - | 1 = 1 |
| 96.06 | Parameter restore | <i>List</i> | 0...34560 | - | 1 = 1 |
| 96.07 | Parameter save manually | <i>List</i> | 0...1 | - | 1 = 1 |
| 96.08 | Control board boot | <i>Real</i> | 0...1 | - | 1 = 1 |
| 96.10 | User macro status | <i>List</i> | 0...11 | - | - |
| 96.11 | User macro save/load | <i>List</i> | 0...5, 18...21 | - | - |
| 96.12 | User macro I/O mode input 1 | <i>Binary src</i> | - | - | - |
| 96.13 | User macro I/O mode input 2 | <i>Binary src</i> | - | - | - |
| 96.16 | unit selection | <i>PB</i> | 000h...FFFFh | | 1 = 1 |
| 96.51 | Clear fault and event logger | <i>Real</i> | 0...1 | - | 1 = 1 |
| 96.20 | Time sync primary source | <i>List</i> | 3, 6, 8, 9 | - | 1 = 1 |
| 96.24 | Full days since 1st Jan 1980 | <i>List</i> | 1...59999 | d | 1 = 1 |
| 96.25 | Time in minutes within 24 h | <i>List</i> | 1...1439 | min | 1 = 1 |
| 96.26 | Time in ms within one minute | <i>List</i> | 0...59999 | ms | 1 = 1 |
| 96.54 | Checksum action | <i>Binary src</i> | - | - | 1 = 1 |
| 96.55 | Checksum control word | <i>Binary src</i> | - | - | |
| 96.68 | Actual checksumA | <i>Binary src</i> | - | - | 1 = 1 |
| 96.69 | Actual checksumB | <i>Binary src</i> | - | - | 1 = 1 |
| 96.71 | Approved checksum A | <i>Binary src</i> | - | - | 1 = 1 |
| 96.72 | Approved checksum B | <i>Binary src</i> | - | - | 1 = 1 |
| 96.78 | 550 compatibility mode | <i>List</i> | 0...1 | - | 1 = 1 |

| Serial number | Name | type | Range | Unit | FbEq32 |
|---------------------------------------------------------------------------------|-------------------------------|-------------|------------------------------------------------------------|--------------|---------------|
| 96.79 | Legacy control profile | <i>List</i> | 0...3 | - | 1 = 1 |
| <i>(The parameter 96.100...96.102 is visible only when the parameter 96.02)</i> | | | | | |
| 96.100 | change user password | <i>Real</i> | 10000000...99999999 | - | 1 = 1 |
| 96.101 | Confirm user password | <i>Real</i> | 10000000...99999999 | - | 1 = 1 |
| 96.102 | user lock function | <i>PB</i> | 0000h...FFFFh | - | 1 = 1 |
| 97 Motor control | | | | | |
| 97.01 | Switching frequency reference | <i>List</i> | 4...12 | kHz | 1 = 1 |
| 97.02 | Minimum switching frequency | <i>List</i> | 1...12 | kHz | 1 = 1 |
| 97.04 | Voltage reserve | <i>Real</i> | -4...50 | % | 1 = 1% |
| 97.13 | IR compensation | <i>Real</i> | 0.00...50.00 | % | 100 = 1% |
| 97.20 | U/F ratio | <i>List</i> | 0...1 | - | 1 = 1 |
| 97.48 | Udc stabilizer | <i>List</i> | 0, 50, 100, 300, 500, 800 | - | 1 = 1 |
| 97.49 | Slip gain for scalar | <i>Real</i> | 0...200 | % | 1 = 1% |
| 97.94 | IR comp max frequency | <i>Real</i> | 1.0...200.0 | % | 10 = 1% |
| 97.135 | Udc ripple | <i>Real</i> | 0.0...200.0 | V | 10 = 1V |
| 99 Motor data | | | | | |
| 99.04 | Motor control mode | <i>List</i> | 0...1 | - | 1 = 1 |
| 99.06 | Motor nominal current | <i>Real</i> | 0.0...6400.0 | A | 10 = 1 A |
| 99.07 | Motor nominal voltage | <i>Real</i> | 0.0...800.0 | V | 10 = 1 V |
| 99.08 | Motor nominal frequency | <i>Real</i> | 0.0...500.0 | Hz | 10 = 1 Hz |
| 99.09 | Motor nominal speed | <i>Real</i> | 0...30000 | rpm | 1 = 1 rpm |
| 99.10 | Motor nominal power | <i>Real</i> | -10000.00...10000.00 kW or -13405.83 ... 13405.83 hp | kW or hp | 100 = 1 unit |
| 99.11 | Motor nominal power factor | <i>Real</i> | 0.00...1.00 | - | 100 = 1 |
| 99.12 | Motor nominal torque | <i>Real</i> | 0.000...4000000.000 N·m or 0.000...2950248.597 lb-ft | N·m or lb-ft | 1000 = 1 unit |
| 99.15 | Motor pole-pairs calculated | <i>Real</i> | 0...1000 | - | 1 = 1 |
| 99.16 | Motor phase order | <i>List</i> | 0...1 | - | 1 = 1 |



Parameter

What this chapter contains

The chapter describes the parameters, including actual signals of the control program.

Terms and abbreviations

| Terms | Definition |
|---------------|---------------------------------------------------------------------------------------------------------------------------------------------------------------------------------------------------------------------------------------------------------------------------------------------------------------------------------------------------------------------------------------------------------------------------------------------------------------------|
| Actual signal | Type of <i>parameter</i> that is the result of a measurement or calculation by the drive or contains status information. Most actual signals are read only, but some (especially counter-type actual signals) can be reset. |
| Def | (In the following table, shown on the same row as the parameter name) Default value of a <i>parameter</i> when used in the Factory macro. For information on other macro-specific parameter values, See chapter <i>Application macros</i> (page 29). |
| FbEq16 | (In the following table, shown on the same row as the parameter range, or for each selection) 16-bit fieldbus equivalence: The scaling between the value shown on the panel and the integer used in communication when a 16-bit value is selected for transmission to an external system. A dash (-) indicates that the parameter is not accessible in 16-bit format. The corresponding 32-bit scaling are listed in chapter <i>Parameter data</i> (page 97). |
| Other | The value comes from another parameter. Choosing "Other" displays a parameter list in which the user can specify the source parameter. |
| Other [bit] | The value is taken from a specific bit in another parameter. The signal sources are selected by parameters list. |
| Parameter | Either a user-adjustable operating instruction for the drive or <i>actual signal</i> . |
| p.u. | Per unit |

Summary of parameter groups

| Groups | Contents | Page |
|------------------------------------------------|---------------------------------------------------------------------------------------------------------------------------------------------|------|
| 01 Actual values | Basic signals for monitoring the drive. | 133 |
| 03 Input references | Values of references received from various sources. | 136 |
| 04 Warnings and faults | Information on warnings and faults that occurred last. | 136 |
| 05 Diagnostics | Drive maintenance related type counter and measured value for operation | 138 |
| 06 Control and status words | Converter control and status words. | 141 |
| 07 System info | Drive hardware and firmware information. | 144 |
| 10 Standard DI,RO | Configuration of digital inputs and relay outputs. | 146 |
| 11 Standard DIO, FI, FO | Configuration of the frequency input. | 150 |
| 12 Standard AI | Configuration of standard analog inputs. | 151 |
| 13 Standard AO | Configuration of standard analog outputs. | 156 |
| 15 I/O extension module | Configuration of the I/O extension module installed in slot 2. | 163 |
| 19 Operation mode | Selection of local and external control location sources and operating modes. | 171 |
| 20 Start/stop/direction | Start/stop/direction and run/start/jog enable signal source selection; positive/negative reference enable signal source selection. | 171 |
| 21 Start/stop mode | Start and stop modes; emergency stop mode and signal source selection; DC magnetization settings. | 181 |
| 22 Speed reference selection | Motor potentiometer settings. | 187 |
| 23 Speed reference ramp | Speed reference ramp settings (programming of the acceleration and deceleration rates for the drive). | 188 |
| 28 Frequency reference chain | See the control chain diagrams on pages | 189 |
| 30 Limits | Drive operation limit. | 199 |
| 31 Fault functions | Configuration of external events; selection of behavior of the drive upon fault situations. | 204 |
| 32 Supervision | Configuration of signal supervision functions 1...3. | 211 |
| 34 Timed functions | Configuration of the timed functions. | 218 |
| 35 Motor thermal protection | Motor thermal protection settings such as temperature measurement configuration, load curve definition and motor fan control configuration. | 224 |
| 36 Load analyzer | Peak value and amplitude logger settings. | 234 |
| 37 User load curve | Settings for user load curve. | 237 |
| 40 Process PID set 1 | Parameter values for process PID control. | 240 |
| 41 Process PID set 2 | A second set of parameter values for process PID control. | 255 |
| 43 Brake chopper | Settings for the internal brake chopper. | 257 |
| 44 Mechanical brake control | Configuration of mechanical brake control. | 259 |
| 45 Energy efficiency | Settings for the energy saving calculators. | 261 |
| 46 Monitoring/scaling settings | Speed supervision settings; actual signal filtering; general scaling settings. | 265 |
| 47 Data storage | Data storage parameters that can be written to and read from using other parameters' source and target settings. | 267 |
| 49 Panel port communication | Communication settings for the control panel port on the drive. | 268 |

| Groups | Contents | Page |
|---------------------------------------------------|---------------------------------------------------------------------------------------------------------------------------------------------|---------------------|
| 50 Fieldbus adapter (FBA) | Fieldbus communication configuration. | 269 |
| 51 FBA A settings | Fieldbus adapter A configuration | 273 |
| 52 FBA A data in | Selection of data to be transferred from converter to fieldbus controller through fieldbus adapter A. | 274 |
| 53 FBA A data out | Selection of data to be transferred from fieldbus controller to drive through fieldbus adapter A | 275 |
| 58 Embedded fieldbus | Configuration of the embedded fieldbus (EFB) interface. | 275 |
| 70 Override | Enabling/disabling of the Override function, Override activation signal and Override speed/frequency. | 282 |
| 71 External PID1 | Configuration of external PID. | 285 |
| 76 PFC configuration | PFC (pump and fan control) and automatic drive configuration parameter. | 288 |
| 77 PFC maintenance and monitoring | PFC (Pump and fan control) maintenance and monitoring parameters. | 294 |
| 95 HW configuration | Related settings of hardware. | 295 |
| 96 System | Language selection; access levels; macro selection; parameter save and restore; control device reboot; user parameter sets; unit selection. | 297 |
| 97 Motor control | Switching frequency; slip compensation; anti-clogging (signal injection); IR compensation. | 307 |
| 99 Motor data | Motor configuration settings. | 309 |

Parameter list

| Serial number | Name/Value | Description | Def/FbEq16 |
|-------------------------|-------------------------------------------|--------------------------------------------------------------------------------------------------------------------------------------------------------------------------------------------------------------------------------------------------------------------------------------------------------------------------------------------------------------------------------------------------------------------------------------------------------------------------------------------------------------------------------|-------------------------------------|
| 01 Actual values | | Basic signals for monitoring the drive. All parameters in this group are read-only unless otherwise noted. Note: Values of these actual signals are filtered with the filter time defined in group 46 Monitoring/scaling settings . The selection lists for parameters in other groups mean the raw value of the actual signal instead. For example, if a selection is output frequency, it does not point to the value of parameter 01.06 Output frequency but to the raw value. | |
| 01.01 | Motor speed | Motor estimated speed. A filter time constant for this signal can be defined by parameter 46.11 Motor speed filter time . | - |
| | -30000.00... 30000.00 rpm | Motor estimated speed. | See parameter 46.01 |
| 01.03 | Motor speed (%) | Motor speed in percent of the nominal motor speed. | - |
| | -1000.00... 1000.00% | Motor speed. | See parameter 46.01 |
| 01.06 | Output frequency | Estimated drive output frequency in Hz. A filter time constant for this signal can be defined by parameter 46.12 Filter time output frequency . | - |
| | -500.00...500.00 Hz | Estimated output frequency. | See parameter 46.02 |
| 01.07 | Motor current | Measured (absolute) motor current in A. | - |
| | 0.00...30,000.00 A | Motor current. | 1 = 1 A |
| 01.08 | Motor nominal current (%) | Motor current (drive output current) percent of motor nominal current. | - |
| | 0.0...1000.0% | Motor current. | 1 = 1% |
| 01.09 | Drive nominal current (%) | Motor current (drive output current) percent of drive nominal current. | - |
| | 0.0...1000.0% | Motor current. | 1 = 1% |
| 01.10 | Motor torque (%) | Motor torque in percent of the nominal motor torque. See also parameter 01.30 Nominal torque scale . A filter time constant for this signal can be defined by parameter 46.13 Filter time motor torque . | - |
| | -1600.0...1600.0% | Motor torque. | See parameter 46.03 |
| 01.11 | DC voltage | Measured DC link voltage. | - |
| | 0.00...2,000.00 V | DC circuit voltage. | 10 = 1 V |
| 01.13 | Output voltage | Calculated motor voltage in V AC. | - |
| | 0...2,000 V | Motor voltage. | 1 = 1 V |
| 01.14 | Output frequency | Drive output power. The unit is selected with parameter 96.16 unit selection A filter time constant for this signal can be defined by parameter 46.14 Filter time power out . | - |
| | -32768.00... 32767.00 kW or hp | Output power. | 1 = 1 unit |

134 Parameter

| Serial number | Name/Value | Description | Def/FbEq16 |
|---------------|---------------------------------------------|-----------------------------------------------------------------------------------------------------------------------------------------------------------------------------------------------------------------------------------------------------------------------------------------------------------|--------------|
| 01.15 | <i>Nominal output power (%) of motor</i> | Output power in percent of the nominal motor power. | - |
| | -300.00... 300.00% | Output power. | 1 = 1% |
| 01.17 | <i>Motor shaft power</i> | Estimated mechanical power at motor shaft. | - |
| | -32768.00... 32767.00 kW or hp | Motor shaft power. | 1 = 1 unit |
| 01.18 | <i>Inverter GWh counter</i> | Amount of energy that has passed through the drive (in either direction) in full gigawatt-hours. The minimum value is zero. | - |
| | 0...65535 GWh | Energy in GWh. | 1 = 1 GWh |
| 01.19 | <i>Inverter MWh counter</i> | Amount of energy that has passed through the drive (in either direction) in full gigawatt-hours. Whenever the counter rolls over, <i>01.18 Inverter GWh counter</i> is incremented. The minimum value is zero. | - |
| | 0...999 MWh | Energy in MWh. | 1 = 1 MWh |
| 01.20 | <i>Inverter kWh counter</i> | Amount of energy that has passed through the drive (in either direction) in full gigawatt-hours. Whenever the counter rolls over, <i>01.19 Inverter MWh counter</i> is incremented. The minimum value is zero. | - |
| | 0...999 kWh | Energy in kWh. | 10 = 1 kWh |
| 01.24 | <i>Actual flux (%)</i> | Used flux reference in percent of nominal flux of motor. | - |
| | 0...200% | Flux reference. | 1 = 1% |
| 01.30 | <i>Nominal torque scale</i> | Torque that corresponds to 100% of nominal motor torque. The unit is selected with parameter <i>96.16 unit selection</i> . Note: Note: if needs to be entered, this value is copied from parameter <i>99.12 Motor nominal torque</i> . Otherwise the value is calculated from other motor data. | - |
| | 0.000... N-m or lb-ft | Nominal torque. | 1 = 100 unit |
| 01.50 | <i>Current hour energy consumption</i> | Current hour energy consumption. The value is stored here when its values has been cumulated for 60 minutes. The value is set to the value before the power cycle when the drive is again up and running. | - |
| | - 21474836.48...214 74836.47 kWh | Energy. | 1 = 1 kWh |
| 01.51 | <i>Previous one hour energy consumption</i> | Previous hour energy consumption. The value <i>01.50 Current hour energy consumption</i> is stored here when its values has been cumulated for 60 minutes. The value is set to the value before the power cycle when the drive is again up and running. | - |
| | - 21474836.48...214 74836.47 kWh | Energy. | 1 = 1 kWh |
| 01.52 | <i>Today's energy consumption</i> | Current day energy consumption. The value is stored here when its values has been cumulated for 24 minutes. The value is set to the value before the power cycle when the drive is again up and running. | - |
| | - 21474836.48...214 74836.47 kWh | Energy. | 1 = 1 kWh |

| Serial number | Name/Value | Description | Def/FbEq16 |
|---------------|------------------------------------------------|--------------------------------------------------------------------------------------------------------------------------------------------------------------------------------------------------------------------------------------------------------------------------------------------------------------------------------------------------------------------------------|------------|
| 01.53 | <i>Yesterday's energy consumption</i> | Previous daily energy consumption. The value <i>01.52 Today's energy consumption</i> is stored here when its values has been cumulated for 24 minutes. The value is set to the value before the power cycle when the drive is again up and running. | - |
| | - 21474836.48...214 74836.47 kWh | Energy. | 1 = 1 kWh |
| 01.54 | <i>Cumulative inverter energy</i> | Amount of energy that has passed through the drive (in either direction) in full kilowatt-hours. The minimum value is zero. | - |
| | -200000000.0... 200000000.0 kWh | Energy in kWh. | 10 = 1 kWh |
| 01.55 | <i>Inverter GWh counter (resettable)</i> | Amount of energy that has passed through the drive (in either direction) in full gigawatt-hours. The minimum value is zero. Can be reset from the control panel by keeping Reset down for over 3 seconds. Resetting any of parameters <i>01.55...01.58</i> resets all of them. | - |
| | 0...65535 GWh | Energy in GWh. | 1 = 1 GWh |
| 01.56 | <i>Inverter MWh counter (resettable)</i> | Amount of energy that has passed through the drive (in either direction) in full megawatt-hours. Whenever the counter rolls over, <i>01.55 Inverter GWh counter (resettable)</i> is incremented. The minimum value is zero. Can be reset from the control panel by keeping Reset down for over 3 seconds. Resetting any of parameters <i>01.55...01.58</i> resets all of them. | - |
| | 0...1000 MWh | Energy in MWh. | 1 = 1 MWh |
| 01.57 | <i>Inverter kWh counter (resettable)</i> | Amount of energy that has passed through the drive (in either direction) in full kilowatt-hours. Whenever the counter rolls over, <i>01.56 Inverter MWh counter (resettable)</i> is incremented. The minimum value is zero. Can be reset from the control panel by keeping Reset down for over 3 seconds. Resetting any of parameters <i>01.55...01.58</i> resets all of them. | - |
| | 0...1000 kWh | Energy in kWh. | 10 = 1 kWh |
| 01.58 | <i>Cumulative inverter energy (resettable)</i> | Amount of energy that has passed through the drive (in either direction) in full kilowatt-hours. The minimum value is zero. Can be reset from the control panel by keeping Reset down for over 3 seconds. Resetting any of parameters <i>01.55...01.58</i> resets all of them. | - |
| | -200000000.0... 200000000.0 kWh | Energy in kWh. | 10 = 1 kWh |
| 01.61 | <i>Absolute value of motor speed</i> | Absolute value of parameter <i>01.01 Motor speed</i> . | - |
| | 0.00... 30000.00 rpm | | 1 = 1 rpm |
| 01.62 | <i>Absolute value of motor speed (%)</i> | Absolute value of parameter <i>01.03 Motor speed (%)</i> . | - |
| | 0.00... 1000.00% | | 1 = 1% |
| 01.63 | <i>Abs output frequency</i> | Absolute value of parameter <i>01.06 Output frequency</i> . | - |
| | 0.00...500.00 Hz | | 1 = 1 Hz |

| Serial number | Name/Value | Description | Def/FbEq16 |
|-------------------------------|------------------------------------------------------------|----------------------------------------------------------------------------------------------------------------------------------------------------------------------------------------------------------------------|------------|
| 01.64 | <i>Abs motor torque</i> | Absolute value of parameter <i>01.10 Motor torque (%)</i> . | - |
| | 0.0...1600.0% | | 1 = 1% |
| 01.65 | <i>Abs output power</i> | Absolute value of parameter <i>01.14 Output frequency</i> . | - |
| | 0.00 = 32767.00 kW or hp | | 1 = 1 kW |
| 01.66 | <i>Absolute value of nominal output power (%) of motor</i> | Absolute value of parameter <i>01.15 Nominal output power (%) of motor</i> . | - |
| | 0.00... 300.00% | | 1 = 1% |
| 01.68 | <i>Abs motor shaft power</i> | Absolute value of parameter <i>01.17 Motor shaft power</i> . | - |
| | 0.00 = 32767.00 kW or hp | | 1 = 1 kW |
| 03 Input references | | Values of references received from various sources. All parameters in this group are read-only unless otherwise noted. | |
| 03.01 | <i>Panel reference</i> | Reference 1 given from the control panel or PC tool. | - |
| | -100000.00...100000.00 | Control panel or PC tool reference. | 1 = 10 |
| 03.02 | <i>Panel reference 2</i> | Control panel or PC tool reference value 2. | - |
| 03.05 | <i>FB A reference 1</i> | Reference 1 received through fieldbus adapter A. See also chapter <i>Control through a fieldbus adapter</i> (page 337). | - |
| | -100000.00...100000.00 | Reference 1 from fieldbus adapter A. | 1 = 10 |
| 03.06 | <i>FB A reference 2</i> | Reference 2 received through fieldbus adapter A. | - |
| | -100000.00...100000.00 | Reference 2 from fieldbus adapter A. | 1 = 10 |
| 03.09 | <i>EFB reference 1</i> | Scaled reference 1 received through the embedded fieldbus interface. | 1 = 10 |
| | -30000.00...30000.00 | Scaled reference 1 received through the embedded fieldbus interface. | 1 = 10 |
| 03.10 | <i>EFB reference 2</i> | Scaled reference 2 received through the embedded fieldbus interface. | 1 = 10 |
| | -30000.00...30000.00 | Scaled reference 2 received through the embedded fieldbus interface. | 1 = 10 |
| 04 Warnings and faults | | Information on warnings and faults that occurred last. For explanations of individual warning and fault codes, See chapter <i>Fault tracing</i> . All parameters in this group are read-only unless otherwise noted. | |
| 04.01 | <i>Active fault</i> | Code of the 1st active fault (the fault that caused the current trip). | - |
| | 0000h...FFFFh | 1st active fault. | 1 = 1 |
| 04.02 | <i>Active fault 2</i> | Code of the 2nd active fault. | - |
| | 0000h...FFFFh | 2nd active fault. | 1 = 1 |

| Serial number | Name/Value | Description | Def/FbEq16 | | | | | | | | | | | | | | | |
|------------------------------------------------------------------------------------------------------------------------------------------------------------------------------------------------------------------------------------------------------------------------------------------------------------------------------------------------------------------------------------------------------------------------------------------------------------------------------------------------------------|--------------------------------|--------------------------------------------------------------------------------------------------------------------------------------------------------------------------------------|------------|-----|------|-------------|---|------------|--------------------------------------------------------|---|------------|--------------------------------------------------------|-----|-----|-----|----|-------------|--------------------------------------------------------|
| 04.03 | <i>Active fault 3</i> | Code of the 3rd active fault. | - | | | | | | | | | | | | | | | |
| | 0000h...FFFFh | 3rd active fault. | 1 = 1 | | | | | | | | | | | | | | | |
| 04.06 | <i>Active warning 1</i> | Code of the 1st active warning | - | | | | | | | | | | | | | | | |
| | 0000h...FFFFh | 1st active warning. | 1 = 1 | | | | | | | | | | | | | | | |
| 04.07 | <i>Active warning 2</i> | Code of the 2nd active warning. | - | | | | | | | | | | | | | | | |
| | 0000h...FFFFh | 2nd active warning. | 1 = 1 | | | | | | | | | | | | | | | |
| 04.08 | <i>Active warning 3</i> | Code of the 3rd active warning. | - | | | | | | | | | | | | | | | |
| | 0000h...FFFFh | 3rd active warning. | 1 = 1 | | | | | | | | | | | | | | | |
| 04.11 | <i>Latest fault</i> | Code of the 1st stored (non-active) warning. | - | | | | | | | | | | | | | | | |
| | 0000h...FFFFh | 1st stored warning. | 1 = 1 | | | | | | | | | | | | | | | |
| 04.12 | <i>2nd latest fault</i> | Code of the 2nd stored (non-active) warning. | - | | | | | | | | | | | | | | | |
| | 0000h...FFFFh | 2nd stored warning. | 1 = 1 | | | | | | | | | | | | | | | |
| 04.13 | <i>3rd latest fault</i> | Code of the 3rd stored (non-active) warning. | - | | | | | | | | | | | | | | | |
| | 0000h...FFFFh | 3rd stored warning. | 1 = 1 | | | | | | | | | | | | | | | |
| 04.16 | <i>Latest warning</i> | Code of the 1st stored (non-active) warning. | - | | | | | | | | | | | | | | | |
| | 0000h...FFFFh | 1st stored warning. | 1 = 1 | | | | | | | | | | | | | | | |
| 04.17 | <i>2nd latest warning</i> | Code of the 2nd stored (non-active) warning. | - | | | | | | | | | | | | | | | |
| | 0000h...FFFFh | 2nd stored warning. | 1 = 1 | | | | | | | | | | | | | | | |
| 04.18 | <i>3rd latest warning</i> | Code of the 3rd stored (non-active) warning. | - | | | | | | | | | | | | | | | |
| | 0000h...FFFFh | Third stored warning. | 1 = 1 | | | | | | | | | | | | | | | |
| 04.40 | <i>Event word 1</i> | User-defined event word. This word collects the status of the events (warnings, faults or pure events) selected by parameters <i>04.41...04.71</i> . This parameter is read-only. | - | | | | | | | | | | | | | | | |
| <table border="1"> <thead> <tr> <th>Bit</th> <th>Name</th> <th>Description</th> </tr> </thead> <tbody> <tr> <td>0</td> <td>User bit 0</td> <td>1 = Event selected by parameter <i>04.41</i> is active</td> </tr> <tr> <td>1</td> <td>User bit 1</td> <td>1 = Event selected by parameter <i>04.43</i> is active</td> </tr> <tr> <td>...</td> <td>...</td> <td>...</td> </tr> <tr> <td>15</td> <td>User bit 15</td> <td>1 = Event selected by parameter <i>04.71</i> is active</td> </tr> </tbody> </table> | | | | Bit | Name | Description | 0 | User bit 0 | 1 = Event selected by parameter <i>04.41</i> is active | 1 | User bit 1 | 1 = Event selected by parameter <i>04.43</i> is active | ... | ... | ... | 15 | User bit 15 | 1 = Event selected by parameter <i>04.71</i> is active |
| Bit | Name | Description | | | | | | | | | | | | | | | | |
| 0 | User bit 0 | 1 = Event selected by parameter <i>04.41</i> is active | | | | | | | | | | | | | | | | |
| 1 | User bit 1 | 1 = Event selected by parameter <i>04.43</i> is active | | | | | | | | | | | | | | | | |
| ... | ... | ... | | | | | | | | | | | | | | | | |
| 15 | User bit 15 | 1 = Event selected by parameter <i>04.71</i> is active | | | | | | | | | | | | | | | | |
| | 0000h...FFFFh | User-defined event word. | 1 = 1 | | | | | | | | | | | | | | | |
| 04.41 | <i>Event word 1 bit 0 code</i> | Selects the hexadecimal code of an event (warning, fault or pure event) whose status is shown as bit 0 of <i>04.40 Event word 1</i> . The event codes are listed in chapter. | 2310h | | | | | | | | | | | | | | | |
| | 0000h...FFFFh | Default fault 2310 Overcurrent. | 1 = 1 | | | | | | | | | | | | | | | |
| 04.43 | <i>Event word 1 bit 1 code</i> | Selects the hexadecimal code of an event (warning, fault or pure event) whose status is shown as bit 1 of <i>04.40 Event word 1</i> . The events are listed in chapter. | 3210h | | | | | | | | | | | | | | | |
| | 0000h...FFFFh | Default fault 3210 DC link overvoltage. | 1 = 1 | | | | | | | | | | | | | | | |
| 04.45 | Event word 1 bit 2 code | Default fault 4310 Excess temperature. | 4310h | | | | | | | | | | | | | | | |

| Serial number | Name/Value | Description | Def/FbEq16 |
|-----------------------|---------------------------------|-------------------------------------------------------------------------------------------------------------------------------------------------------------------------------------------------------------------|------------|
| 04.47 | Event word 1 bit 3 code | Default fault 2340 Short circuit. | 2340h |
| 04.49 | Event word 1 bit 4 code | No default fault | 0000h |
| 04.51 | Event word 1 bit 5 code | Default fault 3220 DC link undervoltage. | 3220h |
| 04.53 | Event word 1 bit 6 code | Default fault 80A0 AI supervision. | 80A0h |
| 04.55 | Event word 1 bit 7 code | No default fault. | 0000h |
| 04.57 | Event word 1 bit 8 code | Default fault 7122 Motor overload. | 7122h |
| 04.59 | Event word 1 bit 9 code | Default fault 7081 Control panel loss. | 7081h |
| 04.61 | Event word 1 bit 10 code | Default fault FF61 ID run. | FF61h |
| 04.63 | Event word 1 bit 11 code | Default fault 7121 Motor stall. | 7121h |
| 04.65 | Event word 1 bit 12 code | Default fault 4110 Control board temperature. | 4110h |
| 04.67 | Event word 1 bit 13 code | Default fault 9081 External fault 1. | 9081h |
| 04.69 | Event word 1 bit 14 code | Default fault 9082 External fault 2. | 9082h |
| 04.71 | <i>Event word 1 bit 15 code</i> | Selects the hexadecimal code of an event (warning, fault or pure event) whose status is shown as bit 15 of <i>04.40 Event word 1</i> . The events are listed in chapter. Default fault 2330 Earth leakage. | 2330h |
| | 0000h...FFFFh | Code of event. | 1 = 1 |
| 05 Diagnostics | | Drive maintenance related type counter and measured value for operation All parameters in this group are read-only unless otherwise noted. | |
| 05.01 | <i>On-time</i> | On-time counter. The counter runs when the drive is powered . | - |
| | 0...65535 days | On-time counter. | 1 = 1 day |
| 05.02 | <i>Runtime</i> | Motor run-time counter. The counter runs when the inverter modulates. | - |
| | 0...65535 days | Motor run-time counter. | 1 = 1 day |
| 05.03 | <i>Hours run</i> | Corresponding parameter to <i>05.02 Runtime</i> in hours, that is, $24 * 05.02$ value + fractional part of a day. | - |
| | 0.0... 429496729.5 h | Hours. | 1 = 1 h |
| 05.04 | <i>Fan run time</i> | Running time of the drive cooling fan(s). Reset from the control panel by keeping Reset down for over 3 seconds. | - |
| | 0...65535 days | Cooling fan run-time counter. | 1 = 1 day |

| Serial number | Name/Value | Description | Def/FbEq16 | | | | | | | | | | | | | | | | | | | | | | | | | | | | | | | | | | | | | | | | | | | | |
|---------------|------------------------------------------------------------------------------------------------------------------------------------------------------------------------------------------------------------------------------------------------------------------------------------------------------------------------------------------------------------------------------------------------------------------------------------------------------------------------------------------------------------------------------------------------------------------------------------------------------------------------------------------------------------------------------------------------------------------------------------------------------------------------------------------------------------------------------------------------------------------------------------------------------------------------------------------------------------------------------------------------------------------------------------------------------------------|------------------------------------------------------------------------------------------------------------------------------------------------------------------|------------|-------|---|---------------------|---|---|----------------|---|---|--------------|---|---|-------------------------|---|---|-----------------------|---|---|------------------|---|---|-------------------|---|---|--------------------|---|---|---------------------------------------|---|---|-------------------------------------|---|----|-----------------|---|----|---------------------------------|---|----|-----------------------------------|--|---------|---------|--|--|
| 05.10 | <i>Control board temperature</i> | Measured temperature of the control board | - | | | | | | | | | | | | | | | | | | | | | | | | | | | | | | | | | | | | | | | | | | | | |
| | -32768.00... 32767.00 °C or °F | Control board temperature in degrees Celsius. | 1 = unit | | | | | | | | | | | | | | | | | | | | | | | | | | | | | | | | | | | | | | | | | | | | |
| 05.11 | <i>Inverter temperature (%)</i> | Estimated drive temperature in percent of fault limit. The fault limit varies according to the type of the drive. 0.0% = 0 °C (32 °F) 100.0% = Fault limit | - | | | | | | | | | | | | | | | | | | | | | | | | | | | | | | | | | | | | | | | | | | | | |
| | -40.0...160.0% | Drive temperature in percent. | 1 = 1% | | | | | | | | | | | | | | | | | | | | | | | | | | | | | | | | | | | | | | | | | | | | |
| 05.20 | <i>Diagnostic word 1</i> | Diagnostic word 1. For possible causes and remedies, see chapter <i>Fault tracing</i> . | - | | | | | | | | | | | | | | | | | | | | | | | | | | | | | | | | | | | | | | | | | | | | |
| | <table border="1"> <thead> <tr> <th>Bit(s)</th> <th>Name</th> <th>Value</th> </tr> </thead> <tbody> <tr> <td>0</td> <td>0= warming or fault</td> <td>0</td> </tr> <tr> <td>1</td> <td>1= Any warming</td> <td>0</td> </tr> <tr> <td>2</td> <td>2= Any fault</td> <td>0</td> </tr> <tr> <td>3</td> <td>3= Over-current warming</td> <td>0</td> </tr> <tr> <td>4</td> <td>4= Over-current fault</td> <td>0</td> </tr> <tr> <td>5</td> <td>5= short circuit</td> <td>0</td> </tr> <tr> <td>6</td> <td>6= DC overvoltage</td> <td>0</td> </tr> <tr> <td>7</td> <td>7= DC undervoltage</td> <td>0</td> </tr> <tr> <td>8</td> <td>8= Equipment over-temperature warming</td> <td>0</td> </tr> <tr> <td>9</td> <td>9= Equipment over-temperature fault</td> <td>0</td> </tr> <tr> <td>10</td> <td>10= Earth fault</td> <td>0</td> </tr> <tr> <td>11</td> <td>11= Power supply phase sequence</td> <td>0</td> </tr> <tr> <td>12</td> <td>12= Power supply converter errors</td> <td></td> </tr> <tr> <td>13...15</td> <td>Reserve</td> <td></td> </tr> </tbody> </table> | Bit(s) | Name | Value | 0 | 0= warming or fault | 0 | 1 | 1= Any warming | 0 | 2 | 2= Any fault | 0 | 3 | 3= Over-current warming | 0 | 4 | 4= Over-current fault | 0 | 5 | 5= short circuit | 0 | 6 | 6= DC overvoltage | 0 | 7 | 7= DC undervoltage | 0 | 8 | 8= Equipment over-temperature warming | 0 | 9 | 9= Equipment over-temperature fault | 0 | 10 | 10= Earth fault | 0 | 11 | 11= Power supply phase sequence | 0 | 12 | 12= Power supply converter errors | | 13...15 | Reserve | | |
| Bit(s) | Name | Value | | | | | | | | | | | | | | | | | | | | | | | | | | | | | | | | | | | | | | | | | | | | | |
| 0 | 0= warming or fault | 0 | | | | | | | | | | | | | | | | | | | | | | | | | | | | | | | | | | | | | | | | | | | | | |
| 1 | 1= Any warming | 0 | | | | | | | | | | | | | | | | | | | | | | | | | | | | | | | | | | | | | | | | | | | | | |
| 2 | 2= Any fault | 0 | | | | | | | | | | | | | | | | | | | | | | | | | | | | | | | | | | | | | | | | | | | | | |
| 3 | 3= Over-current warming | 0 | | | | | | | | | | | | | | | | | | | | | | | | | | | | | | | | | | | | | | | | | | | | | |
| 4 | 4= Over-current fault | 0 | | | | | | | | | | | | | | | | | | | | | | | | | | | | | | | | | | | | | | | | | | | | | |
| 5 | 5= short circuit | 0 | | | | | | | | | | | | | | | | | | | | | | | | | | | | | | | | | | | | | | | | | | | | | |
| 6 | 6= DC overvoltage | 0 | | | | | | | | | | | | | | | | | | | | | | | | | | | | | | | | | | | | | | | | | | | | | |
| 7 | 7= DC undervoltage | 0 | | | | | | | | | | | | | | | | | | | | | | | | | | | | | | | | | | | | | | | | | | | | | |
| 8 | 8= Equipment over-temperature warming | 0 | | | | | | | | | | | | | | | | | | | | | | | | | | | | | | | | | | | | | | | | | | | | | |
| 9 | 9= Equipment over-temperature fault | 0 | | | | | | | | | | | | | | | | | | | | | | | | | | | | | | | | | | | | | | | | | | | | | |
| 10 | 10= Earth fault | 0 | | | | | | | | | | | | | | | | | | | | | | | | | | | | | | | | | | | | | | | | | | | | | |
| 11 | 11= Power supply phase sequence | 0 | | | | | | | | | | | | | | | | | | | | | | | | | | | | | | | | | | | | | | | | | | | | | |
| 12 | 12= Power supply converter errors | | | | | | | | | | | | | | | | | | | | | | | | | | | | | | | | | | | | | | | | | | | | | | |
| 13...15 | Reserve | | | | | | | | | | | | | | | | | | | | | | | | | | | | | | | | | | | | | | | | | | | | | | |
| 05.21 | <i>Diagnostic word 2</i> | Diagnostic word 2. For possible causes and remedies, see chapter <i>Fault tracing</i> . | | | | | | | | | | | | | | | | | | | | | | | | | | | | | | | | | | | | | | | | | | | | | |

| Serial number | Name/Value | Description | Def/FbEq16 | | | | | | | | | | | | | | | | | | | | | | | | | | | | | | | | | | | | | | | | | | | | | | | | | | | |
|---------------|------------------------------------------------------------------------------------------------------------------------------------------------------------------------------------------------------------------------------------------------------------------------------------------------------------------------------------------------------------------------------------------------------------------------------------------------------------------------------------------------------------------------------------------------------------------------------------------------------------------------------------------------------------------------------------------------------------------------------------------------------------------------------------------------------------------------------------------------------------------------------------------------------------------------------------------------------------------------------------------------------------------------------------------------------------------------------------------------------------------------------------------------------------------------------------------------------------------------------------------------------|---------------------------------------------------------------------------------------------------|------------|-------|---|--------------------------------|----------------------------------|---|-----------------------------------------|-----------------------------------------------|---|-----------------------------------------|-----------------------------------------------------------|---|------------------------------------------|---------------------------------------------|---|------------------------------------------|---|---|--------------------------|------------------------|---|---------------|----------------------------------------|---|--------------------|-------------------------------------|---|-------------------------|-----------------------|---|---------------------------------|--------------------------|----|----------------------------------|---|----|-------------|--------------------------------------------|---------|-----------------|---|----|---------------|---|----|-----------------------------|---|----|---|---|--|--|
| | <table border="1" data-bbox="171 220 740 762"> <thead> <tr> <th>Bit(s)</th> <th>Name</th> <th>Value</th> </tr> </thead> <tbody> <tr><td>0</td><td>0= brake chopper short-circuit</td><td>0</td></tr> <tr><td>1</td><td>1= brake chopper over-temperature alarm</td><td>0</td></tr> <tr><td>2</td><td>2= brake chopper over-temperature fault</td><td>0</td></tr> <tr><td>3</td><td>3= brake resistor over-temperature alarm</td><td>0</td></tr> <tr><td>4</td><td>4= brake resistor over-temperature fault</td><td>0</td></tr> <tr><td>5</td><td>5= brake resistor damage</td><td>0</td></tr> <tr><td>6</td><td>-</td><td>0</td></tr> <tr><td>7</td><td>7= over-speed</td><td>0</td></tr> <tr><td>8</td><td>8= motor phase sequence</td><td>0</td></tr> <tr><td>9</td><td>9= motor over-temperature alarm</td><td>0</td></tr> <tr><td>10</td><td>10= motor over-temperature fault</td><td>0</td></tr> <tr><td>11</td><td>11= load</td><td>0</td></tr> <tr><td>12</td><td>12= motor stall</td><td>0</td></tr> <tr><td>13</td><td>13= motor fan</td><td>0</td></tr> <tr><td>14</td><td>14= motor protection switch</td><td>0</td></tr> <tr><td>15</td><td>-</td><td>0</td></tr> </tbody> </table> | Bit(s) | Name | Value | 0 | 0= brake chopper short-circuit | 0 | 1 | 1= brake chopper over-temperature alarm | 0 | 2 | 2= brake chopper over-temperature fault | 0 | 3 | 3= brake resistor over-temperature alarm | 0 | 4 | 4= brake resistor over-temperature fault | 0 | 5 | 5= brake resistor damage | 0 | 6 | - | 0 | 7 | 7= over-speed | 0 | 8 | 8= motor phase sequence | 0 | 9 | 9= motor over-temperature alarm | 0 | 10 | 10= motor over-temperature fault | 0 | 11 | 11= load | 0 | 12 | 12= motor stall | 0 | 13 | 13= motor fan | 0 | 14 | 14= motor protection switch | 0 | 15 | - | 0 | | |
| Bit(s) | Name | Value | | | | | | | | | | | | | | | | | | | | | | | | | | | | | | | | | | | | | | | | | | | | | | | | | | | | |
| 0 | 0= brake chopper short-circuit | 0 | | | | | | | | | | | | | | | | | | | | | | | | | | | | | | | | | | | | | | | | | | | | | | | | | | | | |
| 1 | 1= brake chopper over-temperature alarm | 0 | | | | | | | | | | | | | | | | | | | | | | | | | | | | | | | | | | | | | | | | | | | | | | | | | | | | |
| 2 | 2= brake chopper over-temperature fault | 0 | | | | | | | | | | | | | | | | | | | | | | | | | | | | | | | | | | | | | | | | | | | | | | | | | | | | |
| 3 | 3= brake resistor over-temperature alarm | 0 | | | | | | | | | | | | | | | | | | | | | | | | | | | | | | | | | | | | | | | | | | | | | | | | | | | | |
| 4 | 4= brake resistor over-temperature fault | 0 | | | | | | | | | | | | | | | | | | | | | | | | | | | | | | | | | | | | | | | | | | | | | | | | | | | | |
| 5 | 5= brake resistor damage | 0 | | | | | | | | | | | | | | | | | | | | | | | | | | | | | | | | | | | | | | | | | | | | | | | | | | | | |
| 6 | - | 0 | | | | | | | | | | | | | | | | | | | | | | | | | | | | | | | | | | | | | | | | | | | | | | | | | | | | |
| 7 | 7= over-speed | 0 | | | | | | | | | | | | | | | | | | | | | | | | | | | | | | | | | | | | | | | | | | | | | | | | | | | | |
| 8 | 8= motor phase sequence | 0 | | | | | | | | | | | | | | | | | | | | | | | | | | | | | | | | | | | | | | | | | | | | | | | | | | | | |
| 9 | 9= motor over-temperature alarm | 0 | | | | | | | | | | | | | | | | | | | | | | | | | | | | | | | | | | | | | | | | | | | | | | | | | | | | |
| 10 | 10= motor over-temperature fault | 0 | | | | | | | | | | | | | | | | | | | | | | | | | | | | | | | | | | | | | | | | | | | | | | | | | | | | |
| 11 | 11= load | 0 | | | | | | | | | | | | | | | | | | | | | | | | | | | | | | | | | | | | | | | | | | | | | | | | | | | | |
| 12 | 12= motor stall | 0 | | | | | | | | | | | | | | | | | | | | | | | | | | | | | | | | | | | | | | | | | | | | | | | | | | | | |
| 13 | 13= motor fan | 0 | | | | | | | | | | | | | | | | | | | | | | | | | | | | | | | | | | | | | | | | | | | | | | | | | | | | |
| 14 | 14= motor protection switch | 0 | | | | | | | | | | | | | | | | | | | | | | | | | | | | | | | | | | | | | | | | | | | | | | | | | | | | |
| 15 | - | 0 | | | | | | | | | | | | | | | | | | | | | | | | | | | | | | | | | | | | | | | | | | | | | | | | | | | | |
| 05.22 | <i>Diagnostic word 3</i> | Diagnostic word 3. For possible causes and remedies, see chapter <i>Fault tracing</i> . | - | | | | | | | | | | | | | | | | | | | | | | | | | | | | | | | | | | | | | | | | | | | | | | | | | | | |
| | <table border="1" data-bbox="171 871 740 1350"> <thead> <tr> <th>Bit(s)</th> <th>Name</th> <th>Value</th> </tr> </thead> <tbody> <tr><td>0</td><td>Main circuit power connection</td><td>1= main circuit power connection</td></tr> <tr><td>1</td><td>External supply</td><td>1= external power connection of control panel</td></tr> <tr><td>2</td><td>Programmer</td><td>1= the control panel power connection by programming tool</td></tr> <tr><td>3</td><td>Loss of control panel port communication</td><td>1= loss of control panel port communication</td></tr> <tr><td>4</td><td>Reserve</td><td>-</td></tr> <tr><td>5</td><td>Fieldbus force trip</td><td>1= Fieldbus force trip</td></tr> <tr><td>6</td><td>Start inhibit</td><td>1= start inhibit, such as interlocking</td></tr> <tr><td>7</td><td>Delete safe torque</td><td>1= safe torque off (STO) activation</td></tr> <tr><td>8</td><td>STO damage</td><td>1= STO circuit damage</td></tr> <tr><td>9</td><td>kWh pulse</td><td>1 = kWh pulse is active.</td></tr> <tr><td>10</td><td>Reserve</td><td>-</td></tr> <tr><td>11</td><td>Fan command</td><td>1 = Drive fan is rotating above idle speed</td></tr> <tr><td>12...15</td><td>Reserve</td><td></td></tr> </tbody> </table> | Bit(s) | Name | Value | 0 | Main circuit power connection | 1= main circuit power connection | 1 | External supply | 1= external power connection of control panel | 2 | Programmer | 1= the control panel power connection by programming tool | 3 | Loss of control panel port communication | 1= loss of control panel port communication | 4 | Reserve | - | 5 | Fieldbus force trip | 1= Fieldbus force trip | 6 | Start inhibit | 1= start inhibit, such as interlocking | 7 | Delete safe torque | 1= safe torque off (STO) activation | 8 | STO damage | 1= STO circuit damage | 9 | kWh pulse | 1 = kWh pulse is active. | 10 | Reserve | - | 11 | Fan command | 1 = Drive fan is rotating above idle speed | 12...15 | Reserve | | | | | | | | | | | | |
| Bit(s) | Name | Value | | | | | | | | | | | | | | | | | | | | | | | | | | | | | | | | | | | | | | | | | | | | | | | | | | | | |
| 0 | Main circuit power connection | 1= main circuit power connection | | | | | | | | | | | | | | | | | | | | | | | | | | | | | | | | | | | | | | | | | | | | | | | | | | | | |
| 1 | External supply | 1= external power connection of control panel | | | | | | | | | | | | | | | | | | | | | | | | | | | | | | | | | | | | | | | | | | | | | | | | | | | | |
| 2 | Programmer | 1= the control panel power connection by programming tool | | | | | | | | | | | | | | | | | | | | | | | | | | | | | | | | | | | | | | | | | | | | | | | | | | | | |
| 3 | Loss of control panel port communication | 1= loss of control panel port communication | | | | | | | | | | | | | | | | | | | | | | | | | | | | | | | | | | | | | | | | | | | | | | | | | | | | |
| 4 | Reserve | - | | | | | | | | | | | | | | | | | | | | | | | | | | | | | | | | | | | | | | | | | | | | | | | | | | | | |
| 5 | Fieldbus force trip | 1= Fieldbus force trip | | | | | | | | | | | | | | | | | | | | | | | | | | | | | | | | | | | | | | | | | | | | | | | | | | | | |
| 6 | Start inhibit | 1= start inhibit, such as interlocking | | | | | | | | | | | | | | | | | | | | | | | | | | | | | | | | | | | | | | | | | | | | | | | | | | | | |
| 7 | Delete safe torque | 1= safe torque off (STO) activation | | | | | | | | | | | | | | | | | | | | | | | | | | | | | | | | | | | | | | | | | | | | | | | | | | | | |
| 8 | STO damage | 1= STO circuit damage | | | | | | | | | | | | | | | | | | | | | | | | | | | | | | | | | | | | | | | | | | | | | | | | | | | | |
| 9 | kWh pulse | 1 = kWh pulse is active. | | | | | | | | | | | | | | | | | | | | | | | | | | | | | | | | | | | | | | | | | | | | | | | | | | | | |
| 10 | Reserve | - | | | | | | | | | | | | | | | | | | | | | | | | | | | | | | | | | | | | | | | | | | | | | | | | | | | | |
| 11 | Fan command | 1 = Drive fan is rotating above idle speed | | | | | | | | | | | | | | | | | | | | | | | | | | | | | | | | | | | | | | | | | | | | | | | | | | | | |
| 12...15 | Reserve | | | | | | | | | | | | | | | | | | | | | | | | | | | | | | | | | | | | | | | | | | | | | | | | | | | | | |
| | 0000h...FFFFh | Diagnostic word 3. | | | | | | | | | | | | | | | | | | | | | | | | | | | | | | | | | | | | | | | | | | | | | | | | | | | | |
| 05.80 | <i>Motor speed at fault</i> | Displays the speed when fault occurred. This is applicable in both scalar and speed control mode. | - | | | | | | | | | | | | | | | | | | | | | | | | | | | | | | | | | | | | | | | | | | | | | | | | | | | |

| Serial number | Name/Value | Description | Def/FbEq16 |
|------------------------------------|--------------------------------------|------------------------------------------------------------------------------------------------------------------------------------------------------------------------------------------------------------------------------------------------------------------------------------------------------------------------------------------------------------------------------------------------------------------------------------------------|------------|
| | -30000.00... 30000.00 rpm | Estimated motor speed. | 10 = 1 rpm |
| 05.81 | <i>Output frequency at fault</i> | Shows the value of copy of parameter <i>01.06 Output frequency</i> at the occurrence of the latest fault. | - |
| | -500.00...500.00 Hz | Estimated output frequency. | |
| 05.82 | <i>DC voltage at fault</i> | Shows the value of copy of parameter <i>01.11 DC voltage</i> at the occurrence of the latest fault. | - |
| | 0.00...2000.00 V | DC link voltage. | 10 = 1 V |
| 05.83 | <i>Motor current at fault</i> | Shows the value of copy of parameter <i>01.07 Motor current</i> at the occurrence of the latest fault. | - |
| | 0.00...30000.00 A | Motor current. | 10 = 1 V |
| 05.84 | <i>Motor torque at fault</i> | Shows the value of copy of parameter <i>01.10 Motor torque (%)</i> at the occurrence of the latest fault. | - |
| | -1600.0...1600.0% | Motor torque. | 1 = 1% |
| 05.85 | <i>Main status word at fault</i> | Shows the value of copy of parameter <i>06.11 Main status word</i> at the occurrence of the latest fault. | - |
| | 0000h...FFFFh | Main status word. | 1 = 1 |
| 05.87 | <i>Inverter temperature at fault</i> | Shows the value of copy of parameter <i>05.11 Inverter temperature (%)</i> at the occurrence of the latest fault. | - |
| | -40...160 °C | Drive temperature in °C. | 1 = 1 °C |
| 05.88 | <i>Reference used at fault</i> | Shows the value of copy of parameter <i>28.01 Frequency ref ramp input</i> (in scalar control mode) or <i>23.01 Speed ref ramp input</i> (in speed control mode) at the occurrence of the latest fault. | - |
| | -30000.00... 30000.00 Hz | Frequency or speed reference. | 1 = 1 Hz |
| 06 Control and status words | | Converter control and status words. | |
| 06.01 | <i>Main control word</i> | The main control word of the drive. This parameter shows the control signals as received from the selected sources (such as digital inputs, the fieldbus interfaces and the application program). The bit assignments of the word are as described on page 321 . The related status word and state diagram are presented on pages 325 and 328 respectively. This parameter is read-only. | - |
| | 0000h...FFFFh | Main control word. | 1 = 1 |
| 06.11 | <i>Main status word</i> | Main status word of the drive. The bit assignments are described on page 325 . The related control word and state diagram are presented on pages 321 and 328 respectively. This parameter is read-only. | - |
| | 0000h...FFFFh | Main status word. | 1 = 1 |

| Serial number | Name/Value | Description | Def/FbEq16 | | | | | | | | | | | | | | | | | | | | | | | | | | | | | | | | | | | | | | | | | | | | | |
|---------------|-----------------------------------------------------------------------------------------------------------------------------------------------------------------------------------------------------------------------------------------------------------------------------------------------------------------------------------------------------------------------------------------------------------------------------------------------------------------------------------------------------------------------------------------------------------------------------------------------------------------------------------------------------------------------------------------------------------------------------------------------------------------------------------------------------------------------------------------------------------------------------------------------------------------------------------------------------------------------------------------------------------------------------------------------------------------------------------------------------------------------------------------------------------------------------------------------------------------------------------------------------------------------------------------------------------------------------------------------------------------------------------------------------------------------------------------------------------------------------------------------------------------------------------------------------------------------------------------------------------------------------|------------------------------------------------------------------------------------------------------------------------------------------------------------------------------------------------------------------|------------|--------|------|-------------|---|---------|-------------------------------------------------------------------------------------------------------------------------------------------------|---|------------|-------------------------------------------------------------------------------------------------------------------------------|---|----------------|---------------------------------|---|----------------|-----------------------------------------------|---|---------------------|----------------------------------------------|---|-----------------------|-------------------------------------------------------------------------------------------------------------------|---|---------------------|-------------------------------------------------------------------------------------------------------|---|-------------------|---------------------------------------------------------|----|----------------|------------------------------------------------------------------------------------------------------------------------------------------------------------------------------------------------------------------|---------|-----------------|------------------------------------------------------------|----|--------------------|--------------------------------------|---------|-------------|----------------------------------|----|---------|--|----|---------------|---------------------|
| 06.16 | Drive status word 1 | drive status word 1. This parameter is read-only. | | | | | | | | | | | | | | | | | | | | | | | | | | | | | | | | | | | | | | | | | | | | | | |
| | <table border="1"> <thead> <tr> <th>Bit(s)</th> <th>Name</th> <th>Description</th> </tr> </thead> <tbody> <tr> <td>0</td> <td>Enabled</td> <td>1 = run enable (See par. 20.12) and start enable (20.19) signals are present. Note: This bit is not affected by the presence of a fault.</td> </tr> <tr> <td>1</td> <td>inhibited</td> <td>1 = Start inhibited. To start the drive, the inhibiting signal (See par. 06.18), must be removed and the start signal cycled.</td> </tr> <tr> <td>2</td> <td>DC charge</td> <td>1 = DC circuit has been charged</td> </tr> <tr> <td>3</td> <td>Ready to start</td> <td>1 = drive is ready to receive a start command</td> </tr> <tr> <td>4</td> <td>Following reference</td> <td>1 = drive is ready to follow given reference</td> </tr> <tr> <td>5</td> <td>Start up</td> <td>1 = Drive has been started</td> </tr> <tr> <td>6</td> <td>Modulating</td> <td>1 = drive is modulating (output stage is being controlled)</td> </tr> <tr> <td>7</td> <td>Limit</td> <td>1 = Any operating limit (speed, torque, etc.) is active</td> </tr> <tr> <td>8</td> <td>Local control</td> <td>1 = drive is in local control</td> </tr> <tr> <td>9</td> <td>Network control</td> <td>1 = Drive is in network control (page 15).</td> </tr> <tr> <td>10</td> <td>Ext1 active</td> <td>1 = Control location EXT1 active</td> </tr> <tr> <td>11</td> <td>Ext2 active</td> <td>1 = Control location EXT1 active</td> </tr> <tr> <td>12</td> <td>Reserve</td> <td></td> </tr> <tr> <td>13</td> <td>Start request</td> <td>1 = Start requested</td> </tr> </tbody> </table> | | | Bit(s) | Name | Description | 0 | Enabled | 1 = run enable (See par. 20.12) and start enable (20.19) signals are present. Note: This bit is not affected by the presence of a fault. | 1 | inhibited | 1 = Start inhibited. To start the drive, the inhibiting signal (See par. 06.18), must be removed and the start signal cycled. | 2 | DC charge | 1 = DC circuit has been charged | 3 | Ready to start | 1 = drive is ready to receive a start command | 4 | Following reference | 1 = drive is ready to follow given reference | 5 | Start up | 1 = Drive has been started | 6 | Modulating | 1 = drive is modulating (output stage is being controlled) | 7 | Limit | 1 = Any operating limit (speed, torque, etc.) is active | 8 | Local control | 1 = drive is in local control | 9 | Network control | 1 = Drive is in network control (page 15). | 10 | Ext1 active | 1 = Control location EXT1 active | 11 | Ext2 active | 1 = Control location EXT1 active | 12 | Reserve | | 13 | Start request | 1 = Start requested |
| Bit(s) | Name | Description | | | | | | | | | | | | | | | | | | | | | | | | | | | | | | | | | | | | | | | | | | | | | | |
| 0 | Enabled | 1 = run enable (See par. 20.12) and start enable (20.19) signals are present. Note: This bit is not affected by the presence of a fault. | | | | | | | | | | | | | | | | | | | | | | | | | | | | | | | | | | | | | | | | | | | | | | |
| 1 | inhibited | 1 = Start inhibited. To start the drive, the inhibiting signal (See par. 06.18), must be removed and the start signal cycled. | | | | | | | | | | | | | | | | | | | | | | | | | | | | | | | | | | | | | | | | | | | | | | |
| 2 | DC charge | 1 = DC circuit has been charged | | | | | | | | | | | | | | | | | | | | | | | | | | | | | | | | | | | | | | | | | | | | | | |
| 3 | Ready to start | 1 = drive is ready to receive a start command | | | | | | | | | | | | | | | | | | | | | | | | | | | | | | | | | | | | | | | | | | | | | | |
| 4 | Following reference | 1 = drive is ready to follow given reference | | | | | | | | | | | | | | | | | | | | | | | | | | | | | | | | | | | | | | | | | | | | | | |
| 5 | Start up | 1 = Drive has been started | | | | | | | | | | | | | | | | | | | | | | | | | | | | | | | | | | | | | | | | | | | | | | |
| 6 | Modulating | 1 = drive is modulating (output stage is being controlled) | | | | | | | | | | | | | | | | | | | | | | | | | | | | | | | | | | | | | | | | | | | | | | |
| 7 | Limit | 1 = Any operating limit (speed, torque, etc.) is active | | | | | | | | | | | | | | | | | | | | | | | | | | | | | | | | | | | | | | | | | | | | | | |
| 8 | Local control | 1 = drive is in local control | | | | | | | | | | | | | | | | | | | | | | | | | | | | | | | | | | | | | | | | | | | | | | |
| 9 | Network control | 1 = Drive is in network control (page 15). | | | | | | | | | | | | | | | | | | | | | | | | | | | | | | | | | | | | | | | | | | | | | | |
| 10 | Ext1 active | 1 = Control location EXT1 active | | | | | | | | | | | | | | | | | | | | | | | | | | | | | | | | | | | | | | | | | | | | | | |
| 11 | Ext2 active | 1 = Control location EXT1 active | | | | | | | | | | | | | | | | | | | | | | | | | | | | | | | | | | | | | | | | | | | | | | |
| 12 | Reserve | | | | | | | | | | | | | | | | | | | | | | | | | | | | | | | | | | | | | | | | | | | | | | | |
| 13 | Start request | 1 = Start requested | | | | | | | | | | | | | | | | | | | | | | | | | | | | | | | | | | | | | | | | | | | | | | |
| | 0000h...FFFFh | Drive status word 1. | 1 = 1 | | | | | | | | | | | | | | | | | | | | | | | | | | | | | | | | | | | | | | | | | | | | | |
| 06.17 | Drive status word 2 | Drive status word 2. This parameter is read-only. | - | | | | | | | | | | | | | | | | | | | | | | | | | | | | | | | | | | | | | | | | | | | | | |
| | <table border="1"> <thead> <tr> <th>Bit(s)</th> <th>Name</th> <th>Description</th> </tr> </thead> <tbody> <tr> <td>0</td> <td>Reserve</td> <td></td> </tr> <tr> <td>1</td> <td>Magnetized</td> <td>1 = Motor has been magnetized</td> </tr> <tr> <td>2</td> <td>Torque control</td> <td>1 = Torque control mode active</td> </tr> <tr> <td>3</td> <td>Speed control</td> <td>1 = Speed control mode active</td> </tr> <tr> <td>4</td> <td>Reserve</td> <td></td> </tr> <tr> <td>5</td> <td>Safe reference active</td> <td>1 = A "safe" reference is applied by functions such as parameters 49.05 and 50.02</td> </tr> <tr> <td>6</td> <td>Mantissa activation</td> <td>1 = apply the "Mantissa" reference, through parameter 49.05 and 50.02</td> </tr> <tr> <td>7</td> <td>Loss of reference</td> <td>1 = Reference signal lost</td> </tr> <tr> <td>10</td> <td>Exceed a limit</td> <td>1 = Actual speed, frequency or torque equals or exceeds limit (defined by parameters 46.31...46.33 Valid in both directions of rotation. Valid in both directions of rotation.</td> </tr> <tr> <td>11...12</td> <td>Reserve</td> <td></td> </tr> <tr> <td>13</td> <td>Start delay active</td> <td>1 = Start delay (par. 21.22) active.</td> </tr> <tr> <td>14...15</td> <td>Reserve</td> <td></td> </tr> </tbody> </table> | | | Bit(s) | Name | Description | 0 | Reserve | | 1 | Magnetized | 1 = Motor has been magnetized | 2 | Torque control | 1 = Torque control mode active | 3 | Speed control | 1 = Speed control mode active | 4 | Reserve | | 5 | Safe reference active | 1 = A "safe" reference is applied by functions such as parameters 49.05 and 50.02 | 6 | Mantissa activation | 1 = apply the "Mantissa" reference, through parameter 49.05 and 50.02 | 7 | Loss of reference | 1 = Reference signal lost | 10 | Exceed a limit | 1 = Actual speed, frequency or torque equals or exceeds limit (defined by parameters 46.31 ... 46.33 Valid in both directions of rotation. Valid in both directions of rotation. | 11...12 | Reserve | | 13 | Start delay active | 1 = Start delay (par. 21.22) active. | 14...15 | Reserve | | | | | | | |
| Bit(s) | Name | Description | | | | | | | | | | | | | | | | | | | | | | | | | | | | | | | | | | | | | | | | | | | | | | |
| 0 | Reserve | | | | | | | | | | | | | | | | | | | | | | | | | | | | | | | | | | | | | | | | | | | | | | | |
| 1 | Magnetized | 1 = Motor has been magnetized | | | | | | | | | | | | | | | | | | | | | | | | | | | | | | | | | | | | | | | | | | | | | | |
| 2 | Torque control | 1 = Torque control mode active | | | | | | | | | | | | | | | | | | | | | | | | | | | | | | | | | | | | | | | | | | | | | | |
| 3 | Speed control | 1 = Speed control mode active | | | | | | | | | | | | | | | | | | | | | | | | | | | | | | | | | | | | | | | | | | | | | | |
| 4 | Reserve | | | | | | | | | | | | | | | | | | | | | | | | | | | | | | | | | | | | | | | | | | | | | | | |
| 5 | Safe reference active | 1 = A "safe" reference is applied by functions such as parameters 49.05 and 50.02 | | | | | | | | | | | | | | | | | | | | | | | | | | | | | | | | | | | | | | | | | | | | | | |
| 6 | Mantissa activation | 1 = apply the "Mantissa" reference, through parameter 49.05 and 50.02 | | | | | | | | | | | | | | | | | | | | | | | | | | | | | | | | | | | | | | | | | | | | | | |
| 7 | Loss of reference | 1 = Reference signal lost | | | | | | | | | | | | | | | | | | | | | | | | | | | | | | | | | | | | | | | | | | | | | | |
| 10 | Exceed a limit | 1 = Actual speed, frequency or torque equals or exceeds limit (defined by parameters 46.31 ... 46.33 Valid in both directions of rotation. Valid in both directions of rotation. | | | | | | | | | | | | | | | | | | | | | | | | | | | | | | | | | | | | | | | | | | | | | | |
| 11...12 | Reserve | | | | | | | | | | | | | | | | | | | | | | | | | | | | | | | | | | | | | | | | | | | | | | | |
| 13 | Start delay active | 1 = Start delay (par. 21.22) active. | | | | | | | | | | | | | | | | | | | | | | | | | | | | | | | | | | | | | | | | | | | | | | |
| 14...15 | Reserve | | | | | | | | | | | | | | | | | | | | | | | | | | | | | | | | | | | | | | | | | | | | | | | |
| | 0000h...FFFFh | Drive status word 2. | 1 = 1 | | | | | | | | | | | | | | | | | | | | | | | | | | | | | | | | | | | | | | | | | | | | | |

| Serial number | Name/Value | Description | Def/FbEq16 | | | | | | | | | | | | | | | | | | | | | | | | | | | | | | | | | | | | | | | | | | |
|---------------|------------------------------------------------------------------------------------------------------------------------------------------------------------------------------------------------------------------------------------------------------------------------------------------------------------------------------------------------------------------------------------------------------------------------------------------------------------------------------------------------------------------------------------------------------------------------------------------------------------------------------------------------------------------------------------------------------------------------------------------------------------------------------------------------------------------------------------------------------------------------------------------------------------------------------------------------------------------------------------------------------------------------------------------------------------------------------------------------------------------------------------------------------------------------------------------------------------------------------------------------------------------------------------------------------------------------------------------------------------------------------------------------------------------|---------------------------------------------------------------------------------------------------------------------------------------------------------------------------------------------------------------------------------------------------------------------------------------------------------------------------------------------------------------------------------------|------------|--------|------|-------------|---|----------------|-----------------------------------------------------------------------------------------------------------------|---|----------------------------|----------------------------------------------------------------------------------------|--------|-------------|----------------------------------------------------------------------------------------|-------|-------------|------------------------------|---|--------------------|----------------------------------------------------------|--------|-----------------|-------------------------------|---|---------|--|---|--------------------|-------------------------------------------|--------|---------|--|----|------------------|---------------------------------------|----|------------------|---------------------------------------|----|------------------|---------------------------------------|----|--------------------|----------------------------------------------------|
| 06.18 | <i>Start inhibit status word</i> | Start inhibit status word. This word specifies the source of the inhibiting signal that is preventing the drive from starting. The conditions marked with an asterisk (*) only require that the start command is cycled. In all other instances, the inhibiting condition must be removed first. See parameter <i>06.16 Drive status word 1</i> , bit 1. This parameter is read-only. | - | | | | | | | | | | | | | | | | | | | | | | | | | | | | | | | | | | | | | | | | | | |
| | <table border="1"> <thead> <tr> <th>Bit(s)</th> <th>Name</th> <th>Description</th> </tr> </thead> <tbody> <tr> <td>0</td> <td>Not ready run</td> <td>1 = DC Voltage is missing or drive has not been determined correctly. Check the parameters in groups 95 and 99.</td> </tr> <tr> <td>1</td> <td>Control location switching</td> <td>* 1 = Control location has changed</td> </tr> <tr> <td>2</td> <td>SSW inhibit</td> <td>1 = Control program is keeping itself in inhibited state</td> </tr> <tr> <td>3</td> <td>Fault reset</td> <td>* 1 = A fault has been reset</td> </tr> <tr> <td>4</td> <td>Lost start enable</td> <td>1 = Start enable signal missing</td> </tr> <tr> <td>5</td> <td>Lost run enable</td> <td>1 = Run enable signal missing</td> </tr> <tr> <td>6</td> <td>Reserve</td> <td></td> </tr> <tr> <td>7</td> <td>Delete safe torque</td> <td>1 = Delete safe torque function is active</td> </tr> <tr> <td>8...10</td> <td>Reserve</td> <td></td> </tr> <tr> <td>11</td> <td>Emergency stop 1</td> <td>1 = Emergency stop signal (mode off1)</td> </tr> <tr> <td>12</td> <td>Emergency stop 2</td> <td>1 = Emergency stop signal (mode off1)</td> </tr> <tr> <td>13</td> <td>Emergency stop 3</td> <td>1 = Emergency stop signal (mode off1)</td> </tr> <tr> <td>14</td> <td>Auto reset inhibit</td> <td>1 = The autoreset function is inhibiting operation</td> </tr> </tbody> </table> | | | Bit(s) | Name | Description | 0 | Not ready run | 1 = DC Voltage is missing or drive has not been determined correctly. Check the parameters in groups 95 and 99. | 1 | Control location switching | * 1 = Control location has changed | 2 | SSW inhibit | 1 = Control program is keeping itself in inhibited state | 3 | Fault reset | * 1 = A fault has been reset | 4 | Lost start enable | 1 = Start enable signal missing | 5 | Lost run enable | 1 = Run enable signal missing | 6 | Reserve | | 7 | Delete safe torque | 1 = Delete safe torque function is active | 8...10 | Reserve | | 11 | Emergency stop 1 | 1 = Emergency stop signal (mode off1) | 12 | Emergency stop 2 | 1 = Emergency stop signal (mode off1) | 13 | Emergency stop 3 | 1 = Emergency stop signal (mode off1) | 14 | Auto reset inhibit | 1 = The autoreset function is inhibiting operation |
| Bit(s) | Name | Description | | | | | | | | | | | | | | | | | | | | | | | | | | | | | | | | | | | | | | | | | | | |
| 0 | Not ready run | 1 = DC Voltage is missing or drive has not been determined correctly. Check the parameters in groups 95 and 99. | | | | | | | | | | | | | | | | | | | | | | | | | | | | | | | | | | | | | | | | | | | |
| 1 | Control location switching | * 1 = Control location has changed | | | | | | | | | | | | | | | | | | | | | | | | | | | | | | | | | | | | | | | | | | | |
| 2 | SSW inhibit | 1 = Control program is keeping itself in inhibited state | | | | | | | | | | | | | | | | | | | | | | | | | | | | | | | | | | | | | | | | | | | |
| 3 | Fault reset | * 1 = A fault has been reset | | | | | | | | | | | | | | | | | | | | | | | | | | | | | | | | | | | | | | | | | | | |
| 4 | Lost start enable | 1 = Start enable signal missing | | | | | | | | | | | | | | | | | | | | | | | | | | | | | | | | | | | | | | | | | | | |
| 5 | Lost run enable | 1 = Run enable signal missing | | | | | | | | | | | | | | | | | | | | | | | | | | | | | | | | | | | | | | | | | | | |
| 6 | Reserve | | | | | | | | | | | | | | | | | | | | | | | | | | | | | | | | | | | | | | | | | | | | |
| 7 | Delete safe torque | 1 = Delete safe torque function is active | | | | | | | | | | | | | | | | | | | | | | | | | | | | | | | | | | | | | | | | | | | |
| 8...10 | Reserve | | | | | | | | | | | | | | | | | | | | | | | | | | | | | | | | | | | | | | | | | | | | |
| 11 | Emergency stop 1 | 1 = Emergency stop signal (mode off1) | | | | | | | | | | | | | | | | | | | | | | | | | | | | | | | | | | | | | | | | | | | |
| 12 | Emergency stop 2 | 1 = Emergency stop signal (mode off1) | | | | | | | | | | | | | | | | | | | | | | | | | | | | | | | | | | | | | | | | | | | |
| 13 | Emergency stop 3 | 1 = Emergency stop signal (mode off1) | | | | | | | | | | | | | | | | | | | | | | | | | | | | | | | | | | | | | | | | | | | |
| 14 | Auto reset inhibit | 1 = The autoreset function is inhibiting operation | | | | | | | | | | | | | | | | | | | | | | | | | | | | | | | | | | | | | | | | | | | |
| | 0000h...FFFFh | Start inhibit status word. | 1 = 1 | | | | | | | | | | | | | | | | | | | | | | | | | | | | | | | | | | | | | | | | | | |
| 06.19 | <i>Speed control status word</i> | Speed control status word. This parameter is read-only. | - | | | | | | | | | | | | | | | | | | | | | | | | | | | | | | | | | | | | | | | | | | |
| | <table border="1"> <thead> <tr> <th>Bit(s)</th> <th>Name</th> <th>Description</th> </tr> </thead> <tbody> <tr> <td>0</td> <td>Zero speed</td> <td>1 = Converter is running at zero speed</td> </tr> <tr> <td>1</td> <td>Forward</td> <td>1 = Drive is running in forward direction above zero speed limit (par. <i>21.06</i>).</td> </tr> <tr> <td>2</td> <td>Reverse</td> <td>1 = Drive is running in reverse direction above zero speed limit (par. <i>21.06</i>).</td> </tr> <tr> <td>3...6</td> <td>Reserve</td> <td></td> </tr> <tr> <td>7</td> <td>Constant frequency</td> <td>1 = A constant frequency or frequency has been selected;</td> </tr> <tr> <td>8...15</td> <td>Reserve</td> <td></td> </tr> </tbody> </table> | | | Bit(s) | Name | Description | 0 | Zero speed | 1 = Converter is running at zero speed | 1 | Forward | 1 = Drive is running in forward direction above zero speed limit (par. <i>21.06</i>). | 2 | Reverse | 1 = Drive is running in reverse direction above zero speed limit (par. <i>21.06</i>). | 3...6 | Reserve | | 7 | Constant frequency | 1 = A constant frequency or frequency has been selected; | 8...15 | Reserve | | | | | | | | | | | | | | | | | | | | | | |
| Bit(s) | Name | Description | | | | | | | | | | | | | | | | | | | | | | | | | | | | | | | | | | | | | | | | | | | |
| 0 | Zero speed | 1 = Converter is running at zero speed | | | | | | | | | | | | | | | | | | | | | | | | | | | | | | | | | | | | | | | | | | | |
| 1 | Forward | 1 = Drive is running in forward direction above zero speed limit (par. <i>21.06</i>). | | | | | | | | | | | | | | | | | | | | | | | | | | | | | | | | | | | | | | | | | | | |
| 2 | Reverse | 1 = Drive is running in reverse direction above zero speed limit (par. <i>21.06</i>). | | | | | | | | | | | | | | | | | | | | | | | | | | | | | | | | | | | | | | | | | | | |
| 3...6 | Reserve | | | | | | | | | | | | | | | | | | | | | | | | | | | | | | | | | | | | | | | | | | | | |
| 7 | Constant frequency | 1 = A constant frequency or frequency has been selected; | | | | | | | | | | | | | | | | | | | | | | | | | | | | | | | | | | | | | | | | | | | |
| 8...15 | Reserve | | | | | | | | | | | | | | | | | | | | | | | | | | | | | | | | | | | | | | | | | | | | |
| | 0000h...FFFFh | Speed control status word. | 1 = 1 | | | | | | | | | | | | | | | | | | | | | | | | | | | | | | | | | | | | | | | | | | |
| 06.21 | <i>Drive status word 3</i> | Drive status word 3. This parameter is read-only. | - | | | | | | | | | | | | | | | | | | | | | | | | | | | | | | | | | | | | | | | | | | |
| | <table border="1"> <thead> <tr> <th>Bit(s)</th> <th>Name</th> <th>Description</th> </tr> </thead> <tbody> <tr> <td>0</td> <td>DC hold active</td> <td>1 = DC hold is active</td> </tr> <tr> <td>2</td> <td>Motor pre-heating active</td> <td>1 = Motor pre-heating is active</td> </tr> <tr> <td>3...15</td> <td>Reserve</td> <td></td> </tr> </tbody> </table> | | | Bit(s) | Name | Description | 0 | DC hold active | 1 = DC hold is active | 2 | Motor pre-heating active | 1 = Motor pre-heating is active | 3...15 | Reserve | | | | | | | | | | | | | | | | | | | | | | | | | | | | | | | |
| Bit(s) | Name | Description | | | | | | | | | | | | | | | | | | | | | | | | | | | | | | | | | | | | | | | | | | | |
| 0 | DC hold active | 1 = DC hold is active | | | | | | | | | | | | | | | | | | | | | | | | | | | | | | | | | | | | | | | | | | | |
| 2 | Motor pre-heating active | 1 = Motor pre-heating is active | | | | | | | | | | | | | | | | | | | | | | | | | | | | | | | | | | | | | | | | | | | |
| 3...15 | Reserve | | | | | | | | | | | | | | | | | | | | | | | | | | | | | | | | | | | | | | | | | | | | |
| | 0000h...FFFFh | Drive status word 1. | 1 = 1 | | | | | | | | | | | | | | | | | | | | | | | | | | | | | | | | | | | | | | | | | | |

| Serial number | Name/Value | Description | Def/FbEq16 |
|-----------------------|--------------------------------|---------------------------------------------------------------------------------------------------------------|----------------|
| 06.29 | <i>MSW bit 10 selection</i> | Selects a binary source whose status is transmitted as bit 10 (User bit 0) of <i>06.11 Main status word</i> . | Above limit |
| | False | 0 | 0 |
| | True | 1 | 1 |
| | Above limit | Bit 10 of <i>06.17 Drive status word 2</i> (see page 142). | 2 |
| | <i>Other [bit]</i> | Source selection (see <i>Terms and abbreviations</i> on page 130). | - |
| 06.30 | <i>MSW bit 11 selection</i> | Selects a binary source whose status is transmitted as bit 11 (User bit 0) of <i>06.11 Main status word</i> . | Ext ctrl loc |
| | False | 0 | 0 |
| | True | 1 | 1 |
| | Ext ctrl loc | <i>06.01</i> Bit 11 of <i>Main control word</i> (See page 141). | 2 |
| | <i>Other [bit]</i> | Source selection (See 130 on page <i>Terms and abbreviations</i>). | - |
| 06.31 | <i>MSW bit 12 selection</i> | Selects a binary source whose status is transmitted as bit 12 (User bit 1) of <i>06.11 Main status word</i> . | Ext run enable |
| | False | 0 | 0 |
| | True | 1 | 1 |
| | Ext run enable | Status of the external run enable signal (See parameter <i>20.12 Run enable 1 source</i>). | 2 |
| | <i>Other [bit]</i> | Source selection (See 130 on page <i>Terms and abbreviations</i>). | - |
| 06.32 | <i>MSW bit 13 selection</i> | Selects a binary source whose status is transmitted as bit 13 (User bit 2) of <i>06.11 Main status word</i> . | False |
| | False | 0 | 0 |
| | True | 1 | 1 |
| | <i>Other [bit]</i> | Source selection (See 130 on page <i>Terms and abbreviations</i>). | - |
| 06.33 | <i>MSW bit 14 selection</i> | Selects a binary source whose status is transmitted as bit 14 (User bit 3) of <i>06.11 Main status word</i> . | False |
| | False | 0 | 0 |
| | True | 1 | 1 |
| | <i>Other [bit]</i> | Source selection (See 130 on page <i>Terms and abbreviations</i>). | - |
| 07 System info | | Drive hardware and firmware information. All parameters in this group are read-only. | |
| 07.03 | <i>Drive rating</i> | Type of the drive/inverter unit. | - |
| 07.04 | <i>Firmware name</i> | Firmware identification. | - |
| 07.05 | <i>Firmware version</i> | Version number of the firmware. | - |
| 07.06 | <i>Loading package name</i> | Name of the firmware loading package. | - |
| 07.07 | <i>Loading package version</i> | Version number of the firmware loading package. | - |
| 07.11 | <i>CPU usage</i> | Microprocessor load in percent. | - |
| | 0...100% | Microprocessor load. | 1 = 1% |

| Serial number | Name/Value | Description | Def/FbEq16 | | | | | | | | | | | | | | | | | | | | | | | | | | | | | | | | | | | | | | | | | | | | | |
|-------------------------------------------------------------------------------------------------------------------------------------------------------------------------------------------------------------------------------------------------------------------------------------------------------------------------------------------------------------------------------------------------------------------------------------------------------------------------------------------------------------------------------------------------------------------------------------------------------------------------------------------------------------------------------------------------------------------------------------------------------------------------------------------------------------------------------------------------------------------------------------------------------------------------------------------------------------------------------------------------------------------------------------------------------------------------------------------------------------------------------------------------------------------------------------------------------------------------------------------------------------------------------------------------------------------------------------------------------------------------------------------------------------------------------------------------------------------------|--------------------------------------|-------------------------------------------------------------------------------------------------------------------------------------------------------------------------------------------------------------------------------------------------------------------------------------------------------------------------------------------------------------------------------------------------------------------|------------|-----|------|-------------|---|-----------------|--------------------------------------------------|---|-----------|--------------------------------------------------------------------------------------|---|----------|-------------------------------------------------|---|---------|-------------------------------------------------------|---|---------|----------------------------------------------|---|---------|-------------------------------------------------|---|---------|---------------------------------------------|-------|----------|-------------------------------------|--------|----------|------------------------------------------------|----|---------|----------------------------------------------------------|----|---------|---------------------------------------------------------|----|----------|--|----|---------|----------------------------------------------------------|----|---------|--------------------------------------------------------|
| 07.25 | <i>Customization package name</i> | First five ASCII letters of the name given to the customization package. The full name is visible in the System info menu under the Main menu on the control panel or the Drive composer PC tool. _N/A_ = None. | - | | | | | | | | | | | | | | | | | | | | | | | | | | | | | | | | | | | | | | | | | | | | | |
| 07.26 | <i>Customization package version</i> | Customization package version number. Also visible in the System info menu under the Main menu on the control panel or the Drive composer PC tool. | - | | | | | | | | | | | | | | | | | | | | | | | | | | | | | | | | | | | | | | | | | | | | | |
| 07.35 | <i>Drive configuration</i> | Performs HW initialization, and shows the detected option module configuration of the drive. Plug 'n' play configuration during the HW initialization, if the drive is not able to detect any option module, the value is set to 1, Base unit. For information on automatic setting of parameters after detecting a module, see section <i>Automatic drive configuration for fieldbus control</i> on page 594. | 0000h | | | | | | | | | | | | | | | | | | | | | | | | | | | | | | | | | | | | | | | | | | | | | |
| <table border="1"> <thead> <tr> <th>Bit</th> <th>Name</th> <th>Description</th> </tr> </thead> <tbody> <tr> <td>0</td> <td>Not initialized</td> <td>1 = Drive configuration has not been initialized</td> </tr> <tr> <td>1</td> <td>Base unit</td> <td>1 = Drive has not detected any option modules, that is, there is only the base unit.</td> </tr> <tr> <td>2</td> <td>Reserved</td> <td></td> </tr> <tr> <td>3</td> <td>FENA-21</td> <td>1 = FENA-21 Two-port Ethernet adapter module included</td> </tr> <tr> <td>4</td> <td>FECA-01</td> <td>1 = FECA-01 EtherCAT adapter module included</td> </tr> <tr> <td>5</td> <td>FPBA-01</td> <td>1 = FPBA-01 PROFIBUS DP adapter module included</td> </tr> <tr> <td>6</td> <td>FCAN-01</td> <td>1 = FCAN-01 CANopen adapter module included</td> </tr> <tr> <td>7...9</td> <td>Reserved</td> <td></td> </tr> <tr> <td>10</td> <td>FSCA-01</td> <td>1 = FSCA-01 Modbus/RTU adapter module included</td> </tr> <tr> <td>11</td> <td>FEIP-21</td> <td>1 = FEIP-21 Two-port EtherNet/IP adapter module included</td> </tr> <tr> <td>12</td> <td>FMBT-21</td> <td>1 = FMBT-21 Two-port Modbus/TCP adapter module included</td> </tr> <tr> <td>13</td> <td>Reserved</td> <td></td> </tr> <tr> <td>14</td> <td>FPNO-21</td> <td>1 = FPNO-21 Two-port PROFINET IO adapter module included</td> </tr> <tr> <td>15</td> <td>FEPL-02</td> <td>1 = FEPL-02 Ethernet POWERLINK adapter module included</td> </tr> </tbody> </table> | | | | Bit | Name | Description | 0 | Not initialized | 1 = Drive configuration has not been initialized | 1 | Base unit | 1 = Drive has not detected any option modules, that is, there is only the base unit. | 2 | Reserved | | 3 | FENA-21 | 1 = FENA-21 Two-port Ethernet adapter module included | 4 | FECA-01 | 1 = FECA-01 EtherCAT adapter module included | 5 | FPBA-01 | 1 = FPBA-01 PROFIBUS DP adapter module included | 6 | FCAN-01 | 1 = FCAN-01 CANopen adapter module included | 7...9 | Reserved | | 10 | FSCA-01 | 1 = FSCA-01 Modbus/RTU adapter module included | 11 | FEIP-21 | 1 = FEIP-21 Two-port EtherNet/IP adapter module included | 12 | FMBT-21 | 1 = FMBT-21 Two-port Modbus/TCP adapter module included | 13 | Reserved | | 14 | FPNO-21 | 1 = FPNO-21 Two-port PROFINET IO adapter module included | 15 | FEPL-02 | 1 = FEPL-02 Ethernet POWERLINK adapter module included |
| Bit | Name | Description | | | | | | | | | | | | | | | | | | | | | | | | | | | | | | | | | | | | | | | | | | | | | | |
| 0 | Not initialized | 1 = Drive configuration has not been initialized | | | | | | | | | | | | | | | | | | | | | | | | | | | | | | | | | | | | | | | | | | | | | | |
| 1 | Base unit | 1 = Drive has not detected any option modules, that is, there is only the base unit. | | | | | | | | | | | | | | | | | | | | | | | | | | | | | | | | | | | | | | | | | | | | | | |
| 2 | Reserved | | | | | | | | | | | | | | | | | | | | | | | | | | | | | | | | | | | | | | | | | | | | | | | |
| 3 | FENA-21 | 1 = FENA-21 Two-port Ethernet adapter module included | | | | | | | | | | | | | | | | | | | | | | | | | | | | | | | | | | | | | | | | | | | | | | |
| 4 | FECA-01 | 1 = FECA-01 EtherCAT adapter module included | | | | | | | | | | | | | | | | | | | | | | | | | | | | | | | | | | | | | | | | | | | | | | |
| 5 | FPBA-01 | 1 = FPBA-01 PROFIBUS DP adapter module included | | | | | | | | | | | | | | | | | | | | | | | | | | | | | | | | | | | | | | | | | | | | | | |
| 6 | FCAN-01 | 1 = FCAN-01 CANopen adapter module included | | | | | | | | | | | | | | | | | | | | | | | | | | | | | | | | | | | | | | | | | | | | | | |
| 7...9 | Reserved | | | | | | | | | | | | | | | | | | | | | | | | | | | | | | | | | | | | | | | | | | | | | | | |
| 10 | FSCA-01 | 1 = FSCA-01 Modbus/RTU adapter module included | | | | | | | | | | | | | | | | | | | | | | | | | | | | | | | | | | | | | | | | | | | | | | |
| 11 | FEIP-21 | 1 = FEIP-21 Two-port EtherNet/IP adapter module included | | | | | | | | | | | | | | | | | | | | | | | | | | | | | | | | | | | | | | | | | | | | | | |
| 12 | FMBT-21 | 1 = FMBT-21 Two-port Modbus/TCP adapter module included | | | | | | | | | | | | | | | | | | | | | | | | | | | | | | | | | | | | | | | | | | | | | | |
| 13 | Reserved | | | | | | | | | | | | | | | | | | | | | | | | | | | | | | | | | | | | | | | | | | | | | | | |
| 14 | FPNO-21 | 1 = FPNO-21 Two-port PROFINET IO adapter module included | | | | | | | | | | | | | | | | | | | | | | | | | | | | | | | | | | | | | | | | | | | | | | |
| 15 | FEPL-02 | 1 = FEPL-02 Ethernet POWERLINK adapter module included | | | | | | | | | | | | | | | | | | | | | | | | | | | | | | | | | | | | | | | | | | | | | | |
| | 000h...FFFFh | Drive configuration | 1 = 1 | | | | | | | | | | | | | | | | | | | | | | | | | | | | | | | | | | | | | | | | | | | | | |
| 07.36 | <i>Drive configuration 2</i> | Shows the detected module configuration. See parameter <i>07.35 Drive configuration</i> . | 0000h | | | | | | | | | | | | | | | | | | | | | | | | | | | | | | | | | | | | | | | | | | | | | |
| <table border="1"> <thead> <tr> <th>Bit</th> <th>Name</th> <th>Description</th> </tr> </thead> <tbody> <tr> <td>0</td> <td>Reserved</td> <td></td> </tr> <tr> <td>1</td> <td>FDNA-01</td> <td>1 = FDNA-01 DeviceNet™ adapter module included</td> </tr> <tr> <td>2</td> <td>FCNA-01</td> <td>1 = FCNA-01 ControlNet™ adapter module included</td> </tr> <tr> <td>3</td> <td>CMOD-01</td> <td>1 = CMOD-01 adapter module included</td> </tr> <tr> <td>4</td> <td>CMOD-02</td> <td>1 = CMOD-02 adapter module included</td> </tr> <tr> <td>6</td> <td>CHDI-01</td> <td>1 = CHDI-01 adapter module included</td> </tr> <tr> <td>7</td> <td>FSPS-21</td> <td>1 = FSPS-21 adapter module included</td> </tr> <tr> <td>8</td> <td>CAIO-01</td> <td>1 = CAIO-01 adapter module included</td> </tr> <tr> <td>9...15</td> <td>Reserved</td> <td></td> </tr> </tbody> </table> | | | | Bit | Name | Description | 0 | Reserved | | 1 | FDNA-01 | 1 = FDNA-01 DeviceNet™ adapter module included | 2 | FCNA-01 | 1 = FCNA-01 ControlNet™ adapter module included | 3 | CMOD-01 | 1 = CMOD-01 adapter module included | 4 | CMOD-02 | 1 = CMOD-02 adapter module included | 6 | CHDI-01 | 1 = CHDI-01 adapter module included | 7 | FSPS-21 | 1 = FSPS-21 adapter module included | 8 | CAIO-01 | 1 = CAIO-01 adapter module included | 9...15 | Reserved | | | | | | | | | | | | | | | | |
| Bit | Name | Description | | | | | | | | | | | | | | | | | | | | | | | | | | | | | | | | | | | | | | | | | | | | | | |
| 0 | Reserved | | | | | | | | | | | | | | | | | | | | | | | | | | | | | | | | | | | | | | | | | | | | | | | |
| 1 | FDNA-01 | 1 = FDNA-01 DeviceNet™ adapter module included | | | | | | | | | | | | | | | | | | | | | | | | | | | | | | | | | | | | | | | | | | | | | | |
| 2 | FCNA-01 | 1 = FCNA-01 ControlNet™ adapter module included | | | | | | | | | | | | | | | | | | | | | | | | | | | | | | | | | | | | | | | | | | | | | | |
| 3 | CMOD-01 | 1 = CMOD-01 adapter module included | | | | | | | | | | | | | | | | | | | | | | | | | | | | | | | | | | | | | | | | | | | | | | |
| 4 | CMOD-02 | 1 = CMOD-02 adapter module included | | | | | | | | | | | | | | | | | | | | | | | | | | | | | | | | | | | | | | | | | | | | | | |
| 6 | CHDI-01 | 1 = CHDI-01 adapter module included | | | | | | | | | | | | | | | | | | | | | | | | | | | | | | | | | | | | | | | | | | | | | | |
| 7 | FSPS-21 | 1 = FSPS-21 adapter module included | | | | | | | | | | | | | | | | | | | | | | | | | | | | | | | | | | | | | | | | | | | | | | |
| 8 | CAIO-01 | 1 = CAIO-01 adapter module included | | | | | | | | | | | | | | | | | | | | | | | | | | | | | | | | | | | | | | | | | | | | | | |
| 9...15 | Reserved | | | | | | | | | | | | | | | | | | | | | | | | | | | | | | | | | | | | | | | | | | | | | | | |



| Serial number | Name/Value | Description | Def/FbEq16 | | | | | | | | | | | | | | | | | | | | | | | | |
|-----------------------------------------------------------------------------------------------------------------------------------------------------------------------------------------------------------------------------------------------------------------------------------------------------------------------------------------------------------------------------------------------------------------------------------------------------------------------------------------------------------------------------------------------------------------------------------------------------------------------------------------------------------------------------------------------------------------------------------------------------------------------------------------------------|---------------------------------------------------------------------------|---------------------------------------------------------------------------------------------------------------------------------------------------------------------------------------------------------------------------------------------------------------------------------------------------------------------------------------------------------------------------|------------|--------|-------|-------------|---------------------------------------------------------------------------|-----|---------------------------------------------------------------------------|---|---------------------------------------------------------------------------|----------------------------|---------------------------------------------------------------------------|-----|---------------------------------------------------------------------------|---|---------------------------------------------------------------------------|----------------------------|---------|-----|----------------------------|---|-----|----------------------------|--------|----------|--|
| | 0000h...FFFFh | Drive configuration | 1 = 1 | | | | | | | | | | | | | | | | | | | | | | | | |
| 10 Standard DI,RO | | | | | | | | | | | | | | | | | | | | | | | | | | | |
| 10.01 | <i>DI status</i> | Displays the electrical status of digital inputs DI1...DI6. The activation/deactivation delays of the inputs (if any are specified) are ignored. Bits 0...5 reflect the status of DI1...DI6. Example: 000000000010011b = DI5, DI2 and DI1 are on, DI3, DI4 and DI6 are off. This parameter is read-only. | - | | | | | | | | | | | | | | | | | | | | | | | | |
| <table border="1"> <thead> <tr> <th>Bit</th> <th>Name</th> <th>Description</th> </tr> </thead> <tbody> <tr> <td>0</td> <td>DI1</td> <td>1 = Digital input 1 is ON.</td> </tr> <tr> <td>1</td> <td>DI2</td> <td>1 = Digital input 2 is ON.</td> </tr> <tr> <td>2</td> <td>DI3</td> <td>1 = Digital input 3 is ON.</td> </tr> <tr> <td>3</td> <td>DI4</td> <td>1 = Digital input 4 is ON.</td> </tr> <tr> <td>4</td> <td>DI5</td> <td>1 = Digital input 5 is ON.</td> </tr> <tr> <td>5</td> <td>DI6</td> <td>1 = Digital input 6 is ON.</td> </tr> <tr> <td>6...15</td> <td>Reserved</td> <td></td> </tr> </tbody> </table> | | | | Bit | Name | Description | 0 | DI1 | 1 = Digital input 1 is ON. | 1 | DI2 | 1 = Digital input 2 is ON. | 2 | DI3 | 1 = Digital input 3 is ON. | 3 | DI4 | 1 = Digital input 4 is ON. | 4 | DI5 | 1 = Digital input 5 is ON. | 5 | DI6 | 1 = Digital input 6 is ON. | 6...15 | Reserved | |
| Bit | Name | Description | | | | | | | | | | | | | | | | | | | | | | | | | |
| 0 | DI1 | 1 = Digital input 1 is ON. | | | | | | | | | | | | | | | | | | | | | | | | | |
| 1 | DI2 | 1 = Digital input 2 is ON. | | | | | | | | | | | | | | | | | | | | | | | | | |
| 2 | DI3 | 1 = Digital input 3 is ON. | | | | | | | | | | | | | | | | | | | | | | | | | |
| 3 | DI4 | 1 = Digital input 4 is ON. | | | | | | | | | | | | | | | | | | | | | | | | | |
| 4 | DI5 | 1 = Digital input 5 is ON. | | | | | | | | | | | | | | | | | | | | | | | | | |
| 5 | DI6 | 1 = Digital input 6 is ON. | | | | | | | | | | | | | | | | | | | | | | | | | |
| 6...15 | Reserved | | | | | | | | | | | | | | | | | | | | | | | | | | |
| | 0000h...FFFFh | Status for digital inputs. | 1 = 1 | | | | | | | | | | | | | | | | | | | | | | | | |
| 10.03 | <i>DI force selection</i> | The electrical statuses of the digital inputs can be overridden for, e.g., testing purposes. Bit in parameter <i>10.04 DI force data</i> is used by each digit input, therefore, at any time, the value is applied in case of relevant bit of parameter is 1. Note: Boot and power cycle reset the force selections (parameters <i>10.03</i> and <i>10.04</i>) | 0000h | | | | | | | | | | | | | | | | | | | | | | | | |
| <table border="1"> <thead> <tr> <th>Bit(s)</th> <th>Value</th> </tr> </thead> <tbody> <tr> <td>0</td> <td>1 = Force DI1 to value of bit 0 of parameter <i>10.04 DI force data</i>.</td> </tr> <tr> <td>1</td> <td>1 = Force DI2 to value of bit 1 of parameter <i>10.04 DI force data</i>.</td> </tr> <tr> <td>2</td> <td>1 = Force DI3 to value of bit 2 of parameter <i>10.04 DI force data</i>.</td> </tr> <tr> <td>3</td> <td>1 = Force DI4 to value of bit 3 of parameter <i>10.04 DI force data</i>.</td> </tr> <tr> <td>4</td> <td>1 = Force DI5 to value of bit 4 of parameter <i>10.04 DI force data</i>.</td> </tr> <tr> <td>5</td> <td>1 = Force DI6 to value of bit 5 of parameter <i>10.04 DI force data</i>.</td> </tr> <tr> <td>6...15</td> <td>Reserve</td> </tr> </tbody> </table> | | | | Bit(s) | Value | 0 | 1 = Force DI1 to value of bit 0 of parameter <i>10.04 DI force data</i> . | 1 | 1 = Force DI2 to value of bit 1 of parameter <i>10.04 DI force data</i> . | 2 | 1 = Force DI3 to value of bit 2 of parameter <i>10.04 DI force data</i> . | 3 | 1 = Force DI4 to value of bit 3 of parameter <i>10.04 DI force data</i> . | 4 | 1 = Force DI5 to value of bit 4 of parameter <i>10.04 DI force data</i> . | 5 | 1 = Force DI6 to value of bit 5 of parameter <i>10.04 DI force data</i> . | 6...15 | Reserve | | | | | | | | |
| Bit(s) | Value | | | | | | | | | | | | | | | | | | | | | | | | | | |
| 0 | 1 = Force DI1 to value of bit 0 of parameter <i>10.04 DI force data</i> . | | | | | | | | | | | | | | | | | | | | | | | | | | |
| 1 | 1 = Force DI2 to value of bit 1 of parameter <i>10.04 DI force data</i> . | | | | | | | | | | | | | | | | | | | | | | | | | | |
| 2 | 1 = Force DI3 to value of bit 2 of parameter <i>10.04 DI force data</i> . | | | | | | | | | | | | | | | | | | | | | | | | | | |
| 3 | 1 = Force DI4 to value of bit 3 of parameter <i>10.04 DI force data</i> . | | | | | | | | | | | | | | | | | | | | | | | | | | |
| 4 | 1 = Force DI5 to value of bit 4 of parameter <i>10.04 DI force data</i> . | | | | | | | | | | | | | | | | | | | | | | | | | | |
| 5 | 1 = Force DI6 to value of bit 5 of parameter <i>10.04 DI force data</i> . | | | | | | | | | | | | | | | | | | | | | | | | | | |
| 6...15 | Reserve | | | | | | | | | | | | | | | | | | | | | | | | | | |
| | 0000h...FFFFh | Override selection for digital inputs. | 1 = 1 | | | | | | | | | | | | | | | | | | | | | | | | |
| 10.04 | <i>DI force data</i> | Allows the data value of a forced digital input to be changed from 0 to 1. It is only possible to force an input that has been selected in parameter <i>10.03 DI force selection</i> . Bit 0 is the forced value for DI1; bit 5 is the forced value for the DI6. | 0000h | | | | | | | | | | | | | | | | | | | | | | | | |
| | 0000h...FFFFh | Forced values of digital inputs. | 1 = 1 | | | | | | | | | | | | | | | | | | | | | | | | |
| 10.21 | <i>RO status</i> | Status of relay outputs RO3...RO1 . Example: 00000001b = RO1 is energized; RO2...RO3 are de-energized. | - | | | | | | | | | | | | | | | | | | | | | | | | |
| | 0000h...FFFFh | Status of relay outputs. | 1 = 1 | | | | | | | | | | | | | | | | | | | | | | | | |

| Serial number | Name/Value | Description | Def/FbEq16 | | | | | | | | | | |
|---------------|-------------------------------------------------------------------------------------------------------------------------------------------------------------------------------------------------------------------------------------------------------------------------------------------------------------------------------------------------------------------------------------------------------------------------------------------------------------------------------|-----------------------------------------------------------------------------------------------------------------------------------------------------------------------------------------------------------------------------------------------------------------------------------------------------------------------------------------------------------------------|------------|---|----------------------------------------------------------------------------|---|----------------------------------------------------------------------------|---|----------------------------------------------------------------------------|-------|---------|--|--|
| 10.22 | <i>RO force selection</i> | The signals connected to the relay outputs can be overridden for eg. testing purposes. A bit in parameter <i>10.23 RO force value</i> is provided for each relay output, and its value is applied whenever the corresponding bit in this parameter is 1. Note: Boot and power cycle reset the force selections (parameters <i>10.22</i> and <i>10.23</i>). | | | | | | | | | | | |
| | <table border="1"> <thead> <tr> <th>Bit(s)</th> <th>Value</th> </tr> </thead> <tbody> <tr> <td>0</td> <td>1 = Force RO1 to value of bit 0 of parameter <i>10.23 RO force value</i>.</td> </tr> <tr> <td>1</td> <td>1 = Force RO2 to value of bit 1 of parameter <i>10.23 RO force value</i>.</td> </tr> <tr> <td>2</td> <td>1 = Force RO3 to value of bit 2 of parameter <i>10.23 RO force value</i>.</td> </tr> <tr> <td>3...7</td> <td>Reserve</td> </tr> </tbody> </table> | Bit(s) | Value | 0 | 1 = Force RO1 to value of bit 0 of parameter <i>10.23 RO force value</i> . | 1 | 1 = Force RO2 to value of bit 1 of parameter <i>10.23 RO force value</i> . | 2 | 1 = Force RO3 to value of bit 2 of parameter <i>10.23 RO force value</i> . | 3...7 | Reserve | | |
| Bit(s) | Value | | | | | | | | | | | | |
| 0 | 1 = Force RO1 to value of bit 0 of parameter <i>10.23 RO force value</i> . | | | | | | | | | | | | |
| 1 | 1 = Force RO2 to value of bit 1 of parameter <i>10.23 RO force value</i> . | | | | | | | | | | | | |
| 2 | 1 = Force RO3 to value of bit 2 of parameter <i>10.23 RO force value</i> . | | | | | | | | | | | | |
| 3...7 | Reserve | | | | | | | | | | | | |
| 10.23 | <i>RO force value</i> | Contains the values of relay outputs that are used instead of the connected signals (if selected in parameter <i>10.22 RO force selection</i> Bit 0 is the forced value for RO1. Bit 1 is the forced value for RO2. Bit 2 is the forced value for RO3. | | | | | | | | | | | |
| | 0000h...FFFFh | Forced RO values. | 1 = 1 | | | | | | | | | | |
| 10.24 | <i>RO1 source</i> | Selects a drive signal to be connected to relay output RO1. | Ready run | | | | | | | | | | |
| | De-energized | Output is de-energized. | 0 | | | | | | | | | | |
| | Energized | Output is energized. | 1 | | | | | | | | | | |
| | Ready run | <i>06.11</i> Bit 1 of <i>Main status word</i> (See page 141). | 2 | | | | | | | | | | |
| | Enabled | <i>06.16</i> Bit 0 of <i>Drive status word 1</i> (See page 142). | 4 | | | | | | | | | | |
| | Start up | <i>06.16</i> Bit 5 of <i>Drive status word 1</i> (See page 142). | 5 | | | | | | | | | | |
| | Magnetized | <i>06.17</i> Bit 1 of <i>Drive status word 2</i> (See page 142). | 6 | | | | | | | | | | |
| | Running | <i>06.16</i> Bit 6 of <i>Drive status word 1</i> (See page 142). | 7 | | | | | | | | | | |
| | Rdy Ref | <i>06.11</i> Bit 2 of <i>Main status word</i> (See page 141). | 8 | | | | | | | | | | |
| | Reach a reference | <i>06.11</i> Bit 8 of <i>Main status word</i> (See page 141). | 9 | | | | | | | | | | |
| | Exceed a limit | <i>06.17</i> Bit 10 of <i>Drive status word 2</i> (See page 142). | 12 | | | | | | | | | | |
| | Alarm | <i>06.11</i> Bit 7 of <i>Main status word</i> (See page 141). | 13 | | | | | | | | | | |
| | Fault | <i>06.11</i> Bit 3 of <i>Main status word</i> (See page 141). | 14 | | | | | | | | | | |
| | Fault (-1) | <i>06.11 Main status word</i> Inverted bit 3 of (See page 141). | 15 | | | | | | | | | | |
| | Fault / Alarm | <i>06.11 Main status word</i> Bit 3 or <i>06.11 Main status word</i> Bit 7 (See page 141). | 16 | | | | | | | | | | |
| | Over current | Failure <i>2310 DC bus over current</i> . | 17 | | | | | | | | | | |
| | Overvoltage | Failure <i>3210 DC bus overvoltage</i> . | 18 | | | | | | | | | | |
| | Converter temperature | Failure <i>2381 IGBT overload</i> or <i>4110 Control board temperature</i> or <i>4210 IGBT overtemperature</i> or <i>4290 Cooling</i> or <i>42F1 IGBT temperature</i> or <i>4310 Excess temperature</i> or <i>4380 Excess temperature difference</i> . | 19 | | | | | | | | | | |
| | Undervoltage | Failure <i>3220 DC bus undervoltage</i> . | 20 | | | | | | | | | | |
| | Motor temperature | Failure <i>4981 Ext Tmp 1</i> or <i>4982 Ext Tmp2</i> | 21 | | | | | | | | | | |
| | Ext2active | <i>06.16</i> Bit 11 of <i>Drive status word 1</i> (See page 142). | 23 | | | | | | | | | | |
| | External control | <i>06.11</i> Bit 9 of <i>Main status word</i> (See page 141). | 24 | | | | | | | | | | |

| Serial number | Name/Value | Description | Def/FbEq16 |
|-----------------------------------------------------------------------------------------------------------|---------------------------|-----------------------------------------------------------------------------------------------------------------------------------|----------------|
| | Motor temperature | Failure <i>4981 Ext Tmp 1</i> or <i>4982 Ext Tmp2</i> | 21 |
| | Ext2active | <i>06.16</i> Bit 11 of <i>Drive status word 1</i> (See page 142). | 23 |
| | External control | <i>06.11</i> Bit 9 of <i>Main status word</i> (See page 141). | 24 |
| | MCB | Reserve | 25 |
| | Timed function 1 | <i>34.01</i> Bit 0 of <i>Combined timer status</i> (See page 218). | 27 |
| | Timed function 2 | <i>34.01</i> Bit 1 of <i>Combined timer status</i> (See page 218). | 28 |
| | Timed function 3 | <i>34.01</i> Bit 2 of <i>Combined timer status</i> (See page 218). | 29 |
| | Monitor 1 | <i>32.01</i> Bit 0 of <i>Supervision status word</i> (See page 211). | 33 |
| | Monitor 2 | <i>32.01</i> Bit 1 of <i>Supervision status word</i> (See page 211). | 34 |
| | Monitor 3 | <i>32.01</i> Bit 2 of <i>Supervision status word</i> (See page 211). | 35 |
| | Start delay | <i>06.17</i> Bit 13 of <i>Drive status word 2</i> (See page 142). | 39 |
| | RO/DIO control word bit 0 | <i>10.101 RO/DIO control word</i> bit 0 | 40 |
| | RO/DIO control word bit 1 | <i>10.101 RO/DIO control word</i> bit 1 | 41 |
| | RO/DIO control word bit 2 | <i>10.101 RO/DIO control word</i> bit 2 | 42 |
| | PFC1 | PFC working status bit 0 | 45 |
| | PFC2 | PFC working status bit 1 | 46 |
| | PFC3 | PFC working status bit 2 | 47 |
| | PFC4 | PFC working status bit 3 | 48 |
| | <i>Other [bit]</i> | Source selection (See <i>Terms and abbreviations</i>). | - |
| 10.25 | <i>RO1 ON delay</i> | Defines the activation delay for relay output RO1. | 0.0 s |
| <p> $t_{on} = 10.25$ RO1 ON delay $t_{off} = 10.26$ RO1 OFF delay </p> | | | |
| | 0.0 ... 3000.0 s | Activation delay for RO1. | 10 = 1 s |
| 10.26 | <i>RO1 OFF delay</i> | Defines close delay for relay output RO1. See parameter <i>10.25 RO1 ON delay</i> . | 0.0 s |
| | 0.0 ... 3000.0 s | Deactivation delay for RO1. | 10 = 1 s |
| 10.27 | <i>RO2 source</i> | Selects a drive signal to be connected to relay output RO2. For the available selections, see parameter <i>10.24 RO1 source</i> . | <i>Running</i> |

| Serial number | Name/Value | Description | Def/FbEq16 | | | | | | | | | | | | | |
|---------------|--------------------------------------------------------------------------------------------------------------------------------------------------------------------------------------------------------------------------------------------------------------------------------------------------------------------------------------------------------------------------------------------------------------------------|---------------------------------------------------------------------------------------------------------------------------------------------------------------------------------------------------------------------------------------------------------------------------------------------------------------------------------------------------------|-------------------|--------|------|-------------|---|-----|------------------------------------------------------------------------------------------------------------|---|-----|---|-----|--------|---------|--|
| 10.28 | <i>RO2 ON delay</i> | Defines the activation delay for relay output RO2. | 0.0 s | | | | | | | | | | | | | |
| | <p>$t_{On} = 10.28$ RO2 ON delay $t_{Off} = 10.29$ RO2 OFF delay</p> | | | | | | | | | | | | | | | |
| | 0.0 ... 3000.0 s | Activation delay for RO2. | 10 = 1s | | | | | | | | | | | | | |
| 10.29 | <i>RO2 OFF delay</i> | Defines the deactivation delay for relay output RO2. See parameter <i>10.28 RO2 ON delay</i> . | 0.0 s | | | | | | | | | | | | | |
| | 0.0 ... 3000.0 s | Deactivation delay for RO2. | 10 = 1s | | | | | | | | | | | | | |
| 10.30 | <i>RO3 source</i> | Selects a drive signal to be connected to relay output RO3. For the available selections, see parameter <i>10.24 RO1 source</i> . | <i>Fault (-1)</i> | | | | | | | | | | | | | |
| 10.31 | <i>RO3 ON delay</i> | Defines the activation delay for relay output RO3. | 0.0 s | | | | | | | | | | | | | |
| | <p>$t_{On} = 10.31$ RO3 ON delay $t_{Off} = 10.32$ RO3 OFF delay</p> | | | | | | | | | | | | | | | |
| | 0.0 ... 3000.0 s | Activation delay for RO3. | 10 = 1s | | | | | | | | | | | | | |
| 10.32 | <i>RO3 OFF delay</i> | Defines the deactivation delay for relay output RO3. See parameter <i>10.31 RO3 ON delay</i> . | 0.0 s | | | | | | | | | | | | | |
| | 0.0 ... 3000.0 s | Deactivation delay for RO3. | 10 = 1s | | | | | | | | | | | | | |
| 10.99 | <i>RO/DIO control word</i> | Storage parameters outputted by the control relay, such as those via built-in bus interface. For control of relay output of the drive (RO), a control word needs to be sent as Modbus I/O data. Set target selection parameters <i>58.101...58.114 RO/DIO control word</i> . Select an appropriate control word bit in output signal source parameters. | | | | | | | | | | | | | | |
| | <table border="1"> <thead> <tr> <th>Bit(s)</th> <th>Name</th> <th>Description</th> </tr> </thead> <tbody> <tr> <td>0</td> <td>RO1</td> <td rowspan="3">Signal source bit of relay output RO1...RO3 (See parameter <i>10.24</i>, <i>10.27</i> and <i>10.30</i>).</td> </tr> <tr> <td>1</td> <td>RO2</td> </tr> <tr> <td>2</td> <td>RO3</td> </tr> <tr> <td>3...15</td> <td>Reserve</td> <td></td> </tr> </tbody> </table> | | | Bit(s) | Name | Description | 0 | RO1 | Signal source bit of relay output RO1...RO3 (See parameter <i>10.24</i> , <i>10.27</i> and <i>10.30</i>). | 1 | RO2 | 2 | RO3 | 3...15 | Reserve | |
| Bit(s) | Name | Description | | | | | | | | | | | | | | |
| 0 | RO1 | Signal source bit of relay output RO1...RO3 (See parameter <i>10.24</i> , <i>10.27</i> and <i>10.30</i>). | | | | | | | | | | | | | | |
| 1 | RO2 | | | | | | | | | | | | | | | |
| 2 | RO3 | | | | | | | | | | | | | | | |
| 3...15 | Reserve | | | | | | | | | | | | | | | |

| Serial number | Name/Value | Description | Def/FbEq16 |
|--------------------------------|-------------------------------|-------------------------------------------------------------------------------------------------------------------------------------------------------------------------------------------------------------------------------------------------------------------------------------|---------------|
| 10.101 | <i>RO1 toggle counter</i> | Displays the number of times relay output RO1 has changed states. | - |
| | 0...4294967000 | State change count. | 1 = 1 |
| 10.102 | <i>RO2 toggle counter</i> | Displays the number of times relay output RO2 has changed states. | - |
| | 0...4294967000 | State change count. | 1 = 1 |
| 10.103 | <i>RO3 toggle counter</i> | Displays the number of times relay output RO3 has changed states. | - |
| | 0...4294967000 | State change count. | 1 = 1 |
| 11 Standard DIO, FI, FO | | Configuration of the frequency input. | |
| 11.21 | <i>DI5 Configuration</i> | Selects how digital input 5 is used. | Digital input |
| | Digital input | DI5 is used as a digital input. | 0 |
| | frequency input | DI5 is used as a frequency input. | 1 |
| 11.38 | <i>Freq in 1 actual value</i> | Displays the value of frequency input 1 (via DI5) when it issued as a frequency input) before scaling. <i>11.42 Freq in 1 min.</i> This parameter is read-only. | - |
| | 0 ... 16000 Hz | Unscaled value of frequency input 1. | 1 = 1 Hz |
| 11.39 | <i>Freq in 1 scaled value</i> | Displays the value of frequency input 1 (via DI5) when it is used as a frequency input) after scaling. See parameter <i>11.42 Freq in 1 min.</i> This parameter is read-only. | - |
| | -32768.000... 32767.000 | Scaled value of frequency input 1. | 1 = 1 |
| 11.42 | <i>Freq in 1 min</i> | Displays the value of frequency input 1, (via DI5) when it is used as a frequency input) Input frequency signal (<i>11.38 Freq in 1 actual value</i>) is scaled into an internal signal by parameters <i>11.39...Freq in 1 scaled value</i> as follows (<i>11.42 11.45</i>): | 0 Hz |
| | | | |
| | 1 ... 16000 Hz | Minimum Frequency for frequency input 1 (DI5). | 1 = 1 Hz |

| Serial number | Name/Value | Description | Def/FbEq16 | | | | | | | | |
|-----------------------|--------------------------------------------------------------------------------------------------------------------------------------------------------------------------------------------------------------------------------------------------------------------------------------------------------------------------------------------------------------------------|----------------------------------------------------------------------------------------------------------------------------------------------------------------------------------------------------------------------------------------------------------------------------------------------------------------------------------------------------------------------------------------------------------------------------------------------------------------------------------------------------------------------------------------------------------------------------------------------------------------------------|------------|-------|---|------------------------------------------------------------------------------|---|------------------------------------------------------------------------------|-------|---------|--|
| 11.43 | <i>Freq in 1 max</i> | Defines the maximum for the frequency actually arriving at frequency input 1 (DI5) when it is used as a frequency input). See parameter 11.42 Freq in 1 min . | 16000 Hz | | | | | | | | |
| | 1 ... 16000 Hz | Maximum frequency for frequency input 1 (DI5) | 1 = 1 Hz | | | | | | | | |
| 11.44 | <i>Freq in 1 at scaled min</i> | Defines the value that is required to correspond internally to the minimum input frequency defined by parameter 11.42 Freq in 1 min . See image at parameter 11.42 Freq in 1 min . | 0.000 | | | | | | | | |
| | -32768.000... 32767.000 | Value corresponding to minimum of frequency input 1. | 1 = 1 | | | | | | | | |
| 11.45 | <i>Freq in 1 at scaled max</i> | Defines the value that is required to correspond internally to the maximum input frequency defined by parameter 11.43 Freq in 1 max . See image at parameter 11.42 Freq in 1 min . | 50.000 | | | | | | | | |
| | -32768.000... 32767.000 | Value corresponding to maximum of frequency input 1. | 1 = 1 | | | | | | | | |
| 12 Standard AI | | Configuration of standard analog inputs. | | | | | | | | | |
| 12.02 | <i>AI force sel</i> | The true readings of the analog inputs can be overridden for testing purposes. A forced value parameter is provided for each analog output, and its value is applied whenever the corresponding bit in this parameter is 1. Note: AI filter time (parameter 12.16 AI1 filter time and 12.26 AI2 filter time) have no effect (parameters 12.13 AI1 forced value and 12.23 AI2 forced value) on forced AI values. Note: Boot and power cycle reset the force selections (parameters 12.02 and 12.03). | 0000h | | | | | | | | |
| | <table border="1"> <thead> <tr> <th>Bit(s)</th> <th>Value</th> </tr> </thead> <tbody> <tr> <td>0</td> <td>1 = Force AI1 to value of parameter 12.13 AI1 forced value.</td> </tr> <tr> <td>1</td> <td>1 = Force AI2 to value of parameter 12.23 AI2 forced value.</td> </tr> <tr> <td>2...7</td> <td>Reserve</td> </tr> </tbody> </table> | | Bit(s) | Value | 0 | 1 = Force AI1 to value of parameter 12.13 AI1 forced value . | 1 | 1 = Force AI2 to value of parameter 12.23 AI2 forced value . | 2...7 | Reserve | |
| Bit(s) | Value | | | | | | | | | | |
| 0 | 1 = Force AI1 to value of parameter 12.13 AI1 forced value . | | | | | | | | | | |
| 1 | 1 = Force AI2 to value of parameter 12.23 AI2 forced value . | | | | | | | | | | |
| 2...7 | Reserve | | | | | | | | | | |
| | 0000h...FFFFh | Forced values selector for analog inputs AI1 and AI2. | 1 = 1 | | | | | | | | |
| 12.03 | <i>AI supervision function</i> | Selects how the drive reacts when an analog input signal moves out of the minimum and/or maximum limits specified for the input. The inputs and the limits to be observed are selected by parameter 12.04 AI supervision selection . | No action | | | | | | | | |
| | No action | No action is taken. | 0 | | | | | | | | |
| | Fault | Drive trips on 80A0 AI supervision . | 1 | | | | | | | | |
| | Alarm | The drive generates A8A0 AI supervision a warning. | 2 | | | | | | | | |
| | End speed | Drive generates a warning (A8A0 AI supervision) and freezes the speed (or frequency) to the level the drive was operating at. The speed/frequency is determined on the basis of actual speed using 850 ms low-pass filtering.  Warning! Make sure that it is safe to continue operation in case of a communication break. | 3 | | | | | | | | |
| | Safe speed reference | Drive generates a warning (A8A0 AI supervision) and sets the speed to the speed defined by parameter 28.41 Reference of safe frequency , when frequency reference is being used.  Warning! Make sure that it is safe to continue operation in case of a communication break. | 4 | | | | | | | | |

| Serial number | Name/Value | Description | Def/FbEq16 | | | | | | | | | | | | | | | | | | | | | | | | | | |
|---------------|-------------------------------------------------------------------------------------------------------------------------------------------------------------------------------------------------------------------------------------------------------------------------------------------------------------------------------------------------------------------------------------------------------------------------------------------------------------------------------------------------------------------------------------------------------------------------------------------------------------------------------------------------------------------------------------------------------------------------------------------------------------------------------------------------------------------------------------------------------------------|------------------------------------------------------------------------------------------------------------------------------------------------------------------------------------------------------------------------------------------------------------------------------------------------------------------------------------------------------------------|---------------|-------------|---|-----------|--------------------------------------------------|---|-----------|--------------------------------------------------|---|-----------|-----------------------------------------------------------|---|-----------|----------------------------------------------|--------|----------|--------------------------------------------------|---|----------|--------------------------------------------------|---|-----------|-----------------------------------------------------------|--------|----------|--|--|
| 12.04 | <i>AI supervision selection</i> | Specifies the analog input limits to be supervised. See parameter <i>12.03 AI supervision function</i> . | 0000h | | | | | | | | | | | | | | | | | | | | | | | | | | |
| | <table border="1"> <thead> <tr> <th>Bit(s)</th> <th>Name</th> <th>Description</th> </tr> </thead> <tbody> <tr> <td>0</td> <td>AI1 < MIN</td> <td>1 = Minimum limit supervision of AI1 active.</td> </tr> <tr> <td>1</td> <td>AI1 > MAX</td> <td>1 = Maximum limit supervision of AI1 active.</td> </tr> <tr> <td>2</td> <td>AI2 < MIN</td> <td>1 = Minimum limit supervision of AI2 active.</td> </tr> <tr> <td>3</td> <td>AI2 > MAX</td> <td>1 = Maximum limit supervision of AI2 active.</td> </tr> <tr> <td>4...15</td> <td>Reserve</td> <td></td> </tr> </tbody> </table> | Bit(s) | Name | Description | 0 | AI1 < MIN | 1 = Minimum limit supervision of AI1 active. | 1 | AI1 > MAX | 1 = Maximum limit supervision of AI1 active. | 2 | AI2 < MIN | 1 = Minimum limit supervision of AI2 active. | 3 | AI2 > MAX | 1 = Maximum limit supervision of AI2 active. | 4...15 | Reserve | | | | | | | | | | | |
| Bit(s) | Name | Description | | | | | | | | | | | | | | | | | | | | | | | | | | | |
| 0 | AI1 < MIN | 1 = Minimum limit supervision of AI1 active. | | | | | | | | | | | | | | | | | | | | | | | | | | | |
| 1 | AI1 > MAX | 1 = Maximum limit supervision of AI1 active. | | | | | | | | | | | | | | | | | | | | | | | | | | | |
| 2 | AI2 < MIN | 1 = Minimum limit supervision of AI2 active. | | | | | | | | | | | | | | | | | | | | | | | | | | | |
| 3 | AI2 > MAX | 1 = Maximum limit supervision of AI2 active. | | | | | | | | | | | | | | | | | | | | | | | | | | | |
| 4...15 | Reserve | | | | | | | | | | | | | | | | | | | | | | | | | | | | |
| | 0000h...FFFFh | Activation of analog input supervision. | 1 = 1 | | | | | | | | | | | | | | | | | | | | | | | | | | |
| 12.05 | <i>AI supervision force</i> | Activates/deactivates analog input supervision for each control location (see section <i>Local control vs. external control</i> on page 111). When a control location does not utilize AI for referencing, you can use this parameter to deactivate AI supervision (12.04). This hides the AI supervision function (12.03) for the selected control location. | 0b0000 | | | | | | | | | | | | | | | | | | | | | | | | | | |
| | <table border="1"> <thead> <tr> <th>Bit</th> <th>Name</th> <th>Description</th> </tr> </thead> <tbody> <tr> <td>0</td> <td>AI1 Ext1</td> <td>1 = AI1 supervision is active when EXT1 is used.</td> </tr> <tr> <td>1</td> <td>AI1 Ext2</td> <td>1 = AI1 supervision is active when EXT2 is used.</td> </tr> <tr> <td>2</td> <td>AI1 Local</td> <td>1 = AI1 supervision is active when local control is used.</td> </tr> <tr> <td>3</td> <td>Reserved</td> <td></td> </tr> <tr> <td>4</td> <td>AI2 Ext1</td> <td>1 = AI2 supervision is active when EXT1 is used.</td> </tr> <tr> <td>5</td> <td>AI2 Ext2</td> <td>1 = AI2 supervision is active when EXT2 is used.</td> </tr> <tr> <td>6</td> <td>AI2 Local</td> <td>1 = AI2 supervision is active when local control is used.</td> </tr> <tr> <td>7...15</td> <td>Reserved</td> <td></td> </tr> </tbody> </table> | Bit | Name | Description | 0 | AI1 Ext1 | 1 = AI1 supervision is active when EXT1 is used. | 1 | AI1 Ext2 | 1 = AI1 supervision is active when EXT2 is used. | 2 | AI1 Local | 1 = AI1 supervision is active when local control is used. | 3 | Reserved | | 4 | AI2 Ext1 | 1 = AI2 supervision is active when EXT1 is used. | 5 | AI2 Ext2 | 1 = AI2 supervision is active when EXT2 is used. | 6 | AI2 Local | 1 = AI2 supervision is active when local control is used. | 7...15 | Reserved | | |
| Bit | Name | Description | | | | | | | | | | | | | | | | | | | | | | | | | | | |
| 0 | AI1 Ext1 | 1 = AI1 supervision is active when EXT1 is used. | | | | | | | | | | | | | | | | | | | | | | | | | | | |
| 1 | AI1 Ext2 | 1 = AI1 supervision is active when EXT2 is used. | | | | | | | | | | | | | | | | | | | | | | | | | | | |
| 2 | AI1 Local | 1 = AI1 supervision is active when local control is used. | | | | | | | | | | | | | | | | | | | | | | | | | | | |
| 3 | Reserved | | | | | | | | | | | | | | | | | | | | | | | | | | | | |
| 4 | AI2 Ext1 | 1 = AI2 supervision is active when EXT1 is used. | | | | | | | | | | | | | | | | | | | | | | | | | | | |
| 5 | AI2 Ext2 | 1 = AI2 supervision is active when EXT2 is used. | | | | | | | | | | | | | | | | | | | | | | | | | | | |
| 6 | AI2 Local | 1 = AI2 supervision is active when local control is used. | | | | | | | | | | | | | | | | | | | | | | | | | | | |
| 7...15 | Reserved | | | | | | | | | | | | | | | | | | | | | | | | | | | | |
| 12.11 | <i>AI1 actual value</i> | Displays the value of analog input AI1 in mA or V (depending on whether the input is set to current or voltage by a hardware setting). This parameter is read-only. | - | | | | | | | | | | | | | | | | | | | | | | | | | | |
| | 4.000...20.000 mA or 0.000...10.000 V | Value of analog input AI1. | 1000 = 1 unit | | | | | | | | | | | | | | | | | | | | | | | | | | |
| 12.12 | <i>AI1 scaled value</i> | Displays the value of analog input AI1 after scaling. See parameter <i>12.19 AI1 minimum scaled value</i> and <i>12.20 AI1 maximum scaled value</i> . This parameter is read-only. | - | | | | | | | | | | | | | | | | | | | | | | | | | | |
| | -32768.000...32767.000 | Scaled value of analog input AI1. | 1 = 1 | | | | | | | | | | | | | | | | | | | | | | | | | | |
| 12.13 | <i>AI1 forced value</i> | Forced value that can be used instead of the true reading of the input. See parameter <i>12.02 AI force sel</i> . | - | | | | | | | | | | | | | | | | | | | | | | | | | | |
| | 4.000...20.000 mA or 0.000...10.000 V | Forced value of analog input AI1. | 1000 = 1 unit | | | | | | | | | | | | | | | | | | | | | | | | | | |

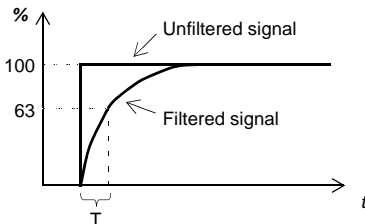
| Serial number | Name/Value | Description | Def/FbEq16 |
|---------------|------------------------------------------|--------------------------------------------------------------------------------------------------------------------------------------------------------------------------------------------------------------------------------------------------------------------------------------------------------------------------------------------------------------------------------------------------------------------------------------------------------------------------------------------------------------------------------------------------------------------------------|-----------------------|
| 12.15 | <i>AI1 unit selection</i> | Selects the unit for readings and settings related to analog input AI1. Note: This setting must match the corresponding hardware setting on the drive control unit. See chapter <i>Electrical installation</i> , section Switches in the <i>Hardware manual</i> of the drive, and the default control connections for the macro in use in chapter <i>Application macros</i> (page 29). Control board reboot (either by cycling the power or through parameter <i>96.08 Control board boot</i>) is required to validate any changes in the hardware settings. | V |
| | V | Volts. | 2 |
| | mA | Milliamperes. | 10 |
| 12.16 | <i>AI1 filter time</i> | Defines the filter time constant for analog input AI1.  $O = I \times (1 - e^{-t/T})$ I = filter input (step) O = filter output t = time T = filter time constant Note: The signal is also filtered due to the signal interface hardware (approximately 0.25 ms time constant). This cannot be changed by any parameter. | 0.100 s |
| | 0.000...30.000 s | Filter time constant. | 1000 = 1s |
| 12.17 | <i>AI1 min</i> | Defines the minimum site value for analog input AI1. Set the value actually sent to the drive when the analog signal from plant is wound to its minimum setting. | 4.000 mA or 0.000 V |
| | 4.000...20.000 mA or 0.000...10.000 V | Minimum value of AI1. | 1000 = 1 unit |
| 12.18 | <i>AI1 max</i> | Defines the maximum site value for analog input AI1. Set the value actually sent to the drive when the analog signal from plant is wound to its maximum setting. | 20.000 mA or 10.000 V |
| | 4.000...20.000 mA or 0.000...10.000 V | Maximum value of AI1. | 1000 = 1 unit |

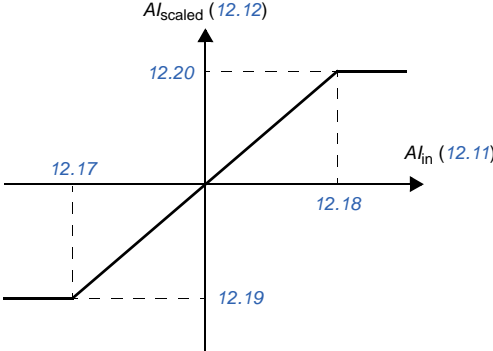
| Serial number | Name/Value | Description | Def/FbEq16 |
|---------------|------------------------------------------|-------------------------------------------------------------------------------------------------------------------------------------------------------------------------------------------------------------------------------------------------------------------------------------------------------------------------------------------------------|------------------|
| 12.19 | <i>AI1 minimum scaled value</i> | <p>Defines the real value that corresponds to the minimum analog input AI2 value defined by parameter 12.17 AI1 min. Changing the polarity settings of 12.19 and 12.20 can effectively invert the analog input.</p>  | 0.000 |
| | -32768.000... 32767.000 | Real value corresponding to minimum AI1 value. | 1 = 1 |
| 12.20 | <i>AI1 maximum scaled value</i> | Definition and by parameter 12.18 AI1 max. Actual internal value corresponding to the maximum analog input AI2 value defined. See image at parameter 12.19 AI1 minimum scaled value. | 50.000 |
| | -32768.000... 32767.000 | Real value corresponding to maximum AI1 value. | 1 = 1 |
| 12.21 | <i>AI2 actual value</i> | Displays the value of analog input AI2 in mA or V (depending on whether the input is set to current or voltage by a hardware setting). This parameter is read-only. | - |
| | 4.000...20.000 mA or 0.000...10.000 V | Value of analog input AI2. | 1000 = 1 unit |
| 12.22 | <i>AI2 scaled value</i> | Displays the value of analog input AI2 after scaling. See parameter 12.29 AI2 minimum scaled value and 12.101 AI1 percentage value. This parameter is read-only. | - |
| | -32768.000... 32767.000 | Scaled value of analog input AI2. | 1 = 1 |
| 12.23 | <i>AI2 forced value</i> | Forced value that can be used instead of the true reading of the input. See parameter 12.02 AI force sel. | - |
| | 4.000...20.000 mA or 0.000...10.000 V | Forced value of analog input AI2. | 1000 = 1 unit |

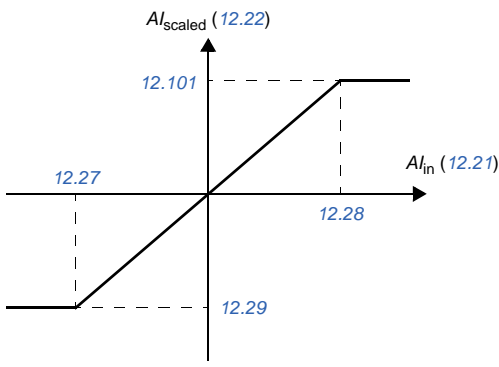
| Serial number | Name/Value | Description | Def/FbEq16 |
|---------------|---------------------------------------|------------------------------------------------------------------------------------------------------------------------------------------------------------------------------------------------------------------------------------------------------------------------------------------------------------------------------------------------------------------------------------------------------------------------------------------------------------------------------------------------------------------------------------------------------------------------|-----------------------|
| 12.25 | <i>AI2 unit selection</i> | Selects the unit for readings and settings related to analog input AI2. Note: This setting must match the corresponding hardware setting on the drive control unit. See chapter <i>Electrical installation</i> , section Switches in the Hardware manual of the drive, and the default control connections for the macro in use in chapter <i>Application macros</i> (page 29) Control board reboot (either by cycling the power or through parameter <i>96.08 Control board boot</i>) is required to validate any changes in the hardware settings. | mA |
| | V | Volts. | 2 |
| | mA | Milliamperes. | 10 |
| 12.26 | <i>AI2 filter time</i> | Defines the filter time constant for analog input AI2. See parameter <i>12.16 AI1 filter time</i> . | 0.100 s |
| | 0.000...30.000 s | Filter time constant | 1000 = 1s |
| 12.27 | <i>AI2 min</i> | Defines the minimum site value for analog input AI2. Set the value actually sent to the drive when the analog signal from plant is wound to its minimum setting. | 4.000 mA or 0.000 V |
| | 4.000...20.000 mA or 0.000...10.000 V | Minimum value of AI2 | 1000 = 1 unit |
| 12.28 | <i>AI2 max</i> | Defines the maximum site value for analog input AI2. Set the value actually sent to the drive when the analog signal from plant is wound to its maximum setting. | 20.000 mA or 10.000 V |
| | 4.000...20.000 mA or 0.000...10.000 V | Maximum value of AI2 | 1000 = 1 unit |
| 12.29 | <i>AI2 minimum scaled value</i> | Definition and by parameter <i>12.27 AI2 min</i> . Actual value corresponding to the minimum analog input AI2 value defined. . Changing the polarity settings of <i>12.29</i> and <i>12.101</i> can effectively invert the analog input.  | 0.000 |
| | -32768.000...32767.000 | Real value corresponding to minimum AI2 value. | 1 = 1 |
| 12.30 | <i>AI2 maximum scaled value</i> | Definition and by parameter <i>12.28 AI2 max</i> . Actual internal value corresponding to the maximum analog input AI2 value defined. See image at parameter <i>12.29 AI2 minimum scaled value</i> . | 50.000 |

| Serial number | Name/Value | Description | Def/FbEq16 | | | | | | | | |
|-----------------------|--------------------------------------------------------------------------------------------------------------------------------------------------------------------------------------------------------------------------------------------------------------------------------------------------------------------------------------------------------|---------------------------------------------------------------------------------------------------------------------------------------------------------------------------------------------------------------------------------------------------------------------------------------------------------------------------------|------------|--------|-------|---|---------------------------------------------------------------------|---|---------------------------------------------------------------------|-------|---------|
| 12.101 | <i>AI1 percentage value</i> | Value of analog input AI1 in percent of AI1 scaling (<i>12.18 AI1 max - 12.17 AI1 min</i>). | - | | | | | | | | |
| | 0.00... 100.00 | AI1 value | 100 = 1% | | | | | | | | |
| 12.102 | <i>AI2 percentage value</i> | Value of analog input AI2 in percent of AI1 scaling (<i>12.28 AI2 max - 12.27 AI2 min</i>). | - | | | | | | | | |
| | 0.00... 100.00 | AI2 value | 100 = 1% | | | | | | | | |
| 12.110 | <i>AI dead band</i> | AI dead band value in percentage where 100% = 10 V in voltage mode and 100% = 20 mA in current mode. Applicable to both AI1 and AI2. Note: 10% of AI dead band value is internally added in firmware as AI dead band hysteresis positive and negative. (See section <i>AI dead band</i> on page 103.) | 0.40% | | | | | | | | |
| | 0%...100% | dead band value | 1 = 1 | | | | | | | | |
| 13 Standard AO | | Configuration of standard analog outputs. | | | | | | | | | |
| 13.02 | <i>AO force selection</i> | The source signals of the analog outputs can be overridden for eg. testing purposes. A forced value parameter is provided for each analog output, and its value is applied whenever the corresponding bit in this parameter is 1. Note: Boot and power cycle reset the force selections (parameters 13.02 and 13.11). | 0000h | | | | | | | | |
| | <table border="1"> <thead> <tr> <th>Bit(s)</th> <th>Value</th> </tr> </thead> <tbody> <tr> <td>0</td> <td>1 = Force AO1 to value of parameter <i>13.13 AO1 forced value</i>.</td> </tr> <tr> <td>1</td> <td>1 = Force AO2 to value of parameter <i>13.23 AO2 forced value</i>.</td> </tr> <tr> <td>2...7</td> <td>Reserve</td> </tr> </tbody> </table> | | | Bit(s) | Value | 0 | 1 = Force AO1 to value of parameter <i>13.13 AO1 forced value</i> . | 1 | 1 = Force AO2 to value of parameter <i>13.23 AO2 forced value</i> . | 2...7 | Reserve |
| Bit(s) | Value | | | | | | | | | | |
| 0 | 1 = Force AO1 to value of parameter <i>13.13 AO1 forced value</i> . | | | | | | | | | | |
| 1 | 1 = Force AO2 to value of parameter <i>13.23 AO2 forced value</i> . | | | | | | | | | | |
| 2...7 | Reserve | | | | | | | | | | |
| | 0000h...FFFFh | Forced values selector for analog outputs AO1 and AO2. | 1 = 1 | | | | | | | | |
| 13.11 | <i>AO1 actual value</i> | Displays the value of AO1 in mA or V. This parameter is read-only. | - | | | | | | | | |
| | 0.000...22.000 mA or 0.000...11.000 mA | Value of AO1. | 1 = 1 mA | | | | | | | | |

| Serial number | Name/Value | Description | Def/FbEq16 |
|---------------|------------------------------------------|--------------------------------------------------------------------------------------------------------------------------------------------------------------------------------------------------------------------------------------------------------------------------------------------------------------------------------------------------------------------------------------------------------------------------------------------------------------------------------------------------------------------------------------------------------------------------------------------------|------------------|
| 13.12 | AO1 signal source | Select the signals which are intended to connect with analogue output AO1. | Output frequency |
| | Zero | None. | 0 |
| | Motor speed used | 01.01 Motor speed (page 133). | 1 |
| | Output frequency | 01.06 Output frequency (page 133). | 3 |
| | Motor current | 01.07 Motor current (page 133). | 4 |
| | Percent of motor nominal current | 01.08 Motor nominal current (%) (page 133). | 5 |
| | Motor torque | 01.10 Motor torque (%) (page 133). | 6 |
| | DC voltage | 01.11 DC voltage (page 133). | 7 |
| | Output power | 01.14 Output frequency (page 133). | 8 |
| | Freq ref used | 28.02 Frequency ref ramp output (page 189). | 14 |
| | Process PID out | 40.01 PID output value (page 240). | 16 |
| | Temp sensor 1 excitation | The output is used to feed an excitation current to the temperature sensor 1. See parameter 35.11 Temperature 1 source . See also section Motor thermal protection (page 89). | 20 |
| | Temp sensor 2 excitation | The output is used to feed an excitation current to the temperature sensor 2. See parameter 35.21 Temperature 2 source . See also section Motor thermal protection (page 89). | 21 |
| | Absolute value of motor speed | 01.61 Absolute value of motor speed (page 129). | 26 |
| | Absolute value of motor speed percentage | 01.62 Absolute value of motor speed (%) (page 135). | 27 |
| | Abs output frequency | 01.63 Abs output frequency (page 135). | 28 |
| | Abs motor torque | 01.64 Abs motor torque (page 136). | 30 |
| | Abs output power | 01.65 Abs output power (page 136). | 31 |
| | Abs motor shaft power | 01.68 Abs motor shaft power (page 136). | 32 |
| | AO1 data storage | 13.91 AO1 data storage | 37 |
| | AO2 data storage | 13.92 AO2 data storage | 38 |
| | <i>Other</i> | Source selection (See 130 on page Terms and abbreviations). | - |
| 13.13 | AO1 forced value | Forced value that can be used instead of the selected output signal. See parameter 13.02 AO force selection . | 0.000 mA |
| | 0.000...22.000 mA or 0...11.000V | Forced value for AO1. | 1 = 1 unit |
| 13.15 | AO1 unit selection | Selects the unit for readings and settings related to analog input AO1. Note: This setting must match the corresponding hardware setting on the drive control unit. See chapter <i>Electrical installation</i> , section Switches in the <i>Hardware manual</i> of the drive, and the default control connections for the macro in use in chapter Application macros (page 29). Control board reboot (either by cycling the power or through parameter 96.08 Control board boot) is required to validate any changes in the hardware settings. | mA |

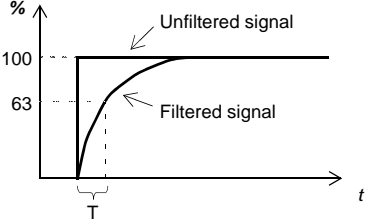
| Serial number | Name/Value | Description | Def/FbEq16 |
|---------------|--------------------|-------------------------------------------------------------------------------------------------------------------------------------------------------------------------------------------------------------------------------------------------------------------------------------------------------|------------|
| | V | Volts. | 2 |
| | mA | Milliamperes. | 10 |
| 13.16 | AO1 filter time | <p>Defines the filtering time constant for analog output AO1.</p>  <p>$O = I \times (1 - e^{-t/T})$</p> <p>I = filter input (step) O = filter output t = time T = filter time constant</p> | 0.100 s |
| | 0.000 ... 30.000 s | Filter time constant | 1000 = 1s |

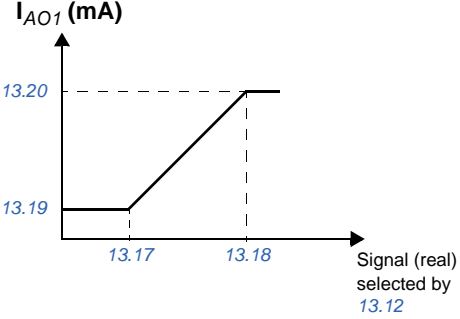
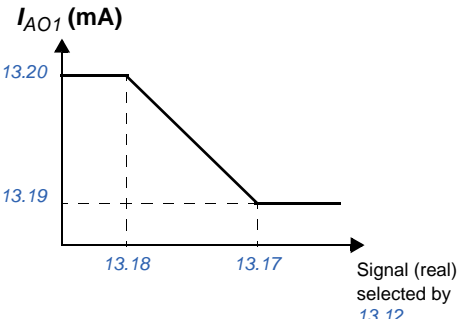
| Serial number | Name/Value | Description | Def/FbEq16 |
|---------------|-----------------------|---------------------------------------------------------------------------------------------------------------------------------------------------------------------------------------------------------------------------------------------------------------------------------------------------------------------------------------------------------------------------------------------------------------------------------------------------------------------------------------------|------------|
| 13.17 | AO1 signal source Min | <p>Defines the real minimum value of the signal (selected by parameter 13.12 AO1 signal source), that corresponds to the minimum required AO1 output value (defined by parameter 13.19 AO1 Minimum output value).</p>  <p>Programming 13.17 as the maximum value and 13.18 as the minimum value inverts the output.</p>  | 0.0 |

| Serial number | Name/Value | Description | Def/FbEq16 |
|---------------------------------------------------------------------------------------------------------------------------------------------------------------------------------------|----------------------------------------------------|-----------------------------------------------------------------------------------------------------------------------------------------------------------------------------------------------------------------------------------------------------------|------------------------------------------------------------|
| AO has automatic scaling. Every time the source for the AO is changed, the scaling range is changed accordingly. User given minimum and maximum values override the automatic values. | | | |
| | 13.12 AO1 signal source 13.22 AO2 signal source | 13.17 AO1 signal source Min 13.27 AO2 signal source min | 13.18 AO1 signal source max 13.28 AO2 signal source max |
| 0 | Zero | N/A (Output is constant zero.) | |
| 1 | Motor speed used | 0 | 46.01 Speed fieldbus scaled value |
| 3 | Output frequency | 0 | 46.02 Frequency fieldbus scaled value |
| 4 | Motor current | 0 | 30.17 Maximum current |
| 5 | Percent of motor nominal current | 0% | 100% |
| 6 | Motor torque | 0 | 46.03 Torque fieldbus scaled value |
| 7 | DC voltage | 01.11 Min. value of DC voltage | 01.11 Max. value of DC voltage |
| 8 | Output power | 0 | 46.04 Power fieldbus scaled value |
| 14 | Freq ref used | 0 | 46.02 Frequency fieldbus scaled value |
| 16 | Process PID out | 40.01 Min. value of PID output value | 40.01 Max. value of PID output value |
| 20 | Temp sensor 1 excitation | N/A (Analog output is not scaled; it is determined by the sensor's triggering voltage.) | |
| 21 | Temp sensor 2 excitation | | |
| 26 | Absolute value of motor speed | 0 | 46.01 Speed fieldbus scaled value |
| 27 | Absolute value of motor speed percentage | 0 | 46.01 Speed fieldbus scaled value |
| 28 | Abs output frequency | 0 | 46.02 Frequency fieldbus scaled value |
| 30 | Abs motor torque | 0 | 46.03 Torque fieldbus scaled value |
| 31 | Abs output power | 0 | 46.04 Power fieldbus scaled value |
| 32 | Abs motor shaft power | 0 | 46.04 Power fieldbus scaled value |
| 37 | AO1 data storage | - | 13.91, AO1 data storage |
| | -32768.0...32767.0 | Real signal value corresponding to minimum AO1 output value. | 1 = 1 |
| 13.18 | AO1 signal source max | Defines the real maximum value of the signal (selected by 13.12 AO1 signal source parameter), that corresponds to the maximum required AO2 output value (defined by parameter 13.20 AO1 Maximum output value). See parameter 13.17 AO1 signal source Min. | 50.0 |
| | -32768.0...32767.0 | Real signal value corresponding to maximum AO1 output value. | 1 = 1 |
| 13.19 | AO1 Minimum output value | Defines the minimum output value for analog output AO1. See also images in parameter 13.17 AO1 signal source Min. | 0.000 mA |
| | 0.000 ... 22.000 mA | Minimum AO1 output value. | 1000 = 1 mA |

| Serial number | Name/Value | Description | Def/FbEq16 |
|---------------|---------------------------------|--------------------------------------------------------------------------------------------------------------------------------------------------------------------------------------------------------------------------------------------------------|----------------------|
| 13.20 | <i>AO1 Maximum output value</i> | Defines the maximum output value for analog output AO1. See also images in parameter 13.17 AO1 signal source Min. | 20.000 mA |
| | 0.000 ... 22.000 mA | Maximum AO1 output value. | 1000 = 1 mA |
| 13.21 | <i>AO2 actual value</i> | Displays the value of AO2 in mA. This parameter is read-only. | - |
| | 0.000 ... 22.000 mA | Value of AO2. | 1000 = 1 mA |
| 13.22 | <i>AO2 signal source</i> | Select the signals which are intended to connect with analog output AO2. Alternatively, sets the output to excitation mode to feed a constant current to a temperature sensor. For selections, see parameter 13.12 AO1 signal source . | <i>Motor current</i> |
| 13.23 | <i>AO2 forced value</i> | Forced value that can be used instead of the selected output signal. See parameter 13.02 AO force selection . | 0.000 mA |
| | 0.000 ... 22.000 mA | Forced value for AO2. | 1000 = 1 mA |
| 13.26 | <i>AO2 filter time</i> | Defines the filtering time constant for analog output AO2. See parameter 13.16 AO1 filter time . | 0.100 s |
| | 0.000 ... 30.000 s | Filter time constant | 1000 = 1s |

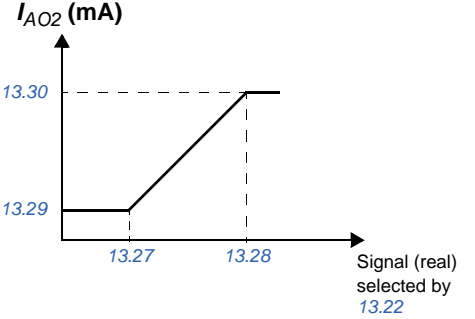
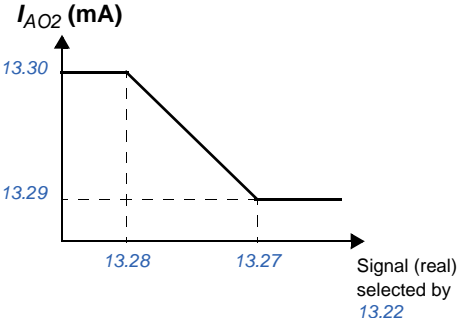
| Serial number | Name/Value | Description | Def/FbEq16 |
|---------------|---------------------------------|-----------------------------------------------------------------------------------------------------------------------------------------------------------------------------------------------------------------------------------------------------------------------------------------------------------------------------------------------------------------------------------------------------------------------------------------------------------------------------------------------------------------------------------------------------------------------------------------------------------------------------------------------------|-------------|
| 13.27 | <i>AO2 signal source min</i> | <p>Defines the real minimum value of the signal (selected by parameter 13.22 AO2 signal source that corresponds to the minimum required AO2 output value (defined by parameter 13.29 AO2 Minimum output value). See parameter 13.17 AO1 signal source Min about the AO automatic scaling.</p>  <p>Programming 13.27 as the maximum value and 13.28 as the minimum value inverts the output.</p>  | 0.0 |
| | -32768.0...32767.0 | Real signal value corresponding to minimum AO2 output value. | 1 = 1 |
| 13.28 | <i>AO2 signal source max</i> | <p>Defines the real maximum value of the signal (selected by parameter 13.22 AO2 signal source) that corresponds to the maximum required AO2 output value (defined by parameter 13.30 AO2 Maximum output value). See parameter 13.27 AO2 signal source min. See parameter 13.17 AO1 signal source Min about the AO automatic scaling.</p> | 100.0 |
| | -32768.0...32767.0 | Real signal value corresponding to maximum AO2 output value. | 1 = 1 |
| 13.29 | <i>AO2 Minimum output value</i> | Defines the minimum output value for analog output AO2. See also images in parameter 13.27 AO2 signal source min . | 0.000 mA |
| | 0.000 ... 22.000 mA | Minimum AO2 output value. | 1000 = 1 mA |

| Serial number | Name/Value | Description | Def/FbEq16 |
|--------------------------------|----------------------------------|--------------------------------------------------------------------------------------------------------------------------------------------------------------------------------------------------------------------------------------------------------------------------------------------------------------------------------------------------------------------------------------------------------------------------------------------------------------------------------------------------------------------------------------------------------------------------------------------------------------------------|-------------|
| 13.30 | <i>AO2 Maximum output value</i> | Defines the maximum output value for analog output AO2. See also images in parameter <i>13.27 AO2 signal source min</i> . | 20.000 mA |
| | 0.000 ... 22.000 mA | Maximum AO2 output value. | 1000 = 1 mA |
| | -32768.000... 32767.000 | Real signal value corresponding to minimum AO8 output value. | 1000 = 1 |
| 13.91 | <i>AO1 data storage</i> | Set the storage parameter that controls the analog output signal AO1 by embedded fieldbus settings. Select <i>13.12 AO1 signal source</i> in parameters <i>AO1 data storage</i> . Next, set the parameter as target input value. Easily set the target selection parameters of specific data (<i>58.101...58.114</i>) by embedded fieldbus interface to <i>AO1 data storage</i> . | |
| 13.92 | <i>AO2 data storage</i> | Actual maximum value of defined signal (through parameter <i>13.22 AO2 signal source</i>) complies with AO2 the maximum allowable output value (See parameter <i>13.30 AO2 Maximum output value</i> defined through parameter). See parameter <i>13.27 AO2 data storage</i> . See parameter <i>13.17 AO2 signal source min</i> about the AO automatic scaling. | |
| 15 I/O extension module | | Configuration of the I/O extension module installed in slot 2. See also section <i>Programmable I/O extensions</i> (page 126). Note: The contents of the parameter group vary according to the selected I/O extension module type. | |
| 15.01 | <i>Extension module type</i> | Activates (and specifies the type of) an I/O extension module. If the extension module has been installed and the drive is powered (keeping all bits in <i>07.35 Drive configuration</i> and <i>07.36 Drive configuration 2</i> as 0), the drive automatically sets the value to the type it has detected in <i>15.02 Detected extension module</i> . Warning <i>A7AB Extension I/O configuration failure</i> is generated if <i>15.01 Extension module type</i> is not <i>None</i> and not matching <i>15.02 Detected extension module</i> . In that case you will have to set the value of this parameter manually. | None |
| | None | Inactive. | 0 |
| | CMOD-01 | CMOD-01 multifunction extension module (external 24 V AC/DC and digital I/O). | 1 |
| | CMOD-02 | CMOD-02 multifunction extension module (external 24 V AC/DC and isolated PTC interface). | 2 |
| | CHDI-01 | CHDI-01 115/230 V digital input extension module. | 3 |
| 15.02 | <i>Detected extension module</i> | I/O extension module detected on the drive. | None |
| | None | Inactive. | 0 |
| | CMOD-01 | CMOD-01 multifunction extension module (external 24 V AC/DC and digital I/O). | 1 |
| | CMOD-02 | CMOD-02 multifunction extension module (external 24 V AC/DC and isolated PTC interface). | 2 |
| | CHDI-01 | CHDI-01 115/230 V digital input extension module. | 3 |
| | 0000h...FFFFh | Status of digital input/outputs. | 1 = 1 |

| Serial number | Name/Value | Description | Def/FbEq16 | | | | | | | | | | | | | | | | | | |
|---------------------------------------------------------------------------------------------------------------------------------------------------------------------------------------------------------------------------------------------------------------------------------------------------------------------------------------------------------------------------------------------------------------------------------------------------------------------------------------------------------------------------------------------------------------------------------------------------------------------------------------------------------------------------------------|------------------------------|---------------------------------------------------------------------------------------------------------------------------------------------------------------------------------------------------------------------------------------------------------------------------------------------------------------------------------------------------------------------------------------------------------|------------|-----|------|-------------|---|-----|-----------------------------------------------------------------------------------------------------|---|-----|-----------------------------------------------------------------------------------------------------|-------|----------|--|---|-----|----------------------------------------------------------------------------------------------------|--------|----------|--|
| 15.04 | <i>RO/DO status</i> | Displays the status of the relay outputs RO4 and RO5 and digital output DO1 on the extension module. Bits 0...1 indicates the status of RO4...RO5; bit 5 indicates the status of DO1. Example: 100101b = RO4 is on, RO5 is off. and DO1 is on. This parameter is read-only. | - | | | | | | | | | | | | | | | | | | |
| <table border="1"> <thead> <tr> <th>Bit</th> <th>Name</th> <th>Description</th> </tr> </thead> <tbody> <tr> <td>0</td> <td>RO4</td> <td>1 = Relay output 4 is ON.</td> </tr> <tr> <td>1</td> <td>RO5</td> <td>1 = Relay output 5 is ON</td> </tr> <tr> <td>2...4</td> <td colspan="2">Reserved</td> </tr> <tr> <td>5</td> <td>DO1</td> <td>1 = Digital output 1 is ON.</td> </tr> <tr> <td>6...15</td> <td colspan="2">Reserved</td> </tr> </tbody> </table> | | | | Bit | Name | Description | 0 | RO4 | 1 = Relay output 4 is ON. | 1 | RO5 | 1 = Relay output 5 is ON | 2...4 | Reserved | | 5 | DO1 | 1 = Digital output 1 is ON. | 6...15 | Reserved | |
| Bit | Name | Description | | | | | | | | | | | | | | | | | | | |
| 0 | RO4 | 1 = Relay output 4 is ON. | | | | | | | | | | | | | | | | | | | |
| 1 | RO5 | 1 = Relay output 5 is ON | | | | | | | | | | | | | | | | | | | |
| 2...4 | Reserved | | | | | | | | | | | | | | | | | | | | |
| 5 | DO1 | 1 = Digital output 1 is ON. | | | | | | | | | | | | | | | | | | | |
| 6...15 | Reserved | | | | | | | | | | | | | | | | | | | | |
| | 0000h...FFFFh | Status of relay/digital outputs. | 1 = 1 | | | | | | | | | | | | | | | | | | |
| 15.05 | <i>RO/DO force selection</i> | The electrical statuses of the relay/digital outputs can be overridden, for example, for testing purposes. A bit in parameter <i>15.06 RO/DO forced data</i> is provided for each relay or digital output, and its value is applied whenever the corresponding bit in this parameter is 1. Note: Boot and power cycle reset the force selections (parameters <i>15.05</i> and <i>15.06</i>). | 0000h | | | | | | | | | | | | | | | | | | |
| <table border="1"> <thead> <tr> <th>Bit</th> <th>Name</th> <th>Value</th> </tr> </thead> <tbody> <tr> <td>0</td> <td>RO4</td> <td>1 = Force RO4 to value of bit 0 of parameter <i>15.06 RO/DO forced data</i>.</td> </tr> <tr> <td>1</td> <td>RO5</td> <td>1 = Force RO5 to value of bit 1 of parameter <i>15.06 RO/DO forced data</i>.</td> </tr> <tr> <td>2...4</td> <td colspan="2">Reserved</td> </tr> <tr> <td>5</td> <td>DO1</td> <td>1 = Force DO1 to value of bit 5 of parameter <i>15.06 RO/DO forced data</i>.</td> </tr> <tr> <td>6...15</td> <td colspan="2">Reserved</td> </tr> </tbody> </table> | | | | Bit | Name | Value | 0 | RO4 | 1 = Force RO4 to value of bit 0 of parameter <i>15.06 RO/DO forced data</i> . | 1 | RO5 | 1 = Force RO5 to value of bit 1 of parameter <i>15.06 RO/DO forced data</i> . | 2...4 | Reserved | | 5 | DO1 | 1 = Force DO1 to value of bit 5 of parameter <i>15.06 RO/DO forced data</i> . | 6...15 | Reserved | |
| Bit | Name | Value | | | | | | | | | | | | | | | | | | | |
| 0 | RO4 | 1 = Force RO4 to value of bit 0 of parameter <i>15.06 RO/DO forced data</i> . | | | | | | | | | | | | | | | | | | | |
| 1 | RO5 | 1 = Force RO5 to value of bit 1 of parameter <i>15.06 RO/DO forced data</i> . | | | | | | | | | | | | | | | | | | | |
| 2...4 | Reserved | | | | | | | | | | | | | | | | | | | | |
| 5 | DO1 | 1 = Force DO1 to value of bit 5 of parameter <i>15.06 RO/DO forced data</i> . | | | | | | | | | | | | | | | | | | | |
| 6...15 | Reserved | | | | | | | | | | | | | | | | | | | | |
| | 0000h...FFFFh | Override selection for relay/digital outputs. | 1 = 1 | | | | | | | | | | | | | | | | | | |
| 15.06 | <i>RO/DO forced data</i> | Allows the data value of a forced relay or digital output to be changed from 0 to 1. It is only possible to force an output that has been selected in parameter <i>15.05 RO/DO force selection</i> . Bits 0...1 are the forced values for RO4...RO5; bit 5 is the forced value for DO1. | 0000h | | | | | | | | | | | | | | | | | | |
| <table border="1"> <thead> <tr> <th>Bit</th> <th>Name</th> <th>Description</th> </tr> </thead> <tbody> <tr> <td>0</td> <td>RO4</td> <td>Force the value of this bit to RO4, if so defined in parameter <i>15.05 RO/DO force selection</i>.</td> </tr> <tr> <td>1</td> <td>RO5</td> <td>Force the value of this bit to RO5, if so defined in parameter <i>15.05 RO/DO force selection</i>.</td> </tr> <tr> <td>2...4</td> <td colspan="2">Reserved</td> </tr> <tr> <td>5</td> <td>DO1</td> <td>Force the value of this bit to DO1 if so defined in parameter <i>15.05 RO/DO force selection</i>.</td> </tr> <tr> <td>6...15</td> <td colspan="2">Reserved</td> </tr> </tbody> </table> | | | | Bit | Name | Description | 0 | RO4 | Force the value of this bit to RO4, if so defined in parameter <i>15.05 RO/DO force selection</i> . | 1 | RO5 | Force the value of this bit to RO5, if so defined in parameter <i>15.05 RO/DO force selection</i> . | 2...4 | Reserved | | 5 | DO1 | Force the value of this bit to DO1 if so defined in parameter <i>15.05 RO/DO force selection</i> . | 6...15 | Reserved | |
| Bit | Name | Description | | | | | | | | | | | | | | | | | | | |
| 0 | RO4 | Force the value of this bit to RO4, if so defined in parameter <i>15.05 RO/DO force selection</i> . | | | | | | | | | | | | | | | | | | | |
| 1 | RO5 | Force the value of this bit to RO5, if so defined in parameter <i>15.05 RO/DO force selection</i> . | | | | | | | | | | | | | | | | | | | |
| 2...4 | Reserved | | | | | | | | | | | | | | | | | | | | |
| 5 | DO1 | Force the value of this bit to DO1 if so defined in parameter <i>15.05 RO/DO force selection</i> . | | | | | | | | | | | | | | | | | | | |
| 6...15 | Reserved | | | | | | | | | | | | | | | | | | | | |
| | 0000h...FFFFh | Forced values of relay/digital outputs. | 1 = 1 | | | | | | | | | | | | | | | | | | |

| Serial number | Name/Value | Description | Def/FbEq16 |
|---------------|-------------------|------------------------------------------------------------------------------------------------------------------------------------------------------------------------------------------------------------------------------------------------------------------|---------------|
| 15.07 | <i>RO4 source</i> | Selects a drive signal to be connected to relay output RO4. | Not energized |
| | Not energized | Output is not energized. | 0 |
| | Energized | Output is energized. | 1 |
| | Ready run | Bit 1 of <i>06.11 Main status word</i> (see page 141). | 2 |
| | Reserved | | 3 |
| | Enabled | Bit 0 of <i>06.16 Drive status word 1</i> (see page 142). | 4 |
| | Started | Bit 5 of <i>06.16 Drive status word 1</i> (see page 142). | 5 |
| | Magnetized | Bit 1 of <i>06.17 Drive status word 2</i> (see page 142). | 6 |
| | Running | Bit 6 of <i>06.16 Drive status word 1</i> (see page 142). | 7 |
| | Ready ref | Bit 2 of <i>06.11 Main status word</i> (see page 141). | 8 |
| | At setpoint | Bit 8 of <i>06.11 Main status word</i> (see page 141). | 9 |
| | Reverse | Bit 2 of <i>06.19 Speed control status word</i> (see page 229). | 10 |
| | Zero speed | Bit 0 of <i>06.19 Speed control status word</i> (see page 229). | 11 |
| | Above limit | Bit 10 of <i>06.17 Drive status word 2</i> (see page 142). | 12 |
| | Warning | Bit 7 of <i>06.11 Main status word</i> (see page 141). | 13 |
| | Fault | Bit 3 of <i>06.11 Main status word</i> (see page 141). | 14 |
| | Fault (-1) | Inverted bit 3 of <i>06.11 Main status word</i> (see page 141). | 15 |
| | Fault/Warning | Bit 3 of <i>06.11 Main status word</i> OR bit 7 of <i>06.11 Main status word</i> (see page 141). | 16 |
| | Overcurrent | Fault <i>2310 Overcurrent</i> has occurred. | 17 |
| | Overvoltage | Fault <i>3210 DC link overvoltage</i> has occurred. | 18 |
| | Drive temp | Fault <i>2381 IGBT overload</i> or <i>4110 Control board temperature</i> or <i>4210 IGBT overtemperature</i> or <i>4290 Cooling</i> or <i>42F1 IGBT temperature</i> or <i>4310 Excess temperature</i> or <i>4380 Excess temperature difference</i> has occurred. | 19 |
| | Undervoltage | Fault <i>3220 DC link undervoltage</i> has occurred. | 20 |
| | Motor temp | Fault <i>4981 External temperature 1</i> or <i>4982 External temperature 2</i> has occurred. | 21 |
| | Brake command | Bit 0 of <i>44.01 Brake control status word</i> (see page 259). | 22 |
| | Ext2 active | Bit 11 of <i>06.16 Drive status word 1</i> (see page 142). | 23 |
| | Remote control | Bit 9 of <i>06.11 Main status word</i> (see page 141). | 24 |
| | Reserved | | 25...26 |
| | Timed function 1 | Bit 0 of <i>34.01 Combined timer status</i> (see page 218). | 27 |
| | Timed function 2 | Bit 1 of <i>34.01 Combined timer status</i> (see page 218). | 28 |
| | Timed function 3 | Bit 2 of <i>34.01 Combined timer status</i> (see page 218). | 29 |
| | Reserved | | 30...32 |
| | Supervision 1 | Bit 0 of <i>32.01 Supervision status word</i> (see page 211). | 33 |
| | Supervision 2 | Bit 1 of <i>32.01 Supervision status word</i> (see page 211). | 34 |
| | Supervision 3 | Bit 2 of <i>32.01 Supervision status word</i> (see page 211). | 35 |
| | Reserved | | 36...38 |
| | Start delay | Bit 13 of <i>06.17 Drive status word 2</i> (see page 142). | 39 |

| Serial number | Name/Value | Description | Def/FbEq16 |
|---------------|-----------------------------------------------------------------------------------------------------------|------------------------------------------------------------------------------------------------------------------------------------------------------------------------------------------------------------------------------------|----------------------|
| | RO/DIO control word bit0 | Bit 0 of 10.99 RO/DIO control word (see page 241). | 40 |
| | RO/DIO control word bit1 | Bit 1 of 10.99 RO/DIO control word (see page 241). | 41 |
| | RO/DIO control word bit2 | Bit 2 of 10.99 RO/DIO control word (see page 241). | 42 |
| | Reserved | | 43...44 |
| | PFC1 | Bit 0 of 76.01 PFC status (see page 435). | 45 |
| | PFC2 | Bit 1 of 76.01 PFC status (see page 435). | 46 |
| | PFC3 | Bit 2 of 76.01 PFC status (see page 435). | 47 |
| | PFC4 | Bit 3 of 76.01 PFC status (see page 435). | 48 |
| | PFC5 | Bit 4 of 76.01 PFC status (see page 435). | 49 |
| | PFC6 | Bit 5 of 76.01 PFC status (see page 435). | 50 |
| | Reserved | | 51...52 |
| | Event word 1 | Event word 1 = 1 if any bit of 04.40 Event word 1 (see page 137) is 1, that is, if any warning, fault or pure event that has been defined with parameters 04.41...04.71 is on. | 53 |
| | User load curve | Bit 3 (Outside load limit) of 37.01 ULC output status word (see page 237). | 61 |
| | RO/DIO control word | For 15.07 RO4 source : Bit 3 (RO4) of 10.99 RO/DIO control word (see page 241). For 15.10 RO5 source : Bit 4 (RO5) of 10.99 RO/DIO control word (see page 241). | 62 |
| | <i>Other [bit]</i> | Source selection (see Terms and abbreviations on page 130). | - |
| 15.08 | RO4 ON delay | Defines the activation delay for relay output RO4. | 0.0 s |
| | <p> $t_{on} = 15.08$ RO4 ON delay $t_{off} = 15.09$ RO4 OFF delay </p> | | |
| | 0.0 ... 3000.0 s | Activation delay for RO4. | 10 = 1 s |
| 15.09 | RO4 OFF delay | Defines the deactivation delay for relay output RO4. See parameter 15.08 RO4 ON delay . | 0.0 s |
| | 0.0 ... 3000.0 s | Deactivation delay for RO4. | 10 = 1 s |
| 15.10 | RO5 source | Selects a drive signal to be connected to relay output RO5. For the available selections, see parameter 15.07 RO4 source . | <i>Not energized</i> |

| Serial number | Name/Value | Description | Def/FbEq16 |
|---------------|---------------------------------------------------------------------------------------------------|---------------------------------------------------------------------------------------------------------------------|----------------|
| 15.11 | <i>RO5 ON delay</i> | Defines the activation delay for relay output RO5. | 0.0 s |
| | <p> t_{On} = 15.11 RO5 ON delay t_{Off} = 15.12 RO5 OFF delay </p> | | |
| | 0.0 ... 3000.0 s | Activation delay for RO5. | 10 = 1 s |
| 15.12 | <i>RO5 OFF delay</i> | Defines the deactivation delay for relay output RO5. See parameter 15.11 RO5 ON delay. | 0.0 s |
| | 0.0 ... 3000.0 s | Deactivation delay for RO5. | 10 = 1 s |
| 15.22 | <i>DO1 configuration</i> | Selects how DO1 is used. | Digital output |
| | Digital output | DO1 is used as a digital output. | 0 |
| | Frequency output | DO1 is used as a frequency output. | 2 |
| 15.23 | <i>DO1 source</i> | Selects a drive signal to be connected to digital output DO1 when 15.22 DO1 configuration is set to Digital output. | Not energized |
| | Not energized | Output is not energized. | 0 |
| | Energized | Output is energized. | 1 |
| | Ready run | Bit 1 of 06.11 Main status word (see page 141). | 2 |
| | Reserved | | 3 |
| | Enabled | Bit 0 of 06.16 Drive status word 1 (see page 142). | 4 |
| | Started | Bit 5 of 06.16 Drive status word 1 (see page 142). | 5 |
| | Magnetized | Bit 1 of 06.17 Drive status word 2 (see page 142). | 6 |
| | Running | Bit 6 of 06.16 Drive status word 1 (see page 142). | 7 |
| | Ready ref | Bit 2 of 06.11 Main status word (see page 141). | 8 |
| | At setpoint | Bit 8 of 06.11 Main status word (see page 141). | 9 |
| | Reverse | Bit 2 of 06.19 Speed control status word (see page 229). | 10 |
| | Zero speed | Bit 0 of 06.19 Speed control status word (see page 229). | 11 |
| | Above limit | Bit 10 of 06.17 Drive status word 2 (see page 142). | 12 |
| | Warning | Bit 7 of 06.11 Main status word (see page 141). | 13 |
| | Fault | Bit 3 of 06.11 Main status word (see page 141). | 14 |
| | Fault (-1) | Inverted bit 3 of 06.11 Main status word (see page 141). | 15 |
| | Fault/Warning | Bit 3 of 06.11 Main status word OR bit 7 of 06.11 Main status word (see page 141). | 16 |
| | Overcurrent | Fault 2310 Overcurrent has occurred. | 17 |
| | Overvoltage | Fault 3210 DC link overvoltage has occurred. | 18 |

| Serial number | Name/Value | Description | Def/FbEq16 |
|---------------|-----------------------------|---------------------------------------------------------------------------------------------------------------------------------------------------------------------------------------------------------------------------------------------------------------------------------------------------------------------------------|------------|
| | Drive temp | Fault 2381 IGBT overload or 4110 Control board temperature or 4210 IGBT overtemperature or 4290 Cooling or 42F1 IGBT temperature or 4310 Excess temperature or 4380 Excess temperature difference has occurred. | 19 |
| | Undervoltage | Fault 3220 DC link undervoltage has occurred. | 20 |
| | Motor temp | Fault 4981 External temperature 1 or 4982 External temperature 2 has occurred. | 21 |
| | Brake command | Bit 0 of 44.01 Brake control status word (see page 259). | 22 |
| | Ext2 active | Bit 11 of 06.16 Drive status word 1 (see page 142). | 23 |
| | Remote control | Bit 9 of 06.11 Main status word (see page 141). | 24 |
| | Reserved | | 25...26 |
| | Timed function 1 | Bit 0 of 34.01 Combined timer status (see page 218). | 27 |
| | Timed function 2 | Bit 1 of 34.01 Combined timer status (see page 218). | 28 |
| | Timed function 3 | Bit 2 of 34.01 Combined timer status (see page 218). | 29 |
| | Reserved | | 30...32 |
| | Supervision 1 | Bit 0 of 32.01 Supervision status word (see page 211). | 33 |
| | Supervision 2 | Bit 1 of 32.01 Supervision status word (see page 211). | 34 |
| | Supervision 3 | Bit 2 of 32.01 Supervision status word (see page 211). | 35 |
| | Reserved | | 36...38 |
| | Start delay | Bit 13 of 06.17 Drive status word 2 (see page 142). | 39 |
| | RO/DIO control word bit0 | Bit 0 of 10.99 RO/DIO control word (see page 241). | 40 |
| | RO/DIO control word bit1 | Bit 1 of 10.99 RO/DIO control word (see page 241). | 41 |
| | RO/DIO control word bit2 | Bit 2 of 10.99 RO/DIO control word (see page 241). | 42 |
| | Reserved | Hint: To access bits 3, 4, and 8 of 10.99 RO/DIO control word (see page 241), use selection 53 (Other [bit]). | 43...44 |
| | PFC1 | Bit 0 of 76.01 PFC status (see page 435). | 45 |
| | PFC2 | Bit 1 of 76.01 PFC status (see page 435). | 46 |
| | PFC3 | Bit 2 of 76.01 PFC status (see page 435). | 47 |
| | PFC4 | Bit 3 of 76.01 PFC status (see page 435). | 48 |
| | PFC5 | Bit 4 of 76.01 PFC status (see page 435). | 49 |
| | PFC6 | Bit 5 of 76.01 PFC status (see page 435). | 50 |
| | Reserved | | 51...52 |
| | Event word 1 | Event word 1 = 1 if any bit of 04.40 Event word 1 (see page 137) is 1, that is, if any warning, fault or pure event that has been defined with parameters 04.41...04.71 is on. | 53 |
| | User load curve | Bit 3 (Outside load limit) of 37.01 ULC output status word (see page 237). | 61 |
| | RO/DIO control word | For 15.23 DO1 source : Bit 8 (DIO1) of 10.99 RO/DIO control word (see page 241). | 62 |
| | Other [bit] | Source selection (see Terms and abbreviations on page 130). | - |

| Serial number | Name/Value | Description | Def/FbEq16 |
|---------------|-----------------------------------------------------------------------------------------------------------------|-----------------------------------------------------------------------------------------------------------------------------------------------------------------------------------------------------------------------------------------------|------------------|
| 15.24 | <i>DO1 ON delay</i> | Defines the activation delay for digital output DO1 when 15.22 DO1 configuration is set to <i>Digital output</i> . | 0.0 s |
| | <p> $t_{On} = 15.24$ <i>DO1 ON delay</i> $t_{Off} = 15.25$ <i>DO1 OFF delay</i> </p> | | |
| | 0.0 ... 3000.0 s | Activation delay for DO1. | 10 = 1 s |
| 15.25 | <i>DO1 OFF delay</i> | Defines the deactivation delay for relay output DO1 when 15.22 DO1 configuration is set to <i>Digital output</i> . See parameter 15.24 DO1 ON delay . | 0.0 s |
| | 0.0 ... 3000.0 s | Deactivation delay for DO1. | 10 = 1 s |
| 15.32 | <i>Freq out 1 actual value</i> | Displays the value of frequency output 1 at digital output DO1 when 15.22 DO1 configuration is set to <i>Frequency output</i> . This parameter is read-only. | - |
| | 0 ... 16000 Hz | Value of frequency output 1. | 1 = 1 Hz |
| 15.33 | <i>Freq out 1 source</i> | Selects a signal to be connected to digital output DO1 when 15.22 DO1 configuration is set to <i>Frequency output</i> . Alternatively, sets the output to excitation mode to feed a constant current to a temperature sensor. | Motor speed used |
| | Not selected | None. | 0 |
| | Motor speed used | 01.01 Motor speed (page 133). | 1 |
| | Output frequency | 01.06 Output frequency (page 133). | 3 |
| | Motor current | 01.07 Motor current (page 133). | 4 |
| | Motor torque | 01.10 Motor torque (%) (page 133). | 6 |
| | DC voltage | 01.11 DC voltage (page 133). | 7 |
| | Output power | 01.14 Output frequency (page 133). | 8 |
| | Speed ref ramp in | 23.01 Speed ref ramp input (page 307). | 10 |
| | Speed ref ramp out | 23.02 Speed ref ramp output (page 307). | 11 |
| | Speed ref used | 24.01 Used speed reference (page 311). | 12 |
| | Torque ref used | 26.02 Torque reference used (page 318). | 13 |
| | Freq ref used | 28.02 Frequency ref ramp output (page 189). | 14 |
| | Reserved | | 15 |
| | Process PID out | 40.01 PID output value (page 240). | 16 |
| | <i>Other</i> | Source selection (see Terms and abbreviations on page 130). | - |

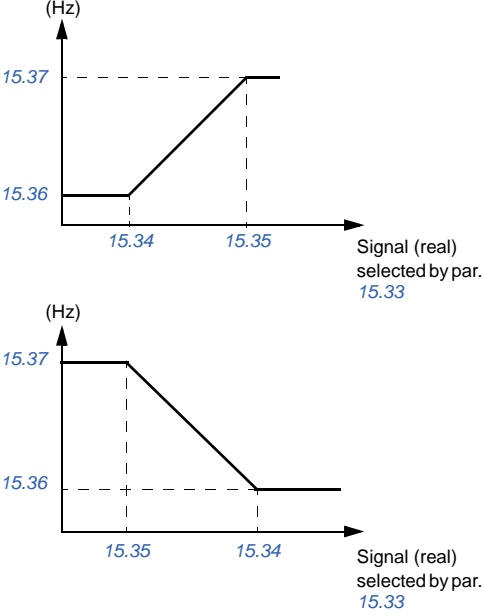
| Serial number | Name/Value | Description | Def/FbEq16 |
|---------------|-----------------------------------------|----------------------------------------------------------------------------------------------------------------------------------------------------------------------------------------------------------------------------------------------------------------------------------------------------------------------------------------------------------------------------------------------------------------------------|-------------------------------------------------------|
| 15.34 | <i>Freq out 1 src min</i> | <p>Defines the real value of the signal (selected by parameter 15.33 Freq out 1 source) that corresponds to the minimum value of frequency output 1 (defined by parameter 15.36 Freq out 1 at src min). This applies when 15.22 DO1 configuration is set to <i>Frequency output</i>.</p>  | 0.000 |
| | -32768.000... 32767.000 | Real signal value corresponding to minimum value of frequency output 1. | 1 = 1 |
| 15.35 | <i>Freq out 1 src max</i> | <p>Defines the real value of the signal (selected by parameter 15.33 Freq out 1 source) that corresponds to the maximum value of frequency output 1 (defined by parameter 15.37 Freq out 1 at src max). This applies when 15.22 DO1 configuration is set to <i>Frequency output</i>. See parameter 15.34 Freq out 1 src min.</p> | 1500.000; 1800.000 (95.20 b0) |
| | -32768.000... 32767.000 | Real signal value corresponding to maximum value of frequency output 1. | 1 = 1 |
| 15.36 | <i>Freq out 1 at src min</i> | <p>Defines the minimum output value of frequency output 1 when 15.22 DO1 configuration is set to <i>Frequency output</i>. See also drawing at parameter 15.34 Freq out 1 src min.</p> | 0 Hz |
| | 0 ... 16000 Hz | Minimum frequency output 1 value. | 1 = 1 Hz |
| 15.37 | <i>Freq out 1 at src max</i> | <p>Defines the maximum value of frequency output 1 when 15.22 DO1 configuration is set to <i>Frequency output</i>. See also drawing at parameter 15.34 Freq out 1 src min.</p> | 16000 Hz |
| | 0 ... 16000 Hz | Maximum value of frequency output 1. | 1 = 1 Hz |
| | 0.000...11.000 V / 0.000...22.000 mA | Maximum output value of AO3 | 1000 = 1 |

| Serial number | Name/Value | Description | Def/FbEq16 |
|--------------------------------|-----------------------------------------|------------------------------------------------------------------------------------------------------------------------------------------------------------------------------------------------------------------------------------------------------------------------------------------------------------------------------------|------------|
| | 0.000...11.000 V / 0.000...22.000 mA | Maximum output value for AO4 | 1000 = 1 |
| 19 Operation mode | | Selection of local and external control location sources and operating modes. See also section <i>Operating modes of the drive</i> (page 66). | |
| 19.11 | <i>Ext1/Ext2 sel</i> | Displays the operation mode currently in use. | - |
| | EXT1 | EXT1 (permanently selected) | 0 |
| | EXT2 | EXT2 (permanently selected) | 1 |
| | FBA | A MCW bit 11 | 2 |
| | Timed function 1 | 34.01 Combined timer status bit 0 | 19 |
| | Timed function 2 | 34.01 Combined timer status bit 1 | 20 |
| | Timed function 3 | 34.01 Combined timer status bit 2 | 21 |
| | Monitor 1 | 32.01 Supervision status bit 0 | 25 |
| | Monitor 2 | 32.01 Supervision status bit 1 | 26 |
| | Monitor 3 | 32.01 Supervision status bit 2 | 27 |
| | EFB A MCW bit 11 | Control word bit 11 received through the embedded fieldbus interface. | 32 |
| | FBAA connection loss | FBA A connection loss | 33 |
| | EFB connection loss | EFB connection loss, <i>58.07</i> bit 10 of communication diagnosis. | 35 |
| | <i>Other</i> | Source selection (See <i>130 on page Terms and abbreviations</i>). | - |
| 19.17 | <i>Local control disable</i> | Enables/disables local control (start and stop buttons on the control panel, and the local controls on the PC tool).  Warning! Before disabling local control, make sure it's not necessary to use the control panel to stop the drive. | No |
| | No | Local control enabled. | 0 |
| | Yes | Local control disabled. | 1 |
| 20 Start/stop/direction | | Start/stop/direction and run/start/jog enable signal source selection; positive/negative reference enable signal source selection. For information on control locations, See <i>Local control vs. external control</i> section (page 63). | |

| Serial number | Name/Value | Description | Def/FbEq16 | | | | | | | | | | | | | | | |
|--------------------------------------------|--------------------------------------------|----------------------------------------------------------------------------------------------------------------------------------------------------------------------------------------------------------------------------------------------------------------------------------------------------------------------------------------------------------------------------------------------------------------------------------------------------------------------------------------------------------------------------------------------------------------------------------------------------------------------------------------------------------------------------------------------------------------------------------------------------------------------|---------------------------------------------|---------------------------|--------------------------------------------|----------|-----|----------|--------------------------------------------|---|---------------|---|--------------------------------------------|---------------------------|---|---|---------|---|
| 20.01 | <i>Ext1 commands</i> | Selects the source of start, stop and direction commands for external control location 1 (EXT1). See also parameter 20.02...20.05. See parameter 20.21 for the determination of the actual direction. | <i>in1 Start forward; in2 Start reverse</i> | | | | | | | | | | | | | | | |
| | Not selected | No start or stop command sources selected. | 0 | | | | | | | | | | | | | | | |
| | in1 Start | The source of the start and stop commands is selected by parameter 20.03 <i>Ext1 in1</i> . The state transitions of the source bit are interpreted as follows: <table border="1" data-bbox="352 395 700 502"> <thead> <tr> <th>State of source 1 (20.03)</th> <th>commands</th> </tr> </thead> <tbody> <tr> <td>0 -> 1 (20.02 = Edge) 1 (20.02 = Level)</td> <td>Start up</td> </tr> <tr> <td>0</td> <td>Stopped</td> </tr> </tbody> </table> | State of source 1 (20.03) | commands | 0 -> 1 (20.02 = Edge) 1 (20.02 = Level) | Start up | 0 | Stopped | 1 | | | | | | | | | |
| State of source 1 (20.03) | commands | | | | | | | | | | | | | | | | | |
| 0 -> 1 (20.02 = Edge) 1 (20.02 = Level) | Start up | | | | | | | | | | | | | | | | | |
| 0 | Stopped | | | | | | | | | | | | | | | | | |
| | in1 Start forward; in2 Start reverse | The source selected by parameter 20.03 <i>Ext1 in1</i> is the start signal; the source selected by parameter 20.04 <i>Ext1 in 2</i> determines the direction. The state transitions of the source bit are interpreted as follows: <table border="1" data-bbox="352 630 856 801"> <thead> <tr> <th>State of source 1 (20.03)</th> <th>State of source 2 (20.04)</th> <th>commands</th> </tr> </thead> <tbody> <tr> <td>0</td> <td>Any</td> <td>Stopped</td> </tr> <tr> <td rowspan="2">0 -> 1 (20.02 = Edge) 1 (20.02 = Level)</td> <td>0</td> <td>Start forward</td> </tr> <tr> <td>1</td> <td>Start and running reverse</td> </tr> </tbody> </table> | State of source 1 (20.03) | State of source 2 (20.04) | commands | 0 | Any | Stopped | 0 -> 1 (20.02 = Edge) 1 (20.02 = Level) | 0 | Start forward | 1 | Start and running reverse | 2 | | | | |
| State of source 1 (20.03) | State of source 2 (20.04) | commands | | | | | | | | | | | | | | | | |
| 0 | Any | Stopped | | | | | | | | | | | | | | | | |
| 0 -> 1 (20.02 = Edge) 1 (20.02 = Level) | 0 | Start forward | | | | | | | | | | | | | | | | |
| | 1 | Start and running reverse | | | | | | | | | | | | | | | | |
| | in1 Start forward; in2 Start reverse | The source selected by parameter 20.03 <i>Ext1 in1</i> is the forward start signal; the source selected by parameter 20.04 <i>Ext1 in 2</i> is the reverse start signal. The state transitions of the source bit are interpreted as follows: <table border="1" data-bbox="352 933 856 1157"> <thead> <tr> <th>State of source 1 (20.03)</th> <th>State of source 2 (20.04)</th> <th>commands</th> </tr> </thead> <tbody> <tr> <td>0</td> <td>0</td> <td>Stopped</td> </tr> <tr> <td>0 -> 1 (20.02 = Edge) 1 (20.02 = Level)</td> <td>0</td> <td>Start forward</td> </tr> <tr> <td>0</td> <td>0 -> 1 (20.02 = Edge) 1 (20.02 = Level)</td> <td>Start and running reverse</td> </tr> <tr> <td>1</td> <td>1</td> <td>Stopped</td> </tr> </tbody> </table> | State of source 1 (20.03) | State of source 2 (20.04) | commands | 0 | 0 | Stopped | 0 -> 1 (20.02 = Edge) 1 (20.02 = Level) | 0 | Start forward | 0 | 0 -> 1 (20.02 = Edge) 1 (20.02 = Level) | Start and running reverse | 1 | 1 | Stopped | 3 |
| State of source 1 (20.03) | State of source 2 (20.04) | commands | | | | | | | | | | | | | | | | |
| 0 | 0 | Stopped | | | | | | | | | | | | | | | | |
| 0 -> 1 (20.02 = Edge) 1 (20.02 = Level) | 0 | Start forward | | | | | | | | | | | | | | | | |
| 0 | 0 -> 1 (20.02 = Edge) 1 (20.02 = Level) | Start and running reverse | | | | | | | | | | | | | | | | |
| 1 | 1 | Stopped | | | | | | | | | | | | | | | | |
| | in1P Start; in2 Stop | The sources of the start and stop commands are selected by parameters 20.03 <i>Ext1 in1</i> and 20.04 <i>Ext1 in 2</i> . The state transitions of the source bit are interpreted as follows: <table border="1" data-bbox="352 1273 856 1372"> <thead> <tr> <th>State of source 1 (20.03)</th> <th>State of source 2 (20.04)</th> <th>commands</th> </tr> </thead> <tbody> <tr> <td>0 -> 1</td> <td>1</td> <td>Start up</td> </tr> <tr> <td>Any</td> <td>0</td> <td>Stopped</td> </tr> </tbody> </table> <p>Notes:</p> <ul style="list-style-type: none"> Parameter 20.02 <i>Ext1 start trigger</i> has no effect on this setting. When source 2 is 0, the Start and Stop keys on the control panel are disabled. | State of source 1 (20.03) | State of source 2 (20.04) | commands | 0 -> 1 | 1 | Start up | Any | 0 | Stopped | 4 | | | | | | |
| State of source 1 (20.03) | State of source 2 (20.04) | commands | | | | | | | | | | | | | | | | |
| 0 -> 1 | 1 | Start up | | | | | | | | | | | | | | | | |
| Any | 0 | Stopped | | | | | | | | | | | | | | | | |

| Serial number | Name/Value | Description | Def/FbEq16 | | | | | | | | | | | | | | | | |
|------------------------------|--------------------------------------------------|-------------------------------------------------------------------------------------------------------------------------------------------------------------------------------------------------------------------------------------------------------------------------------------------------------------------------------------------------------------------------------------------------------------------------------------------------------------------------------------------------------------------------------------------------------------------------------------------------------------------------------------------------------------------------------------------------------------------------------------------------------------------------------------------------------------------------------------------------------------------------------------------------------------------------------------------------------------------------------|------------------------------|------------------------------|------------------------------|----------|--------|-----|---|---------------|--------|--------|---|---------------------------|-----|-----|-----|---------|---|
| | in1P Start; in2 Stop; in3 Direction | <p>The sources of the start and stop commands are selected by parameters <i>20.03 Ext1 in1</i> and <i>20.04 Ext1 in2</i>. The source selected by parameter <i>20.05 Ext1 in3</i> determines the direction. The state transitions of the source bit are interpreted as follows:</p> <table border="1"> <thead> <tr> <th>State of source 1 (20.03)</th> <th>State of source 2 (20.04)</th> <th>State of source 3 (20.05)</th> <th>commands</th> </tr> </thead> <tbody> <tr> <td>0 -> 1</td> <td>1</td> <td>0</td> <td>Start forward</td> </tr> <tr> <td>0 -> 1</td> <td>1</td> <td>1</td> <td>Start and running reverse</td> </tr> <tr> <td>Any</td> <td>0</td> <td>Any</td> <td>Stopped</td> </tr> </tbody> </table> <p>Notes:</p> <ul style="list-style-type: none"> Parameter <i>20.02 Ext1 start trigger</i> has no effect on this setting. When source 2 is 0, the Start and Stop keys on the control panel are disabled. | State of source 1 (20.03) | State of source 2 (20.04) | State of source 3 (20.05) | commands | 0 -> 1 | 1 | 0 | Start forward | 0 -> 1 | 1 | 1 | Start and running reverse | Any | 0 | Any | Stopped | 5 |
| State of source 1 (20.03) | State of source 2 (20.04) | State of source 3 (20.05) | commands | | | | | | | | | | | | | | | | |
| 0 -> 1 | 1 | 0 | Start forward | | | | | | | | | | | | | | | | |
| 0 -> 1 | 1 | 1 | Start and running reverse | | | | | | | | | | | | | | | | |
| Any | 0 | Any | Stopped | | | | | | | | | | | | | | | | |
| | in1P Start forward; in2P Start reverse; in3 Stop | <p>The sources of the start and stop commands are selected by parameters <i>20.03 Ext1 in1</i>, <i>20.04 Ext1 in2</i> and <i>20.05 Ext1 in3</i>. The source selected by parameter <i>20.05 Ext1 in3</i> determines the direction. The state transitions of the source bit are interpreted as follows:</p> <table border="1"> <thead> <tr> <th>State of source 1 (20.03)</th> <th>State of source 2 (20.04)</th> <th>State of source 3 (20.05)</th> <th>commands</th> </tr> </thead> <tbody> <tr> <td>0 -> 1</td> <td>Any</td> <td>1</td> <td>Start forward</td> </tr> <tr> <td>Any</td> <td>0 -> 1</td> <td>1</td> <td>Start and running reverse</td> </tr> <tr> <td>Any</td> <td>Any</td> <td>0</td> <td>Stopped</td> </tr> </tbody> </table> <p>Note: Parameter <i>20.02 Ext1 start trigger</i> has no effect on this setting.</p> | State of source 1 (20.03) | State of source 2 (20.04) | State of source 3 (20.05) | commands | 0 -> 1 | Any | 1 | Start forward | Any | 0 -> 1 | 1 | Start and running reverse | Any | Any | 0 | Stopped | 6 |
| State of source 1 (20.03) | State of source 2 (20.04) | State of source 3 (20.05) | commands | | | | | | | | | | | | | | | | |
| 0 -> 1 | Any | 1 | Start forward | | | | | | | | | | | | | | | | |
| Any | 0 -> 1 | 1 | Start and running reverse | | | | | | | | | | | | | | | | |
| Any | Any | 0 | Stopped | | | | | | | | | | | | | | | | |
| | Control panel | The start and stop commands are taken from the control panel (or PC connected to the panel connector). | 11 | | | | | | | | | | | | | | | | |
| | Fieldbus A | The start and stop commands are taken from fieldbus adapter A. Note: Separately set <i>20.02 Ext1 start trigger</i> as <i>Level</i> . | 12 | | | | | | | | | | | | | | | | |
| | Embedded fieldbus | The start and stop commands are taken from the embedded fieldbus interface. Note: Separately set <i>20.02 Ext1 start trigger</i> as <i>Level</i> . | 14 | | | | | | | | | | | | | | | | |
| 20.02 | <i>Ext1 start trigger</i> | <p>Defines whether the start signal for external control location EXT1 is edge-triggered or level-triggered.</p> <p>Note: This parameter is not effective if a pulse-type start signal is selected. See the descriptions of the selections of parameter <i>20.01 Ext1 commands</i>.</p> | Level | | | | | | | | | | | | | | | | |
| | Edge | The start signal is edge-triggered. | 0 | | | | | | | | | | | | | | | | |
| | Level | The start signal is level-triggered. | 1 | | | | | | | | | | | | | | | | |

174 *Parameter*

| Serial number | Name/Value | Description | Def/FbEq16 |
|---------------|--------------------|------------------------------------------------------------------------------------------------------------------------------------|------------|
| 20.03 | <i>Ext1 in1</i> | Selected source 1 of parameter <i>20.01 Ext1 commands</i> . | DI1 |
| | Not selected | 0(always off). | 0 |
| | select | 1(always on). | 1 |
| | Timed function 1 | <i>34.01</i> Bit 0 of <i>Combined timer status</i> (See page 218). | 18 |
| | Timed function 2 | <i>34.01</i> Bit 1 of <i>Combined timer status</i> (See page 218). | 19 |
| | Timed function 3 | <i>34.01</i> Bit 2 of <i>Combined timer status</i> (See page 218). | 20 |
| | Monitor 1 | <i>32.01</i> Bit 0 of <i>Supervision status word</i> (See page 211). | 24 |
| | Monitor 2 | <i>32.01</i> Bit 1 of <i>Supervision status word</i> (See page 211). | 25 |
| | Monitor 3 | <i>32.01</i> Bit 2 of <i>Supervision status word</i> (See page 211). | 26 |
| | <i>Other [bit]</i> | Source selection (See <i>130 on page Terms and abbreviations</i>). | - |
| 20.04 | <i>Ext1 in 2</i> | Selected source 2 of parameter <i>20.01 Ext1 commands</i> . For the available selections, see parameter <i>20.03 Ext1 in1</i> . | DI2 |
| 20.05 | <i>Ext1 in3</i> | Selected source 3 of parameter <i>20.01 Ext1 commands</i> . For the available selections, see parameter <i>20.03 Ext1 in1</i> . | Off |

| Serial number | Name/Value | Description | Def/FbEq16 | | | | | | | | | | | | | | | |
|---------------------------|--------------------------------------------|-----------------------------------------------------------------------------------------------------------------------------------------------------------------------------------------------------------------------------------------------------------------------------------------------------------------------------------------------------------------------------------------------------------------------------------------------------------------------------------------------------------------------------------------------------------------------------------------------------------------------------------------------------------------------------------------------------------------------------------------------------|---------------------------|---------------------------|-----------------------|----------|-------------------|----------|-----------------------|---------|---------------|-------------------|--------------------------------------------|---------------------------|---|---|---------|---|
| 20.06 | <i>Ext2 commands</i> | Selects the source of start, stop and direction commands for external control location 2 (EXT1). See also parameter 20.07...20.10. See parameter 20.21 for the determination of the actual direction. | Off | | | | | | | | | | | | | | | |
| | Not selected | No start or stop command sources selected. | 0 | | | | | | | | | | | | | | | |
| | in1 Start | The source of the start and stop commands is selected by parameter 20.08 <i>Ext2 in 1</i> . The state transitions of the source bit are interpreted as follows: <table border="1" data-bbox="404 405 753 512"> <thead> <tr> <th>State of source 1 (20.08)</th> <th>commands</th> </tr> </thead> <tbody> <tr> <td>0 -> 1 (20.07 = Edge)</td> <td>Start up</td> </tr> <tr> <td>1 (20.07 = Level)</td> <td>Stopped</td> </tr> <tr> <td>0</td> <td>Stopped</td> </tr> </tbody> </table> | State of source 1 (20.08) | commands | 0 -> 1 (20.07 = Edge) | Start up | 1 (20.07 = Level) | Stopped | 0 | Stopped | 1 | | | | | | | |
| State of source 1 (20.08) | commands | | | | | | | | | | | | | | | | | |
| 0 -> 1 (20.07 = Edge) | Start up | | | | | | | | | | | | | | | | | |
| 1 (20.07 = Level) | Stopped | | | | | | | | | | | | | | | | | |
| 0 | Stopped | | | | | | | | | | | | | | | | | |
| | in1 Start forward; in2 Start reverse | The source selected by parameter 20.08 <i>Ext2 in 1</i> is the start signal; the source selected by parameter 20.09 <i>Ext2 in 2</i> determines the direction. The state transitions of the source bit are interpreted as follows: <table border="1" data-bbox="404 638 912 810"> <thead> <tr> <th>State of source 1 (20.08)</th> <th>State of source 2 (20.09)</th> <th>commands</th> </tr> </thead> <tbody> <tr> <td>0</td> <td>Any</td> <td>Stopped</td> </tr> <tr> <td>0 -> 1 (20.07 = Edge)</td> <td>0</td> <td>Start forward</td> </tr> <tr> <td>1 (20.07 = Level)</td> <td>1</td> <td>Start and running reverse</td> </tr> </tbody> </table> | State of source 1 (20.08) | State of source 2 (20.09) | commands | 0 | Any | Stopped | 0 -> 1 (20.07 = Edge) | 0 | Start forward | 1 (20.07 = Level) | 1 | Start and running reverse | 2 | | | |
| State of source 1 (20.08) | State of source 2 (20.09) | commands | | | | | | | | | | | | | | | | |
| 0 | Any | Stopped | | | | | | | | | | | | | | | | |
| 0 -> 1 (20.07 = Edge) | 0 | Start forward | | | | | | | | | | | | | | | | |
| 1 (20.07 = Level) | 1 | Start and running reverse | | | | | | | | | | | | | | | | |
| | in1 Start forward; in2 Start reverse | The source selected by parameter 20.08 <i>Ext2 in 1</i> is the forward start signal; the source selected by parameter 20.09 <i>Ext2 in 2</i> is the reverse start signal. The state transitions of the source bit are interpreted as follows: <table border="1" data-bbox="404 936 912 1158"> <thead> <tr> <th>State of source 1 (20.08)</th> <th>State of source 2 (20.09)</th> <th>commands</th> </tr> </thead> <tbody> <tr> <td>0</td> <td>0</td> <td>Stopped</td> </tr> <tr> <td>0 -> 1 (20.07 = Edge)</td> <td>0</td> <td>Start forward</td> </tr> <tr> <td>0</td> <td>0 -> 1 (20.07 = Edge) 1 (20.07 = Level)</td> <td>Start and running reverse</td> </tr> <tr> <td>1</td> <td>1</td> <td>Stopped</td> </tr> </tbody> </table> | State of source 1 (20.08) | State of source 2 (20.09) | commands | 0 | 0 | Stopped | 0 -> 1 (20.07 = Edge) | 0 | Start forward | 0 | 0 -> 1 (20.07 = Edge) 1 (20.07 = Level) | Start and running reverse | 1 | 1 | Stopped | 3 |
| State of source 1 (20.08) | State of source 2 (20.09) | commands | | | | | | | | | | | | | | | | |
| 0 | 0 | Stopped | | | | | | | | | | | | | | | | |
| 0 -> 1 (20.07 = Edge) | 0 | Start forward | | | | | | | | | | | | | | | | |
| 0 | 0 -> 1 (20.07 = Edge) 1 (20.07 = Level) | Start and running reverse | | | | | | | | | | | | | | | | |
| 1 | 1 | Stopped | | | | | | | | | | | | | | | | |
| | in1P Start; in2 Stop | The sources of the start and stop commands are selected by parameters 20.08 <i>Ext2 in 1</i> and 20.09 <i>Ext2 in 2</i> . The state transitions of the source bit are interpreted as follows: <table border="1" data-bbox="404 1259 912 1361"> <thead> <tr> <th>State of source 1 (20.08)</th> <th>State of source 2 (20.09)</th> <th>commands</th> </tr> </thead> <tbody> <tr> <td>0 -> 1</td> <td>1</td> <td>Start up</td> </tr> <tr> <td>Any</td> <td>0</td> <td>Stopped</td> </tr> </tbody> </table> <p>Notes:</p> <ul style="list-style-type: none"> Parameter 20.07 <i>Ext2 start trigger</i> has no effect on this setting. When source 2 is 0, the Start and Stop keys on the control panel are disabled. | State of source 1 (20.08) | State of source 2 (20.09) | commands | 0 -> 1 | 1 | Start up | Any | 0 | Stopped | 4 | | | | | | |
| State of source 1 (20.08) | State of source 2 (20.09) | commands | | | | | | | | | | | | | | | | |
| 0 -> 1 | 1 | Start up | | | | | | | | | | | | | | | | |
| Any | 0 | Stopped | | | | | | | | | | | | | | | | |

| Serial number | Name/Value | Description | Def/FbEq16 | | | | | | | | | | | | | | | | |
|---------------------------------------------|--------------------------------------------------|----------------------------------------------------------------------------------------------------------------------------------------------------------------------------------------------------------------------------------------------------------------------------------------------------------------------------------------------------------------------------------------------------------------------------------------------------------------------------------------------------------------------------------------------------------------------------------------------------------------------------------------------------------------------------------------------------------------------------------------------------------------------------------------------------------------------------------------------------------------------------------------------------------------------------------------------------------------------------------------------------------------------------------------------------------|---------------------------------------------|---------------------------------------------|---------------------------------------------|----------|--------|-----|---|---------------|--------|--------|---|---------------------------|-----|-----|-----|---------|---|
| | in1P Start; in2 Stop; in3 Direction | <p>The sources of the start and stop commands are selected by parameters 20.08 Ext2 in 1 and 20.09 Ext2 in 2. The source selected by parameter 20.10 Ext2 in 3 determines the direction. The state transitions of the source bit are interpreted as follows:</p> <table border="1"> <thead> <tr> <th>State of source 1 (20.08)</th> <th>State of source 2 (20.09)</th> <th>State of source 3 (20.10)</th> <th>commands</th> </tr> </thead> <tbody> <tr> <td>0 -> 1</td> <td>1</td> <td>0</td> <td>Start forward</td> </tr> <tr> <td>0 -> 1</td> <td>1</td> <td>1</td> <td>Start and running reverse</td> </tr> <tr> <td>Any</td> <td>0</td> <td>Any</td> <td>Stopped</td> </tr> </tbody> </table> <p>Notes:</p> <ul style="list-style-type: none"> Parameter 20.07 Ext2 start trigger has no effect on this setting. When source 2 is 0, the Start and Stop keys on the control panel are disabled. | State of source 1 (20.08) | State of source 2 (20.09) | State of source 3 (20.10) | commands | 0 -> 1 | 1 | 0 | Start forward | 0 -> 1 | 1 | 1 | Start and running reverse | Any | 0 | Any | Stopped | 5 |
| State of source 1 (20.08) | State of source 2 (20.09) | State of source 3 (20.10) | commands | | | | | | | | | | | | | | | | |
| 0 -> 1 | 1 | 0 | Start forward | | | | | | | | | | | | | | | | |
| 0 -> 1 | 1 | 1 | Start and running reverse | | | | | | | | | | | | | | | | |
| Any | 0 | Any | Stopped | | | | | | | | | | | | | | | | |
| | in1P Start forward; in2P Start reverse; in3 Stop | <p>The sources of the start and stop commands are selected by parameters 20.08 Ext2 in 1, 20.09 Ext2 in 2 and 20.10 Ext2 in 3. The source selected by parameter 20.10 Ext2 in 3 determines the direction. The state transitions of the source bit are interpreted as follows:</p> <table border="1"> <thead> <tr> <th>State of source 1 (20.08)</th> <th>State of source 2 (20.09)</th> <th>State of source 3 (20.10)</th> <th>commands</th> </tr> </thead> <tbody> <tr> <td>0 -> 1</td> <td>Any</td> <td>1</td> <td>Start forward</td> </tr> <tr> <td>Any</td> <td>0 -> 1</td> <td>1</td> <td>Start and running reverse</td> </tr> <tr> <td>Any</td> <td>Any</td> <td>0</td> <td>Stopped</td> </tr> </tbody> </table> <p>Note: Parameter 20.07 Ext2 start trigger has no effect on this setting.</p> | State of source 1 (20.08) | State of source 2 (20.09) | State of source 3 (20.10) | commands | 0 -> 1 | Any | 1 | Start forward | Any | 0 -> 1 | 1 | Start and running reverse | Any | Any | 0 | Stopped | 6 |
| State of source 1 (20.08) | State of source 2 (20.09) | State of source 3 (20.10) | commands | | | | | | | | | | | | | | | | |
| 0 -> 1 | Any | 1 | Start forward | | | | | | | | | | | | | | | | |
| Any | 0 -> 1 | 1 | Start and running reverse | | | | | | | | | | | | | | | | |
| Any | Any | 0 | Stopped | | | | | | | | | | | | | | | | |
| | Control panel | The start and stop commands are taken from the control panel (or PC connected to the panel connector). | 11 | | | | | | | | | | | | | | | | |
| | Fieldbus A | The start and stop commands are taken from fieldbus adapter A. Note: Separately set 20.07 Ext2 start trigger as <i>Level</i> . | 12 | | | | | | | | | | | | | | | | |
| | Embedded fieldbus | The start and stop commands are taken from the embedded fieldbus interface. Note: Separately set 20.07 Ext2 start trigger as <i>Level</i> . | 14 | | | | | | | | | | | | | | | | |
| 20.07 | Ext2 start trigger | <p>Defines whether the start signal for external control location EXT2 is edge-triggered or level-triggered.</p> <p>Note: This parameter is not effective if a pulse-type start signal is selected. See the descriptions of the selections of parameter 20.06 Ext2 commands.</p> | <i>Level</i> | | | | | | | | | | | | | | | | |
| | Edge | The start signal is edge-triggered. | 0 | | | | | | | | | | | | | | | | |
| | Level | The start signal is level-triggered. | 1 | | | | | | | | | | | | | | | | |
| 20.08 | Ext2 in 1 | <p>Selected source 1 of parameter 20.06 Ext2 commands.</p> <p>For the available selections, see parameter 20.03 Ext1 in1.</p> | <i>Off</i> | | | | | | | | | | | | | | | | |

| Serial number | Name/Value | Description | Def/FbEq16 |
|---------------|-----------------------------|----------------------------------------------------------------------------------------------------------------------------------------------------------------------------------------------------------------------------------------------------------------------------------------------------------------------------------------------------------------------------------------------------------------------------------|------------|
| 20.09 | <i>Ext2 in 2</i> | Selected source 2 of parameter 20.06 Ext2 commands . For the available selections, see parameter 20.03 Ext1 in1 . | Off |
| 20.10 | <i>Ext2 in 3</i> | Selected source 3 of parameter 20.06 Ext2 commands . For the available selections, see parameter 20.03 Ext1 in1 . | Off |
| 20.11 | <i>Run enable stop mode</i> | Selects the way the motor is stopped when the run enable signal switches off. The source of the run enable signal is selected by parameter 20.12 Run enable 1 source . | Coast |
| | Coast | Stop by switching off the output semiconductors of the drive. The motor coasts to a stop.  Warning! If a mechanical brake is used, ensure it is safe to stop the converter by coasting. | 0 |
| | Ramp to stopped | Stop along the active deceleration ramp. | 1 |
| 20.12 | <i>Run enable 1 source</i> | Selects the source of the external run enable signal. If the run enable signal is switched off, the drive will not start. If already running, the drive will stop according to the setting of parameter 20.11 Run enable stop mode . 1 = Run enable signal on. Note: The parameter cannot be changed while the drive is running. See also parameter 20.19 Enable start command . | Select |
| | Not selected | 0. | 0 |
| | Select | 1. | 1 |
| | Timed function 1 | 34.01 Bit 0 of <i>Combined timer status</i> (See page 218). | 18 |
| | Timed function 2 | 34.01 Bit 1 of <i>Combined timer status</i> (See page 218). | 19 |
| | Timed function 3 | 34.01 Bit 2 of <i>Combined timer status</i> (See page 218). | 20 |
| | Monitor 1 | 32.01 Bit 0 of <i>Supervision status word</i> (See page 211). | 24 |
| | Monitor 2 | 32.01 Bit 1 of <i>Supervision status word</i> (See page 211). | 25 |
| | Monitor 3 | 32.01 Bit 2 of <i>Supervision status word</i> (See page 211). | 26 |
| | FBA A MCW bit 3 | Control word bit 3 received through fieldbus interface A. | 30 |
| | EFB MCW bit 3 | Control word bit 3 received through the embedded fieldbus interface. | 32 |
| | <i>Other [bit]</i> | Source selection (See 130 on page Terms and abbreviations). | - |

| Serial number | Name/Value | Description | Def/FbEq16 |
|---------------|-----------------------------|--------------------------------------------------------------------------------------------------------------------------------------------------------------------------------------------------------------------------------------------------------------------|------------|
| 20.19 | <i>Enable start command</i> | Selects source for Run enable. 1 = Start enable. With the signal switched off, any drive start command is inhibited. (Switching the signal off while the drive is running will not stop the drive.) See also parameter <i>20.12 Run enable 1 source</i> . | Select |
| | Not selected | 0. | 0 |
| | Select | 1. | 1 |
| | Timed function 1 | <i>34.01</i> Bit 0 of <i>Combined timer status</i> (See page 218). | 18 |
| | Timed function 2 | <i>34.01</i> Bit 1 of <i>Combined timer status</i> (See page 218). | 19 |
| | Timed function 3 | <i>34.01</i> Bit 2 of <i>Combined timer status</i> (See page 218). | 20 |
| | Monitor 1 | <i>32.01</i> Bit 0 of <i>Supervision status word</i> (See page 211). | 24 |
| | Monitor 2 | <i>32.01</i> Bit 1 of <i>Supervision status word</i> (See page 211). | 25 |
| | Monitor 3 | <i>32.01</i> Bit 2 of <i>Supervision status word</i> (See page 211). | 26 |
| | <i>Other [bit]</i> | Source selection (See <i>130 on page Terms and abbreviations</i>). | - |
| 20.21 | <i>Direction</i> | Reference direction lock. | <i>Off</i> |
| | Request | In external control the direction is selected by a direction command (parameter <i>20.01 Ext1 commands</i> or <i>20.06 Ext2 commands</i>). The motor rotates in the direction of the reference. If no direction command is defined, the motor rotates forward | 0 |
| | Forward | Motor rotates forward regardless of the sign of the external reference. (Negative reference values are replaced by zero. Positive reference values are used as is. | 1 |
| | Reverse | Motor rotates reverse regardless of the sign of the external reference. (Negative reference values are replaced by zero. Positive reference values are multiplied by -1. | 2 |
| 20.22 | <i>Enable to rotate</i> | Selected source 1 of parameter <i>20.01 Ext1 commands</i> . | Select |
| | Not selected | 0(always off). | 0 |
| | Select | 1(always on). | 1 |
| | Timed function 1 | <i>34.01</i> Timed function status bit 0 (See page 154) | 18 |
| | Timed function 2 | <i>34.01</i> Timed function status bit 1 (See page 154) | 19 |
| | Timed function 3 | <i>34.01</i> Timed function status bit 2 (See page 154) | 20 |
| | Monitor 1 | Bit 0 of <i>32.01</i> Supervision status (See page 149) | 24 |
| | Monitor 2 | Bit 1 of <i>32.01</i> Supervision status (See page 149) | 25 |
| | Monitor 3 | Bit 2 of <i>32.01</i> Supervision status (See page 149) | 26 |
| | <i>Other [bit]</i> | Source selection (See <i>130 on page Terms and abbreviations</i>). | - |

| Serial number | Name/Value | Description | Def/FbEq16 |
|---------------|-------------------------------|----------------------------------------------------------------------------------------------------------------------------------------------------------------------------------------------------------------------------------------------------------------------------------------------------------------------------------------------------------------------------------------------------------------------------------------------------------------------------------------------------------------------------------------------------------------------------------------------------------------------------------------------------------------------------------------------------------------------------------------------------------|---------------------|
| 20.25 | <i>Jogging enable</i> | <p>Selects the source for a jog enable signal. (The sources for jogging activation signals are selected by parameters 20.26 Jogging 1 start source and 20.27 Jogging 2 start source.)</p> <p>1 = Jogging is enabled. 0 = Jogging is disabled.</p> <p>Notes:</p> <ul style="list-style-type: none"> Jogging is supported in vector control mode only. Jogging can be enabled only when no start command from an external control location is active. On the other hand, if jogging is already enabled, the drive cannot be started from an external control location (apart from inching commands through fieldbus). See section Rush control (page 177). | <i>Not selected</i> |
| | Not selected | 0. | 0 |
| | Selected | 1. | 1 |
| | Reserved | | 8...17 |
| | Timed function 1 | Bit 0 of 34.01 Combined timer status (see page 218). | 18 |
| | Timed function 2 | Bit 1 of 34.01 Combined timer status (see page 218). | 19 |
| | Timed function 3 | Bit 2 of 34.01 Combined timer status (see page 218). | 20 |
| | Reserved | | 21...23 |
| | Supervision 1 | Bit 0 of 32.01 Supervision status word (see page 211). | 24 |
| | Supervision 2 | Bit 1 of 32.01 Supervision status word (see page 211). | 25 |
| | Supervision 3 | Bit 2 of 32.01 Supervision status word (see page 211). | 26 |
| | <i>Other [bit]</i> | Source selection (see Terms and abbreviations on page 130). | - |
| 20.26 | <i>Jogging 1 start source</i> | <p>If enabled by parameter 20.25 Jogging enable, selects the source for the activation of jogging function 1. (Jogging function 1 can also be activated through fieldbus regardless of parameter 20.25.)</p> <p>1 = Jogging 1 active.</p> <p>Notes:</p> <ul style="list-style-type: none"> Jogging is supported in vector control mode only. If both jogging 1 and 2 are activated, the one that was activated first has priority. This parameter cannot be changed while the drive is running. | <i>Not selected</i> |
| | Not selected | 0. | 0 |
| | Selected | 1. | 1 |
| | Reserved | | 8...17 |
| | Timed function 1 | Bit 0 of 34.01 Combined timer status (see page 218). | 18 |
| | Timed function 2 | Bit 1 of 34.01 Combined timer status (see page 218). | 19 |
| | Timed function 3 | Bit 2 of 34.01 Combined timer status (see page 218). | 20 |
| | Reserved | | 21...23 |
| | Supervision 1 | Bit 0 of 32.01 Supervision status word (see page 211). | 24 |
| | Supervision 2 | Bit 1 of 32.01 Supervision status word (see page 211). | 25 |
| | Supervision 3 | Bit 2 of 32.01 Supervision status word (see page 211). | 26 |

| Serial number | Name/Value | Description | Def/FbEq16 | | | | | | | | | | | | |
|---------------|-----------------------------------------------------------------------------------------------------------------------------------------------------------------------------------------------------------------------------------------------------------------------------------------------------------------------------------------------------------------------------------------------------------------------|---------------------------------------------------------------------------------------------------------------------------------------------------------------------------------------------------------------------------------------------------------------------------------------------------------------------------------------------------------------------------------------------------------------------------------------------------------------------------------------------------------------------------------------------------------------------------------------------------------------------|---------------------|-----|------|-------------|---|------------------|---------------------------------------------------------|---|--------------------|-----------------------------------------------------------|--------|----------|--|
| | <i>Other [bit]</i> | Source selection (see <i>Terms and abbreviations</i> on page 130). | - | | | | | | | | | | | | |
| 20.27 | <i>Jogging 2 start source</i> | If enabled by parameter <i>20.25 Jogging enable</i> , selects the source for the activation of jogging function 2. (Jogging function 2 can also be activated through fieldbus regardless of parameter <i>20.25</i> .) 1 = Jogging 2 active. For the selections, see parameter <i>20.26 Jogging 1 start source</i> . Notes: <ul style="list-style-type: none"> Jogging is supported in vector control mode only. If both jogging 1 and 2 are activated, the one that was activated first has priority. This parameter cannot be changed while the drive is running. | <i>Not selected</i> | | | | | | | | | | | | |
| 20.28 | <i>Remote to local action</i> | Select the action to take when the drive switches between remote and local control modes. | <i>Keep running</i> | | | | | | | | | | | | |
| | Keep running | The drive will continue to run when the user presses the <i>Loc/Rem</i> button on the control panel or the Drive Composer PC tool. | 0 | | | | | | | | | | | | |
| | Stop | The drive will stop when the user presses the <i>Loc/Rem</i> button on the control panel or the Drive Composer PC tool. | 1 | | | | | | | | | | | | |
| 20.30 | <i>Enable signal warning function</i> | Selects enable signal warnings to be suppressed. This parameter can be used to prevent these warnings from flooding the event log. Whenever a bit of this parameter is set to 1, the corresponding warning is suppressed. | 0000h | | | | | | | | | | | | |
| | <table border="1"> <thead> <tr> <th>Bit</th> <th>Name</th> <th>Description</th> </tr> </thead> <tbody> <tr> <td>0</td> <td>Enable to rotate</td> <td>1 = Warning <i>AFED Enable to rotate</i> is suppressed.</td> </tr> <tr> <td>1</td> <td>Run enable missing</td> <td>1 = Warning <i>AFEB Run enable missing</i> is suppressed.</td> </tr> <tr> <td>3...15</td> <td>Reserved</td> <td></td> </tr> </tbody> </table> | | | Bit | Name | Description | 0 | Enable to rotate | 1 = Warning <i>AFED Enable to rotate</i> is suppressed. | 1 | Run enable missing | 1 = Warning <i>AFEB Run enable missing</i> is suppressed. | 3...15 | Reserved | |
| Bit | Name | Description | | | | | | | | | | | | | |
| 0 | Enable to rotate | 1 = Warning <i>AFED Enable to rotate</i> is suppressed. | | | | | | | | | | | | | |
| 1 | Run enable missing | 1 = Warning <i>AFEB Run enable missing</i> is suppressed. | | | | | | | | | | | | | |
| 3...15 | Reserved | | | | | | | | | | | | | | |
| | 0000h...FFFFh | Word for disabling enable signal warnings. | 1 = 1 | | | | | | | | | | | | |

| Serial number | Name/Value | Description | Def/FbEq16 | | | | | | | | | | |
|---------------------------|---------------------------|---------------------------------------------------------------------------------------------------------------------------------------------------------------------------------------------------------------------------------------------------------------------------------------------------------------------------------------------------------------------------------------------------------------------------------------------------------------------------------------------------------------------------------------------------------------------------------------------------------------------------------------------------------------------------------------------------------------------------------------------------------------------------------------------------------------------------------------------------------------------------------------------------------------------------------------------------------|---------------------|---------------------------|--------|----------------|------------|-----------------|--------------|------------------|----------------|-------------------|--------|
| 21 Start/stop mode | | Start and stop modes; emergency stop mode and signal source selection; DC magnetization settings. | | | | | | | | | | | |
| 21.02 | <i>Magnetization time</i> | <p>Defines the pre-magnetization time when:</p> <ul style="list-style-type: none"> parameter 21.19 Scalar start mode is set to <i>Constant time</i> (in scalar control mode). <p>After the start command, the drive automatically premagnetizes the motor for the set time. To ensure full magnetizing, set this parameter to the same value as, or higher than, the rotor time constant. If not known, use the rule-of-thumb value given in the table below:</p> <table border="1"> <thead> <tr> <th>Motor nominal power</th> <th>Constant magnetizing time</th> </tr> </thead> <tbody> <tr> <td>< 1 kW</td> <td>≥ 50 to 100 ms</td> </tr> <tr> <td>1 to 10 kW</td> <td>≥ 100 to 200 ms</td> </tr> <tr> <td>10 to 200 kW</td> <td>≥ 200 to 1000 ms</td> </tr> <tr> <td>200 to 1000 kW</td> <td>≥ 1000 to 2000 ms</td> </tr> </tbody> </table> <p>Note: The parameter cannot be changed while the drive is running.</p> | Motor nominal power | Constant magnetizing time | < 1 kW | ≥ 50 to 100 ms | 1 to 10 kW | ≥ 100 to 200 ms | 10 to 200 kW | ≥ 200 to 1000 ms | 200 to 1000 kW | ≥ 1000 to 2000 ms | 500 ms |
| Motor nominal power | Constant magnetizing time | | | | | | | | | | | | |
| < 1 kW | ≥ 50 to 100 ms | | | | | | | | | | | | |
| 1 to 10 kW | ≥ 100 to 200 ms | | | | | | | | | | | | |
| 10 to 200 kW | ≥ 200 to 1000 ms | | | | | | | | | | | | |
| 200 to 1000 kW | ≥ 1000 to 2000 ms | | | | | | | | | | | | |
| | 0...10000 ms | Constant DC magnetizing time. | 1 = 1 ms | | | | | | | | | | |
| 21.03 | <i>Stop mode</i> | Selects the way the motor is stopped when a stop command is received. | Coast | | | | | | | | | | |
| | Coast | <p>Stop by switching off the output semiconductors of the drive. The motor coasts to a stop.</p> <p> Warning! If a mechanical brake is used, ensure it is safe to stop the converter by coasting.</p> | 0 | | | | | | | | | | |
| | Ramp to stopped | Stop along the active deceleration ramp. | 1 | | | | | | | | | | |

| Serial number | Name/Value | Description | Def/FbEq16 |
|---------------|------------------------------|-----------------------------------------------------------------------------------------------------------------------------------------------------------------------------------------------------------------------------------------------------------------------------------------------------------------------------------------------------------------------------------------------------------------------------------------------------------------------------------------------------------------------------------------|------------------------|
| 21.04 | <i>Emergency stop mode</i> | Selects the way the motor is stopped when an emergency stop command is received. The source of the emergency stop signal is selected by parameter <i>21.05 Emergency stop source</i> . | Ramp to stopped (Off1) |
| | Ramp to stopped (Off1) | With the drive running: <ul style="list-style-type: none"> • 1 = Normal operation. • 0 = Normal stop along the standard deceleration ramp defined for the particular reference type (See section <i>Reference ramping</i> (page 68)). After the drive has stopped, it can be restarted by removing the emergency stop signal and switching the start signal from 0 to 1. With the drive stopped: <ul style="list-style-type: none"> • 1 = Starting allowed. • 0 = Starting not allowed. | 0 |
| | Coast stop (Off2) | With the drive running: <ul style="list-style-type: none"> • 1 = Normal operation. • 0 = Stop by coasting. The drive can be restarted by restoring the start interlock signal and switching the start signal from 0 to 1. With the drive stopped: <ul style="list-style-type: none"> • 1 = Starting allowed. • 0 = Starting not allowed. | 1 |
| | Eme ramp stop (Off3) | With the drive running: <ul style="list-style-type: none"> • 1 = Normal operation • 0 = Stop by ramping along emergency stop ramp defined by parameter <i>23.23 Emergency stop time</i>. After the drive has stopped, it can be restarted by removing the emergency stop signal and switching the start signal from 0 to 1. With the drive stopped: <ul style="list-style-type: none"> • 1 = Starting allowed • 0 = Starting not allowed | 2 |
| 21.05 | <i>Emergency stop source</i> | Selects the source of the emergency stop signal. The stop mode is selected by parameter <i>21.04 Emergency stop mode</i> . 0 = emergency stop active 1 = Normal operation Note: The parameter cannot be changed while the drive is running. | Inactive (true) |
| | Active (false) | 0. | 0 |
| | Inactive (true) | 1. | 1 |
| | <i>Other [bit]</i> | Source selection (See <i>130 on page Terms and abbreviations</i>). | - |
| 21.06 | <i>Zero speed limit</i> | Defines the zero speed limit. The motor is stopped along a speed ramp (when ramped stop is selected or emergency stop time is used) until the defined zero speed limit is reached. After the zero speed delay, the motor coasts to a stop. | 30.00 rpm |
| | 0.00...30000.00 rpm | Zero speed limit. | See par. <i>46.01</i> |

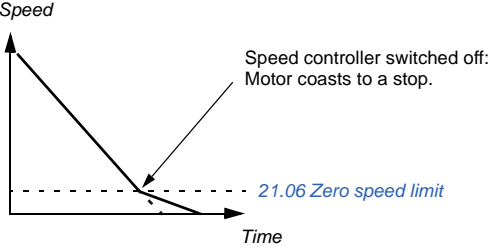
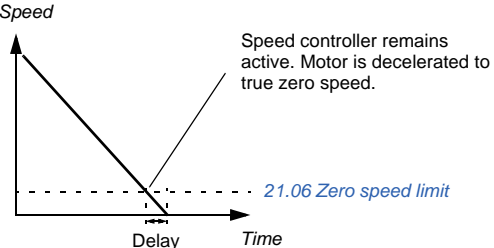
| Serial number | Name/Value | Description | Def/FbEq16 |
|---------------|-------------------------|-------------------------------------------------------------------------------------------------------------------------------------------------------------------------------------------------------------------------------------------------------------------------------------------------------------------------------------------------------------------------------------------------------------------------------------------------------------------------------------------------------------------------------------------------------------|------------|
| 21.07 | <i>Zero speed delay</i> | <p>Defines the delay for the zero speed delay function. The function is useful in applications where a smooth and quick restarting is essential. During the delay, the drive knows the rotor position accurately.</p> | 0 ms |
| | | <p><u>Without zero speed delay:</u> The drive receives a stop command and decelerates along a ramp. When actual motor speed falls below the value of parameter <i>21.06 Zero speed limit</i>, inverter modulation is stopped and the motor coasts to a standstill.</p>  | |
| | | <p><u>With zero speed delay:</u> The drive receives a stop command and decelerates along a ramp. When actual motor speed falls below the value of parameter <i>21.06 Zero speed limit</i>, the zero speed delay function activates. During the delay the function keeps the speed controller live: the inverter modulates, motor is magnetized and the drive is ready for a quick restart. Zero speed delay can be used, for example, with the jogging function.</p>  | |
| | 0...30000 ms | Zero speed delay. | 1 = 1 ms |

| Serial number | Name/Value | Description | Def/FbEq16 | | | | | | |
|---------------|-------------------------------------------------------------------------------------------------------------------------------------------------------------------------------------------------------------------------------------------------------------------------------------------------------------------------------------------------|------------------------------------------------------------------------------------------------------------------------------------------------------------------------------------------------------------------------------------------------------------------------------------------------------------------------------------------------------------------------------------------------------------------------------------------------|------------|--------|-------|---|-------------------------------------------------------------------------------------------------------------------------------------------------------------|--------|---------|
| 21.08 | <i>DC current control</i> | Activates/deactivates the DC hold and post-magnetization functions. See section <i>DC magnetization</i> page 70). Note: DC magnetization causes the motor to heat up. In applications where long DC magnetization times are required, externally ventilated motors should be used. If the DC magnetization period is long, DC magnetization cannot prevent the motor shaft from rotating if a constant load is applied to the motor. | 00b | | | | | | |
| | <table border="1"> <thead> <tr> <th>Bit(s)</th> <th>Value</th> </tr> </thead> <tbody> <tr> <td>0</td> <td>1 = DC hold. See section <i>Mechanical brake control</i> (page 79). Note: The DC hold function has no effect if the start signal is switched off.</td> </tr> <tr> <td>1...15</td> <td>Reserve</td> </tr> </tbody> </table> | | | Bit(s) | Value | 0 | 1 = DC hold. See section <i>Mechanical brake control</i> (page 79). Note: The DC hold function has no effect if the start signal is switched off. | 1...15 | Reserve |
| Bit(s) | Value | | | | | | | | |
| 0 | 1 = DC hold. See section <i>Mechanical brake control</i> (page 79). Note: The DC hold function has no effect if the start signal is switched off. | | | | | | | | |
| 1...15 | Reserve | | | | | | | | |
| | 00b...11b | DC magnetization selection. | 1 = 1 | | | | | | |
| 21.10 | <i>DC current reference</i> | Defines the DC hold current in percent of the motor nominal current. See parameter 21.08 <i>DC current control</i> , and <i>DC magnetization</i> section (on page 70). | 30.0% | | | | | | |
| | 0.0...100.0% | DC hold current. | 1 = 1% | | | | | | |
| 21.11 | <i>Post magnetization time</i> | Defines the length of time for which post-magnetization is active after stopping the motor. The magnetization current is defined by parameter 21.10 <i>DC current reference</i> . See parameter 21.08 <i>DC current control</i> . | 0 s | | | | | | |
| | 0...3000 s | Post-magnetization time. | 1 = 1 s | | | | | | |
| 21.14 | <i>Pre-heating input source</i> | Selects the source for triggering pre-heating for the motor. The status of the pre-heating is shown as bit 2 of 06.20 <i>Drive status word 3</i> . Note: <ul style="list-style-type: none"> The heating function requires that run enable, interlock and STO signals are active. The heating function requires that the drive is not faulted. Pre-heating uses DC hold to produce current. | Off | | | | | | |
| | Off | 0. Pre-heating is always deactivated. | 0 | | | | | | |
| | Open | 1. Pre-heating is always activated when the drive is stopped. | 1 | | | | | | |
| | Monitor 1 | 32.01 Bit 0 of <i>Supervision status word</i> (See page 211). | 8 | | | | | | |
| | Monitor 2 | 32.01 Bit 1 of <i>Supervision status word</i> (See page 211). | 9 | | | | | | |
| | Monitor 3 | 32.01 Bit 2 of <i>Supervision status word</i> (See page 211). | 10 | | | | | | |
| | Timed function 1 | 34.01 Bit 0 of <i>Combined timer status</i> (See page 218). | 11 | | | | | | |
| | Timed function 2 | 34.01 Bit 1 of <i>Combined timer status</i> (See page 218). | 12 | | | | | | |
| | Timed function 3 | 34.01 Bit 2 of <i>Combined timer status</i> (See page 218). | 13 | | | | | | |
| | <i>Other [bit]</i> | Source selection (See 130 on page <i>Terms and abbreviations</i>). | - | | | | | | |
| 21.15 | <i>Pre-heating time delay</i> | Defines the time delay before pre-heating starts after the drive is stopped. | 60 s | | | | | | |
| | 10...3000 s | Pre-heating time delay. | 1 = 1 s | | | | | | |
| 21.16 | <i>Pre-heating current</i> | Defines the DC current used to heat motor findings. | 0.0% | | | | | | |
| | 0.0...30.0% | Pre-heating current. | 1 = 1% | | | | | | |

| Serial number | Name/Value | Description | Def/FbEq16 |
|---------------|--------------------------|-------------------------------------------------------------------------------------------------------------------------------------------------------------------------------------------------------------------------------------------------------------------------------------------------------------------------------------------------------------------------------------------------------------------------------------------------------------------------------------------------------------------------------------------------------------------------------------------------------------------------------------------------------------------------------------------------------------------------------------------------------------------------------------------------------------------------------------------------------------------------------------------------------|------------|
| 21.18 | <i>Auto restart time</i> | The motor can be automatically started after a short supply power failure using the automatic restart function. When this parameter is set to 0.0 seconds, automatic restarting is disabled. Otherwise, the parameter defines the maximum duration of the power failure after which restarting is attempted. Note that this time also includes the DC pre-charging delay. | 10.0 s |
| | 0.0 s | Automatic restarting disabled. | 0 |
| | 0.1...10.0 s | Maximum power failure duration. | 1 = 1 s |
| 21.19 | <i>Scalar start mode</i> | Selects the motor start function for the scalar motor control mode, ie. when <i>99.04 Motor control mode</i> is set to <i>Scalar</i> . Notes: <ul style="list-style-type: none"> The parameter cannot be changed while the drive is running. See also section <i>DC magnetization</i> (page 70). | Normal |
| | Normal | Immediate start from zero speed. | 0 |
| | Constant time | Drive pre-magnetizes the motor before start. The pre-magnetizing time is defined by parameter <i>21.02 Magnetization time</i> . This mode should be selected if constant pre-magnetizing time is required (for example, if the motor start must be synchronized with the release of a mechanical brake). This setting also guarantees the highest possible break-away torque when the pre-magnetizing time is set long enough. Note: This mode cannot be used to start into a rotating motor.  Warning! The drive will start after the set magnetizing time has passed even if motor magnetization is not completed. In applications where a full break-away torque is essential, ensure that the constant magnetizing time is long enough to allow generation of full magnetization and torque. | 1 |
| | Automatic | The drive automatically selects the correct output frequency to start a rotating motor. This is useful for flying starts: if the motor is already rotating, the drive will start smoothly at the current frequency. Note: Cannot be used in multimotor systems. | 2 |
| | Torque boost | Select the automatic torque boost mode. The feature is necessary in drives with high starting torque. Torque boost is only applied at start, ending when the output frequency exceeds 20Hz or when output frequency is equal to reference. | |
| | Automatic + boost | Select both automatic and torque boost features. The track starting procedure is performed firstly and the motor is magnetized. If the speed is found to be zero, the torque boost shall be started | |
| 21.21 | <i>DC hold frequency</i> | Define DC hold frequency (it is used when the motor is under scalar frequency mode). See parameter <i>21.08 DC current control</i> , and <i>DC hold</i> section (on page 70). | 5.00 Hz |
| | 0.00...1000.00 Hz | DC hold frequency. | 1 = 1 Hz |

| Serial number | Name/Value | Description | Def/FbEq16 |
|---------------|--------------------------------------|--------------------------------------------------------------------------------------------------------------------------------------------------------------------------------------------------------------------------------------------------------------------------------------------------------------|----------------|
| 21.22 | <i>Start delay</i> | Defines the start delay. After the conditions for start have been fulfilled, the drive waits until the delay has elapsed and then starts the motor. Display alarms during delay time <i>AFE9 Start delay</i> . Start delay can be used with all start modes. | 0.00 s |
| | 0.00...60.00 s | Start delay | 1 = 1 s |
| 21.26 | <i>Torque raise cur</i> | Maximum power supply current for torque boost Only used for permanent magnet synchronous motor | 100.0% |
| | 15.0...300.0% | Percent of rated motor current | 1 = 1% |
| 21.27 | <i>Torque boost time</i> | Defines the minimum and maximum torque boost time. If torque boost time is less than 40% of frequency acceleration time (see parameters <i>28.72</i> and <i>28.74</i>), then torque boost time is set at 40% of frequency acceleration time. | 20.0 s |
| | 0.0...60.0 s | Nominal motor time. | 1 = 1 s |
| 21.30 | <i>Speed compensation stop mode</i> | Select drive stop mode. Speed compensation stop is activated under the following circumstances: <ul style="list-style-type: none"> Parameters <i>21.03 Stop mode</i> is <i>Ramp to stopped</i>, or Parameters <i>20.11 Run enable stop mode</i> is <i>Ramp</i> (to prevent loss). | Off |
| | Off | Stop based on the parameter <i>21.03 Stop mode</i> , no speed compensation stop | 0 |
| | Speed comp forward | If the rotation direction is forward, the speed compensation is used for constant distance braking. Before motor slope stop, the drive runs at current speed to compensate for the speed difference between operating speed and maximum speed. For reverse rotation, the drive stops along the slope. | 1 |
| | Speed comp reverse | If the rotation direction is reverse, the speed compensation is used for constant distance braking. Before motor slope stop, the drive runs at current speed to compensate for the speed difference between operating speed and maximum speed. For forward rotation, the drive stops along the slope. | 2 |
| | Speed comp bipolar | Despite of rotation direction and speed compensation used for constant distance braking, the difference between operating speed and maximum speed is compensated by the drive at current speed before motor slope stop. | 3 |
| 21.31 | <i>Speed compensation stop delay</i> | The delay increases total distance before stop at maximum speed. It is used to adjust distances to meet requirements, so total distance is not only dependent on deceleration rate. | 0.00 s |
| | 0.00...1000.00 s | Speed delay | 1 = 1 s |
| 21.32 | <i>Speed compensation stop delay</i> | The parameter sets a speed threshold and the compensation stop function is disabled if below the speed. Within the speed range, the speed compensation stop will not be enabled and the drive will continue to have slope stop. | 10% |
| | 0...100% | Speed threshold is 1% of rated motor speed. | 1 = 1% |
| 21.34 | <i>Force auto restart</i> | Forces automatic restart. The parameter is applicable only if parameter <i>95.04 Control board supply</i> is set to <i>External 24V</i> . | <i>Disable</i> |
| | Disable | Force auto restart disabled. Parameter <i>21.18 Auto restart time</i> is in effect if its value is more than 0.0 s. | 0 |

| Serial number | Name/Value | Description | Def/FbEq16 |
|-------------------------------------|---------------------------------------------|---------------------------------------------------------------------------------------------------------------------------------------------------------------------------------------------------------------------------------------------------------------------------------------------------------------------------------------------------------------------------------------------------------------------------------------------------------------|-----------------|
| | Enable | Force auto restart enabled. Parameter 21.18 Auto restart time is ignored. The drive never trips on the undervoltage fault and the start signal is on forever. When the DC voltage is restored, the normal operation continues. | 1 |
| 22 Speed reference selection | | Motor potentiometer settings. | |
| 22.70 | <i>Motor potentiometer reference enable</i> | Determines when parameters 22.73 Motor potentiometer up source and 22.74 Motor potentiometer down source may change parameter 22.80 Motor potentiometer ref act . | <i>Selected</i> |
| | Not selected | Motor potentiometer Up/Down sources (22.73 and 22.74) are disabled. | 0 |
| | Selected | Motor potentiometer Up/Down sources (22.73 and 22.74) are enabled. | 1 |
| | While running | Motor potentiometer reference enable follows bit 4 (Following reference) of parameter 06.16 Drive status word 1 . | 2 |
| 22.71 | <i>Motor potentiometer function</i> | Activates and selects the mode of the motor potentiometer. | inhibited |
| | inhibited | Motor potentiometer is disabled and its value set to 0. | 0 |
| | Enabled (init at power-up) | When enabled, the motor potentiometer first adopts the value defined by parameter 22.72 Motor potentiometer initial value . The value can then be adjusted from the up and down sources defined by parameters 22.73 Motor potentiometer up source and 22.74 Motor potentiometer down source . After a power cycle, the motor potentiometer reverts to the predefined initial value (22.72). | 1 |
| | Enabled (resume at power-up) | As <i>Enabled (init at power-up)</i> , but the motor potentiometer value is retained over a power cycle. | 2 |
| | Enabled (init to actual) | Whenever another reference source is selected, the value of the motor potentiometer follows that reference. After the source of reference returns to the motor potentiometer, its value can again be changed by the up and down sources (defined by 22.73 and 22.74). | 3 |
| 22.72 | <i>Motor potentiometer initial value</i> | Defines an initial value (starting point) for the motor potentiometer. See the selections of parameter 22.71 Motor potentiometer function . | 0.00 |
| | -32768.00... 32767.00 | Initial value for motor potentiometer. | 1 = 1 |

| Serial number | Name/Value | Description | Def/FbEq16 |
|--------------------------------|----------------------------------------|-------------------------------------------------------------------------------------------------------------------------------------------------------------------------------------------------------------------------------------------------------------------------------------|---------------------|
| 22.73 | <i>Motor potentiometer up source</i> | Selects the source of motor potentiometer up signal. 0 = No change 1 = Increase motor potentiometer value. (If both the up and down sources are on, the potentiometer value will not change.) | Not selected |
| | Not selected | 0 | 0 |
| | Select | 1 | 1 |
| | Timed function 1 | 34.01 Bit 0 of <i>Combined timer status</i> (See page 218). | 18 |
| | Timed function 2 | 34.01 Bit 1 of <i>Combined timer status</i> (See page 218). | 19 |
| | Timed function 3 | 34.01 Bit 2 of <i>Combined timer status</i> (See page 218). | 20 |
| | Monitor 1 | 32.01 Bit 0 of <i>Supervision status word</i> (See page 211). | 24 |
| | Monitor 2 | 32.01 Bit 1 of <i>Supervision status word</i> (See page 211). | 25 |
| | Monitor 3 | 32.01 Bit 2 of <i>Supervision status word</i> (See page 211). | 26 |
| | <i>Other [bit]</i> | Source selection (See 130 on page <i>Terms and abbreviations</i>). | - |
| 22.74 | <i>Motor potentiometer down source</i> | Selects the source of motor potentiometer down signal. 0 = No change 1 = Decrease motor potentiometer value. (If both the up and down sources are on, the potentiometer value will not change.) For selections, see parameter 22.73 <i>Motor potentiometer up source</i> . | <i>Not selected</i> |
| 22.75 | <i>Motor potentiometer ramp time</i> | Defines the change rate of the motor potentiometer. This parameter specifies the time required for the motor potentiometer to change from minimum (22.76) to maximum (22.77) The same change rate applies in both directions. | 10.0 s |
| | 0.0...3600.0 s | Motor potentiometer change time. | 10 = 1s |
| 22.76 | <i>Motor potentiometer min value</i> | Defines the minimum value of the motor potentiometer. Note: If vector control mode is used, value of this parameter must be changed. | -50.00 |
| | -32768.00... 32767.00 | Motor potentiometer minimum. | 1 = 1 |
| 22.77 | <i>Motor potentiometer max value</i> | Defines the maximum value of the motor potentiometer. Note: If vector control mode is used, value of this parameter must be changed. | 50.00 |
| | -32768.00... 32767.00 | Motor potentiometer maximum. | 1 = 1 |
| 22.80 | <i>Motor potentiometer ref act</i> | The output of the motor potentiometer function. (The motor potentiometer is configured using parameters 22.71...22.74). This parameter is read-only. | - |
| | -32768.00... 32767.00 | Value of motor potentiometer. | 1 = 1 |
| 23 Speed reference ramp | | Speed reference ramp settings (programming of the acceleration and deceleration rates for the drive). | |

| Serial number | Name/Value | Description | Def/FbEq16 |
|-------------------------------------|----------------------------------|------------------------------------------------------------------------------------------------------------------------------------------------------------------------------------------------------------------------------------------------------------------------------------------------------------------------------------------------------------------------------------------------------------------------------------------------------------------------------------------------------------------------------------------------------------------------------------------------------------|-------------------------------------|
| 23.20 | <i>Acc time jogging</i> | Defines the acceleration time for the jogging function ie. the time required for the speed to change from zero to the speed value defined by parameter 46.01 Speed fieldbus scaled value . See section <i>Settings and diagnostics</i> (page 177). | 60.000 s |
| | 0.000...1800.000 s | Acceleration time for jogging. | 10 = 1 s |
| 23.21 | <i>Dec time jogging</i> | Defines the deceleration time for the jogging function ie. the time required for the speed to change from the speed value defined by parameter 46.01 Speed fieldbus scaled value to zero. See section <i>Settings and diagnostics</i> (page 177). | 60.000 s |
| | 0.000...1800.000 s | Deceleration time for jogging. | 10 = 1 s |
| 23.23 | <i>Emergency stop time</i> | Speed reference ramp settings (programming of the acceleration and deceleration rates for the drive). 46.01 Speed fieldbus scaled value or 46.02 Frequency fieldbus scaled value to zero). The emergency stop mode and activation source are selected by parameters 21.04 Emergency stop mode and 21.05 Emergency stop source respectively. Emergency stop can also be activated through fieldbus. Notes: • The same parameter value is also used in frequency control mode (ramp parameters 28.71...28.75). | 1 = 1 |
| | 0.000...1800.000 s | Emergency stop Off3 deceleration time. | 10 = 1s |
| 28 Frequency reference chain | | See the control chain diagrams on pages 374 and 375. | |
| 28.01 | <i>Frequency ref ramp input</i> | Displays the used frequency reference before ramping. See the control chain diagram on page 374. This parameter is read-only. | - |
| | -500.00...500.00 Hz | Frequency reference before ramping. | See parameter 46.02 |
| 28.02 | <i>Frequency ref ramp output</i> | Displays the final frequency reference (after selection, limitation and ramping). See the control chain diagram on page 375. This parameter is read-only. | - |
| | -500.00...500.00 Hz | Final frequency reference. | See parameter 46.02 |

| Serial number | Name/Value | Description | Def/FbEq16 |
|---------------|---------------------|----------------------------------------------------------------------------------------------------------------------------------------------------------------------------------------------------------------------------------------------------------------------------------------------------------------------------------------------------------------------------------------------------------------------------------------------------------------------------------------------------------------------------------------------------------------------|------------------|
| 28.11 | Ext1 frequency ref1 | <p>Selects Ext1 frequency reference source 1.</p> <p>Two signal sources can be defined by this parameter and 28.12 Ext1 frequency ref 2. A mathematical function (28.13 Ext1 frequency function) applied to the two signals creates an Ext1 reference (A in the figure below).</p> <p>A digital source selected by 19.11 Ext1/Ext2 sel can be used to switch between Ext1 reference and the corresponding Ext2 reference defined by parameters (28.15 Ext2 frequency ref1, 28.16 Ext2 frequency ref2 and 28.17 Ext2 frequency function) (B in the figure below).</p> | AI1 scaled value |

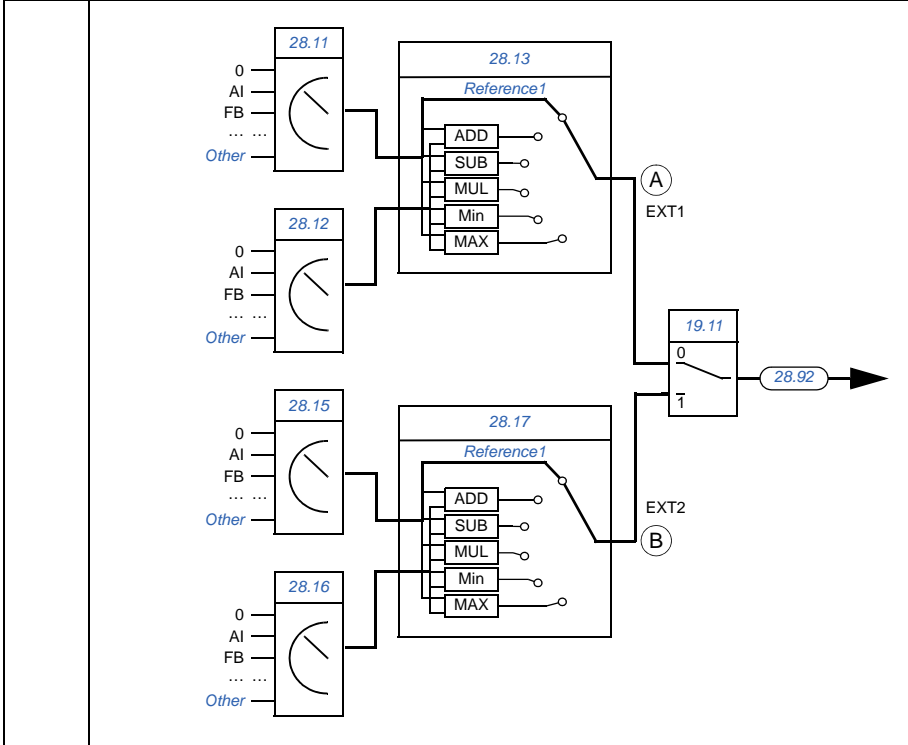

| | | |
|---------------------|------------------------------------------------------------------------|----|
| Zero | None. | 0 |
| AI1 scaled value | 12.12 AI1 scaled value (See page 152). | 1 |
| AI2 scaled value | 12.22 AI2 scaled value (See page 154). | 2 |
| FB A reference 1 | 03.05 FB A reference 1 (See page 136). | 4 |
| FB A reference 2 | 03.06 FB A reference 2 (See page 136). | 5 |
| EFB reference 1 | 03.09 EFB reference 1 (See page 136). | 8 |
| EFB reference 2 | 03.10 EFB reference 2 (See page 136). | 9 |
| Motor potentiometer | 22.80 Motor potentiometer ref act (output of the motor potentiometer). | 15 |
| PID | 40.01 PID output value (output of the process PID controller). | 16 |

| Serial number | Name/Value | Description | Def/FbEq16 |
|---------------|-----------------------------------------|----------------------------------------------------------------------------------------------------------------------------------------------------------------------------------------------------------------------------------------------------------------------------------------------------------------------------------------------------------------------|-------------|
| | Frequency input | 11.38 Freq in 1 actual value (when DI6 is used as Frequency input) | 17 |
| | Control panel (ref saved) | <p>The control panel reference saved through control system; the returned control word is used as the reference.</p> <p>Reference</p> | 18 |
| | Control panel (ref copied) | <p>When the control locations change, if the same control types (e.g., frequency / speed / torque /PID), are selected by two locations, the former used control location is served as the reference, otherwise, the actual signal shall be served as a new reference. ((See 136 on page 03.01 Panel reference).</p> <p>Reference</p> | 19 |
| | <i>Other</i> | Source selection (See Terms and abbreviations). | - |
| 28.12 | Ext1 frequency ref 2 | Selects Ext1 frequency reference source 2. For the selections, and a diagram of reference source selection, see parameter 28.11 Ext1 frequency ref 1 . | <i>Zero</i> |
| 28.13 | Ext1 frequency function | Selects a mathematical function between the reference sources selected by parameters 28.11 Ext1 frequency ref 1 and 28.12 Ext1 frequency ref 2 . See diagram at 28.11 Ext1 frequency ref 1 . | Reference1 |
| | Reference1 | Signal selected by 28.11 Ext1 frequency ref 1 is used as frequency reference 1 as such (no function applied). | 0 |
| | Add (ref1 + ref2) | The sum of the reference sources is used as frequency reference 1. | 1 |
| | Sub (ref1 - ref2) | The subtraction (28.11 Ext1 frequency ref 1 - 28.12 Ext1 frequency ref 2) of the reference sources is used as frequency reference 1. | 2 |
| | Mul (ref1 × ref2) | The multiplication of the reference sources is used as frequency reference 1. | 3 |
| | Min (ref1, ref2) | The smaller of the reference sources is used as frequency reference 1. | 4 |
| | Max (ref1, ref2) | The greater of the reference sources is used as frequency reference 1. | 5 |

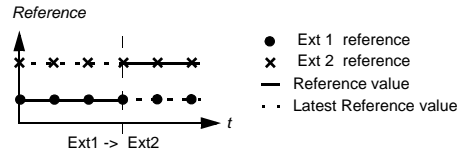
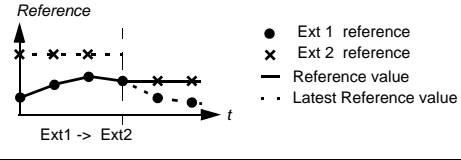
| Serial number | Name/Value | Description | Def/FbEq16 |
|---------------|----------------------------|-------------------------------------------------------------------------------------------------------------------------------------------------------------------------------------------------------------------------------------------------------------------------------------------------------------------------------------------------------------------------------------------------------------------------------------------|------------------|
| 28.15 | <i>Ext2 frequency ref1</i> | Selects Ext2 frequency reference source 1. Two signal sources can be defined by this parameter and 28.16 Ext2 frequency ref2 . A mathematical function (28.17 Ext2 frequency function) applied to the two signals creates an Ext2 reference. See diagram at 28.11 Ext1 frequency ref1 . | AI1 scaled value |
| | Zero | None. | 0 |
| | AI1 scaled value | 12.12 AI1 scaled value (See page 152). | 1 |
| | AI2 scaled value | 12.22 AI2 scaled value (See page 154). | 2 |
| | FB A reference 1 | 03.05 FB A reference 1 (See page 136). | 4 |
| | FB A reference 2 | 03.06 FB A reference 2 (See page 136). | 5 |
| | EFB reference 1 | 03.09 EFB reference 1 (See page 136). | 8 |
| | EFB reference 2 | 03.10 EFB reference 2 (See page 136). | 9 |
| | Motor potentiometer | 22.80 Motor potentiometer ref act (output of the motor potentiometer). | 15 |
| | PID | 40.01 PID output value (output of the process PID controller). | 16 |
| | Frequency input | 11.38 Freq in 1 actual value (When DI6 is used as Frequency input). | |
| | Control panel (ref saved) | The control panel reference saved through control system; the returned control word is used as the reference.  | 18 |
| | Control panel (ref copied) | When the control locations change, if the same control types (e.g., frequency / speed / torque /PID), are selected by two locations, the former used control location is served as the reference, otherwise, the actual signal shall be served as a new reference. ((See 136 on page 03.01 Panel reference) .  | 19 |
| 28.16 | <i>Ext2 frequency ref2</i> | Selects Ext2 frequency reference source 2. For the selections, and a diagram of reference source selection, see parameter 28.15 Ext2 frequency ref1 . | Zero |

| Serial number | Name/Value | Description | Def/FbEq16 | | | | | | | | | |
|---------------|-----------------------------------------------------------------------------------------------------------------------------------------------------------------------------------------------------------------------------------------------------------------------------------------------------------------------------------------------------------------------------------------------------------------------------------------------------------------------------------------------------------------------------------------------------------------------------------------------------------------------------------------------------------------------------|-------------------------------------------------------------------------------------------------------------------------------------------------------------------------------------------------------------------------------------------------------------------------------------------------------------------------------------------------------------------------------------------------------|--------------------|--------|------|-------------|---|-----------------|-------------------------------------------------------------------------------------------------------------------------------------------------------------------------------------------------------------------------------------------------------------------------------------------------------------------------------------------------------------------------------------------------------|---|------------------|---------------------------|
| 28.17 | <i>Ext2 frequency function</i> | Selects a mathematical function between the reference sources selected by parameters <i>28.15 Ext2 frequency ref1</i> and <i>28.16 Ext2 frequency ref2</i> . See diagram at <i>28.15 Ext2 frequency ref1</i> . | <i>Reference 1</i> | | | | | | | | | |
| | Reference value 1 | Signal selected by <i>28.15 Ext2 frequency ref1</i> is used as frequency reference 1 as such (no function applied). | 0 | | | | | | | | | |
| | Add (ref1 + ref2) | The sum of the reference sources is used as frequency reference 1. | 1 | | | | | | | | | |
| | Sub (ref1 - ref2) | The subtraction ([<i>28.15 Ext2 frequency ref1</i>] - [<i>28.16 Ext2 frequency ref2</i>]) of the reference sources is used as frequency reference 1. | 2 | | | | | | | | | |
| | Mul (ref1 × ref2) | The multiplication of the reference sources is used as frequency reference 1. | 3 | | | | | | | | | |
| | Min (ref1, ref2) | The smaller of the reference sources is used as frequency reference 1. | 4 | | | | | | | | | |
| | Max (ref1, ref2) | The greater of the reference sources is used as frequency reference 1. | 5 | | | | | | | | | |
| 28.21 | <i>Constant frequency function</i> | Determines how constant frequencies are selected, and whether the rotation direction signal is considered or not when applying a constant frequency. | 01b | | | | | | | | | |
| | <table border="1"> <thead> <tr> <th>Bit(s)</th> <th>Name</th> <th>Information</th> </tr> </thead> <tbody> <tr> <td>0</td> <td>Const freq mode</td> <td>1 = combination: 7 constant frequencies are selectable using the three sources defined by parameters <i>28.22</i>, <i>28.23</i> and <i>28.24</i>. 0 = individual: Constant frequencies 1, 2 and 3 are separately activated by the sources defined by parameters <i>28.22</i>, <i>28.23</i> and <i>28.24</i> In case of conflict, the constant frequency with the smaller number takes priority.</td> </tr> <tr> <td>1</td> <td>Direction enable</td> <td>0= inhibited 1= enable</td> </tr> </tbody> </table> | | | Bit(s) | Name | Information | 0 | Const freq mode | 1 = combination: 7 constant frequencies are selectable using the three sources defined by parameters <i>28.22</i> , <i>28.23</i> and <i>28.24</i> . 0 = individual: Constant frequencies 1, 2 and 3 are separately activated by the sources defined by parameters <i>28.22</i> , <i>28.23</i> and <i>28.24</i> In case of conflict, the constant frequency with the smaller number takes priority. | 1 | Direction enable | 0= inhibited 1= enable |
| Bit(s) | Name | Information | | | | | | | | | | |
| 0 | Const freq mode | 1 = combination: 7 constant frequencies are selectable using the three sources defined by parameters <i>28.22</i> , <i>28.23</i> and <i>28.24</i> . 0 = individual: Constant frequencies 1, 2 and 3 are separately activated by the sources defined by parameters <i>28.22</i> , <i>28.23</i> and <i>28.24</i> In case of conflict, the constant frequency with the smaller number takes priority. | | | | | | | | | | |
| 1 | Direction enable | 0= inhibited 1= enable | | | | | | | | | | |
| | 00b...11b | Constant frequency configuration word. | 1 = 1 | | | | | | | | | |

| Serial number | Name/Value | Description | Def/FbEq16 | | | | | | | | | | | | | | | | | | | | | | | | | | | | | | | | | | | | |
|------------------------------------------------------------------------------------------------------------------------------------------------------------------------------------------------------------------------------------------------------------------------------------------------------------------------------------------------------------------------------------------------------------------------------------------------------------------------------------------------------------------------------------------------------------------------------------------------------------------------------------------------------------------------------------------------------------------------------------------------------------------------------------------------------------------------------|---------------------------------|------------------------------------------------------------------------------------------------------------------------------------------------------------------------------------------------------------------------------------------------------------------------------------------------------------------------------------------------------------------------------------------------------------------------------------------------------------------------------------------------------------------------------------------------|---------------------------|------------------------------|------------------------------|------------------------------|---------------------------|---|---|---|-----|---|---|---|----------------------|---|---|---|----------------------|---|---|---|----------------------|---|---|---|----------------------|---|---|---|----------------------|---|---|---|----------------------|---|---|---|----------------------|
| 28.22 | <i>Constant frequency sel 1</i> | When bit 0 of parameter <i>28.21 Constant frequency function</i> is 0 (Separate), selects a source that activates constant speed 1. When bit 0 of parameter <i>28.21 Constant frequency function</i> is 1 (Packed), this parameter and parameters <i>28.23 Constant frequency sel 2</i> and <i>28.24 Constant frequency sel 3</i> select three sources whose states activate constant speeds as follows: | DI3 | | | | | | | | | | | | | | | | | | | | | | | | | | | | | | | | | | | | |
| <table border="1"> <thead> <tr> <th>Source defined by par. 28.22</th> <th>Source defined by par. 28.23</th> <th>Source defined by par. 28.24</th> <th>Constant frequency active</th> </tr> </thead> <tbody> <tr> <td>0</td> <td>0</td> <td>0</td> <td>n/a</td> </tr> <tr> <td>1</td> <td>0</td> <td>0</td> <td>Constant frequency 1</td> </tr> <tr> <td>0</td> <td>1</td> <td>0</td> <td>Constant frequency 2</td> </tr> <tr> <td>1</td> <td>1</td> <td>0</td> <td>Constant frequency 3</td> </tr> <tr> <td>0</td> <td>0</td> <td>1</td> <td>Constant frequency 4</td> </tr> <tr> <td>1</td> <td>0</td> <td>1</td> <td>Constant frequency 5</td> </tr> <tr> <td>0</td> <td>1</td> <td>1</td> <td>Constant frequency 6</td> </tr> <tr> <td>1</td> <td>1</td> <td>1</td> <td>Constant frequency 7</td> </tr> </tbody> </table> | | | | Source defined by par. 28.22 | Source defined by par. 28.23 | Source defined by par. 28.24 | Constant frequency active | 0 | 0 | 0 | n/a | 1 | 0 | 0 | Constant frequency 1 | 0 | 1 | 0 | Constant frequency 2 | 1 | 1 | 0 | Constant frequency 3 | 0 | 0 | 1 | Constant frequency 4 | 1 | 0 | 1 | Constant frequency 5 | 0 | 1 | 1 | Constant frequency 6 | 1 | 1 | 1 | Constant frequency 7 |
| Source defined by par. 28.22 | Source defined by par. 28.23 | Source defined by par. 28.24 | Constant frequency active | | | | | | | | | | | | | | | | | | | | | | | | | | | | | | | | | | | | |
| 0 | 0 | 0 | n/a | | | | | | | | | | | | | | | | | | | | | | | | | | | | | | | | | | | | |
| 1 | 0 | 0 | Constant frequency 1 | | | | | | | | | | | | | | | | | | | | | | | | | | | | | | | | | | | | |
| 0 | 1 | 0 | Constant frequency 2 | | | | | | | | | | | | | | | | | | | | | | | | | | | | | | | | | | | | |
| 1 | 1 | 0 | Constant frequency 3 | | | | | | | | | | | | | | | | | | | | | | | | | | | | | | | | | | | | |
| 0 | 0 | 1 | Constant frequency 4 | | | | | | | | | | | | | | | | | | | | | | | | | | | | | | | | | | | | |
| 1 | 0 | 1 | Constant frequency 5 | | | | | | | | | | | | | | | | | | | | | | | | | | | | | | | | | | | | |
| 0 | 1 | 1 | Constant frequency 6 | | | | | | | | | | | | | | | | | | | | | | | | | | | | | | | | | | | | |
| 1 | 1 | 1 | Constant frequency 7 | | | | | | | | | | | | | | | | | | | | | | | | | | | | | | | | | | | | |
| | Not selected | 0 | 0 | | | | | | | | | | | | | | | | | | | | | | | | | | | | | | | | | | | | |
| | Select | 1 | 1 | | | | | | | | | | | | | | | | | | | | | | | | | | | | | | | | | | | | |
| | Timed function 1 | <i>34.01</i> Bit 0 of <i>Combined timer status</i> (See page 218). | 18 | | | | | | | | | | | | | | | | | | | | | | | | | | | | | | | | | | | | |
| | Timed function 2 | <i>34.01</i> Bit 1 of <i>Combined timer status</i> (See page 218). | 19 | | | | | | | | | | | | | | | | | | | | | | | | | | | | | | | | | | | | |
| | Timed function 3 | <i>34.01</i> Bit 2 of <i>Combined timer status</i> (See page 218). | 20 | | | | | | | | | | | | | | | | | | | | | | | | | | | | | | | | | | | | |
| | Monitor 1 | <i>32.01</i> Bit 0 of <i>Supervision status word</i> (See page 211). | 24 | | | | | | | | | | | | | | | | | | | | | | | | | | | | | | | | | | | | |
| | Monitor 2 | <i>32.01</i> Bit 1 of <i>Supervision status word</i> (See page 211). | 25 | | | | | | | | | | | | | | | | | | | | | | | | | | | | | | | | | | | | |
| | Monitor 3 | <i>32.01</i> Bit 2 of <i>Supervision status word</i> (See page 211). | 26 | | | | | | | | | | | | | | | | | | | | | | | | | | | | | | | | | | | | |
| | <i>Other [bit]</i> | Source selection (See <i>130 on page Terms and abbreviations</i>). | - | | | | | | | | | | | | | | | | | | | | | | | | | | | | | | | | | | | | |
| 28.23 | <i>Constant frequency sel 2</i> | When bit 0 of parameter <i>28.21 Constant frequency function</i> is 0 (Separate), selects a source that activates constant speed 2. When bit 0 of parameter <i>28.21 Constant frequency function</i> is 1 (Packed), this parameter and parameters <i>28.22 Constant frequency sel 1</i> and <i>28.24 Constant frequency sel 3</i> select three sources that are used to activate constant frequencies. See table at parameter <i>28.22 Constant frequency sel 1</i> . For selections, see parameter <i>28.22 Constant frequency sel 1</i> . | DI4 | | | | | | | | | | | | | | | | | | | | | | | | | | | | | | | | | | | | |
| 28.24 | <i>Constant frequency sel 3</i> | When bit 0 of parameter <i>28.21 Constant frequency function</i> is 0 (Separate), selects a source that activates constant speed 3. When bit 0 of parameter <i>28.21 Constant frequency function</i> is 1 (Packed), this parameter and parameters <i>28.22 Constant frequency sel 1</i> and <i>28.23 Constant frequency sel 2</i> select three sources that are used to activate constant frequencies. See table at parameter <i>28.22 Constant frequency sel 1</i> . For selections, see parameter <i>28.22 Constant frequency sel 1</i> . | <i>Not selected</i> | | | | | | | | | | | | | | | | | | | | | | | | | | | | | | | | | | | | |



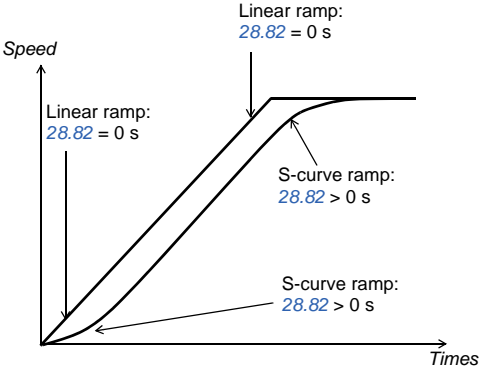
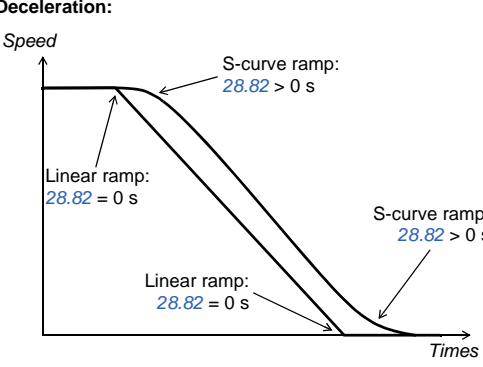

| Serial number | Name/Value | Description | Def/FbEq16 |
|---------------|------------------------------------|----------------------------------------------------------------------------------------------------------------------------------------------------------------------------------------------------------------------------------------------------------------------------------------------------------------------------|-------------------------------------|
| 28.26 | <i>Constant frequency 1</i> | Defines constant speed 1 (the frequency the motor will turn when constant speed 1 is selected). | 5.00 Hz |
| | -500.00...500.00 Hz | Constant frequency 1. | See parameter 46.02 |
| 28.27 | <i>Constant frequency 2</i> | Defines constant frequency 2. | 10.00 Hz |
| | -500.00...500.00 Hz | Constant frequency 2. | See parameter 46.02 |
| 28.28 | <i>Constant frequency 3</i> | Defines constant frequency 3. | 15.00 Hz |
| | -500.00...500.00 Hz | Constant frequency 3. | See parameter 46.02 |
| 28.29 | <i>Constant frequency 4</i> | Defines constant frequency 4. | 20.00 Hz |
| | -500.00...500.00 Hz | Constant frequency 4. | See parameter 46.02 |
| 28.30 | <i>Constant frequency 5</i> | Defines constant frequency 5. | 25.00 Hz |
| | -500.00...500.00 Hz | Constant frequency 5. | See parameter 46.02 |
| 28.31 | <i>Constant frequency 6</i> | Defines constant frequency 6. | 40.00 Hz |
| | -500.00...500.00 Hz | Constant frequency 6. | See parameter 46.02 |
| 28.32 | <i>Constant frequency 7</i> | Defines constant frequency 7. | 50.00 Hz |
| | -500.00...500.00 Hz | Constant frequency 7. | See parameter 46.02 |
| 28.41 | <i>Reference of safe frequency</i> | Defines a safe frequency reference value that is used with supervision functions such as: <ul style="list-style-type: none"> • 12.03 AI supervision function • 49.05 Communication loss action • 50.02 FBA A communication loss function. | 0.00 Hz |
| | -500.00...500.00 Hz | Safe frequency reference. | See parameter 46.02 |
| 28.42 | <i>Jogging 1 frequency ref</i> | Defines the frequency reference for jogging function 1 in scalar control mode. | 0.00 Hz |
| | -500.00...500.00 Hz | Jogging 1 frequency reference. | See par. 46.02 |
| 28.43 | <i>Jogging 2 frequency ref</i> | Defines the frequency reference for jogging function 2 in scalar control mode. | 0.00 Hz |
| | -500.00...500.00 Hz | Jogging 2 frequency reference. | See par. 46.02 |

| Serial number | Name/Value | Description | Def/FbEq16 | | | | | | | | | | | |
|---------------|--------------------------------------------------------------------------------------------------------------------------------------------------------------------------------------------------------------------------------------------------------------------------------------------------------------------------------------------------------------------------------------------------------------------------------------------------------------------------------------------------------------------------------------------------------------------------------------------------------------------------------------------------------------|------------------------------------------------------------------------------------------------------------------------------------------------------------------------------------|-------------------------------------|--------|------|-------------|---|-----------------------------|-----------------------------------------|-------------------------------------------|---|-----------|-------------------------------------------------------------------------------------------------|----------------------------------------------------------------------------------------------------------------------------------|
| 28.51 | <i>Critical frequency function</i> | Enables/disables the critical frequencies function. Also determines whether the specified ranges are effective in both rotating directions or not. | 00b | | | | | | | | | | | |
| | <table border="1"> <thead> <tr> <th>Bit(s)</th> <th>Name</th> <th>Information</th> </tr> </thead> <tbody> <tr> <td rowspan="2">0</td> <td rowspan="2">Critical frequency function</td> <td>1 = enable: enables critical frequency.</td> </tr> <tr> <td>0 = disable: disables critical frequency.</td> </tr> <tr> <td rowspan="2">1</td> <td rowspan="2">Sign mode</td> <td>1 = according to parameter: consider parameter 28.52...28.57 positive-negative.</td> </tr> <tr> <td>0 = absolute: parameter 28.52...28.57 is absolute value. Each range is effective in both directions of rotation.</td> </tr> </tbody> </table> | | | Bit(s) | Name | Information | 0 | Critical frequency function | 1 = enable: enables critical frequency. | 0 = disable: disables critical frequency. | 1 | Sign mode | 1 = according to parameter: consider parameter 28.52...28.57 positive-negative. | 0 = absolute: parameter 28.52...28.57 is absolute value. Each range is effective in both directions of rotation. |
| Bit(s) | Name | Information | | | | | | | | | | | | |
| 0 | Critical frequency function | 1 = enable: enables critical frequency. | | | | | | | | | | | | |
| | | 0 = disable: disables critical frequency. | | | | | | | | | | | | |
| 1 | Sign mode | 1 = according to parameter: consider parameter 28.52...28.57 positive-negative. | | | | | | | | | | | | |
| | | 0 = absolute: parameter 28.52...28.57 is absolute value. Each range is effective in both directions of rotation. | | | | | | | | | | | | |
| | 00b...11b | Critical frequencies configuration word. | 1 = 1 | | | | | | | | | | | |
| 28.52 | <i>Critical frequency 1 lower limit</i> | Defines the low limit for critical frequency 1. Note: This value must be less than or equal to the value of 28.53 Critical frequency 1 upper limit . | 0.00 Hz | | | | | | | | | | | |
| | -500.00...500.00 Hz | Low limit for critical frequency 1. | See parameter 46.02 | | | | | | | | | | | |
| 28.53 | <i>Critical frequency 1 upper limit</i> | Defines the high limit for critical frequency 1. Note: This value must be greater than or equal to the value of 28.52 Critical frequency 1 lower limit . | 0.00 Hz | | | | | | | | | | | |
| | -500.00...500.00 Hz | High limit for critical frequency 1. | See parameter 46.02 | | | | | | | | | | | |
| 28.54 | <i>Critical frequency 2 lower limit</i> | Defines the low limit for critical frequency 2. Note: This value must be less than or equal to the value of 28.55 Critical frequency 2 upper limit . | 0.00 Hz | | | | | | | | | | | |
| | -500.00...500.00 Hz | Low limit for critical frequency 2. | See parameter 46.02 | | | | | | | | | | | |
| 28.55 | <i>Critical frequency 2 upper limit</i> | Defines the high limit for critical frequency 2. Note: This value must be greater than or equal to the value of 28.54 Critical frequency 2 lower limit . | 0.00 Hz | | | | | | | | | | | |
| | -500.00...500.00 Hz | High limit for critical frequency 2. | See parameter 46.02 | | | | | | | | | | | |
| 28.56 | <i>Critical frequency 3 lower limit</i> | Defines the low limit for critical frequency 3. Note: This value must be less than or equal to the value of 28.57 Critical frequency 3 upper limit . | 0.00 Hz | | | | | | | | | | | |
| | -500.00...500.00 Hz | Low limit for critical frequency 3. | See parameter 46.02 | | | | | | | | | | | |
| 28.57 | <i>Critical frequency 3 upper limit</i> | Defines the high limit for critical frequency 3. Note: This value must be greater than or equal to the value of 28.56 Critical frequency 3 lower limit . | 0.00 Hz | | | | | | | | | | | |
| | -500.00...500.00 Hz | High limit for critical frequency 3. | See parameter 46.02 | | | | | | | | | | | |

| Serial number | Name/Value | Description | Def/FbEq16 |
|---------------|---------------------------------|-------------------------------------------------------------------------------------------------------------------------------------------------------------------------------------------------------------------------------------------------------------------------------------------------------------------------------------------------------------------------------------------------------------------------------------------------------------------------------------------------------------------------------------------------------------------------------------------------------------------------------------------------------------------------------------------------------------------------------|------------|
| 28.71 | <i>Freq ramp set selection</i> | Selects the source that switches between the two sets of acceleration/deceleration times defined by parameters 28.72...28.75. 0 = Each range is effective in both directions of rotation. 1 = Acceleration time 2 and deceleration time 2 are in force | D15 |
| | Acc/Dec time 1 | 0 | 0 |
| | Acc/Dec time 2 | 1 | 1 |
| | EFB | Only for the DCU profile. DCU control word bit 10 received through the embedded fieldbus interface. | 20 |
| | <i>Other [bit]</i> | Source selection (See 130 on page <i>Terms and abbreviations</i>). | - |
| 28.72 | <i>Freq acceleration time 1</i> | Defines acceleration time 1 as the time required for the frequency to change from zero to the frequency defined by parameter 46.02 <i>Frequency fieldbus scaled value</i> . After this frequency has been reached, the acceleration continues with the same rate to the value defined by parameter 30.14 <i>Maximum frequency</i> . If the reference increases faster than the set acceleration rate, the motor will follow the acceleration rate. If the reference increases slower than the set acceleration rate, the motor frequency will follow the reference. If the acceleration time is set too short, the drive will automatically prolong the acceleration in order not to exceed the drive torque limits. | 20.000 s |
| | 0.000...1800.000 s | Acceleration time 1. | 10 = 1s |
| 28.73 | <i>Freq deceleration time 1</i> | Defines deceleration time 1 as the time required for the frequency to change from the frequency defined by parameter 46.02 <i>Frequency fieldbus scaled value</i> (not from parameter 30.14 <i>Maximum frequency</i>) to zero. If there is any doubt about the deceleration time being too short, ensure that DC overvoltage control (30.30 <i>Overvoltage control</i>) is on. Note: If a short deceleration time is needed for a high inertia application, the drive should be equipped with braking equipment such as a brake chopper and brake resistor. | 20.000 s |
| | 0.000...1800.000 s | Deceleration time 1. | 10 = 1s |
| 28.74 | <i>Freq acceleration time 2</i> | Defines acceleration time 2. See parameter 28.72 <i>Freq acceleration time 1</i> . | 60.000 s |
| | 0.000...1800.000 s | Acceleration time 2. | 10 = 1s |
| 28.75 | <i>Freq deceleration time 2</i> | Defines deceleration time 2. See parameter 28.73 <i>Freq deceleration time 1</i> . | 60.000 s |
| | 0.000...1800.000 s | Deceleration time 2. | 10 = 1s |
| 28.76 | <i>Frequency ramp in Zero</i> | Selects a source that forces the frequency reference to zero. 0 = Force frequency reference to zero 1 = Normal operation | Inactive |
| | Activating | 0. | 0 |
| | Inactive | 1. | 1 |
| | <i>Other [bit]</i> | Source selection (See 130 on page <i>Terms and abbreviations</i>). | - |

| Serial number | Name/Value | Description | Def/FbEq16 |
|---------------|----------------------|----------------------------------------------------------------------------------------------------------------------------------------------------------------------------------------------------------------------------------------------------------------------------------------------------------------------------------------------------------------------------------------------------------------------------------------------------------------------------------------------------------------------------------------------------------------------------------------------------------------------|------------|
| 28.82 | Acc/Dec curve time 1 | <p>Defines the shape of the acceleration and deceleration ramps used with the set 1.</p> <p>0.000 s: Linear ramp. Suitable for steady acceleration or deceleration and for slow ramps.</p> <p>0.001...1000.000 s: S-curve ramp. S-curve ramps are ideal for lifting applications. The S-curve consists of symmetrical curves at both ends of the ramp and a linear part in between.</p> <p>Acceleration:</p>  <p>Deceleration:</p>  | 0.100 s |
| | 0.100...1800.000 s | Ramp shape at start and end of acceleration and deceleration. | 10 = 1 s |
| 28.83 | Acc/Dec curve time 2 | Defines the shape of the acceleration and deceleration ramps used with the set 2. See parameter 28.82 Acc/Dec curve time 1. | 0.100 s |
| | 0.100...1800.000 s | Ramp shape at start and end of acceleration and deceleration. | 10 = 1 s |

| Serial number | Name/Value | Description | Def/FbEq16 |
|------------------|----------------------------------------|----------------------------------------------------------------------------------------------------------------------------------------------------------------------------------------------------------------------------------------|-------------------------------------------------------------------------------------------------------------------------------------------------------------------------------------------------------------------------------|
| 28.92 | <i>Frequency ref act 3</i> | Displays the selected (<i>19.11 Ext1/Ext2 se</i>)frequency reference and the function applied by parameter <i>28.13 Ext1 frequency function</i> (if any). See the control chain diagram on page 373. This parameter is read-only. | - |
| | -500.00...500.00 Hz | Frequency reference after selection. | See parameter <i>46.02</i> |
| 28.96 | <i>Frequency ref act 7</i> | Displays the frequency reference after application of constant frequencies, control panel reference etc. See the control chain diagram on page 373. This parameter is read-only. | - |
| | -500.00...500.00 Hz | Frequency reference 7. | See parameter <i>46.02</i> |
| 28.97 | <i>Non-limited frequency reference</i> | Display frequency reference after application of critical frequency (before the slope and threshold) See the control chain diagram on page 373. This parameter is read-only. | See parameter <i>46.02</i> |
| | -500.00...500.00 Hz | Frequency reference before slope and threshold. | - |
| 30 Limits | | Drive operation limit. | |
| 30.01 | <i>Limit word 1</i> | Displays limit word 1. This parameter is read-only. | - |
| | Bit | Name | Description |
| | 0 | Torq lim | 1 = Drive torque is being limited by the motor control (undervoltage control, current control, load angle control or pull-out control), or by the torque limits defined by parameters. |
| | 1...2 | Reserved | |
| | 3 | Torq ref max | 1 = Torque reference ramp input is being limited by <i>26.09 Maximum torque ref</i> , <i>30.20 Maximum torque 1</i> , <i>30.26 Power motoring limit</i> or <i>30.27 Power generating limit</i> . See the diagram on page 608. |
| | 4 | Torq ref min | 1 = Torque reference ramp input is being limited by <i>26.08 Minimum torque ref</i> , <i>30.19 Minimum torque 1</i> , <i>30.26 Power motoring limit</i> or <i>30.27 Power generating limit</i> . See the diagram on page 608. |
| | 5 | Tlim max speed | 1 = Torque reference is being limited by the rush control because of maximum speed limit (<i>30.12 Maximum speed</i>) |
| | 6 | Tlim min speed | 1 = Torque reference is being limited by the rush control because of minimum speed limit (<i>30.11 Minimum speed</i>) |
| | 7 | Max speed ref lim | 1 = Speed reference is being limited by <i>30.12 Maximum speed</i> |
| | 8 | Min speed ref lim | 1 = Speed reference is being limited by <i>30.11 Minimum speed</i> |
| | 9 | Max freq ref lim | 1 = Frequency reference is being limited by <i>30.14 Maximum frequency</i> |
| | 10 | Min freq ref lim | 1 = Frequency reference is being limited by <i>30.13 Minimum frequency</i> |
| | 11...15 | Reserved | |
| | 0000h...FFFFh | Limit word 1. | 1 = 1 |

| Serial number | Name/Value | Description | Def/FbEq16 | | | | | | | | | | | | | | | | | | | | | | | | | | | | | | | | | | | | | | | | | | | | | | | |
|---------------|-------------------------------------------------------------------------------------------------------------------------------------------------------------------------------------------------------------------------------------------------------------------------------------------------------------------------------------------------------------------------------------------------------------------------------------------------------------------------------------------------------------------------------------------------------------------------------------------------------------------------------------------------------------------------------------------------------------------------------------------------------------------------------------------------------------------------------------------------------------------------------------------------------------------------------------------------------------------------------------------------------------------------------------------------------------------------------------------------------------------------------------------------------------------------------------------------------------------------------------------------------------------------------------------------------------------------------------------------------------------------------------------------------------------------------------------------------------------------------------------------------------------------------------------------------------------------------------------------------------------------------------------------------------------------------------------------------------------------------------------------------------------------------------------------------------------------------------------------------------------------------------------------------------------------------------------------------------------------------------------------------------------------------------------------------------------------------------------------------------------------------------------------------------------------------------------------------------------------------------------------------------------------------------------------------------------------------------------------|-------------------------------------------------------------------------------------------------------------------------------------------------------------------------------------------------------------------------------------------------------------------------------------------------------------------------------------------------------------------------------------------|-------------------------------------|-------------|---|--------------|-------------------------------------------|---|-------------|------------------------------------------|---|----------------|---------------------------------------------------------------------------------------------------------------------------------------------------------------------|---|----------------|---------------------------------------------------------------------------------------------------------------------------------------------------------------------|---|------------------|---------------------------------------------------------------------|---|------------|-------------------------------------------------------------------------------------------------------------------------------------------|---|---------------|-----------------------------------------------------------------------------------------------------------------|---|----------|--|---|---------|----------------------------------------------------------------------|---|-------------|------------------------------------------------------------|----|--------------|-------------------------------------------------------------------------------|----|--------------|----------------------------------------------------------------------------|----|----------------------|----------------------------------------------------------------------------|----|---------------|-----------------------------------------------------------------------------------|---------|----------|--|--|
| 30.02 | <i>Torque limit status</i> | Displays the torque controller limitation status word. This parameter is read-only. | - | | | | | | | | | | | | | | | | | | | | | | | | | | | | | | | | | | | | | | | | | | | | | | | |
| | <table border="1"> <thead> <tr> <th>Bit</th> <th>Name</th> <th>Description</th> </tr> </thead> <tbody> <tr> <td>0</td> <td>Undervoltage</td> <td>*1 = Intermediate DC circuit undervoltage</td> </tr> <tr> <td>1</td> <td>Overvoltage</td> <td>*1 = Intermediate DC circuit overvoltage</td> </tr> <tr> <td>2</td> <td>Minimum torque</td> <td>*1 = Torque is being limited by 30.19 Minimum torque 1, 30.26 Power motoring limit or 30.27 Power generating limit</td> </tr> <tr> <td>3</td> <td>Maximum torque</td> <td>*1 = Torque is being limited by 30.20 Maximum torque 1, 30.26 Power motoring limit or 30.27 Power generating limit</td> </tr> <tr> <td>4</td> <td>Internal current</td> <td>1 = An inverter current limit (identified by bits 8...11) is active</td> </tr> <tr> <td>5</td> <td>Load angle</td> <td>(With permanent magnet motors and reluctance motors only) 1 = Load angle limit is active, ie. the motor cannot produce any more torque</td> </tr> <tr> <td>6</td> <td>Motor pullout</td> <td>(With asynchronous motors only) Motor pull-out limit is active, ie. the motor cannot produce any more torque</td> </tr> <tr> <td>7</td> <td>Reserved</td> <td></td> </tr> <tr> <td>8</td> <td>Thermal</td> <td>1 = Input current is being limited by the main circuit thermal limit</td> </tr> <tr> <td>9</td> <td>Max current</td> <td>*1 = Maximum output current (I_{MAX}) is being limited</td> </tr> <tr> <td>10</td> <td>User current</td> <td>*1 = Output current is being limited by 30.17 Maximum current</td> </tr> <tr> <td>11</td> <td>Thermal IGBT</td> <td>*1 = Output current is being limited by a calculated thermal current value</td> </tr> <tr> <td>12</td> <td>IGBT overtemperature</td> <td>*1 = Output current is being limited because of estimated IGBT temperature</td> </tr> <tr> <td>13</td> <td>IGBT overload</td> <td>*1 = Output current is being limited because of IGBT junction to case temperature</td> </tr> <tr> <td>14...15</td> <td>Reserved</td> <td></td> </tr> </tbody> </table> <p>*Only one out of bits 0...3, and one out of bits 9...11 can be on simultaneously. The bit typically indicates the limit that is exceeded first.</p> | Bit | Name | Description | 0 | Undervoltage | *1 = Intermediate DC circuit undervoltage | 1 | Overvoltage | *1 = Intermediate DC circuit overvoltage | 2 | Minimum torque | *1 = Torque is being limited by 30.19 Minimum torque 1 , 30.26 Power motoring limit or 30.27 Power generating limit | 3 | Maximum torque | *1 = Torque is being limited by 30.20 Maximum torque 1 , 30.26 Power motoring limit or 30.27 Power generating limit | 4 | Internal current | 1 = An inverter current limit (identified by bits 8...11) is active | 5 | Load angle | (With permanent magnet motors and reluctance motors only) 1 = Load angle limit is active, ie. the motor cannot produce any more torque | 6 | Motor pullout | (With asynchronous motors only) Motor pull-out limit is active, ie. the motor cannot produce any more torque | 7 | Reserved | | 8 | Thermal | 1 = Input current is being limited by the main circuit thermal limit | 9 | Max current | *1 = Maximum output current (I_{MAX}) is being limited | 10 | User current | *1 = Output current is being limited by 30.17 Maximum current | 11 | Thermal IGBT | *1 = Output current is being limited by a calculated thermal current value | 12 | IGBT overtemperature | *1 = Output current is being limited because of estimated IGBT temperature | 13 | IGBT overload | *1 = Output current is being limited because of IGBT junction to case temperature | 14...15 | Reserved | | |
| Bit | Name | Description | | | | | | | | | | | | | | | | | | | | | | | | | | | | | | | | | | | | | | | | | | | | | | | | |
| 0 | Undervoltage | *1 = Intermediate DC circuit undervoltage | | | | | | | | | | | | | | | | | | | | | | | | | | | | | | | | | | | | | | | | | | | | | | | | |
| 1 | Overvoltage | *1 = Intermediate DC circuit overvoltage | | | | | | | | | | | | | | | | | | | | | | | | | | | | | | | | | | | | | | | | | | | | | | | | |
| 2 | Minimum torque | *1 = Torque is being limited by 30.19 Minimum torque 1 , 30.26 Power motoring limit or 30.27 Power generating limit | | | | | | | | | | | | | | | | | | | | | | | | | | | | | | | | | | | | | | | | | | | | | | | | |
| 3 | Maximum torque | *1 = Torque is being limited by 30.20 Maximum torque 1 , 30.26 Power motoring limit or 30.27 Power generating limit | | | | | | | | | | | | | | | | | | | | | | | | | | | | | | | | | | | | | | | | | | | | | | | | |
| 4 | Internal current | 1 = An inverter current limit (identified by bits 8...11) is active | | | | | | | | | | | | | | | | | | | | | | | | | | | | | | | | | | | | | | | | | | | | | | | | |
| 5 | Load angle | (With permanent magnet motors and reluctance motors only) 1 = Load angle limit is active, ie. the motor cannot produce any more torque | | | | | | | | | | | | | | | | | | | | | | | | | | | | | | | | | | | | | | | | | | | | | | | | |
| 6 | Motor pullout | (With asynchronous motors only) Motor pull-out limit is active, ie. the motor cannot produce any more torque | | | | | | | | | | | | | | | | | | | | | | | | | | | | | | | | | | | | | | | | | | | | | | | | |
| 7 | Reserved | | | | | | | | | | | | | | | | | | | | | | | | | | | | | | | | | | | | | | | | | | | | | | | | | |
| 8 | Thermal | 1 = Input current is being limited by the main circuit thermal limit | | | | | | | | | | | | | | | | | | | | | | | | | | | | | | | | | | | | | | | | | | | | | | | | |
| 9 | Max current | *1 = Maximum output current (I_{MAX}) is being limited | | | | | | | | | | | | | | | | | | | | | | | | | | | | | | | | | | | | | | | | | | | | | | | | |
| 10 | User current | *1 = Output current is being limited by 30.17 Maximum current | | | | | | | | | | | | | | | | | | | | | | | | | | | | | | | | | | | | | | | | | | | | | | | | |
| 11 | Thermal IGBT | *1 = Output current is being limited by a calculated thermal current value | | | | | | | | | | | | | | | | | | | | | | | | | | | | | | | | | | | | | | | | | | | | | | | | |
| 12 | IGBT overtemperature | *1 = Output current is being limited because of estimated IGBT temperature | | | | | | | | | | | | | | | | | | | | | | | | | | | | | | | | | | | | | | | | | | | | | | | | |
| 13 | IGBT overload | *1 = Output current is being limited because of IGBT junction to case temperature | | | | | | | | | | | | | | | | | | | | | | | | | | | | | | | | | | | | | | | | | | | | | | | | |
| 14...15 | Reserved | | | | | | | | | | | | | | | | | | | | | | | | | | | | | | | | | | | | | | | | | | | | | | | | | |
| | 0000h...FFFFh | Torque limitation status word. | 1 = 1 | | | | | | | | | | | | | | | | | | | | | | | | | | | | | | | | | | | | | | | | | | | | | | | |
| 30.13 | <i>Minimum frequency</i> | Defines the minimum allowed frequency.  Warning! This value must not be higher than 30.14 Maximum frequency .  Warning! This limit is effective in frequency control mode only. | -50.00 Hz | | | | | | | | | | | | | | | | | | | | | | | | | | | | | | | | | | | | | | | | | | | | | | | |
| | -500.00...500.00 Hz | Minimum frequency. | See parameter 46.02 | | | | | | | | | | | | | | | | | | | | | | | | | | | | | | | | | | | | | | | | | | | | | | | |
| 30.14 | <i>Maximum frequency</i> | Defines the maximum allowed frequency.  Warning! This value must not be less than 30.13 Minimum frequency .  Warning! This limit is effective in frequency control mode only. | 50.00 Hz | | | | | | | | | | | | | | | | | | | | | | | | | | | | | | | | | | | | | | | | | | | | | | | |
| | -500.00...500.00 Hz | Maximum frequency. | See parameter 46.02 | | | | | | | | | | | | | | | | | | | | | | | | | | | | | | | | | | | | | | | | | | | | | | | |
| 30.17 | <i>Maximum current</i> | Defines the maximum allowed motor current. | 0.00 A | | | | | | | | | | | | | | | | | | | | | | | | | | | | | | | | | | | | | | | | | | | | | | | |
| | 0.00...30,000.00 A | Maximum motor current. | 1 = 1 A | | | | | | | | | | | | | | | | | | | | | | | | | | | | | | | | | | | | | | | | | | | | | | | |

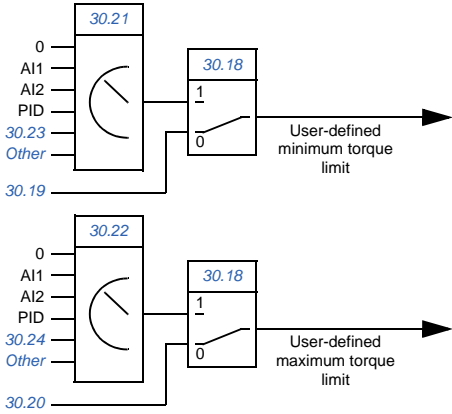
| Serial number | Name/Value | Description | Def/FbEq16 |
|---------------|-------------------------|-----------------------------------------------------------------------------------------------------------------------------------------------------------------------------------------------------------------------------------------------------------------------------------------------------------------------------------------------------------------------------------------------------------------------------------------------------------------------------------------------------------------------------------------------------------------------------------------------------------------------------------------------------------------------------------------------------------------------------------------------------------------------------------------------------------------------------------------------------------------------------------------------------------------------------------------------------------|---------------------------|
| 30.18 | <i>Torq lim sel</i> | <p>Selects a source that switches between two different predefined minimum torque limit sets.</p> <p>0 = minimum torque limit defined by 30.19 and maximum torque limit defined by 30.20 are active</p> <p>1 = minimum torque limit selected by 30.21 and maximum torque limit defined by 30.22 are active</p> <p>The user can define two sets of torque limits, and switch between the sets using a binary source such as a digital input.</p> <p>The first set of limits is defined by parameters 30.19 and 30.20. The second set has selector parameters for both the minimum (30.21) and maximum (30.22) limits that allows the use of a selectable analog source (such as an analog input).</p>  <p>Note: In addition to the user-defined limits, torque may be limited for other reasons (such as power limitation). See the block diagram on page 608.</p> | <i>Torque limit set 1</i> |
| | Torque limit set 1 | 0 (minimum torque limit defined by 30.19 and maximum torque limit defined by 30.20 are active). | 0 |
| | Torque limit set 2 | 1 (minimum torque limit selected by 30.21 and maximum torque limit defined by 30.22 are active). | 1 |
| | Reserved | | 8...10 |
| | EFB | Only for the DCU profile. DCU control word bit 15 received through the embedded fieldbus interface. | 11 |
| | <i>Other [bit]</i> | Source selection (see <i>Terms and abbreviations</i> on page 130). | - |
| 30.19 | <i>Minimum torque 1</i> | <p>Defines a minimum torque limit for the drive (in percent of nominal motor torque). See diagram at parameter 30.18 <i>Torq lim sel</i>.</p> <p>The limit is effective when</p> <ul style="list-style-type: none"> the source selected by 30.18 <i>Torq lim sel</i> is 0, or 30.18 is set to <i>Torque limit set 1</i>. | -300.0% |
| | -1600.0...0.0% | Minimum torque limit 1. | See par. 46.03 |

| Serial number | Name/Value | Description | Def/FbEq16 |
|---------------|----------------------------|-------------------------------------------------------------------------------------------------------------------------------------------------------------------------------------------------------------------------------------------------------------------------------------------------------------------------------------------------------------------------------------------------------------------------------------------------------------------------------------------|--------------------------------|
| 30.20 | <i>Maximum torque 1</i> | Defines a maximum torque limit for the drive (in percent of nominal motor torque). See diagram at parameter 30.18 Torq lim sel . The limit is effective when <ul style="list-style-type: none"> the source selected by 30.18 Torq lim sel is 0, or 30.18 is set to Torque limit set 1. | 300.0% |
| | 0.0...1600.0% | Maximum torque 1. | See par. 46.03 |
| 30.21 | <i>Min torque 2 source</i> | Defines the source of the minimum torque limit for the drive (in percent of nominal motor torque) when <ul style="list-style-type: none"> the source selected by parameter 30.18 Torq lim sel is 1, or 30.18 is set to Torque limit set 2. See diagram at 30.18 Torq lim sel . Note: Any positive values received from the selected source are inverted. | <i>Minimum torque 2</i> |
| | Zero | None. | 0 |
| | AI1 scaled | 12.12 AI1 scaled value (see page 152). | 1 |
| | AI2 scaled | 12.22 AI2 scaled value (see page 154). | 2 |
| | Reserved | | 3...14 |
| | PID | 40.01 PID output value (output of the process PID controller). | 15 |
| | Minimum torque 2 | 30.23 Minimum torque 2 . | 16 |
| | <i>Other</i> | Source selection (see Terms and abbreviations on page 130). | - |
| 30.22 | <i>Max torque 2 source</i> | Defines the source of the maximum torque limit for the drive (in percent of nominal motor torque) when <ul style="list-style-type: none"> the source selected by parameter 30.18 Torq lim sel is 1, or 30.18 is set to Torque limit set 2. See diagram at 30.18 Torq lim sel . Note: Any negative values received from the selected source are inverted. | <i>Maximum torque 2</i> |
| | Zero | None. | 0 |
| | AI1 scaled | 12.12 AI1 scaled value (see page 152). | 1 |
| | AI2 scaled | 12.22 AI2 scaled value (see page 154). | 2 |
| | Reserved | | 3...14 |
| | PID | 40.01 PID output value (output of the process PID controller). | 15 |
| | Maximum torque 2 | 30.24 Maximum torque 2 . | 16 |
| | <i>Other</i> | Source selection (see Terms and abbreviations on page 130). | - |
| 30.23 | <i>Minimum torque 2</i> | Defines the minimum torque limit for the drive (in percent of nominal motor torque) when <ul style="list-style-type: none"> the source selected by 30.18 Torq lim sel is 1, or 30.18 is set to Torque limit set 2 and <ul style="list-style-type: none"> 30.21 Min torque 2 source is set to Minimum torque 2. See diagram at 30.18 Torq lim sel . | -300.0% |
| | -1600.0...0.0% | Minimum torque limit 2. | See par. 46.03 |

| Serial number | Name/Value | Description | Def/FbEq16 |
|---------------|-------------------------------|-------------------------------------------------------------------------------------------------------------------------------------------------------------------------------------------------------------------------------------------------------------------------------------------------------------------------------------------------------------------------------------------------------------------------------------------------------------------------------------------------------------------------------------------------------------------------------|-----------------------|
| 30.24 | <i>Maximum torque 2</i> | Defines the maximum torque limit for the drive (in percent of nominal motor torque) when The limit is effective when <ul style="list-style-type: none"> the source selected by <i>30.18 Torq lim sel</i> is 1, or <i>30.18</i> is set to <i>Torque limit set 2</i> and <ul style="list-style-type: none"> <i>30.22 Max torque 2 source</i> is set to <i>Maximum torque 2</i>. See diagram at <i>30.18 Torq lim sel</i> . | 300.0% |
| | 0.0...1600.0% | Maximum torque limit 2. | See par. <i>46.03</i> |
| 30.26 | <i>Power motoring limit</i> | Defines the maximum allowed power fed by the inverter to the motor in percent of nominal motor power. | 300.00% |
| | 0.00...600.00% | Maximum motoring power. | 1 = 1% |
| 30.27 | <i>Power generating limit</i> | Defines the maximum allowed power fed by the motor to the inverter in percent of nominal motor power. Note: If your application, like a pump or a fan, requires that the motor must rotate in one direction only, use speed/frequency limit (<i>30.11 Minimum speed/30.13 Minimum frequency</i>), or direction limit (<i>20.21 Direction</i>) to achieve this. Do not set parameter <i>30.19 Minimum torque 1</i> or <i>30.27 Power generating limit</i> to 0%, as the drive is then not able to stop correctly. | -300.00% |
| | -600.00...0.00% | Maximum generating power. | 1 = 1% |
| 30.30 | <i>Overvoltage control</i> | Enables the overvoltage control of the intermediate DC bus. Fast braking of a high inertia load causes the voltage to rise to the overvoltage control limit. To prevent the DC voltage from exceeding the limit, the overvoltage controller automatically decreases the braking torque. Note: If the drive is equipped with a brake chopper and resistor, or a regenerative supply unit, the controller must be disabled. | Enabled |
| | inhibited | Overvoltage control disabled. | 0 |
| | Enabled | Overvoltage control enabled. | 1 |
| 30.31 | <i>Undervoltage control</i> | Enables the overvoltage control of the intermediate DC bus. If the DC voltage drops due to input power cut off, the undervoltage controller will automatically decrease the motor torque in order to keep the voltage above the lower limit. By decreasing the motor torque, the inertia of the load will cause regeneration back to the drive, keeping the DC bus charged and preventing an undervoltage trip until the motor coasts to a stop. This will act as voltage instantaneous interruption protection in systems with high inertia (such as a centrifuge or a fan). | Enabled |
| | Disabled | Undervoltage control disabled. | 0 |
| | Enabled | Undervoltage control enabled. | 1 |

204 Parameter

| Serial number | Name/Value | Description | Def/FbEq16 |
|---------------------------|--------------------------------|-------------------------------------------------------------------------------------------------------------------------------------------------------------------------|------------------------|
| 31 Fault functions | | | |
| | | Configuration of external events; selection of behavior of the drive upon fault situations. | |
| 31.01 | <i>External event 1 source</i> | Defines the source of external event 1. See also parameter <i>31.02 External event 1 type</i> . 0 = Trigger even 1 = Normal operation | Inactive (true) |
| | Active (false) | 0 | 0 |
| | Inactive (true) | 1 | 1 |
| | <i>Other [bit]</i> | Source selection (See <i>130 on page Terms and abbreviations</i>). | - |
| 31.02 | <i>External event 1 type</i> | Selects the type of external event 1. | Fault |
| | Fault | The external event generates a fault. | 0 |
| | Alarm | The external event generates a warning. | 1 |
| 31.03 | <i>External event 2 source</i> | Defines the source of external event 2. See also parameter <i>31.04 External event 2 type</i> . For selections, see parameter <i>31.01 External event 1 source</i> . | <i>Inactive (true)</i> |
| 31.04 | <i>External event 2 type</i> | Selects the type of external event 2. | Fault |
| | Fault | The external event generates a fault. | 0 |
| | Alarm | The external event generates a warning. | 1 |
| 31.05 | <i>External event 3 source</i> | Defines the source of external event 3. See also parameter <i>31.06 External event 3 type</i> . For selections, see parameter <i>31.01 External event 1 source</i> . | <i>Inactive (true)</i> |
| 31.06 | <i>External event 3 type</i> | Selects the type of external event 3. | Fault |
| | Fault | The external event generates a fault. | 0 |
| | Alarm | The external event generates a warning. | 1 |
| 31.07 | <i>External event 4 source</i> | Defines the source of external event 4. See also parameter <i>31.08 External event 4 type</i> . For selections, see parameter <i>31.01 External event 1 source</i> . | <i>Inactive (true)</i> |
| 31.08 | <i>External event 4 type</i> | Selects the type of external event 4. | Fault |
| | Fault | The external event generates a fault. | 0 |
| | Alarm | The external event generates a warning. | 1 |
| 31.09 | <i>External event 5 source</i> | Defines the source of external event 5. See also parameter <i>31.10 External event 5 type</i> . For selections, see parameter <i>31.01 External event 1 source</i> . | <i>Inactive (true)</i> |
| 31.10 | <i>External event 5 type</i> | Selects the type of external event 5. | Fault |
| | Fault | The external event generates a fault. | 0 |
| | Alarm | The external event generates a warning. | 1 |

| Serial number | Name/Value | Description | Def/FbEq16 | | | | | | | | | | | | | | | | | | | | | | | | |
|---------------|----------------------------------------------------------------------------------------------------------------------------------------------------------------------------------------------------------------------------------------------------------------------------------------------------------------------------------------------------------------------------------------------------------------------------------------------------------------------------------------------------------------------------------------------------------------------------------------------------------------------------------------------------------------------------------------------------------------------------------------------------------------------------------------------------------------------------------------------------------------------------------------------------------------------------------------------------------------------------------------------------------------------------------------------------------------------------------|---------------------------------------------------------------------------------------------------------------------------------------------------------------------------------------------------------------------------------------------------------------------------------------------------------------------------------------------------------------------------------------------------------------------------|--------------|--------|-------|---|--------------|---|-------------|---|--------------|---|----------------------|-------|---------|----|--------------------------------------------------------------------------------------|----|----------------------------------------------------------------------------------------|----|----------------------------------------------------------------------------------------|----|----------------------------------------------------------------------------------------|----|----------------------------------------------------------------------------------------|----|----------------------------------------------------------------------------------------|
| 31.11 | <i>Fault reset selection</i> | Selects the source of an external fault reset signal. The signal resets the drive after a fault trip if the cause of the fault no longer exists. 0 -> 1 = Reset Note: A fault reset from the fieldbus interface is always observed regardless of this parameter. | Not selected | | | | | | | | | | | | | | | | | | | | | | | | |
| | Not selected | 0. | 0 | | | | | | | | | | | | | | | | | | | | | | | | |
| | Select | 1. | 1 | | | | | | | | | | | | | | | | | | | | | | | | |
| | Timed function 1 | 34.01 Bit 0 of <i>Combined timer status</i> (See page 218). | 18 | | | | | | | | | | | | | | | | | | | | | | | | |
| | Timed function 2 | 34.01 Bit 1 of <i>Combined timer status</i> (See page 218). | 19 | | | | | | | | | | | | | | | | | | | | | | | | |
| | Timed function 3 | 34.01 Bit 2 of <i>Combined timer status</i> (See page 218). | 20 | | | | | | | | | | | | | | | | | | | | | | | | |
| | Monitor 1 | 32.01 Bit 0 of <i>Supervision status word</i> (See page 211). | 24 | | | | | | | | | | | | | | | | | | | | | | | | |
| | Monitor 2 | 32.01 Bit 1 of <i>Supervision status word</i> (See page 211). | 25 | | | | | | | | | | | | | | | | | | | | | | | | |
| | Monitor 3 | 32.01 Bit 2 of <i>Supervision status word</i> (See page 211). | 26 | | | | | | | | | | | | | | | | | | | | | | | | |
| | <i>Other [bit]</i> | Source selection (See 130 on page <i>Terms and abbreviations</i>). | - | | | | | | | | | | | | | | | | | | | | | | | | |
| 31.12 | <i>Autoreset selection</i> | Selects faults that are automatically reset. The parameter is a 16-bit word with each bit corresponding to a fault type. Whenever a bit is set to 1, the corresponding fault is automatically reset. Note: The autoreset function is only available in external control; See section <i>Local control vs. external control</i> (page 63). The bits of this binary number correspond to the following faults: | 0000h | | | | | | | | | | | | | | | | | | | | | | | | |
| | <table border="1"> <thead> <tr> <th>Bit(s)</th> <th>Fault</th> </tr> </thead> <tbody> <tr> <td>0</td> <td>Over current</td> </tr> <tr> <td>1</td> <td>Overvoltage</td> </tr> <tr> <td>2</td> <td>Undervoltage</td> </tr> <tr> <td>3</td> <td>AI supervision fault</td> </tr> <tr> <td>4...9</td> <td>Reserve</td> </tr> <tr> <td>10</td> <td>Self-defined auto reset fault (See par. 31.13 <i>Self-defined auto reset fault</i>)</td> </tr> <tr> <td>11</td> <td>External fault 1 (source selected 31.01 <i>External event 1 source</i> from parameter)</td> </tr> <tr> <td>12</td> <td>External fault 2 (source selected 31.03 <i>External event 2 source</i> from parameter)</td> </tr> <tr> <td>13</td> <td>External fault 3 (source selected 31.05 <i>External event 3 source</i> from parameter)</td> </tr> <tr> <td>14</td> <td>External fault 4 (source selected 31.07 <i>External event 4 source</i> from parameter)</td> </tr> <tr> <td>15</td> <td>External fault 5 (source selected 31.09 <i>External event 5 source</i> from parameter)</td> </tr> </tbody> </table> | | | Bit(s) | Fault | 0 | Over current | 1 | Overvoltage | 2 | Undervoltage | 3 | AI supervision fault | 4...9 | Reserve | 10 | Self-defined auto reset fault (See par. 31.13 <i>Self-defined auto reset fault</i>) | 11 | External fault 1 (source selected 31.01 <i>External event 1 source</i> from parameter) | 12 | External fault 2 (source selected 31.03 <i>External event 2 source</i> from parameter) | 13 | External fault 3 (source selected 31.05 <i>External event 3 source</i> from parameter) | 14 | External fault 4 (source selected 31.07 <i>External event 4 source</i> from parameter) | 15 | External fault 5 (source selected 31.09 <i>External event 5 source</i> from parameter) |
| Bit(s) | Fault | | | | | | | | | | | | | | | | | | | | | | | | | | |
| 0 | Over current | | | | | | | | | | | | | | | | | | | | | | | | | | |
| 1 | Overvoltage | | | | | | | | | | | | | | | | | | | | | | | | | | |
| 2 | Undervoltage | | | | | | | | | | | | | | | | | | | | | | | | | | |
| 3 | AI supervision fault | | | | | | | | | | | | | | | | | | | | | | | | | | |
| 4...9 | Reserve | | | | | | | | | | | | | | | | | | | | | | | | | | |
| 10 | Self-defined auto reset fault (See par. 31.13 <i>Self-defined auto reset fault</i>) | | | | | | | | | | | | | | | | | | | | | | | | | | |
| 11 | External fault 1 (source selected 31.01 <i>External event 1 source</i> from parameter) | | | | | | | | | | | | | | | | | | | | | | | | | | |
| 12 | External fault 2 (source selected 31.03 <i>External event 2 source</i> from parameter) | | | | | | | | | | | | | | | | | | | | | | | | | | |
| 13 | External fault 3 (source selected 31.05 <i>External event 3 source</i> from parameter) | | | | | | | | | | | | | | | | | | | | | | | | | | |
| 14 | External fault 4 (source selected 31.07 <i>External event 4 source</i> from parameter) | | | | | | | | | | | | | | | | | | | | | | | | | | |
| 15 | External fault 5 (source selected 31.09 <i>External event 5 source</i> from parameter) | | | | | | | | | | | | | | | | | | | | | | | | | | |
| | 0000h...FFFFh | Automatic reset configuration word. | 1 = 1 | | | | | | | | | | | | | | | | | | | | | | | | |
| 31.13 | <i>Self-defined auto reset fault</i> | Defines the fault that can be automatically reset using parameter 31.12 <i>Autoreset selection</i> , bit 10. The faults are listed in chapter <i>Fault tracing</i> (page 351). Note: The fault codes are in hexadecimal. The selected code must be converted to decimal for this parameter. | 0 | | | | | | | | | | | | | | | | | | | | | | | | |
| | 0000h...FFFFh | Fault code. | 10 = 1 | | | | | | | | | | | | | | | | | | | | | | | | |

| Serial number | Name/Value | Description | Def/FbEq16 |
|---------------|--------------------------|--------------------------------------------------------------------------------------------------------------------------------------------------------------------------------------------|--------------|
| 31.14 | <i>Number of trials</i> | Defines the number of automatic fault resets the drive performs within the time defined by parameter <i>31.15 Trial time</i> . | 0 |
| | 0...5 | Number of automatic resets. | 10 = 1 |
| 31.15 | <i>Trial time</i> | Defines the time the automatic reset function will attempt to reset the drive. During this time, it will perform the number of automatic resets defined by <i>31.14 Number of trials</i> . | 30.0 s |
| | 1.0...600.0 s | Autoreset time. | 10 = 1s |
| 31.16 | <i>Delay time</i> | Defines the time that the drive will wait after a fault before attempting an automatic reset. See parameter <i>31.12 Autoreset selection</i> . | 0.0 s |
| | 0.0...120.0 s | Autoreset delay. | 10 = 1s |
| 31.19 | <i>Motor phase loss</i> | Selects how the drive reacts when a motor phase loss is detected. | Fault |
| | No action | No action is taken. | 0 |
| | Fault | The drive trips on <i>3381 Output phase loss</i> . | 1 |
| 31.20 | <i>Ground fault</i> | Selects how the drive reacts when an earth fault or current unbalance is detected in the motor or the motor cable. | <i>Fault</i> |
| | No action | No action is taken. | 0 |
| | Alarm | The drive generates <i>A2B3 Earth leakage</i> a warning. | 1 |
| | Fault | The drive trips on <i>2330 Earth leakage</i> . | 2 |
| 31.21 | <i>Supply phase loss</i> | Selects how the drive reacts when a supply phase loss is detected. | <i>Fault</i> |
| | No action | No action is taken. | 0 |
| | Fault | The drive trips on <i>3130 Supply phase loss</i> . | 1 |

| Serial number | Name/Value | Description | Def/FbEq16 | | | | | | | | | | | | | | | | | | | | | | | | |
|---------------|--------------------------------|--------------------------------------------------------------------------------------------------------------------------------------------------------------------------------------------------------------------------------------------------------------------------------------------------------------------------------------------------------------------------------------------------------------------------------------------------------------------------------------------------------------------------------------------------------------------------------------------------------------------------------------------------------------------------------------------------------------------------------------------------------------------------------------------------------------------------------------------------------------------------------------------------------------------------------------|---------------------------------------------------------------------------------|--|---------------------------------|-----|-----|-----|---------|--------------------------------------|---|---|---------------------------------------------------------------------------|--------------------------------------|---|---------------------------------------------------------------------------|---------------------------------------------------------------------------|---------------------------------------------------------------------------------|--------------------|---|---------------------------------------------------------------------------|---------------------------------------------------------------------------------|---|---|--------------------|--|---|
| 31.22 | <i>STO indication run/stop</i> | <p>Selects which indications are given when one or both Safe torque off (STO) signals are switched off or lost. The indications also depend on whether the drive is running or stopped when this occurs.</p> <p>The tables at each selection below show the indications generated with that particular setting.</p> <p>Notes:</p> <ul style="list-style-type: none"> This parameter does not affect the operation of the STO function itself. The STO function will operate regardless of the setting of this parameter: a running drive will stop upon removal of one or both STO signals, and will not start until both STO signals are restored and all faults reset. The loss of only one STO signal always generates a fault as it is interpreted as a malfunction. <p>For more information on the STO, See chapter The Safe torque off function in the <i>Hardware manual of the drive</i>.</p> | Fault/Fault | | | | | | | | | | | | | | | | | | | | | | | | |
| | Fault/Fault | <table border="1"> <thead> <tr> <th colspan="2">In</th> <th rowspan="2">Indication (running or stopped)</th> </tr> <tr> <th>in1</th> <th>in2</th> </tr> </thead> <tbody> <tr> <td>0</td> <td>0</td> <td>Fault <i>5091 Delete safe torque</i></td> </tr> <tr> <td>0</td> <td>1</td> <td>Fault <i>5091 Delete safe torque</i> and <i>FA81 Delete safe torque 1</i></td> </tr> <tr> <td>1</td> <td>0</td> <td>Fault <i>5091 Delete safe torque</i> and <i>FA82 Delete safe torque 2</i></td> </tr> <tr> <td>1</td> <td>1</td> <td>(Normal operation)</td> </tr> </tbody> </table> | In | | Indication (running or stopped) | in1 | in2 | 0 | 0 | Fault <i>5091 Delete safe torque</i> | 0 | 1 | Fault <i>5091 Delete safe torque</i> and <i>FA81 Delete safe torque 1</i> | 1 | 0 | Fault <i>5091 Delete safe torque</i> and <i>FA82 Delete safe torque 2</i> | 1 | 1 | (Normal operation) | 0 | | | | | | | |
| In | | Indication (running or stopped) | | | | | | | | | | | | | | | | | | | | | | | | | |
| in1 | in2 | | | | | | | | | | | | | | | | | | | | | | | | | | |
| 0 | 0 | Fault <i>5091 Delete safe torque</i> | | | | | | | | | | | | | | | | | | | | | | | | | |
| 0 | 1 | Fault <i>5091 Delete safe torque</i> and <i>FA81 Delete safe torque 1</i> | | | | | | | | | | | | | | | | | | | | | | | | | |
| 1 | 0 | Fault <i>5091 Delete safe torque</i> and <i>FA82 Delete safe torque 2</i> | | | | | | | | | | | | | | | | | | | | | | | | | |
| 1 | 1 | (Normal operation) | | | | | | | | | | | | | | | | | | | | | | | | | |
| | Faults/Warnings | <table border="1"> <thead> <tr> <th colspan="2">In</th> <th colspan="2">Indications</th> </tr> <tr> <th>in1</th> <th>in2</th> <th>Running</th> <th>Stopped</th> </tr> </thead> <tbody> <tr> <td>0</td> <td>0</td> <td>Fault <i>5091 Delete safe torque</i></td> <td>Alarm <i>A5A0 Delete safe torque</i></td> </tr> <tr> <td>0</td> <td>1</td> <td>Fault <i>5091 Delete safe torque</i> and <i>FA81 Delete safe torque 1</i></td> <td>Alarm <i>A5A0 Delete safe torque</i> and Fault <i>FA81 Delete safe torque 1</i></td> </tr> <tr> <td>1</td> <td>0</td> <td>Fault <i>5091 Delete safe torque</i> and <i>FA82 Delete safe torque 2</i></td> <td>Alarm <i>A5A0 Delete safe torque</i> and Fault <i>FA82 Delete safe torque 2</i></td> </tr> <tr> <td>1</td> <td>1</td> <td colspan="2">(Normal operation)</td> </tr> </tbody> </table> | In | | Indications | | in1 | in2 | Running | Stopped | 0 | 0 | Fault <i>5091 Delete safe torque</i> | Alarm <i>A5A0 Delete safe torque</i> | 0 | 1 | Fault <i>5091 Delete safe torque</i> and <i>FA81 Delete safe torque 1</i> | Alarm <i>A5A0 Delete safe torque</i> and Fault <i>FA81 Delete safe torque 1</i> | 1 | 0 | Fault <i>5091 Delete safe torque</i> and <i>FA82 Delete safe torque 2</i> | Alarm <i>A5A0 Delete safe torque</i> and Fault <i>FA82 Delete safe torque 2</i> | 1 | 1 | (Normal operation) | | 1 |
| In | | Indications | | | | | | | | | | | | | | | | | | | | | | | | | |
| in1 | in2 | Running | Stopped | | | | | | | | | | | | | | | | | | | | | | | | |
| 0 | 0 | Fault <i>5091 Delete safe torque</i> | Alarm <i>A5A0 Delete safe torque</i> | | | | | | | | | | | | | | | | | | | | | | | | |
| 0 | 1 | Fault <i>5091 Delete safe torque</i> and <i>FA81 Delete safe torque 1</i> | Alarm <i>A5A0 Delete safe torque</i> and Fault <i>FA81 Delete safe torque 1</i> | | | | | | | | | | | | | | | | | | | | | | | | |
| 1 | 0 | Fault <i>5091 Delete safe torque</i> and <i>FA82 Delete safe torque 2</i> | Alarm <i>A5A0 Delete safe torque</i> and Fault <i>FA82 Delete safe torque 2</i> | | | | | | | | | | | | | | | | | | | | | | | | |
| 1 | 1 | (Normal operation) | | | | | | | | | | | | | | | | | | | | | | | | | |

| Serial number | Name/Value | Description | Def/FbEq16 | | | | | | | | | | | | | | | | | | | | | | | | |
|---------------|------------------------------|------------------------------------------------------------------------------------------------------------------------------------------------------------------------------------------------------------------------------------------------------------------------------------------------------------------------------------------------------------------------------------------------------------------------------------------------------------------------------------------------------------------------------------------------------------------------------------------------------------------------------------------------------------------------------------------------------------------------------------------------------------------------------------------------------------------------------------------|---------------------------------------------------------------------------------|--|---------------------------------|-----|-----|-----|---------|--------------------------------------|---|---|---------------------------------------------------------------------------------|--------------------------------------|---|---------------------------------------------------------------------------------|---------------------------------------------------------------------------|---------------------------------------------------------------------------------|--------------------|---|---------------------------------------------------------------------------|---------------------------------------------------------------------------------|---|---|--------------------|--|---|
| | Fault/Event | <table border="1"> <thead> <tr> <th colspan="2">In</th> <th colspan="2">Indications</th> </tr> <tr> <th>in1</th> <th>in2</th> <th>Running</th> <th>Stopped</th> </tr> </thead> <tbody> <tr> <td>0</td> <td>0</td> <td>Fault <i>5091 Delete safe torque</i></td> <td>Event <i>B5A0 Delete safe torque</i></td> </tr> <tr> <td>0</td> <td>1</td> <td>Fault <i>5091 Delete safe torque</i> and <i>FA81 Delete safe torque 1</i></td> <td>Event <i>B5A0 Delete safe torque</i> and Fault <i>FA81 Delete safe torque 1</i></td> </tr> <tr> <td>1</td> <td>0</td> <td>Fault <i>5091 Delete safe torque</i> and <i>FA82 Delete safe torque 2</i></td> <td>Event <i>B5A0 Delete safe torque</i> and Fault <i>FA82 Delete safe torque 2</i></td> </tr> <tr> <td>1</td> <td>1</td> <td colspan="2">(Normal operation)</td> </tr> </tbody> </table> | In | | Indications | | in1 | in2 | Running | Stopped | 0 | 0 | Fault <i>5091 Delete safe torque</i> | Event <i>B5A0 Delete safe torque</i> | 0 | 1 | Fault <i>5091 Delete safe torque</i> and <i>FA81 Delete safe torque 1</i> | Event <i>B5A0 Delete safe torque</i> and Fault <i>FA81 Delete safe torque 1</i> | 1 | 0 | Fault <i>5091 Delete safe torque</i> and <i>FA82 Delete safe torque 2</i> | Event <i>B5A0 Delete safe torque</i> and Fault <i>FA82 Delete safe torque 2</i> | 1 | 1 | (Normal operation) | | 2 |
| In | | Indications | | | | | | | | | | | | | | | | | | | | | | | | | |
| in1 | in2 | Running | Stopped | | | | | | | | | | | | | | | | | | | | | | | | |
| 0 | 0 | Fault <i>5091 Delete safe torque</i> | Event <i>B5A0 Delete safe torque</i> | | | | | | | | | | | | | | | | | | | | | | | | |
| 0 | 1 | Fault <i>5091 Delete safe torque</i> and <i>FA81 Delete safe torque 1</i> | Event <i>B5A0 Delete safe torque</i> and Fault <i>FA81 Delete safe torque 1</i> | | | | | | | | | | | | | | | | | | | | | | | | |
| 1 | 0 | Fault <i>5091 Delete safe torque</i> and <i>FA82 Delete safe torque 2</i> | Event <i>B5A0 Delete safe torque</i> and Fault <i>FA82 Delete safe torque 2</i> | | | | | | | | | | | | | | | | | | | | | | | | |
| 1 | 1 | (Normal operation) | | | | | | | | | | | | | | | | | | | | | | | | | |
| | Alarm/Alarm | <table border="1"> <thead> <tr> <th colspan="2">In</th> <th rowspan="2">Indication (running or stopped)</th> </tr> <tr> <th>in1</th> <th>in2</th> </tr> </thead> <tbody> <tr> <td>0</td> <td>0</td> <td>Alarm <i>A5A0 Delete safe torque</i></td> </tr> <tr> <td>0</td> <td>1</td> <td>Alarm <i>A5A0 Delete safe torque</i> and Fault <i>FA81 Delete safe torque 1</i></td> </tr> <tr> <td>1</td> <td>0</td> <td>Alarm <i>A5A0 Delete safe torque</i> and Fault <i>FA82 Delete safe torque 2</i></td> </tr> <tr> <td>1</td> <td>1</td> <td>(Normal operation)</td> </tr> </tbody> </table> | In | | Indication (running or stopped) | in1 | in2 | 0 | 0 | Alarm <i>A5A0 Delete safe torque</i> | 0 | 1 | Alarm <i>A5A0 Delete safe torque</i> and Fault <i>FA81 Delete safe torque 1</i> | 1 | 0 | Alarm <i>A5A0 Delete safe torque</i> and Fault <i>FA82 Delete safe torque 2</i> | 1 | 1 | (Normal operation) | 3 | | | | | | | |
| In | | Indication (running or stopped) | | | | | | | | | | | | | | | | | | | | | | | | | |
| in1 | in2 | | | | | | | | | | | | | | | | | | | | | | | | | | |
| 0 | 0 | Alarm <i>A5A0 Delete safe torque</i> | | | | | | | | | | | | | | | | | | | | | | | | | |
| 0 | 1 | Alarm <i>A5A0 Delete safe torque</i> and Fault <i>FA81 Delete safe torque 1</i> | | | | | | | | | | | | | | | | | | | | | | | | | |
| 1 | 0 | Alarm <i>A5A0 Delete safe torque</i> and Fault <i>FA82 Delete safe torque 2</i> | | | | | | | | | | | | | | | | | | | | | | | | | |
| 1 | 1 | (Normal operation) | | | | | | | | | | | | | | | | | | | | | | | | | |
| 31.23 | <i>Cross connection</i> | Selects how the drive reacts to incorrect input power and motor cable connection (i.e. input power cable is connected to drive motor connection). | Fault | | | | | | | | | | | | | | | | | | | | | | | | |
| | No action | No action is taken. | 0 | | | | | | | | | | | | | | | | | | | | | | | | |
| | Fault | The drive trips on <i>3181 Cross connection</i> . | 1 | | | | | | | | | | | | | | | | | | | | | | | | |
| 31.24 | <i>Stall function</i> | Selects how the drive reacts to a motor stall condition. A stall condition is defined as follows: <ul style="list-style-type: none"> • The drive exceeds the stall current limit (<i>31.25 Stall current limit</i>), and • the output frequency is below the level set by parameter <i>31.27 Stall frequency limit</i> or the motor speed is below the level set by parameter <i>31.26 Stall frequency limit</i>, and • the conditions above have been true longer than the time set by parameter <i>31.28 Stall time</i>. | No action | | | | | | | | | | | | | | | | | | | | | | | | |
| | No action | None (stall supervision disabled). | 0 | | | | | | | | | | | | | | | | | | | | | | | | |
| | Alarm | The drive generates <i>A780 Motor stall</i> a warning. | 1 | | | | | | | | | | | | | | | | | | | | | | | | |
| | Fault | The drive trips on <i>7121 Motor stall</i> . | 2 | | | | | | | | | | | | | | | | | | | | | | | | |
| 31.25 | <i>Stall current limit</i> | Stall current limit in percent of the nominal current of the motor. See parameter <i>31.24 Stall function</i> . | 200.0% | | | | | | | | | | | | | | | | | | | | | | | | |
| | 0.0...1600.0% | Stall current limit. | - | | | | | | | | | | | | | | | | | | | | | | | | |
| 31.27 | <i>Stall frequency limit</i> | Stall frequency limit. See parameter <i>31.24 Stall function</i> . Note: Setting the limit below 10 Hz is not recommended. | 15.00 Hz | | | | | | | | | | | | | | | | | | | | | | | | |
| | 0.00...1,000.00 Hz | Stall frequency limit. | See parameter <i>46.02</i> | | | | | | | | | | | | | | | | | | | | | | | | |

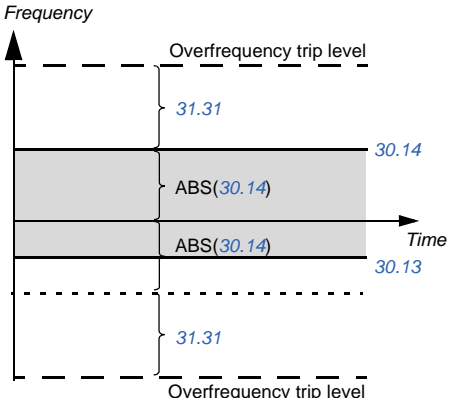
| Serial number | Name/Value | Description | Def/FbEq16 |
|---------------|-----------------------------------|--------------------------------------------------------------------------------------------------------------------------------------------------------------------------------------------------------------------------------------------------------------------------------------------------------------------------------------------------------------------------------------------------------------------------------------------------------------------------------------------------------------------------------------------------------------------------------------------------------------------------------------------------------------------------------------------------------------------------------------------------------------------------------------------------------------------------------------------------------------------------------------------------------------------------------------------------------------------------------------------------------------------------------------------------------------------------------------------------------------------------------------------------------------------------------------------------------------|------------|
| 31.28 | <i>Stall time</i> | Stall time. See parameter 31.24 Stall function . | 20 s |
| | 0...3600 s | Stall time. | - |
| 31.31 | <i>Frequency trip margin</i> | <p>Defines, together with 30.13 Minimum frequency and 30.14 Maximum frequency, the maximum allowed frequency of the motor (overfrequency protection). The absolute value of this overfrequency trip level is calculated by adding the value of this parameter to the higher of the absolute values of 30.13 Minimum frequency and 30.14 Maximum frequency.</p> <p>If the output frequency (01.06 Output frequency) exceeds the overfrequency trip level (ie. the absolute value of the output frequency exceeds the absolute value of the overfrequency trip level), the drive trips on the 73F0 Overfrequency fault.</p>  | 15.00 Hz |
| | 0.00...10000.00 Hz | Overfrequency trip margin. | 1 = 1 Hz |
| 31.32 | <i>Emergency ramp supervision</i> | <p>Parameters 31.32 Emergency ramp supervision and 31.36 Screen auxiliary fan fault provide a supervision function for emergency stop modes Off1 and Off3.</p> <p>The supervision is based on either</p> <ul style="list-style-type: none"> observing the time within which the motor stops, or comparing the actual and expected deceleration rates. <p>If this parameter is set to 0%, the maximum stop time is directly set in parameter 31.36. Otherwise, 31.32 defines the maximum allowed deviation from the expected deceleration rate, which is calculated from parameters 23.11...23.15 (Off1) or 23.23 Emergency stop time (Off3). If the actual deceleration rate deviates too much from the expected rate, the drive trips on 73B0 Emergency ramp failed, sets bit 8 of 06.17 Drive status word 2, and coasts to a stop.</p> <p>If 31.32 is set to 0% and 31.36 is set to 0 s, the emergency stop ramp supervision is disabled.</p> <p>See also parameter 21.04 Emergency stop mode.</p> | 0% |
| | 0...300% | Maximum deviation from expected deceleration rate. | 1 = 1% |

| Serial number | Name/Value | Description | Def/FbEq16 | | | | | | | | | | | | | | | | | | | | | |
|---------------|----------------------------------------------------------------------------------------------------------------------------------------------------------------------------------------------------------------------------------------------------------------------------------------------------------------------------------------------------------------------------------------------------------------------------------------------------------------------------------------------------------------------------------------------------------------------------------------------------------------------------------------------------------------------------------------|-------------------------------------------------------------------------------------------------------------------------------------------------------------------------------------------------------------------------------------------------------------------------------------------------------------------------------------------------------------------------------------------------------------------------------------------------------------------------------------------------------------------------------------------------------------------------------------------------------------------------|--------------|-----|------|-------------|---|----------|--|---|----------------------|-------------------------------------------------------------|-------|----------|--|---|-----------------------|--------------------------------------------------------------|---|-------------------------------|----------------------------------------------------------------------|--------|----------|--|
| 31.33 | <i>Emergency ramp supervision delay</i> | If parameter <i>31.32 Emergency ramp supervision</i> is set to 0%, this parameter defines the maximum time an emergency stop (mode Off1 or Off3) is allowed to take. If the motor has not stopped when the time elapses, the drive trips on <i>73B0 Emergency ramp failed</i> , sets bit 8 of <i>06.17 Drive status word 2</i> , and coasts to a stop. If <i>31.32</i> is set to a value other than 0%, this parameter defines a delay between the receipt of the emergency stop command and the activation of the supervision. ABB recommends to specify a short delay to allow the speed change rate to stabilize. | 0 s | | | | | | | | | | | | | | | | | | | | | |
| | 0...100 s | Maximum ramp-down time, or supervision activation delay. | 1 = 1 s | | | | | | | | | | | | | | | | | | | | | |
| 31.36 | <i>Screen auxiliary fan fault</i> | Screen auxiliary fan fault | Off | | | | | | | | | | | | | | | | | | | | | |
| | - | default =Off [0] Temporary Screen =[1] | - | | | | | | | | | | | | | | | | | | | | | |
| 31.40 | <i>Disable warning messages</i> | Selects warnings to be suppressed. This parameter is a 16-bit word with each bit corresponding to a warning. Whenever a bit is set to 1, the corresponding warning is suppressed. | 0000h | | | | | | | | | | | | | | | | | | | | | |
| | <table border="1"> <thead> <tr> <th>Bit</th> <th>Name</th> <th>Description</th> </tr> </thead> <tbody> <tr> <td>0</td> <td>Reserved</td> <td></td> </tr> <tr> <td>1</td> <td>DC link undervoltage</td> <td>1 = Warning <i>A3A2 DC link undervoltage</i> is suppressed.</td> </tr> <tr> <td>2...4</td> <td>Reserved</td> <td></td> </tr> <tr> <td>5</td> <td>Emergency stop (off2)</td> <td>1 = Warning <i>AFE1 Emergency stop (off2)</i> is suppressed.</td> </tr> <tr> <td>6</td> <td>Emergency stop (off1 or off3)</td> <td>1 = Warning <i>AFE2 Emergency stop (off1 or off3)</i> is suppressed.</td> </tr> <tr> <td>7...15</td> <td>Reserved</td> <td></td> </tr> </tbody> </table> | | | Bit | Name | Description | 0 | Reserved | | 1 | DC link undervoltage | 1 = Warning <i>A3A2 DC link undervoltage</i> is suppressed. | 2...4 | Reserved | | 5 | Emergency stop (off2) | 1 = Warning <i>AFE1 Emergency stop (off2)</i> is suppressed. | 6 | Emergency stop (off1 or off3) | 1 = Warning <i>AFE2 Emergency stop (off1 or off3)</i> is suppressed. | 7...15 | Reserved | |
| Bit | Name | Description | | | | | | | | | | | | | | | | | | | | | | |
| 0 | Reserved | | | | | | | | | | | | | | | | | | | | | | | |
| 1 | DC link undervoltage | 1 = Warning <i>A3A2 DC link undervoltage</i> is suppressed. | | | | | | | | | | | | | | | | | | | | | | |
| 2...4 | Reserved | | | | | | | | | | | | | | | | | | | | | | | |
| 5 | Emergency stop (off2) | 1 = Warning <i>AFE1 Emergency stop (off2)</i> is suppressed. | | | | | | | | | | | | | | | | | | | | | | |
| 6 | Emergency stop (off1 or off3) | 1 = Warning <i>AFE2 Emergency stop (off1 or off3)</i> is suppressed. | | | | | | | | | | | | | | | | | | | | | | |
| 7...15 | Reserved | | | | | | | | | | | | | | | | | | | | | | | |
| | 0000h...FFFFh | Word for disabling warnings. | 1 = 1 | | | | | | | | | | | | | | | | | | | | | |
| 31.54 | <i>Fault action</i> | Selects the stop mode when a non-critical fault occurs. | <i>Coast</i> | | | | | | | | | | | | | | | | | | | | | |
| | Coast | Drive coasts to a stop. | 0 | | | | | | | | | | | | | | | | | | | | | |
| | Emergency ramp | Drive follows the ramp specified for an emergency stop in parameter <i>23.23 Emergency stop time</i> . | 1 | | | | | | | | | | | | | | | | | | | | | |

| Serial number | Name/Value | Description | Def/FbEq16 | | | | | | | | | | | | | | | | | | | | | | | | |
|-----------------------------------------------------------------------------------------------------------------------------------------------------------------------------------------------------------------------------------------------------------------------------------------------------------------------------------------------------------------------------------------------------------------------------------------------------------------------------------------------------------------------------------------------------------------------------------------------------------------------------------------------------------------------------------------------------------------------------------------------------------------------------------------------------------------------------------------------------------------------------------------|--------------------------------|------------------------------------------------------------------------------------------------------------------------------------------------------------------------------------------------------------------------------------------------------------------------------------------------|------------|--------|------|-------------|---|----------------------|-----------------------------------------------------|---|----------------------|-----------------------------------------------------|---|----------------------|-----------------------------------------------------|---|----------------------|-----------------------------------------------------|---|----------------------|-----------------------------------------------------|---|----------------------|-----------------------------------------------------|--------|---------|--|
| 32 Supervision | | Configuration of signal supervision functions 1...3. Three values can be chosen to be monitored; a warning or fault is generated whenever predefined limits are exceeded. See also section <i>Signal supervision</i> (page 92). | | | | | | | | | | | | | | | | | | | | | | | | | |
| 32.01 | <i>Supervision status word</i> | Signal supervision status word. Indicates whether the values monitored by the signal supervision functions are within or outside their respective limits. Note: This word is independent of the drive actions defined by parameters 32.06 , 32.16 , 32.26 , 32.36 , 32.46 and 32.56. | 000b | | | | | | | | | | | | | | | | | | | | | | | | |
| <table border="1"> <thead> <tr> <th>Bit(s)</th> <th>Name</th> <th>Description</th> </tr> </thead> <tbody> <tr> <td>0</td> <td>Supervision 1 active</td> <td>1 = Signal selected by 32.07 is outside its limits.</td> </tr> <tr> <td>1</td> <td>Supervision 2 active</td> <td>1 = Signal selected by 32.17 is outside its limits.</td> </tr> <tr> <td>2</td> <td>Supervision 3 active</td> <td>1 = Signal selected by 32.27 is outside its limits.</td> </tr> <tr> <td>3</td> <td>Supervision 4 active</td> <td>1 = Signal selected by 32.37 is outside its limits.</td> </tr> <tr> <td>4</td> <td>Supervision 5 active</td> <td>1 = Signal selected by 32.47 is outside its limits.</td> </tr> <tr> <td>5</td> <td>Supervision 6 active</td> <td>1 = Signal selected by 32.27 is outside its limits.</td> </tr> <tr> <td>6...15</td> <td>Reserve</td> <td></td> </tr> </tbody> </table> | | | | Bit(s) | Name | Description | 0 | Supervision 1 active | 1 = Signal selected by 32.07 is outside its limits. | 1 | Supervision 2 active | 1 = Signal selected by 32.17 is outside its limits. | 2 | Supervision 3 active | 1 = Signal selected by 32.27 is outside its limits. | 3 | Supervision 4 active | 1 = Signal selected by 32.37 is outside its limits. | 4 | Supervision 5 active | 1 = Signal selected by 32.47 is outside its limits. | 5 | Supervision 6 active | 1 = Signal selected by 32.27 is outside its limits. | 6...15 | Reserve | |
| Bit(s) | Name | Description | | | | | | | | | | | | | | | | | | | | | | | | | |
| 0 | Supervision 1 active | 1 = Signal selected by 32.07 is outside its limits. | | | | | | | | | | | | | | | | | | | | | | | | | |
| 1 | Supervision 2 active | 1 = Signal selected by 32.17 is outside its limits. | | | | | | | | | | | | | | | | | | | | | | | | | |
| 2 | Supervision 3 active | 1 = Signal selected by 32.27 is outside its limits. | | | | | | | | | | | | | | | | | | | | | | | | | |
| 3 | Supervision 4 active | 1 = Signal selected by 32.37 is outside its limits. | | | | | | | | | | | | | | | | | | | | | | | | | |
| 4 | Supervision 5 active | 1 = Signal selected by 32.47 is outside its limits. | | | | | | | | | | | | | | | | | | | | | | | | | |
| 5 | Supervision 6 active | 1 = Signal selected by 32.27 is outside its limits. | | | | | | | | | | | | | | | | | | | | | | | | | |
| 6...15 | Reserve | | | | | | | | | | | | | | | | | | | | | | | | | | |
| | 000...111b | Signal supervision status word. | 1 = 1 | | | | | | | | | | | | | | | | | | | | | | | | |
| 32.05 | <i>Supervision 1 function</i> | Selects the mode of signal supervision function 1. Determines how the monitored signal (See parameter 32.07) is compared to its lower and upper limits (32.09 and 32.10) respectively). The action to be taken when the condition is fulfilled is selected by 32.06. | Inhibited | | | | | | | | | | | | | | | | | | | | | | | | |
| | Inhibited | Signal supervision 1 not in use. | 0 | | | | | | | | | | | | | | | | | | | | | | | | |
| | Lower limit | Action is taken whenever the signal falls below its lower limit. | 1 | | | | | | | | | | | | | | | | | | | | | | | | |
| | Upper limit | Action is taken whenever the signal rises above its upper limit. | 2 | | | | | | | | | | | | | | | | | | | | | | | | |
| | Abs low | Action is taken whenever the absolute value of the signal falls below its (absolute) lower limit. | 3 | | | | | | | | | | | | | | | | | | | | | | | | |
| | Abs high | Action is taken whenever the absolute value of the signal rises above its (absolute) upper limit. | 4 | | | | | | | | | | | | | | | | | | | | | | | | |
| | Upper and lower limits | Action is taken whenever the signal falls below its low limit or rises above its high limit. | 5 | | | | | | | | | | | | | | | | | | | | | | | | |
| | Abs both | Action is taken whenever the absolute value of the signal falls below its (absolute) low limit or rises above its (absolute) high limit. | 6 | | | | | | | | | | | | | | | | | | | | | | | | |
| | Hysteresis | - | 7 | | | | | | | | | | | | | | | | | | | | | | | | |

| Serial number | Name/Value | Description | Def/FbEq16 |
|---------------|----------------------------------|-------------------------------------------------------------------------------------------------------------------------------------------------------------------------------------------------------------------------------------------------------------|------------|
| 32.06 | <i>Supervision 1 action</i> | Selects whether the drive generates a fault, warning or neither when the value monitored by signal supervision 1 exceeds its limits. Note: This parameter does not affect the status indicated by 32.01 Supervision status word . | No action |
| | No action | No warnings or fault generated. | 0 |
| | Alarm | Alarm is generated (A8B0 Signal supervision). | 1 |
| | Fault | The drive trips on 80B0 Signal supervision . | 2 |
| | Failure in operation | If the motor is in service, 80B0 signal monitoring fault will be activated. | 3 |
| 32.07 | <i>Supervision 1 signal</i> | Selects the signal to be monitored by signal supervision function 1. | Frequency |
| | Zero | None. | 0 |
| | Speed | 01.01 Motor speed (page 133). | 1 |
| | Frequency | 01.06 Output frequency (page 133). | 3 |
| | Current | 01.07 Motor current (page 133). | 4 |
| | Torque | 01.10 Motor torque (%) (page 133). | 6 |
| | DC voltage | 01.11 DC voltage (page 133). | 7 |
| | Output power | 01.14 Output frequency (page 133). | 8 |
| | AI1 | 12.11 AI1 actual value (page 152). | 9 |
| | AI2 | 12.21 AI2 actual value (page 154). | 10 |
| | Frequency reference | 28.02 Frequency ref ramp output (page 189). | 22 |
| | Inverter temperature | 05.11 Inverter temperature (%) (page 139). | 23 |
| | Process PID output | 40.01 PID output value (page 240). | 24 |
| | Feedback act value | 40.02 PID feedback value (page 241). | 25 |
| | Process PID setpoint. | 40.03 PID setpoint (page 241). | 26 |
| | Process PID dev. | 40.04 PID deviation value (page 241). | 27 |
| | <i>Other</i> | Source selection (See 130 on page Terms and abbreviations). | - |
| 32.08 | <i>Supervision 1 filter time</i> | Defines the filter time constant for the signal monitored by signal supervision 1. | 0.000 s |
| | 0.000 ... 30.000 s | Signal filter time. | 1000 = 1s |
| 32.09 | <i>Supervision 1 lower limit</i> | Defines the lower limit for signal supervision 1. | 0.00 |
| | -21474830.00... 21474830.00 | Low limit. | - |
| 32.10 | <i>Supervision 1 upper limit</i> | Defines the upper limit for signal supervision 1. | 0.00 |
| | -21474830.00... 21474830.00 | Upper limit. | - |
| 32.11 | <i>Supervision 1 hysteresis</i> | Defines the hysteresis for the signal monitored by signal supervision 1. | 0.00 |
| | 0.00...100000.00 | Hysteresis. | - |

| Serial number | Name/Value | Description | Def/FbEq16 |
|---------------|----------------------------------|---------------------------------------------------------------------------------------------------------------------------------------------------------------------------------------------------------------------------------------------------------------------|----------------|
| 32.15 | <i>Supervision 2 function</i> | Selects the mode of signal supervision function 2. Determines how the monitored signal (See parameter 32.17) is compared to its lower and upper limits 32.19 and 32.20) respectively). The action to be taken when the condition is fulfilled is selected by 32.16. | Inhibited |
| | Inhibited | Signal supervision 2 not in use. | 0 |
| | Lower limit | Action is taken whenever the signal falls below its lower limit. | 1 |
| | Upper limit | Action is taken whenever the signal rises above its upper limit. | 2 |
| | Abs low | Action is taken whenever the absolute value of the signal falls below its (absolute) lower limit. | 3 |
| | Abs high | Action is taken whenever the absolute value of the signal rises above its (absolute) upper limit. | 4 |
| | Upper and lower limits | Action is taken whenever the signal falls below its low limit or rises above its high limit. | 5 |
| | Abs both | Action is taken whenever the absolute value of the signal falls below its (absolute) low limit or rises above its (absolute) high limit. | 6 |
| | Hysteresis | - | 7 |
| 32.16 | <i>Supervision 2 action</i> | Selects whether the drive generates a fault, warning or neither when the value monitored by signal supervision 2 exceeds its limits. Note: This parameter does not affect the status indicated by 32.01 <i>Supervision status word</i> . | No action |
| | No action | No warnings or fault generated. | 0 |
| | Alarm | Alarm is generated (<i>A8B0 Signal supervision</i>). | 1 |
| | Fault | The drive trips on <i>80B0 Signal supervision</i> . | 2 |
| | Failure in operation | If the motor is in service, 80B0 signal monitoring fault will be activated. | 3 |
| 32.17 | <i>Supervision 2 signal</i> | Selects the signal to be monitored by signal supervision function 2. For the available selections, see parameter 32.07 <i>Supervision 1 signal</i> . | <i>Current</i> |
| 32.18 | <i>Supervision 2 filter time</i> | Defines the filter time constant for the signal monitored by signal supervision 2. | 0.000 s |
| | 0.000 ... 30.000 s | Signal filter time. | 1000 = 1s |
| 32.19 | <i>Supervision 2 lower limit</i> | Defines the lower limit for signal supervision 2. | 0.00 |
| | -21474830.00... 21474830.00 | Low limit. | - |
| 32.20 | <i>Supervision 2 upper limit</i> | Defines the upper limit for signal supervision 2. | 0.00 |
| | -21474830.00... 21474830.00 | Upper limit. | - |
| 32.21 | <i>Supervision 2 hysteresis</i> | Define the hysteresis for the signal monitored by signal supervision 2. | 0.00 |
| | 0.00...100000.00 | Hysteresis. | - |

| Serial number | Name/Value | Description | Def/FbEq16 |
|---------------|----------------------------------|--------------------------------------------------------------------------------------------------------------------------------------------------------------------------------------------------------------------------------------------------------------------|---------------|
| 32.25 | <i>Supervision 3 function</i> | Selects the mode of signal supervision function 3. Determines how the monitored signal (See parameter 32.27) is compared to its lower and upper limits 32.29 and 32.30 respectively). The action to be taken when the condition is fulfilled is selected by 32.26. | Inhibited |
| | Inhibited | Signal supervision 3 not in use. | 0 |
| | Lower limit | Action is taken whenever the signal falls below its lower limit. | 1 |
| | Upper limit | Action is taken whenever the signal rises above its upper limit. | 2 |
| | Abs low | Action is taken whenever the absolute value of the signal falls below its (absolute) lower limit. | 3 |
| | Abs high | Action is taken whenever the absolute value of the signal rises above its (absolute) upper limit. | 4 |
| | Upper and lower limits | Action is taken whenever the signal falls below its low limit or rises above its high limit. | 5 |
| | Abs both | Action is taken whenever the absolute value of the signal falls below its (absolute) low limit or rises above its (absolute) high limit. | 6 |
| | Hysteresis. | - | 7 |
| 32.26 | <i>Supervision 3 action</i> | Selects whether the drive generates a fault, warning or neither when the value monitored by signal supervision 3 exceeds its limits. Note: This parameter does not affect the status indicated by 32.01 <i>Supervision status word</i> . | No action |
| | No action | No warnings or fault generated. | 0 |
| | Alarm | Alarm is generated (<i>A8B0 Signal supervision</i>). | 1 |
| | Fault | The drive trips on <i>80B0 Signal supervision</i> . | 2 |
| | Failure in operation | If the motor is in service, 80B0 signal monitoring fault will be activated. | 3 |
| 32.27 | <i>Supervision 3 signal</i> | Selects the signal to be monitored by signal supervision function 3. For the available selections, see parameter 32.07 <i>Supervision 1 signal</i> . | <i>Torque</i> |
| 32.28 | <i>Supervision 3 filter time</i> | Defines the filter time constant for the signal monitored by signal supervision 3. | 0.000 s |
| | 0.000 ... 30.000 s | Signal filter time. | 1000 = 1s |
| 32.29 | <i>Supervision 3 lower limit</i> | Defines the lower limit for signal supervision 3. | 0.00 |
| | -21474830.00 21474830.00 | Low limit. | - |
| 32.30 | <i>Supervision 3 upper limit</i> | Defines the upper limit for signal supervision 3. | 0.00 |
| | -21474830.00... 21474830.00 | Upper limit. | - |
| 32.31 | <i>Supervision 3 hysteresis</i> | Defines the hysteresis for the signal monitored by signal supervision 3. | 0.00 |
| | 0.00...100000.00 | Hysteresis. | - |

| Serial number | Name/Value | Description | Def/FbEq16 |
|---------------|----------------------------------|---------------------------------------------------------------------------------------------------------------------------------------------------------------------------------------------------------------------------------------------------------------------|------------|
| 32.35 | <i>Supervision 4 function</i> | Selects the mode of signal supervision function 4. Determines how the monitored signal (See parameter 32.37) is compared to its lower and upper limits 32.39 and 32.30) respectively). The action to be taken when the condition is fulfilled is selected by 32.36. | Inhibited |
| | Inhibited | Signal supervision 4 not in use. | 0 |
| | Low | Action is taken whenever the signal falls below its lower limit. | 1 |
| | Upper limit | Action is taken whenever the signal rises above its upper limit. | 2 |
| | Abs low | Action is taken whenever the absolute value of the signal falls below its (absolute) lower limit. | 3 |
| | Abs high | Action is taken whenever the absolute value of the signal rises above its (absolute) upper limit. | 4 |
| | Upper and lower limits | Action is taken whenever the signal falls below its low limit or rises above its high limit. | 5 |
| | Abs both | Action is taken whenever the absolute value of the signal falls below its (absolute) low limit or rises above its (absolute) high limit. | 6 |
| | Hysteresis | - | 7 |
| 32.36 | <i>Supervision 4 action</i> | Selects whether the drive generates a fault, warning or neither when the value monitored by signal supervision 4 exceeds its limits. Note: This parameter does not affect the status indicated by 32.01 <i>Supervision status word</i> . | No action |
| | No action | No warnings or fault generated. | 0 |
| | Alarm | Alarm is generated (<i>A8B0 Signal supervision</i>). | 1 |
| | Fault | The drive trips on <i>80B0 Signal supervision</i> . | 2 |
| | Failure in operation | If the motor is in service, 80B0 signal monitoring fault will be activated. | 3 |
| 32.37 | <i>Supervision 4 signal</i> | Selects the signal to be monitored by signal supervision function 4. For the available selections, see parameter 32.07 <i>Supervision 1 signal</i> . | Zero |
| 32.38 | <i>Supervision 4 filter time</i> | Defines the filter time constant for the signal monitored by signal supervision 4. | 0.000 s |
| | 0.000 ... 30.000 s | Signal filter time. | 1000 = 1s |
| 32.39 | <i>Supervision 4 lower limit</i> | Defines the lower limit for signal supervision 4. | 0.00 |
| | -21474830.00... 21474830.00 | Low limit. | - |
| 32.40 | <i>Supervision 4 upper limit</i> | Defines the upper limit for signal supervision 4. | 0.00 |
| | -21474830.00... 21474830.00 | Upper limit. | - |
| 32.41 | <i>Supervision 4 hysteresis</i> | Defines the hysteresis for the signal monitored by signal supervision 4. | 0.00 |
| | 0.00...100000.00 | Hysteresis. | - |

| Serial number | Name/Value | Description | Def/FbEq16 |
|---------------|----------------------------------|--------------------------------------------------------------------------------------------------------------------------------------------------------------------------------------------------------------------------------------------------------------------------------------------------------------------------------------|------------|
| 32.45 | <i>Supervision 5 function</i> | Selects the mode of signal supervision function 5. Determines how the monitored signal (See parameter 32.47) is compared to its lower and upper limits 32.49 and 32.40 respectively). The action to be taken when the condition is fulfilled is selected by 32.46 . | Inhibited |
| | Inhibited | Signal supervision 5 not in use. | 0 |
| | Lower limit | Action is taken whenever the signal falls below its lower limit. | 1 |
| | Upper limit | Action is taken whenever the signal rises above its upper limit. | 2 |
| | Abs low | Action is taken whenever the absolute value of the signal falls below its (absolute) lower limit. | 3 |
| | Abs high | Action is taken whenever the absolute value of the signal rises above its (absolute) upper limit. | 4 |
| | Upper and lower limits | Action is taken whenever the signal falls below its low limit or rises above its high limit. | 5 |
| | Abs both | Action is taken whenever the absolute value of the signal falls below its (absolute) low limit or rises above its (absolute) high limit. | 6 |
| | Hysteresis | - | 7 |
| 32.46 | <i>Supervision 5 action</i> | Selects whether the drive generates a fault, warning or neither when the value monitored by signal supervision 5 exceeds its limits. Note: This parameter does not affect the status indicated by 32.01 Supervision status word . | No action |
| | No action | No warnings or fault generated. | 0 |
| | Alarm | Alarm is generated (A8B0 Signal supervision). | 1 |
| | Fault | The drive trips on 80B0 Signal supervision . | 2 |
| | Failure in operation | If the motor is in service, 80B0 signal monitoring fault will be activated. | 3 |
| 32.47 | <i>Supervision 5 signal</i> | Selects the signal to be monitored by signal supervision function 5. For the available selections, see parameter 32.07 Supervision 1 signal . | Zero |
| 32.48 | <i>Supervision 5 filter time</i> | Defines the filter time constant for the signal monitored by signal supervision 5. | 0.000 s |
| | 0.000 ... 30.000 s | Signal filter time. | 1000 = 1s |
| 32.49 | <i>Supervision 5 lower limit</i> | Defines the lower limit for signal supervision 5. | 0.00 |
| | -21474830.00... 21474830.00 | Low limit. | - |
| 32.50 | <i>Supervision 5 upper limit</i> | Defines the upper limit for signal supervision 5. | 0.00 |
| | -21474830.00... 21474830.00 | Upper limit. | - |
| 32.51 | <i>Supervision 5 hysteresis</i> | Defines the hysteresis for the signal monitored by signal supervision 5. | 0.00 |
| | 0.00...100000.00 | Hysteresis. | - |

| Serial number | Name/Value | Description | Def/FbEq16 |
|---------------|----------------------------------|---------------------------------------------------------------------------------------------------------------------------------------------------------------------------------------------------------------------------------------------------------------------|------------|
| 32.55 | <i>Supervision 6 function</i> | Selects the mode of signal supervision function 6. Determines how the monitored signal (See parameter 32.57) is compared to its lower and upper limits 32.59 and 32.50) respectively). The action to be taken when the condition is fulfilled is selected by 32.56. | Inhibited |
| | Inhibited | Signal supervision 6 not in use. | 0 |
| | Lower limit | Action is taken whenever the signal falls below its lower limit. | 1 |
| | Upper limit | Action is taken whenever the signal rises above its upper limit. | 2 |
| | Abs low | Action is taken whenever the absolute value of the signal falls below its (absolute) lower limit. | 3 |
| | Abs high | Action is taken whenever the absolute value of the signal rises above its (absolute) upper limit. | 4 |
| | Upper and lower limits | Action is taken whenever the signal falls below its low limit or rises above its high limit. | 5 |
| | Abs both | Action is taken whenever the absolute value of the signal falls below its (absolute) low limit or rises above its (absolute) high limit. | 6 |
| | Hysteresis. | - | 7 |
| 32.56 | <i>Supervision 6 action</i> | Selects whether the drive generates a fault, warning or neither when the value monitored by signal supervision 6 exceeds its limits. Note: This parameter does not affect the status indicated by 32.01 <i>Supervision status word</i> . | No action |
| | No action | No warnings or fault generated. | 0 |
| | Alarm | Alarm is generated (<i>A8B0 Signal supervision</i>). | 1 |
| | Fault | The drive trips on <i>80B0 Signal supervision</i> . | 2 |
| | Failure in operation | If the motor is in service, 80B0 signal monitoring fault will be activated. | 3 |
| 32.57 | <i>Supervision 6 signal</i> | Selects the signal to be monitored by signal supervision function 6. For the available selections, see parameter 32.07 <i>Supervision 1 signal</i> . | Zero |
| 32.58 | <i>Supervision 6 filter time</i> | Defines the filter time constant for the signal monitored by signal supervision 6. | 0.000 s |
| | 0.000 ... 30.000 s | Signal filter time. | 1000 = 1s |
| 32.59 | <i>Supervision 6 lower limit</i> | Defines the lower limit for signal supervision 6. | 0.00 |
| | -21474830.00... 21474830.00 | Low limit. | - |
| 32.60 | <i>Supervision 6 upper limit</i> | Defines the upper limit for signal supervision 6. | 0.00 |
| | -21474830.00... 21474830.00 | Upper limit. | - |
| 32.61 | <i>Supervision 6 hysteresis</i> | Defines the hysteresis for the signal monitored by signal supervision 6. | 0.00 |
| | 0.00...100000.00 | Hysteresis. | - |

| Serial number | Name/Value | Description | Def/FbEq16 | | | | | | | | | | | | | | | | | | | | | | | | | | | | | | | | | | | | | | | | | | |
|---------------------------|-----------------------------------------------------------------------------------------------------------------------------------------------------------------------------------------------------------------------------------------------------------------------------------------------------------------------------------------------------------------------------------------------------------------------------------------------------------------------------------------------------------------------------------------------------------------------------------------------------------------------------------------------------------------------------------------------------------------------------------------------------------------------------------------------------------------------------------------------------------------------------------------------------------------------------------------|-------------------------------------------------------------------------------------------------------------------------------------------------------------------------------------------|------------|--------|------|-------------|---|------------------|-------------|---|------------------|-------------|---|------------------|-------------|--------|----------|-------------|-------|---------|-------------|----|-----------------------------|-------------|----|-----------------------------|-------------|---------|---------|-------------|---|---------|-------------|---|----------|-------------|----|----------|-------------|----|----------|-------------|---------|---------|--|
| 34 Timed functions | | Configuration of the timed functions. See also section <i>Timed function</i> (page 82). | | | | | | | | | | | | | | | | | | | | | | | | | | | | | | | | | | | | | | | | | | | |
| 34.01 | <i>Combined timer status</i> | Status of the combined timers. The status of a combined timer is the logical OR of all timers connected to it. This parameter is read-only. | - | | | | | | | | | | | | | | | | | | | | | | | | | | | | | | | | | | | | | | | | | | |
| | <table border="1"> <thead> <tr> <th>Bit(s)</th> <th>Name</th> <th>Description</th> </tr> </thead> <tbody> <tr> <td>0</td> <td>Combined timer 1</td> <td>1 = Active.</td> </tr> <tr> <td>1</td> <td>Combined timer 2</td> <td>1 = Active.</td> </tr> <tr> <td>2</td> <td>Combined timer 3</td> <td>1 = Active.</td> </tr> <tr> <td>3...15</td> <td>Reserve</td> <td></td> </tr> </tbody> </table> | | | Bit(s) | Name | Description | 0 | Combined timer 1 | 1 = Active. | 1 | Combined timer 2 | 1 = Active. | 2 | Combined timer 3 | 1 = Active. | 3...15 | Reserve | | | | | | | | | | | | | | | | | | | | | | | | | | | | |
| Bit(s) | Name | Description | | | | | | | | | | | | | | | | | | | | | | | | | | | | | | | | | | | | | | | | | | | |
| 0 | Combined timer 1 | 1 = Active. | | | | | | | | | | | | | | | | | | | | | | | | | | | | | | | | | | | | | | | | | | | |
| 1 | Combined timer 2 | 1 = Active. | | | | | | | | | | | | | | | | | | | | | | | | | | | | | | | | | | | | | | | | | | | |
| 2 | Combined timer 3 | 1 = Active. | | | | | | | | | | | | | | | | | | | | | | | | | | | | | | | | | | | | | | | | | | | |
| 3...15 | Reserve | | | | | | | | | | | | | | | | | | | | | | | | | | | | | | | | | | | | | | | | | | | | |
| | 0000h...0FFFFh | Status of combined timers 1...3. | 1 = 1 | | | | | | | | | | | | | | | | | | | | | | | | | | | | | | | | | | | | | | | | | | |
| 34.02 | <i>Timer status</i> | Status of timers 1...12. This parameter is read-only. | - | | | | | | | | | | | | | | | | | | | | | | | | | | | | | | | | | | | | | | | | | | |
| | <table border="1"> <thead> <tr> <th>Bit(s)</th> <th>Name</th> <th>Description</th> </tr> </thead> <tbody> <tr> <td>0</td> <td>Timer 1</td> <td>1 = Active.</td> </tr> <tr> <td>1</td> <td>Timer 2</td> <td>1 = Active.</td> </tr> <tr> <td>2</td> <td>Timer 3</td> <td>1 = Active.</td> </tr> <tr> <td>3</td> <td>Timer 4</td> <td>1 = Active.</td> </tr> <tr> <td>4</td> <td>Timer 5</td> <td>1 = Active.</td> </tr> <tr> <td>5</td> <td>Timer 6</td> <td>1 = Active.</td> </tr> <tr> <td>6</td> <td>Timer 7</td> <td>1 = Active.</td> </tr> <tr> <td>7</td> <td>Timer 8</td> <td>1 = Active.</td> </tr> <tr> <td>8</td> <td>Timer 9</td> <td>1 = Active.</td> </tr> <tr> <td>9</td> <td>Timer 10</td> <td>1 = Active.</td> </tr> <tr> <td>10</td> <td>Timer 11</td> <td>1 = Active.</td> </tr> <tr> <td>11</td> <td>Timer 12</td> <td>1 = Active.</td> </tr> <tr> <td>12...15</td> <td>Reserve</td> <td></td> </tr> </tbody> </table> | | | Bit(s) | Name | Description | 0 | Timer 1 | 1 = Active. | 1 | Timer 2 | 1 = Active. | 2 | Timer 3 | 1 = Active. | 3 | Timer 4 | 1 = Active. | 4 | Timer 5 | 1 = Active. | 5 | Timer 6 | 1 = Active. | 6 | Timer 7 | 1 = Active. | 7 | Timer 8 | 1 = Active. | 8 | Timer 9 | 1 = Active. | 9 | Timer 10 | 1 = Active. | 10 | Timer 11 | 1 = Active. | 11 | Timer 12 | 1 = Active. | 12...15 | Reserve | |
| Bit(s) | Name | Description | | | | | | | | | | | | | | | | | | | | | | | | | | | | | | | | | | | | | | | | | | | |
| 0 | Timer 1 | 1 = Active. | | | | | | | | | | | | | | | | | | | | | | | | | | | | | | | | | | | | | | | | | | | |
| 1 | Timer 2 | 1 = Active. | | | | | | | | | | | | | | | | | | | | | | | | | | | | | | | | | | | | | | | | | | | |
| 2 | Timer 3 | 1 = Active. | | | | | | | | | | | | | | | | | | | | | | | | | | | | | | | | | | | | | | | | | | | |
| 3 | Timer 4 | 1 = Active. | | | | | | | | | | | | | | | | | | | | | | | | | | | | | | | | | | | | | | | | | | | |
| 4 | Timer 5 | 1 = Active. | | | | | | | | | | | | | | | | | | | | | | | | | | | | | | | | | | | | | | | | | | | |
| 5 | Timer 6 | 1 = Active. | | | | | | | | | | | | | | | | | | | | | | | | | | | | | | | | | | | | | | | | | | | |
| 6 | Timer 7 | 1 = Active. | | | | | | | | | | | | | | | | | | | | | | | | | | | | | | | | | | | | | | | | | | | |
| 7 | Timer 8 | 1 = Active. | | | | | | | | | | | | | | | | | | | | | | | | | | | | | | | | | | | | | | | | | | | |
| 8 | Timer 9 | 1 = Active. | | | | | | | | | | | | | | | | | | | | | | | | | | | | | | | | | | | | | | | | | | | |
| 9 | Timer 10 | 1 = Active. | | | | | | | | | | | | | | | | | | | | | | | | | | | | | | | | | | | | | | | | | | | |
| 10 | Timer 11 | 1 = Active. | | | | | | | | | | | | | | | | | | | | | | | | | | | | | | | | | | | | | | | | | | | |
| 11 | Timer 12 | 1 = Active. | | | | | | | | | | | | | | | | | | | | | | | | | | | | | | | | | | | | | | | | | | | |
| 12...15 | Reserve | | | | | | | | | | | | | | | | | | | | | | | | | | | | | | | | | | | | | | | | | | | | |
| | 0000h...FFFFh | Timer status. | 1 = 1 | | | | | | | | | | | | | | | | | | | | | | | | | | | | | | | | | | | | | | | | | | |
| 34.04 | <i>Season/exception day status</i> | Status of seasons 1...3, exception weekday and exception holiday. One season can be active at a time. A day can be a workday and a holiday at the same time. This parameter is read-only. | - | | | | | | | | | | | | | | | | | | | | | | | | | | | | | | | | | | | | | | | | | | |
| | <table border="1"> <thead> <tr> <th>Bit(s)</th> <th>Name</th> <th>Description</th> </tr> </thead> <tbody> <tr> <td>0</td> <td>Season 1</td> <td>1 = Active.</td> </tr> <tr> <td>1</td> <td>Season 2</td> <td>1 = Active.</td> </tr> <tr> <td>2</td> <td>Season 3</td> <td>1 = Active.</td> </tr> <tr> <td>3</td> <td>Season 4</td> <td>1 = Active.</td> </tr> <tr> <td>4...9</td> <td>Reserve</td> <td></td> </tr> <tr> <td>10</td> <td>Status of exception weekday</td> <td>1 = Active.</td> </tr> <tr> <td>11</td> <td>Status of exception holiday</td> <td>1 = Active.</td> </tr> <tr> <td>12...15</td> <td>Reserve</td> <td></td> </tr> </tbody> </table> | | | Bit(s) | Name | Description | 0 | Season 1 | 1 = Active. | 1 | Season 2 | 1 = Active. | 2 | Season 3 | 1 = Active. | 3 | Season 4 | 1 = Active. | 4...9 | Reserve | | 10 | Status of exception weekday | 1 = Active. | 11 | Status of exception holiday | 1 = Active. | 12...15 | Reserve | | | | | | | | | | | | | | | | |
| Bit(s) | Name | Description | | | | | | | | | | | | | | | | | | | | | | | | | | | | | | | | | | | | | | | | | | | |
| 0 | Season 1 | 1 = Active. | | | | | | | | | | | | | | | | | | | | | | | | | | | | | | | | | | | | | | | | | | | |
| 1 | Season 2 | 1 = Active. | | | | | | | | | | | | | | | | | | | | | | | | | | | | | | | | | | | | | | | | | | | |
| 2 | Season 3 | 1 = Active. | | | | | | | | | | | | | | | | | | | | | | | | | | | | | | | | | | | | | | | | | | | |
| 3 | Season 4 | 1 = Active. | | | | | | | | | | | | | | | | | | | | | | | | | | | | | | | | | | | | | | | | | | | |
| 4...9 | Reserve | | | | | | | | | | | | | | | | | | | | | | | | | | | | | | | | | | | | | | | | | | | | |
| 10 | Status of exception weekday | 1 = Active. | | | | | | | | | | | | | | | | | | | | | | | | | | | | | | | | | | | | | | | | | | | |
| 11 | Status of exception holiday | 1 = Active. | | | | | | | | | | | | | | | | | | | | | | | | | | | | | | | | | | | | | | | | | | | |
| 12...15 | Reserve | | | | | | | | | | | | | | | | | | | | | | | | | | | | | | | | | | | | | | | | | | | | |
| | 0000h...FFFFh | Status of the seasons and exception weekday and holiday. | 1 = 1 | | | | | | | | | | | | | | | | | | | | | | | | | | | | | | | | | | | | | | | | | | |

| Serial number | Name/Value | Description | Def/FbEq16 | | | | | | | | | | | | | | | | | | | | | | | | | | | | | | | | | | | | | | | | | | | | | | | |
|---------------|----------------------------------------------------------------------------------------------------------------------------------------------------------------------------------------------------------------------------------------------------------------------------------------------------------------------------------------------------------------------------------------------------------------------------------------------------------------------------------------------------------------------------------------------------------------------------------------------------------------------------------------------------------------------------------------------------------------------------------------------------------------------------------------------------------------------------------------------------------------------------------------------------------------------------------------------------------------------------------------------------------------------------------------------------------------------------------------------------------------------------------------------------------------------------------------------------------------------------------------------------------------------------------------------------------------------------------------------------------------------------------------------------------------------------------------------------------------------------------------------------------------------------------------------------------------------------------------------------------------------------------------------------------------------------------------|------------------------------------------------------------------------------------------------------------------------------------------------------------------------------------------------------------------------------------------------------------------------------------------------------------------------------------------------------------------------------------------------------------------------|----------------------|-------------|---|--------|------------------------------------|---|---------|-------------------------------------|---|-----------|---------------------------------------|---|----------|--------------------------------------|---|--------|------------------------------------|---|----------|--------------------------------------|---|--------|------------------------------------|---|----------|----------------------------------|---|----------|----------------------------------|---|----------|----------------------------------|----|----------|----------------------------------|----|------------|-------------------------------------------------------------------------------------------------------------|----|----------|------------------------------------------------------------------------------------------------------------------------------------|----|----------|------------------------------------------------------------------------------------------------------------------------------------|---------|---------|--|--|
| 34.10 | <i>Timed functions enable</i> | Selects the source for the timed functions enable signal. 0 = inhibited. 1 = Enabled. | Not selected | | | | | | | | | | | | | | | | | | | | | | | | | | | | | | | | | | | | | | | | | | | | | | | |
| | Not selected | 0 | 0 | | | | | | | | | | | | | | | | | | | | | | | | | | | | | | | | | | | | | | | | | | | | | | | |
| | Select | 1 | 1 | | | | | | | | | | | | | | | | | | | | | | | | | | | | | | | | | | | | | | | | | | | | | | | |
| | <i>Other [bit]</i> | Source selection (See 130 on page Terms and abbreviations). | - | | | | | | | | | | | | | | | | | | | | | | | | | | | | | | | | | | | | | | | | | | | | | | | |
| 34.11 | <i>Timer 1 configuration</i> | Defines when timer 1 is active. | 0000011110 000000 | | | | | | | | | | | | | | | | | | | | | | | | | | | | | | | | | | | | | | | | | | | | | | | |
| | <table border="1"> <thead> <tr> <th>Bit(s)</th> <th>Name</th> <th>Description</th> </tr> </thead> <tbody> <tr> <td>0</td> <td>Monday</td> <td>1 = Monday is an active start day.</td> </tr> <tr> <td>1</td> <td>Tuesday</td> <td>1 = Tuesday is an active start day.</td> </tr> <tr> <td>2</td> <td>Wednesday</td> <td>1 = Wednesday is an active start day.</td> </tr> <tr> <td>3</td> <td>Thursday</td> <td>1 = Thursday is an active start day.</td> </tr> <tr> <td>4</td> <td>Friday</td> <td>1 = Friday is an active start day.</td> </tr> <tr> <td>5</td> <td>Saturday</td> <td>1 = Saturday is an active start day.</td> </tr> <tr> <td>6</td> <td>Sunday</td> <td>1 = Sunday is an active start day.</td> </tr> <tr> <td>7</td> <td>Season 1</td> <td>1 = Timer is active in season 1.</td> </tr> <tr> <td>8</td> <td>Season 2</td> <td>1 = Timer is active in season 2.</td> </tr> <tr> <td>9</td> <td>Season 3</td> <td>1 = Timer is active in season 3.</td> </tr> <tr> <td>10</td> <td>Season 4</td> <td>1 = Timer is active in season 4.</td> </tr> <tr> <td>11</td> <td>Exceptions</td> <td>0 = Exceptions days are disabled. 1 = Exception days are enabled. Bits 12 and 13 are taken into account.</td> </tr> <tr> <td>12</td> <td>Holidays</td> <td>0 = Timer is inactive on exception days configured as "Holiday". 1 = Timer is active on exception days configured as "Holiday".</td> </tr> <tr> <td>13</td> <td>Workdays</td> <td>0 = Timer is inactive on exception days configured as "Workday". 1 = Timer is active on exception days configured as "Workday".</td> </tr> <tr> <td>14...15</td> <td>Reserve</td> <td></td> </tr> </tbody> </table> | Bit(s) | Name | Description | 0 | Monday | 1 = Monday is an active start day. | 1 | Tuesday | 1 = Tuesday is an active start day. | 2 | Wednesday | 1 = Wednesday is an active start day. | 3 | Thursday | 1 = Thursday is an active start day. | 4 | Friday | 1 = Friday is an active start day. | 5 | Saturday | 1 = Saturday is an active start day. | 6 | Sunday | 1 = Sunday is an active start day. | 7 | Season 1 | 1 = Timer is active in season 1. | 8 | Season 2 | 1 = Timer is active in season 2. | 9 | Season 3 | 1 = Timer is active in season 3. | 10 | Season 4 | 1 = Timer is active in season 4. | 11 | Exceptions | 0 = Exceptions days are disabled. 1 = Exception days are enabled. Bits 12 and 13 are taken into account. | 12 | Holidays | 0 = Timer is inactive on exception days configured as "Holiday". 1 = Timer is active on exception days configured as "Holiday". | 13 | Workdays | 0 = Timer is inactive on exception days configured as "Workday". 1 = Timer is active on exception days configured as "Workday". | 14...15 | Reserve | | |
| Bit(s) | Name | Description | | | | | | | | | | | | | | | | | | | | | | | | | | | | | | | | | | | | | | | | | | | | | | | | |
| 0 | Monday | 1 = Monday is an active start day. | | | | | | | | | | | | | | | | | | | | | | | | | | | | | | | | | | | | | | | | | | | | | | | | |
| 1 | Tuesday | 1 = Tuesday is an active start day. | | | | | | | | | | | | | | | | | | | | | | | | | | | | | | | | | | | | | | | | | | | | | | | | |
| 2 | Wednesday | 1 = Wednesday is an active start day. | | | | | | | | | | | | | | | | | | | | | | | | | | | | | | | | | | | | | | | | | | | | | | | | |
| 3 | Thursday | 1 = Thursday is an active start day. | | | | | | | | | | | | | | | | | | | | | | | | | | | | | | | | | | | | | | | | | | | | | | | | |
| 4 | Friday | 1 = Friday is an active start day. | | | | | | | | | | | | | | | | | | | | | | | | | | | | | | | | | | | | | | | | | | | | | | | | |
| 5 | Saturday | 1 = Saturday is an active start day. | | | | | | | | | | | | | | | | | | | | | | | | | | | | | | | | | | | | | | | | | | | | | | | | |
| 6 | Sunday | 1 = Sunday is an active start day. | | | | | | | | | | | | | | | | | | | | | | | | | | | | | | | | | | | | | | | | | | | | | | | | |
| 7 | Season 1 | 1 = Timer is active in season 1. | | | | | | | | | | | | | | | | | | | | | | | | | | | | | | | | | | | | | | | | | | | | | | | | |
| 8 | Season 2 | 1 = Timer is active in season 2. | | | | | | | | | | | | | | | | | | | | | | | | | | | | | | | | | | | | | | | | | | | | | | | | |
| 9 | Season 3 | 1 = Timer is active in season 3. | | | | | | | | | | | | | | | | | | | | | | | | | | | | | | | | | | | | | | | | | | | | | | | | |
| 10 | Season 4 | 1 = Timer is active in season 4. | | | | | | | | | | | | | | | | | | | | | | | | | | | | | | | | | | | | | | | | | | | | | | | | |
| 11 | Exceptions | 0 = Exceptions days are disabled. 1 = Exception days are enabled. Bits 12 and 13 are taken into account. | | | | | | | | | | | | | | | | | | | | | | | | | | | | | | | | | | | | | | | | | | | | | | | | |
| 12 | Holidays | 0 = Timer is inactive on exception days configured as "Holiday". 1 = Timer is active on exception days configured as "Holiday". | | | | | | | | | | | | | | | | | | | | | | | | | | | | | | | | | | | | | | | | | | | | | | | | |
| 13 | Workdays | 0 = Timer is inactive on exception days configured as "Workday". 1 = Timer is active on exception days configured as "Workday". | | | | | | | | | | | | | | | | | | | | | | | | | | | | | | | | | | | | | | | | | | | | | | | | |
| 14...15 | Reserve | | | | | | | | | | | | | | | | | | | | | | | | | | | | | | | | | | | | | | | | | | | | | | | | | |
| | 0000h...FFFFh | Configuration of timer 1. | 1 = 1 | | | | | | | | | | | | | | | | | | | | | | | | | | | | | | | | | | | | | | | | | | | | | | | |
| 34.12 | <i>Timer 1 start time</i> | Defines the daily start time of timer 1. The time can be changed in second steps. The timer can be started at the other time than the start time. E.g. if the timer's duration is more than one day and the active session starts during the time, the timer is started at 00:00 and stopped when there is no duration left. | 00:00:00 | | | | | | | | | | | | | | | | | | | | | | | | | | | | | | | | | | | | | | | | | | | | | | | |
| | 00:00:00...23:59:59 | Daily start time of the timer. | 1 = 1 | | | | | | | | | | | | | | | | | | | | | | | | | | | | | | | | | | | | | | | | | | | | | | | |
| 34.13 | <i>Timer 1 duration</i> | Defines the duration of timer 1. The duration can be changed in minute steps. The duration can extend over the change of the day but if an exception day becomes active, the period is interrupted at midnight. In the same way the period started on an exception day stays active only until the end of the day, even if the duration is longer. The timer will continue after a break if there is duration left. | 00 00:00 | | | | | | | | | | | | | | | | | | | | | | | | | | | | | | | | | | | | | | | | | | | | | | | |
| | 00 00:00...07 00:00 | Timer duration. | 1 = 1 | | | | | | | | | | | | | | | | | | | | | | | | | | | | | | | | | | | | | | | | | | | | | | | |

| Serial number | Name/Value | Description | Def/FbEq16 |
|----------------------|-------------------------------|-----------------------------------------|----------------------|
| 34.14 | <i>Timer 2 configuration</i> | See 34.11 <i>Timer 1 configuration.</i> | 0000011110 000000 |
| 34.15 | <i>Timer 2 start time</i> | See 34.12 <i>Timer 1 start time.</i> | 00:00:00 |
| 34.16 | <i>Timer 2 duration</i> | See 34.13 <i>Timer 1 duration.</i> | 00 00:00 |
| 34.17 | <i>Timer 3 configuration</i> | See 34.11 <i>Timer 1 configuration.</i> | 0000011110 000000 |
| 34.18 | <i>Timer 3 start time</i> | See 34.12 <i>Timer 1 start time.</i> | 00:00:00 |
| 34.19 | <i>Timer 3 duration</i> | See 34.13 <i>Timer 1 duration.</i> | 00 00:00 |
| 34.20 | <i>Timer 4 configuration</i> | See 34.11 <i>Timer 1 configuration.</i> | 0000011110 000000 |
| 34.21 | <i>Timer 4 start time</i> | See 34.12 <i>Timer 1 start time.</i> | 00:00:00 |
| 34.22 | <i>Timer 4 duration</i> | See 34.13 <i>Timer 1 duration.</i> | 00 00:00 |
| 34.23 | <i>Timer 5 configuration</i> | See 34.11 <i>Timer 1 configuration.</i> | 0000011110 000000 |
| 34.24 | <i>Timer 5 start time</i> | See 34.12 <i>Timer 1 start time.</i> | 00:00:00 |
| 34.25 | <i>Timer 5 duration</i> | See 34.13 <i>Timer 1 duration.</i> | 00 00:00 |
| 34.26 | <i>Timer 6 configuration</i> | See 34.11 <i>Timer 1 configuration.</i> | 0000011110 000000 |
| 34.27 | <i>Timer 6 start time</i> | See 34.12 <i>Timer 1 start time.</i> | 00:00:00 |
| 34.28 | <i>Timer 6 duration</i> | See 34.13 <i>Timer 1 duration.</i> | 00 00:00 |
| 34.29 | <i>Timer 7 configuration</i> | See 34.11 <i>Timer 1 configuration.</i> | 0000011110 000000 |
| 34.30 | <i>Timer 7 start time</i> | See 34.12 <i>Timer 1 start time.</i> | 00:00:00 |
| 34.31 | <i>Timer 7 duration</i> | See 34.13 <i>Timer 1 duration.</i> | 00 00:00 |
| 34.32 | <i>Timer 8 configuration</i> | See 34.11 <i>Timer 1 configuration.</i> | 0000011110 000000 |
| 34.33 | <i>Timer 8 start time</i> | See 34.12 <i>Timer 1 start time.</i> | 00:00:00 |
| 34.34 | <i>Timer 8 duration</i> | See 34.13 <i>Timer 1 duration.</i> | 00 00:00 |
| 34.35 | <i>Timer 9 configuration</i> | See 34.11 <i>Timer 1 configuration.</i> | 0000011110 000000 |
| 34.36 | <i>Timer 9 start time</i> | See 34.12 <i>Timer 1 start time.</i> | 00:00:00 |
| 34.37 | <i>Timer 9 duration</i> | See 34.13 <i>Timer 1 duration.</i> | 00 00:00 |
| 34.38 | <i>Timer 10 configuration</i> | See 34.11 <i>Timer 1 configuration.</i> | 0000011110 000000 |
| 34.39 | <i>Timer 10 start time</i> | See 34.12 <i>Timer 1 start time.</i> | 00:00:00 |
| 34.40 | <i>Timer 10 duration</i> | See 34.13 <i>Timer 1 duration.</i> | 00 00:00 |
| 34.41 | <i>Timer 11 configuration</i> | See 34.11 <i>Timer 1 configuration.</i> | 0000011110 000000 |
| 34.42 | <i>Timer 11 start time</i> | See 34.12 <i>Timer 1 start time.</i> | 00:00:00 |
| 34.43 | <i>Timer 11 duration</i> | See 34.13 <i>Timer 1 duration.</i> | 00 00:00 |
| 34.44 | <i>Timer 12 configuration</i> | See 34.11 <i>Timer 1 configuration.</i> | 0000011110 000000 |
| 34.45 | <i>Timer 12 start time</i> | See 34.12 <i>Timer 1 start time.</i> | 00:00:00 |
| 34.46 | <i>Timer 12 duration</i> | See 34.13 <i>Timer 1 duration.</i> | 00 00:00 |

| Serial number | Name/Value | Description | Def/FbEq16 | | | | | | | | | | | | | | | | | | | | | | | | | | | | | | | | | | | | | | | | | | | | | | | | | | | |
|---------------|----------------------------------------------------------------------------------------------------------------------------------------------------------------------------------------------------------------------------------------------------------------------------------------------------------------------------------------------------------------------------------------------------------------------------------------------------------------------------------------------------------------------------------------------------------------------------------------------------------------------------------------------------------------------------------------------------------------------------------------------------------------------------------------------------------------------------------------------------------------------------------------------------------------------------------------------------------------------------------------------------------------------------------------------------------------------------------------------------------------------------------------------------------------------------------------------------------------------------------------------------------------------------------------------------------------------------------------------------------|--------------------------------------------------------------------------------------------------------------------------------------------------------------------------------------------------------------------------------------------------------------------------------------------------------------------------------------------------------------------------------------------------------------------------------------------------------------------------------------------------------------------------------------------------------------------------------------------------|--------------------|-------------|---|-------------|--------------------------|---|-------------|--------------------------|---|-------------|--------------------------|---|-------------|--------------------------|---|-------------|--------------------------|---|-------------|--------------------------|---|-------------|--------------------------|---|-------------|--------------------------|---|-------------|--------------------------|---|--------------|--------------------------|----|--------------|--------------------------|----|--------------|--------------------------|----|--------------|--------------------------|----|--------------|--------------------------|----|--------------|--------------------------|----|--------------|--------------------------|--|--|
| 34.60 | <i>Season 1 start date</i> | Defines the start date of season 1 in format dd.mm, where dd is the number of the day and mm is the number of the month. The season changes at midnight. One season can be active at a time. Timers are started on exception days even if they are not inside the active season. The season start dates (14) must be given in increasing order to use all seasons. The default value is interpreted that the season is not configured. If the season start dates are not in increasing order and the value is something else than the default value, a season configuration warning is given. | 01.01. | | | | | | | | | | | | | | | | | | | | | | | | | | | | | | | | | | | | | | | | | | | | | | | | | | | |
| | 01.01...31.12 | Season start date. | | | | | | | | | | | | | | | | | | | | | | | | | | | | | | | | | | | | | | | | | | | | | | | | | | | | |
| 34.61 | <i>Season 2 start date</i> | Defines the start date of season 2 See 34.60 <i>Season 1 start date</i> . | 01.01. | | | | | | | | | | | | | | | | | | | | | | | | | | | | | | | | | | | | | | | | | | | | | | | | | | | |
| 34.62 | <i>Season 3 start date</i> | Defines the start date of season 3 See 34.60 <i>Season 1 start date</i> . | 01.01. | | | | | | | | | | | | | | | | | | | | | | | | | | | | | | | | | | | | | | | | | | | | | | | | | | | |
| 34.63 | <i>Season 4 start date</i> | Defines the start date of season 4 See 34.60 <i>Season 1 start date</i> . | 01.01. | | | | | | | | | | | | | | | | | | | | | | | | | | | | | | | | | | | | | | | | | | | | | | | | | | | |
| 34.70 | <i>Number of active exceptions</i> | Defines how many of the exceptions are active by specifying the last active one. All preceding exceptions are active. Exceptions 1...3 are periods (duration can be defined) and exceptions 4...16 are days (duration is always 24 hours). Example: If the value is 4, exceptions 1...4 are active, and exceptions 5...16 are not active. | 3 | | | | | | | | | | | | | | | | | | | | | | | | | | | | | | | | | | | | | | | | | | | | | | | | | | | |
| | 0...16 | Number of active exception periods or days. | - | | | | | | | | | | | | | | | | | | | | | | | | | | | | | | | | | | | | | | | | | | | | | | | | | | | |
| 34.71 | <i>Exception types</i> | Defines the types of exceptions 1...16 as workday or holiday. Exceptions 1...3 are periods (duration can be defined) and exceptions 4...16 are days (duration is always 24 hours). | 1111111111 1111 | | | | | | | | | | | | | | | | | | | | | | | | | | | | | | | | | | | | | | | | | | | | | | | | | | | |
| | <table border="1"> <thead> <tr> <th>Bit(s)</th> <th>Name</th> <th>Description</th> </tr> </thead> <tbody> <tr><td>0</td><td>Exception 1</td><td>0 = Workday. 1 = Holiday</td></tr> <tr><td>1</td><td>Exception 2</td><td>0 = Workday. 1 = Holiday</td></tr> <tr><td>2</td><td>Exception 3</td><td>0 = Workday. 1 = Holiday</td></tr> <tr><td>3</td><td>Exception 4</td><td>0 = Workday. 1 = Holiday</td></tr> <tr><td>4</td><td>Exception 5</td><td>0 = Workday. 1 = Holiday</td></tr> <tr><td>5</td><td>Exception 6</td><td>0 = Workday. 1 = Holiday</td></tr> <tr><td>6</td><td>Exception 7</td><td>0 = Workday. 1 = Holiday</td></tr> <tr><td>7</td><td>Exception 8</td><td>0 = Workday. 1 = Holiday</td></tr> <tr><td>8</td><td>Exception 9</td><td>0 = Workday. 1 = Holiday</td></tr> <tr><td>9</td><td>Exception 10</td><td>0 = Workday. 1 = Holiday</td></tr> <tr><td>10</td><td>Exception 11</td><td>0 = Workday. 1 = Holiday</td></tr> <tr><td>11</td><td>Exception 12</td><td>0 = Workday. 1 = Holiday</td></tr> <tr><td>12</td><td>Exception 13</td><td>0 = Workday. 1 = Holiday</td></tr> <tr><td>13</td><td>Exception 14</td><td>0 = Workday. 1 = Holiday</td></tr> <tr><td>14</td><td>Exception 15</td><td>0 = Workday. 1 = Holiday</td></tr> <tr><td>15</td><td>Exception 16</td><td>0 = Workday. 1 = Holiday</td></tr> </tbody> </table> | Bit(s) | Name | Description | 0 | Exception 1 | 0 = Workday. 1 = Holiday | 1 | Exception 2 | 0 = Workday. 1 = Holiday | 2 | Exception 3 | 0 = Workday. 1 = Holiday | 3 | Exception 4 | 0 = Workday. 1 = Holiday | 4 | Exception 5 | 0 = Workday. 1 = Holiday | 5 | Exception 6 | 0 = Workday. 1 = Holiday | 6 | Exception 7 | 0 = Workday. 1 = Holiday | 7 | Exception 8 | 0 = Workday. 1 = Holiday | 8 | Exception 9 | 0 = Workday. 1 = Holiday | 9 | Exception 10 | 0 = Workday. 1 = Holiday | 10 | Exception 11 | 0 = Workday. 1 = Holiday | 11 | Exception 12 | 0 = Workday. 1 = Holiday | 12 | Exception 13 | 0 = Workday. 1 = Holiday | 13 | Exception 14 | 0 = Workday. 1 = Holiday | 14 | Exception 15 | 0 = Workday. 1 = Holiday | 15 | Exception 16 | 0 = Workday. 1 = Holiday | | |
| Bit(s) | Name | Description | | | | | | | | | | | | | | | | | | | | | | | | | | | | | | | | | | | | | | | | | | | | | | | | | | | | |
| 0 | Exception 1 | 0 = Workday. 1 = Holiday | | | | | | | | | | | | | | | | | | | | | | | | | | | | | | | | | | | | | | | | | | | | | | | | | | | | |
| 1 | Exception 2 | 0 = Workday. 1 = Holiday | | | | | | | | | | | | | | | | | | | | | | | | | | | | | | | | | | | | | | | | | | | | | | | | | | | | |
| 2 | Exception 3 | 0 = Workday. 1 = Holiday | | | | | | | | | | | | | | | | | | | | | | | | | | | | | | | | | | | | | | | | | | | | | | | | | | | | |
| 3 | Exception 4 | 0 = Workday. 1 = Holiday | | | | | | | | | | | | | | | | | | | | | | | | | | | | | | | | | | | | | | | | | | | | | | | | | | | | |
| 4 | Exception 5 | 0 = Workday. 1 = Holiday | | | | | | | | | | | | | | | | | | | | | | | | | | | | | | | | | | | | | | | | | | | | | | | | | | | | |
| 5 | Exception 6 | 0 = Workday. 1 = Holiday | | | | | | | | | | | | | | | | | | | | | | | | | | | | | | | | | | | | | | | | | | | | | | | | | | | | |
| 6 | Exception 7 | 0 = Workday. 1 = Holiday | | | | | | | | | | | | | | | | | | | | | | | | | | | | | | | | | | | | | | | | | | | | | | | | | | | | |
| 7 | Exception 8 | 0 = Workday. 1 = Holiday | | | | | | | | | | | | | | | | | | | | | | | | | | | | | | | | | | | | | | | | | | | | | | | | | | | | |
| 8 | Exception 9 | 0 = Workday. 1 = Holiday | | | | | | | | | | | | | | | | | | | | | | | | | | | | | | | | | | | | | | | | | | | | | | | | | | | | |
| 9 | Exception 10 | 0 = Workday. 1 = Holiday | | | | | | | | | | | | | | | | | | | | | | | | | | | | | | | | | | | | | | | | | | | | | | | | | | | | |
| 10 | Exception 11 | 0 = Workday. 1 = Holiday | | | | | | | | | | | | | | | | | | | | | | | | | | | | | | | | | | | | | | | | | | | | | | | | | | | | |
| 11 | Exception 12 | 0 = Workday. 1 = Holiday | | | | | | | | | | | | | | | | | | | | | | | | | | | | | | | | | | | | | | | | | | | | | | | | | | | | |
| 12 | Exception 13 | 0 = Workday. 1 = Holiday | | | | | | | | | | | | | | | | | | | | | | | | | | | | | | | | | | | | | | | | | | | | | | | | | | | | |
| 13 | Exception 14 | 0 = Workday. 1 = Holiday | | | | | | | | | | | | | | | | | | | | | | | | | | | | | | | | | | | | | | | | | | | | | | | | | | | | |
| 14 | Exception 15 | 0 = Workday. 1 = Holiday | | | | | | | | | | | | | | | | | | | | | | | | | | | | | | | | | | | | | | | | | | | | | | | | | | | | |
| 15 | Exception 16 | 0 = Workday. 1 = Holiday | | | | | | | | | | | | | | | | | | | | | | | | | | | | | | | | | | | | | | | | | | | | | | | | | | | | |
| | 0000h...FFFFh | Types of exception period or days. | 1 = 1 | | | | | | | | | | | | | | | | | | | | | | | | | | | | | | | | | | | | | | | | | | | | | | | | | | | |

| Serial number | Name/Value | Description | Def/FbEq16 |
|---------------|---------------------------|--------------------------------------------------------------------------------------------------------------------------------------------------------------------------------------------------------------------------------------------------------------------------------------------------------------------------------------------------------------------|------------|
| 34.72 | <i>Exception 1 start</i> | Defines the start date of the exception period in format dd.mm, where dd is the number of the day and mm is the number of the month. The timer started on an exception day is always stopped at 23:59:59 even if it has duration left. The same date can be configured to be holiday and workday. The date is active if any of exception days are active. | 01.01. |
| | 01.01....31.12. | Start date of exception period 1. | |
| 34.73 | <i>Exception 1 length</i> | Defines the length of the exception period in days. Exception period is handled the same as a number of consecutive exception days. | 0 |
| | 0...60 | Length of exception period 1. | 1 = 1 |
| 34.74 | <i>Exception 2 start</i> | See 34.72 <i>Exception 1 start</i> . | 01.01. |
| 34.75 | <i>Exception 2 length</i> | See 34.73 <i>Exception 1 length</i> . | 0 |
| 34.76 | <i>Exception 3 start</i> | See 34.72 <i>Exception 1 start</i> . | 01.01. |
| 34.77 | <i>Exception 3 length</i> | See 34.73 <i>Exception 1 length</i> . | 0 |
| 34.78 | <i>Exception day 4</i> | Defines the date of exception day 4. | 01.01. |
| | 01.01....31.12. | Start date of exception day 4. The timer started on an exception day is always stopped at 23:59:59 even if it has duration left. | |
| 34.79 | <i>Exception day 5</i> | See 34.79 <i>Exception day 4</i> . | 01.01 |
| 34.80 | <i>Exception day 6</i> | See 34.79 <i>Exception day 4</i> . | 01.01 |
| 34.81 | <i>Exception day 7</i> | See 34.79 <i>Exception day 4</i> | 01.01 |
| 34.82 | <i>Exception day 8</i> | See 34.79 <i>Exception day 4</i> . | 01.01 |
| 34.83 | <i>Exception day 9</i> | See 34.79 <i>Exception day 4</i> . | 01.01 |
| 34.84 | <i>Exception day 10</i> | See 34.79 <i>Exception day 4</i> . | 01.01 |
| 34.85 | <i>Exception day 11</i> | See 34.79 <i>Exception day 4</i> . | 01.01 |
| 34.86 | <i>Exception day 12</i> | See 34.79 <i>Exception day 4</i> . | 01.01 |
| 34.87 | <i>Exception day 13</i> | See 34.79 <i>Exception day 4</i> . | 01.01 |
| 34.88 | <i>Exception day 14</i> | See 34.79 <i>Exception day 4</i> . | 01.01 |
| 34.89 | <i>Exception day 15</i> | See 34.79 <i>Exception day 4</i> . | 01.01 |
| 34.90 | <i>Exception day 16</i> | See 34.79 <i>Exception day 4</i> . | 01.01 |

| Serial number | Name/Value | Description | Def/FbEq16 | | | | | | | | | | | | | | | | | | | | | | | | | | | | | | | | | | | | | | | | | | |
|---------------|-------------------------------------------------------------------------------------------------------------------------------------------------------------------------------------------------------------------------------------------------------------------------------------------------------------------------------------------------------------------------------------------------------------------------------------------------------------------------------------------------------------------------------------------------------------------------------------------------------------------------------------------------------------------------------------------------------------------------------------------------------------------------------------------------------------------------------------------------------------------------------------------------------------------------------------------------------------------------------------------------------------------------------------------------------------|------------------------------------------------------------------------------------------------------------------------------------------------------------------------------------------------------------------------------------------------------------------------------------------------------------------------------------------------------------------------------------------------|---------------------|--------|------|-------------|---|------------|---------------------------|---|------------|---------------------------|---|------------|---------------------------|--------|---------|---------------------------|---|---------|---------------------------|---|---------|---------------------------|---|---------|---------------------------|---|---------|---------------------------|---|---------|---------------------------|---|----------|---------------------------|----|----------|---------------------------|----|----------|---------------------------|---------|---------|--|
| 34.100 | <i>Combined timer 1</i> | Defines which timers are connected to combined timer 1. 0 = Not connected. 1 = Connected. eg. 34.01 Combined timer status . | 0000000000 00000 | | | | | | | | | | | | | | | | | | | | | | | | | | | | | | | | | | | | | | | | | | |
| | <table border="1"> <thead> <tr> <th>Bit(s)</th> <th>Name</th> <th>Description</th> </tr> </thead> <tbody> <tr><td>0</td><td>Timer 1</td><td>0 = Inactive. 1 = Active.</td></tr> <tr><td>1</td><td>Timer 2</td><td>0 = Inactive. 1 = Active.</td></tr> <tr><td>2</td><td>Timer 3</td><td>0 = Inactive. 1 = Active.</td></tr> <tr><td>3</td><td>Timer 4</td><td>0 = Inactive. 1 = Active.</td></tr> <tr><td>4</td><td>Timer 5</td><td>0 = Inactive. 1 = Active.</td></tr> <tr><td>5</td><td>Timer 6</td><td>0 = Inactive. 1 = Active.</td></tr> <tr><td>6</td><td>Timer 7</td><td>0 = Inactive. 1 = Active.</td></tr> <tr><td>7</td><td>Timer 8</td><td>0 = Inactive. 1 = Active.</td></tr> <tr><td>8</td><td>Timer 9</td><td>0 = Inactive. 1 = Active.</td></tr> <tr><td>9</td><td>Timer 10</td><td>0 = Inactive. 1 = Active.</td></tr> <tr><td>10</td><td>Timer 11</td><td>0 = Inactive. 1 = Active.</td></tr> <tr><td>11</td><td>Timer 12</td><td>0 = Inactive. 1 = Active.</td></tr> <tr><td>14...15</td><td>Reserve</td><td></td></tr> </tbody> </table> | | | Bit(s) | Name | Description | 0 | Timer 1 | 0 = Inactive. 1 = Active. | 1 | Timer 2 | 0 = Inactive. 1 = Active. | 2 | Timer 3 | 0 = Inactive. 1 = Active. | 3 | Timer 4 | 0 = Inactive. 1 = Active. | 4 | Timer 5 | 0 = Inactive. 1 = Active. | 5 | Timer 6 | 0 = Inactive. 1 = Active. | 6 | Timer 7 | 0 = Inactive. 1 = Active. | 7 | Timer 8 | 0 = Inactive. 1 = Active. | 8 | Timer 9 | 0 = Inactive. 1 = Active. | 9 | Timer 10 | 0 = Inactive. 1 = Active. | 10 | Timer 11 | 0 = Inactive. 1 = Active. | 11 | Timer 12 | 0 = Inactive. 1 = Active. | 14...15 | Reserve | |
| Bit(s) | Name | Description | | | | | | | | | | | | | | | | | | | | | | | | | | | | | | | | | | | | | | | | | | | |
| 0 | Timer 1 | 0 = Inactive. 1 = Active. | | | | | | | | | | | | | | | | | | | | | | | | | | | | | | | | | | | | | | | | | | | |
| 1 | Timer 2 | 0 = Inactive. 1 = Active. | | | | | | | | | | | | | | | | | | | | | | | | | | | | | | | | | | | | | | | | | | | |
| 2 | Timer 3 | 0 = Inactive. 1 = Active. | | | | | | | | | | | | | | | | | | | | | | | | | | | | | | | | | | | | | | | | | | | |
| 3 | Timer 4 | 0 = Inactive. 1 = Active. | | | | | | | | | | | | | | | | | | | | | | | | | | | | | | | | | | | | | | | | | | | |
| 4 | Timer 5 | 0 = Inactive. 1 = Active. | | | | | | | | | | | | | | | | | | | | | | | | | | | | | | | | | | | | | | | | | | | |
| 5 | Timer 6 | 0 = Inactive. 1 = Active. | | | | | | | | | | | | | | | | | | | | | | | | | | | | | | | | | | | | | | | | | | | |
| 6 | Timer 7 | 0 = Inactive. 1 = Active. | | | | | | | | | | | | | | | | | | | | | | | | | | | | | | | | | | | | | | | | | | | |
| 7 | Timer 8 | 0 = Inactive. 1 = Active. | | | | | | | | | | | | | | | | | | | | | | | | | | | | | | | | | | | | | | | | | | | |
| 8 | Timer 9 | 0 = Inactive. 1 = Active. | | | | | | | | | | | | | | | | | | | | | | | | | | | | | | | | | | | | | | | | | | | |
| 9 | Timer 10 | 0 = Inactive. 1 = Active. | | | | | | | | | | | | | | | | | | | | | | | | | | | | | | | | | | | | | | | | | | | |
| 10 | Timer 11 | 0 = Inactive. 1 = Active. | | | | | | | | | | | | | | | | | | | | | | | | | | | | | | | | | | | | | | | | | | | |
| 11 | Timer 12 | 0 = Inactive. 1 = Active. | | | | | | | | | | | | | | | | | | | | | | | | | | | | | | | | | | | | | | | | | | | |
| 14...15 | Reserve | | | | | | | | | | | | | | | | | | | | | | | | | | | | | | | | | | | | | | | | | | | | |
| | 0000h...FFFFh | Timers connected to combined timer 1. | 1 = 1 | | | | | | | | | | | | | | | | | | | | | | | | | | | | | | | | | | | | | | | | | | |
| 34.101 | <i>Combined timer 2</i> | Defines which timers are connected to combined timer 2. See 34.01 Combined timer status . | 0000000000 00000 | | | | | | | | | | | | | | | | | | | | | | | | | | | | | | | | | | | | | | | | | | |
| 34.102 | <i>Combined timer 3</i> | Defines which timers are connected to combined timer 3. See 34.01 Combined timer status . | 0000000000 00000 | | | | | | | | | | | | | | | | | | | | | | | | | | | | | | | | | | | | | | | | | | |
| 34.110 | <i>Extra time function</i> | Defines which combined timers (that is, timers that are connected to the combined timers) are activated with the extra time function. | 000 | | | | | | | | | | | | | | | | | | | | | | | | | | | | | | | | | | | | | | | | | | |
| | <table border="1"> <thead> <tr> <th>Bit(s)</th> <th>Name</th> <th>Description</th> </tr> </thead> <tbody> <tr><td>0</td><td>Combined 1</td><td>0 = Inactive. 1 = Active.</td></tr> <tr><td>1</td><td>Combined 2</td><td>0 = Inactive. 1 = Active.</td></tr> <tr><td>2</td><td>Combined 3</td><td>0 = Inactive. 1 = Active.</td></tr> <tr><td>3...15</td><td>Reserve</td><td></td></tr> </tbody> </table> | | | Bit(s) | Name | Description | 0 | Combined 1 | 0 = Inactive. 1 = Active. | 1 | Combined 2 | 0 = Inactive. 1 = Active. | 2 | Combined 3 | 0 = Inactive. 1 = Active. | 3...15 | Reserve | | | | | | | | | | | | | | | | | | | | | | | | | | | | |
| Bit(s) | Name | Description | | | | | | | | | | | | | | | | | | | | | | | | | | | | | | | | | | | | | | | | | | | |
| 0 | Combined 1 | 0 = Inactive. 1 = Active. | | | | | | | | | | | | | | | | | | | | | | | | | | | | | | | | | | | | | | | | | | | |
| 1 | Combined 2 | 0 = Inactive. 1 = Active. | | | | | | | | | | | | | | | | | | | | | | | | | | | | | | | | | | | | | | | | | | | |
| 2 | Combined 3 | 0 = Inactive. 1 = Active. | | | | | | | | | | | | | | | | | | | | | | | | | | | | | | | | | | | | | | | | | | | |
| 3...15 | Reserve | | | | | | | | | | | | | | | | | | | | | | | | | | | | | | | | | | | | | | | | | | | | |
| | 0000h...FFFFh | Combined timers including the extra timer. | 1 = 1 | | | | | | | | | | | | | | | | | | | | | | | | | | | | | | | | | | | | | | | | | | |
| 34.111 | <i>Extra time activation source</i> | Selects the source of extra time activation signal. 0 = inhibited. 1 = Enabled. | Off | | | | | | | | | | | | | | | | | | | | | | | | | | | | | | | | | | | | | | | | | | |
| | Off | 0 | 0 | | | | | | | | | | | | | | | | | | | | | | | | | | | | | | | | | | | | | | | | | | |
| | Open | 1 | 1 | | | | | | | | | | | | | | | | | | | | | | | | | | | | | | | | | | | | | | | | | | |
| | <i>Other [bit]</i> | Source selection (See 130 on page Terms and abbreviations). | - | | | | | | | | | | | | | | | | | | | | | | | | | | | | | | | | | | | | | | | | | | |
| 34.112 | <i>Extra time duration</i> | Defines the time inside which the extra time is deactivated after extra time activation signal is switched off. Example: If parameter 34.111 Extra time activation source is set to DI1 and 34.112 Extra time duration is set to 00 01:30, the extra time is active for 1 hour and 30 minutes after digital input DI is deactivated. | 00 00:00 | | | | | | | | | | | | | | | | | | | | | | | | | | | | | | | | | | | | | | | | | | |

| Serial number | Name/Value | Description | Def/FbEq16 |
|------------------------------------|---------------------------------------|-----------------------------------------------------------------------------------------------------------------------------------------------------------------------------------------------------------------------------------------------------------------------------------------------------------------|----------------------|
| | 00 00:00...00 00:00 | Extra time duration. | 1 = 1 |
| 35 Motor thermal protection | | | |
| | | Motor thermal protection settings such as temperature measurement configuration, load curve definition and motor fan control configuration. See also section <i>Motor thermal protection</i> (page 89). | |
| 35.01 | <i>Estimated temperature of motor</i> | Displays the motor temperature as estimated by the internal motor thermal protection model (See parameters 35.50...35.55). The unit is selected with parameter 96.16 <i>unit selection</i> . This parameter is read-only. | - |
| | -60...1000 °C or -76...1832 °F | Estimated motor temperature. | 1 = 1° |
| 35.02 | <i>Measured temperature 1</i> | Displays the temperature received through the source defined by parameter 35.11 <i>Temperature 1 source</i> . The unit is selected with parameter 96.16 <i>unit selection</i> . This parameter is read-only. | - |
| | -10...1,000 °C or 14...1,000.00 °C | Measured temperature 1. | 1 = 1 unit |
| 35.03 | <i>Measured temperature 2</i> | Displays the temperature received through the source defined by parameter 35.21 <i>Temperature 2 source</i> . The unit is selected with parameter 96.16 <i>unit selection</i> . This parameter is read-only. | - |
| | -10...1,000 °C or 14...1,000.00 °C | Measured temperature 2. | 1 = 1 unit |
| 35.05 | <i>Motor overload level</i> | Shows the motor overload level as a percent of the motor overload fault limit. See parameter 35.56 <i>Motor overload action</i> and section <i>Motor overload protection</i> (page 199). | 0.0 |
| | 0.0...300.0% | Motor overload level. 0.0% No motor overloading 88.0% Motor overloaded to warning level 100.0% Motor overloaded to fault level | 10 = 1% |
| 35.11 | <i>Temperature 1 source</i> | Selects the source from which measured temperature 1 is read. Usually this source is from a sensor connected to the motor controlled by the drive, but it could be used to measure and monitor a temperature from other parts of the process as long as a suitable sensor is used as per the selection list. | Measured temperature |
| | Disabled | None. Temperature monitoring function 1 is disabled. | 0 |
| | Estimated temperature | Estimated motor temperature (see parameter 35.01 <i>Estimated temperature of motor</i>). The temperature is estimated from an internal drive calculation. It is important to set up the ambient temperature of the motor in 35.50 <i>Motor ambient temperature</i> . | 1 |

| Serial number | Name/Value | Description | Def/FbEq16 |
|---------------|----------------------|-----------------------------------------------------------------------------------------------------------------------------------------------------------------------------------------------------------------------------------------------------------------------------------------------------------------------------------------------------------------------------------------------------------------------------------------------------------------------------------------------------------------------------------------------------------------------------------------------------------------------------------------------------------------------------------------------------------------------------------------------------------------------------------------------------------------------------------------------------------------------------------------------------------------------------------------------------|------------|
| | KTY84 analog I/O | <p>KTY84 sensor connected to the analog input selected by parameter 35.14 Temperature 1 AI source and an analog output.</p> <p>The following settings are required:</p> <ul style="list-style-type: none"> Set the hardware jumper or switch related to the analog input to U (voltage). Any change must be validated by a control unit reboot. Set the appropriate analog input unit selection parameter in group 12 Standard AI to V (volt). In parameter group 13 Standard AO, set the source selection parameter of the analog output to Temp sensor 1 excitation. <p>The analog output feeds a constant current through the sensor. As the resistance of the sensor increases along with its temperature, the voltage over the sensor increases. The voltage is read by the analog input and converted into degrees.</p> | 2 |
| | Reserved | | 3...4 |
| | 1 x Pt100 analog I/O | <p>Pt100 sensor connected to a standard analog input selected by parameter 35.14 Temperature 1 AI source and an analog output.</p> <p>The following settings are required:</p> <ul style="list-style-type: none"> Set the hardware jumper or switch related to the analog input to U (voltage). Any change must be validated by a control unit reboot. Set the appropriate analog input unit selection parameter in group 12 Standard AI to V (volt). In parameter group 13 Standard AO, set the source selection parameter of the analog output to Temp sensor 1 excitation. <p>The analog output feeds a constant current through the sensor. As the resistance of the sensor increases along with its temperature, the voltage over the sensor increases. The voltage is read by the analog input and converted into degrees.</p> | 5 |
| | 2 x Pt100 analog I/O | As selection 1 x Pt100 analog I/O , but with two sensors connected in series. Using multiple sensors improves measurement accuracy significantly. | 6 |
| | 3 x Pt100 analog I/O | As selection 1 x Pt100 analog I/O , but with three sensors connected in series. Using multiple sensors improves measurement accuracy significantly. | 7 |
| | PTC DI6 | <p>PTC sensor is connected to DI6.</p> <p>Note: With a PTC sensor, the value shown is not a valid measurement. Either 0 ohm (normal temperature) or the value of parameter 35.22 Temperature 1 AI source (excessive temperature) is shown.</p> | 8 |
| | Reserved | | 9...10 |
| | Direct temperature | The temperature is taken from the source selected by parameter 35.14 . The value of the source is assumed to be in the unit of temperature specified by 96.16 . | 11 |

| Serial number | Name/Value | Description | Def/FbEq16 |
|---------------|-----------------------|-----------------------------------------------------------------------------------------------------------------------------------------------------------------------------------------------------------------------------------------------------------------------------------------------------------------------------------------------------------------------------------------------------------------------------------------------------------------------------------------------------------------------------------------------------------------------------------------------------------------------------------------------------------------------------------------------------------------------------------------------------------------------------------------------------------------------------------------------------------------------------------------------------------------------------------------------------|------------|
| | KTY83 analog I/O | <p>KTY83 sensor connected to the analog input selected by parameter 35.14 Temperature 1 AI source and an analog output.</p> <p>The following settings are required:</p> <ul style="list-style-type: none"> • Set the hardware jumper or switch related to the analog input to U (voltage). Any change must be validated by a control unit reboot. • Set the appropriate analog input unit selection parameter in group 12 Standard AI to V (volt). • In parameter group 13 Standard AO, set the source selection parameter of the analog output to Temp sensor 1 excitation. <p>The analog output feeds a constant current through the sensor. As the resistance of the sensor increases along with its temperature, the voltage over the sensor increases. The voltage is read by the analog input and converted into degrees.</p> | 12 |
| | 1 × Pt1000 analog I/O | <p>Pt1000 sensor connected to a standard analog input selected by parameter 35.14 Temperature 1 AI source and an analog output.</p> <p>The following settings are required:</p> <ul style="list-style-type: none"> • Set the hardware jumper or switch related to the analog input to U (voltage). Any change must be validated by a control unit reboot. • Set the appropriate analog input unit selection parameter in group 12 Standard AI to V (volt). • In parameter group 13 Standard AO, set the source selection parameter of the analog output to Temp sensor 1 excitation. <p>The analog output feeds a constant current through the sensor. As the resistance of the sensor increases along with its temperature, the voltage over the sensor increases. The voltage is read by the analog input and converted into degrees.</p> | 13 |
| | 2 × Pt1000 analog I/O | <p>As selection 1 × Pt1000 analog I/O, but with two sensors connected in series. Using multiple sensors improves measurement accuracy significantly.</p> | 14 |
| | 3 × Pt1000 analog I/O | <p>As selection 1 × Pt1000 analog I/O, but with three sensors connected in series. Using multiple sensors improves measurement accuracy significantly.</p> | 15 |

| Serial number | Name/Value | Description | Def/FbEq16 |
|-----------------------|---------------------------------------------|-----------------------------------------------------------------------------------------------------------------------------------------------------------------------------------------------------------------------------------------------------------------------------------------------------------------------------------------------------------------------------------------------------------------------------------------------------------------------------------------------------------------------------------------------------------------------------------------------------------------------------------------------------------------------------------------------------------------------------------------------------------------------------------------------------------------------------------------------------------------------------------------------------------------------------|--------------|
| | Ni1000 | Ni1000 sensor connected to the analog input selected by parameter 35.14 Temperature 1 AI source and an analog output. The following settings are required: <ul style="list-style-type: none"> Set the hardware jumper or switch related to the analog input to U (voltage). Any change must be validated by a control unit reboot. Set the appropriate analog input unit selection parameter in group 12 Standard AI to V (volt). In parameter group 13 Standard AO, set the source selection parameter of the analog output to Temp sensor 1 excitation. The analog output feeds a constant current through the sensor. As the resistance of the sensor increases along with its temperature, the voltage over the sensor increases. The voltage is read by the analog input and converted into degrees. | 16 |
| | Reserved | | 17...18 |
| | PTC extension module | PTC is connected to the CMOD-02 multifunction extension module, which is installed in drive slot 2. See chapter Optional I/O extension modules, section CMOD-02 multifunction extension module (external 24 V AC/DC and isolated PTC interface) in the <i>Hardware manual</i> of the drive). | 19 |
| | PTC analog I/O | PTC sensor connected to the analog input selected by parameter 35.14 and an analog output. The required settings are the same as with selection KTY84 analog I/O . If a PTC sensor is used, the voltage ready by the analog input is converted into ohms. Note: With this selection, the control program converts the analog signal to PTC resistance value in ohms and shows it in parameter 35.02 . The parameter name and unit still refer to temperature. | 20 |
| | Therm(0) | PTC sensor or a normally closed thermistor relay connected to digital input DI6. The motor is overheated when the digital input is 0. | 21 |
| | Therm(1) | Normally open thermistor relay connected to digital input DI6. The motor is overheated when the digital input is 1. | 22 |
| | Reserved | | 23 |
| 35.12 | Temperature 1 fault limit | Define fault limit of temperature monitoring function 1. The unit is selected by the parameter 96.16 unit selection . Note: it has PTC sensor and the unit is ohms. | 130 °C |
| 35.13 | Temperature 1 warning limit | Define alarm limit of temperature monitoring function 1. The unit is selected by the parameter 96.16 unit selection . Note: it has PTC sensor and the unit is ohms. | 110 °C |
| 35.14 | Temperature 1 AI source | Selects 1 x PT100 analog I/O , 2 x Pt100 analog I/O , 3 x Pt100 analog I/O , Direct temperature the input for parameter 35.11 Temperature 1 source . | Not selected |
| | Not selected | None. | 0 |
| | AI1 actual value | Analog input AI1 on the control unit. | 1 |
| | AI2 actual value | Analog input AI2 on the control unit. | 2 |
| | Other | Source selection (See 130 on page Terms and abbreviations). | - |

| Serial number | Name/Value | Description | Def/FbEq16 |
|---------------|-----------------------------|-----------------------------------------------------------------------------------------------------------------------------------------------------------------------------------------------------------------------------------------------------------------------------------------------------------------------------------------------------------------------------------------------------------------------------------------------------------------------------------------------------------------------------------------------------------------------------------------------------------------------------------------------------------------------------------------------------------------------------------------------------------------------------------------------------------------------------------------------------------------------------------------------|------------|
| 35.21 | <i>Temperature 2 source</i> | Selects the source from which measured temperature 2 is read. Usually this source is from a sensor connected to the motor controlled by the drive, but it could be used to measure and monitor a temperature from other parts of the process as long as a suitable sensor is used as per the selection list. | Disabled |
| | Disabled | None. Temperature monitoring function 2 is disabled. | 0 |
| | Estimated temperature | Estimated motor temperature (see parameter <i>35.01 Estimated temperature of motor</i>). The temperature is estimated from an internal drive calculation. It is important to set up the ambient temperature of the motor in <i>35.50 Motor ambient temperature</i> . | 1 |
| | KTY84 analog I/O | KTY84 sensor connected to the analog input selected by parameter <i>35.24 Temperature 2 AI source</i> and an analog output. The following settings are required: <ul style="list-style-type: none"> Set the hardware jumper or switch related to the analog input to U (voltage). Any change must be validated by a control unit reboot. Set the appropriate analog input unit selection parameter in group <i>12 Standard AI</i> to V (volt). In parameter group <i>13 Standard AO</i>, set the source selection parameter of the analog output to <i>Temp sensor 2 excitation</i>. The analog output feeds a constant current through the sensor. As the resistance of the sensor increases along with its temperature, the voltage over the sensor increases. The voltage is read by the analog input and converted into degrees. | 2 |
| | Reserved | | 3...4 |
| | 1 × Pt100 analog I/O | Pt100 sensor connected to a standard analog input selected by parameter <i>35.24 Temperature 2 AI source</i> and an analog output. The following settings are required: <ul style="list-style-type: none"> Set the hardware jumper or switch related to the analog input to U (voltage). Any change must be validated by a control unit reboot. Set the appropriate analog input unit selection parameter in group <i>12 Standard AI</i> to V (volt). In parameter group <i>13 Standard AO</i>, set the source selection parameter of the analog output to <i>Temp sensor 2 excitation</i>. The analog output feeds a constant current through the sensor. As the resistance of the sensor increases along with its temperature, the voltage over the sensor increases. The voltage is read by the analog input and converted into degrees. | 5 |
| | 2 × Pt100 analog I/O | As selection <i>1 × Pt100 analog I/O</i> , but with two sensors connected in series. Using multiple sensors improves measurement accuracy significantly. | 6 |
| | 3 × Pt100 analog I/O | As selection <i>1 × Pt100 analog I/O</i> , but with three sensors connected in series. Using multiple sensors improves measurement accuracy significantly. | 7 |

| Serial number | Name/Value | Description | Def/FbEq16 |
|---------------|-----------------------|------------------------------------------------------------------------------------------------------------------------------------------------------------------------------------------------------------------------------------------------------------------------------------------------------------------------------------------------------------------------------------------------------------------------------------------------------------------------------------------------------------------------------------------------------------------------------------------------------------------------------------------------------------------------------------------------------------------------------------------------------------------------------------------------------------------------------------------------------------------------------------------------------------------------------------|------------|
| | PTC DI6 | PTC sensor is connected to DI6. Note: With a PTC sensor, the value shown is not a valid measurement. Either 0 ohm (normal temperature) or the value of parameter 35.22 Temperature 2 fault limit (excessive temperature) is shown. | 8 |
| | Reserved | | 9...10 |
| | Direct temperature | The temperature is taken from the source selected by parameter 35.24 . The value of the source is assumed to be in the unit of temperature specified by 96.16 . | 11 |
| | KTY83 analog I/O | KTY83 sensor connected to the analog input selected by parameter 35.14 Temperature 1 AI source and an analog output. The following settings are required: <ul style="list-style-type: none"> Set the hardware jumper or switch related to the analog input to U (voltage). Any change must be validated by a control unit reboot. Set the appropriate analog input unit selection parameter in group 12 Standard AI to V (volt). In parameter group 13 Standard AO, set the source selection parameter of the analog output to Temp sensor 2 excitation. The analog output feeds a constant current through the sensor. As the resistance of the sensor increases along with its temperature, the voltage over the sensor increases. The voltage is read by the analog input and converted into degrees. | 12 |
| | 1 x Pt1000 analog I/O | Pt1000 sensor connected to a standard analog input selected by parameter 35.14 Temperature 1 AI source and an analog output. The following settings are required: <ul style="list-style-type: none"> Set the hardware jumper or switch related to the analog input to U (voltage). Any change must be validated by a control unit reboot. Set the appropriate analog input unit selection parameter in group 12 Standard AI to V (volt). In parameter group 13 Standard AO, set the source selection parameter of the analog output to Temp sensor 2 excitation. The analog output feeds a constant current through the sensor. As the resistance of the sensor increases along with its temperature, the voltage over the sensor increases. The voltage is read by the analog input and converted into degrees. | 13 |
| | 2 x Pt1000 analog I/O | As selection 1 x Pt1000 analog I/O , but with two sensors connected in series. Using multiple sensors improves measurement accuracy significantly. | 14 |
| | 3 x Pt1000 analog I/O | As selection 1 x Pt1000 analog I/O , but with three sensors connected in series. Using multiple sensors improves measurement accuracy significantly. | 15 |

| Serial number | Name/Value | Description | Def/FbEq16 |
|-----------------------|---------------------------------------------|-----------------------------------------------------------------------------------------------------------------------------------------------------------------------------------------------------------------------------------------------------------------------------------------------------------------------------------------------------------------------------------------------------------------------------------------------------------------------------------------------------------------------------------------------------------------------------------------------------------------------------------------------------------------------------------------------------------------------------------------------------------------------------------------------------------------------------------------------------------------------------------------------------------------------------------------------|---------------------|
| | Ni1000 | <p>Ni1000 sensor connected to the analog input selected by parameter 35.14 Temperature 1 AI source and an analog output.</p> <p>The following settings are required:</p> <ul style="list-style-type: none"> Set the hardware jumper or switch related to the analog input to U (voltage). Any change must be validated by a control unit reboot. Set the appropriate analog input unit selection parameter in group 12 Standard AI to V (volt). In parameter group 13 Standard AO, set the source selection parameter of the analog output to Temp sensor 2 excitation. <p>The analog output feeds a constant current through the sensor. As the resistance of the sensor increases along with its temperature, the voltage over the sensor increases. The voltage is read by the analog input and converted into degrees.</p> | 16 |
| | Reserved | | 17...18 |
| | PTC extension module | PTC is connected to the CMOD-02 multifunction extension module, which is installed in drive slot 2. See chapter Optional I/O extension modules, section CMOD-02 multifunction extension module (external 24 V AC/DC and isolated PTC interface) in the <i>Hardware manual</i> of the drive). | 19 |
| | PTC analog I/O | <p>PTC sensor connected to the analog input selected by parameter 35.24 and an analog output.</p> <p>The required settings are the same as with selection KTY84 analog I/O. If a PTC sensor is used, the voltage ready by the analog input is converted into ohms.</p> <p>Note: With this selection, the control program converts the analog signal to PTC resistance value in ohms and shows it in parameter 35.03. The parameter name and unit still refer to temperature.</p> | 20 |
| | Therm(0) | PTC sensor or a normally closed thermistor relay connected to digital input DI6. The motor is overheated when the digital input is 0. | 21 |
| | Therm(1) | Normally open thermistor relay connected to digital input DI6. The motor is overheated when the digital input is 1. | 22 |
| 35.22 | Temperature 2 fault limit | <p>Define fault limit of temperature monitoring function 2. The unit is selected by the parameter 96.16 unit selection.</p> <p>Note: it has PTC sensor and the unit is ohms.</p> | 130 °C |
| 35.23 | Temperature 2 warning limit | <p>Define alarm limit of temperature monitoring function 2. The unit is selected by the parameter 96.16 unit selection.</p> <p>Note: it has PTC sensor and the unit is ohms.</p> | 110 °C |
| 35.24 | Temperature 2 AI source | Selects 1 x PT100 analog I/O , 2 x PT100 analog I/O , 3 x PT100 analog I/O , Direct temperature the input for parameter 35.21 Temperature 2 source . | <i>Not selected</i> |
| | Not selected | None. | 0 |
| | AI1 actual value | Analog input AI1 on the control unit. | 1 |
| | AI2 actual value | Analog input AI2 on the control unit. | 2 |
| | <i>Other</i> | Source selection (See page 130 Terms and abbreviations). | - |

| Serial number | Name/Value | Description | Def/FbEq16 |
|---------------|--------------------------------------------------------------------------------------------------------------------------------------------------------------------------------------------------------------------------------------------------------------------------------------------------------------------------------------------------------------------------------------------------------------------------------------------------------------------------------------------------------------------------------------------------------------------------------------------------------------------------------------------------------------------|-----------------------------------------------------------------------------------------------------------------------------------------------------------------------------------------------------------------------------------------------------------------------------------------------------------------------------------------------------------------------------------------------------------------------------------------------------------------------------------------------------------------------------------------------------------------------------------------|----------------|
| 35.50 | <i>Motor ambient temperature</i> | <p>Defines the ambient temperature of the motor for the motor thermal protection model. The unit is selected with parameter 96.16 unit selection.</p> <p>The motor thermal protection model estimates the motor temperature on the basis of parameters 35.50...35.55. The motor temperature increases if it operates in the region above the load curve, and decreases if it operates in the region below the load curve.</p> <p>Warning! The model cannot protect the motor if the motor does not cool properly because of dust, dirt, etc.</p> | 20 °C or 68 °F |
| | -60...100 °C or -75 ... 212 °F | ambient temperature. | 1 = 1° |
| 35.51 | <i>Motor load curve</i> | <p>Defines the motor load curve together with parameters 35.52 Zero speed load and 35.53 Load break point. The load curve is used by the motor thermal protection model to estimate the motor temperature.</p> <p>When the parameter is set to 100%, the maximum load is taken as the value of parameter 99.06 Motor nominal current (higher loads heat up the motor). The load curve level should be adjusted if the ambient temperature differs from the nominal value set in 35.50 Motor ambient temperature.</p> | 100% |
| | <p>The graph plots the ratio of motor current to nominal current, I/in (%), on the vertical axis against Drive output frequency on the horizontal axis. The vertical axis has markings at 50, 100, and 150. A horizontal dashed line is drawn at 100%. The curve starts at a value of 35.52 on the vertical axis. It rises linearly until it reaches the 100% mark on the vertical axis. At this point, the frequency on the horizontal axis is labeled 35.53. From this point, the curve continues as a horizontal line at the 100% level. A legend indicates that I is Motor current and in is Nominal motor current.</p> | | |
| | 50...150% | Maximum load for the motor load curve. | 1 = 1% |
| 35.52 | <i>Zero speed load</i> | <p>Defines the motor load curve together with parameters 35.51 Motor load curve and 35.53 Load break point. Defines the maximum motor load at zero speed of the load curve. A higher value can be used if the motor has an external motor fan to boost the cooling. See the motor manufacturer's recommendations.</p> <p>See parameter 35.51 Motor load curve.</p> | 100% |
| | 50...150% | Zero speed load for the motor load curve. | 1 = 1% |

| Serial number | Name/Value | Description | Def/FbEq16 |
|---------------|---------------------------------------|---------------------------------------------------------------------------------------------------------------------------------------------------------------------------------------------------------------------------------------------------------------------------------------------------------------------------------------------------------------------------------------------------------------------------------------------------------------|-------------------------------------|
| 35.53 | <i>Load break point</i> | Defines the motor load curve together with parameters 35.51 Motor load curve and 35.52 Zero speed load . Defines the break point frequency of the load curve i.e. the point at which the motor load curve begins to decrease from the value of parameter 35.51 Motor load curve towards the value of parameter 35.52 Zero speed load . See parameter 35.51 Motor load curve . | 45.00 Hz |
| | 1.00...500.00 Hz | Break point for the motor load curve. | See parameter 46.02 |
| 35.54 | <i>Motor nominal temperature rise</i> | Defines the temperature rise of the motor above ambient when the motor is loaded with nominal current. See the motor manufacturer's recommendations. The unit is selected with parameter 96.16 unit selection . | 80 °C or 176 °F |
| | | | |
| | 0...572.00 °F or 32...572 °F | Temperature rise. | 1 = 1° |

| Serial number | Name/Value | Description | Def/FbEq16 |
|------------------------------------------------------------------------------------------------------------------------------------------------------------------------------------------------------------------------------------------------------------------------------------------------------------------------------------------------------------------------------------------------------------------------------------------------------------------------------------------------------------------------------------------------------------------------------------------------------------------------------------------------------------------------------------------------------------------------------------------------------------------------------------------------------------------------------------------------------------------------------------------------------------------------------------------------------------------------------------------------------------------------------------------------------------------------------------------------------------------------------------------------------------------------------------|---------------------------------------------------|-------------------------------------------------------------------------------------------------------------------------------------------------------------------------------------------------------------------------------------------------------------------------------------------------------------------------------------------------------------|--------------------------|
| 35.55 | <i>The motor thermal protection time constant</i> | Defines the thermal time constant for use with the motor thermal protection model (defined as the time to reach 63% of the nominal motor temperature). See the motor manufacturer's recommendations. | 256 s |
| <p>The figure consists of two vertically aligned graphs sharing a common horizontal axis labeled 'Times'. The top graph plots 'Motor current' on the vertical axis. It shows a rectangular pulse that starts at a certain point on the time axis, rises to a constant value of 100%, and then falls back to zero. Vertical dashed lines mark the start and end of this pulse. The bottom graph plots 'Temperature rise' on the vertical axis. It shows a curve that starts at zero, rises asymptotically towards 100%, and then decays back to zero after the pulse ends. A horizontal dashed line at 63% on the temperature rise axis intersects the rising part of the curve. A vertical dashed line from this intersection point down to the time axis marks the end of the 'Motor thermal time' interval. Another vertical dashed line from the start of the pulse to the 63% mark on the temperature rise axis indicates the time taken to reach 63% of the nominal temperature during the pulse. The label 'Motor thermal time' is placed below the time axis, with a double-headed arrow indicating the duration from the start of the pulse to the 63% mark.</p> | | | |
| | 100...10000 s | Motor thermal time constant. | 1 = 1s |
| 35.56 | <i>Motor overload action</i> | Selects the action taken when motor overload is detected. See section <i>Motor overload protection</i> (page 199). | <i>Warning and fault</i> |
| | No action | No action taken. | 0 |
| | Warning only | Drive generates warning <i>A783 Motor overload</i> when the motor is overloaded to the warning level, that is, parameter <i>35.05 Motor overload level</i> reaches value 88.0%. | 1 |
| | Warning and fault | Drive generates warning <i>A783 Motor overload</i> when the motor is overloaded to the warning level, that is, parameter <i>35.05 Motor overload level</i> reaches value 88.0%. Drive trips on fault <i>7122 Motor overload</i> when the motor is overloaded to the fault level, that is, parameter <i>35.05 Motor overload level</i> reaches value 100.0%. | 2 |
| 35.57 | <i>Motor overload class</i> | Defines the motor overload class to be used. The class of protection is specified by the user as the time for tripping at 7.2 times (IEC 60947-4-1) or 6 times (NEMA ICS) the tripping level current. See section <i>Motor overload protection</i> (page 199). | <i>Class 20</i> |
| | Class 5 | Motor overload class 5. | 0 |
| | Class 10 | Motor overload class 10. | 1 |
| | Class 20 | Motor overload class 20. | 2 |
| | Class 30 | Motor overload class 30. | 3 |
| | Class 40 | Motor overload class 40. | 4 |

| Serial number | Name/Value | Description | Def/FbEq16 |
|-------------------------|--------------------------|------------------------------------------------------------------------------------------------------------------------------------------------------------------------------------------------------------------------------------------------------------------------------------------------------------------------------------------------------------------------------------------------------------------------------------------------------------------------------------------------------------------------------------------------------------------------------------------------------------------------------------------------------------------------------------------------------------------------------------|---------------------|
| 36 Load analyzer | | Peak value and amplitude logger settings. See also section <i>Load analyzer</i> (page 92). | |
| 36.01 | <i>PVL signal source</i> | Selects the signal to be monitored by the peak value logger. The signal is filtered using the filtering time specified by parameter <i>36.02 PVL filter time</i> . The peak value is stored, along with other pre-selected signals at the time, into parameters <i>36.10...36.15</i> . The peak value logger can be reset using parameter <i>36.09 Reset loggers</i> . The logger is also reset whenever the signal source is changed. The date and time of the last reset are stored into parameters <i>36.16</i> and <i>36.17</i> respectively. | <i>Output power</i> |
| | Not selected | None (peak value logger disabled). | 0 |
| | Motor speed used | <i>01.01 Motor speed</i> (page 133). | 1 |
| | Reserved | | 2 |
| | Output frequency | <i>01.06 Output frequency</i> (page 133). | 3 |
| | Motor current | <i>01.07 Motor current</i> (page 133). | 4 |
| | Reserved | | 5 |
| | Motor torque | <i>01.10 Motor torque (%)</i> (page 133). | 6 |
| | DC voltage | <i>01.11 DC voltage</i> (page 133). | 7 |
| | Output power | <i>01.14 Output frequency</i> (page 133). | 8 |
| | Reserved | | 9 |
| | Speed ref ramp in | <i>23.01 Speed ref ramp input</i> (page 307). | 10 |
| | Speed ref ramp out | <i>23.02 Speed ref ramp output</i> (page 307). | 11 |
| | Speed ref used | <i>24.01 Used speed reference</i> (page 311). | 12 |
| | Torque ref used | <i>26.02 Torque reference used</i> (page 318). | 13 |
| | Freq ref used | <i>28.02 Frequency ref ramp output</i> (page 189). | 14 |
| | Reserved | | 15 |
| | Process PID out | <i>40.01 PID output value</i> (page 240). | 16 |
| | <i>Other</i> | Source selection (see <i>Terms and abbreviations</i> on page 130). | - |
| 36.02 | <i>PVL filter time</i> | Peak value logger filtering time. See parameter <i>36.01 PVL signal source</i> . | 2.00 s |
| | 0.00...120.00 s | Peak value logger filtering time. | 100 = 1 s |
| 36.06 | <i>AL2 signal source</i> | Selects the signal to be monitored by amplitude logger 2. The signal is sampled at 200 ms intervals. The results are displayed by parameters <i>36.40...36.49</i> . Each parameter represents an amplitude range, and shows what portion of the samples fall within that range. The signal value corresponding to 100% is defined by parameter <i>36.07 AL2 signal scaling</i> . Amplitude logger 2 can be reset using parameter <i>36.09 Reset loggers</i> . The logger is also reset whenever the signal source or scaling is changed. The date and time of the last reset are stored into parameters <i>36.50</i> and <i>36.51</i> respectively. For the selections, see parameter <i>36.01 PVL signal source</i> . | <i>Motor torque</i> |

| Serial number | Name/Value | Description | Def/FbEq16 |
|---------------|-------------------------------|----------------------------------------------------------------------------------------------------------------------------------------------------------------------------------------------------------------------------|--------------------------------|
| 36.07 | <i>AL2 signal scaling</i> | Defines the signal value that corresponds to 100% amplitude. | 100.00 |
| | 0.00...32767.00 | Signal value corresponding to 100%. | 1 = 1 |
| 36.09 | <i>Reset loggers</i> | Resets the peak value logger and/or amplitude logger 2. (Amplitude logger 1 cannot be reset.) | <i>Done</i> |
| | Done | Reset completed or not requested (normal operation). | 0 |
| | All | Reset both the peak value logger and amplitude logger 2. | 1 |
| | PVL | Reset the peak value logger. | 2 |
| | AL2 | Reset amplitude logger 2. | 3 |
| 36.10 | <i>PVL peak value</i> | Peak value recorded by the peak value logger. | 0.00 |
| | -32768.00... 32767.00 | Peak value. | 1 = 1 |
| 36.11 | <i>PVL peak date</i> | The date on which the peak value was recorded. | 01.01.1980 |
| | - | Peak occurrence date. | - |
| 36.12 | <i>PVL peak time</i> | The time at which the peak value was recorded. | 00:00:00 |
| | - | Peak occurrence time. | - |
| 36.13 | <i>PVL current at peak</i> | Motor current at the moment the peak value was recorded. | 0.00 A |
| | -32768.00... 32767.00 A | Motor current at peak. | 1 = 1 A |
| 36.14 | <i>PVL DC voltage at peak</i> | Voltage in the intermediate DC circuit of the drive at the moment the peak value was recorded. | 0.00 V |
| | 0.00...2000.00 V | DC voltage at peak. | 10 = 1 V |
| 36.15 | <i>PVL speed at peak</i> | Motor speed at the moment the peak value was recorded. | 0.00 rpm |
| | -30000.00... 30000.00 rpm | Motor speed at peak. | See par. 46.01 |
| 36.16 | <i>PVL reset date</i> | The date on which the peak value logger was last reset. | 01.01.1980 |
| | - | Last reset date of the peak value logger. | - |
| 36.17 | <i>PVL reset time</i> | The time at which the peak value logger was last reset. | 00:00:00 |
| | - | Last reset time of the peak value logger. | - |
| 36.20 | <i>AL1 0 to 10%</i> | Percentage of samples recorded by amplitude logger 1 that fall between 0 and 10%. 100% corresponds to the I_{max} value given in the ratings table in chapter Technical data in the <i>Hardware manual</i> of the drive. | 0.00% |
| | 0.00...100.00% | Amplitude logger 1 samples between 0 and 10%. | 1 = 1% |
| 36.21 | <i>AL1 10 to 20%</i> | Percentage of samples recorded by amplitude logger 1 that fall between 10 and 20%. | 0.00% |
| | 0.00...100.00% | Amplitude logger 1 samples between 10 and 20%. | 1 = 1% |
| 36.22 | <i>AL1 20 to 30%</i> | Percentage of samples recorded by amplitude logger 1 that fall between 20 and 30%. | 0.00% |
| | 0.00...100.00% | Amplitude logger 1 samples between 20 and 30%. | 1 = 1% |
| 36.23 | <i>AL1 30 to 40%</i> | Percentage of samples recorded by amplitude logger 1 that fall between 30 and 40%. | 0.00% |
| | 0.00...100.00% | Amplitude logger 1 samples between 30 and 40%. | 1 = 1% |

| Serial number | Name/Value | Description | Def/FbEq16 |
|----------------------|----------------------|------------------------------------------------------------------------------------|-------------------|
| 36.24 | <i>AL1 40 to 50%</i> | Percentage of samples recorded by amplitude logger 1 that fall between 40 and 50%. | 0.00% |
| | 0.00...100.00% | Amplitude logger 1 samples between 40 and 50%. | 1 = 1% |
| 36.25 | <i>AL1 50 to 60%</i> | Percentage of samples recorded by amplitude logger 1 that fall between 50 and 60%. | 0.00% |
| | 0.00...100.00% | Amplitude logger 1 samples between 50 and 60%. | 1 = 1% |
| 36.26 | <i>AL1 60 to 70%</i> | Percentage of samples recorded by amplitude logger 1 that fall between 60 and 70%. | 0.00% |
| | 0.00...100.00% | Amplitude logger 1 samples between 60 and 70%. | 1 = 1% |
| 36.27 | <i>AL1 70 to 80%</i> | Percentage of samples recorded by amplitude logger 1 that fall between 70 and 80%. | 0.00% |
| | 0.00...100.00% | Amplitude logger 1 samples between 70 and 80%. | 1 = 1% |
| 36.28 | <i>AL1 80 to 90%</i> | Percentage of samples recorded by amplitude logger 1 that fall between 80 and 90%. | 0.00% |
| | 0.00...100.00% | Amplitude logger 1 samples between 80 and 90%. | 1 = 1% |
| 36.29 | <i>AL1 over 90%</i> | Percentage of samples recorded by amplitude logger 1 that exceed 90%. | 0.00% |
| | 0.00...100.00% | Amplitude logger 1 samples over 90%. | 1 = 1% |
| 36.40 | <i>AL2 0 to 10%</i> | Percentage of samples recorded by amplitude logger 2 that fall between 0 and 10%. | 0.00% |
| | 0.00...100.00% | Amplitude logger 2 samples between 0 and 10%. | 1 = 1% |
| 36.41 | <i>AL2 10 to 20%</i> | Percentage of samples recorded by amplitude logger 2 that fall between 10 and 20%. | 0.00% |
| | 0.00...100.00% | Amplitude logger 2 samples between 10 and 20%. | 1 = 1% |
| 36.42 | <i>AL2 20 to 30%</i> | Percentage of samples recorded by amplitude logger 2 that fall between 20 and 30%. | 0.00% |
| | 0.00...100.00% | Amplitude logger 2 samples between 20 and 30%. | 1 = 1% |
| 36.43 | <i>AL2 30 to 40%</i> | Percentage of samples recorded by amplitude logger 2 that fall between 30 and 40%. | 0.00% |
| | 0.00...100.00% | Amplitude logger 2 samples between 30 and 40%. | 1 = 1% |
| 36.44 | <i>AL2 40 to 50%</i> | Percentage of samples recorded by amplitude logger 2 that fall between 40 and 50%. | 0.00% |
| | 0.00...100.00% | Amplitude logger 2 samples between 40 and 50%. | 1 = 1% |
| 36.45 | <i>AL2 50 to 60%</i> | Percentage of samples recorded by amplitude logger 2 that fall between 50 and 60%. | 0.00% |
| | 0.00...100.00% | Amplitude logger 2 samples between 50 and 60%. | 1 = 1% |
| 36.46 | <i>AL2 60 to 70%</i> | Percentage of samples recorded by amplitude logger 2 that fall between 60 and 70%. | 0.00% |
| | 0.00...100.00% | Amplitude logger 2 samples between 60 and 70%. | 1 = 1% |
| 36.47 | <i>AL2 70 to 80%</i> | Percentage of samples recorded by amplitude logger 2 that fall between 70 and 80%. | 0.00% |
| | 0.00...100.00% | Amplitude logger 2 samples between 70 and 80%. | 1 = 1% |
| 36.48 | <i>AL2 80 to 90%</i> | Percentage of samples recorded by amplitude logger 2 that fall between 80 and 90%. | 0.00% |
| | 0.00...100.00% | Amplitude logger 2 samples between 80 and 90%. | 1 = 1% |

| Serial number | Name/Value | Description | Def/FbEq16 | | | | | | | | | | | | | | | | | | |
|----------------------------------------------------------------------------------------------------------------------------------------------------------------------------------------------------------------------------------------------------------------------------------------------------------------------------------------------------------------------------------------------------------------------------------------------------------------------------------------------------------------------------------------------------------------------------------------------------------------------------------------------|---------------------------------|-----------------------------------------------------------------------------------------------------------------------------------------------------------------------------------------------------------------------------------------------------------------------------------|-----------------------|-----|------|-------------|---|------------------|--------------------------------------------|---|-------------------|------------------------------------------------------|---|----------------|--------------------------------------------|---|--------------------|------------------------------------------------------------------------------|--------|----------|--|
| 36.49 | <i>AL2 over 90%</i> | Percentage of samples recorded by amplitude logger 2 that exceed 90%. | 0.00% | | | | | | | | | | | | | | | | | | |
| | 0.00...100.00% | Amplitude logger 2 samples over 90%. | 1 = 1% | | | | | | | | | | | | | | | | | | |
| 36.50 | <i>AL2 reset date</i> | The date on which amplitude logger 2 was last reset. | 01.01.1980 | | | | | | | | | | | | | | | | | | |
| | - | Last reset date of amplitude logger 2. | - | | | | | | | | | | | | | | | | | | |
| 36.51 | <i>AL2 reset time</i> | The time at which amplitude logger 2 was last reset. | 00:00:00 | | | | | | | | | | | | | | | | | | |
| | - | Last reset time of amplitude logger 2. | - | | | | | | | | | | | | | | | | | | |
| 37 User load curve | | Settings for user load curve. See also section <i>User load curve</i> (page 84). | | | | | | | | | | | | | | | | | | | |
| 37.01 | <i>ULC output status word</i> | Displays the status of the monitored signal. The status is shown only while the drive is running. (The status word is independent of the actions and delays selected by parameters <i>37.03</i> , <i>37.04</i> , <i>37.41</i> and <i>37.42</i> .) This parameter is read-only. | 0000h | | | | | | | | | | | | | | | | | | |
| <table border="1"> <thead> <tr> <th>Bit</th> <th>Name</th> <th>Description</th> </tr> </thead> <tbody> <tr> <td>0</td> <td>Under load limit</td> <td>1 = Signal lower than the underload curve.</td> </tr> <tr> <td>1</td> <td>Within load range</td> <td>1 = Signal between the underload and overload curve.</td> </tr> <tr> <td>2</td> <td>Overload limit</td> <td>1 = Signal higher than the overload curve.</td> </tr> <tr> <td>3</td> <td>Outside load limit</td> <td>1 = Signal lower than the underload curve or higher than the overload curve.</td> </tr> <tr> <td>4...15</td> <td>Reserved</td> <td></td> </tr> </tbody> </table> | | | | Bit | Name | Description | 0 | Under load limit | 1 = Signal lower than the underload curve. | 1 | Within load range | 1 = Signal between the underload and overload curve. | 2 | Overload limit | 1 = Signal higher than the overload curve. | 3 | Outside load limit | 1 = Signal lower than the underload curve or higher than the overload curve. | 4...15 | Reserved | |
| Bit | Name | Description | | | | | | | | | | | | | | | | | | | |
| 0 | Under load limit | 1 = Signal lower than the underload curve. | | | | | | | | | | | | | | | | | | | |
| 1 | Within load range | 1 = Signal between the underload and overload curve. | | | | | | | | | | | | | | | | | | | |
| 2 | Overload limit | 1 = Signal higher than the overload curve. | | | | | | | | | | | | | | | | | | | |
| 3 | Outside load limit | 1 = Signal lower than the underload curve or higher than the overload curve. | | | | | | | | | | | | | | | | | | | |
| 4...15 | Reserved | | | | | | | | | | | | | | | | | | | | |
| | 0000h...FFFFh | Status of the monitored signal. | 1 = 1 | | | | | | | | | | | | | | | | | | |
| 37.02 | <i>ULC supervision signal</i> | Selects the signal to be monitored. The function compares the absolute value of the signal against the load curve. | <i>Motor torque %</i> | | | | | | | | | | | | | | | | | | |
| | Not selected | No signal selected (monitoring disabled). | 0 | | | | | | | | | | | | | | | | | | |
| | Motor speed % | <i>01.03 Motor speed (%)</i> (page 133). | 1 | | | | | | | | | | | | | | | | | | |
| | Motor current % | <i>01.08 Motor nominal current (%)</i> (page 133). | 2 | | | | | | | | | | | | | | | | | | |
| | Motor torque % | <i>01.10 Motor torque (%)</i> (page 133). | 3 | | | | | | | | | | | | | | | | | | |
| | Output power % of motor nominal | <i>01.15 Nominal output power (%) of motor</i> (page 134). | 4 | | | | | | | | | | | | | | | | | | |
| | <i>Other</i> | Source selection (see <i>Terms and abbreviations</i> on page 130). | - | | | | | | | | | | | | | | | | | | |
| 37.03 | <i>ULC overload actions</i> | Selects how the drive reacts if the absolute value of the monitored signal stays continuously above the overload curve for longer than the value of <i>37.41 ULC overload timer</i> . | <i>Disabled</i> | | | | | | | | | | | | | | | | | | |
| | Disabled | No action taken. | 0 | | | | | | | | | | | | | | | | | | |
| | Warning | The drive generates a warning (<i>A8BE ULC overload warning</i>). | 1 | | | | | | | | | | | | | | | | | | |
| | Fault | The drive trips on <i>8002 ULC overload fault</i> . | 2 | | | | | | | | | | | | | | | | | | |

| Serial number | Name/Value | Description | Def/FbEq16 |
|---------------|--------------------------------|------------------------------------------------------------------------------------------------------------------------------------------------------------------------------------------------------------------------------------------------------------------------------------------------------------------------------------------------------------------------------------------------|-----------------|
| | Warning/Fault | The drive generates a warning (<i>A8BE ULC overload warning</i>) if the signal stays continuously above the overload curve for half of the time defined by parameter <i>37.41 ULC overload timer</i> . The drive trips on <i>8002 ULC overload fault</i> if the signal stays continuously above the overload curve for a time defined by parameter <i>37.41 ULC overload timer</i> . | 3 |
| <i>37.04</i> | <i>ULC underload actions</i> | Selects how the drive reacts if the absolute value of the monitored signal stays continuously below the overload curve for longer than the value of <i>37.42 ULC underload timer</i> . | <i>Disabled</i> |
| | Disabled | No action taken. | 0 |
| | Warning | The drive generates a warning (<i>A8BF ULC underload warning</i>). | 1 |
| | Fault | The drive trips on <i>8001 ULC underload fault</i> . | 2 |
| | Warning/Fault | The drive generates a warning (<i>A8BF ULC underload warning</i>) if the signal stays continuously below the underload curve for half of the time defined by parameter <i>37.41 ULC overload timer</i> . The drive trips on <i>8001 ULC underload fault</i> if the signal stays continuously below the underload curve for a time defined by parameter <i>37.42 ULC underload timer</i> . | 3 |
| <i>37.11</i> | <i>ULC speed table point 1</i> | Defines the first of the five speed points on the X-axis of the user load curve. The five points must be in order from lowest to highest. The points are defined as positive values, but the range is symmetrically effective also in the negative direction. The monitoring is not active outside these two areas. | 150.0 rpm |
| | -30000.0...30000.0 rpm | Speed. | 1 = 1 rpm |
| <i>37.12</i> | <i>ULC speed table point 2</i> | Defines the second speed point. See parameter <i>37.11 ULC speed table point 1</i> . | 750.0 rpm |
| | -30000.0...30000.0 rpm | Speed. | 1 = 1 rpm |
| <i>37.13</i> | <i>ULC speed table point 3</i> | Defines the third speed point. See parameter <i>37.11 ULC speed table point 1</i> . | 1290.0 rpm |
| | -30000.0...30000.0 rpm | Speed. | 1 = 1 rpm |
| <i>37.14</i> | <i>ULC speed table point 4</i> | Defines the fourth speed point. See parameter <i>37.11 ULC speed table point 1</i> . | 1500.0 rpm |
| | -30000.0...30000.0 rpm | Speed. | 1 = 1 rpm |
| <i>37.15</i> | <i>ULC speed table point 5</i> | Defines the fifth speed point. See parameter <i>37.11 ULC speed table point 1</i> . | 1800.0 rpm |
| | -30000.0...30000.0 rpm | Speed. | 1 = 1 rpm |

| Serial number | Name/Value | Description | Def/FbEq16 |
|---------------|------------------------------------|------------------------------------------------------------------------------------------------------------------------------------------------------------------------------------------------------------------------------------------------------------------------------------------------------------------------------------------------------------------------------------------------------------------------------------------------------------|------------|
| 37.16 | <i>ULC frequency table point 1</i> | Defines the first of the five frequency points on the X-axis of the user load curve. Frequency points are used if parameter <i>99.04 Motor control mode</i> is set to <i>Scalar</i> and the reference unit is Hz. The five points must be in order from lowest to highest. The points are defined as positive values, but the range is symmetrically effective also in the negative direction. The monitoring is not active outside these two areas. | 5.0 Hz |
| | -500.0...500.0 Hz | Frequency. | 1 = 1 Hz |
| 37.17 | <i>ULC frequency table point 2</i> | Defines the second frequency point. See parameter <i>37.16 ULC frequency table point 1</i> . | 25.0 Hz |
| | -500.0...500.0 Hz | Frequency. | 1 = 1 Hz |
| 37.18 | <i>ULC frequency table point 3</i> | Defines the third frequency point. See parameter <i>37.16 ULC frequency table point 1</i> . | 43.0 Hz |
| | -500.0...500.0 Hz | Frequency. | 1 = 1 Hz |
| 37.19 | <i>ULC frequency table point 4</i> | Defines the fourth frequency point. See parameter <i>37.16 ULC frequency table point 1</i> . | 50.0 Hz |
| | -500.0...500.0 Hz | Frequency. | 1 = 1 Hz |
| 37.20 | <i>ULC frequency table point 5</i> | Defines the fifth frequency point. See parameter <i>37.16 ULC frequency table point 1</i> . | 60.0 Hz |
| | -500.0...500.0 Hz | Frequency. | 1 = 1 Hz |
| 37.21 | <i>ULC underload point 1</i> | Defines the first of the five points on the Y-axis that together with the corresponding point on the X-axis (<i>37.11 ULC speed table point 1...37.15 ULC speed table point 5</i> or <i>37.15 ULC speed table point 5...37.20 ULC frequency table point 5</i>) define the underload (lower) curve. Each point of the underload curve must have a lower value than the corresponding overload point. | 10.0% |
| | -1600.0...1600.0% | Underload point. | 1 = 1% |
| 37.22 | <i>ULC frequency table point 5</i> | Defines the second underload point. See parameter <i>37.21 ULC underload point 1</i> . | 15.0% |
| | -1600.0...1600.0% | Underload point. | 1 = 1% |
| 37.23 | <i>ULC underload point 3</i> | Defines the third underload point. See parameter <i>37.21 ULC underload point 1</i> | 25.0% |
| | -1600.0...1600.0% | Underload point. | 1 = 1% |
| 37.24 | <i>ULC underload point 4</i> | Defines the fourth underload point. See parameter <i>37.21 ULC underload point 1</i> | 30.0% |
| | -1600.0...1600.0% | Underload point. | 1 = 1% |
| 37.25 | <i>ULC underload point 5</i> | Defines the fifth underload point. See parameter <i>37.21 ULC underload point 1</i> | 30.0% |
| | -1600.0...1600.0% | Underload point. | 1 = 1% |

| Serial number | Name/Value | Description | Def/FbEq16 |
|-----------------------------|-----------------------------|----------------------------------------------------------------------------------------------------------------------------------------------------------------------------------------------------------------------------------------------------------------------------------------------------------------------------------------------------------------------------------------------------------------------------------------------------------------------------------------------------------------------------------------------------------------------------------------------|------------|
| 37.31 | <i>ULC overload point 1</i> | Defines the first of the five points on the Y-axis that together with the corresponding point on the X-axis (<i>37.11 ULC speed table point 1...37.15 ULC speed table point 5</i> or <i>37.15 ULC speed table point 5...37.20 ULC frequency table point 5</i>) define the overload (higher) curve. Each point of the overload curve must have a higher value than the corresponding underload point. | 300.0% |
| | -1600.0...1600.0% | Overload point. | 1 = 1% |
| 37.32 | <i>ULC overload point 2</i> | Defines the second overload point. See parameter <i>37.31 ULC overload point 1</i> . | 300.0% |
| | -1600.0...1600.0% | Overload point. | 1 = 1% |
| 37.33 | <i>ULC overload point 3</i> | Defines the third overload point. See parameter <i>37.31 ULC overload point 1</i> . | 300.0% |
| | -1600.0...1600.0% | Overload point. | 1 = 1% |
| 37.34 | <i>ULC overload point 4</i> | Defines the fourth overload point. See parameter <i>37.31 ULC overload point 1</i> . | 300.0% |
| | -1600.0...1600.0% | Overload point. | 1 = 1% |
| 37.35 | <i>ULC overload point 5</i> | Defines the fifth overload point. See parameter <i>37.31 ULC overload point 1</i> . | 300.0% |
| | -1600.0...1600.0% | Overload point. | 1 = 1% |
| 37.41 | <i>ULC overload timer</i> | Defines the time for which the monitored signal must continuously stay above the overload curve before the drive takes the action selected by <i>37.03 ULC overload actions</i> . | 20.0 s |
| | 0.0...10000.0 s | Overload timer. | 1 = 1 s |
| 37.42 | <i>ULC underload timer</i> | Defines the time for which the monitored signal must continuously stay below the underload curve before the drive takes the action selected by <i>37.04 ULC underload actions</i> . | 20.0 s |
| | 0.0...10000.0 s | Underload timer. | 1 = 1 s |
| 40 Process PID set 1 | | Parameter values for process PID control. The drive output can be controlled by the process PID. When the process PID control is enabled, the drive controls the process feedback to the reference value. Two different parameter sets can be defined for the process PID. One parameter set is in use at a time. The first set is made up of parameters <i>40.07...40.50</i> , the second set is defined by the parameters in group <i>41 Process PID set 2</i> . The binary source that defines which set is used is selected by parameter <i>40.57 PID set1/set2 selection</i> . | |
| 40.01 | <i>PID output value</i> | Displays the output of the process PID controller. See the control chain diagram on page <i>349</i> . This parameter is read-only. | - |
| | -32768.00...32767.00 | Process PID controller output. | 1 = 1 unit |

| Serial number | Name/Value | Description | Def/FbEq16 | | | | | | | | | | | | | | | | | | | | | | | | | | | | | | | | | | | | | | | | | | | | | |
|---------------|--------------------------------------------------------------------------------------------------------------------------------------------------------------------------------------------------------------------------------------------------------------------------------------------------------------------------------------------------------------------------------------------------------------------------------------------------------------------------------------------------------------------------------------------------------------------------------------------------------------------------------------------------------------------------------------------------------------------------------------------------------------------------------------------------------------------------------------------------------------------------------------------------------------------------------------------------------------------------------------------------------------------------------------------------------------------------------------------------------------------------------------------------------------------------------------------------------------------------------------------------------------------------------------------------------------------------------------------------------------|-------------------------------------------------------------------------------------------------------------------------------------------------------------------------------------------------------------------------------------------------------------------------------------------------|------------|--------|------|-------|---|------------|---------------------------------|---|-----------------|----------------------------------|---|---------------|-------------------------------------------|---|----------------|------------------------|---|-------------|-------------------------|---|---------|--|---|---------------|-------------------------------|---|-------------------|-----------------------------------------------------------------|---|------------------|-----------------------------------------------------------------|---|---------|--|----|---------|---------------------------------------------------------|----|---------|--|----|--------------------------|------------------------------------------------------------------------|---------|---------|--|
| 40.02 | <i>PID feedback value</i> | Displays the value of process feedback after source selection, mathematical function (parameter 40.10 Reference group 1 feedback function) and filtering. See the control chain diagram on page 376 . This parameter is read-only. | - | | | | | | | | | | | | | | | | | | | | | | | | | | | | | | | | | | | | | | | | | | | | | |
| | -32768.00... 32767.00 | Process feedback. | 1 = 1 unit | | | | | | | | | | | | | | | | | | | | | | | | | | | | | | | | | | | | | | | | | | | | | |
| 40.03 | <i>PID setpoint</i> | Displays the value of process PID setpoint after source selection, mathematical function 40.18 Reference group 1 set value function), limitation and ramping. See the control chain diagram on page 306 . This parameter is read-only. | - | | | | | | | | | | | | | | | | | | | | | | | | | | | | | | | | | | | | | | | | | | | | | |
| | -32768.00... 32767.00 | Setpoint for process PID controller. | 1 = 1 unit | | | | | | | | | | | | | | | | | | | | | | | | | | | | | | | | | | | | | | | | | | | | | |
| 40.04 | <i>PID deviation value</i> | Displays the process PID deviation. By default, this value equals setpoint - feedback, but deviation can be inverted by parameter 40.31 Reference group 1 negated deviation value . See the control chain diagram on page 307 . This parameter is read-only. | - | | | | | | | | | | | | | | | | | | | | | | | | | | | | | | | | | | | | | | | | | | | | | |
| | -32768.00... 32767.00 | Process PID trimmed reference. | 1 = 1 | | | | | | | | | | | | | | | | | | | | | | | | | | | | | | | | | | | | | | | | | | | | | |
| 40.05 | <i>Process PID trim output act</i> | Displays the process PID trimmed reference output. See control chain diagram on page 377 . This parameter is read-only. | | | | | | | | | | | | | | | | | | | | | | | | | | | | | | | | | | | | | | | | | | | | | | |
| | -32768.0...32767.0 | | | | | | | | | | | | | | | | | | | | | | | | | | | | | | | | | | | | | | | | | | | | | | | |
| 40.06 | <i>PID status word</i> | Displays status information on process PID control. This parameter is read-only. | - | | | | | | | | | | | | | | | | | | | | | | | | | | | | | | | | | | | | | | | | | | | | | |
| | <table border="1"> <thead> <tr> <th>Bit(s)</th> <th>Name</th> <th>Value</th> </tr> </thead> <tbody> <tr> <td>0</td> <td>PID active</td> <td>1 = Process PID control active.</td> </tr> <tr> <td>1</td> <td>Setpoint frozen</td> <td>1 = Process PID setpoint frozen.</td> </tr> <tr> <td>2</td> <td>Output frozen</td> <td>1 = Process PID controller output frozen.</td> </tr> <tr> <td>3</td> <td>PID sleep mode</td> <td>1 = Sleep mode active.</td> </tr> <tr> <td>4</td> <td>Sleep boost</td> <td>1 = Sleep boost active.</td> </tr> <tr> <td>5</td> <td>Reserve</td> <td></td> </tr> <tr> <td>6</td> <td>Tracking mode</td> <td>1 = Tracking function active.</td> </tr> <tr> <td>7</td> <td>Output limit high</td> <td>1 = PID output is being limited by par. 40.37.</td> </tr> <tr> <td>8</td> <td>Output limit low</td> <td>1 = PID output is being limited by par. 40.36.</td> </tr> <tr> <td>9</td> <td>Reserve</td> <td></td> </tr> <tr> <td>10</td> <td>PID set</td> <td>0 = Parameter set 1 in use. 1 = Parameter set 2 in use.</td> </tr> <tr> <td>11</td> <td>Reserve</td> <td></td> </tr> <tr> <td>12</td> <td>Internal setpoint active</td> <td>1 = Internal setpoint active (See par. 40.16...40.16)</td> </tr> <tr> <td>13...15</td> <td>Reserve</td> <td></td> </tr> </tbody> </table> | | | Bit(s) | Name | Value | 0 | PID active | 1 = Process PID control active. | 1 | Setpoint frozen | 1 = Process PID setpoint frozen. | 2 | Output frozen | 1 = Process PID controller output frozen. | 3 | PID sleep mode | 1 = Sleep mode active. | 4 | Sleep boost | 1 = Sleep boost active. | 5 | Reserve | | 6 | Tracking mode | 1 = Tracking function active. | 7 | Output limit high | 1 = PID output is being limited by par. 40.37 . | 8 | Output limit low | 1 = PID output is being limited by par. 40.36 . | 9 | Reserve | | 10 | PID set | 0 = Parameter set 1 in use. 1 = Parameter set 2 in use. | 11 | Reserve | | 12 | Internal setpoint active | 1 = Internal setpoint active (See par. 40.16...40.16) | 13...15 | Reserve | |
| Bit(s) | Name | Value | | | | | | | | | | | | | | | | | | | | | | | | | | | | | | | | | | | | | | | | | | | | | | |
| 0 | PID active | 1 = Process PID control active. | | | | | | | | | | | | | | | | | | | | | | | | | | | | | | | | | | | | | | | | | | | | | | |
| 1 | Setpoint frozen | 1 = Process PID setpoint frozen. | | | | | | | | | | | | | | | | | | | | | | | | | | | | | | | | | | | | | | | | | | | | | | |
| 2 | Output frozen | 1 = Process PID controller output frozen. | | | | | | | | | | | | | | | | | | | | | | | | | | | | | | | | | | | | | | | | | | | | | | |
| 3 | PID sleep mode | 1 = Sleep mode active. | | | | | | | | | | | | | | | | | | | | | | | | | | | | | | | | | | | | | | | | | | | | | | |
| 4 | Sleep boost | 1 = Sleep boost active. | | | | | | | | | | | | | | | | | | | | | | | | | | | | | | | | | | | | | | | | | | | | | | |
| 5 | Reserve | | | | | | | | | | | | | | | | | | | | | | | | | | | | | | | | | | | | | | | | | | | | | | | |
| 6 | Tracking mode | 1 = Tracking function active. | | | | | | | | | | | | | | | | | | | | | | | | | | | | | | | | | | | | | | | | | | | | | | |
| 7 | Output limit high | 1 = PID output is being limited by par. 40.37 . | | | | | | | | | | | | | | | | | | | | | | | | | | | | | | | | | | | | | | | | | | | | | | |
| 8 | Output limit low | 1 = PID output is being limited by par. 40.36 . | | | | | | | | | | | | | | | | | | | | | | | | | | | | | | | | | | | | | | | | | | | | | | |
| 9 | Reserve | | | | | | | | | | | | | | | | | | | | | | | | | | | | | | | | | | | | | | | | | | | | | | | |
| 10 | PID set | 0 = Parameter set 1 in use. 1 = Parameter set 2 in use. | | | | | | | | | | | | | | | | | | | | | | | | | | | | | | | | | | | | | | | | | | | | | | |
| 11 | Reserve | | | | | | | | | | | | | | | | | | | | | | | | | | | | | | | | | | | | | | | | | | | | | | | |
| 12 | Internal setpoint active | 1 = Internal setpoint active (See par. 40.16...40.16) | | | | | | | | | | | | | | | | | | | | | | | | | | | | | | | | | | | | | | | | | | | | | | |
| 13...15 | Reserve | | | | | | | | | | | | | | | | | | | | | | | | | | | | | | | | | | | | | | | | | | | | | | | |
| | 0000h...FFFFh | Process PID control status word. | 1 = 1 | | | | | | | | | | | | | | | | | | | | | | | | | | | | | | | | | | | | | | | | | | | | | |

| Serial number | Name/Value | Description | Def/FbEq16 |
|---------------|---------------------------------------------------|-----------------------------------------------------------------------------------------------------------------------------------------------------------------------------------------------------------------------------------------|---------------------|
| 40.07 | <i>Process PID operation mode</i> | Activates/deactivates process PID control. Note: Process PID control is only available in external control; See section <i>Local control vs. external control</i> (page 63). | Off |
| | Off | Process PID control is not effective. | 0 |
| | Open | Process PID control active. | 1 |
| | When the drive is running | Process PID control is active when the drive is running. | 2 |
| 40.08 | <i>Reference group 1 feedback 1 signal source</i> | Selects the first source of process feedback. See the control chain diagram on page 373. | AI1 percent |
| | Not selected | n/a | 0 |
| | AI1 scaled value | 12.12 AI1 scaled value (See page 152). | 1 |
| | AI2 scaled value | 12.22 AI2 scaled value (See page 154). | 2 |
| | Freq in scaled | 11.39 Freq in 1 scaled value (See page 150). | 3 |
| | AI1 percent | 12.101 AI1 percent | 8 |
| | AI2 percent | 12.102 AI2 percent | 9 |
| | Feedback data storage | 40.91 Feedback data storage (See page 116), | 10 |
| | <i>Other</i> | Source selection (See 130 on page Terms and abbreviations). | - |
| 40.09 | <i>Reference group 1 feedback 2 signal source</i> | Selects the second source of process feedback. The second source is used only if the setpoint function requires two inputs. For selections, see parameter 40.08 Reference group 1 feedback 1 signal source . | <i>Not selected</i> |
| 40.10 | <i>Reference group 1 feedback function</i> | Defines how process feedback is calculated from the two feedback sources selected by parameters 40.08 Reference group 1 feedback 1 signal source and 40.09 Reference group 1 feedback 2 signal source . | in1 |
| | in1 | Source 1. | 0 |
| | in1+in2 | Sum of sources 1 and 2. | 1 |
| | in1-in2 | Source 2 subtracted from source 1. | 2 |
| | in1*in2 | Source 1 multiplied by source 2. | 3 |
| | in1/in2 | Source 1 divided by source 2. | 4 |
| | Min(in1,in2) | Smaller of the two sources. | 5 |
| | MAX(in1,in2) | Greater of the two sources. | 6 |
| | AVE(in1,in2) | Average of the two sources. | 7 |
| | sqrt(in1) | Square root of source 1. | 8 |
| | sqrt(in1-in2) | Square root of (source 1 - source 2). | 9 |
| | sqrt(in1+in2) | Square root of (source 1 + source 2). | 10 |
| | sqrt(in1)+sqrt(in2) | Square root of source 1 + square root of source 2. | 11 |
| 40.11 | <i>Reference group 1 feedback filter time</i> | Defines the filter time constant for process feedback. | 0.000 s |
| | 0.000...30.000 s | Feedback filter time. | 1 = 1s |

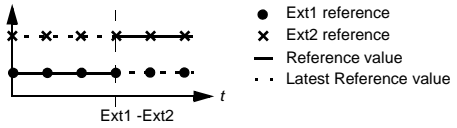
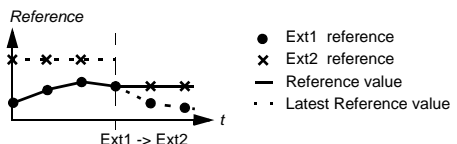
| Serial number | Name/Value | Description | Def/FbEq16 |
|---------------|----------------------------------------------------|-------------------------------------------------------------------------------------------------------------------------------------------------------------------------------------------------------------------------------------------------------------------------------------------------------------------------------------------------------------------------------------------------------------------------------------|---------------------|
| 40.16 | <i>Reference group 1 set value 1 signal source</i> | Selects the primary source of process PID setpoint. See the control chain diagram on page 376. | All1 percent |
| | Not selected | None. | 0 |
| | Internal setpoint | Internal setpoint. See parameter 40.19 <i>Reference group 1 internal setpoint selection 1</i> . | 2 |
| | AI1 scaled value | <i>12.12 AI1 scaled value</i> (See page 152). | 3 |
| | AI2 scaled value | <i>12.22 AI2 scaled value</i> (See page 154). | 4 |
| | Motor potentiometer | <i>22.80 Motor potentiometer ref act</i> (output of the motor potentiometer). | 8 |
| | Freq in scaled | <i>11.39 Freq in 1 scaled value</i> (See page 150). | 10 |
| | AI1 percent | <i>12.101 AI1 percent</i> | 11 |
| | AI2 percent | <i>12.102 AI2 percent</i> | 12 |
| | Control panel (ref saved) | The control panel reference saved through control system; the returned control word is used as the reference. <i>Reference</i>  | 13 |
| | Control panel (ref copied) | When the control locations change, if the same control types (e.g., frequency / speed / torque /PID), are selected by two locations, the former used control location is served as the reference, otherwise, the actual signal shall be served as a new reference. ((See 136 on page 03.01 <i>Panel reference</i>) . <i>Reference</i>  | 14 |
| | FBA ref1 | <i>03.05 FB A reference 1</i> . | 15 |
| | FBA ref2 | <i>03.06 FB A reference 2</i> . | 16 |
| | EFB reference 1 | <i>03.09 EFB reference 1</i> . | 19 |
| | EFB reference 2 | <i>03.10 EFB reference 2</i> . | 20 |
| | Setpoint data storage | <i>40.92 Setpoint data storage</i> . | 24 |
| | <i>Other</i> | Source selection (See <i>130 on page Terms and abbreviations</i>). | - |
| 40.17 | <i>Reference group 1 set value 2 signal source</i> | Selects the second source of process setpoint. The second source is used only if the setpoint function requires two inputs. For selections, see parameter 40.16 <i>Reference group 1 set value 1 signal source</i> . | <i>Not selected</i> |

| Serial number | Name/Value | Description | Def/FbEq16 | | | | | | | | | | | | | | | |
|------------------------------------------|--------------------------------------------------------|------------------------------------------------------------------------------------------------------------------------------------------------------------------------------------------------------------------------------------------------------------------------------------------------------------------------------------------------------------------------------------------------------------------------------------------------------------------------|------------------------------------------|------------------------------------------|------------------------|---|---|-----------------|---|---|------------------------|---|---|------------------------|---|---|------------------------|--|
| 40.18 | <i>Reference group 1 set value function</i> | Selects a function between the setpoint sources selected by parameters <i>40.16 Reference group 1 set value 1 signal source</i> and <i>40.17 Reference group 1 set value 2 signal source</i> . | in1 | | | | | | | | | | | | | | | |
| | in1 | Source 1. | 0 | | | | | | | | | | | | | | | |
| | in1+in2 | Sum of sources 1 and 2. | 1 | | | | | | | | | | | | | | | |
| | in1-in2 | Source 2 subtracted from source 1. | 2 | | | | | | | | | | | | | | | |
| | in1*in2 | Source 1 multiplied by source 2. | 3 | | | | | | | | | | | | | | | |
| | in1/in2 | Source 1 divided by source 2. | 4 | | | | | | | | | | | | | | | |
| | Min(in1,in2) | Smaller of the two sources. | 5 | | | | | | | | | | | | | | | |
| | MAX(in1,in2) | Greater of the two sources. | 6 | | | | | | | | | | | | | | | |
| | AVE(in1,in2) | Average of the two sources. | 7 | | | | | | | | | | | | | | | |
| | sqrt(in1) | Square root of source 1. | 8 | | | | | | | | | | | | | | | |
| | sqrt(in1-in2) | Square root of (source 1 - source 2). | 9 | | | | | | | | | | | | | | | |
| | sqrt(in1+in2) | Square root of (source 1 + source 2). | 10 | | | | | | | | | | | | | | | |
| | sqrt(in1)+sqrt(in2) | Square root of source 1 + square root of source 2. | 11 | | | | | | | | | | | | | | | |
| 40.19 | <i>Reference group 1 internal setpoint selection 1</i> | Selects, together with <i>40.20 Reference group 1 internal setpoint selection 2</i> , the internal setpoint out of the presets defined by parameters <i>40.21...40.23</i> . Note: Parameter <i>40.16 Reference group 1 set value 1 signal source</i> and <i>40.17 Reference group 1 set value 2 signal source</i> must be set as <i>Internal setpoint</i> . | <i>Not selected</i> | | | | | | | | | | | | | | | |
| | | <table border="1"> <thead> <tr> <th>Source defined by parameter <i>40.19</i></th> <th>Source defined by parameter <i>40.20</i></th> <th>Setpoint preset active</th> </tr> </thead> <tbody> <tr> <td>0</td> <td>0</td> <td>Setpoint source</td> </tr> <tr> <td>1</td> <td>0</td> <td>1 (par. <i>40.21</i>)</td> </tr> <tr> <td>0</td> <td>1</td> <td>2 (par. <i>40.22</i>)</td> </tr> <tr> <td>1</td> <td>1</td> <td>3 (par. <i>40.23</i>)</td> </tr> </tbody> </table> | Source defined by parameter <i>40.19</i> | Source defined by parameter <i>40.20</i> | Setpoint preset active | 0 | 0 | Setpoint source | 1 | 0 | 1 (par. <i>40.21</i>) | 0 | 1 | 2 (par. <i>40.22</i>) | 1 | 1 | 3 (par. <i>40.23</i>) | |
| Source defined by parameter <i>40.19</i> | Source defined by parameter <i>40.20</i> | Setpoint preset active | | | | | | | | | | | | | | | | |
| 0 | 0 | Setpoint source | | | | | | | | | | | | | | | | |
| 1 | 0 | 1 (par. <i>40.21</i>) | | | | | | | | | | | | | | | | |
| 0 | 1 | 2 (par. <i>40.22</i>) | | | | | | | | | | | | | | | | |
| 1 | 1 | 3 (par. <i>40.23</i>) | | | | | | | | | | | | | | | | |
| | Not selected | 0 | 0 | | | | | | | | | | | | | | | |
| | Select | 1 | 1 | | | | | | | | | | | | | | | |
| | Timed function 1 | <i>34.01</i> Bit 0 of <i>Combined timer status</i> (See page 218). | 18 | | | | | | | | | | | | | | | |
| | Timed function 2 | <i>34.01</i> Bit 1 of <i>Combined timer status</i> (See page 218). | 19 | | | | | | | | | | | | | | | |
| | Timed function 3 | <i>34.01</i> Bit 2 of <i>Combined timer status</i> (See page 218). | 20 | | | | | | | | | | | | | | | |
| | Monitor 1 | <i>32.01</i> Bit 0 of <i>Supervision status word</i> (See page 211). | 21 | | | | | | | | | | | | | | | |
| | Monitor 2 | <i>32.01</i> Bit 1 of <i>Supervision status word</i> (See page 211). | 22 | | | | | | | | | | | | | | | |
| | Monitor 3 | <i>32.01</i> Bit 2 of <i>Supervision status word</i> (See page 211). | 23 | | | | | | | | | | | | | | | |
| | <i>Other [bit]</i> | Source selection (See 130 on page <i>Terms and abbreviations</i>). | - | | | | | | | | | | | | | | | |

| Serial number | Name/Value | Description | Def/FbEq16 |
|---------------|-----------------------------------------------------------------|---------------------------------------------------------------------------------------------------------------------------------------------------------------------------------------------------------------------------------------------------------------------------------|-------------------------|
| 40.20 | Reference group 1 internal setpoint selection 2 | Select internal set values except three internal set values defined by the parameter 40.19 Reference group 1 internal setpoint selection 1 and 40.21...40.23 . See 40.19 Reference group 1 internal setpoint selection 1 table. | Not selected |
| | Not selected | 0 | 0 |
| | Select | 1 | 1 |
| | Timed function 1 | 34.01 Bit 0 of Combined timer status (See page 218). | 18 |
| | Timed function 2 | 34.01 Bit 1 of Combined timer status (See page 218). | 19 |
| | Timed function 3 | 34.01 Bit 2 of Combined timer status (See page 218). | 20 |
| | Monitor 1 | 32.01 Bit 0 of Supervision status word (See page 211). | 21 |
| | Monitor 2 | 32.01 Bit 1 of Supervision status word (See page 211). | 22 |
| | Monitor 3 | 32.01 Bit 2 of Supervision status word (See page 211). | 23 |
| | <i>Other [bit]</i> | Source selection (See 130 on page Terms and abbreviations). | - |
| 40.21 | Reference group 1 internal setpoint 1 | Internal process setpoint 1. See parameter 40.19 Reference group 1 internal setpoint selection 1 . | 0.00 |
| | -32768.00... 32767.00 | Internal process setpoint 1. | 1 = 1 unit |
| 40.22 | Reference group 1 internal setpoint 2 | Internal process setpoint 2. See parameter 40.19 Reference group 1 internal setpoint selection 1 . | 0.00 |
| | -32768.00... 32767.00 | Internal process setpoint 2. | 1 = 1 unit |
| 40.23 | Reference group 1 internal setpoint 3 | Internal process setpoint 3. See parameter 40.19 Reference group 1 internal setpoint selection 1 . | 0.00 |
| | -32768.00... 32767.00 | Internal process setpoint 3. | 1 = 1 unit |
| 40.24 | Set 1 internal setpoint 0 | Internal process setpoint 0. See parameter 40.19 Set 1 internal setpoint sel1 . | 0.00 PID customer units |
| | -200000.00... 200000.00 PID customer units | Internal process setpoint 0. | 1 = 1 PID customer unit |
| 40.26 | Reference group 1 the minimum set value | Defines a minimum limit for the process PID controller setpoint. | 0.00 |
| | -32768.00... 32767.00 | Minimum limit for process PID controller setpoint. | 1 = 1 |
| 40.27 | Reference group 1 the maximum set value | Defines a maximum limit for the process PID controller setpoint. | 32767.00 |
| | -32768.00... 32767.00 | Maximum limit for process PID controller setpoint. | 1 = 1 |
| 40.28 | Reference group 1 set value increase time | Defines the minimum time it takes for the setpoint to increase from 0% to 100%. | 0.0 s |
| | 0.0...1800.0 s | Setpoint increase time. | 1 = 1 |

| Serial number | Name/Value | Description | Def/FbEq16 |
|---------------|-----------------------------------------------------|--------------------------------------------------------------------------------------------------------------------------------------------------------------------------------------------------------------------------------------------------------------------------------------------------------------------------------------------------------------------------------------------------------|---------------------------------|
| 40.29 | <i>Reference group 1 setpoint decrease time</i> | Defines the minimum time it takes for the setpoint to decrease from 100% to 0%. | 0.0 s |
| | 0.0...1800.0 s | Setpoint decrease time. | 1 = 1 |
| 40.30 | <i>Reference group 1 set value keeping function</i> | Freezes, or defines a source that can be used to freeze, the setpoint of the process PID controller. This feature is useful when the reference is based on a process feedback connected to an analog input, and the sensor must be serviced without stopping the process. 1 = Process PID controller setpoint frozen See also parameter <i>40.38 Reference group 1 output keeping function</i> . | Not selected |
| | Not selected | Process PID controller setpoint not frozen. | 0 |
| | Select | Process PID controller setpoint frozen. | 1 |
| | Timed function 1 | <i>34.01</i> Bit 0 of <i>Combined timer status</i> (See page 218). | 18 |
| | Timed function 2 | <i>34.01</i> Bit 1 of <i>Combined timer status</i> (See page 218). | 19 |
| | Timed function 3 | <i>34.01</i> Bit 2 of <i>Combined timer status</i> (See page 218). | 20 |
| | Monitor 1 | <i>32.01</i> Bit 0 of <i>Supervision status word</i> (See page 211). | 21 |
| | Monitor 2 | <i>32.01</i> Bit 1 of <i>Supervision status word</i> (See page 211). | 22 |
| | Monitor 3 | <i>32.01</i> Bit 2 of <i>Supervision status word</i> (See page 211). | 23 |
| | <i>Other [bit]</i> | Source selection (See <i>130 on page Terms and abbreviations</i>). | - |
| 40.31 | <i>Reference group 1 negated deviation value</i> | Inverts the input of the process PID controller. 0 = Deviation not inverted (Deviation = Setpoint - Feedback) 1 = Deviation inverted (Deviation = Feedback - Setpoint) See also section <i>Sleep and boost functions for process PID control</i> . (page 75). | <i>Not inverted (Ref - Fbk)</i> |
| | Not inverted (Ref - Fbk) | 0 | 0 |
| | Inverted (Fbk - Ref) | 1 | 1 |
| | <i>Other [bit]</i> | Source selection (See <i>130 on page Terms and abbreviations</i>). | - |
| 40.32 | <i>Reference group 1 gain</i> | Defines the gain for the process PID controller. See parameter <i>40.33 Reference group 1 integration time</i> . | 1.00 |
| | 0.10...100.00 | Gain for PID controller. | 100 = 1 |

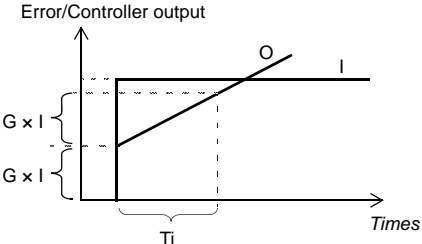
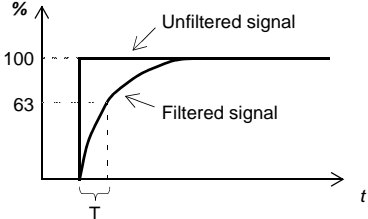
| Serial number | Name/Value | Description | Def/FbEq16 |
|---------------|-------------------------------------------------|----------------------------------------------------------------------------------------------------------------------------------------------------------------------------------------------------------------------------------------------------------------------------------------------------------------------------------------------------------------------------------------------------------------------------------------------------------------------------------------------------------------------------------|------------|
| 40.33 | <i>Reference group 1 integration time</i> | <p>Defines the integration time for the process PID controller. This time needs to be set to the same order of magnitude as the reaction time of the process being controlled, otherwise instability will result.</p>  <p>I = controller input (error) O = controller output G = gain Ti = integration time</p> <p>Note: Setting this value to 0 disables the "I" part, turning the PID controller into a PD controller.</p> | 60.0 s |
| | 0.0...9999.0 s | Integration time. | 1 = 1s |
| 40.34 | <i>Reference group 1 derivation time</i> | <p>Defines the derivation time of the process PID controller. The derivative component at the controller output is calculated on basis of two consecutive error values (E_{K-1} and E_K) according to the following formula: $PID\ DERIV\ TIME \times (E_K - E_{K-1}) / T_S$, in which $T_S = 2\ ms$ sample time $E = Error = Process\ reference - process\ feedback$.</p> | 0.000 s |
| | 0.000...10.000 s | Derivation time. | 1000 = 1s |
| 40.35 | <i>Reference group 1 derivation filter time</i> | <p>Defines the time constant of the 1-pole filter used to smooth the derivative component of the process PID controller.</p>  <p>$O = I \times (1 - e^{-t/T})$</p> <p>I = filter input (step) O = filter output t = time T = filter time constant</p> | 0.0 s |
| | 0.0...10.0 s | Filter time constant | 10 = 1s |

| Serial number | Name/Value | Description | Def/FbEq16 |
|---------------|---------------------------------------------------|------------------------------------------------------------------------------------------------------------------------------------------------------------------------------------------------------------------------------------------------------------------------------------------------------------------------------------------------------------------------------------------------------------------------------------------------|--------------|
| 40.36 | <i>Reference group 1 the minimum output value</i> | Defines the minimum limit for the process PID controller output. Using the minimum and maximum limits, it is possible to restrict the operation range. | 0 |
| | -32768.0... 32767.0 | Minimum limit for process PID controller output. | 1 = 1 |
| 40.37 | <i>Reference group 1 the maximum output value</i> | Defines the maximum limit for the process PID controller output. See parameter 40.36 Reference group 1 the minimum output value . | 100 |
| | -32768.0... 32767.0 | Maximum limit for process PID controller output. | 1 = 1 |
| 40.38 | <i>Reference group 1 output keeping function</i> | Freezes (or defines a source that can be used to freeze) the output of the process PID controller, keeping the output at the value it was before freeze was enabled. This function can be used when, for example, a sensor providing process feedback must to be serviced without stopping the process. 1 = Process PID controller output frozen See also parameter 40.30 Reference group 1 set value keeping function . | Not selected |
| | Not selected | Process PID controller output not frozen. | 0 |
| | Select | Process PID controller output frozen. | 1 |
| | Timed function 1 | 34.01 Bit 0 of <i>Combined timer status</i> (See page 218). | 18 |
| | Timed function 2 | 34.01 Bit 1 of <i>Combined timer status</i> (See page 218). | 19 |
| | Timed function 3 | 34.01 Bit 2 of <i>Combined timer status</i> (See page 218). | 20 |
| | Monitor 1 | 32.01 Bit 0 of <i>Supervision status word</i> (See page 211). | 21 |
| | Monitor 2 | 32.01 Bit 1 of <i>Supervision status word</i> (See page 211). | 22 |
| | Monitor 3 | 32.01 Bit 2 of <i>Supervision status word</i> (See page 211). | 23 |
| | <i>Other [bit]</i> | Source selection (See 130 on page Terms and abbreviations). | - |

| Serial number | Name/Value | Description | Def/FbEq16 |
|---------------|------------------------------------------------|---------------------------------------------------------------------------------------------------------------------------------------------------------------------------------------------------------------------------------------------------------------------------------------------------------------------------------------------------------------------------|-------------------------|
| 40.39 | <i>Set 1 deadband range</i> | Defines a deadband around the setpoint. Whenever process feedback enters the deadband, a delay timer starts. If the feedback remains within the deadband longer than the delay (40.40 <i>Set 1 deadband delay</i>), the PID controller output is frozen. Normal operation resumes after the feedback value leaves the deadband. | 0.00 PID customer unit |
| | | | |
| | 0.00.....200000.00 PID customer units | Deadband range. | 1 = 1 PID customer unit |
| 40.40 | <i>Set 1 deadband delay</i> | Delay for the deadband. See parameter 40.39 <i>Set 1 deadband range</i> . | 0.0 s |
| | 0.0 ... 3600.0 s | Delay for deadband area. | 1 = 1 s |
| 40.43 | <i>Reference group 1 sleep frequency</i> | Defines the start limit for the sleep function. If the value is 0.0, set 1 sleep mode is disabled. The sleep function compares the motor speed to the value of this parameter. If the motor speed remains below this value longer than the sleep delay defined by 40.44 <i>Reference group 1 sleeping delay</i> , the drive enters the sleep mode and stops the motor. | 0.0 |
| | 0.0...32767.0 | Sleep start level. | 1 = 1 |
| 40.44 | <i>Reference group 1 sleeping delay</i> | Defines a delay before the sleep function actually becomes enabled, to prevent nuisance sleeping. The delay timer starts when the sleep mode is enabled by parameter 40.43 <i>Reference group 1 sleep frequency</i> , and resets when the sleep mode is disabled. | 60.0 s |
| | 0.0...3600.0 s | Sleep start delay. | 1 = 1s |
| 40.45 | <i>Reference group 1 sleep boost time</i> | Defines a boost time for the sleep boost step. See parameter 40.46 <i>Reference group 1 sleeping raise period</i> . | 0.0 s |
| | 0.0...3600.0 s | Sleep boost time. | 1 = 1s |
| 40.46 | <i>Reference group 1 sleeping raise period</i> | When the drive is entering sleep mode, the process setpoint is increased by this percentage for the time defined by parameter 40.45 <i>Reference group 1 sleep boost time</i> . If active, sleep boost is aborted when the drive wakes up. | 0.0 |
| | 0.0...32767.0 | Sleep boost step. | 1 = 1 unit |

| Serial number | Name/Value | Description | Def/FbEq16 |
|---------------|-------------------------------------------------------|------------------------------------------------------------------------------------------------------------------------------------------------------------------------------------------------------------------------------------------------------------------------------------------------------------------------------------------------------|--------------|
| 40.47 | <i>Reference group 1 wake-up deviation</i> | Defines the wake-up level as deviation between process setpoint and feedback. When the deviation exceeds the value of this parameter, and remains there for the duration of the wake-up delay (40.48 <i>Reference group 1 wake-up delay</i>), the drive wakes up. See also parameter 40.31 <i>Reference group 1 negated deviation value</i> . | 0.00 |
| | -32768.00 ... 32767.00 rpm,% or Hz | Wake-up level (deviation between process setpoint and feedback). | 1 = 1% |
| 40.48 | <i>Reference group 1 wake-up delay</i> | Defines a wake-up delay for the sleep function to prevent nuisance wake-ups. See parameter 40.47 <i>Reference group 1 wake-up deviation</i> . The delay timer starts when the deviation exceeds the wake-up level (40.47 <i>Reference group 1 wake-up deviation</i>), and resets if the deviation falls below the wake-up level. | 0.50 s |
| | 0.00...60.00 s | Wake-up delay. | 1 = 1s |
| 40.49 | <i>Reference group 1 tracking mode</i> | Activates (or selects a source that activates) tracking mode. In tracking mode, the value selected by parameter 40.50 <i>Reference group 1 tracking reference selection</i> is substituted for the PID controller output. 1 = Tracking mode enabled | Not selected |
| | Not selected | 0 | 0 |
| | Select | 1 | 1 |
| | Timed function 1 | 34.01 Bit 0 of <i>Combined timer status</i> (See page 218). | 18 |
| | Timed function 2 | 34.01 Bit 1 of <i>Combined timer status</i> (See page 218). | 19 |
| | Timed function 3 | 34.01 Bit 2 of <i>Combined timer status</i> (See page 218). | 20 |
| | Monitor 1 | 32.01 Bit 0 of <i>Supervision status word</i> (See page 211). | 21 |
| | Monitor 2 | 32.01 Bit 1 of <i>Supervision status word</i> (See page 211). | 22 |
| | Monitor 3 | 32.01 Bit 2 of <i>Supervision status word</i> (See page 211). | 23 |
| | <i>Other [bit]</i> | Source selection (See <i>Terms and abbreviations</i> on page 130). | - |
| 40.50 | <i>Reference group 1 tracking reference selection</i> | Selects the value source for tracking mode. See parameter 40.49 <i>Reference group 1 tracking mode</i> . | Not selected |
| | Not selected | n/a | 0 |
| | AI1 scaled value | 12.12 <i>AI1 scaled value</i> (See page 152). | 1 |
| | AI2 scaled value | 12.22 <i>AI2 scaled value</i> (See page 154). | 2 |
| | FB A reference 1 | 03.05 <i>FB A reference 1</i> (See page 136). | 3 |
| | FB A reference 2 | 03.06 <i>FB A reference 2</i> (See page 136). | 4 |
| | <i>Other</i> | Source selection (See 130 on page <i>Terms and abbreviations</i>). | - |

| Serial number | Name/Value | Description | Def/FbEq16 |
|---------------|----------------------------------|-------------------------------------------------------------------------------------------------------------------------------------------------------------------------------------------------------------------------------------------------------------------------------------------------------------------------------------------------------------------------------------------------------|---------------------|
| 40.51 | <i>Set 1 trim mode</i> | Activates the trim function and selects between direct and proportional trimming (or a combination of both). With trimming, it is possible to apply a corrective factor to the drive reference (setpoint). The output after trimming is available as parameter <i>40.05 Process PID trim output act</i> . See section <i>PID trim function</i> (page 139), and the control chain diagram on page 610. | <i>Off</i> |
| | Off | The trim function is inactive. | 0 |
| | Direct | The trim function is active. The trimming factor is relative to the maximum speed, torque or frequency; the selection between these is made by parameter <i>40.52 Set 1 trim selection</i> . | 1 |
| | Proportional | The trim function is active. The trimming factor is relative to the reference selected by parameter <i>40.53 Set 1 trimmed ref pointer</i> . | 2 |
| | Combined | The trim function is active. The trimming factor is a combination of both <i>Direct</i> and <i>Proportional</i> modes; the proportions of each are defined by parameter <i>40.54 Set 1 trim mix</i> . | 3 |
| 40.52 | <i>Set 1 trim selection</i> | Selects whether trimming is used for correcting the speed, torque or frequency reference. | <i>Speed</i> |
| | Torque | Torque reference trimming. | 1 |
| | Speed | Speed reference trimming. | 2 |
| | Frequency | Frequency reference trimming. | 3 |
| 40.53 | <i>Set 1 trimmed ref pointer</i> | Selects the signal source for the trim reference. | <i>Not selected</i> |
| | Not selected | None. | 0 |
| | AI1 scaled | <i>12.12 AI1 scaled value</i> (see page 152). | 1 |
| | AI2 scaled | <i>12.22 AI2 scaled value</i> (see page 154). | 2 |
| | FB A ref1 | <i>03.05 FB A reference 1</i> (see page 136). | 3 |
| | FB A ref2 | <i>03.06 FB A reference 2</i> (see page 136). | 4 |
| | <i>Other</i> | Source selection (see <i>Terms and abbreviations</i> on page 130). | - |
| 40.54 | <i>Set 1 trim mix</i> | When parameter <i>40.51 Set 1 trim mode</i> is set to <i>Combined</i> , defines the effect of direct and proportional trim sources in the final trimming factor. 0.000 = 100% proportional 0.500 = 50% proportional, 50% direct 1.000 = 100% direct | 0.000 |
| | 0.000 ... 1.000 | Trim mix. | 1 = 1 |
| 40.55 | <i>Set 1 trim adjust</i> | Defines a multiplier for the trimming factor. This value is multiplied by the result of parameter <i>40.51 Set 1 trim mode</i> . Consequently, the result of the multiplication is used to multiply the result of parameter <i>40.56 Set 1 trim source</i> . | 1.000 |
| | -100.000 ... 100.000 | Multiplier for trimming factor. | 1 = 1 |
| 40.56 | <i>Set 1 trim source</i> | Selects the reference to be trimmed. | <i>PID output</i> |
| | PID ref | PID setpoint. | 1 |
| | PID output | PID controller output. | 2 |

| Serial number | Name/Value | Description | Def/FbEq16 |
|---------------|------------------------------------------------|----------------------------------------------------------------------------------------------------------------------------------------------------------------------------------------------------------------------------------------------------|------------|
| 40.57 | <i>PID set1/set2 selection</i> | Select the source of using process PID parameter set 1 (parameter 40.07...40.50) or parameter set 2 (41 Process PID set 2). 0 = using process PID parameter set 1 1 = using process PID parameter group 2 | PID set 1 |
| | PID set 1 | 0 | 0 |
| | PID set 2 | 1 | 1 |
| | Timed function 1 | 34.01 Bit 0 of <i>Combined timer status</i> (See page 218). | 18 |
| | Timed function 2 | 34.01 Bit 1 of <i>Combined timer status</i> (See page 218). | 19 |
| | Timed function 3 | 34.01 Bit 2 of <i>Combined timer status</i> (See page 218). | 20 |
| | Monitor 1 | 32.01 Bit 0 of <i>Supervision status word</i> (See page 211). | 21 |
| | Monitor 2 | 32.01 Bit 1 of <i>Supervision status word</i> (See page 211). | 22 |
| | Monitor 3 | 32.01 Bit 2 of <i>Supervision status word</i> (See page 211). | 23 |
| | <i>Other [bit]</i> | Source selection (See 130 on page <i>Terms and abbreviations</i>). | - |
| 40.58 | <i>Reference group 1 output raise limit</i> | Prevention of PID integration term increase for PID set 1. | No |
| | No | Increase prevention not in use. | 0 |
| | Limit | The PID integration term is not increased if the maximum value for the PID output is reached. This parameter is valid for the PID parameter set 1. | 1 |
| 40.59 | <i>Reference group 1 output decrease limit</i> | Prevention of PID integration term decrease for PID set 1. | No |
| | No | Decrease prevention not in use. | 0 |
| | Limit | The PID integration term is not decreased if the minimum value for the PID output is reached. This parameter is valid for the PID parameter set 1. | 1 |
| 40.60 | <i>Set 1 PID activation source</i> | Selects a source that enables/disables process PID control. See also parameter 40.07 Process PID operation mode . 0 = Process PID control disabled. 1 = Process PID control enabled. | <i>On</i> |
| | Off | 0. | 0 |
| | On | 1. | 1 |
| | Follow Ext1/Ext2 selection | Process PID control is disabled when external control location EXT1 is active, and enabled when external control location EXT2 is active. See also parameter 19.11 Ext1/Ext2 selection . | 2 |
| | <i>Other [bit]</i> | Source selection (see <i>Terms and abbreviations</i> on page 130). | - |
| 40.61 | <i>Setpoint scaling actual</i> | Actual setpoint scaling. See parameter 40.14 Set 1 setpoint scaling . | 100.00 |
| | -200000.00... 200000.00 | Scaling. | 1 = 1 |
| 40.62 | <i>PID internal actual setpoint</i> | Displays the value of the internal setpoint. See the control chain diagram on page 373 . This parameter is read-only. | - |

| Serial number | Name/Value | Description | Def/FbEq16 |
|---------------|-----------------------------|--------------------------------------------------------------------------------------------------------------------------------------------------------------------------------------------------------------------------------------------------------------------------------------------------------|----------------|
| | -32768.00... 32767.00 | Process PID internal setpoint. | 1 = 1 unit |
| 40.65 | <i>Trim auto connection</i> | Enables the PID trim auto connection and connects PID trim <i>40.05 Process PID trim output act</i> to either speed, torque or frequency chains, based on the trim selection parameter <i>40.52 Set 1 trim selection</i> or <i>41.52 Set 2 trim selection</i> . See control chain diagram on page 614. | <i>Disable</i> |
| | Disable | Disable PID trim auto connection. | 0 |
| | Enable | Enable PID trim auto connection. | 1 |
| 40.79 | <i>Set 1 units</i> | Unit used for PID set 1. | °C |
| | User text | User editable text. | 0 |
| | % | Percent. | 4 |
| | bar | Bar. | 74 |
| | kPa | Kilo pascal. | 75 |
| | Pa | Pascal. | 77 |
| | psi | Pound per square inch. | 76 |
| | CFM | Cubic feet per minute. | 26 |
| | inH ₂ O | Inch of water. | 58 |
| | °C | Degree Celsius. | 150 |
| | °F | Degree Fahrenheit. | 151 |
| | mbar | Millibar. | 44 |
| | m ³ /h | Cubic meter per hour. | 78 |
| | dm ³ /h | Cubic decimeter per hour. | 21 |
| | l/s | Liter per second. | 79 |
| | l/min | Liter per minute. | 37 |
| | l/h | Liter per hour. | 38 |
| | m ³ /s | Cubic meter per second. | 88 |
| | m ³ /min | Cubic meter per minute. | 40 |
| | km ³ /h | Cubic kilometer per minute. | 131 |
| | gal/s | Gallon per second. | 47 |
| | ft ³ /s | Cubic feet per second. | 50 |
| | ft ³ /min | Cubic feet per minute. | 51 |
| | ft ³ /h | Cubic feet per hour. | 52 |
| | ppm | Parts per million. | 34 |
| | inHg | Inch of mercury. | 29 |
| | kCFM | Cubic kilo feet per minute. | 126 |
| | inWC | Inch of water. | 85 |
| | gpm | Gallon per minute. | 80 |
| | gal/min | Gallon per minute. | 48 |
| | in wg | Inch water gauge. | 59 |
| | MPa | Megapascal. | 94 |
| | ftWC | Feet of water. | 125 |

| Serial number | Name/Value | Description | Def/FbEq16 |
|---------------|------------------------------------|--------------------------------------------------------------------------------------------------------------------------------------------------------------------------------------------------------------------------------------------------------------------------------------------------------------------------------------------------------------------------------------------------------------------------------------------|------------------------|
| 40.80 | <i>Set 1 PID output min source</i> | Selects the source for set 1 PID output minimum. | <i>Set1 output min</i> |
| | None | Not selected. | 0 |
| | Set1 output min | <i>40.36 Reference group 1 the minimum output value.</i> | 1 |
| 40.81 | <i>Set 1 PID output max source</i> | Selects the source for set 1 PID output maximum. | <i>Set1 output max</i> |
| | None | Not selected. | 0 |
| | Set1 output max | <i>40.37 Reference group 1 the maximum output value</i> | 1 |
| 40.89 | <i>Set 1 setpoint multiplier</i> | Defines the multiplier with which the result of the function specified by parameter <i>40.18 Reference group 1 set value function</i> is multiplied. | 1.00 |
| | -200000.00... 200000.00 | Multiplier. | 1 = 1 |
| 40.90 | <i>Set 1 feedback multiplier</i> | Defines the multiplier with which the result of the function specified by parameter <i>40.10 Reference group 1 feedback function</i> is multiplied. | 1.00 |
| | -200000.00... 200000.00 | Multiplier. | 1 = 1 |
| 40.91 | <i>Feedback data storage</i> | Set storage parameter receiving process feedback value by embedded fieldbus interface. The value can be sent to drive as Modbus I/O data. Set the target selection parameters of specific data (<i>58.101...58.114</i>) to <i>Feedback data storage</i> . Among parameters <i>40.08Reference group 1 feedback 1 signal source</i> (or <i>40.09Reference group 1 feedback 2 signal source</i>), select <i>Feedback data storage</i> . | |
| | -327.68...327.67 | Storage parameter for process feedback. | |
| 40.92 | <i>Setpoint data storage</i> | | |
| | -327.68...327.67 | Storage parameter for process setpoint. | |
| 40.96 | <i>Process PID output %</i> | Percentage scaled signal of parameter <i>40.01 PID feedback value</i> . | 0.00% |
| | -100.00...100.00% | Percentage. | 100 = 1% |
| 40.97 | <i>Process PID feedback %</i> | Percentage scaled signal of parameter <i>40.02 PID feedback value</i> . | 0.00% |
| | -100.00...100.00% | Percentage. | 100 = 1% |
| 40.98 | <i>Process PID setpoint %</i> | Percentage scaled signal of parameter <i>40.03 PID setpoint</i> . | 0.00% |
| | -100.00...100.00% | Percentage. | 100 = 1% |
| 40.99 | <i>Process PID deviation %</i> | Percentage scaled signal of parameter <i>40.04 PID deviation value</i> . | 0.00% |
| | -100.00...100.00% | Percentage. | 100 = 1% |

| Serial number | Name/Value | Description | Def/FbEq16 |
|-----------------------------|--------------------------------------------------------|-----------------------------------------------------------------------------------------------------------------------------------------------------------------------------------------------------------------------------------------------------------------------------------------------------------|-------------------------|
| 41 Process PID set 2 | | | |
| | | A second set of parameter values for process PID control. The selection between this set and first set (parameter group <i>PID set 1/set2 selection</i> is made by parameter <i>40 Process PID set 1 40.57</i>). See also parameters <i>40.01...40.06</i> , and the control chain diagrams on pages 376. | |
| 41.08 | <i>Reference group 2 feedback 1 signal source</i> | See parameter <i>40.08 Reference group 1 feedback 1 signal source</i> . | Al1 percent |
| 41.09 | <i>Reference group 2 feedback 2 signal source</i> | See parameter <i>40.09 Reference group 1 feedback 2 signal source</i> . | <i>Not selected</i> |
| 41.10 | <i>Reference group 2 feedback function</i> | See parameter <i>40.10 Reference group 1 feedback function</i> . | <i>in1</i> |
| 41.11 | <i>Reference group 2 feedback filter time</i> | See parameter <i>40.11 Reference group 1 feedback filter time</i> . | 0.000 s |
| 41.16 | <i>Reference group 2 set value 1 signal source</i> | See parameter <i>40.16 Reference group 1 set value 1 signal source</i> . | Al2 percent |
| 41.17 | <i>Reference group 2 set value 2 signal source</i> | See parameter <i>40.17 Reference group 1 set value 2 signal source</i> . | <i>Not selected</i> |
| 41.18 | <i>Reference group 2 set value function</i> | See parameter <i>40.18 Reference group 1 set value function</i> . | <i>in1</i> |
| 41.19 | <i>Reference group 2 internal setpoint selection 1</i> | See parameter <i>40.19 Reference group 1 internal setpoint selection 1</i> . | <i>Not selected</i> |
| 41.20 | <i>Reference group 2 internal setpoint selection 2</i> | See parameter <i>40.20 Reference group 1 internal setpoint selection 2</i> . | <i>Not selected</i> |
| 41.21 | <i>Reference group 2 internal setpoint 1</i> | See parameter <i>40.21 Reference group 1 internal setpoint 1</i> . | 0.00 |
| 41.22 | <i>Reference group 2 internal setpoint 2</i> | See parameter <i>40.22 Reference group 1 internal setpoint 2</i> . | 0.00 |
| 41.23 | <i>Reference group 2 internal setpoint 3</i> | See parameter <i>40.23 Reference group 1 internal setpoint 3</i> . | 0.00 |
| 41.24 | <i>Set 2 internal setpoint 0</i> | <i>40.24 Set 1 internal setpoint 0</i> . | 0.00 PID customer units |
| 41.26 | <i>Reference group 2 the minimum set value</i> | See parameter <i>40.26 Reference group 1 the minimum set value</i> . | 0.00 |
| 41.27 | <i>Reference group 2 the maximum set value</i> | See parameter <i>40.27 Reference group 1 the maximum set value</i> . | 32767.00 |
| 41.28 | <i>Reference group 2 set value increase time</i> | See parameter <i>40.28 Reference group 1 set value increase time</i> . | 0.0 s |
| 41.29 | <i>Reference group 2 setpoint decrease time</i> | See parameter <i>40.29 Reference group 1 setpoint decrease time</i> . | 0.0 s |

256 *Parameter*

| Serial number | Name/Value | Description | Def/FbEq16 |
|----------------------|-----------------------------------------------------|----------------------------------------------------------------------------|---------------------------------|
| 41.30 | <i>Reference group 2 set value keeping function</i> | See parameter 40.30 <i>Reference group 1 set value keeping function.</i> | <i>Not selected</i> |
| 41.31 | <i>Reference group 2 negated deviation value</i> | See parameter 40.31 <i>Reference group 1 negated deviation value.</i> | <i>Not inverted (Ref - Fbk)</i> |
| 41.32 | <i>Reference group 2 gain</i> | See parameter 40.32 <i>Reference group 1 gain.</i> | 1.00 |
| 41.33 | <i>Reference group 2 integration time</i> | See parameter 40.33 <i>Reference group 1 integration time.</i> | 60.0 s |
| 41.34 | <i>Reference group 2 derivation time</i> | See parameter 40.34 <i>Reference group 1 derivation time.</i> | 0.000 s |
| 41.35 | <i>Reference group 2 derivation filter time</i> | See parameter 40.35 <i>Reference group 1 derivation filter time.</i> | 0.0 s |
| 41.36 | <i>Reference group 2 the minimum output value</i> | See parameter 40.36 <i>Reference group 1 the minimum output value.</i> | -32768.0 |
| 41.37 | <i>Reference group 2 the maximum output value</i> | See parameter 40.37 <i>Reference group 1 the maximum output value.</i> | 32767.0 |
| 41.38 | <i>Reference group 2 output keeping function</i> | See parameter 40.38 <i>Reference group 1 output keeping function.</i> | <i>Not selected</i> |
| 41.39 | <i>Set 2 deadband range</i> | See parameter 40.39 <i>Set 1 deadband range.</i> | 0.00 PID customer units |
| 41.40 | <i>Set 2 deadband delay</i> | See parameter 40.40 <i>Set 1 deadband delay.</i> | 0.0 s |
| 41.43 | <i>Reference group 2 sleeping speed/frequency</i> | See parameter 40.43 <i>Reference group 1 sleep frequency.</i> | 0.0 |
| 41.44 | <i>Reference group 2 sleeping delay</i> | See parameter 40.44 <i>Reference group 1 sleeping delay.</i> | 60.0 s |
| 41.45 | <i>Reference group 2 sleep boost time</i> | See parameter 40.45 <i>Reference group 1 sleep boost time.</i> | 0.0 s |
| 41.46 | <i>Reference group 2 sleeping raise period</i> | See parameter 40.46 <i>Reference group 1 sleeping raise period.</i> | 0.0 |
| 41.47 | <i>Reference group 2 wake-up deviation</i> | See parameter 40.47 <i>Reference group 1 wake-up deviation.</i> | 0.00% |
| 41.48 | <i>Reference group 2 wake-up delay</i> | See parameter 40.48 <i>Reference group 1 wake-up delay.</i> | 0.50 s |
| 41.49 | <i>Reference group 2 tracking mode</i> | See parameter 40.49 <i>Reference group 1 tracking mode.</i> | <i>Not selected</i> |
| 41.50 | <i>Set 2 tracking ref selection</i> | See parameter 40.50 <i>Reference group 1 tracking reference selection.</i> | <i>Not selected</i> |
| 41.51 | <i>Set 2 trim mode</i> | See parameter 40.51 <i>Set 1 trim mode.</i> | <i>Off</i> |
| 41.52 | <i>Set 2 trim selection</i> | See parameter 40.52 <i>Set 1 trim selection.</i> | <i>Speed</i> |
| 41.53 | <i>Set 2 trimmed ref pointer</i> | See parameter 40.53 <i>Set 1 trimmed ref pointer.</i> | <i>Not selected</i> |

| Serial number | Name/Value | Description | Def/FbEq16 |
|-------------------------|------------------------------------------------|--------------------------------------------------------------------------------------------------------------------------------------------------------------------------------------------------------------------------------------------------------------------------------------------------------------------------------------------------------------------------------------------------------------------------------------------------------------------------------------------------------------------------------------------------------------------|------------------------|
| 41.54 | <i>Set 2 trim mix</i> | See parameter 40.54 Set 1 trim mix . | - |
| 41.55 | <i>Set 2 trim adjust</i> | See parameter 40.55 Set 1 trim adjust . | 1.000 |
| 41.56 | <i>Set 2 trim source</i> | See parameter 40.56 Set 1 trim source . | <i>PID output</i> |
| 41.58 | <i>Reference group 2 output raise limit</i> | See parameter 40.58 Reference group 1 output raise limit . | No |
| 41.59 | <i>Reference group 2 output decrease limit</i> | See parameter 40.59 Reference group 1 output decrease limit . | No |
| 41.60 | <i>Set 2 PID activation source</i> | See parameter 40.60 Set 1 PID activation source . | On |
| 41.79 | <i>Set 2 units</i> | See parameter 40.79 Set 1 units . | °C |
| 41.80 | <i>Set 2 PID output min source</i> | Selects the source for set 2 PID output minimum. | <i>Set2 output min</i> |
| | None | Not selected. | 0 |
| | Set2 output min | 41.36 Set 2 output min . | 1 |
| 41.81 | <i>Set 2 PID output max source</i> | Selects the source for set 2 PID output maximum. | <i>Set2 output max</i> |
| | None | Not selected. | 0 |
| | Set2 output max | 41.37 Set 2 output max | 1 |
| 41.89 | <i>Set 2 setpoint multiplier</i> | See parameter 40.89 Set 1 setpoint multiplier . | 1.00 |
| 41.90 | <i>Set 2 feedback multiplier</i> | Defines the multiplier k used in formulas of parameter 41.10 Set 2 feedback function . See parameter 40.90 Set 1 feedback multiplier . | 1.00 |
| 43 Brake chopper | | Settings for the internal brake chopper. | |
| 43.01 | <i>Brake resistor temperature</i> | Displays the estimated temperature of the brake resistor, or how close the brake resistor is to being too hot. The value is given in percent where 100% is the temperature the resistors would reach if the maximum continuous braking power (43.09 Brake resistor Pmax cont) is applied to the resistors for 100% rated time. The thermal time constant (43.08 Brake resistor thermal time) defines the rated time to achieve 63% temperature. 100% would be reached when 100% time has elapsed. This parameter is read-only. | - |
| | 0.0...120.0% | Estimated brake resistor temperature. | 1 = 1% |

| Serial number | Name/Value | Description | Def/FbEq16 |
|---------------|---------------------------------------|-----------------------------------------------------------------------------------------------------------------------------------------------------------------------------------------------------------------------------------------------------------------------------------------------------------------------------------------------------------------------------------------------------------|------------|
| 43.06 | <i>Braking chopper enable</i> | Enables brake chopper control. Note: Before enabling brake chopper control, ensure that: <ul style="list-style-type: none"> • a brake resistor is connected • overvoltage control is switched off (parameter 30.30 Overvoltage control) • The supply voltage range has been selected correctly. (parameter 95.01 Supply volt). | Inhibited |
| | Inhibited | Brake chopper control disabled. | 0 |
| | Enabled with thermal model | Brake chopper control enabled with resistor overload protection. | 1 |
| | Enabled without thermal model | Brake chopper control enabled without resistor overload protection. This setting can be used, for example, if the resistor is equipped with a thermal circuit breaker that is wired to stop the drive if the resistor overheats. | 2 |
| | Overvoltage peak protection | - | 3 |
| 43.07 | <i>Braking chopper runtime enable</i> | Selects the source for quick brake chopper on/off control. 0 = Brake chopper IGBT pulses are cut off 1 = Normal brake chopper IGBT modulation. This parameter can be used to program the chopper control to function only when the supply is missing from a drive with a regenerative supply unit. | Open |
| | Off | 0 | 0 |
| | Open | 1 | 1 |
| | <i>Other [bit]</i> | Source selection (See 130 on page Terms and abbreviations). | - |
| 43.08 | <i>Brake resistor thermal time</i> | Defines the thermal time constant of the brake resistors for overload protection. | 0 s |
| | 0...10000 s | Brake resistor thermal time constant. | 1 = 1s |
| 43.09 | <i>Brake resistor Pmax cont</i> | Defines the maximum continuous braking power of the resistor (in kW) which will raise the resistor temperature to the maximum allowed value. The value is used in the overload protection . | 0.00 kW |
| | 0.00... 10000.00 kW | Maximum continuous braking power. | 1 = 1 kW |
| 43.10 | <i>Brake resistance</i> | Defines the resistance value of the brake resistor. The value is used for brake chopper protection. | 0.0 ohm |
| | 0.0...1000.0 ohm | Brake resistor resistance value. | 1 = 1 ohm |
| 43.11 | <i>Brake resistor fault limit</i> | Selects the fault limit for the brake resistor temperature protection function. When the limit is exceeded, the drive trips on fault due to 7183 Brake resistor temperature is excessive . The value is given in percent of the temperature the resistors reach (when loaded with the power defined by parameter 43.09 Brake resistor Pmax cont). | 105% |
| | 0...150% | Brake resistor temperature fault limit. | 1 = 1% |

| Serial number | Name/Value | Description | Def/FbEq16 | | | | | | | | | | | | | | | | | | | | | | | | | | | | | | | | | |
|------------------------------------|----------------------------------------------------------------------------------------------------------------------------------------------------------------------------------------------------------------------------------------------------------------------------------------------------------------------------------------------------------------------------------------------------------------------------------------------------------------------------------------------------------------------------------------------------------------------------------------------------------------------------------------------------------------------------------------------------------------------------------------------------------------------------------------------------------------------------------------------------------------------------------------------------------------------------------------------------------------------------------------------------------------------------------------------------------------------------------------------------------------------------------------------------------|---------------------------------------------------------------------------------------------------------------------------------------------------------------------------------------------------------------------------------------------------------------------------------------------------------------------------------------------------------------------|------------|--------|------|-------------|---|--------------|----------------------------------------------------------------------------------------------|---|----------------|-----------------------------------------------|---|----------------------|-------------------------------------|---|-----------------|-----------------------------------------------------------|---|---------|------------------------------|---|--------|------------------------------------------------------|---|---------|-------------------------------------------------------|---|------|----------------------------------------------------|---|---------|-------------------------------------------------------|--------|---------|--|
| 43.12 | <i>Brake resistor warning limit</i> | Selects the warning limit for the brake resistor temperature protection function. When the limit is exceeded, the drive generates a <i>A793 Brake resistor temperature is excessive</i> warning. The value is given in percent of the temperature the resistors reach (when loaded with the power defined by parameter <i>43.09 Brake resistor Pmax cont.</i>). | 95% | | | | | | | | | | | | | | | | | | | | | | | | | | | | | | | | | |
| | 0...150% | Brake resistor warning limit | 1 = 1% | | | | | | | | | | | | | | | | | | | | | | | | | | | | | | | | | |
| 44 Mechanical brake control | | Configuration of mechanical brake control. See also section <i>Mechanical brake control</i> (page 79). | | | | | | | | | | | | | | | | | | | | | | | | | | | | | | | | | | |
| 44.01 | <i>Brake control status word</i> | Displays the mechanical brake control status word. This parameter is read-only. | - | | | | | | | | | | | | | | | | | | | | | | | | | | | | | | | | | |
| | <table border="1"> <thead> <tr> <th>Bit(s)</th> <th>Name</th> <th>Information</th> </tr> </thead> <tbody> <tr> <td>0</td> <td>Open command</td> <td>Close/open command to brake drive (0 = close, 1 = open). Connect this bit to desired output.</td> </tr> <tr> <td>1</td> <td>Opening torque</td> <td>1 = Opening torque requested from drive logic</td> </tr> <tr> <td>2</td> <td>Hold stopped request</td> <td>1 = Hold requested from drive logic</td> </tr> <tr> <td>3</td> <td>Ramp to stopped</td> <td>1 = Ramping down to zero speed requested from drive logic</td> </tr> <tr> <td>4</td> <td>Enabled</td> <td>1 = Brake control is enabled</td> </tr> <tr> <td>5</td> <td>Closed</td> <td>1 = Brake control logic in <i>BRAKE CLOSED</i> state</td> </tr> <tr> <td>6</td> <td>Opening</td> <td>1 = Brake control logic in <i>BRAKE OPENING</i> state</td> </tr> <tr> <td>7</td> <td>Open</td> <td>1 = Brake control logic in <i>BRAKE OPEN</i> state</td> </tr> <tr> <td>8</td> <td>Closing</td> <td>1 = Brake control logic in <i>BRAKE CLOSING</i> state</td> </tr> <tr> <td>9...15</td> <td>Reserve</td> <td></td> </tr> </tbody> </table> | | | Bit(s) | Name | Information | 0 | Open command | Close/open command to brake drive (0 = close, 1 = open). Connect this bit to desired output. | 1 | Opening torque | 1 = Opening torque requested from drive logic | 2 | Hold stopped request | 1 = Hold requested from drive logic | 3 | Ramp to stopped | 1 = Ramping down to zero speed requested from drive logic | 4 | Enabled | 1 = Brake control is enabled | 5 | Closed | 1 = Brake control logic in <i>BRAKE CLOSED</i> state | 6 | Opening | 1 = Brake control logic in <i>BRAKE OPENING</i> state | 7 | Open | 1 = Brake control logic in <i>BRAKE OPEN</i> state | 8 | Closing | 1 = Brake control logic in <i>BRAKE CLOSING</i> state | 9...15 | Reserve | |
| Bit(s) | Name | Information | | | | | | | | | | | | | | | | | | | | | | | | | | | | | | | | | | |
| 0 | Open command | Close/open command to brake drive (0 = close, 1 = open). Connect this bit to desired output. | | | | | | | | | | | | | | | | | | | | | | | | | | | | | | | | | | |
| 1 | Opening torque | 1 = Opening torque requested from drive logic | | | | | | | | | | | | | | | | | | | | | | | | | | | | | | | | | | |
| 2 | Hold stopped request | 1 = Hold requested from drive logic | | | | | | | | | | | | | | | | | | | | | | | | | | | | | | | | | | |
| 3 | Ramp to stopped | 1 = Ramping down to zero speed requested from drive logic | | | | | | | | | | | | | | | | | | | | | | | | | | | | | | | | | | |
| 4 | Enabled | 1 = Brake control is enabled | | | | | | | | | | | | | | | | | | | | | | | | | | | | | | | | | | |
| 5 | Closed | 1 = Brake control logic in <i>BRAKE CLOSED</i> state | | | | | | | | | | | | | | | | | | | | | | | | | | | | | | | | | | |
| 6 | Opening | 1 = Brake control logic in <i>BRAKE OPENING</i> state | | | | | | | | | | | | | | | | | | | | | | | | | | | | | | | | | | |
| 7 | Open | 1 = Brake control logic in <i>BRAKE OPEN</i> state | | | | | | | | | | | | | | | | | | | | | | | | | | | | | | | | | | |
| 8 | Closing | 1 = Brake control logic in <i>BRAKE CLOSING</i> state | | | | | | | | | | | | | | | | | | | | | | | | | | | | | | | | | | |
| 9...15 | Reserve | | | | | | | | | | | | | | | | | | | | | | | | | | | | | | | | | | | |
| | 0000h...FFFFh | Mechanical brake control status word. | 1 = 1 | | | | | | | | | | | | | | | | | | | | | | | | | | | | | | | | | |

| Serial number | Name/Value | Description | Def/FbEq16 |
|---------------|-----------------------------|--------------------------------------------------------------------------------------------------------------------------------------------------------------------------------------------------------------------------------------------------------------------------------------------------------------------------------------------------------------------------------------------------------------------------------|----------------------------|
| 44.06 | <i>Brake control enable</i> | Activates/deactivates (or selects a source that activates / deactivates) the mechanical brake control logic. 0 = Brake control inactive 1 = Brake control active | Not selected |
| | Not selected | 0. | 0 |
| | Select | 1. | 1 |
| | DI1 | Digital input DI1 (<i>10.02 DI delayed status</i> , bit 0). | 2 |
| | DI2 | Digital input DI2 (<i>10.02 DI delayed status</i> , bit 1). | 3 |
| | DI3 | Digital input DI3 (<i>10.02 DI delayed status</i> , bit 2). | 4 |
| | DI4 | Digital input DI4 (<i>10.02 DI delayed status</i> , bit 3). | 5 |
| | DI5 | Digital input DI5 (<i>10.02 DI delayed status</i> , bit 4). | 6 |
| | DI6 | Digital input DI6 (<i>10.02 DI delayed status</i> , bit 5). | 7 |
| | Timed function 1 | <i>34.01</i> Bit 0 of <i>Combined timer status</i> (See page 218). | 18 |
| | Timed function 2 | <i>34.01</i> Bit 1 of <i>Combined timer status</i> (See page 218). | 19 |
| | Timed function 3 | <i>34.01</i> Bit 2 of <i>Combined timer status</i> (See page 218). | 20 |
| | Monitor 1 | <i>32.01</i> Bit 0 of <i>Supervision status word</i> (See page 211). | 24 |
| | Monitor 2 | <i>32.01</i> Bit 1 of <i>Supervision status word</i> (See page 211). | 25 |
| | Monitor 3 | <i>32.01</i> Bit 2 of <i>Supervision status word</i> (See page 211). | 26 |
| | <i>Other [bit]</i> | Source selection (See <i>130 on page Terms and abbreviations</i>). | - |
| 44.08 | BRAKE OPENING DELAY | Defines the brake open delay, i.e. the delay between the internal open brake command and the release of motor speed control. The delay timer starts when the drive has magnetized the motor. Simultaneously with the timer start, the brake control logic energizes the brake control output and the brake starts to open. Set this parameter to the value of mechanical opening delay specified by the brake manufacturer. | 0.00 s |
| | 0.00...5.00 s | Brake open delay. | 100 = 1s |
| 44.13 | <i>Brake close delay</i> | Specifies a delay between a close command (that is, when the brake control output is de-energized) and when the drive stops modulating. This is to keep the motor live and under control until the brake actually closes. Set this parameter equal to the value specified by the brake manufacturer as the mechanical make-up time of the brake. | 0.00 s |
| | 0.00...60.00 s | Brake close delay. | 100 = 1s |
| 44.14 | <i>Brake close level</i> | Defines the brake close speed as an absolute value. After motor speed has decelerated to this level, a close command is given. | 100.0 rpm |
| | 0.0... 1000.0 rpm | Brake close speed. | See parameter <i>46.01</i> |

| Serial number | Name/Value | Description | Def/FbEq16 |
|-----------------------------|-----------------------------|----------------------------------------------------------------------------------------------------------------------------------------------------------------------------------------------------------------------------------------------------------------------------------------------------------------------------------------------------------------------------------------------------------------------------------------------------------------------------------------------------------------------------------------------------------------------------|------------|
| 45 Energy efficiency | | Settings for the energy saving calculators. See also section Energy saving calculators (page 92). | |
| 45.01 | <i>Saved energy (kWh)</i> | Energy saved in GWh compared to direct-on-line motor connection. This parameter is incremented when 45.02 Saved energy (kWh) rolls over. This parameter is read-only (See parameter 45.21 Energy calculations reset). | - |
| | 0...65535 GWh | Energy savings in GWh. | 1 = 1 GWh |
| 45.02 | <i>Saved energy (kWh)</i> | Energy saved in MWh compared to direct-on-line motor connection. This parameter is incremented when 45.03 Saved energy (kWh) rolls over. When this parameter rolls over, parameter 45.01 Saved energy (kWh) is incremented. This parameter is read-only (See parameter 45.21 Energy calculations reset). | - |
| | 0...999 MWh | Energy savings in MWh. | 1 = 1 MWh |
| 45.03 | <i>Saved energy (kWh)</i> | Energy saved in kWh compared to direct-on-line motor connection. If the internal brake chopper of the drive is enabled, all energy fed by the motor to the drive is assumed to be converted into heat, but the calculation still records savings made by controlling the speed. If the chopper is disabled, then regenerated energy from the motor is also recorded here. When this parameter rolls over, parameter 45.02 Saved energy (kWh) is incremented. This parameter is read-only (See parameter 45.21 Energy calculations reset). | - |
| | 0.0...999.9 kWh | Energy savings in kWh. | 10 = 1 kWh |
| 45.04 | <i>Totally saved energy</i> | Energy saved in kWh compared to direct-on-line motor connection. If the internal brake chopper of the drive is enabled, all energy fed by the motor to the drive is assumed to be converted into heat. This parameter is read-only (See parameter 45.21 Energy calculations reset). | - |
| | 0.0...214748364.7 kWh | Energy savings in kWh. | 1 = 1 kWh |
| 45.05 | <i>Saved money x1000</i> | Monetary savings in thousands compared to direct-on-line motor connection. This parameter is incremented when 45.06 Saved money rolls over. This parameter is read-only (See parameter 45.21 Energy calculations reset). | - |
| | 0...4294967295 thousands | Monetary savings in thousands of units. | 1 = 1 unit |
| 45.06 | <i>Saved money</i> | Monetary savings compared to direct-on-line motor connection. This value is a calculated by multiplying the saved energy in kWh by the currently active energy tariff (45.14 Tariff selection) . When this parameter rolls over, parameter 45.05 Saved money x1000 is incremented. This parameter is read-only (See parameter 45.21 Energy calculations reset). | - |
| | 0.00... 999.99 units | Monetary savings. | 1 = 1 unit |

| Serial number | Name/Value | Description | Def/FbEq16 |
|---------------|---------------------------------------|------------------------------------------------------------------------------------------------------------------------------------------------------------------------------------------------------------------------------------------------------------------------------------------------------------------------------------------------------------------------------------------------------------------------------------------------------------------------------------------------|----------------------|
| 45.07 | <i>Saved amount</i> | Monetary savings compared to direct-on-line motor connection. This value is calculated by multiplying the saved energy in kWh by the currently active energy tariff (45.14 Tariff selection). This parameter is read-only (See parameter 45.21 Energy calculations reset). | - |
| | 0.00... 21474836.47 units | Monetary savings. | 1 = 1 unit |
| 45.08 | <i>CO2 reduction (in metric tons)</i> | Reduction in CO ₂ emissions in metric kilotons compared to direct-on-line motor connection. This value is incremented when parameter 45.09 CO2 reduction (in tons) rolls over. This parameter is read-only (See parameter 45.21 Energy calculations reset). | - |
| | 0...65535 metric kilotons | Reduction in CO ₂ emissions in metric kilotons. | 1 = 1 metric kiloton |
| 45.09 | <i>CO2 reduction (in tons)</i> | Reduction in CO ₂ emissions in metric tons compared to direct-on-line motor connection. This value is calculated by multiplying the saved energy in MWh by the value of parameter 45.18 CO2 conversion factor (by default, 0.5 metric tons/MWh). When this parameter rolls over, parameter 45.08 CO2 reduction (in metric tons) is incremented. This parameter is read-only (See parameter 45.21 Energy calculations reset). | - |
| | 0.0 ... 999.9 metric tons | Reduction in CO ₂ emissions in metric tons. | 1 = 1 metric ton |
| 45.10 | <i>Decreased CO2 emission</i> | Reduction in CO ₂ emissions in metric tons compared to direct-on-line motor connection. This value is calculated by multiplying the saved energy in MWh by the value of parameter 45.18 CO2 conversion factor (by default, 0.5 metric tons/ MWh). This parameter is read-only (See parameter 45.21 Energy calculations reset). | - |
| | 0.0 ... 214748364.7 metric tons | Reduction in CO ₂ emissions in metric tons. | 1 = 1 metric ton |
| 45.11 | <i>Energy (flux) optimization</i> | Enables/disables the energy optimization function. Function optimizes the motor flux so that the total energy consumption and motor noise level are reduced when the drive operates below the nominal load. Total efficiency (motor and drive) can be improved by 1...20% depending on the load torque and speed. | Inhibited |
| | Inhibited | Energy optimization disabled. | 0 |
| | Enabled | Energy optimization enabled. | 1 |
| 45.12 | <i>Energy tariff 1</i> | Defines energy tariff 1 (price of energy per kWh). Depending on the setting of parameter 45.14 Tariff selection , either this value or 45.13 Energy tariff 2 is used for reference when monetary savings are calculated. Note: Tariffs are read only at the instant of selection, and are not applied retroactively. | 0.100 units |
| | 0.000... 4294967.295 units | Energy tariff 1. | - |



| Serial number | Name/Value | Description | Def/FbEq16 |
|---------------|----------------------------------|------------------------------------------------------------------------------------------------------------------------------------------------------------------------------------------------------------------------------------------------------------------------------------------------------------------------------------------------------------------------------------------------------------------------------------------------------------------------------|------------------------|
| 45.13 | <i>Energy tariff 2</i> | Defines energy tariff 2 (price of energy per kWh). See parameter 45.12 Energy tariff 1 . | 0.200 units |
| | 0.000... 4294967.295 units | Energy tariff 2. | - |
| 45.14 | <i>Tariff selection</i> | Selects (or defines a source that selects) which pre-defined energy tariff is used. 0 = 45.12 Energy tariff 1 1 = 45.13 Energy tariff 2 | <i>Energy tariff 1</i> |
| | Energy tariff 1 | 0. | 0 |
| | Energy tariff 2 | 1. | 1 |
| | DI1 | Digital input DI1 (10.02 DI delayed status , bit 0). | 2 |
| | DI2 | Digital input DI2 (10.02 DI delayed status , bit 1). | 3 |
| | DI3 | Digital input DI3 (10.02 DI delayed status , bit 2). | 4 |
| | DI4 | Digital input DI4 (10.02 DI delayed status , bit 3). | 5 |
| | DI5 | Digital input DI5 (10.02 DI delayed status , bit 4). | 6 |
| | DI6 | Digital input DI6 (10.02 DI delayed status , bit 5). | 7 |
| | <i>Other [bit]</i> | Source selection (See 130 on page Terms and abbreviations). | - |
| 45.18 | <i>CO2 conversion factor</i> | Defines a factor for conversion of saved energy into CO ₂ emissions (kg/kWh or tn/MWh). | 0.500 tn/MWh |
| | 0.000...65.535 tn/MWh | Factor for conversion of saved energy into CO ₂ emissions. | 1 = 1 tn/MWh |
| 45.19 | <i>Comparison power</i> | Actual power that the motor absorbs when connected direct-on-line and operating the application. The value is used for reference when energy savings are calculated. Note: The accuracy of the energy savings calculation is directly dependent on the accuracy of this value. If nothing is entered here, then the nominal motor power is used by the calculation, but that may inflate the energy savings reported as many motors do not absorb nameplate power. | 0.00 kW |
| | 0.00...100000.00 kW | Motor power. | 1 = 1 kW |
| 45.21 | <i>Energy calculations reset</i> | Resets the savings counter parameters 45.01...45.10 . | Finalization |
| | Finalization | Reset not requested (normal operation), or reset complete. | 0 |
| | Resetting | Reset the savings counter parameters. The value reverts back to Finalization automatically. | 1 |
| 45.24 | <i>Hourly peak power value</i> | Value of the peak power during the last hour, that is, the most recent 60 minutes after the drive has been powered up. The parameter is updated once every 10 minutes unless the hourly peak is found in the most recent 10 minutes. In that case, the values is shown immediately. | 0.00 kW |
| | -3000.00... 3000.00 kW | Peak power value. | 10 = 1 kW |
| 45.25 | <i>Hourly peak power time</i> | Time of the peak power value during the last hour. | 00:00:00 |
| | | Time. | N/A |

| Serial number | Name/Value | Description | Def/FbEq16 |
|---------------|----------------------------------------------|--------------------------------------------------------------------------------------------------------------------------------------------------------------------------|--------------|
| 45.26 | <i>Hourly total energy (resettable)</i> | Total energy consumption during the last hour, that is, the most recent 60 minutes. You can reset the value by setting it to zero. | 0.00 kWh |
| | -3000.00 ... 3000.00 kWh | Total energy. | 10 = 1 kWh |
| 45.27 | <i>Daily peak power value (resettable)</i> | Value of the peak power since midnight of the present day. You can reset the value by setting it to zero. | 0.00 kW |
| | -3000.00 ... 3000.00 kW | Peak power value. | 10 = 1 kW |
| 45.28 | <i>Daily peak power time</i> | Time of the peak power since midnight of the present day. | 00:00:00 |
| | | Time. | N/A |
| 45.29 | <i>Daily total energy (resettable)</i> | Total energy consumption since midnight of the present day. You can reset the value by setting it to zero. | 0.00 kWh |
| | -30000.00 ... 30000.00 kWh | Total energy. | 1 = 1 kWh |
| 45.30 | <i>Last day total energy</i> | Total energy consumption during the previous day, that is, between midnight of the previous day and midnight of the present day | 0.00 kWh |
| | -30000.00 ... 30000.00 kWh | Total energy. | 1 = 1 kWh |
| 45.31 | <i>Monthly peak power value (resettable)</i> | Value of the peak power during the present month, that is, since midnight of the first day of the present month. You can reset the value by setting it to zero. | 0.00 kW |
| | -3000.00 ... 3000.00 kW | Peak power value. | 10 = 1 kW |
| 45.32 | <i>Monthly peak power date</i> | Date of the peak power during the present month. | 1.1.1980 |
| | | Date. | N/A |
| 45.33 | <i>Monthly peak power time</i> | Time of the peak power during the present month. | 00:00:00 |
| | | Time. | N/A |
| 45.34 | <i>Monthly total energy (resettable)</i> | Total energy consumption from the beginning of the present month. You can reset the value by setting it to zero. | 0.00 kWh |
| | -1000000.00 ... 1000000.00 kWh | Total energy. | 0.01 = 1 kWh |
| 45.35 | <i>Last month total energy</i> | Total energy consumption during the previous month, that is, between midnight of the first day or the previous month and midnight of the first day of the present month. | 0.00 kWh |
| | -1000000.00 ... 1000000.00 kWh | | 0.01 = 1 kWh |
| 45.36 | <i>Lifetime peak power value</i> | Value of the peak power over the drive lifetime. | 0.00 kW |
| | -3000.00 ... 3000.00 kW | Peak power value. | 10 = 1 kW |



| Serial number | Name/Value | Description | Def/FbEq16 |
|---------------------------------------|---------------------------------------------------|-------------------------------------------------------------------------------------------------------------------------------------------------------------------------------------------------------------------------------------------------------------------------------------------------------------------------------------------------------------------------------------------------------------------------------------------------------------------------------------------------------------------------------------------|-----------------|
| 45.37 | <i>Lifetime peak power date</i> | Date of the peak power over the drive lifetime. | 1.1.1980 |
| | | Date. | N/A |
| 45.38 | <i>Lifetime peak power time</i> | Time of the peak power over the drive lifetime. | 00:00:00 |
| | | Time. | N/A |
| 46 Monitoring/scaling settings | | Speed supervision settings; actual signal filtering; general scaling settings. | |
| 46.01 | <i>Speed fieldbus scaled value</i> | Defines the 16-bit scaling of speed-related parameters. The value of this parameter corresponds to 20000 in eg. fieldbus communication. | 1500.00 rpm |
| | 0.10... 30000.00 rpm | Terminal/initial speed. | 1 = 1 rpm |
| 46.02 | <i>Frequency fieldbus scaled value</i> | Defines the maximum frequency value used to define the acceleration ramp rate and the initial frequency value used to define deceleration ramp rate (See parameter group 28 Frequency reference chain). The frequency acceleration and deceleration ramp times are therefore related to this value (not to parameter 30.14 Maximum frequency). Also defines the 16-bit scaling of frequency-related parameters. The value of this parameter corresponds to 20000 in eg. fieldbus communication. | 50.00 Hz |
| | 0.10...1,000.00 Hz | Acceleration/deceleration terminal/initial frequency. | 10 = 1 Hz |
| 46.03 | <i>Torque fieldbus scaled value</i> | Defines the 16-bit scaling of torque parameters. The value of this parameter (in percent of nominal motor torque) corresponds to 10000 in eg. Fieldbus communication. | 100.0% |
| | 0.1...1000.0% | Torque corresponding to 10000 on fieldbus. | 10 = 1% |
| 46.04 | <i>Power fieldbus scaled value</i> | Defines the output power value that corresponds to 10000 in eg. fieldbus communication. The unit is selected with parameter 96.16 unit selection . | 1000.0 kW or hp |
| | 0.1...30000.0 kW or 0.1...40214.5 hp | Power corresponding to 10000 on fieldbus. | 1 = 1 unit |
| 46.05 | <i>Current fieldbus scaled value</i> | Defines the 16-bit scaling of current parameters. The value of this parameter corresponds to 10000 in fieldbus communication. | 10000 A |
| | 0...30,000 A | | |
| 46.06 | <i>Zero-speed reference fieldbus scaled value</i> | The parameter defines that the rpm value given to the fieldbus in compliance with ABB drive communication protocol is zero. | |
| | 0.00 ... 30000.00 rpm | Default 0.00 rpm. | |
| 46.07 | <i>Frequency ref zero scaling</i> | Defines a frequency corresponding to a zero reference received from fieldbus (either the embedded fieldbus interface, or interface FBA). For example, with a setting of 30, the fieldbus reference range of 0...20000 would correspond to a speed of 30... 46.02 Hz. Note: This parameter is effective only with the ABB Drives communication profile. | 0.00 Hz |
| | 0.00 ... 1000.00 Hz | Frequency corresponding to minimum fieldbus reference. | 10 = 1 Hz |

| Serial number | Name/Value | Description | Def/FbEq16 |
|---------------|-------------------------------------|-------------------------------------------------------------------------------------------------------------------------------------------------------------------------------------------------------------------------------------------------------------------------------------------------------------------------------------------------------------------------------------|----------------------------|
| 46.11 | <i>Motor speed filter time</i> | Defines a filter time for signals <i>01.01 Motor speed</i> and <i>01.02 Motor speed (%)</i> . | 500 ms |
| | 2...20000 ms | Motor speed signal filter time. | 1 = 1 ms |
| 46.12 | <i>Filter time output frequency</i> | Defines a filter time for signal <i>01.06 Output frequency</i> . | 500 ms |
| | 2...20000 ms | Output frequency signal filter time. | 1 = 1 ms |
| 46.13 | <i>Filter time motor torque</i> | Defines a filter time for signal <i>01.10 Motor torque (%)</i> . | 100 ms |
| | 2...20000 ms | Motor torque signal filter time. | 1 = 1 ms |
| 46.14 | <i>Filter time power out</i> | Defines a filter time for signal <i>01.14 Output frequency</i> . | 100 ms |
| | 2...20000 ms | Output power signal filter time. | 1 = 1 ms |
| 46.22 | <i>Frequency arrival hysteresis</i> | Defines the "at setpoint" limits for frequency control of the drive. When the absolute difference between reference (<i>28.96 Frequency ref ramp input</i>) and (<i>28.02 Frequency ref ramp output</i>) is smaller than <i>46.22 Frequency arrival hysteresis</i> , the drive is considered to be "at setpoint". This is indicated by bit 8 of <i>06.11 Main status word</i> . | 2.00 Hz |
| | | | |
| | 0.00...1,000.00 Hz | Limit for "at setpoint" indication in frequency control. | See parameter <i>46.02</i> |
| 46.32 | <i>Upper limit of frequency</i> | Defines the trigger level for "above limit" indication in frequency control. When actual frequency exceeds the limit, bit 10 of <i>06.17 Drive status word 2</i> is set. | 0.00 Hz |
| | 0.00...1,000.00 Hz | "Above limit" indication trigger level for frequency control. | See parameter <i>46.02</i> |
| 46.41 | <i>kWh pulse scaling</i> | Defines the trigger level for the "kWh pulse" on for 50 ms. The output of the pulse is bit 9 of <i>05.22 Diagnostic word 3</i> . | 1.000 kWh |
| | 0.001...1000.000 kWh | "kWh pulse" on trigger level. | 1 = 1 kWh |
| 46.43 | <i>Power decimals</i> | Defines the number of display decimals places and 32-bit scaling of power-related parameters. The value of this parameter corresponds to the number of decimals assumed in the 32-bit integer fieldbus communication (for 16-bit scaling see <i>46.04 Power fieldbus scaled value</i>). | 2 |
| | 0...3 | Number of decimals. | 1 = 1 |

| Serial number | Name/Value | Description | Def/FbEq16 |
|------------------------|--------------------------------|-----------------------------------------------------------------------------------------------------------------------------------------------------------------------------------------------------------------------------------------------------------------------------------------|------------|
| 46.44 | <i>Current decimals</i> | Defines the number of display decimals places and 32-bit scaling of current-related parameters. The value of this parameter corresponds to the number of decimals assumed in the 32-bit integer fieldbus communication (for 16-bit scaling see 46.05 Current scaling). | 1 |
| | 0...3 | Number of decimals. | 1 = 1 |
| 47 Data storage | | Data storage parameters that can be written to and read from using other parameters' source and target settings. Note that there are different storage parameters for different data types. See also section Data storage parameters (page 95). | |
| 47.01 | <i>Data storage 1 real 32</i> | Data storage parameter 1. | 0.000 |
| | -2147483.000... 2147483.000 | 32-bit data. | - |
| 47.02 | <i>Data storage 2 real 32</i> | Data storage parameter 2. | 0.000 |
| | -2147483.000... 2147483.000 | 32-bit data. | - |
| 47.03 | <i>Data storage 3 real 32</i> | Data storage parameter 3. | 0.000 |
| | -2147483.000... 2147483.000 | 32-bit data. | - |
| 47.04 | <i>Data storage 4 real 32</i> | Data storage parameter 4. | 0.000 |
| | -2147483.000... 2147483.000 | 32-bit data. | - |
| 47.11 | <i>Data storage 1 int32</i> | Data storage parameter 9. | 0 |
| | -2147483648... 2147483647 | 32-bit data. | - |
| 47.12 | <i>Data storage 2 int32</i> | Data storage parameter 10. | 0 |
| | -2147483648... 2147483647 | 32-bit data. | - |
| 47.13 | <i>Data storage 3 int32</i> | Data storage parameter 11. | 0 |
| | -2147483648... 2147483647 | 32-bit data. | - |
| 47.14 | <i>Data storage 4 int32</i> | Data storage parameter 12. | 0 |
| | -2147483648... 2147483647 | 32-bit data. | - |
| 47.21 | <i>Data storage 1 int16</i> | Data storage parameter 17. | 0 |
| | -32768...32767 | 16-bit data. | 1 = 1 |
| 47.22 | <i>Data storage 2 int16</i> | Data storage parameter 18. | 0 |
| | -32768...32767 | 16-bit data. | 1 = 1 |

| Serial number | Name/Value | Description | Def/FbEq16 |
|------------------------------------|-----------------------------------------------------------------|----------------------------------------------------------------------------------------------------------------------------------------------------------------------------------------------------------------------------------------------------------------------------------------------------------------------------------------------------------------------------------------------------------|---------------------|
| 47.23 | <i>Data storage 3 int16</i> | Data storage parameter 19. | 0 |
| | -32768...32767 | 16-bit data. | 1 = 1 |
| 47.24 | <i>Data storage 4 int16</i> | Data storage parameter 20. | 0 |
| | -32768...32767 | 16-bit data. | 1 = 1 |
| 49 Panel port communication | | Communication settings for the control panel port on the drive. | |
| 49.01 | <i>Control panel communication transmission station address</i> | Defines the node ID of the drive. All devices connected to the network must have a unique node ID. Note: For networked drives, it is advisable to reserve ID 1 for spare/replacement drives. | 1 |
| | 1...32 | Node ID. | 1 = 1 |
| 49.03 | <i>Baud rate</i> | Defines the transfer rate of the link. | <i>115.2 kbps</i> |
| | 38.4 kbps | 38.4 kbit/s. | 1 |
| | 57.6 kbps | 57.6 kbit/s. | 2 |
| | 86.4 kbps | 86.4 kbit/s. | 3 |
| | 115.2 kbps | 115.2 kbit/s. | 4 |
| | 230.4 kbps | 230.4 kbit/s. | 5 |
| 49.04 | <i>Communication loss time-out</i> | Sets a timeout for control panel (or PC tool) communication. If a communication break lasts longer than the timeout, the action specified by parameter <i>49.05 Communication loss action</i> is taken. | 10.0 s |
| | 0.1...3000.0 s | Panel/PC tool communication time-out. | 10 = 1s |
| 49.05 | <i>Communication loss action</i> | Selects how the drive reacts to a control panel (or PC tool) communication break. | Fault |
| | No action | No action is taken. | 0 |
| | Fault | Drive trips on <i>7081 Control panel loss programmable fault: 49.05 Communication loss action</i> . | 1 |
| | End speed | Drive generates an warning <i>A7EE Control Panel loss</i> and freezes the speed to the level the drive was operating at. The speed is determined on the basis of actual speed using 850 ms low-pass filtering.  Warning! Make sure that it is safe to continue operation in case of a communication break.. | 2 |
| | Safe speed reference | Drive generates a <i>A7EE Control Panel loss</i> warning, when frequency reference is being used).  Warning! Make sure that it is safe to continue operation in case of a communication break.. | 3 |
| 49.06 | <i>Refresh</i> | Applies the settings of parameters <i>49.01...49.05</i> . Note: Refreshing may cause a communication break, so reconnecting the drive may be required. | <i>Finalization</i> |
| | Finalization | Refresh done or not requested. | 0 |
| | Configure | Refresh parameters <i>49.01...49.05</i> . The value reverts back to <i>Finalization</i> automatically. | 1 |

| Serial number | Name/Value | Description | Def/FbEq16 |
|----------------------------------|---------------------------------------------------|--------------------------------------------------------------------------------------------------------------------------------------------------------------------------------------------------------------------------------------------------------------------------------------------------------------------------------------------------------------------------------------------------------------------------------|------------------|
| 49.20 | Basic panel home view 2 | Selects the parameters that are shown in Home view 2 of the integrated or Basic control panel (ACS-BP-S) when the active external control location is EXT1. Home view 2 is toggled automatically between Home view 5 (parameter 49.220) according to the active external control location EXT1 or EXT2, respectively. For the selections, see parameter 49.19 Basic panel home view 1 . | <i>Auto</i> |
| 49.21 | Basic panel home view 3 | Selects the parameters that are shown in Home view 3 of the integrated or Basic control panel (ACS-BP-S) when the active external control location is EXT1. Home view 3 is toggled automatically between Home view 6 (parameter 49.221) according to the active external control location EXT1 or EXT2, respectively. For the selections, see parameter 49.19 Basic panel home view 1 . | <i>Auto</i> |
| 49.219 | Basic panel home view 4 | Selects the parameters that are shown in Home view 4 of the integrated or Basic control panel (ACS-BP-S) when the active external control location is EXT2. Home view 1 (parameter 49.19) is toggled automatically between Home view 4 according to the active external control location EXT1 or EXT2, respectively. For the selections, see parameter 49.19 Basic panel home view 1 . | <i>Auto</i> |
| 49.220 | Basic panel home view 5 | Selects the parameters that are shown in Home view 5 of the integrated or Basic control panel (ACS-BP-S) when the active external control location is EXT2. Home view 2 (parameter 49.20) is toggled automatically between Home view 5 according to the active external control location EXT1 or EXT2, respectively. For the selections, see parameter 49.19 Basic panel home view 1 . | <i>Auto</i> |
| 49.221 | Basic panel home view 6 | Selects the parameters that are shown in Home view 6 of the integrated or Basic control panel (ACS-BP-S) when the active external control location is EXT2. Home view 3 (parameter 49.21) is toggled automatically between Home view 6 according to the active external control location EXT1 or EXT2, respectively. For the selections, see parameter 49.19 Basic panel home view 1 . | <i>Auto</i> |
| 50 Fieldbus adapter (FBA) | | Fieldbus communication configuration. See also chapter Fieldbus control (page 311). | |
| 50.01 | FBA A Enable | Enables/disables communication between the drive and fieldbus adapter A, and specifies the slot the adapter is installed into. | Inhibited |
| | Inhibited | Communication between drive and fieldbus adapter A disabled. | 0 |
| | Enable | Communication between drive and fieldbus adapter A enabled. Adapter in slot 1. | 1 |
| 50.02 | FBA A communication loss function | Selects how the drive reacts upon a fieldbus communication break. Time delay is defined by parameter 50.03 FBA A communication loss time out . | <i>No action</i> |
| | No action | No action is taken. | 0 |

| Serial number | Name/Value | Description | Def/FbEq16 |
|---------------|------------------------------------------|--------------------------------------------------------------------------------------------------------------------------------------------------------------------------------------------------------------------------------------------------------------------------------------------------------------------------------------------------------------------------------------------------------------------------------------------------------------------------------------|--------------------|
| | Fault | Break detection active in Communication. Upon a communication break, the drive trips on a <i>7510 FBA A communication</i> fault and coasts to a stop. | 1 |
| | End speed | Break detection active in Communication. Upon a communication break, the drive generates a warning (<i>A7C1 FBA A communication</i>), and freezes the speed to the level the drive was operating at. The speed is determined on the basis of actual speed using 850 ms low-pass filtering.  Warning! Make sure that it is safe to continue operation in case of a communication break.. | 2 |
| | Safe speed reference | Break detection active in Communication. communication break, the drive generates a warning (<i>A7C1 FBA A communication</i>).  Warning! Make sure that it is safe to continue operation in case of a communication break.. | 3 |
| | Fault always | The drive trips due to the fault <i>7510 FBA A communication</i> . The fault will occur even if the fieldbus is not operated. | 4 |
| | Alarm | The drive gives warning: <i>A7C1 FBA A communication</i> . The fault will occur even if the fieldbus is not operated.  Warning! The warning is to ensure a safe operation for communication fault. | 5 |
| 50.03 | <i>FBA A communication loss time out</i> | Defines the time delay before the action defined by parameter <i>50.02 FBA A communication loss function</i> is taken. Time count starts when the communication link fails to update the message. | 0.3 s |
| | 0.3...6553.5 s | Time delay. | 1 = 1s |
| 50.04 | <i>FBA A Reference 1 type</i> | Selects the type and scaling of reference 1 received from fieldbus adapter A. The scaling of the reference is defined by parameters <i>46.01...46.04</i> , depending on which reference type is selected by this parameter. | Speed or Frequency |
| | Speed or Frequency | Frequency control. | 0 |
| | Transparent | No scaling is applied. | 1 |
| | General | Generic reference without a specific unit. | 2 |
| | Torque | The scaling is defined by parameter <i>46.03 Torque fieldbus scaled value</i> . | 3 |
| | Speed | The scaling is defined by parameter <i>46.01 Speed fieldbus scaled value</i> . | 4 |
| | Frequency | The scaling is defined by parameter <i>46.02 Frequency fieldbus scaled value</i> . | 5 |
| 50.05 | <i>FBA A Reference 2 type</i> | Selects the type and scaling of reference 2 received from fieldbus adapter A. The scaling of the reference is defined by parameters <i>46.01...46.04</i> , depending on which reference type is selected by this parameter. | Speed or Frequency |
| | Speed or Frequency | Frequency control. | 0 |
| | Transparent | No scaling is applied. | 1 |
| | General | Generic reference without a specific unit. | 2 |

| Serial number | Name/Value | Description | Def/FbEq16 |
|---------------|-------------------------------------|--------------------------------------------------------------------------------------------------------------------------------------------------------------------------------------------------------------------------------------------------------------------|--------------------|
| | Torque | The scaling is defined by parameter 46.03 Torque fieldbus scaled value . | 3 |
| | Speed | The scaling is defined by parameter 46.01 Speed fieldbus scaled value . | 4 |
| | Frequency | The scaling is defined by parameter 46.02 Frequency fieldbus scaled value . | 5 |
| 50.06 | FBA A SW selection | Selects the source of the Status word to be sent to the fieldbus network through fieldbus adapter A. | Automatic |
| | Automatic | Source of the Status word is chosen automatically. | 0 |
| | Transparent mode | The source selected by parameter 50.09 FBA A SW transparent source is transmitted as the Status word to the fieldbus network through fieldbus adapter A. | 1 |
| 50.07 | FBA A Actual 1 type | Selects the type and scaling of actual value 1 transmitted to the fieldbus network through fieldbus adapter A. The scaling of the value is defined by parameters 46.01...46.04 depending on which actual value type is selected by this parameter. | Speed or Frequency |
| | Speed or Frequency | Frequency control. | 0 |
| | Transparent | No scaling is applied. | 1 |
| | General | Generic reference without a specific unit. | 2 |
| | Torque | The scaling is defined by parameter 46.03 Torque fieldbus scaled value . | 3 |
| | Speed | The scaling is defined by parameter 46.01 Speed fieldbus scaled value . | 4 |
| | Frequency | The scaling is defined by parameter 46.02 Frequency fieldbus scaled value . | 5 |
| 50.08 | FBA A Actual 2 type | Selects the type and scaling of actual value 2 transmitted to the fieldbus network through fieldbus adapter A. The scaling of the value is defined by parameters 46.01...46.04 depending on which actual value type is selected by this parameter. | Speed or Frequency |
| | Speed or Frequency | Frequency control. | 0 |
| | Transparent | No scaling is applied. | 1 |
| | General | Generic reference without a specific unit. | 2 |
| | Torque | The scaling is defined by parameter 46.03 Torque fieldbus scaled value . | 3 |
| | Speed | The scaling is defined by parameter 46.01 Speed fieldbus scaled value . | 4 |
| | Frequency | The scaling is defined by parameter 46.02 Frequency fieldbus scaled value . | 5 |

272 *Parameter*

| Serial number | Name/Value | Description | Def/FbEq16 |
|---------------|-----------------------------------------------|----------------------------------------------------------------------------------------------------------------------------------------------------------------------------------------------------|--------------|
| 50.09 | <i>FBA A SW transparent source</i> | Selects the source of the fieldbus status word when parameter <i>50.06 FBA A SW selection</i> is set to <i>Transparent mode</i> . | Not selected |
| | Not selected | Source not selected. | - |
| | <i>Other</i> | Source selection (See <i>130 on page Terms and abbreviations</i>). | - |
| 50.10 | <i>FBA A Actual value 1 transparent value</i> | When parameter <i>50.07 FBA A Actual 1 type</i> is set to <i>Transparent</i> , this parameter selects the source of actual value 1 transmitted to the fieldbus network through fieldbus adapter A. | Not selected |
| | Not selected | Source not selected. | - |
| | <i>Other</i> | Source selection (See <i>130 on page Terms and abbreviations</i>). | - |
| 50.11 | <i>FBA A Actual value 2 transparent value</i> | When parameter <i>50.08 FBA A Actual 2 type</i> is set to <i>Transparent</i> , this parameter selects the source of actual value 2 transmitted to the fieldbus network through fieldbus adapter A. | Not selected |
| | Not selected | Source not selected. | - |
| | <i>Other</i> | Source selection (See <i>130 on page Terms and abbreviations</i>). | - |
| 50.12 | <i>FBA A debug mode</i> | Enables the display of raw (unmodified) data received from and sent to fieldbus adapter A in parameters <i>50.13...50.18</i> . This functionality should only be used for debugging. | Inhibited |
| | Inhibited | Display of raw data from fieldbus adapter A disabled. | 0 |
| | Enabled | Display of raw data from fieldbus adapter A enabled. | 1 |
| 50.13 | <i>FBA A Control Word</i> | Displays the raw (unmodified) control word sent by the master (PLC) to fieldbus adapter A if debugging is enabled by parameter <i>50.12 FBA A debug mode</i> . This parameter is read-only. | - |
| | 0000000h...FFFF FFFFh | Control word sent by master to fieldbus adapter A. | - |
| 50.14 | <i>FBA A reference 1</i> | Displays the raw (unmodified) reference REF1 sent by the master (PLC) to fieldbus adapter A if debugging is enabled by parameter <i>50.12 FBA A debug mode</i> . This parameter is read-only. | - |
| | -2147483648... 2147483647 | Raw REF1 sent by master to fieldbus adapter A. | - |
| 50.15 | <i>FBA A reference 2</i> | Displays the raw (unmodified) reference REF2 sent by the master (PLC) to fieldbus adapter A if debugging is enabled by parameter <i>50.12 FBA A debug mode</i> . This parameter is read-only. | - |
| | -2147483648... 2147483647 | Raw REF2 sent by master to fieldbus adapter A. | - |
| 50.16 | <i>FBA A Status Word</i> | Displays the raw (unmodified) status word sent by fieldbus adapter A to the master (PLC) if debugging is enabled by parameter <i>50.12 FBA A debug mode</i> . This parameter is read-only. | - |
| | 0000000h...FFFF FFFFh | Status word sent by fieldbus adapter A to master. | - |



| Serial number | Name/Value | Description | Def/FbEq16 |
|--------------------------|-----------------------------------|---------------------------------------------------------------------------------------------------------------------------------------------------------------------------------------------------------------------------------------------------------------------------------------------------------------------------------------------------------------------------------------------------------------------------------------------------------------------------------|--------------|
| 50.17 | <i>FBA A Actual value 1</i> | Displays raw (unmodified) actual value ACT1 sent by fieldbus adapter A to the master (PLC) if debugging is enabled by parameter 50.12 FBA A debug mode . This parameter is read-only. | - |
| | -2147483648... 2147483647 | Raw ACT1 sent by fieldbus adapter A to master. | - |
| 50.18 | <i>FBA A Actual value 2</i> | Displays raw (unmodified) actual value ACT1 sent by fieldbus adapter A to the master (PLC) if debugging is enabled by parameter 50.12 FBA A debug mode . This parameter is read-only. | - |
| | -2147483648... 2147483647 | Raw ACT2 sent by fieldbus adapter A to master. | - |
| 51 FBA A settings | | Fieldbus adapter A configuration | |
| 51.01 | <i>FBA A type</i> | Displays the type of the connected fieldbus adapter module. 0 = Module is not found or is not properly connected, or is disabled by parameter 50.01 FBA A Enable ; 0 = None; 1 = PROFIBUS-DP; 32 = CANopen; 37 = DeviceNet; 128 = Ethernet; 132 = PROFinet IO; 135 = EtherCAT; 136 = ETH Pwrlink; 485 = RS-485 comm; 101 = ControlNet; 47808=BAC net; This parameter is read-only. | - |
| 51.02 | <i>FBA A Par 2</i> | Parameters 51.02 ... 51.26 are adapter module-specific. For more information, see the documentation of the fieldbus adapter. Note that not all of these parameters are necessarily in use. | - |
| | 0...65535 | Fieldbus adapter configuration parameter. | 1 = 1 |
| ... | ... | ... | ... |
| 51.26 | <i>FBA A Par 26</i> | See parameter 51.02 FBA A Par 2 . | - |
| | 0...65535 | Fieldbus adapter configuration parameter. | 1 = 1 |
| 51.27 | <i>FBA A parameter update</i> | Validates any modified fieldbus adapter module configuration settings. After refreshing, the value reverts automatically to Finalization. Note: The parameter cannot be changed while the drive is running. | Finalization |
| | Finalization | Refreshing done. | 0 |
| | Configure | Refreshing. | 1 |
| 51.28 | <i>FBA A par table version</i> | Displays the parameter table revision of the fieldbus adapter module mapping file (stored in the memory of the drive). In format axyz, where ax = major table revision number; yz = minor table revision number. This parameter is read-only. | - |
| | | Parameter table revision of adapter module. | - |
| 51.29 | <i>FBA A drive type code</i> | Displays the drive type code in the fieldbus adapter module mapping file (stored in the memory of the drive). This parameter is read-only. | - |
| | 0...65535 | Drive type code stored in the mapping file. | 1 = 1 |
| 51.30 | <i>FBA A mapping file version</i> | Displays the fieldbus adapter module mapping file revision stored in the memory of the drive in decimal format. This parameter is read-only. | - |
| | 0...65535 | Mapping file revision. | 1 = 1 |

| Serial number | Name/Value | Description | Def/FbEq16 |
|-------------------------|---------------------------------------|--------------------------------------------------------------------------------------------------------------------------------------------------------------------------------------------------------------------------------------------------------------------------------|----------------|
| 51.31 | <i>FBA A communication status</i> | Displays the status of the fieldbus adapter module communication. | Not configured |
| | Not configured | Adapter not configured. | 0 |
| | Initializing | Adapter is initializing. | 1 |
| | Timed Out | A timeout has occurred in the communication between the adapter and the drive. | 2 |
| | Conf.err | Adapter configuration error: mapping file not found in the file system of the drive, or mapping file upload has failed more than three times. | 3 |
| | Off-line | Fieldbus communication is off-line. | 4 |
| | On-line | Fieldbus communication is on-line, or fieldbus adapter has not been configured to detect a communication break. For more information, see the documentation of the fieldbus adapter. | 5 |
| | Resetting | Adapter is performing a hardware reset. | 6 |
| 51.32 | <i>FBA A communication SW version</i> | Displays the common program revision of the adapter module in format axyz, where a = major revision number, xy = minor revision number, z = correction number or letter. Example: 190A = revision 1.90A. | |
| | | Common program revision of the adapter module. | - |
| 51.33 | <i>FBA A application SW version</i> | Displays the application program revision of the adapter module in format axyz, where a = major revision number, xy = minor revision number, z = correction number or letter. Example: 190A = revision 1.90A. | |
| | | Application program version of adapter module. | - |
| 52 FBA A data in | | Selection of data to be transferred from converter to fieldbus controller through fieldbus adapter A. Note: 32-bit values require two consecutive parameters. Whenever a 32-bit value is selected in a data parameter, the next parameter is automatically reserved. | |
| 52.01 | <i>FBA A data in 1</i> | Parameters 52.01...52.12 select data to be transferred from the drive to the fieldbus controller through fieldbus adapter A. | n/a |
| | n/a | n/a | 0 |
| | CW 16 bits | Control word (16 bit) | 1 |
| | Ref1 16bit | Reference REF1 (16 bit) | 2 |
| | Ref2 16bit | Reference REF1 (16 bit) | 3 |

| Serial number | Name/Value | Description | Def/FbEq16 |
|-----------------------------|--------------------------|---------------------------------------------------------------------------------------------------------------------------------------------------------------------------------------------------------------------------------------------------------------------------|------------|
| | SW 16 bits | Status word (16 bit) | 4 |
| | Act1 16bit | Actual value ACT1(16 bit) | 5 |
| | Act2 16bit | Actual value ACT1(16 bit) | 6 |
| | CW 32 bits | Control word (32 bit) | 11 |
| | Ref1 32bit | Reference REF1 (32 bit) | 12 |
| | Ref2 32bit | Reference REF1 (32 bit) | 13 |
| | SW 32 bits | Status word (32 bit) | 14 |
| | Act1 32bit | Actual value ACT1(32 bit) | 15 |
| | Act2 32bit | Actual value ACT1(32 bit) | 16 |
| | SW2 16bit | Status word (16 bit) | 24 |
| | <i>Other</i> | Source selection (See 130 on page Terms and abbreviations). | - |
| ... | ... | ... | ... |
| 52.12 | <i>FBA A data in 12</i> | See parameter 52.01 FBA A data in 1 . | n/a |
| 53 FBA A data out | | Selection of data to be transferred from fieldbus controller to drive through fieldbus adapter A Note: 32-bit values require two consecutive parameters. Whenever a 32-bit value is selected in a data parameter, the next parameter is automatically reserved. | |
| 53.01 | <i>FBA A data out 1</i> | Parameters 53.01 ... 53.12 select data to be transferred from the fieldbus controller to the drive through fieldbus adapter A. | n/a |
| | n/a | None. | 0 |
| | CW 16 bits | Control word (16 bit) | 1 |
| | Ref1 16bit | Reference REF1 (16 bit) | 2 |
| | Ref2 16bit | Reference REF1 (16 bit) | 3 |
| | CW 32 bits | Control word (32 bit) | 11 |
| | Ref1 32bit | Reference REF1 (32 bit) | 12 |
| | Ref2 32bit | Reference REF1 (32 bit) | 13 |
| | CW2 16bit | Control word 2 (16 bit) | 21 |
| | <i>Other</i> | Source selection (See 130 on page Terms and abbreviations). | - |
| | ... | ... | ... |
| 53.12 | <i>FBA A data out 12</i> | See parameter 53.01 FBA A data out 1 . | n/a |
| 58 Embedded fieldbus | | Configuration of the embedded fieldbus (EFB) interface. See also chapter Controlled through an embedded fieldbus interface (EFB) (page 311). | |
| 58.01 | <i>Protocol enable</i> | Enables/disables the embedded fieldbus interface and selects the protocol to use. | n/a |
| | n/a | None (communication disabled). | 0 |
| | Modbus RTU | Embedded fieldbus interface is enabled and uses the Modbus RTU protocol. | 1 |

| Serial number | Name/Value | Description | Def/FbEq16 |
|---------------|------------------------------|------------------------------------------------------------------------------------------------------------------------------------------------------------------------------------------------------------------------------------------------------------------------------------------------------------------------------|------------|
| 58.02 | <i>Protocol ID</i> | Displays the protocol ID and revision. This parameter is read-only. | - |
| | | Protocol ID and revision. | 1 = 1 |
| 58.03 | <i>Node address</i> | Defines the node address of the drive on the fieldbus link. Values 1...247 are allowable. Two devices with the same address are not allowed on-line. Changes to this parameter take effect after the control unit is rebooted or the new settings validated by parameter 58.06 Communication control . | 1 |
| | 0...255 | Node address (values 1...247 are allowable). | 1 = 1 |
| 58.04 | <i>Baud rate</i> | Selects the transfer rate of the fieldbus link. Changes to this parameter take effect after the control unit is rebooted or the new settings validated by parameter 58.06 Communication control . | 19.2 kbps |
| | Autotuning | 0 kbit/s. | 0 |
| | 4.8 kbps | 4.8 kbit/s. | 1 |
| | 9.6 kbps | 9.6 kbit/s. | 2 |
| | 19.2 kbps | 19.2 kbit/s. | 3 |
| | 38.4 kbps | 38.4 kbit/s. | 4 |
| | 57.6 kbps | 57.6 kbit/s. | 5 |
| | 76.8 kbps | 76.8 kbit/s. | 6 |
| | 115.2 kbps | 115.2 kbit/s. | 7 |
| 58.05 | <i>Parity</i> | Selects the type of parity bit, and number of stop bits. Changes to this parameter take effect after the control unit is rebooted or the new settings validated by parameter 58.06 Communication control . | 8 EVEN 1 |
| | 8 NONE 1 | Eight data bits, no parity bit, one stop bit. | 0 |
| | 8 NONE 2 | Eight data bits, no parity bit, two stop bits. | 1 |
| | 8 EVEN 1 | Eight data bits, even parity bit, one stop bit. | 2 |
| | 8 ODD 1 | Eight data bits, odd parity bit, one stop bit. | 3 |
| 58.06 | <i>Communication control</i> | Takes changed EFB settings in use, or activates silent mode. | Enabled |
| | Enabled | Normal operation. | 0 |
| | Refresh settings | Refreshes settings (parameters 58.01...58.05,58.14...58.17, 58.25,58.28...58.34) and takes changed EFB configuration settings in use. | 1 |
| | Standstill mode | Activates silent mode (no messages are transmitted). Silent mode can be terminated by activating the Refresh settings selection of this parameter. | 2 |

| Serial number | Name/Value | Description | Def/FbEq16 | | | | | | | | | | | | | | | | | | | | | | | | | | | | | | | | | | | | | | | | | | | | | | | | | | | |
|---------------|----------------------------------|----------------------------------------------------------------------------------------------------------------------------------------------------------------------------------------------------------------------------------------------------------------------------------------------------------------------------------------------------------------------------------------------------------------------------------------------------------------------------------------------------------------------------------------------------------------------------------------------------------------------------------------------------------------------------------------------------------------------------------------------------------------------------------------------------------------------------------------------------------------------------------------------------------------------------------------------------------------------------------------------------------------------------------------------------------------------------------------------------------------------------------------------------------------------------------------------------------------------------------------------------------------------------------------------------------------------------------------------------------------------------------------------------------------------------------------------------------------------------------------------------------------------------------------------------------------------------------------------------------------------------------------------------------------------------------------------------------------------------------------------------------------------------------------------------------------------------------------------------------------------------------------------------------------------------|------------|------|-------------|---|-------------|-------------------------------|---|-----------------|------------------------------------------|---|-------------|--------------------------------------------------------------------|---|------------|----------------------------------------------------------------------|---|--------------|--------------------------------------------------|---|--------------|--------------------------------------------------------------------------------------|---|-----------------|--------------------------------------------------------------------------------------|---|----------------------|--------------------------------------------|---|------------|------------------------------------------------------------------------|---|----------------------------|-------------------------------------------------------------------------------------|----|--------------------|----------------------------------------------------------------------------------------|----|-------------|-------------------------------------------------------------------------------------|----|----------|---------|----|------------|---|----|------------|---|----|----------------|-------------------------------------------------|--|
| 58.07 | <i>Communication diagnostics</i> | Displays the status of the EFB communication. This parameter is read-only. Note that the name is only visible when the error is present (bit value is 1). | - | | | | | | | | | | | | | | | | | | | | | | | | | | | | | | | | | | | | | | | | | | | | | | | | | | | |
| | | <table border="1"> <thead> <tr> <th>Bit(s)</th> <th>Name</th> <th>Description</th> </tr> </thead> <tbody> <tr> <td>0</td> <td>Init failed</td> <td>1 = EFB initialization failed</td> </tr> <tr> <td>1</td> <td>Addr config err</td> <td>1 = Node address not allowed by protocol</td> </tr> <tr> <td>2</td> <td>Silent mode</td> <td>1 = Drive not allowed to transmit 0 = Drive allowed to transmit</td> </tr> <tr> <td>3</td> <td>Autodetect</td> <td>1 = Autodetect in progress: EFB is trying to determine the baud rate</td> </tr> <tr> <td>4</td> <td>Wiring error</td> <td>1 = Errors detected (A/B wires possibly swapped)</td> </tr> <tr> <td>5</td> <td>Parity error</td> <td>1 = Error detected: check parameters 58.04 and 58.05</td> </tr> <tr> <td>6</td> <td>Baud rate error</td> <td>1 = Error detected: check parameters 58.05 and 58.04</td> </tr> <tr> <td>7</td> <td>No fieldbus response</td> <td>1 = 0 bytes received during last 5 seconds</td> </tr> <tr> <td>8</td> <td>No packets</td> <td>1 = 0 packets (addressed to any device) detected during last 5 seconds</td> </tr> <tr> <td>9</td> <td>Noise or addressing repeat</td> <td>1 = Errors detected (interference, or another device with the same address on line)</td> </tr> <tr> <td>10</td> <td>Communication lost</td> <td>1 = 0 packets addressed to the drive received within timeout (58.16)</td> </tr> <tr> <td>11</td> <td>CW/Ref loss</td> <td>1 = No control word or references received within timeout (58.16)</td> </tr> <tr> <td>12</td> <td>Inactive</td> <td>Reserve</td> </tr> <tr> <td>13</td> <td>Protocol 1</td> <td>-</td> </tr> <tr> <td>14</td> <td>Protocol 2</td> <td>-</td> </tr> <tr> <td>15</td> <td>internal error</td> <td>1 = Problem with calls to drive control program</td> </tr> </tbody> </table> | Bit(s) | Name | Description | 0 | Init failed | 1 = EFB initialization failed | 1 | Addr config err | 1 = Node address not allowed by protocol | 2 | Silent mode | 1 = Drive not allowed to transmit 0 = Drive allowed to transmit | 3 | Autodetect | 1 = Autodetect in progress: EFB is trying to determine the baud rate | 4 | Wiring error | 1 = Errors detected (A/B wires possibly swapped) | 5 | Parity error | 1 = Error detected: check parameters 58.04 and 58.05 | 6 | Baud rate error | 1 = Error detected: check parameters 58.05 and 58.04 | 7 | No fieldbus response | 1 = 0 bytes received during last 5 seconds | 8 | No packets | 1 = 0 packets (addressed to any device) detected during last 5 seconds | 9 | Noise or addressing repeat | 1 = Errors detected (interference, or another device with the same address on line) | 10 | Communication lost | 1 = 0 packets addressed to the drive received within timeout (58.16) | 11 | CW/Ref loss | 1 = No control word or references received within timeout (58.16) | 12 | Inactive | Reserve | 13 | Protocol 1 | - | 14 | Protocol 2 | - | 15 | internal error | 1 = Problem with calls to drive control program | |
| Bit(s) | Name | Description | | | | | | | | | | | | | | | | | | | | | | | | | | | | | | | | | | | | | | | | | | | | | | | | | | | | |
| 0 | Init failed | 1 = EFB initialization failed | | | | | | | | | | | | | | | | | | | | | | | | | | | | | | | | | | | | | | | | | | | | | | | | | | | | |
| 1 | Addr config err | 1 = Node address not allowed by protocol | | | | | | | | | | | | | | | | | | | | | | | | | | | | | | | | | | | | | | | | | | | | | | | | | | | | |
| 2 | Silent mode | 1 = Drive not allowed to transmit 0 = Drive allowed to transmit | | | | | | | | | | | | | | | | | | | | | | | | | | | | | | | | | | | | | | | | | | | | | | | | | | | | |
| 3 | Autodetect | 1 = Autodetect in progress: EFB is trying to determine the baud rate | | | | | | | | | | | | | | | | | | | | | | | | | | | | | | | | | | | | | | | | | | | | | | | | | | | | |
| 4 | Wiring error | 1 = Errors detected (A/B wires possibly swapped) | | | | | | | | | | | | | | | | | | | | | | | | | | | | | | | | | | | | | | | | | | | | | | | | | | | | |
| 5 | Parity error | 1 = Error detected: check parameters 58.04 and 58.05 | | | | | | | | | | | | | | | | | | | | | | | | | | | | | | | | | | | | | | | | | | | | | | | | | | | | |
| 6 | Baud rate error | 1 = Error detected: check parameters 58.05 and 58.04 | | | | | | | | | | | | | | | | | | | | | | | | | | | | | | | | | | | | | | | | | | | | | | | | | | | | |
| 7 | No fieldbus response | 1 = 0 bytes received during last 5 seconds | | | | | | | | | | | | | | | | | | | | | | | | | | | | | | | | | | | | | | | | | | | | | | | | | | | | |
| 8 | No packets | 1 = 0 packets (addressed to any device) detected during last 5 seconds | | | | | | | | | | | | | | | | | | | | | | | | | | | | | | | | | | | | | | | | | | | | | | | | | | | | |
| 9 | Noise or addressing repeat | 1 = Errors detected (interference, or another device with the same address on line) | | | | | | | | | | | | | | | | | | | | | | | | | | | | | | | | | | | | | | | | | | | | | | | | | | | | |
| 10 | Communication lost | 1 = 0 packets addressed to the drive received within timeout (58.16) | | | | | | | | | | | | | | | | | | | | | | | | | | | | | | | | | | | | | | | | | | | | | | | | | | | | |
| 11 | CW/Ref loss | 1 = No control word or references received within timeout (58.16) | | | | | | | | | | | | | | | | | | | | | | | | | | | | | | | | | | | | | | | | | | | | | | | | | | | | |
| 12 | Inactive | Reserve | | | | | | | | | | | | | | | | | | | | | | | | | | | | | | | | | | | | | | | | | | | | | | | | | | | | |
| 13 | Protocol 1 | - | | | | | | | | | | | | | | | | | | | | | | | | | | | | | | | | | | | | | | | | | | | | | | | | | | | | |
| 14 | Protocol 2 | - | | | | | | | | | | | | | | | | | | | | | | | | | | | | | | | | | | | | | | | | | | | | | | | | | | | | |
| 15 | internal error | 1 = Problem with calls to drive control program | | | | | | | | | | | | | | | | | | | | | | | | | | | | | | | | | | | | | | | | | | | | | | | | | | | | |
| | 0000h...FFFFh | EFB communication status. | 1 = 1 | | | | | | | | | | | | | | | | | | | | | | | | | | | | | | | | | | | | | | | | | | | | | | | | | | | |
| 58.08 | <i>Received packets</i> | Displays a count of valid packets addressed to the drive. During normal operation, this number increases constantly. Reset from the control panel by keeping Reset down for over 3 seconds. | - | | | | | | | | | | | | | | | | | | | | | | | | | | | | | | | | | | | | | | | | | | | | | | | | | | | |
| | 0...4294967295 | Number of received packets addressed to the drive. | 1 = 1 | | | | | | | | | | | | | | | | | | | | | | | | | | | | | | | | | | | | | | | | | | | | | | | | | | | |
| 58.09 | <i>Transmitted packets</i> | Displays a count of valid packets transmitted by the drive. During normal operation, this number increases constantly. Reset from the control panel by keeping Reset down for over 3 seconds. | - | | | | | | | | | | | | | | | | | | | | | | | | | | | | | | | | | | | | | | | | | | | | | | | | | | | |
| | 0...4294967295 | Number of transmitted packets. | 1 = 1 | | | | | | | | | | | | | | | | | | | | | | | | | | | | | | | | | | | | | | | | | | | | | | | | | | | |
| 58.10 | <i>All packets</i> | Displays a count of valid packets addressed to any device on the bus. During normal operation, this number increases constantly. Reset from the control panel by keeping Reset down for over 3 seconds. | - | | | | | | | | | | | | | | | | | | | | | | | | | | | | | | | | | | | | | | | | | | | | | | | | | | | |
| | 0...4294967295 | Number of all received packets. | 1 = 1 | | | | | | | | | | | | | | | | | | | | | | | | | | | | | | | | | | | | | | | | | | | | | | | | | | | |

| Serial number | Name/Value | Description | Def/FbEq16 |
|---------------|----------------------------------|----------------------------------------------------------------------------------------------------------------------------------------------------------------------------------------------------------------------------------------------------------------------------------------------------------------------------------------------------------------------------------------------------------------------------------------------------------------|-------------|
| 58.11 | <i>UART errors</i> | Displays a count of character errors received by the drive. An increasing count indicates a configuration problem on the bus. Reset from the control panel by keeping Reset down for over 3 seconds. | - |
| | 0...4294967295 | Number of UART errors. | 1 = 1 |
| 58.12 | <i>CRC errors</i> | Displays a count of packets with a CRC error received by the drive. An increasing count indicates interference on the bus. Reset from the control panel by keeping Reset down for over 3 seconds. | - |
| | 0...4294967295 | Number of CRC errors. | 1 = 1 |
| 58.14 | <i>Communication loss action</i> | Selects how the drive reacts to an EFB communication break. Changes to this parameter take effect after the control unit is rebooted or the new settings validated by parameter 58.06 Communication control . See also parameters 58.15 Communication loss mode and 58.16 Communication loss time . | n/a |
| | n/a | No action taken (monitoring disabled). | 0 |
| | Fault | Drive trips on 6681 EFB Communication loss . This only occurs if control is expected from the EFB. | 1 |
| | Operation at end speed | Drive generates an A7CE EFB comm loss and freezes the speed to the level the drive was operating at. The speed is determined on the basis of actual speed using 850 ms low-pass filtering. This only occurs if control is expected from the EFB.  Warning! Make sure that it is safe to continue operation in case of a communication break.. | 2 |
| | Safe speed reference | Drive generates an A7CE EFB comm loss warning and sets the speed to the speed defined by parameter 28.41 Reference of safe frequency , when frequency reference is being used). This only occurs if control is expected from the EFB.  Warning! Make sure that it is safe to continue operation in case of a communication break.. | 3 |
| | Fault always | Drive trips on 6681 EFB Communication loss . This occurs even though no control is expected from the EFB. | 4 |
| | Alarm | - | 5 |
| 58.15 | <i>Communication loss mode</i> | Defines which message types reset the timeout counter for detecting an EFB communication loss. Changes to this parameter take effect after the control unit is rebooted or the new settings validated by parameter 58.06 Communication control . See also parameters 58.14 Communication loss action and 58.16 Communication loss time . | Any message |
| | Any message | Any message addressed to the drive resets the timeout. | 1 |
| | Cw / Ref1 / Ref2 | A write of the control word or a reference resets the timeout. | 2 |

| Serial number | Name/Value | Description | Def/FbEq16 |
|---------------|--------------------------------|--------------------------------------------------------------------------------------------------------------------------------------------------------------------------------------------------------------------------------------------------------------------------------------------------------------------------------------------------------------------------------------------------------------------------------|--------------------|
| 58.16 | <i>Communication loss time</i> | Sets a timeout for EFB communication. If a communication break lasts longer than the timeout, the action specified by parameter 58.14 Communication loss action is taken. Changes to this parameter take effect after the control unit is rebooted or the new settings validated by parameter 58.06 Communication control . See also parameter 58.15 Communication loss mode . | 60.0 s |
| | 0.0...6000.0 s | EFB communication timeout. | 1 = 1 |
| 58.17 | <i>Transmit delay</i> | Defines a minimum response delay in addition to any fixed delay imposed by the protocol. Changes to this parameter take effect after the control unit is rebooted or the new settings validated by parameter 58.06 Communication control . | 0 ms |
| | 0...65535 ms | Minimum response delay. | 1 = 1 |
| 58.18 | <i>EFB control word</i> | Displays the raw (unmodified) control word for debugging purposes. This parameter is read-only. | - |
| | 0000h...FFFFh | Control word. | 1 = 1 |
| 58.19 | <i>EFB status word</i> | Displays the raw (unmodified) status word for debugging purposes. This parameter is read-only. | - |
| | 0000h...FFFFh | Status word. | 1 = 1 |
| 58.25 | <i>Profile</i> | Defines the communication profile used by the protocol. Changes to this parameter take effect after the control unit is rebooted or the new settings validated by parameter 58.06 Communication control . | ABB Drives |
| | ABB Drives | ABB Drives control profile (with a 16-bit control word) | 0 |
| | DCU Profile | DCU control profile (16 or 32-bit control word) | 5 |
| 58.26 | <i>EFB ref1 type</i> | Selects the type of reference 1. The scaled references are shown by parameters 03.09 EFB reference 1 . | Speed or Frequency |
| | Speed or Frequency | Frequency control. | 0 |
| | Transparent | No scaling is applied. | 1 |
| | General | Generic reference without a specific unit. Scaling:1 = 100. | 2 |
| | Torque | Torque reference. The scaling is defined through parameter 46.03 Torque fieldbus scaled value . | 3 |
| | Speed | Speed reference. The scaling is defined through parameter 46.01 Speed fieldbus scaled value . | 4 |
| | Frequency | Frequency reference. The scaling is defined through parameter 46.02 Frequency fieldbus scaled value . | 5 |
| 58.27 | <i>EFB ref 2 type</i> | Selects the type of reference 2. For selections, See parameter 03.10 EFB reference 2 . | Torque |
| 58.28 | <i>EFB actual value 1 type</i> | Selects the type of actual value 1. | Speed or frequency |

| Serial number | Name/Value | Description | Def/FbEq16 |
|---------------|---------------------------------------------|-------------------------------------------------------------------------------------------------------------------------------------------------------------------------------------------------------------------------------------------------------------------------------------------------------------------------------------------------------------------------------------------------------------------------------------------------|--------------------|
| | Speed or frequency | Frequency control. | 0 |
| | Transparent | No scaling is applied. | 1 |
| | General | Generic reference without a specific unit. Scaling:1 = 100. | 2 |
| | Torque | The scaling is defined through parameter 46.03 Torque fieldbus scaled value . | 3 |
| | Speed | The scaling is defined through parameter 46.01 Speed fieldbus scaled value . | 4 |
| | Frequency | The scaling is defined through parameter 46.02 Frequency fieldbus scaled value . | 5 |
| 58.29 | EFB actual value 2 type | Selects the type of actual value 2. For selections, see parameter 58.26 EFB ref1 type . | Speed or frequency |
| 58.31 | EFB act1 transparent source | Selects the source of actual value 1 when in transparent mode. | Not selected |
| | Not selected | None. | 0 |
| | <i>Other</i> | Source selection (See 130 on page Terms and abbreviations). | - |
| 58.32 | EFB act2 transparent source | Selects the source of actual value 1 when in transparent mode. | Not selected |
| | Not selected | n/a | 0 |
| | <i>Other</i> | Source selection (See 130 on page Terms and abbreviations). | - |
| 58.33 | Addressing mode | Defines the mapping between parameters and holding registers in the 100...65535 Modbus register range. Changes to this parameter take effect after the control unit is rebooted or the new settings validated by parameter 58.06 Communication control . | Mode 0 |
| | Mode 0 | 16-bit values (groups 1...99, indexes 1...99): Register address = 400000 + 100 × parameter group + parameter index. For example, parameter 22.80 would be mapped to register 400000 + 2200 + 80 = 402280. 32-bit values (groups 1...99, indexes 1...99): Register address = 420000 + 200 × parameter group + 2 × parameter index. For example, parameter 22.80 would be mapped to register 420000 + 4400 + 160 = 424560. | 0 |
| | Mode 1 | 16-bit values (groups 1...255, indexes 1...255): Register address = 400000 + 256 × parameter group + parameter index. For example, parameter 22.80 would be mapped to register 400000 + 5632 + 80 = 405712. | 1 |
| | Mode 2 | 32-bit values (groups 1...127, indexes 1...255): Register address = 400000 + 512 × parameter group + 2 × parameter index. For example, parameter 22.80 would be mapped to register 400000 + 11264 + 160 = 411424. | 2 |

| Serial number | Name/Value | Description | Def/FbEq16 |
|---------------|-----------------------|-------------------------------------------------------------------------------------------------------------------------------------------------------------------------------------------------------------------------------------------------------------------------------------------------------------------------------------------------------------------------------------------------------------------------------------------------------------------|--------------------|
| 58.34 | <i>Word order</i> | Selects in which order the 16-bit registers of 32-bit parameters are transferred. For each register, the first byte contains the high order byte and the second byte contains the low order byte. Changes to this parameter take effect after the control unit is rebooted or the new settings validated by parameter 58.06 Communication control . | Low - High |
| | High - Low | The first register contains the high order word, the second contains the low order word. | 0 |
| | Low - High | The first register contains the low order word, the second contains the high order word. | 1 |
| 58.101 | <i>Data I/O 1</i> | Defines the address in the drive which the Modbus master accesses when it reads from or writes to the register address corresponding to Modbus I/O parameter 1. The master defines the type of the data (input or output). The value is transmitted in a Modbus frame consisting of two 16-bit words. If the value is 16-bit, it is transmitted in the LSW (least significant word). If the value is 32-bit, the subsequent parameter is also reserved for it. | CW 16 bit |
| | n/a | n/a | 0 |
| | CW 16 bit | Control word (16 bit) | 1 |
| | Ref1 16 bit | Reference REF1 (16 bit) | 2 |
| | Ref2 16 bit | Reference REF1 (16 bit) | 3 |
| | SW 16 bit | Status word (16 bit) | 4 |
| | Act1 16 bit | Actual value ACT1(16 bit) | 5 |
| | Act2 16 bit | Actual value ACT1(16 bit) | 6 |
| | CW 32 bit | Control word (32 bit) | 11 |
| | Ref1 32bit | Reference REF1 (32 bit) | 12 |
| | Ref2 32bit | Reference REF1 (32 bit) | 13 |
| | SW 32 bit | Status word (32 bit) | 14 |
| | Act1 32bit | Actual value ACT1(32 bit) | 15 |
| | Act2 32bit | Actual value ACT1(32 bit) | 16 |
| | CW2 16bit | Control word 2 (16 bit) | 21 |
| | SW2 16bit | Status word (16 bit) | 24 |
| | RO/DIO control word | Parameter 10.99 RO/DIO control word . | 31 |
| | AO1 data storage | Parameter 13.91 AO1 data storage . | 32 |
| | AO2 data storage | Parameter 13.92 AO2 data storage . | 33 |
| | Feedback data storage | Parameter 40.91 Feedback data storage . | 40 |
| | Setpoint data storage | Parameter 40.92 Setpoint data storage . | 41 |
| | Other | Source selection (See 130 on page Terms and abbreviations). | - |
| 58.102 | <i>Data I/O 2</i> | Defines the address in the drive which the Modbus master accesses when it reads from or writes to register address 400002. For selections, see parameter 58.101 Data I/O 1 . | <i>Ref1 16 bit</i> |

| Serial number | Name/Value | Description | Def/FbEq16 | | | | | | | | | | | | | | | | | | | | | | | | | | | | | | | | | | | | | | | |
|----------------------------------------------------------------------------------------------------------------------------------------------------------------------------------------------------------------------------------------------------------------------------------------------------------------------------------------------------------------------------------------------------------------------------------------------------------------------------------------------------------------------------------------------------------------------------------------------------------------------------------------------------------------------------------------------------------------------------------------------------------------------------------------------------------------------------------------------------------------------------------------------------------------------------------------------------------------------------------------------------------------------------------------------------------------------------------------------------------------------------------------------------------------------------------------------------------------------------------------------------------------------------------------------------------------------------------------------------------------------------------------------------------------------------------------|-------------------------------|--------------------------------------------------------------------------------------------------------------------------------------------------------------------------------|-------------|-----|------|-------------|---|------------------|----------------------------------------------------|---|-----------------|------------------------------------------------|---|-------------------------------|---------------------------------------------------------------------------|---|-------------------------------|---------------------------------------------------------------------------|---|------------------------------|-------------------------------------------------------------------------|-------|----------|--|---|----------------|--------------------------------------------|---|-------------------|----------------------------------------------|---|-------------------|----------------------------------------------|----|-------------------|----------------------------------------------|----|-------------------|----------------------------------------------|---------|----------|--|
| 58.103 | Data I/O 3 | Defines the address in the drive which the Modbus master accesses when it reads from or writes to register address 400003. For selections, see parameter 58.101 Data I/O 1. | Ref2 16 bit | | | | | | | | | | | | | | | | | | | | | | | | | | | | | | | | | | | | | | | |
| 58.104 | Data I/O 4 | Defines the address in the drive which the Modbus master accesses when it reads from or writes to register address 400004. For selections, see parameter 58.101 Data I/O 1. | SW 16 bit | | | | | | | | | | | | | | | | | | | | | | | | | | | | | | | | | | | | | | | |
| 58.105 | Data I/O 5 | Defines the address in the drive which the Modbus master accesses when it reads from or writes to register address 400005. For selections, see parameter 58.101 Data I/O 1. | n/a | | | | | | | | | | | | | | | | | | | | | | | | | | | | | | | | | | | | | | | |
| 58.106 | Data I/O 6 | Defines the address in the drive which the Modbus master accesses when it reads from or writes to register address 400006. For selections, see parameter 58.101 Data I/O 1. | n/a | | | | | | | | | | | | | | | | | | | | | | | | | | | | | | | | | | | | | | | |
| 58.107 | Data I/O 7 | Parameter selector for Modbus register address 400007. For selections, see parameter 58.101 Data I/O 1. | n/a | | | | | | | | | | | | | | | | | | | | | | | | | | | | | | | | | | | | | | | |
| ... | ... | ... | ... | | | | | | | | | | | | | | | | | | | | | | | | | | | | | | | | | | | | | | | |
| 58.114 | Data I/O 14 | Parameter selector for Modbus register address 400030. For selections, see parameter 58.101 Data I/O 1. | n/a | | | | | | | | | | | | | | | | | | | | | | | | | | | | | | | | | | | | | | | |
| 70 Override | | Enabling/disabling of the Override function, Override activation signal and Override speed/frequency. See control chain diagram. | | | | | | | | | | | | | | | | | | | | | | | | | | | | | | | | | | | | | | | | |
| 70.01 | Override status | Shows the override status. This parameter is read-only. | - | | | | | | | | | | | | | | | | | | | | | | | | | | | | | | | | | | | | | | | |
| <table border="1"> <thead> <tr> <th>Bit</th> <th>Name</th> <th>Description</th> </tr> </thead> <tbody> <tr> <td>0</td> <td>Override enabled</td> <td>0 = Override is disabled; 1 = Override is enabled.</td> </tr> <tr> <td>1</td> <td>Override active</td> <td>0 = Override is inactive; 1 = Drive is active.</td> </tr> <tr> <td>2</td> <td>Override direction is forward</td> <td>0 = Override direction is not forward; 1 = Override direction is forward.</td> </tr> <tr> <td>3</td> <td>Override direction is reverse</td> <td>0 = Override direction is not reverse; 1 = Override direction is reverse.</td> </tr> <tr> <td>4</td> <td>Override stop mode is active</td> <td>0 = Override stop mode is not active; 1 = Override stop mode is active.</td> </tr> <tr> <td>5...6</td> <td>Reserved</td> <td></td> </tr> <tr> <td>7</td> <td>Run permissive</td> <td>0 = Prevents running; 1 = Permits running.</td> </tr> <tr> <td>8</td> <td>Start interlock 1</td> <td>0 = Prevents starting; 1 = Permits starting.</td> </tr> <tr> <td>9</td> <td>Start interlock 2</td> <td>0 = Prevents starting; 1 = Permits starting.</td> </tr> <tr> <td>10</td> <td>Start interlock 3</td> <td>0 = Prevents starting; 1 = Permits starting.</td> </tr> <tr> <td>11</td> <td>Start interlock 4</td> <td>0 = Prevents starting; 1 = Permits starting.</td> </tr> <tr> <td>12...15</td> <td>Reserved</td> <td></td> </tr> </tbody> </table> | | | | Bit | Name | Description | 0 | Override enabled | 0 = Override is disabled; 1 = Override is enabled. | 1 | Override active | 0 = Override is inactive; 1 = Drive is active. | 2 | Override direction is forward | 0 = Override direction is not forward; 1 = Override direction is forward. | 3 | Override direction is reverse | 0 = Override direction is not reverse; 1 = Override direction is reverse. | 4 | Override stop mode is active | 0 = Override stop mode is not active; 1 = Override stop mode is active. | 5...6 | Reserved | | 7 | Run permissive | 0 = Prevents running; 1 = Permits running. | 8 | Start interlock 1 | 0 = Prevents starting; 1 = Permits starting. | 9 | Start interlock 2 | 0 = Prevents starting; 1 = Permits starting. | 10 | Start interlock 3 | 0 = Prevents starting; 1 = Permits starting. | 11 | Start interlock 4 | 0 = Prevents starting; 1 = Permits starting. | 12...15 | Reserved | |
| Bit | Name | Description | | | | | | | | | | | | | | | | | | | | | | | | | | | | | | | | | | | | | | | | |
| 0 | Override enabled | 0 = Override is disabled; 1 = Override is enabled. | | | | | | | | | | | | | | | | | | | | | | | | | | | | | | | | | | | | | | | | |
| 1 | Override active | 0 = Override is inactive; 1 = Drive is active. | | | | | | | | | | | | | | | | | | | | | | | | | | | | | | | | | | | | | | | | |
| 2 | Override direction is forward | 0 = Override direction is not forward; 1 = Override direction is forward. | | | | | | | | | | | | | | | | | | | | | | | | | | | | | | | | | | | | | | | | |
| 3 | Override direction is reverse | 0 = Override direction is not reverse; 1 = Override direction is reverse. | | | | | | | | | | | | | | | | | | | | | | | | | | | | | | | | | | | | | | | | |
| 4 | Override stop mode is active | 0 = Override stop mode is not active; 1 = Override stop mode is active. | | | | | | | | | | | | | | | | | | | | | | | | | | | | | | | | | | | | | | | | |
| 5...6 | Reserved | | | | | | | | | | | | | | | | | | | | | | | | | | | | | | | | | | | | | | | | | |
| 7 | Run permissive | 0 = Prevents running; 1 = Permits running. | | | | | | | | | | | | | | | | | | | | | | | | | | | | | | | | | | | | | | | | |
| 8 | Start interlock 1 | 0 = Prevents starting; 1 = Permits starting. | | | | | | | | | | | | | | | | | | | | | | | | | | | | | | | | | | | | | | | | |
| 9 | Start interlock 2 | 0 = Prevents starting; 1 = Permits starting. | | | | | | | | | | | | | | | | | | | | | | | | | | | | | | | | | | | | | | | | |
| 10 | Start interlock 3 | 0 = Prevents starting; 1 = Permits starting. | | | | | | | | | | | | | | | | | | | | | | | | | | | | | | | | | | | | | | | | |
| 11 | Start interlock 4 | 0 = Prevents starting; 1 = Permits starting. | | | | | | | | | | | | | | | | | | | | | | | | | | | | | | | | | | | | | | | | |
| 12...15 | Reserved | | | | | | | | | | | | | | | | | | | | | | | | | | | | | | | | | | | | | | | | | |
| 70.02 | Override enable | Enables the Override function. | Off | | | | | | | | | | | | | | | | | | | | | | | | | | | | | | | | | | | | | | | |
| | Off | Override disabled. | 0 | | | | | | | | | | | | | | | | | | | | | | | | | | | | | | | | | | | | | | | |
| | On | Override enabled. | 1 | | | | | | | | | | | | | | | | | | | | | | | | | | | | | | | | | | | | | | | |

| Serial number | Name/Value | Description | Def/FbEq16 |
|---------------|-----------------------------------|---------------------------------------------------------------------------------------------------------------------------------------------------------------------------------|----------------------------|
| 70.03 | <i>Override activation source</i> | Selects the source of the Override activation. Value 0 of the source deactivates the Override. Value 1 of the source activates the Override. | <i>Not used</i> |
| | Not used | 0. | 0 |
| | Constant speed | Bit 7 of <i>06.19 Speed control status word</i> (see page 143). | 13 |
| | <i>Other [bit]</i> | Source selection (see <i>Terms and abbreviations</i> on page 130). | - |
| 70.04 | <i>Override reference source</i> | Selects the source for the speed used in the Override mode. | <i>Override speed/freq</i> |
| | Constant speed | Constant speed used as the reference. | 0 |
| | AI1 | <i>12.12 AI1 scaled value</i> (page 152). | 1 |
| | AI2 | <i>12.22 AI2 scaled value</i> (page 154). | 2 |
| | Override speed/freq | Parameter <i>70.06 Override frequency</i> or <i>70.07 Override speed</i> is used as the reference. | 3 |
| | Motor potentiometer | <i>22.80 Motor potentiometer ref act</i> (output of the Floating point control (Motor potentiometer)). | 4 |
| | Stop | The output of the drive is shut off and the motor no longer runs. Override is displayed on the control panel but the motor does not run. Drive follows the specified stop type. | 5 |
| | Process PID set 1 | <i>40.01 PID output value</i> (page 240). | 6 |
| 70.05 | <i>Override direction</i> | Selects the source of the motor direction used in the Override mode. | <i>Forward</i> |
| | Forward | Direction is forward. | 0 |
| | Reverse | Direction is reverse. | 1 |
| | <i>Other [bit]</i> | Source selection (see <i>Terms and abbreviations</i> on page 130). | - |
| 70.06 | <i>Override frequency</i> | Defines the frequency used as reference in the Override mode if <i>70.04 Override reference source</i> is set to <i>Override speed/freq</i> and the drive is in frequency mode. | 0.0 Hz |
| | -500.0...500.0 Hz | Override frequency. | 1 = 1 Hz |
| 70.40 | <i>Override log 1 start date</i> | Displays the start date of the last Override activation. | 01.01.1980 |
| | | Start date. | |
| 70.41 | <i>Override log 1 start time</i> | Displays the start time of the last Override activation. | 00:00:00 |
| | | Start time. | |
| 70.42 | <i>Override log 1 end date</i> | Displays the end date of the last Override situation. If the drive is in Override mode, the parameter shows the current date. | 01.01.1980 |
| | | End date. | |
| 70.43 | <i>Override log 1 end time</i> | Displays the end time of the last Override situation. If the drive is in Override mode, the parameter shows the current time. | 00:00:00 |
| | | End time. | |

| Serial number | Name/Value | Description | Def/FbEq16 |
|---------------|----------------------------------|-------------------------------------------------------------------------------------------------------|------------|
| 70.44 | <i>Override log 1 fault 1</i> | Displays the last fault, if any, that occurred during the last operation of Override. | 0 |
| | | Fault description. | |
| 70.45 | <i>Override log 1 fault 2</i> | Displays the second last fault, if any, that occurred during the last operation of Override. | 0 |
| | | Fault description. | |
| 70.46 | <i>Override log 1 fault 3</i> | Displays the third last fault, if any, that occurred during the last operation of Override. | 0 |
| | | Fault description. | |
| 70.47 | <i>Override log 1 warning 1</i> | Displays the last warning, if any, that occurred during the last operation of Override. | 0 |
| | | Warning description. | |
| 70.48 | <i>Override log 1 warning 2</i> | Displays the second last warning, if any, that occurred during the last operation of Override. | 0 |
| | | Warning description. | |
| 70.49 | <i>Override log 1 warning 3</i> | Displays the third last warning, if any, that occurred during the last operation of Override. | 0 |
| | | Warning description. | |
| 70.50 | <i>Override log 2 start date</i> | Displays the start date of the second last Override activation. | 01.01.1980 |
| | | Start date. | |
| 70.51 | <i>Override log 2 start time</i> | Displays the start time of the second last Override activation. | 00:00:00 |
| | | Start time. | |
| 70.52 | <i>Override log 2 end date</i> | Displays the end date of the second last Override situation. | 01.01.1980 |
| | | End date. | |
| 70.53 | <i>Override log 2 end time</i> | Displays the end time of the second last Override situation. | 00:00:00 |
| | | End time. | |
| 70.54 | <i>Override log 2 fault 1</i> | Displays the last fault, if any, that occurred during the second last operation of Override. | 0 |
| | | Fault description. | |
| 70.55 | <i>Override log 2 fault 2</i> | Displays the second last fault, if any, that occurred during the second last operation of Override. | 0 |
| | | Fault description. | |
| 70.56 | <i>Override log 2 fault 3</i> | Displays the third last fault, if any, that occurred during the second last operation of Override. | 0 |
| | | Fault description. | |
| 70.57 | <i>Override log 2 warning 1</i> | Displays the last warning, if any, that occurred during the second last operation of Override. | 0 |
| | | Warning description. | |
| 70.58 | <i>Override log 2 warning 2</i> | Displays the second last warning, if any, that occurred during second the last operation of Override. | 0 |
| | | Warning description. | |

| Serial number | Name/Value | Description | Def/FbEq16 |
|-------------------------|----------------------------------|------------------------------------------------------------------------------------------------------------------------------|------------|
| 70.59 | <i>Override log 2 warning 3</i> | Displays the third last warning, if any, that occurred during the second last operation of Override. Warning description. | 0 |
| 70.60 | <i>Override log 3 start date</i> | Displays the start date of the third last Override activation. Start date. | 01.01.1980 |
| 70.61 | <i>Override log 3 start time</i> | Displays the start time of the third last Override activation. Start time. | 00:00:00 |
| 70.62 | <i>Override log 3 end date</i> | Displays the end date of the third last Override situation. End date. | 01.01.1980 |
| 70.63 | <i>Override log 3 end time</i> | Displays the end time of the third last Override situation. End time. | 00:00:00 |
| 70.64 | <i>Override log 3 fault 1</i> | Displays the last fault, if any, that occurred during the third last operation of Override. Fault description. | 0 |
| 70.65 | <i>Override log 3 fault 2</i> | Displays the second last fault, if any, that occurred during the third last operation of Override Fault description. | 0 |
| 70.66 | <i>Override log 3 fault 3</i> | Displays the third last fault, if any, that occurred during the third last operation of Override. Fault description. | 0 |
| 70.67 | <i>Override log 3 warning 1</i> | Displays the last warning, if any, that occurred during the third last operation of Override. Warning description. | 0 |
| 70.68 | <i>Override log 3 warning 2</i> | Displays the second last warning, if any, that occurred during third the last operation of Override. Warning description. | 0 |
| 70.69 | <i>Override log 3 warning 3</i> | Displays the third last warning, if any, that occurred during the third last operation of Override. Warning description. | 0 |
| 71 External PID1 | | Configuration of external PID. See the control chain diagrams on pages 611 and 612. | |
| 71.01 | <i>External PID act value</i> | See parameter <i>40.01 PID output value</i> . | - |
| 71.02 | <i>Feedback act value</i> | See parameter <i>40.02 PID feedback value</i> . | - |
| 71.03 | <i>Setpoint act value</i> | See parameter <i>40.03 PID setpoint</i> . | - |
| 71.04 | <i>Deviation act value</i> | See parameter <i>40.04 PID deviation value</i> . | - |

| Serial number | Name/Value | Description | Def/FbEq16 | | | | | | | | | | | | | | | | | | | | | | | | | | | | | | | | |
|---------------|-----------------------------------------------------------------------------------------------------------------------------------------------------------------------------------------------------------------------------------------------------------------------------------------------------------------------------------------------------------------------------------------------------------------------------------------------------------------------------------------------------------------------------------------------------------------------------------------------------------------------------------------------------------------------------------------------------------------------------------------------------------------------------------------------------------------------------------------------------------------------------------------------------------------------------------------------------------------------------------------------------------------------------------------------------------------------------------------------------------------------------------------------------------------------|-----------------------------------------------------------------------------------------------------------------------------------------------------------------------------------------------------------------------------------------------------------------------------------------------------------------------------------------------------------------------------------------------------------------------------------------------------------------------------------------------------------------------------------------------------------------------------------------------------------------------------------------------------------------------------------------------------------------------------------------------------------------------------------------------------------|-------------------------|-------|---|------------|---------------------------------|---|----------|--|---|---------------|--------------------------------------------------------------------------------------------------------------------------------------------------------------------------|-------|----------|--|---|-------------------|-----------------------------------------------------------------|---|------------------|-----------------------------------------------------------------|---|-----------------|----------------------------------------------------------|---------|----------|--|----|--------------------------|------------------------------------------------------------------------|---------|----------|--|--|
| 71.06 | <i>PID status word</i> | Displays status information on process external PID control. This parameter is read-only. | - | | | | | | | | | | | | | | | | | | | | | | | | | | | | | | | | |
| | <table border="1"> <thead> <tr> <th>Bit</th> <th>Name</th> <th>Value</th> </tr> </thead> <tbody> <tr> <td>0</td> <td>PID active</td> <td>1 = Process PID control active.</td> </tr> <tr> <td>1</td> <td>Reserved</td> <td></td> </tr> <tr> <td>2</td> <td>Output frozen</td> <td>1 = Process PID controller output frozen. Bit is set if parameter 71.38 Output freeze enable is TRUE, or the deadband function is active (bit 9 is set).</td> </tr> <tr> <td>3...6</td> <td>Reserved</td> <td></td> </tr> <tr> <td>7</td> <td>Output limit high</td> <td>1 = PID output is being limited by par. 71.37.</td> </tr> <tr> <td>8</td> <td>Output limit low</td> <td>1 = PID output is being limited by par. 71.36.</td> </tr> <tr> <td>9</td> <td>Deadband active</td> <td>1 = Deadband is active (see par. 71.39)</td> </tr> <tr> <td>10...11</td> <td>Reserved</td> <td></td> </tr> <tr> <td>12</td> <td>Internal setpoint active</td> <td>1 = Internal setpoint active (see par. 71.16...71.23)</td> </tr> <tr> <td>13...15</td> <td>Reserved</td> <td></td> </tr> </tbody> </table> | Bit | Name | Value | 0 | PID active | 1 = Process PID control active. | 1 | Reserved | | 2 | Output frozen | 1 = Process PID controller output frozen. Bit is set if parameter 71.38 Output freeze enable is TRUE, or the deadband function is active (bit 9 is set). | 3...6 | Reserved | | 7 | Output limit high | 1 = PID output is being limited by par. 71.37 . | 8 | Output limit low | 1 = PID output is being limited by par. 71.36 . | 9 | Deadband active | 1 = Deadband is active (see par. 71.39) | 10...11 | Reserved | | 12 | Internal setpoint active | 1 = Internal setpoint active (see par. 71.16...71.23) | 13...15 | Reserved | | |
| Bit | Name | Value | | | | | | | | | | | | | | | | | | | | | | | | | | | | | | | | | |
| 0 | PID active | 1 = Process PID control active. | | | | | | | | | | | | | | | | | | | | | | | | | | | | | | | | | |
| 1 | Reserved | | | | | | | | | | | | | | | | | | | | | | | | | | | | | | | | | | |
| 2 | Output frozen | 1 = Process PID controller output frozen. Bit is set if parameter 71.38 Output freeze enable is TRUE, or the deadband function is active (bit 9 is set). | | | | | | | | | | | | | | | | | | | | | | | | | | | | | | | | | |
| 3...6 | Reserved | | | | | | | | | | | | | | | | | | | | | | | | | | | | | | | | | | |
| 7 | Output limit high | 1 = PID output is being limited by par. 71.37 . | | | | | | | | | | | | | | | | | | | | | | | | | | | | | | | | | |
| 8 | Output limit low | 1 = PID output is being limited by par. 71.36 . | | | | | | | | | | | | | | | | | | | | | | | | | | | | | | | | | |
| 9 | Deadband active | 1 = Deadband is active (see par. 71.39) | | | | | | | | | | | | | | | | | | | | | | | | | | | | | | | | | |
| 10...11 | Reserved | | | | | | | | | | | | | | | | | | | | | | | | | | | | | | | | | | |
| 12 | Internal setpoint active | 1 = Internal setpoint active (see par. 71.16...71.23) | | | | | | | | | | | | | | | | | | | | | | | | | | | | | | | | | |
| 13...15 | Reserved | | | | | | | | | | | | | | | | | | | | | | | | | | | | | | | | | | |
| | 0000h...FFFFh | Process PID control status word. | 1 = 1 | | | | | | | | | | | | | | | | | | | | | | | | | | | | | | | | |
| 71.07 | <i>PID operation mode</i> | See parameter 40.07 Process PID operation mode . | Off | | | | | | | | | | | | | | | | | | | | | | | | | | | | | | | | |
| 71.08 | <i>Feedback 1 source</i> | See parameter 40.08 Reference group 1 feedback 1 signal source . | A12 percent | | | | | | | | | | | | | | | | | | | | | | | | | | | | | | | | |
| 71.11 | <i>Feedback filter time</i> | See parameter 40.11 Reference group 1 feedback filter time . | 0.000 s | | | | | | | | | | | | | | | | | | | | | | | | | | | | | | | | |
| 71.14 | <i>Setpoint scaling</i> | Defines, together with parameter 71.15 Output scaling , a general scaling factor for the external PID control chain. The scaling can be utilized when, for example, the process setpoint is input in Hz, and the output of the PID controller is used as an rpm value in speed control. In this case, this parameter might be set to 50, and parameter 71.15 to the nominal motor speed at 50 Hz. In effect, the output of the PID controller [71.15] when deviation (setpoint - feedback) = [71.14] and [71.32] = 1. Note: The scaling is based on the ratio between 71.14 and 71.15 . For example, the values 50 and 1500 would produce the same scaling as 1 and 3. | 1500.00 | | | | | | | | | | | | | | | | | | | | | | | | | | | | | | | | |
| | -200000.00... 200000.00 | Process setpoint base. | 1 = 1 | | | | | | | | | | | | | | | | | | | | | | | | | | | | | | | | |
| 71.15 | <i>Output scaling</i> | See parameter 71.14 Setpoint scaling . | 1500.00 | | | | | | | | | | | | | | | | | | | | | | | | | | | | | | | | |
| | -200000.00... 200000.00 | Process PID controller output base. | 1 = 1 | | | | | | | | | | | | | | | | | | | | | | | | | | | | | | | | |
| 71.16 | <i>Setpoint 1 source</i> | See parameter 40.16 Reference group 1 set value 1 signal source . | A12 percent | | | | | | | | | | | | | | | | | | | | | | | | | | | | | | | | |
| 71.19 | <i>Internal setpoint sel1</i> | See parameter 40.19 Set 1 internal setpoint sel1 . | Not selected | | | | | | | | | | | | | | | | | | | | | | | | | | | | | | | | |
| 71.20 | <i>Internal setpoint sel2</i> | See parameter 40.20 Reference group 1 internal setpoint selection 2 . | Not selected | | | | | | | | | | | | | | | | | | | | | | | | | | | | | | | | |
| 71.21 | <i>Internal setpoint 1</i> | See parameter 40.21 Reference group 1 internal setpoint 1 . | 0.00 PID customer units | | | | | | | | | | | | | | | | | | | | | | | | | | | | | | | | |

| Serial number | Name/Value | Description | Def/FbEq16 |
|---------------|-----------------------------------|-------------------------------------------------------------------------------------------------------------------------------------------------------------------------------------------------------------------------------------------------------------------------------------------------------------------------------------------------------------------------------------------------------------------------------------------------------------------------------------------------------------------------------------------------------------------------------------------|---------------------------------|
| 71.22 | <i>Internal setpoint 2</i> | See parameter <i>40.22 Reference group 1 internal setpoint 2</i> . | 0.00 PID customer units |
| 71.23 | <i>Internal setpoint 3</i> | See parameter <i>40.23 Reference group 1 internal setpoint 3</i> . | 0.00 PID customer units |
| 71.26 | <i>Setpoint min</i> | See parameter <i>40.26 Reference group 1 the minimum set value</i> . | 0.00 PID customer units |
| 71.27 | <i>Setpoint max</i> | See parameter <i>40.27 Reference group 1 the maximum set value</i> . | 200000.00 PID customer units |
| 71.31 | <i>Deviation inversion</i> | See parameter <i>40.31 Reference group 1 negated deviation value</i> . | <i>Not inverted (Ref - Fbk)</i> |
| 71.32 | <i>Gain</i> | See parameter <i>40.32 Reference group 1 gain</i> . | 1.00 |
| 71.33 | <i>Integration time</i> | See parameter <i>40.33 Reference group 1 integration time</i> . | 60.0 s |
| 71.34 | <i>Derivation time</i> | See parameter <i>40.34 Reference group 1 derivation time</i> . | 0.000 s |
| 71.35 | <i>Derivation filter time</i> | See parameter <i>40.35 Reference group 1 derivation filter time</i> . | 0.0 s |
| 71.36 | <i>Output min</i> | See parameter <i>40.36 Reference group 1 the minimum output value</i> . | -200000.00 |
| 71.37 | <i>Output max</i> | See parameter <i>40.37 Reference group 1 the maximum output value</i> . | 200000.00 |
| 71.38 | <i>Output freeze enable</i> | See parameter <i>40.38 Reference group 1 output keeping function</i> . | <i>Not selected</i> |
| 71.39 | <i>Deadband range</i> | The control program compares the absolute value of parameter <i>71.04 Deviation act value</i> to the deadband range defined by this parameter. If the absolute value is within the deadband range for the time period defined by parameter <i>71.40 Deadband delay</i> , PID's deadband mode is activated and <i>71.06 PID status word</i> bit 9 <i>Deadband active</i> is set. Then PID's output is frozen and <i>71.06 PID status word</i> bit 2 <i>Output frozen</i> is set. If the absolute value is equal or greater than the deadband range, PID's deadband mode is deactivated. | 0.0 |
| | 0.0...200000.0 PID customer units | Range | 1 = 1 PID customer unit |
| 71.40 | <i>Deadband delay</i> | Defines the deadband delay for the deadband function. See parameter <i>71.39 Deadband range</i> . | 0.0 s |
| | 0.0...3600.0 s | Delay | 1 = 1 s |
| 71.58 | <i>Increase prevention</i> | Activates increase prevention of PID integration term for Ext PID 1. | <i>No</i> |
| | No | Increase prevention not in use. | 0 |
| | Limiting | The Ext PID integration term is not increased. | 1 |
| | Process PID min lim | The Ext PID integration term is not increased when the output of the process PID has reached its minimum limit. In this setup, the external PID is used as a source for the process PID. | 2 |

| Serial number | Name/Value | Description | Def/FbEq16 | | | | | | | | | | | | | | | | | | |
|-----------------------------|---------------------------------|---------------------------------------------------------------------------------------------------------------------------------------------------------------------------------------------------------------------------------------------------------------------------------------------------------------------------------------------------------------------------------------------------------------------------------------------------------------------------------------------------------------------------------------------|------------|------|-------|---|--------------|--------------------|---|--------------|--------------------|---|--------------|--------------------|---|--------------|--------------------|--------|---------|--|--|
| | Process PID max lim | The Ext PID integration term is not increased when the output of the process PID has reached its maximum limit. In this setup, the external PID is used as a source for the process PID. | 3 | | | | | | | | | | | | | | | | | | |
| | <i>Other [bit]</i> | Source selection (see <i>Terms and abbreviations</i> on page 130). | - | | | | | | | | | | | | | | | | | | |
| 71.59 | <i>Decrease prevention</i> | Activates decrease prevention of PID integration term for Ext PID 1. | No | | | | | | | | | | | | | | | | | | |
| | No | Decrease prevention not in use. | 0 | | | | | | | | | | | | | | | | | | |
| | Limiting | The Ext PID integration term is not decreased. | 1 | | | | | | | | | | | | | | | | | | |
| | Process PID min lim | The Ext PID integration term is not decreased when the output of the process PID has reached its minimum limit. In this setup, the external PID is used as a source for the process PID. | 2 | | | | | | | | | | | | | | | | | | |
| | Process PID max lim | The Ext PID integration term is not decreased when the output of the process PID has reached its maximum limit. In this setup, the external PID is used as a source for the process PID. | 3 | | | | | | | | | | | | | | | | | | |
| | <i>Other [bit]</i> | Source selection (see <i>Terms and abbreviations</i> on page 130). | - | | | | | | | | | | | | | | | | | | |
| 71.62 | <i>Internal setpoint actual</i> | See parameter 40.62 <i>PID internal actual setpoint</i> . | - | | | | | | | | | | | | | | | | | | |
| 71.79 | <i>External PID units</i> | Unit used for external PID. | % | | | | | | | | | | | | | | | | | | |
| | | For selections, see parameter 40.79 <i>Set 1 units</i> . | | | | | | | | | | | | | | | | | | | |
| 76 PFC configuration | | PFC (pump and fan control) and automatic drive configuration parameter. | | | | | | | | | | | | | | | | | | | |
| 76.01 | <i>PFC working status</i> | Displays the running/stopped status of the PFC motors. PFC1, PFC2, PFC3 and PFC4 always correspond to the 1st...4th motor of the PFC system. <i>76.74 Autochange auxiliary PFC</i> If auxiliary PFC is set to <i>Aux motors only</i> , PFC1 represents the motor connected to the drive and PFC2 the first auxiliary motor (the 2nd motor of the system). If <i>76.74</i> is set to <i>All motors</i> , PFC1 is the first motor, PFC2 the 2nd. The drive can be connected to any of these motors depending on the Autochange functionality. | | | | | | | | | | | | | | | | | | | |
| | | <table border="1"> <thead> <tr> <th>Bit(s)</th> <th>Name</th> <th>Value</th> </tr> </thead> <tbody> <tr> <td>0</td> <td>PFC 1operate</td> <td>0 = Stop, 1 =Start</td> </tr> <tr> <td>1</td> <td>PFC 2operate</td> <td>0 = Stop, 1 =Start</td> </tr> <tr> <td>2</td> <td>PFC 3operate</td> <td>0 = Stop, 1 =Start</td> </tr> <tr> <td>3</td> <td>PFC 4operate</td> <td>0 = Stop, 1 =Start</td> </tr> <tr> <td>4...15</td> <td>Reserve</td> <td></td> </tr> </tbody> </table> | Bit(s) | Name | Value | 0 | PFC 1operate | 0 = Stop, 1 =Start | 1 | PFC 2operate | 0 = Stop, 1 =Start | 2 | PFC 3operate | 0 = Stop, 1 =Start | 3 | PFC 4operate | 0 = Stop, 1 =Start | 4...15 | Reserve | | |
| Bit(s) | Name | Value | | | | | | | | | | | | | | | | | | | |
| 0 | PFC 1operate | 0 = Stop, 1 =Start | | | | | | | | | | | | | | | | | | | |
| 1 | PFC 2operate | 0 = Stop, 1 =Start | | | | | | | | | | | | | | | | | | | |
| 2 | PFC 3operate | 0 = Stop, 1 =Start | | | | | | | | | | | | | | | | | | | |
| 3 | PFC 4operate | 0 = Stop, 1 =Start | | | | | | | | | | | | | | | | | | | |
| 4...15 | Reserve | | | | | | | | | | | | | | | | | | | | |
| 76.02 | <i>PFC working description</i> | Displays the status of the PFC system in text form. Provides a quick PFC system overview, eg. if the parameter is added to the Home view on the control panel. | | | | | | | | | | | | | | | | | | | |
| 76.11 | <i>Pump/fan status 1</i> | Shows the status of pump or fan 1. | | | | | | | | | | | | | | | | | | | |

| Serial number | Name/Value | Description | Def/FbEq16 | | | | | | | | | | | | | | | | | | | | | |
|---------------|---------------------------------------------------------------------------------------------------------------------------------------------------------------------------------------------------------------------------------------------------------------------------------------------------------------------------------------------------------------------------------------------------------------------------------------------------------------------------------------------------------------------------------------|-------------------------------------------------------------------------------------------------------------------------------------------------------------------------------------------------------------------------------------------------------------------------------------------------------------------------------------------------------|------------|-------|---|-------|---------------------|---|-----------|---------------------|---|-------------------|---------------------|--------------|---------|--|----|-----------|---------------------|---------|---------|--|--|--|
| | <table border="1"> <thead> <tr> <th>Bit(s)</th> <th>Name</th> <th>Value</th> </tr> </thead> <tbody> <tr> <td>0</td> <td>Ready</td> <td>0 = False, 1 = True</td> </tr> <tr> <td>2</td> <td>operating</td> <td>0 = False, 1 = True</td> </tr> <tr> <td>5</td> <td>Under PFC control</td> <td>0 = False, 1 = True</td> </tr> <tr> <td>1, 3, 4...10</td> <td>Reserve</td> <td></td> </tr> <tr> <td>11</td> <td>Interlock</td> <td>0 = False, 1 = True</td> </tr> <tr> <td>12...15</td> <td>Reserve</td> <td></td> </tr> </tbody> </table> | Bit(s) | Name | Value | 0 | Ready | 0 = False, 1 = True | 2 | operating | 0 = False, 1 = True | 5 | Under PFC control | 0 = False, 1 = True | 1, 3, 4...10 | Reserve | | 11 | Interlock | 0 = False, 1 = True | 12...15 | Reserve | | | |
| Bit(s) | Name | Value | | | | | | | | | | | | | | | | | | | | | | |
| 0 | Ready | 0 = False, 1 = True | | | | | | | | | | | | | | | | | | | | | | |
| 2 | operating | 0 = False, 1 = True | | | | | | | | | | | | | | | | | | | | | | |
| 5 | Under PFC control | 0 = False, 1 = True | | | | | | | | | | | | | | | | | | | | | | |
| 1, 3, 4...10 | Reserve | | | | | | | | | | | | | | | | | | | | | | | |
| 11 | Interlock | 0 = False, 1 = True | | | | | | | | | | | | | | | | | | | | | | |
| 12...15 | Reserve | | | | | | | | | | | | | | | | | | | | | | | |
| | 0000h...FFFFh | Status of pump or fan 1. | | | | | | | | | | | | | | | | | | | | | | |
| 76.12 | <i>Pump/fan status 2</i> | See parameter 76.11 <i>Pump/fan status 1</i> | | | | | | | | | | | | | | | | | | | | | | |
| 76.13 | <i>Pump/fan status 3</i> | See parameter 76.11 <i>Pump/fan status 1</i> . | | | | | | | | | | | | | | | | | | | | | | |
| 76.14 | <i>Pump/fan status 4</i> | See parameter 76.11 <i>Pump/fan status 1</i> . | | | | | | | | | | | | | | | | | | | | | | |
| 76.15 | <i>Pump status 5</i> | See parameter 76.11 <i>Pump/fan status 1</i> . | - | | | | | | | | | | | | | | | | | | | | | |
| 76.16 | <i>Pump status 6</i> | See parameter 76.11 <i>Pump/fan status 1</i> . | - | | | | | | | | | | | | | | | | | | | | | |
| 76.21 | <i>PFC Configuration</i> | Selects the multi-pump/fan control (PFC) mode. | | | | | | | | | | | | | | | | | | | | | | |
| | De-active | PFC disabled. | 0 | | | | | | | | | | | | | | | | | | | | | |
| | PFC | PFC enabled. One pump at a time is controlled by the drive. The remaining pumps are direct-on-line pumps that are started and stopped by the drive logic. The frequency (group 28 <i>Frequency reference chain</i>)/ speed (group 22 <i>Speed reference selection</i>) reference must be defined as PID for the PFC functionality to work properly. | 2 | | | | | | | | | | | | | | | | | | | | | |
| | SPFC | Enable SPFC. See 78 on page <i>Soft pump and fan control (SPFC)</i> . | 3 | | | | | | | | | | | | | | | | | | | | | |
| 76.25 | <i>Number of motors</i> | Total number of motors used in the application, including the motor connected directly to the drive. | 1 | | | | | | | | | | | | | | | | | | | | | |
| | 1...4 | Number of motors. | 1 = 1 | | | | | | | | | | | | | | | | | | | | | |
| 76.26 | <i>Minimum number of motors</i> | Minimum number of motors running simultaneously. | 1 | | | | | | | | | | | | | | | | | | | | | |
| | 0...4 | Minimum number of motors. | 1 = 1 | | | | | | | | | | | | | | | | | | | | | |
| 76.27 | <i>Maximum number of motors</i> | Maximum number of motors running simultaneously. | 1 | | | | | | | | | | | | | | | | | | | | | |
| | 1...4 | Maximum number of motors. | 1 = 1 | | | | | | | | | | | | | | | | | | | | | |

| Serial number | Name/Value | Description | Def/FbEq16 |
|---------------|---------------|-----------------------------------------------------------------------------------------------------------------------------------------------------------------------------------------------------------------------------------------------------------------------------------------------------------------------------------------------------------------------------------------------------------------------------------------------------------------------------------------------------------------------------------------------------------------------------------------------------------------------------------------------------------------------------------------------------------------------------------------------------------------------------------------------------------------------------------------------------------------------------------------------------------------------------------------------------------------------------------------------------------------|------------|
| 76.30 | Start point 1 | <p>Defines the start speed (Hz/rpm) for the first auxiliary motor. As the motor speed or frequency exceeds the limit defined by this parameter, a new auxiliary motor is started.</p> <p>To avoid nuisance starts of the second auxiliary motor, the speed of the variable speed motor should be higher than the start speed for the duration defined by parameter 76.55 Start delay. If the speed decreases below the start speed, the auxiliary motor is not started.</p> <p>To maintain the process conditions during the start of the second auxiliary motor, a speed hold on time can be defined with parameter 76.57 Speed keeping. Certain pump types do not produce significant flow with low frequencies. The speed hold on time can be used to compensate the time needed to accelerate the second auxiliary motor to a speed where it produces flow. The start of the second auxiliary motor is not aborted if the speed of the first auxiliary motor decreases.</p> | 48Hz |

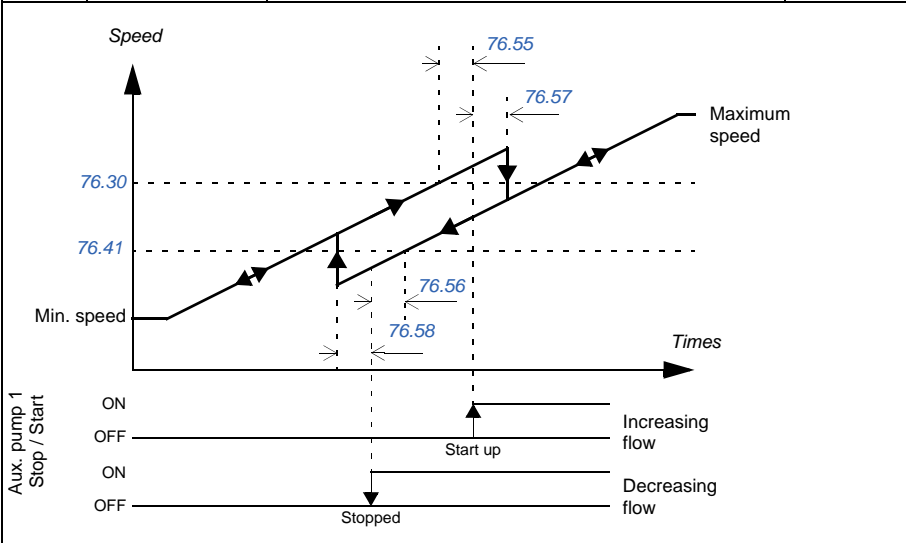

| | | | |
|-------|---------------|-------------------------------------------------------------------------------------------------------------------------------------------------|------------------------------------------------------------------|
| | 0...32,767 Hz | Frequency | |
| 76.31 | Start point 2 | Defines the start speed (Hz) for the second auxiliary motor. | 48Hz |
| 76.32 | Start point 3 | Defines the start speed (Hz) for the third auxiliary motor. | 48Hz |
| 76.33 | Start point 4 | Defines the start speed or frequency (Hz/rpm) for the fourth follower pump/auxiliary motor. See parameter 76.30 Start point 1 . | Vector: 1300 rpm; Scalar: 48 Hz; 58 Hz (95.20 b0) |

| Serial number | Name/Value | Description | Def/FbEq16 |
|---------------|----------------------------|-----------------------------------------------------------------------------------------------------------------------------------------------------------------------------------------------------------------------------------------------------------------------------------------------------------------------------------------------------------------------------------------------------------------------------------------------------------------------------------------------------------------------------------------------------------------------------------------------------------------|----------------------------------------------------------------------------------|
| 76.34 | <i>Start point 5</i> | Defines the start speed or frequency (Hz/rpm) for the fifth follower pump/auxiliary motor. See parameter 76.30 Start point 1 . | Vector: 1300 rpm; Scalar 48 Hz; 58 Hz (95.20 b0) |
| 76.41 | <i>Stop point 1</i> | Defines the stop speed (Hz) for the first auxiliary motor. When the speed of the motor connected directly to the drive falls below this value and one auxiliary motor is running, the stop delay defined by parameter 76.56 Stop delay is started. If the speed is still at the same level or lower when the stop delay elapses, the first auxiliary motor stops. The running speed of the drive is increased by (Start point 1 - Stop point 1) after the auxiliary motor stops | 25Hz |
| | 0...32767 rpm/Hz | Speed/frequency | |
| 76.42 | <i>Stop point 2</i> | Defines the stop speed (Hz) for the second auxiliary motor. See parameter 76.41 Stop point 1 . | 25Hz |
| 76.43 | <i>Stop point 3</i> | Defines the stop speed (Hz) for the third auxiliary motor. See parameter 76.41 Stop point 1 . | 250.00.00s |
| 76.44 | <i>Stop point 4</i> | Defines the stop speed (Hz/rpm) for the fourth auxiliary motor. See parameter 76.41 Stop point 1 . | Vector: 800 rpm; Scalar 25 Hz; 30 Hz (95.20 b0) |
| 76.45 | <i>Stop point 5</i> | Defines the stop speed (Hz/rpm) for the fifth auxiliary motor. See parameter 76.41 Stop point 1 . | Vector: 800 rpm; Scalar 25 Hz; 30 Hz (95.20 b0) |
| 76.55 | <i>Start delay</i> | Defines a start delay for auxiliary motor. See parameter 76.30 Start point 1 . | 10.00 s |
| | 0.00...12600.00 s | Time delay. | |
| 76.56 | <i>Stop delay</i> | Defines a stop delay for auxiliary motor. See parameter 76.41 Stop point 1 . | 10.00s |
| | 0.00...12600.00 s | Time delay. | |
| 76.57 | <i>Speed keeping</i> | Hold time for auxiliary motor switch-on. See parameter 76.30 Start point 1 . | 0.00 s |
| | 0.00...1000.00 s | Time. | |
| 76.58 | <i>PFC contactor delay</i> | Hold time for auxiliary motor switch-off. See parameter 76.41 Stop point 1 . | 0.00 s |
| | 0.00...1000.00 s | Time. | |
| 76.59 | <i>PFC contactor delay</i> | Start delay for the motor that is directly controlled by the drive. This does not affect the starting of the auxiliary motors.  Warning! There must always be a delay set if the motors are equipped with star-delta starters. The delay must be set longer than the time setting of the starter. After the motor is switched on by the relay output of the drive, there must be enough time for the star-delta starter to first switch to star and then back to delta before the motor is connected to the drive. | 0.5 s |

| Serial number | Name/Value | Description | Def/FbEq16 |
|---------------|---------------------------|--------------------------------------------------------------------------------------------------------------------------------------------------------------------------------------------------------------------------------------------------------------------------------------------------------------------------------------------------------------------------------------------------------------------------------------------------------------------------------------------------------------------------------------------------------------------------------------------------------|--------------|
| | 0.20...600.00 s | Time delay. | 1 = 1 s |
| 76.60 | <i>PFC ramp up time</i> | Defines the acceleration time for the drive motor speed compensation, when an auxiliary motor is stopped. This ramp time is also used for the drive motor to accelerate after an auto-change has occurred. The parameter sets the ramp-up time as seconds from zero to maximum frequency (not from the previous reference to the new reference). | 1.00 s |
| | 0.00...1800.00 s | Time. | 1 = 1 s |
| 76.61 | <i>PFC ramp down time</i> | Defines the deceleration time for the drive motor speed compensation, when an auxiliary motor is started. This ramp time is also used for the drive motor to decelerate after an autochange has occurred. The parameter sets the ramp-up time as seconds from maximum to zero frequency (not from the previous reference to the new reference). | 1.00 s |
| | 0.00...1800.00 s | Time. | 1 = 1 s |
| 76.70 | <i>Autochange</i> | Defines the way the autochange is triggered. In all cases except Instant loss, the start order is moved one step forward each time the autochange occurs. If the start order initially is 1-2-3-4, after the first autochange the order will be 2-3-4-1, etc. For Instant loss, the start order will be determined so that the running times of all motors remain within the defined limit. Note: Autochange only occurs when the speed of the drive is below the speed defined by parameter 76.73 Autochange scope . see also section Autochange . | Not selected |
| | Not selected | Autochange disabled. | 0 |
| | Selected | Rising edge starts the autochange if autochange conditions are met. | 1 |

| Serial number | Name/Value | Description | Def/FbEq16 |
|---------------|------------------------------------|------------------------------------------------------------------------------------------------------------------------------------------------------------------------------------------------------------------------------------------------------------------------------------------------------------------------------------------------------------------------------------------------------------------------------------|------------|
| | DI1 | Autochange triggered by the rising edge of Digital input DI1 (<i>10.02 DI delayed status</i> , bit 0). | 2 |
| | DI2 | Autochange triggered by the rising edge of Digital input DI2 (<i>10.02 DI delayed status</i> , bit 1). | 3 |
| | DI3 | Autochange triggered by the rising edge of Digital input DI3 (<i>10.02 DI delayed status</i> , bit 2). | 4 |
| | DI4 | Autochange triggered by the rising edge of Digital input DI4 (<i>10.02 DI delayed status</i> , bit 3). | 5 |
| | DI5 | Autochange triggered by the rising edge of Digital input DI5 (<i>10.02 DI delayed status</i> , bit 4). | 6 |
| | DI6 | Autochange triggered by the rising edge of Digital input DI6 (<i>10.02 DI delayed status</i> , bit 5). | 7 |
| | Timed function 1 | Autochange triggered by timed function 2 (bit 0 of (<i>34.01 Combined timer status</i>) (See page 218) | 8 |
| | Timed function 2 | Autochange triggered by timed function 2 (bit 0 of (<i>34.01 Combined timer status</i>) (See page 218) | 9 |
| | Timed function 3 | Autochange triggered by timed function 2 (bit 0 of (<i>34.01 Combined timer status</i>) (See page 218) | 10 |
| | Fixed interval | Autochange is done when the interval determined in the parameter <i>76.71 Autochange interval</i> has elapsed. | 11 |
| | All stopped | Autochange is done when all the motors are stopped. The PID sleep feature (parameters <i>40.43 Reference group 1 sleep frequency ... 40.48 Reference group 1 wake-up delay</i>) must be used for the drive to stop when the process demand is low. | 12 |
| | Balanced load | The running time of the motors are balanced by the drive. When the difference in running time between the motors with the least and most running hours exceeds the time defined by parameter <i>76.72 Maximum disequilibrium time</i> , the autochange occurs. The running hours of the motors can be found in group <i>PFC run time change</i> . | 13 |
| | <i>Other [bit]</i> | Signal source selection (See <i>130</i> on page <i>Terms and abbreviations</i>). | - |
| <i>76.71</i> | <i>Autochange interval</i> | Specifies the interval that is used in setting <i>Fixed interval</i> of parameter <i>76.70 Autochange</i> . | 1.00 h |
| | 0.00...42949672.9 5 h | Time. | - |
| <i>76.72</i> | <i>Maximum disequilibrium time</i> | Specifies the maximum wear imbalance, or difference in running times between any motor, used by the instant loss setting of parameter <i>76.70 Autochange</i> . | 10.00 h |
| | 0.00...1000000.00 h | Time. | - |
| <i>76.73</i> | <i>Autochange scope</i> | Upper speed limit for the Autochange to occur. The Autochange occurs when meeting below conditions: <ul style="list-style-type: none"> the condition defined in <i>76.70 Autochange</i> is fulfilled and, the speed of the drive motor <i>01.03 Motor speed (%)</i> is below the speed limit defined in this parameter. Note: When the value is selected as 0%, this speed limit check is disabled. | 100.0%- |

| Serial number | Name/Value | Description | Def/FbEq16 |
|------------------------------------------|---------------------------------------|--------------------------------------------------------------------------------------------------------------------------------------------------------------------------------------------------------------------------------------------------------------------------------------------------------------------------------------------------------------------------------------------------------------|--------------------------------------|
| | 0.0...300.0% | Speed/frequency in percentage of the nominal speed or frequency of the drive motor. | - |
| 76.74 | <i>Autochange auxiliary PFC</i> | Selects whether only auxiliary motors or all motors are included in the Autochange function. | Aux motors only |
| | All motors | All motors, including the one connected to the drive which participates in the autochange. The Autochange logic will connect the drive to each of the motors according to setting of parameter 76.70 Autochange . Note: The first motor (PFC1) also requires the appropriate hardware contactor connections and PFC1 must be defined in one of the relay output source parameters. | 0 |
| | Aux motors only | Only auxiliary (direct-on-line) motors are affected by the autochange function. Note: PFC1 refers to the motor that is fixed to the drive and must not be selected in any of the relay output source parameters. Only the starting order of the auxiliary motors will be rotated. | 1 |
| 76.81 | <i>PFC 1 interlock</i> | Defines if the PFC motor 1 can be started. An interlocked PFC motor cannot be started. An interlocked PFC motor cannot be started. 0 = interlocked (not available.), 1 = Available. | Available |
| | Interlocked. PFC motor is not in use. | PFC motor is interlocked and not available. | 0 |
| | Available. PFC motor is available. | PFC motor is available. | 1 |
| | Timed function 1 | 34.01 Bit 0 of <i>Combined timer status</i> (See page 218). | 8 |
| | Timed function 2 | 34.01 Bit 1 of <i>Combined timer status</i> (See page 218). | 9 |
| | Timed function 3 | 34.01 Bit 2 of <i>Combined timer status</i> (See page 218). | 10 |
| | <i>Other [bit]</i> | Signal source selection (See 130 on page <i>Terms and abbreviations</i>). | - |
| 76.82 | <i>PFC 2 interlock</i> | See parameter 76.82 PFC 2 interlock . | - |
| 76.83 | <i>PFC 3 interlock</i> | See parameter 76.82 PFC 2 interlock . | - |
| 76.84 | <i>PFC 4 interlock</i> | See parameter 76.82 PFC 2 interlock . | - |
| 76.85 | <i>PFC 5 interlock</i> | See parameter 76.81 PFC 1 interlock . | Available. PFC motor is available |
| 76.86 | <i>PFC 6 interlock</i> | See parameter 76.81 PFC 1 interlock . | Available. PFC motor is available |
| 76.95 | <i>Regulator bypass control</i> | Inhibit =0, Enable =1, Other | - |
| 77 PFC maintenance and monitoring | | PFC (Pump and fan control) maintenance and monitoring parameters. | |
| 77.10 | <i>PFC run time change</i> | Enables the reset or arbitrary setting of 77.11 Pump/fan 1 run time ... 77.14 Pump/fan 4 run time . | Finalization |

| Serial number | Name/Value | Description | Def/FbEq16 |
|----------------------------|-------------------------------------|------------------------------------------------------------------------------------------------------------------------------------------------------------------------------------------------------------------------------------------------------------------------------------------------------------------------------------------------------------------------------------------------------------------------------------------------------------------------------------------------------------------------------------------------------------------------------------------------------------------------------------------------------------------------------------|--------------------------|
| | Finalization | The parameter automatically reverts back to this value. | 0 |
| | Set any PFC run time | Enables the setting of 77.11 Pump/fan 1 run time ... 77.14 Pump/fan 4 run time to an arbitrary value. | 1 |
| | Reset PFC1 run time | Resets parameter 77.11 Pump/fan 1 run time . | 2 |
| | Reset PFC2 run time | Resets parameter 77.12 Pump/fan 2 run time . | 3 |
| | Reset PFC3 run time | Resets parameter 77.13 Pump/fan 3 run time . | 4 |
| | Reset PFC4 run time | Resets parameter 77.14 Pump/fan 4 run time . | 5 |
| 77.11 | Pump/fan 1 run time | Pump/Fan 1 on-time counter. Set or reset by parameter 77.10 PFC run time change . | 0.00 h |
| | 0.00...42949672.95 h | Times | |
| 77.12 | Pump/fan 2 run time | See parameter 77.11 Pump/fan 1 run time . | 0.00 h |
| 77.13 | Pump/fan 3 run time | See parameter 77.11 Pump/fan 1 run time . | 0.00 h |
| 77.14 | Pump/fan 4 run time | See parameter 77.11 Pump/fan 1 run time . | 0.00 h |
| 77.15 | Pump 5 running time | See parameter 77.11 Pump/fan 1 run time . | 0.00 h |
| 77.16 | Pump 6 running time | See parameter 77.11 Pump/fan 1 run time . | 0.00 h |
| 95 HW configuration | | Related settings of hardware. | |
| 95.01 | Supply volt | <p>Selects the supply voltage range. This parameter is used by the drive to determine the nominal voltage of the supply network. The parameter also affects the current ratings and the DC voltage control functions (trip and brake chopper activation limits) of the drive.</p> <p> Warning! An incorrect setting may cause the motor to rush uncontrollably, or the brake chopper or resistor to overload.</p> <p>Note: The selections shown depend on the hardware of the drive. If only one voltage range is valid for the drive in question, it is selected by default.</p> | Automatic / not selected |
| | Automatic / not selected | No voltage range selected. The drive will not start modulating before a range is selected, unless parameter 95.02 Adaptive voltage limits is set to Enabled, in which case the drive estimates the supply voltage itself. | 0 |
| | 380...415 V | 380...415 V, available for ACS530-01-xxxx-4 drives | 2 |

| Serial number | Name/Value | Description | Def/FbEq16 | | | | | | | | | | | |
|---------------|----------------------------------------------------------------------------------------------------------------------------------------------------------------------------------------------------------------------------------------------------------------------------------------------------------------------------------------|----------------------------------------------------------------------------------------------------------------------------------------------------------------------------------------------------------------------------------------------------------------------------------------------------------------------------------------------------------------------------------------------------------------------------------------------------------------------------------------------------------------------------------------------------------------|--------------|-------|---------|------------------------|--------------------------|--------|-------------------------|--|--------|---------|--|--|
| 95.02 | <i>Adaptive voltage limits</i> | Enables adaptive voltage limits. Adaptive voltage limits can be used if, for example, an IGBT supply unit is used to raise the DC voltage level. If the communication between the inverter and IGBT supply unit is active, the voltage limits are related to the DC voltage reference from the IGBT supply unit. Otherwise the limits are calculated based on the measured DC voltage at the end of the pre-charging sequence. This function is also useful if the AC supply voltage to the drive is high, as the warning levels are raised accordingly. | Enabled | | | | | | | | | | | |
| | Inhibited | Adaptive voltage limits disabled. | 0 | | | | | | | | | | | |
| | Enabled | Adaptive voltage limits enabled. | 1 | | | | | | | | | | | |
| 95.03 | <i>Estimated AC supply voltage</i> | AC supply voltage estimated by calculating using DC voltage. | - | | | | | | | | | | | |
| | 0.0...1,000.0 V | Voltage. | 10 = 1 V | | | | | | | | | | | |
| 95.04 | <i>Control board supply</i> | Specifies how the control board of the drive is powered. | Internal 24V | | | | | | | | | | | |
| | Internal 24V | The drive control board is powered from the drive power unit it is connected to. | 0 | | | | | | | | | | | |
| | External 24V | It is available only under CCU24 | 1 | | | | | | | | | | | |
| 95.15 | <i>Special HW settings</i> | | | | | | | | | | | | | |
| | External 24V | The drive control board is powered from an external power supply. | 1 | | | | | | | | | | | |
| | <table border="1"> <thead> <tr> <th>Bit(s)</th> <th>Name</th> </tr> </thead> <tbody> <tr> <td>0</td> <td>Reserve</td> </tr> <tr> <td>1</td> <td>ABB sine filter</td> </tr> <tr> <td>3...15</td> <td>Reserve</td> </tr> </tbody> </table> | Bit(s) | Name | 0 | Reserve | 1 | ABB sine filter | 3...15 | Reserve | | | | | |
| Bit(s) | Name | | | | | | | | | | | | | |
| 0 | Reserve | | | | | | | | | | | | | |
| 1 | ABB sine filter | | | | | | | | | | | | | |
| 3...15 | Reserve | | | | | | | | | | | | | |
| 95.20 | <i>HW options word 1</i> | Specifies hardware-related options that require differentiated parameter default settings. This parameter is not affected by a parameter restore. | - | | | | | | | | | | | |
| | <table border="1"> <thead> <tr> <th>Bit(s)</th> <th>Name</th> <th>Value</th> </tr> </thead> <tbody> <tr> <td>0</td> <td>Supply Frequency 60 Hz</td> <td>0 = 50 Hz. 1 = 60 Hz.</td> </tr> <tr> <td>13</td> <td>du/dt filter activation</td> <td></td> </tr> <tr> <td>1...15</td> <td>Reserve</td> <td></td> </tr> </tbody> </table> | Bit(s) | Name | Value | 0 | Supply Frequency 60 Hz | 0 = 50 Hz. 1 = 60 Hz. | 13 | du/dt filter activation | | 1...15 | Reserve | | |
| Bit(s) | Name | Value | | | | | | | | | | | | |
| 0 | Supply Frequency 60 Hz | 0 = 50 Hz. 1 = 60 Hz. | | | | | | | | | | | | |
| 13 | du/dt filter activation | | | | | | | | | | | | | |
| 1...15 | Reserve | | | | | | | | | | | | | |
| | 0000h...FFFFh | Hardware options configuration word. | 1 = 1 | | | | | | | | | | | |

| Serial number | Name/Value | Description | Def/FbEq16 |
|------------------|-----------------------------------|----------------------------------------------------------------------------------------------------------------------------------------------------------------------------------------------------------------------------------------------------------------------------------------------------------------------------------------------------------------------------------------------------------------------------------------------------------------------------------------------------------------------------------------------------------------------------------------------------------------------------------------------------------------------------------------------------------------------------------------------------------------------------------------------------------------------------------------------------------------|----------------|
| 95.26 | <i>Motor disconnect detection</i> | <p>Detects if motor is disconnected and shows a warning of disconnected motor.</p> <p>When this parameter is enabled, the drive will do the followings:</p> <ol style="list-style-type: none"> 1. The drive detects if the motor is disconnected from the drive (all three phases). 2. When a motor disconnection is detected, the drive will stay running and waits for the motor to be connected again. The drive shows warning <i>A784 Motor disconnect</i> on the control panel. 3. When motor connection is again detected, the motor returns back to the last active reference before the disconnection was detected. 4. The warning message disappears from the panel <p>Note: This feature is only available in scalar control mode. This parameter does not affect vector control mode behavior.</p> | <i>Disable</i> |
| | Disable | Detecting of disconnected motor disabled. | 0 |
| | Enable | Detecting of disconnected motor enabled. | 1 |
| 95.200 | <i>Cooling fan mode</i> | Cooling fan operation mode. | <i>Auto</i> |
| | Auto | Fan runs normally: Fan on/off, fan speed reference can autochange according to the drive state. | 0 |
| | Always on | Fan always runs at 100% speed reference. | 1 |
| 96 System | | Language selection; access levels; macro selection; parameter save and restore; control device reboot; user parameter sets; unit selection. | |
| 96.01 | <i>Language</i> | <p>Selects the language of the parameter interface and other displayed information when viewed on the control panel.</p> <p>Notes:</p> <ul style="list-style-type: none"> • Not all languages listed below are necessarily supported. • This parameter does not affect the languages visible in the Drive composer PC tool. (Those are specified under View – Settings – Drive default language.) | - |
| | Not selected | None. | 0 |
| | English | English. | 1033 |
| | Chinese (Simplified, PRC) | Simplified Chinese. | 2052 |
| 96.02 | <i>Passcode</i> | <p>Pass codes can be entered into this parameter to activate further access levels (for example additional parameters, parameter lock, etc.). See parameter <i>96.03 Access level status</i>.</p> <p>Code 358 sets and resets parameter lock, which prevents changing of parameters.</p> | 0 |
| | 0...99999999 | Pass code. | - |

| Serial number | Name/Value | Description | Def/FbEq16 | | | | | | | | | | | | | | | | | | |
|---------------|------------------------------------------------------------------------------------------------------------------------------------------------------------------------------------------------------------------------------------------------------------------------------------------------------------------------------------------------------------------------------------------------------------------------------------------------------------------------------------|-----------------------------------------------------------------------------------------------------------------------------------------------------------------------------------|--------------|---|----------|---|----------|--------|---------|----|--------------------|----|--------------------|----|--------------------|----|----------------|----|---------|--|--|
| 96.03 | <i>Access level status</i> | Shows which access levels have been activated by pass codes entered into parameter <i>96.02 Passcode</i> . | 001b | | | | | | | | | | | | | | | | | | |
| | <table border="1"> <thead> <tr> <th>Bit(s)</th> <th>Name</th> </tr> </thead> <tbody> <tr> <td>0</td> <td>End user</td> </tr> <tr> <td>1</td> <td>Services</td> </tr> <tr> <td>2...10</td> <td>Reserve</td> </tr> <tr> <td>11</td> <td>OEM access level 1</td> </tr> <tr> <td>12</td> <td>OEM access level 2</td> </tr> <tr> <td>13</td> <td>OEM access level 3</td> </tr> <tr> <td>14</td> <td>Parameter lock</td> </tr> <tr> <td>15</td> <td>Reserve</td> </tr> </tbody> </table> | Bit(s) | Name | 0 | End user | 1 | Services | 2...10 | Reserve | 11 | OEM access level 1 | 12 | OEM access level 2 | 13 | OEM access level 3 | 14 | Parameter lock | 15 | Reserve | | |
| Bit(s) | Name | | | | | | | | | | | | | | | | | | | | |
| 0 | End user | | | | | | | | | | | | | | | | | | | | |
| 1 | Services | | | | | | | | | | | | | | | | | | | | |
| 2...10 | Reserve | | | | | | | | | | | | | | | | | | | | |
| 11 | OEM access level 1 | | | | | | | | | | | | | | | | | | | | |
| 12 | OEM access level 2 | | | | | | | | | | | | | | | | | | | | |
| 13 | OEM access level 3 | | | | | | | | | | | | | | | | | | | | |
| 14 | Parameter lock | | | | | | | | | | | | | | | | | | | | |
| 15 | Reserve | | | | | | | | | | | | | | | | | | | | |
| | 000b...111b | Active access levels. | - | | | | | | | | | | | | | | | | | | |
| 96.04 | <i>Macro select</i> | Selects the application macro. For details, See chapter <i>Application macros</i> (page 29). After a selection is made, the parameter reverts automatically to <i>Done</i> . | Done | | | | | | | | | | | | | | | | | | |
| | Done | Macro selection complete; normal operation. | 0 | | | | | | | | | | | | | | | | | | |
| | ABB standard | Factory macro (See page 30). | 1 | | | | | | | | | | | | | | | | | | |
| | Hand/Auto | Hand/Auto macro (See page 40). | 2 | | | | | | | | | | | | | | | | | | |
| | Hand/PID | Hand/PID macro (See page 44). | 3 | | | | | | | | | | | | | | | | | | |
| | 3- wire | 3-wire macro (See page 33). | 11 | | | | | | | | | | | | | | | | | | |
| | Alternate | Alternate macro (See page 35). | 12 | | | | | | | | | | | | | | | | | | |
| | Motor potentiometer | Motor potentiometer macro (See page 38). | 13 | | | | | | | | | | | | | | | | | | |
| | PID | PID macro (See page 46). | 14 | | | | | | | | | | | | | | | | | | |
| | Panel PID | Control panel macro (See page 56) | 15 | | | | | | | | | | | | | | | | | | |
| | PFC | PFC macro (see page 50). | 16 | | | | | | | | | | | | | | | | | | |
| | SPFC | SPFC macro (See page 53). | 18 | | | | | | | | | | | | | | | | | | |
| 96.05 | <i>Macro active</i> | Shows which application macro is currently selected. For details, See chapter <i>Application macros</i> (page 29). To change the macro, use parameter <i>96.04 Macro select</i> . | ABB standard | | | | | | | | | | | | | | | | | | |
| | ABB standard | Factory macro (See page 30). | 1 | | | | | | | | | | | | | | | | | | |
| | Hand/Auto | Hand/Auto macro (See page 40). | 2 | | | | | | | | | | | | | | | | | | |
| | Hand/PID | Hand/PID macro (See page 44). | 3 | | | | | | | | | | | | | | | | | | |
| | 3-wire | 3-wire macro (See page 33). | 11 | | | | | | | | | | | | | | | | | | |
| | Alternate | Alternate macro (See page 35). | 12 | | | | | | | | | | | | | | | | | | |
| | Motor potentiometer | Motor potentiometer macro (See page 38). | 13 | | | | | | | | | | | | | | | | | | |
| | PID control | PID macro (See page 46). | 14 | | | | | | | | | | | | | | | | | | |
| | Control panel | Control panel macro (See page 56). | 15 | | | | | | | | | | | | | | | | | | |
| | PFC | PFC macro (see page 50). | 16 | | | | | | | | | | | | | | | | | | |
| | SPFC | SPFC macro (See page 53). | 18 | | | | | | | | | | | | | | | | | | |

| Serial number | Name/Value | Description | Def/FbEq16 |
|---------------|-----------------------------|------------------------------------------------------------------------------------------------------------------------------------------------------------------------------------------------------------------------------------------------------------------------------------------------------------------------------------------------------------------------------------------------------------------------------------------------------------------------------------------------------------------------------------------------------------------------------------------------------|--------------|
| 96.06 | <i>Parameter restore</i> | Restores the original settings of the control program, i.e., parameter default values. Note: The parameter cannot be changed while the drive is running. | Finalization |
| | Finalization | Restoring is completed. | 0 |
| | Reset motor data | restore all motor rating ID run results to default values | 2 |
| | Restore defaults | All editable parameter values are restored to default values, except: <ul style="list-style-type: none"> • motor data and ID run results • I/O extension module settings • End user texts, such as customized warnings and faults (external faults and changed), and the drive name • Control panel/PC communication settings • Fieldbus adapter settings • Application selection and the parameter defaults implemented by macro • Parameter <i>95.20 HW options word 1</i> and the differentiated defaults implemented by it. | 8 |
| | Reset all fieldbus settings | Restore all the fieldbus and communication related settings to default values Note : The communication of fieldbus, control board and PC tool is disturbed in the process of saving. | 32 |
| | Clear all | All editable parameter values are restored to default values, except: <ul style="list-style-type: none"> • End user texts, such as customized warnings and faults (external faults and changed), and the drive name • Control panel/PC communication settings • Application selection and the parameter defaults implemented by it • Parameter <i>95.20 HW options word 1</i> and the differentiated defaults implemented by it. PC tool communication is interrupted during the restoring. | 62 |
| | Reset home view | Restore home view and display the currently used default parameter that is defined by control macro. | 512 |
| | Reset end user texts | Restore the default value of all end user texts, comprising drive names, contact information, self-defined fault and warning texts, PID and currency unit. | 1024 |
| | Restore factory settings | Restore all the transmission parameter and settings to factory settings, except <ul style="list-style-type: none"> • Parameter 95.20 HW options word 1 and the default value defined through the parameter. | 34560 |

| Serial number | Name/Value | Description | Def/FbEq16 |
|---------------|--------------------------------|------------------------------------------------------------------------------------------------------------------------------------------------------------------------------------------------------------------------------------------------------------------------------------------------------------------------------------------------------------------------------------------------------------------------------------------------------------------------------------------------------------------------------------------------------------------------------------------------------------------------------------------------------------|--------------|
| 96.07 | <i>Parameter save manually</i> | Saves the valid parameter values to the permanent memory on the drive control unit to ensure that operation can continue after cycling the power. Save the parameters with this parameter. <ul style="list-style-type: none"> to store values sent from the fieldbus When using external +24 V DC power supply to the control unit: save parameter changes before you power down the control unit. The supply has a very short hold-up time when powered off. Note: A new parameter value is saved automatically when changed from the PC tool or control panel but not when altered through a fieldbus adapter connection. | Finalization |
| | Finalization | Save completed. | 0 |
| | Save | Save in progress. | 1 |
| 96.08 | <i>Control board boot</i> | Changing the value of this parameter to 1 reboots the control unit (without requiring a power off/on cycle of the complete drive module). Value automatically returns to 0. | 0 |
| | No action | No action | 0 |
| | Restart | Restart control panel | 1 |
| 96.10 | <i>User macro status</i> | Shows the status of the user parameter sets. This parameter is read-only. See also section <i>User macro</i> (page 94). | - |
| | n/a | No user parameter sets have been saved. | 0 |
| | Loading | Users' group is loading. | 1 |
| | Saving | Users' group is saving. | 2 |
| | Fault | Invalid or empty parameter group. | 3 |
| | User1 IO active | User set 1 has been selected by parameters <i>96.12 User macro I/O mode input 1</i> and <i>96.13 User macro I/O mode input 2</i> . | 4 |
| | User2 IO active | User set 2 has been selected by parameters <i>96.12 User macro I/O mode input 1</i> and <i>96.13 User macro I/O mode input 2</i> . | 5 |
| | User3 IO active | User set 3 has been selected by parameters <i>96.12 User macro I/O mode input 1</i> and <i>96.13 User macro I/O mode input 2</i> . | 6 |
| | User4 IO active | User set 4 has been selected by parameters <i>96.12 User macro I/O mode input 1</i> and <i>96.13 User macro I/O mode input 2</i> . | 7 |
| | User1 Backup | User group 1 has been saved or loaded. | 20 |
| | User2 Backup | User group 2 has been saved or loaded. | 21 |
| | User3 Backup | User group 3 has been saved or loaded. | 22 |
| | User4 Backup | User group 4 has been saved or loaded. | 23 |

| Serial number | Name/Value | Description | Def/FbEq16 | | | | | | | | | | | | | | | |
|--------------------------------------------------------------|--------------------------------------------------------------|-------------------------------------------------------------------------------------------------------------------------------------------------------------------------------------------------------------------------------------------------------------------------------------------------------------------------------------------------------------------------------------------------------------------------------------------------------------------------------------------------------------------------------------------------------------------------------------------------------------------------------------------------------------------------------------------------|--------------------------------------------------------------|--------------------------------------------------------------|-------------------------------|---|---|---------|---|---|---------|---|---|---------|---|---|---------|--------------|
| 96.11 | <i>User macro save/load</i> | <p>Enables the saving and restoring of up to four custom sets of parameter settings. The set that was in use before powering down the drive is in use after the next power-up.</p> <p>Notes:</p> <ul style="list-style-type: none"> Some hardware configuration such as bus adapter (respectively Group 14...16、47、50...58 and 92...93) is not included in the user parameter set. Parameter changes made after loading a set are not automatically stored – they must be saved using this parameter. This parameter cannot be changed while the drive is running | No action | | | | | | | | | | | | | | | |
| | No action | Load or save operation complete; normal operation. | 0 | | | | | | | | | | | | | | | |
| | User macro I/O mode | Load user parameter set using parameters 96.12 User macro I/O mode input 1 and 96.13 User macro I/O mode input 2 . | 1 | | | | | | | | | | | | | | | |
| | Load user macro 1 | Load user macro 1. | 2 | | | | | | | | | | | | | | | |
| | Load user macro 2 | Load user macro 2. | 3 | | | | | | | | | | | | | | | |
| | Load user macro 3 | Load user macro 3. | 4 | | | | | | | | | | | | | | | |
| | Load user macro 4 | Load user macro 4. | 5 | | | | | | | | | | | | | | | |
| | Save user macro 1 | Save user macro 1. | 18 | | | | | | | | | | | | | | | |
| | Save user macro 2 | Save user macro 2. | 19 | | | | | | | | | | | | | | | |
| | Save user macro 3 | Save user macro 3. | 20 | | | | | | | | | | | | | | | |
| | Save user macro 4 | Save user macro 4. | 21 | | | | | | | | | | | | | | | |
| 96.12 | <i>User macro I/O mode input 1</i> | <p>When parameter 96.11 User macro save/load is set to <i>User macro I/O mode</i>, selects the user parameter set together with parameter 96.13 User macro I/O mode input 2 as follows:</p> <table border="1"> <thead> <tr> <th>Status of source defined by parameter: 96.12</th> <th>Status of source defined by parameter: 96.13</th> <th>User parameter group selected</th> </tr> </thead> <tbody> <tr> <td>0</td> <td>0</td> <td>Group 1</td> </tr> <tr> <td>1</td> <td>0</td> <td>Group 2</td> </tr> <tr> <td>0</td> <td>1</td> <td>Group 3</td> </tr> <tr> <td>1</td> <td>1</td> <td>Group 4</td> </tr> </tbody> </table> | Status of source defined by parameter: 96.12 | Status of source defined by parameter: 96.13 | User parameter group selected | 0 | 0 | Group 1 | 1 | 0 | Group 2 | 0 | 1 | Group 3 | 1 | 1 | Group 4 | Not selected |
| Status of source defined by parameter: 96.12 | Status of source defined by parameter: 96.13 | User parameter group selected | | | | | | | | | | | | | | | | |
| 0 | 0 | Group 1 | | | | | | | | | | | | | | | | |
| 1 | 0 | Group 2 | | | | | | | | | | | | | | | | |
| 0 | 1 | Group 3 | | | | | | | | | | | | | | | | |
| 1 | 1 | Group 4 | | | | | | | | | | | | | | | | |
| | Not selected | 0 | 0 | | | | | | | | | | | | | | | |
| | Select | 1 | 1 | | | | | | | | | | | | | | | |
| | Timed function 1 | 34.01 Bit 0 of <i>Combined timer status</i> (See page 218). | 18 | | | | | | | | | | | | | | | |
| | Timed function 2 | 34.01 Bit 1 of <i>Combined timer status</i> (See page 218). | 19 | | | | | | | | | | | | | | | |
| | Timed function 3 | 34.01 Bit 2 of <i>Combined timer status</i> (See page 218). | 20 | | | | | | | | | | | | | | | |
| | Monitor 1 | 32.01 Bit 0 of <i>Supervision status word</i> (See page 211). | 24 | | | | | | | | | | | | | | | |
| | Monitor 2 | 32.01 Bit 1 of <i>Supervision status word</i> (See page 211). | 25 | | | | | | | | | | | | | | | |
| | Monitor 3 | 32.01 Bit 2 of <i>Supervision status word</i> (See page 211). | 26 | | | | | | | | | | | | | | | |
| | <i>Other [bit]</i> | Source selection (See 130 on page Terms and abbreviations). | - | | | | | | | | | | | | | | | |

| Serial number | Name/Value | Description | Def/FbEq16 | | | | | | | | | | | | | | | | | | | | |
|---------------|----------------------------------------------------------------------------------------------------------------------------------------------------------------------------------------------------------------------------------------------------------------------------------------------------------------------------------------------------------------------------------------------------------------------------------------------------------------------------------------------------------------------------------|-----------------------------------------------------------------------------------------------------------------------------------------------------------------------------------------------------------------------------------------------------------------------------------------------------------------------------------------------------------------------------------------------------------------------------------------------------------------------------------------------------------------------------|---------------------|-------------|---|-------------------|------------------|---|---------|--|---|------------------|------------------|---|---------|--|---|-------------|----------------------------------|--------|---------|--|--|
| 96.13 | <i>User macro I/O mode input 2</i> | See parameter 96.12 User macro I/O mode input 1 . | <i>Not selected</i> | | | | | | | | | | | | | | | | | | | | |
| 96.16 | <i>unit selection</i> | Selects the unit of parameters indicating power, temperature and torque. | 00000b | | | | | | | | | | | | | | | | | | | | |
| | <table border="1"> <thead> <tr> <th>Bit(s)</th> <th>Name</th> <th>Information</th> </tr> </thead> <tbody> <tr> <td>0</td> <td>power supply unit</td> <td>0 = kW 1 = hp</td> </tr> <tr> <td>1</td> <td>Reserve</td> <td></td> </tr> <tr> <td>2</td> <td>Temperature unit</td> <td>0 = °C 1 = °F</td> </tr> <tr> <td>3</td> <td>Reserve</td> <td></td> </tr> <tr> <td>4</td> <td>Torque unit</td> <td>0 = Nm (N-m) 1 = lbft (lb-ft)</td> </tr> <tr> <td>5...15</td> <td>Reserve</td> <td></td> </tr> </tbody> </table> | Bit(s) | Name | Information | 0 | power supply unit | 0 = kW 1 = hp | 1 | Reserve | | 2 | Temperature unit | 0 = °C 1 = °F | 3 | Reserve | | 4 | Torque unit | 0 = Nm (N-m) 1 = lbft (lb-ft) | 5...15 | Reserve | | |
| Bit(s) | Name | Information | | | | | | | | | | | | | | | | | | | | | |
| 0 | power supply unit | 0 = kW 1 = hp | | | | | | | | | | | | | | | | | | | | | |
| 1 | Reserve | | | | | | | | | | | | | | | | | | | | | | |
| 2 | Temperature unit | 0 = °C 1 = °F | | | | | | | | | | | | | | | | | | | | | |
| 3 | Reserve | | | | | | | | | | | | | | | | | | | | | | |
| 4 | Torque unit | 0 = Nm (N-m) 1 = lbft (lb-ft) | | | | | | | | | | | | | | | | | | | | | |
| 5...15 | Reserve | | | | | | | | | | | | | | | | | | | | | | |
| | 0000h...FFFFh | Unit selection word. | 1 = 1 | | | | | | | | | | | | | | | | | | | | |
| 96.20 | <i>Time sync primary source</i> | Defines the first priority external source for synchronization of the drive's time and date. The date and time can also be directly set into 96.24... 96.26 in which case this parameter is ignored. | Embedded FB | | | | | | | | | | | | | | | | | | | | |
| | Fieldbus A | Fieldbus interface A. | 3 | | | | | | | | | | | | | | | | | | | | |
| | Embedded FB | Embedded fieldbus interface. | 6 | | | | | | | | | | | | | | | | | | | | |
| | Panel link | Control panel, or the Drive composer PC tool connected to the control panel. | 8 | | | | | | | | | | | | | | | | | | | | |
| | Ethernet tool link | Drive composer PC tool through a FENA module. | 9 | | | | | | | | | | | | | | | | | | | | |
| 96.24 | <i>Full days since 1st Jan 1980</i> | The number of full days passed since beginning of the year 1980. This parameter, together with 96.25 Time in minutes within 24 h and 96.26 Time in ms within one minute makes it possible to set the date and time in the drive via the parameter interface from a fieldbus or application program. This may be necessary if the fieldbus protocol does not support time synchronization. | 12055 | | | | | | | | | | | | | | | | | | | | |
| | 1...59999 | Days since the beginning of 1980. | 1 = 1 | | | | | | | | | | | | | | | | | | | | |
| 96.25 | <i>Time in minutes within 24 h</i> | The number of full minutes passed since midnight. For example, the value 860 corresponds to 2:20 pm. See parameter 96.24 Full days since 1st Jan 1980 . | 0 min | | | | | | | | | | | | | | | | | | | | |
| | 1...1439 | Minutes since midnight. | 1 = 1 | | | | | | | | | | | | | | | | | | | | |
| 96.26 | <i>Time in ms within one minute</i> | The number of milliseconds passed since the previous minute. See parameter 96.24 Full days since 1st Jan 1980 . | 0 ms | | | | | | | | | | | | | | | | | | | | |
| | 0...59999 | Number of milliseconds since the last minute. | 1 = 1 | | | | | | | | | | | | | | | | | | | | |
| 96.54 | <i>Checksum action</i> | Selects how the drive reacts. <ul style="list-style-type: none"> when 96.55 Checksum control word, bit 8 = 1 (Approved checksum A): if the parameter checksum 96.68 Actual checksumA does not match 96.71 Approved checksum A, and/or when 96.55 Checksum control word, bit 9 = 1 (Approved checksum B): if the parameter checksum 96.69 Actual checksumB does not match 96.72 Approved checksum B. | No action | | | | | | | | | | | | | | | | | | | | |
| | No action | No action taken. (The checksum feature is not in use.) | 0 | | | | | | | | | | | | | | | | | | | | |

| Serial number | Name/Value | Description | Def/FbEq16 | | | | | | | | | | | | | | | | | | | | | | | | | | | |
|---------------|------------------------------|---------------------------------------------------------------------------------------------------------------------------------------------------------------------------------------------------------------------------------------------------------------------------------------------------------------------------------------------------------------------------------------------------------------------------------------------------------------------------------------------------------------------------------------------------------------------------------------------------------------------------------------------------------------------------------------------------------------------------------------------------------------------------------------------------------------------------------------------------------------------------------------------------------------------------------------------------|------------|------|-------------|-------|----------|--|---|---------------------|------------------------------------------------------------------------|---|---------------------|------------------------------------------------------------------------|---------|----------|--|----|-------------------------|-------------------------------------------------------------------------------------------|----|-------------------------|-------------------------------------------------------------------------------------------|--|--|------------------|---------|----------|--|--|
| | Pure event | The drive generates an event log entry (<i>B686 Checksum mismatch</i>). | 1 | | | | | | | | | | | | | | | | | | | | | | | | | | | |
| | Warning | The drive generates a warning (<i>A686 Checksum mismatch</i>). | 2 | | | | | | | | | | | | | | | | | | | | | | | | | | | |
| | Warning and prevent start | The drive generates a warning (<i>A686 Checksum mismatch</i>). Starting the drive is prevented. | 3 | | | | | | | | | | | | | | | | | | | | | | | | | | | |
| | Fault | The drive trips on <i>6200 Checksum mismatch</i> . | 4 | | | | | | | | | | | | | | | | | | | | | | | | | | | |
| 96.55 | <i>Checksum control word</i> | <p>Bits 8...9 select which comparison(s) are made:</p> <ul style="list-style-type: none"> Bit 8 = 1 (Approved checksum A): <i>96.68 Actual checksumA</i> is compared to <i>96.71 Approved checksum A</i>, and/or Bit 9 = 1 (Approved checksum A): if <i>96.69 Actual checksumB</i> is compared to <i>96.72 Approved checksum B</i>. <p>Bits 12...13 select approved (reference) checksum parameter(s) into which the actual checksum(s) from parameter(s) are copied:</p> <ul style="list-style-type: none"> Bit 12 = 1 (Set approved checksum A): Value of <i>96.68 Actual checksumA</i> is copied into <i>96.71 Approved checksum A</i>, and/or Bit 13 = 1 (Set approved checksum B): Value of <i>96.69 Actual checksumB</i> copied into <i>96.72 Approved checksum B</i>. | 00000000h | | | | | | | | | | | | | | | | | | | | | | | | | | | |
| | | <table border="1"> <thead> <tr> <th>Bit</th> <th>Name</th> <th>Information</th> </tr> </thead> <tbody> <tr> <td>0...7</td> <td>Reserved</td> <td></td> </tr> <tr> <td>8</td> <td>Approved checksum A</td> <td>1 = Enabled: Checksum A (<i>96.71</i>) is observed. 0 = Disabled.</td> </tr> <tr> <td>9</td> <td>Approved checksum B</td> <td>1 = Enabled: Checksum B (<i>96.72</i>) is observed. 0 = Disabled.</td> </tr> <tr> <td>10...11</td> <td>Reserved</td> <td></td> </tr> <tr> <td>12</td> <td>Set approved checksum A</td> <td>1 = Set: Copy value of <i>96.68</i> into <i>96.71</i>. 0 = Done (copy has been made).</td> </tr> <tr> <td>13</td> <td>Set approved checksum B</td> <td>1 = Set: Copy value of <i>96.69</i> into <i>96.72</i>. 0 = Done (copy has been made).</td> </tr> <tr> <td></td> <td></td> <td>1 = lbft (lb-ft)</td> </tr> <tr> <td>14...15</td> <td>Reserved</td> <td></td> </tr> </tbody> </table> | Bit | Name | Information | 0...7 | Reserved | | 8 | Approved checksum A | 1 = Enabled: Checksum A (<i>96.71</i>) is observed. 0 = Disabled. | 9 | Approved checksum B | 1 = Enabled: Checksum B (<i>96.72</i>) is observed. 0 = Disabled. | 10...11 | Reserved | | 12 | Set approved checksum A | 1 = Set: Copy value of <i>96.68</i> into <i>96.71</i> . 0 = Done (copy has been made). | 13 | Set approved checksum B | 1 = Set: Copy value of <i>96.69</i> into <i>96.72</i> . 0 = Done (copy has been made). | | | 1 = lbft (lb-ft) | 14...15 | Reserved | | |
| Bit | Name | Information | | | | | | | | | | | | | | | | | | | | | | | | | | | | |
| 0...7 | Reserved | | | | | | | | | | | | | | | | | | | | | | | | | | | | | |
| 8 | Approved checksum A | 1 = Enabled: Checksum A (<i>96.71</i>) is observed. 0 = Disabled. | | | | | | | | | | | | | | | | | | | | | | | | | | | | |
| 9 | Approved checksum B | 1 = Enabled: Checksum B (<i>96.72</i>) is observed. 0 = Disabled. | | | | | | | | | | | | | | | | | | | | | | | | | | | | |
| 10...11 | Reserved | | | | | | | | | | | | | | | | | | | | | | | | | | | | | |
| 12 | Set approved checksum A | 1 = Set: Copy value of <i>96.68</i> into <i>96.71</i> . 0 = Done (copy has been made). | | | | | | | | | | | | | | | | | | | | | | | | | | | | |
| 13 | Set approved checksum B | 1 = Set: Copy value of <i>96.69</i> into <i>96.72</i> . 0 = Done (copy has been made). | | | | | | | | | | | | | | | | | | | | | | | | | | | | |
| | | 1 = lbft (lb-ft) | | | | | | | | | | | | | | | | | | | | | | | | | | | | |
| 14...15 | Reserved | | | | | | | | | | | | | | | | | | | | | | | | | | | | | |
| | 00000000... FFFFFFFFh | Checksum control word. | 1 = 1 | | | | | | | | | | | | | | | | | | | | | | | | | | | |
| 96.68 | <i>Actual checksumA</i> | <p>Displays the actual parameter configuration checksum A. The checksum A is generated and updated whenever an action is selected in <i>96.54 Checksum action</i> and <i>96.55 Checksum control word</i>, bit 8 = 1 (Approved checksum A). Checksum A calculation does not include</p> <ul style="list-style-type: none"> fieldbus settings. <p>The parameters included in the calculation are user editable parameters in parameter groups 10, 11, 12, 13, 15, 19, 20, 21, 22, 23, 24, 25, 28, 30, 31, 32, 34, 35, 36, 37, 40, 41, 43, 45, 46, 70, 71, 72, 73, 74, 76, 80, 94, 95, 96, 97, 98, 99. See also section <i>Parameter checksum calculation</i> (page 208).</p> | 0h | | | | | | | | | | | | | | | | | | | | | | | | | | | |
| | 00000000... FFFFFFFFh | Actual checksum. | - | | | | | | | | | | | | | | | | | | | | | | | | | | | |

| Serial number | Name/Value | Description | Def/FbEq16 |
|---------------|-------------------------------|-------------------------------------------------------------------------------------------------------------------------------------------------------------------------------------------------------------------------------------------------------------------------------------------------------------------------------------------------------------------------------------------------------------------------------------------------------------------------------------------------------------------------------------------------------------------------------------------------------------------------------------------------------------------------------------------------------------------------------------------------------------------------------|--------------|
| 96.69 | <i>Actual checksumB</i> | Displays the actual parameter configuration checksum B. The checksum B is generated and updated whenever an action is selected in 96.54 Checksum action and 96.55 Checksum control word , bit 9 = 1 (Approved checksum B). Checksum B calculation does not include <ul style="list-style-type: none"> • fieldbus settings • motor data settings • energy data settings. The parameters included in the calculation are user editable parameters in parameter groups 10, 11, 12, 13, 15, 19, 20, 21, 22, 23, 24, 25, 28, 30, 31, 32, 34, 35, 36, 37, 40, 41, 43, 46, 70, 71, 72, 73, 74, 76, 80, 94, 95, 96, 97. See also section Parameter checksum calculation (page 208). | 0h |
| | 00000000h... FFFFFFFFh | Actual checksum. | - |
| 96.71 | <i>Approved checksum A</i> | Approved (reference) checksum A. | 0h |
| | 00000000h... FFFFFFFFh | Approved checksum A. | - |
| 96.72 | <i>Approved checksum B</i> | Approved (reference) checksum B. | 0h |
| | 00000000h... FFFFFFFFh | Approved checksum B. | - |
| 96.78 | <i>550 compatibility mode</i> | Enables/disables a Modbus user to access a select set of parameters using 550 register numbering. See the supported parameters in section Parameters supported by Modbus backwards compatibility with 550 on page 478 . | Disable |
| | Disable | Using 550 compatibility mode is disabled. | 0 |
| | Enable | Using 550 compatibility mode is enabled. | 1 |
| 96.79 | <i>Legacy control profile</i> | Enables using a legacy control profile. Currently only EFB supports legacy profiles. | Not selected |
| | Not selected | EFB: Control profile selected with 58.25 Profile used. | 0 |
| | DCU | Legacy DCU profile used. | 1 |
| | ABB drives | ABB drives profile used. | 2 |
| | ABB drives limited | Legacy ABB drives limited profile used. | 3 |

| Serial number | Name/Value | Description | Def/FbEq16 | | | | | | | | | | | | | | | | | | | | | | | | | | | |
|-----------------------------------------------------------------------------------------------------------------------------------------------------------------------------------------------------------------------------------------------------------------------------------------------------------------------------------------------------------------------------------------------------------------------------------------------------------------------------------------------------------------------------------------------------------------------------------------------------------------------------------------------------------------------------------------------------------------------------------------------------------------------------------------------------------------------------------------------------------------------------------------------------------------------------------------------------------------------------------------------------------------------------------------------------------------------------------------------------------------------------------------------------------------------------------------------------------------------------------------------------------------------------------------------------------------------------------------------------------------------------------------------------------------------------------------------------------------------------------------------|--------------------------------|------------------------------------------------------------------------------------------------------------------------------------------------------------------------------------------------------------------------------------------------------------------------------------------------------------------------------------------------------------------------------------------------------------------------------------------------------------------------------------------------------------------------------------------|------------|--------|------|-------------|---|---------------------------|-------------------------------------------------------------------------------------------------------------|---|--------------------------------|------------------------------------------------------------------------------------|---|------------------------|-----------------------------------------------------------------------------------------------------------------------------------------------------------------------------------------------------------------------------------------------------------------------------------------------------------------------------------------------------------------------------------------------------------------------------------------------------------------------------------------------------|--------|---------|--|----|-----------------------------|------------------------------------------|----|-----------------------------|------------------------------------------|----|-----------------------------|------------------------------------------|---------|---------|--|
| 96.100 | <i>change user password</i> | (visible when the user lock turns on) For change of current user password, enter a new password in the parameter and 96.101 Confirm user password . The alarm will disappear after new password confirmation. For cancellation of password change, turn off unconfirmed user lock. For turning off the lock, enter a valid password in 96.02 Passcode for activation of 96.08 Control board boot , or circulating power supply. See User lock section (Page 78). | 10000000 | | | | | | | | | | | | | | | | | | | | | | | | | | | |
| | 10000000... 99999999 | New user password. | - | | | | | | | | | | | | | | | | | | | | | | | | | | | |
| 96.101 | <i>Confirm user password</i> | (visible when the user lock turns on) Confirm new password in the input parameter 96.100 change user password . | | | | | | | | | | | | | | | | | | | | | | | | | | | | |
| | 10000000... 99999999 | Confirm new user password. | - | | | | | | | | | | | | | | | | | | | | | | | | | | | |
| 96.102 | <i>user lock function</i> | (visible when the user lock turns on) Select the action or function blocked by the user lock. The change will enter into force only when the user lock turns off. See the parameter 96.02 Passcode . Note: you should select all actions and functions, unless otherwise required by applications. | 0000h | | | | | | | | | | | | | | | | | | | | | | | | | | | |
| <table border="1"> <thead> <tr> <th>Bit(s)</th> <th>Name</th> <th>Description</th> </tr> </thead> <tbody> <tr> <td>0</td> <td>ABB access blocking level</td> <td>1 = ABB access level ((service, senior programmer, etc.; see the parameter 96.03) blocking</td> </tr> <tr> <td>1</td> <td>freezing parameter lock status</td> <td>1 = prevent change of parameter lock status, that is, the password 358 is invalid.</td> </tr> <tr> <td>2</td> <td>File download blocking</td> <td>1 = Block the drive for file download. Applications: <ul style="list-style-type: none"> • Firmware upgrade • Param restore • Custom programming download • Download and debugging of application program • Control panel homepage change • Edit drive text • Edit collected parameter list on the control panel • Configure settings by control panel, such as / time/date format and enable / disable clock display. </td> </tr> <tr> <td>3...10</td> <td>Reserve</td> <td></td> </tr> <tr> <td>11</td> <td>OEM access blocking level 1</td> <td>1 = OEM access blocking level 1 blocking</td> </tr> <tr> <td>12</td> <td>OEM access blocking level 2</td> <td>1 = OEM access blocking level 2 blocking</td> </tr> <tr> <td>13</td> <td>OEM access blocking level 3</td> <td>1 = OEM access blocking level 3 blocking</td> </tr> <tr> <td>14...15</td> <td>Reserve</td> <td></td> </tr> </tbody> </table> | | | | Bit(s) | Name | Description | 0 | ABB access blocking level | 1 = ABB access level ((service, senior programmer, etc.; see the parameter 96.03) blocking | 1 | freezing parameter lock status | 1 = prevent change of parameter lock status, that is, the password 358 is invalid. | 2 | File download blocking | 1 = Block the drive for file download. Applications: <ul style="list-style-type: none"> • Firmware upgrade • Param restore • Custom programming download • Download and debugging of application program • Control panel homepage change • Edit drive text • Edit collected parameter list on the control panel • Configure settings by control panel, such as / time/date format and enable / disable clock display. | 3...10 | Reserve | | 11 | OEM access blocking level 1 | 1 = OEM access blocking level 1 blocking | 12 | OEM access blocking level 2 | 1 = OEM access blocking level 2 blocking | 13 | OEM access blocking level 3 | 1 = OEM access blocking level 3 blocking | 14...15 | Reserve | |
| Bit(s) | Name | Description | | | | | | | | | | | | | | | | | | | | | | | | | | | | |
| 0 | ABB access blocking level | 1 = ABB access level ((service, senior programmer, etc.; see the parameter 96.03) blocking | | | | | | | | | | | | | | | | | | | | | | | | | | | | |
| 1 | freezing parameter lock status | 1 = prevent change of parameter lock status, that is, the password 358 is invalid. | | | | | | | | | | | | | | | | | | | | | | | | | | | | |
| 2 | File download blocking | 1 = Block the drive for file download. Applications: <ul style="list-style-type: none"> • Firmware upgrade • Param restore • Custom programming download • Download and debugging of application program • Control panel homepage change • Edit drive text • Edit collected parameter list on the control panel • Configure settings by control panel, such as / time/date format and enable / disable clock display. | | | | | | | | | | | | | | | | | | | | | | | | | | | | |
| 3...10 | Reserve | | | | | | | | | | | | | | | | | | | | | | | | | | | | | |
| 11 | OEM access blocking level 1 | 1 = OEM access blocking level 1 blocking | | | | | | | | | | | | | | | | | | | | | | | | | | | | |
| 12 | OEM access blocking level 2 | 1 = OEM access blocking level 2 blocking | | | | | | | | | | | | | | | | | | | | | | | | | | | | |
| 13 | OEM access blocking level 3 | 1 = OEM access blocking level 3 blocking | | | | | | | | | | | | | | | | | | | | | | | | | | | | |
| 14...15 | Reserve | | | | | | | | | | | | | | | | | | | | | | | | | | | | | |
| | 0000h...FFFFh | Select the action blocked by the user lock. | - | | | | | | | | | | | | | | | | | | | | | | | | | | | |

| Serial number | Name/Value | Description | Def/FbEq16 |
|-------------------------|--------------------------------------|------------------------------------------------------------------------------------------------------------------------------------------------------------------------------------------------------------------------------------------------------------------------------------------------------------------------------------------------------------------------------------------------------------------------------------------------------------------------------------------------------------------------------------------------------------------------------------------------------------------------------------------------------------------------------------------------------------------------------------------------------------------------------------------------------------------------------------------------------------------------------------------------------|------------|
| 97 Motor control | | Switching frequency; slip compensation; anti-clogging (signal injection); IR compensation. | |
| 97.01 | <i>Switching frequency reference</i> | Defines the switching frequency of the drive that is used as long as the drive does not heat too much. Depends on the frame size. See section 54 on page Switching frequency. See section <i>Switching frequency</i> on page 72. Higher switching frequency results in lower acoustic noise. In multimotor systems, do not change the switching frequency from the default value. | 2 kHz |
| | 2 kHz | 2 kHz, Frame size R6~R9. | 2 |
| | 4 kHz | 4 kHz. | 4 |
| | 8 kHz | 8 kHz. | 8 |
| 97.02 | <i>Minimum switching frequency</i> | Lowest switching frequency that is allowed. Depends on the frame size. | 1.5 kHz |
| | 1.5 kHz | 1.5 kHz. Depends on the frame size. B0~B2, R6~R9. | 1 |
| | 2 kHz | 2 kHz. | 2 |
| | 4 kHz | 4 kHz. | 4 |
| | 8 kHz | 8 kHz. | 8 |
| 97.04 | <i>Voltage reserve</i> | Defines the minimum allowed voltage reserve. When the voltage reserve has decreased to the set value, the drive enters the field weakening area. Note: This is an expert level parameter and should not be adjusted without appropriate skill. If the intermediate circuit DC voltage $U_{dc} = 550 \text{ V}$ and the voltage reserve is 5%, the RMS value of the maximum output voltage in steady-state operation is $0.95 \times 550 \text{ V} / \sqrt{2} = 369 \text{ V}$ The dynamic performance of the motor control in the field weakening area can be improved by increasing the voltage reserve value, but the drive enters the field weakening area earlier. Warning: Decreasing the voltage reserve parameter to -5% to get higher voltage leads to higher harmonics in output current, typically 8 - 10%, as the drive is operating in over-modulation region. | -2% |
| | -5...50% | Voltage reserve. | 1 = 1% |

| Serial number | Name/Value | Description | Def/FbEq16 |
|---------------|-----------------------------|----------------------------------------------------------------------------------------------------------------------------------------------------------------------------------------------------------------------------------------------------------------------------------------------------------------------------------------------------------------------------------------------|------------|
| 97.13 | <i>IR compensation</i> | <p>Defines the relative output voltage boost at zero speed (IR compensation). The function is useful in applications with a high break-away torque where vector control cannot be applied.</p> | 3.50% |
| | 0.00...50.00% | Voltage boost at zero speed in percent of nominal motor voltage. | 1 = 1% |
| 97.20 | <i>U/f ratio</i> | Selects the form for the U/f (voltage to frequency) ratio below field weakening point. For scalar control only. | Squared |
| | Linear | Linear ratio for constant torque applications. | 0 |
| | Squared | Squared ratio for centrifugal pump and fan applications. With squared U/f ratio the noise level is lower for most operating frequencies. Not recommended for permanent magnet motors. | 1 |
| 97.48 | <i>Udc stabilizer</i> | Enables or disables the DC bus voltage stabilizer. | Disabled |
| | Disabled | DC bus voltage stabilizer disabled. | 0 |
| | Enabled min | DC bus voltage stabilizer enabled, minimum stabilization. | 50 |
| | Enabled mild | DC bus voltage stabilizer enabled, mild stabilization. | 100 |
| | Enabled medium | DC bus voltage stabilizer enabled, medium stabilization. | 300 |
| | Enabled strong | DC bus voltage stabilizer enabled, strong stabilization. | 500 |
| | Enabled max | DC bus voltage stabilizer enabled, maximum stabilization. | 800 |
| 97.49 | <i>Slip gain for scalar</i> | <p>Sets gain for slip compensation in percent when the drive is operating in scalar control mode.</p> <p>A squirrel-cage motor slips under load. Increasing the frequency as the motor torque increases compensates for the slip.</p> <p>Note: This parameter is only effective in scalar motor control mode (parameter <i>99.04 Motor control mode</i> is set to <i>Scalar</i>).</p> | 0% |
| | 0...200% | <p>0% = No slip compensation.</p> <p>0...200% = Increasing slip compensation. 100% means full slip compensation according to parameter <i>99.08 Motor nominal frequency</i> and <i>99.04 Motor control mode</i>.</p> | 1 = 1% |

| Serial number | Name/Value | Description | Def/FbEq16 |
|----------------------|------------------------------|---------------------------------------------------------------------------------------------------------------------------------------------------------------------------------------------------------------------------------------------------------------------------------------------------------------------------------------------------------------------------------------------------------------------------------------------------------------------------------------------------------------------------------------------------------------------------------------------------------------------------------------------------------------------------------------------------------------------------------------------------------------------------------------------------------------------------------------------------------------------------------------------------------------------------------------------------------|------------|
| 97.94 | <i>IR comp max frequency</i> | Sets the frequency at which IR compensation set by parameter 97.13 IR compensation reaches 0 V. Unit is percent of the motor nominal frequency. | 50.0% |
| | 1.0...200.0% | Frequency. | 1 = 1% |
| 97.135 | <i>Udc ripple</i> | Calculates ripple voltage. | 0.0 V |
| | 0.0...200.0 V | Voltage. | 1 = 1 V |
| 99 Motor data | | Motor configuration settings. | |
| 99.04 | <i>Motor control mode</i> | Selects the motor control mode. | Scalar |
| | Scalar | Scalar control. Suitable for most applications, if top performance is not required. Motor identification run is not required. Note: Scalar control must be used in the following situations: <ul style="list-style-type: none"> with multimotor applications 1) if the load is not equally shared between the motors, 2) if the motors are of different sizes, or 3) if the motors are going to be changed after the motor identification (ID run) if the nominal current of the motor is less than 1/6 of the nominal output current of the drive. if the drive is used with no motor connected (for example, for test purposes). Note: Correct motor operation requires that the magnetizing current of the motor does not exceed 90% of the nominal | 1 |
| 99.06 | <i>Motor nominal current</i> | Defines the nominal motor current. Must be equal to the value on the motor rating plate. If multiple motors are connected to the drive, enter the total current of the motors. Notes: <ul style="list-style-type: none"> Correct motor operation requires that the magnetizing current of the motor does not exceed 90% of the nominal current of the drive. The parameter cannot be changed while the drive is running. | 0.0 A |
| | 0.0...6400.0 A | Nominal current of the motor. The allowable range is 1/6...2 x <i>in</i> of the drive(0...2 x <i>in</i> with scalar control mode). | 1 = 1 A |
| 99.07 | <i>Motor nominal voltage</i> | Defines the nominal motor voltage supplied to the motor. The setting must match the value on the rating plate of the motor. Notes: <ul style="list-style-type: none"> With permanent magnet motors, the nominal voltage is the BackEMF voltage at nominal speed of the motor. If the voltage is given as voltage per rpm, e.g. 60 V per 1000 rpm, the voltage for a nominal speed of 3000 rpm is 3 x 60 V = 180 V. Note that the nominal voltage is not equal to the equivalent DC motor voltage (EDCM) specified by some motor manufacturers. The nominal voltage can be calculated by dividing the EDCM voltage by 1.7 (or square root of 3). The stress on the motor insulation is always dependent on the drive supply voltage. This also applies to the case where the motor voltage rating is lower than that of the drive and the supply. The parameter cannot be changed while the drive is running. | 0.0 V |
| | 0.0...800.0 | Nominal voltage of the motor. | 10 = 1 V |

| Serial number | Name/Value | Description | Def/FbEq16 |
|---------------|---------------------------------------------------------------|------------------------------------------------------------------------------------------------------------------------------------------------------------------------------------------------------------------------------------------------------------------------------------------------------------------------------------------------------------------------------------------------------------------------------------------------------------------------------------------------------------------------------------|--------------------|
| 99.08 | <i>Motor nominal frequency</i> | Defines the nominal motor frequency. The setting must match the value on the rating plate of the motor. Note: The parameter cannot be changed while the drive is running. | 50.0 Hz |
| | 0.0...500.0 Hz | Nominal frequency of the motor. | 10 = 1 Hz |
| 99.09 | <i>Motor nominal speed</i> | Defines the nominal motor speed. The setting must match the value on the rating plate of the motor. Note: The parameter cannot be changed while the drive is running. | 0 rpm |
| | 0... 30000 rpm | Nominal speed of the motor. | 1 = 1 rpm |
| 99.10 | <i>Motor nominal power</i> | Defines the nominal motor power. The setting must match the value on the rating plate of the motor. If multiple motors are connected to the drive, enter the total power of the motors. The unit is selected with parameter 96.16 unit selection . Note: The parameter cannot be changed while the drive is running. | 0.00 kW or hp |
| | -10000.00... 10000.00 kW or -13404.83... 13404.83 hp | Nominal power of the motor. | 1 = 1 unit |
| 99.11 | <i>Motor nominal power factor</i> | Defines the cosphi of the motor for a more accurate motor model. (Not applicable to permanent magnet motors.) Not obligatory; if set, it should match the value on the rating plate of the motor. Note: The parameter cannot be changed while the drive is running. | 0.00 |
| | 0.00...1.00 | Cosphi of the motor. | 100 = 1 |
| 99.12 | <i>Motor nominal torque</i> | Defines the nominal motor shaft torque for a more accurate motor model. Not obligatory. The unit is selected with parameter 96.16 unit selection . Note: The parameter cannot be changed while the drive is running. | 0.000 N-m or lb-ft |
| | 0.000... N-m or lb-ft | Nominal motor torque. | 1 = 100 unit |
| 99.15 | <i>Motor pole-pairs calculated</i> | Calculated number of pole pairs in the motor. | 0 |
| | 0...1000 | Number of pole pairs. | 1 = 1 |
| 99.16 | <i>Motor phase order</i> | Switches the rotation direction of motor. This parameter can be used if the motor turns in the wrong direction (for example, because of the wrong phase order in the motor cable), and correcting the cabling is considered impractical. Notes: <ul style="list-style-type: none"> Changing this parameter does not affect speed reference polarities, so positive speed reference will rotate the motor forward. The phase order selection just ensures that "forward" is in fact the correct direction. | U V W |
| | U V W | Normal. | 0 |
| | U W V | Reversed rotation direction. | 1 |



Fieldbus control

Controlled through an embedded fieldbus interface (EFB)

What this chapter contains

The chapter describes how the drive can be controlled by external devices over a communication network (fieldbus) using the embedded fieldbus interface.

System overview

The drive can be connected to an external control system through a communication link using either a fieldbus adapter or an embedded fieldbus interface.

The embedded fieldbus interface supports the Modbus RTU protocol. The drive control program can receive and send cyclic data from and to the Modbus master on 10 ms time level. The actual response time depends on other factors as well, such as the baud rate (a parameter setting in the drive).

The drive can be set to receive all of its control information through the fieldbus interface, or the control can be distributed between the embedded fieldbus interface and other available sources, for example, digital and analog inputs

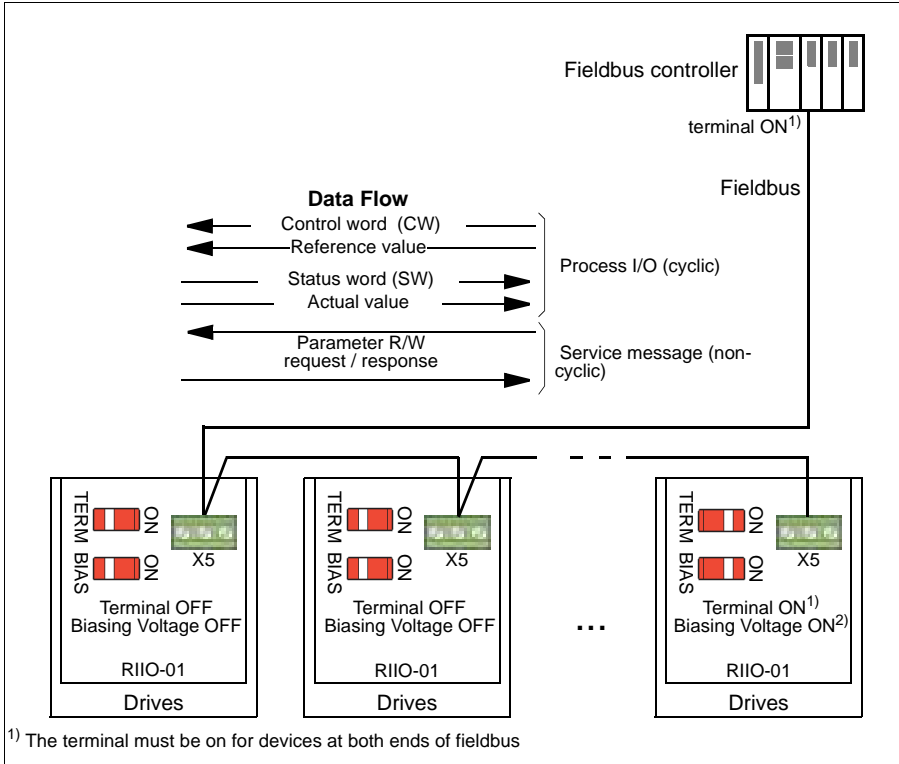

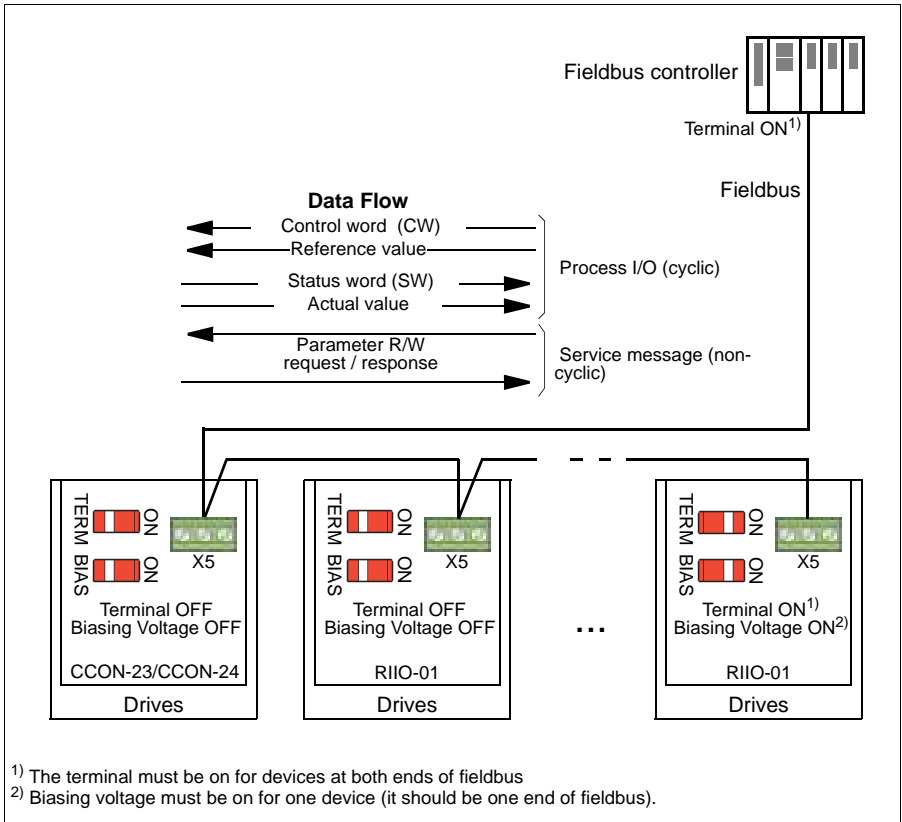

Connecting the fieldbus to the drive

Connect the fieldbus to terminal X5 on the CEIA-01, which is attached on the control unit of the drive. The connection diagram is shown below.

Setting up the embedded fieldbus interface

Set the drive up for the embedded fieldbus communication with the parameters shown in the table below. **The fieldbus control settings** column gives either the value to use or the default value **The Function/Information** column gives a description of the parameter.

| Parameters | Fieldbus control Settings | Function/Information |
|-----------------------------------------------------------------------------------------------------------|-----------------------------------------------------------------------------------------------|----------------------------------------------------------------------------------------------------------------------------------------------------------------------------------------------------------------------------------------------------------------|
| COMMUNICATION INITIALIZATION | | |
| 58.01 <i>Protocol enable</i> | <i>Modbus RTU</i> | Initializes embedded fieldbus communication. |
| EMBEDDED MODBUS CONFIGURATION | | |
| 58.03 <i>Node address</i> | 1 (default) | Node address. There must be no two nodes with the same node address online. |
| 58.04 <i>Baud rate</i> | <i>19.2 kbps</i> (default) | Defines the communication speed of the link. Use the same setting as in the master station. |
| 58.05 <i>Parity</i> | <i>8 EVEN 1</i> (default) | Defines the communication speed of the link. Use the same setting as in the master station. |
| 58.14 <i>Communication loss action</i> | <i>n/a</i> (default) | Defines the action taken when a communication loss is detected. |
| 58.15 <i>Communication loss mode</i> | <i>Any message</i> (default) | Enables/disables communication loss monitoring and defines the means for resetting the counter of the communication loss delay. |
| 58.16 <i>Communication loss time</i> | 30.0 s (default) | Defines the timeout limit for the communication monitoring. |
| 58.17 <i>Transmit delay</i> | 0 ms (default) | Defines a response delay for the drive. |
| 58.25 <i>Profile</i> | <i>ABB Drives</i> (default) | Selects the control profile used by the drive. See section <i>Basics of the embedded fieldbus interface</i> (page 317). |
| 58.26 <i>EFB ref1 type</i> ... 58.29 <i>EFB actual value 2 type</i> | <i>Speed or frequency</i> (default), <i>Transparent, General, Torque, Speed, Frequency</i> | Selects the reference and actual value types. With the <i>Speed or frequency</i> setting, the type is selected automatically according to the currently active drive control mode. |
| 58.33 <i>Addressing mode</i> | <i>Mode 0</i> (default) | Defines the mapping between parameters and holding registers in the 100...65535 Modbus register range. |
| 58.34 <i>Word order</i> | <i>Low - High</i> (default) | Defines the order of the data words in the Modbus message frame. |
| 58.101 <i>Data I/O 1</i> ... 58.114 <i>Data I/O 14</i> | <i>n/a</i> (default) | Defines the address of the drive parameter which the Modbus master accesses when it reads from or writes to the register address corresponding to Modbus In/Out parameters. Select the parameters that you want to read or write through the Modbus I/O words. |

| Parameters | Fieldbus control Settings | Function/Information |
|----------------------------------------------------|---------------------------|---------------------------------------------------------|
| 58.06 <i>Communication control</i> | <i>Refresh settings</i> | Validates the settings of the configuration parameters. |

The new settings will take effect when the drive is powered up the next time, or when they are validated by parameter [58.06](#)*Communication control*.

Setting the drive control parameters

After the embedded fieldbus interface has been set up, check and adjust the drive control parameters listed in the table below. **The fieldbus control settings** column gives the value or values to use when the embedded fieldbus signal is the desired source or destination for that particular drive control signal. **The Function/Information** column gives a description of the parameter.

| Parameter | Fieldbus control Settings | Function/Information |
|--------------------------------------------------------------------------------------------------------------------------------------------------------------------------------------------------------------------------------|-------------------------------------------------------------------------------------|-------------------------------------------------------------------------------------------------------------------------------------------------------------------------------------------------------------------------------------------------------------------------------------------------------|
| CONTROL COMMAND SOURCE SELECTION | | |
| 20.01 <i>Ext1 commands</i> | <i>Embedded fieldbus</i> | Selects fieldbus as the source of the start and stop commands when EXT1 is selected as the active control location. |
| 20.02 <i>Ext2 commands</i> | <i>Embedded fieldbus</i> | Selects fieldbus as the source of the start and stop commands when EXT2 is selected as the active control location. |
| Frequency reference selection | | |
| 28.11 <i>Ext1 frequency ref1</i> | <i>EFB reference 1</i> | Selects a reference received through the embedded fieldbus interface as frequency reference 1. |
| 28.15 <i>Ext2 frequency ref1</i> | <i>EFB reference 1</i> | Selects a reference received through the embedded fieldbus interface as frequency reference 2. |
| OTHER SELECTIONS | | |
| Efb references can be selected as the source at virtually any signal selector parameter by selecting <i>Other</i> , then either 03.09 <i>Efb reference 1</i> or 03.10 <i>Efb reference 2</i> . | | |
| REFERENCE TYPE AND SCALING | | |
| 58.26 <i>Efb ref1 type</i> 58.27 <i>Efb ref 2 type</i> | <i>Speed or frequency (default), Transparent, General, Torque, Speed, Frequency</i> | Defines the types of fieldbus references 1 and 2. The scaling for each reference type is defined by parameters 46.01 ... 46.03 . With the <i>Speed or frequency</i> setting, the type is selected automatically according to the currently active drive control mode. |

| Parameter | Fieldbus control Settings | Function/Information |
|---------------------------------------------------------------------------------|-----------------------------------------------------------------------------------------------|-----------------------------------------------------------------------------------------------------------------------------------------------------------------------------------------------------------------------------------------------------------------|
| ACTUAL VALUE TYPE AND SCALING | | |
| 58.28 EFB actual value 1 type 58.29 EFB actual value 2 type | <i>Speed or frequency</i> (default), <i>Transparent, General, Torque, Speed, Frequency</i> | Defines the types of actual values 1 and 2. The scaling for each actual value type is defined by parameters 46.01...46.03. With the <i>Speed or frequency</i> setting, the type is selected automatically according to the currently active drive control mode. |
| ACTUAL VALUE SOURCE SELECTION (when <i>Transparent</i> type is selected) | | |
| 58.31 EFB act1 transparent source 58.32 EFB act2 transparent source | <i>Other</i> | Defines the source of actual values 1 and 2, when the selected type is <i>Transparent</i> . |
| SYSTEM CONTROL INPUTS | | |
| 96.07 Parameter save manually | <i>Save</i> (reverts to <i>Finalization</i>) | Save parameter value changes (including those made through fieldbus control) to permanent memory. |

Basics of the embedded fieldbus interface

The cyclic communication between a fieldbus system and the drive consists of 16-bit data words or 32-bit data words (with the transparent control profiles).

The diagram below illustrates the operation of the embedded fieldbus interface. The signals transferred in the cyclic communication are explained further below the diagram.

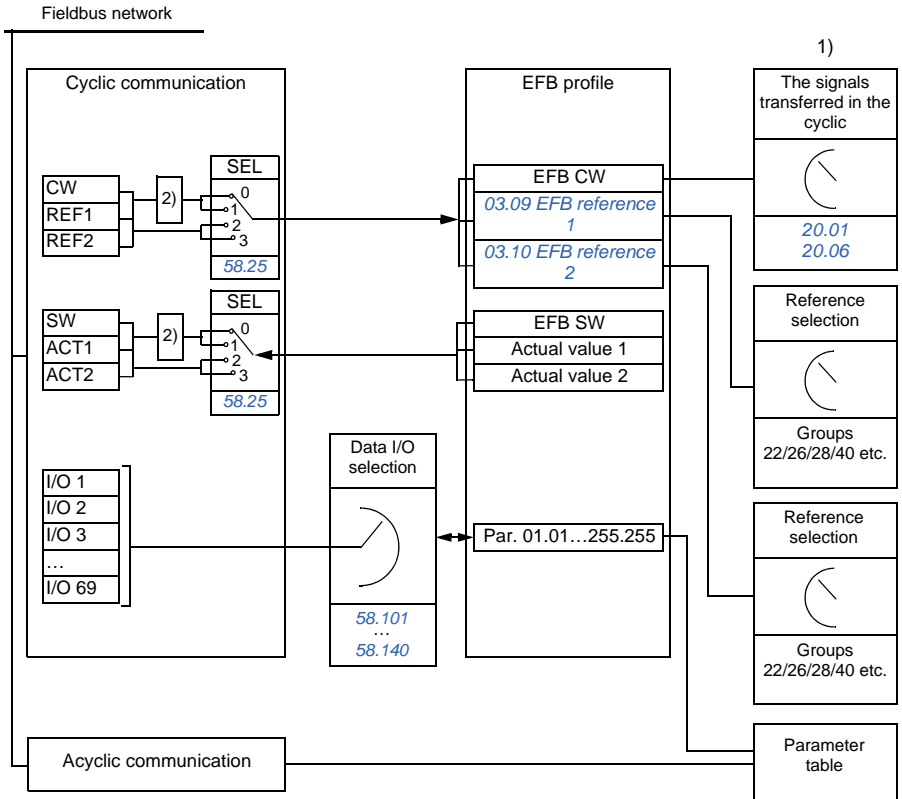

1. See also other parameters which can be controlled through fieldbus.

2. Data conversion if parameter *58.25 Profile* is set to *ABB Drives*. See *About the control profiles* section (on page 320).

■ Control word and Status word

The Control Word (CW) is a 16-bit or 32-bit packed boolean word. It is the principal means of controlling the drive from a fieldbus system. The CW is sent by the fieldbus controller to the drive. By drive parameters, the user selects the EFB CW as the source of drive control commands (such as start/stop, emergency stop, selection between external control locations 1/2 or fault reset). The drive switches between its states according to the bit-coded instructions of the CW.

The fieldbus CW is either written to the drive as it is or the data is converted. See [About the control profiles](#) section (on page 320).

The fieldbus Status Word (SW) is a 16-bit or 32-bit packed boolean word. It contains status information from the drive to the fieldbus controller. The drive SW is either written to the fieldbus SW as it is or the data is converted. See [About the control profiles](#) section (on page 320).

■ Reference value

EFB references 1 and 2 are 16-bit or 32-bit signed integers. The contents of each reference word can be used as the source of virtually any signal, such as the speed, frequency, torque or process reference. In embedded fieldbus communication, references 1 and 2 are displayed by [03.09 EFB reference 1](#) and [03.10 EFB reference 2](#) respectively. Whether the references are scaled or not depends on the settings of [58.26 EFB ref1 type](#) and [58.27 EFB ref 2 type](#). See [About the control profiles](#) section (on page 320).

■ Actual value

Fieldbus actual signals (ACT1 and ACT2) are 16-bit or 32-bit signed integers. They convey selected drive parameter values from the drive to the master. Whether the actual values are scaled or not depends on the settings of [58.28 EFB actual value 1 type](#) and [58.29 EFB actual value 2 type](#). See [About the control profiles](#) section (on page 320).

■ Data I/O

Parameters [58.101 Data I/O 1 ... 58.114 Data I/O 14](#) define the addresses from which the master either reads data (input) or to which it writes data (output).

■ Register addressing

The address field of Modbus Requests for accessing Holding registers is 16 bits. This allows the Modbus protocol to support addressing of 65536 holding registers.

Historically, Modbus master devices used 5-digit decimal addresses from 40001 to 49999 to represent Holding register addresses. The 5-digit decimal addressing limited to 9999 the number of holding registers that could be addressed.

Modbus master devices typically provide a means to access the full range of 65536 Modbus holding registers. One of these methods is to use 6-digit decimal addresses from 400001 to 465536. This manual uses 6-digit decimal addressing to represent Modbus holding register addresses.

Modbus master devices that are limited to the 5-digit decimal addressing may still access registers 400001 to 409999 by using 5-digit decimal addresses 40001 to 49999. Registers 410000-465536 are inaccessible to these masters.

Note: Register addresses of the 32-bit parameters cannot be accessed by using 5-digit register numbers.

About the control profiles

A control profile defines the rules for data transfer between the drive and the fieldbus master, for example:

- if packed boolean words are converted and how
- if signal values are scaled and how
- how drive register addresses are mapped for the fieldbus master.

You can configure the drive to receive and send messages according to one of the two profiles:

- [ABB Drives](#)
- [DCU Profile](#).

For the ABB Drives profile, the embedded fieldbus interface of the drive converts the fieldbus data to and from the native data used in the drive. The DCU Profile involves no data conversion or scaling. The figure below illustrates the effect of the profile selection.

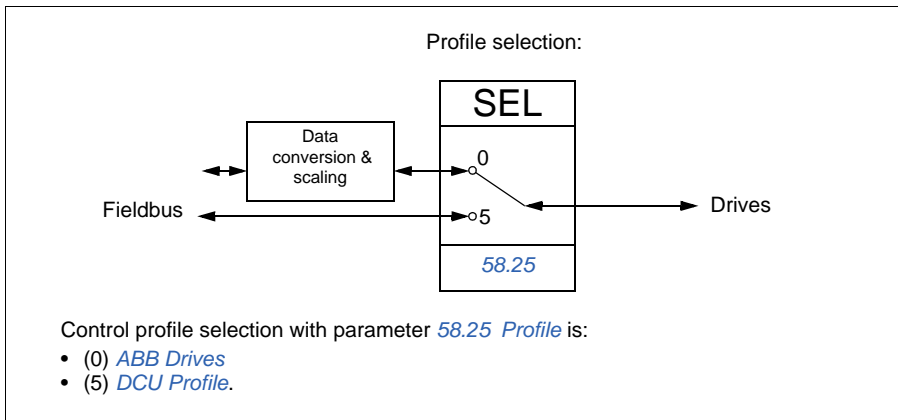

Control word

■ Control Word for the ABB Drives profile

The table below shows the contents of the fieldbus Control Word for the ABB Drives profile. The embedded fieldbus interface converts this word to the form in which it is used in the drive. The upper case boldface text refers to the states shown on [State transition diagram for the ABB Drives profile on page 328](#).

| Bit(s) | Name | Value | State/Description |
|--------|-------------------|-------|------------------------------------------------------------------------------------------------------------------------------------------------------------------------------------------------------------------------------|
| 0 | OFF1_CONTROL | 1 | Proceed to READY TO OPERATE. |
| | | 0 | Stop along currently active deceleration ramp. Proceed to OFF1 ACTIVE ; Proceed to READY TO SWITCH ON unless other interlocks (OFF2, OFF3) are active. |
| 1 | OFF2_CONTROL | 1 | Continue operation (OFF2 stopped). |
| | | 0 | Emergency OFF, coast to a stop. Proceed to OFF2 ACTIVE , Proceed to SWITCH-ON INHIBITED . |
| 2 | OFF3_CONTROL | 1 | Continue operation (OFF3 stopped). |
| | | 0 | Emergency stop, stop within time defined by drive parameter. Proceed to OFF3 ACTIVE ; Proceed to SWITCH-ON INHIBITED . Warning: Ensure motor and driven machine can be stopped using this stop mode. |
| 3 | inHIBIT_OPERATION | 1 | Proceed to OPERATION ENABLED . Note: Run enable signal must be active; see drive documentation. If the drive is set to receive the run enable signal from the fieldbus, this bit activates the signal. |
| | | 0 | Operation inhibited. Proceed to OPERATION INHIBITED . |
| 4 | RAMP_OUT_ZERO | 1 | Normal operation. Proceed to RAMP FUNCTION GENERATOR: OUTPUT ENABLED . |
| | | 0 | Force Ramp function generator output to zero. Drive ramps stop (current and DC voltage limits in force). |
| 5 | RAMP_HOLD | 1 | Enable ramp function. Proceed to RAMP FUNCTION GENERATOR: ACCELERATOR ENABLED . |
| | | 0 | Halt ramping (Ramp Function Generator output held). |
| 6 | RAMP_in_ZERO | 1 | Normal operation. Proceed to OPERATING . Note: This bit is effective only if the fieldbus interface is set as the source of this signal by drive parameters. |
| | | 0 | Force Ramp function generator input to zero. |
| 7 | RESET | 0...1 | Fault reset if an active fault exists. Proceed to SWITCH-ON INHIBITED . Note: This bit is effective only if the fieldbus interface is set as the source of this signal by drive parameters. |
| | | 0 | Continue nominal operation. |

| Bit(s)) | Name | Value | State/Description |
|-------------|------------------------|-------|----------------------------------------------------------------------------------------------------------------------------------------------------------------------------------------------------------------|
| 8 ...9 | Reserve | | |
| 10 | REMOTE_ CMD | 1 | Fieldbus control enabled. |
| | | 0 | Control word \neq 0 or reference \neq 0: retain last control word and reference. Control word = 0 and reference = 0: fieldbus control enabled. Reference and deceleration/acceleration ramp are locked. |
| 11 | External _CTRL_ LOC | 1 | Select External Control Location EXT2. Effective if the control location is parametrized to be selected from the fieldbus. |
| | | 0 | Select External Control Location EXT1. Effective if the control location is parametrized to be selected from the fieldbus. |
| 12 | USER_0 | | Writeable control bits that can be combined with drive logic for application-specific functionality. |
| 13 | USER_1 | | |
| 14 | USER_2 | | |
| 15 | USER_3 | | |

■ Control Word for the DCU Profile

The embedded fieldbus interface writes the fieldbus Control Word as is to the drive Control Word bits 0 to 15. Bits 16 to 32 of the drive Control Word are not in use.

| Bit(s) | Name | Value | State/Description |
|--------|----------------------|-------|----------------------------------------------------------------------------------------------------------------------------|
| 0 | STOP | 1 | Stop according to the Stop Mode parameter or the stop mode request bits (bits 7...9). |
| | | 0 | (no operation) |
| 1 | START | 1 | Start the drive. |
| | | 0 | (no operation) |
| 2 | Reserved for REVERSE | | Not yet implemented. |
| 3 | Reserve | | |
| 4 | RESET | 0...1 | Fault reset if an active fault exists. |
| | | 0 | (no operation) |
| 5 | EXT2 | 1 | Select External Control Location EXT2. Effective if the control location is parametrized to be selected from the fieldbus. |
| | | 0 | Select External Control Location EXT1. Effective if the control location is parametrized to be selected from the fieldbus. |

| Bit(s) | Name | Value | State/Description |
|--------|------------------------------|-------|-----------------------------------------------------------------------------------------------------------------------|
| 6 | RUN_DISABLE | 1 | Run disable. If the drive is set to receive the run enable signal from the fieldbus, this bit deactivates the signal. |
| | | 0 | Run enable. If the drive is set to receive the run enable signal from the fieldbus, this bit activates the signal. |
| 7 | STOPMODE_RAMP | 1 | Normal ramp stop mode |
| | | 0 | (no operation) Default to parameter stop mode if bits 7...9 are all 0. |
| 8 | STOPMODE_EMERGENCY_RAMP | 1 | Emergency ramp stop mode. |
| | | 0 | (no operation) Default to parameter stop mode if bits 7...9 are all 0. |
| 9 | STOPMODE_COAST | 1 | Coast stop mode. |
| | | 0 | (no operation) Default to parameter stop mode if bits 7...9 are all 0. |
| 10 | Reserved for RAMP_PAIR_2 | | Not yet implemented. |
| 11 | RAMP_OUT_ZERO | 1 | Force Ramp function generator output to zero. Drive ramps stop (current and DC voltage limits in force). |
| | | 0 | Normal operation. |
| 12 | RAMP_HOLD | 1 | Halt ramping (Ramp Function Generator output held). |
| | | 0 | Normal operation. |
| 13 | RAMP_in_ZERO | 1 | Force Ramp function generator input to zero. |
| | | 0 | Normal operation. |
| 14 | Reserved for REQ_LOCAL_LOCK | | Not yet implemented. |
| 15 | Reserved for TORQ_LIM_PAIR_2 | | Not yet implemented. |
| 16 | FB_LOCAL_CTL | 1 | Local mode for control from the fieldbus is requested. Steal control from the active source. |
| | | 0 | (no operation) |
| 17 | FB_LOCAL_REF | 1 | Local mode for reference from the fieldbus is requested. Steal reference from the active source. |
| | | 0 | (no operation) |
| 18 | Reserved for RUN_DISABLE_1 | | Not yet implemented. This is START_DISABLE_1 in HVAC. |
| 19 | Reserve | | |
| 20 | Reserve | | |
| 21 | Reserve | | |

| Bit(s) | Name | Value | State/Description |
|--------------|---------|-------|-------------------------------------------------------------------------------------------------------|
| 22 | USER_0 | | Write able control bits that can be combined with drive logic for application-specific functionality. |
| 23 | USER_1 | | |
| 24 | USER_2 | | |
| 25 | USER_3 | | |
| 26 ... 31 | Reserve | | |

Status word

■ Status Word for the ABB Drives profile

The table below shows the fieldbus Status Word for the ABB Drives control profile. The embedded fieldbus interface converts the drive Status Word into this form for the fieldbus. The upper case boldface text refers to the states shown on [State transition diagram for the ABB Drives profile on page 328](#).

| Bit(s) | Name | Value | State/Description |
|--------|------------------|-------|------------------------------------------------------------------------------------------------------------------------------------------------------|
| 0 | RDY_ON | 1 | READY TO SWITCH ON. |
| | | 0 | NOT READY TO SWITCH ON. |
| 1 | RDY_RUN | 1 | READY TO OPERATE. |
| | | 0 | OFF1 ACTIVE. |
| 2 | RDY_REF | 1 | OPERATION ENABLED. |
| | | 0 | OPERATION INHIBITED. |
| 3 | TRIPPED | 1 | FAULT. |
| | | 0 | No fault. |
| 4 | OFF_2_STATUS | 1 | OFF2 inactive. |
| | | 0 | OFF2 ACTIVE. |
| 5 | OFF_3_STATUS | 1 | OFF3 inactive. |
| | | 0 | OFF3 ACTIVE. |
| 6 | SWC_ON_ inHIB | 1 | SWITCH-ON INHIBITED. |
| | | 0 | – |
| 7 | ALARM | 1 | Warnings/Warnings |
| | | 0 | No warnings/Warnings |
| 8 | AT_ SETPOinT | 1 | OPERATING. Actual value equals Reference (is within tolerance limits, e.g. in speed control, speed error is 10% max. of nominal motor speed). |
| | | 0 | Actual value differs from Reference (is outside tolerance limits). |
| 9 | REMOTE | 1 | Drive control location: REMOTE (Ext1 or Ext2). |
| | | 0 | Drive control location: LOCAL. |
| 10 | ABOVE_ LIMIT | 1 | Actual frequency or speed equals or exceeds supervision limit (set by drive parameter). Valid in both directions of rotation. |
| | | 0 | Actual frequency or speed within supervision limit. |
| 11 | USER_0 | | Status bits that can be combined with drive logic for application-specific functionality. |
| 12 | USER_1 | | |
| 13 | USER_2 | | |
| 14 | USER_3 | | |
| 15 | Reserve | | |

■ Status Word for the DCU Profile

The embedded fieldbus interface writes the drive Status Word bits 0 to 15 to the fieldbus Status Word as is. Bits 16 to 32 of the drive Status Word are not in use.

| Bit(s) | Name | Value | State/Description |
|--------|--------------------------------|-------|-------------------------------------------------------------------------------------------------------------------------|
| 0 | READY | 1 | Drive is ready to receive the start command. |
| | | 0 | Drive is not ready. |
| 1 | ENABLED | 1 | External run enable signal is active. |
| | | 0 | External run enable signal is not active. |
| 2 | Reserved for ENABLED_TO_ROTATE | | Not yet implemented. This is STARTED in HVAC. |
| 3 | RUNNING | 1 | Drive is modulating. |
| | | 0 | Drive is not modulating. |
| 4 | ZERO_SPEED | 1 | Drive is at zero speed. |
| | | 0 | Drive is not at zero speed. |
| 5 | Reserved for ACCELERATING | | Not yet implemented. |
| 6 | Reserved for DECELERATING | | Not yet implemented. |
| 7 | AT_SETPOINT | 1 | Drive is at setpoint. |
| | | 0 | Drive is not at setpoint. |
| 8 | LIMIT | 1 | Drive operation is limited. |
| | | 0 | Drive operation is not limited. |
| 9 | SUPERVISION | 1 | Actual value (speed, frequency or torque) is above a limit. Actual value (speed, frequency or torque) is above a limit. |
| | | 0 | Actual value (speed, frequency or torque) is within limits. |
| 10 | Reserved for REVERSE_REF | | Not yet implemented. |
| 11 | Reserved for REVERSE_ACT | | Not yet implemented. |
| 12 | PANEL_LOCAL | 1 | Panel/keypad (or PC tool) is in local control mode. |
| | | 0 | Panel/keypad (or PC tool) is not in local control mode. |
| 13 | FIELDBUS_LOCAL | 1 | Fieldbus is in local control mode. |
| | | 0 | Fieldbus is not in local control mode. |
| 14 | Ext. 2_ACT | 1 | External control location EXT2 is active. |
| | | 0 | External control location EXT1 is active. |
| 15 | FAULT | 1 | Drive is faulted. |
| | | 0 | Drive is not faulted. |

| Bit(s) | Name | Value | State/Description |
|--------------|-----------------------------|-------|-------------------------------------------------------------------------------------------|
| 16 | ALARM | 1 | Panel/keypad (or PC tool) is in local control mode. |
| | | 0 | No warnings/Warnings |
| 17 | Reserve | | |
| 18 | Reserved for DIRECTION_LOCK | | Not yet implemented. |
| 19 | Reserve | | |
| 20 | Reserve | | |
| 21 | Reserve | | |
| 22 | USER_0 | | Status bits that can be combined with drive logic for application-specific functionality. |
| 23 | USER_1 | | |
| 24 | USER_2 | | |
| 25 | USER_3 | | |
| 26 | REQ_CTL | 1 | Control is requested in this channel. |
| | | 0 | Control is not requested in this channel. |
| 27 ... 31 | Reserve | | |

State transition diagrams

■ State transition diagram for the ABB Drives profile

The diagram below shows the state transitions in the drive when the drive is using the ABB Drives profile and the drive is configured to follow the commands of the control word from the embedded fieldbus interface. The upper case texts refer to the states which are used in the tables representing the fieldbus Control and Status words. See section [321](#) on page *Control Word for the ABB Drives profile*, and section [325](#) on page *Status Word for the ABB Drives profile*.

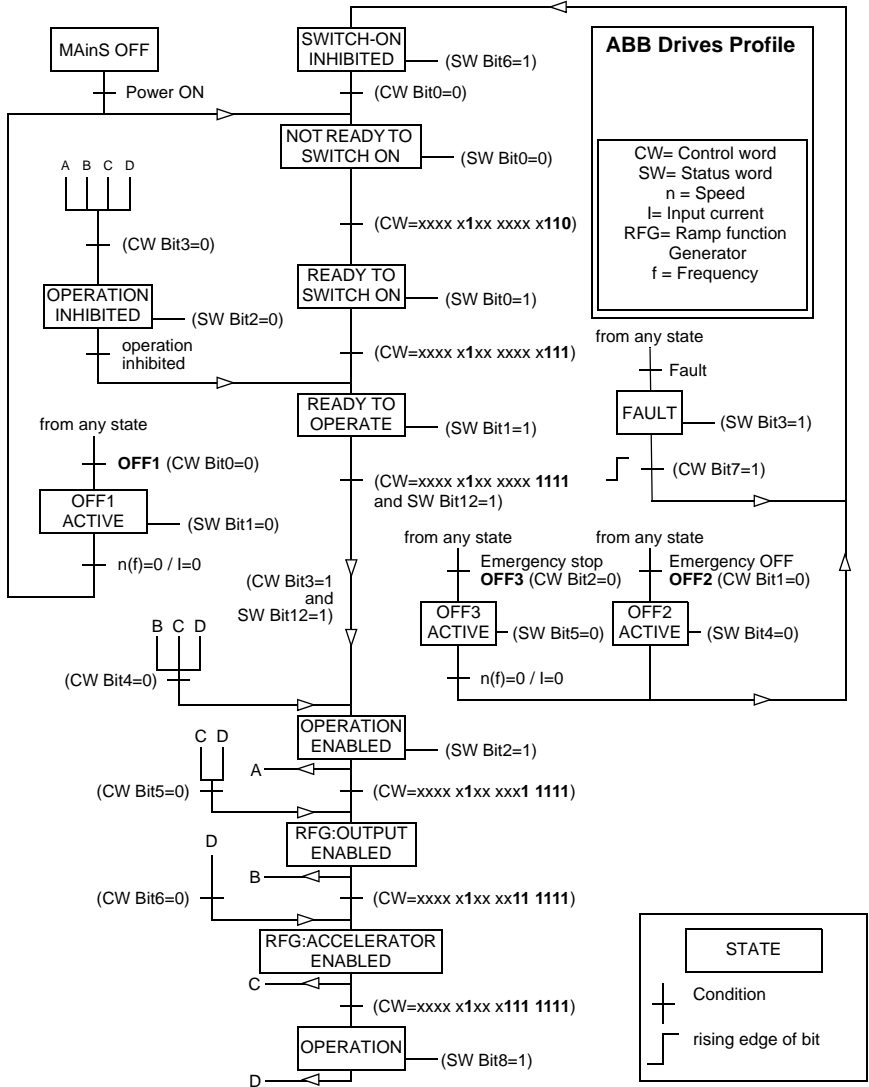

Reference value

■ References for the ABB Drives profile and DCU Profile

The ABB Drives profile supports the use of two references, EFB reference 1 and EFB reference 2. The references are 16-bit words each containing a sign bit and a 15-bit integer. A negative reference is formed by calculating the two's complement from the corresponding positive reference.

The references are scaled as defined by parameters [46.01...46.04](#) which scaling is in use depends on the setting of [58.26 EFB ref1 type](#) and [58.27 EFB ref 2 type](#) (see page [279](#)).

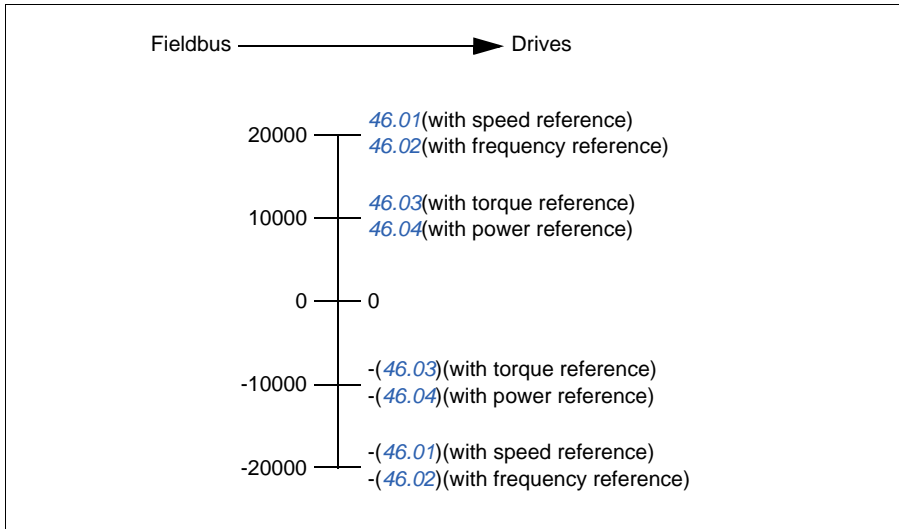

The scaled references are shown by parameters [03.09 EFB reference 1](#) and [03.10 EFB reference 2](#).

Actual value

■ Actual values for the ABB Drives profile and DCU Profile

The ABB Drives profile supports the use of two fieldbus actual values, ACT1 and ACT2. The actual values are 16-bit words each containing a sign bit and a 15-bit integer. A negative value is formed by calculating the two's complement from the corresponding positive value.

The actual values are scaled as defined by parameters [46.01...46.04](#); which scaling is in use depends on the setting of parameters [58.28 EFB actual value 1 type](#) and [58.29 EFB actual value 2 type](#) (see page [279](#)).

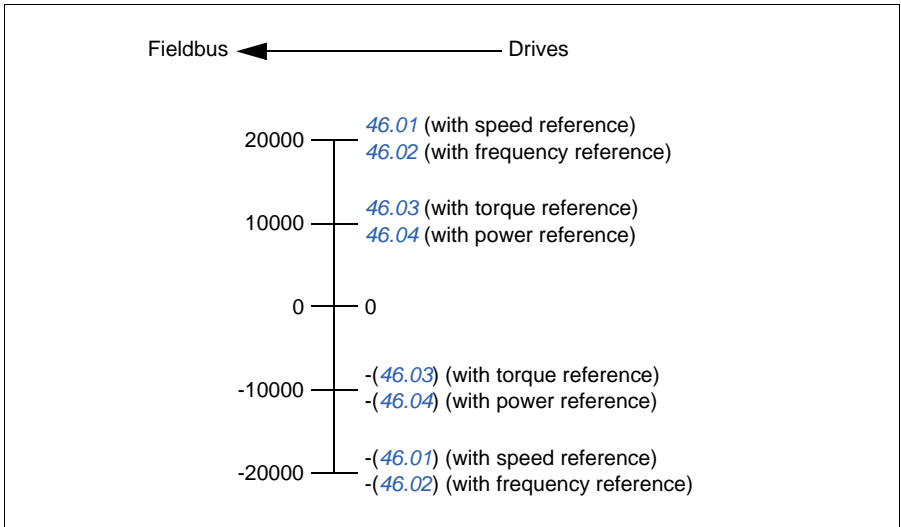

Modbus holding register addresses

■ Modbus holding register addresses for the ABB Drives profile and DCU Profile

The table below shows the default Modbus holding register addresses for the drive data with the ABB Drives profile. This profile provides a converted 16-bit access to the drive data.

Note: only access to 16 least significant digits of 32-bit control word and status word for the drive.

Note: Bits 16 through 32 of the DCU Control/Status word are not in use if 16-bit control/status word is used with the DCU Profile.

| Register address | Register data (16-bit words) |
|------------------|-------------------------------------------------------------------------------------------------------------------------------------------------------------------------------------------------------------------|
| 400001 | Control word. See sections <i>Control Word for the ABB Drives profile</i> (page 321) and <i>Control Word for the DCU Profile</i> (page 322). The selection can be changed using parameter 58.101 Data I/O 1. |
| 400002 | Reference 1 (REF1). The selection can be changed using parameter 58.102 Data I/O 2. |
| 400003 | Reference 2 (REF2). The selection can be changed using parameter 58.102 Data I/O 2. |
| 400004 | Status Word (SW). See sections <i>Status Word for the ABB Drives profile</i> (page 325) and <i>Status Word for the DCU Profile</i> (page 326). The selection can be changed using parameter 58.102 Data I/O 2. |
| 400005 | Actual value 1 (ACT1). The selection can be changed using parameter 58.105 Data I/O 5. |
| 400006 | Actual value 2 (ACT2). The selection can be changed using parameter 58.106 Data I/O 6. |
| 400007...400040 | Data in/out 7...40. Selected by parameters 58.107 Data I/O 7 ... 58.114 Data I/O 14. |
| 400070...400089 | Unused |
| 400090...400100 | Error code access. See <i>Error code registers (holding registers 400090...400100)</i> section (page 337). |
| 400101...465536 | Parameter read/write. Parameters are mapped to register addresses according to parameter 58.33 Addressing mode. |

MODBUS function codes

The table below shows the Modbus function codes supported by the embedded fieldbus interface.

| Code | Function name | Description |
|------|-------------------------------|------------------------------------------------------------------------------------------------------------------------------------------------------------------------------------------------------------------------------------------------------------------------------------------------------------------------------------------------------------------------------------------------------------------------------------------------------------------------------------------------------------------------------------------------------------------------------------------------------------------------------------------------------------------------------------------------------------------------------------------------------------------------------------------------------------------------------------------------------------------------------------------------|
| 01h | Read Coils | N/A |
| 02h | Read Discrete Inputs | N/A |
| 03h | Read Holding Registers | N/A |
| 05h | Write Single Coil | N/A |
| 06h | Write Single Register | N/A |
| 08h | Diagnose | <p>Provides a series of tests for checking the communication, or for checking various internal error conditions.</p> <p>Supported subcodes:</p> <ul style="list-style-type: none"> • 00h Return Query Data: echo/loopback test. • 01h Restart Comm Option: Restarts and initializes the EFB, clears communications event counters. • 04h Force Listen Only Mode • 0Ah Clear Counters and Diagnostic Register • 0Bh Return Bus Message Count • 0Dh Return Bus Communication Error Count • 0Dh Return Bus Exception Error Count • 0Eh Return Slave Message Count • 0Fh Return Slave No Response Count • 10h Return Slave NAK (negative acknowledge) Count • 11h Return Slave Busy Count • 12h Return Bus Character Overrun Count • 14h Clear Overrun Counter and Flag |
| 0Bh | Get Comm Event Counter | N/A |
| 0Fh | Write Multiple Coils | N/A |
| 10h | Write Multiple Registers | N/A |
| 16h | Mask Write Register | N/A |
| 17h | Read/Write Multiple Registers | N/A |

| Code | Function name | Description |
|---------|----------------------------------|---------------------------------------------------------------------------------------------------------------------------------------------------------------------------------------------------------------------------------------------------------------------------------------------------------------------------------------------------------------------------------------------------------------------------------------------------------------------------------------------------------------------------------------------------------------------------------------------------------------------------------------------------------------------------------------------------------------------------------------|
| 2Bh/0Eh | Encapsulated Interface Transport | <p>Supported subcodes:</p> <ul style="list-style-type: none"> • 0Eh Read Device Identification: allows reading identification and other information. <p>Supported ID codes (access type):</p> <ul style="list-style-type: none"> • 00h: Request to get the basic device identification (stream access) • 04h: Request to get one specific identification object (individual access) <p>Supported Object IDs:</p> <ul style="list-style-type: none"> • 00h: Vendor Name ("ABB") • 01h: Product Code (for example "AinFX") • 02h : Major Minor Revision (combination of contents 07.05 Firmware version and 58.02 Protocol ID . |

Exception code

The table below shows the Modbus exception codes supported by the embedded fieldbus interface.

| Code | Name | Description |
|------|----------------------|---------------------------------------------------------------------------------------------------------------------------------------------------------------------------------------------------------------------|
| 01h | ILLEGAL FUNCTION | The function code received in the query is not an allowable action for the server. |
| 02h | ILLEGAL DATA ADDRESS | The data address received in the query is not an allowable address for the server. |
| 03h | ILLEGAL DATA VALUE | A value contained in the query in not an allowable value for the server. |
| 04h | SLAVE DEVICE FAILURE | An unrecoverable error occurred while the server was attempting to perform the requested action. See section 337 on page Error code registers (holding registers 400090...400100) . |
| 06h | SLAVE DEVICE BUSY | The server is engaged in processing a long-duration program command. |

Coils (0xxxx reference set)

Coils are 1-bit read/write values. Control Word bits are exposed with this data type. The table below summarizes the Modbus coils (0xxxx reference set). Note that the references are 0-based index that match the address transmitted on the wire.

| Reference value | ABB Drives Profile | DCU profile |
|-----------------|--------------------|-------------------------|
| 0 | OFF1_CONTROL | STOP |
| 1 | OFF2_CONTROL | START |
| 2 | OFF3_CONTROL | Reserve |
| 3 | inHIBIT_OPERATION | Reserve |
| 4 | RAMP_OUT_ZERO | RESET |
| 5 | RAMP_HOLD | EXT2 |
| 6 | RAMP_in_ZERO | RUN_DISABLE |
| 7 | RESET | STOPMODE_RAMP |
| 8 | JOGGinG_1 | STOPMODE_EMERGENCY_RAMP |
| 9 | JOGGinG_2 | STOPMODE_COAST |
| 10 | REMOTE_CMD | Reserve |
| 11 | External_CTRL_LOC | RAMP_OUT_ZERO |
| 12 | USER_0 | RAMP_HOLD |
| 13 | USER_1 | RAMP_in_ZERO |
| 14 | USER_2 | Reserve |
| 15 | USER_3 | Reserve |
| 16 | Reserve | FB_LOCAL_CTL |
| 17 | Reserve | FB_LOCAL_REF |
| 18 | Reserve | Reserve |
| 19 | Reserve | Reserve |
| 20 | Reserve | Reserve |
| 21 | Reserve | Reserve |
| 22 | Reserve | USER_0 |
| 23 | Reserve | USER_1 |
| 24 | Reserve | USER_2 |
| 25 | Reserve | USER_3 |
| 26 | Reserve | Reserve |
| 27 | Reserve | Reserve |
| 28 | Reserve | Reserve |
| 29 | Reserve | Reserve |
| 30 | Reserve | Reserve |
| 31 | Reserve | Reserve |

Discrete inputs (1xxxx reference set)

Discrete inputs are 1-bit read-only values. Status Word bits are exposed with this data type. The table below summarizes the Modbus discrete inputs (1xxxx reference set). Note that the references are 0-based index that match the address transmitted on the wire.

| Reference value | ABB Drives Profile | DCU profile |
|-----------------|--------------------|----------------|
| 0 | RDY_ON | READY |
| 1 | RDY_RUN | ENABLED |
| 2 | RDY_REF | Reserve |
| 3 | TRIPPED | RUNNinG |
| 4 | OFF_2_STATUS | ZERO_SPEED |
| 5 | OFF_3_STATUS | Reserve |
| 6 | SWC_ON_inHIB | Reserve |
| 7 | ALARM | AT_SETPOinT |
| 8 | AT_SETPOinT | LIMIT |
| 9 | REMOTE | SUPERVISION |
| 10 | ABOVE_LIMIT | Reserve |
| 11 | USER_0 | Reserve |
| 12 | USER_1 | PANEL_LOCAL |
| 13 | USER_2 | FIELDBUS_LOCAL |
| 14 | USER_3 | Ext. 2_ACT |
| 15 | Reserve | FAULT |
| 16 | Reserve | ALARM |
| 17 | Reserve | Reserve |
| 18 | Reserve | Reserve |
| 19 | Reserve | Reserve |
| 20 | Reserve | Reserve |
| 21 | Reserve | Reserve |
| 22 | Reserve | USER_0 |
| 23 | Reserve | USER_1 |
| 24 | Reserve | USER_2 |
| 25 | Reserve | USER_3 |
| 26 | Reserve | REQ_CTL |
| 27 | Reserve | Reserve |
| 28 | Reserve | Reserve |
| 29 | Reserve | Reserve |
| 30 | Reserve | Reserve |
| 31 | Reserve | Reserve |

Error code registers (holding registers 400090...400100)

These registers contain information about the last query. The error register is cleared when a query has finished successfully.

| Reference value | Name | Description |
|-----------------|---------------------------------------------|----------------------------------------------------------------------------------------------------------------------------------------------------------------------------------------------------------------------------------------------------------------------------------------------------------------------------------------------------------------------------------------------|
| 89 | Reset Error Registers | 1 = Reset internal error registers (91...95).0 = Do nothing. |
| 90 | Error Function Code | Function code of the failed query. |
| 91 | Error Code | Set when exception code 04h is generated (see table above). <ul style="list-style-type: none"> • 00h No error • 02h Low/High limit exceeded • 03h Fault index: Unavailable index of an array parameter • 05h Data type error: Value does not match the data type of the parameter • 65h Normal error: Undefined error when handling query |
| 92 | Failed register | The last register (discrete input, coil, input register or holding register) that failed to be read or written. |
| 93 | Last register that was written successfully | The last register that was written successfully. |
| 94 | Last register that was read successfully | The last register that was read successfully. |

Control through a fieldbus adapter

System overview

The drive can be connected to an external control system through an optional fieldbus adapter ("fieldbus adapter A" = FBA A) mounted onto the control unit of the drive. The drive can be configured to receive all of its control information through the fieldbus interface, or the control can be distributed between the fieldbus interface and other available sources such as digital and analog inputs, depending on how control locations EXT1 and EXT2 are configured.

Fieldbus adapters are available for various communication systems and protocols, for example:

- PROFIBUS DP(FPBA-01 adapter)
- CANopen(FCAN-01 adapter)
- DeviceNet™(FDNA-01 adapter)
- EtherNet/IP™(FENA-11 adapter)

Note: The text and examples in this chapter describe the configuration of one fieldbus adapter (FBA A) by parameters *50.01...50.18* and parameter groups *51 FBA A settings...53 FBA A data out*.

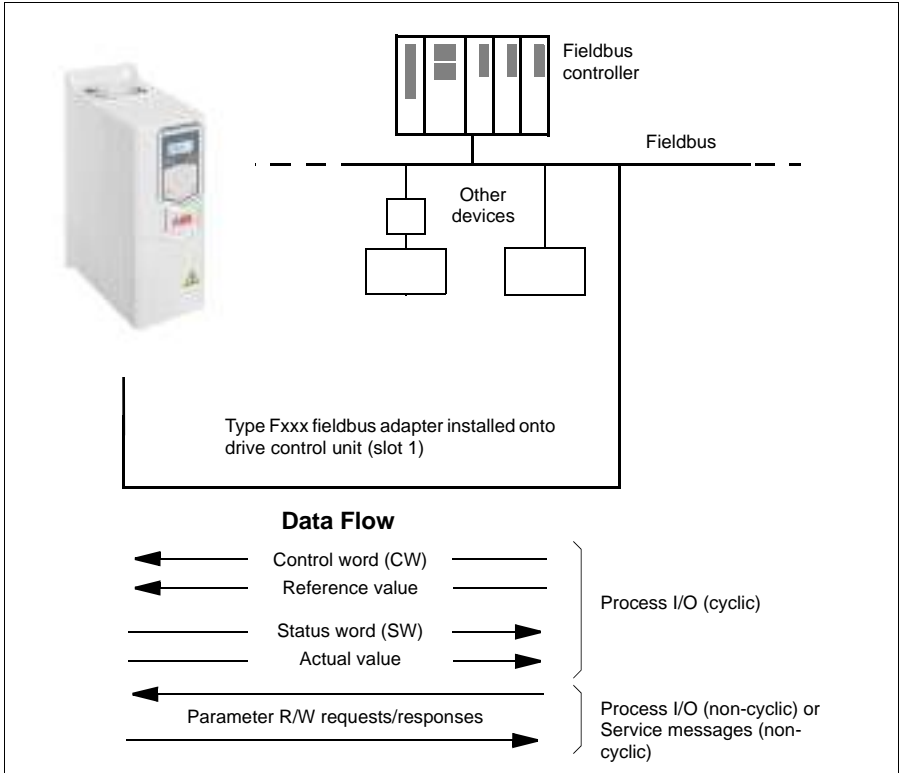

Interface basis of fieldbus adapters

The cyclic communication between a fieldbus system and the drive consists of 16- or 32-bit input and output data words. The drive is able to support a maximum of 12 data words (16 bits) in each direction.

Data transmitted from the drive to the fieldbus controller is defined by parameters [52.01 FBA A data in 1 ... 52.12 FBA A data in 12](#). The data transmitted from the fieldbus controller to the drive is defined by parameters [53.01 FBA A data out 1 ... 53.12 FBA A data out 12](#).

Fieldbus network

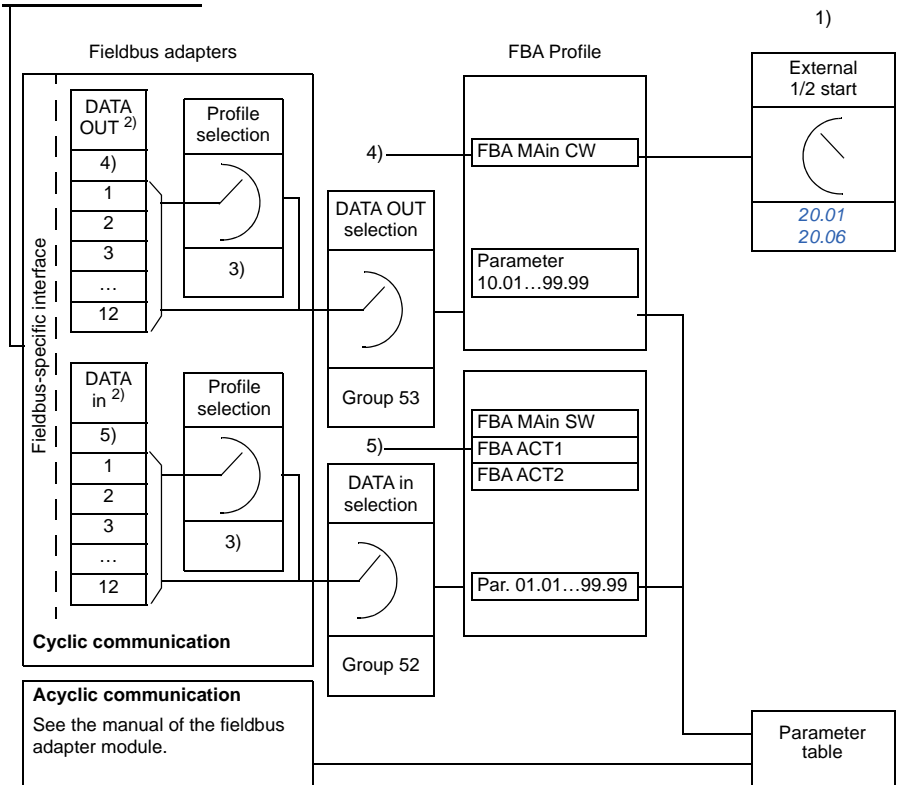

- 1) See also other parameters which can be controlled from fieldbus.
- 2) The maximum number of data words used is protocol-dependent.
- 3) Profile/instance selection parameters. Fieldbus module specific parameters. For more information, see the User's Manual of the appropriate fieldbus adapter module.
- 4) With DeviceNet, the control part is transmitted directly.
- 5) With DeviceNet, the actual value part is transmitted directly.

■ **Control word and Status word**

The Control word is the principal means for controlling the drive from a fieldbus system. It is sent by the fieldbus master station to the drive through the adapter module. The drive switches between its states according to the bit-coded instructions in the Control word and returns status information to the master in the Status word.

The contents of the Control word and the Status word are detailed on pages [343](#) and [345](#) respectively. The drive states are presented in the state diagram (page [346](#)).

Debugging the network words

If parameter [50.12 FBA A debug mode](#) is set to *Enabled*, the Control word received from the fieldbus is shown by parameter [50.13 FBA A Control Word](#), and the Status word transmitted to the fieldbus network by [50.16 FBA A Status Word](#). This “raw” data is very useful to determine if the fieldbus master is transmitting the correct data before handing control to the fieldbus network.

■ Reference value

References are 16-bit words containing a sign bit and a 15-bit integer. A negative reference (indicating reversed direction of rotation) is formed by calculating the complement from the corresponding positive reference.

ABB drives can receive control information from multiple sources including analog and digital inputs, the drive control panel and a fieldbus adapter module. In order to have the drive controlled through the fieldbus, the module must be defined as the source of control information such as reference. This is done using the source selection parameters in groups [22 Speed reference selection](#) and [28 Frequency reference chain](#).

Debugging the network words

If parameter [50.12 FBA A debug mode](#) is set to *Enabled*, the references received from the fieldbus are displayed by [50.14 FBA A reference 1](#) and [50.15 FBA A reference 2](#).

Scaling of references

The references are scaled as defined by parameters [46.01...46.04](#); which scaling is in use depends on the setting of [50.04 FBA A Reference 1 type](#) and [50.05 FBA A Reference 2 type](#).

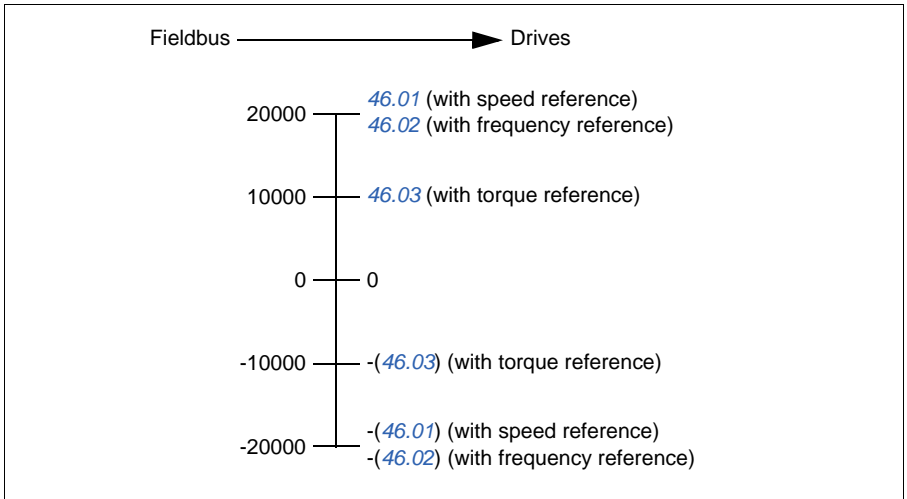

The scaled references are shown by parameters [03.05FBA reference 1](#) and [03.06FBA reference 2](#).

■ Actual value

Actual values are 16-bit words containing information on the operation of the drive. The types of the monitored signals are selected by parameters [50.07 FBA A Actual 1 type](#) and [50.08 FBA A Actual 2 type](#).

Debugging the network words

If parameter [50.12 FBA A debug mode](#) is set to *Enabled*, the actual values sent to the fieldbus are displayed by [50.17 FBA A Actual value 1](#) and [50.18 FBA A Actual value 2](#).

Scaling of actual values

The actual values are scaled as defined by parameters [46.01...46.04](#); which scaling is in use depends on the setting of parameters [50.07 FBA A Actual 1 type](#) and [50.08 FBA A Actual 2 type](#).

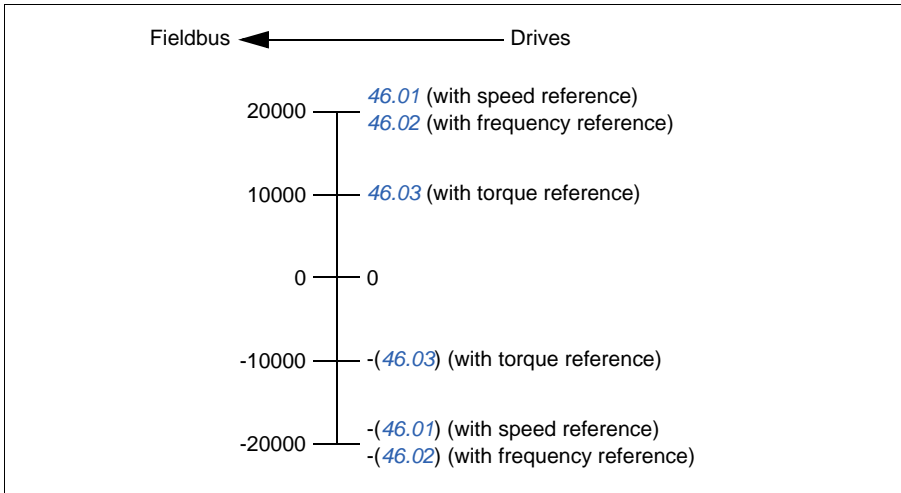

■ Contents of the fieldbus Control word

The upper case boldface text refers to the states shown in the state diagram (page 346).

| Bit(s) | Name | Value | State/Description |
|--------|---------------------------|-------|---------------------------------------------------------------------------------------------------------------------------------------------------------------------------------------------------------------------------------------------------------------------------------------------------------------------------------------------------|
| 0 | Off1 control | 1 | Proceed to READY TO OPERATE . |
| | | 0 | Stop along currently active deceleration ramp. Proceed to OFF1 ACTIVE ; Proceed to READY TO SWITCH ON unless other interlocks (OFF2, OFF3) are active. |
| 1 | Off2 control | 1 | Continue operation (OFF2 stopped). |
| | | 0 | Emergency OFF, coast to a stop. Proceed to OFF2 ACTIVE , Proceed to SWITCH-ON INHIBITED . |
| 2 | Off3 control | 1 | Continue operation (OFF3 stopped). |
| | | 0 | Emergency stop, stop within time d Continue operation (OFF3 stopped).efined by drive parameter. Proceed to OFF3 ACTIVE ; Proceed to SWITCH-ON INHIBITED .  Warning: Ensure motor and driven machine can be stopped using this stop mode. |
| 3 | Running | 1 | Proceed to OPERATION ENABLED . Note: Run enable signal must be active; see drive documentation. If the drive is set to receive the run enable signal from the fieldbus, this bit activates the signal. |
| | | 0 | Operation inhibited. Proceed to OPERATION INHIBITED . |
| 4 | Ramp Out Zero | 1 | Normal operation. Proceed to RAMP FUNCTION GENERATOR: OUTPUT ENABLED . |
| | | 0 | Force Ramp function generator input to zero. The drive will immediately reduce the speed to zero (observe the torque limit) |
| 5 | Ramp Hold | 1 | Enable ramp function. Proceed to RAMP FUNCTION GENERATOR: ACCELERATOR ENABLED . |
| | | 0 | Halt ramping (Ramp Function Generator output held). |
| 6 | Ramp in Zero | 1 | Normal operation. Proceed to OPERATING . Note: This bit is effective only if the fieldbus interface is set as the source of this signal by drive parameters. |
| | | 0 | Force Ramp function generator input to zero. |
| 7 | Resetting | 0=>1 | Fault reset if an active fault exists. Proceed to SWITCH-ON INHIBITED . Note: This bit is effective only if the fieldbus interface is set as the source of the reset signal by drive parameters. |
| | | 0 | Continue nominal operation. |
| 8 | Inching 1 | 1 | Accelerate to inching (jogging) setpoint 1. Notes: • Bits 4...6 must be 0. |
| | | 0 | Inching (jogging) 1 disabled. |
| 9 | Inching 2 | 1 | Accelerate to inching (jogging) setpoint 2. See notes at bit 8. |
| | | 0 | Inching (jogging) 2 disabled. |
| 10 | Remote cmd | 1 | Fieldbus control enabled. |
| | | 0 | Control word and reference not getting through to the drive, except for bits 0...2. |
| 11 | External control location | 1 | Select External Control Location EXT2. Effective if control location parametrized to be selected from fieldbus. |
| | | 0 | Select External Control Location EXT1. Effective if control location parametrized to be selected from fieldbus. |
| 12 | User bit0 | 1 | TBA |
| | | 0 | TBA |
| 13 | User bit1 | 1 | TBA |
| | | 0 | TBA |

| Bit(s) | Name | Value | State/Description |
|---------------|-------------|--------------|--------------------------|
| 14 | User bit2 | 1 | TBA |
| | | 0 | TBA |
| 15 | User bit3 | 1 | TBA |
| | | 0 | TBA |

■ Contents of the fieldbus Status word

The upper case boldface text refers to the states shown in the state diagram (page 346).

| Bit(s) | Name | Value | State/Description |
|--------|-----------------------|------------|-------------------------------------------------------------------------------------------------------------------------------|
| 0 | Ready to switch to ON | 1 | READY TO SWITCH ON. |
| | | 0 | NOT READY TO SWITCH ON. |
| 1 | Ready run | 1 | READY TO OPERATE. |
| | | 0 | OFF1 ACTIVE. |
| 2 | Rdy Ref | 1 | OPERATION ENABLED. |
| | | 0 | OPERATION INHIBITED. |
| 3 | Trip | 1 | FAULT. |
| | | 0 | No fault. |
| 4 | Off 2 inactive | 1 | OFF2 inactive. |
| | | 0 | OFF2 ACTIVE. |
| 5 | Off 3 inactive | 1 | OFF3 inactive. |
| | | 0 | OFF3 ACTIVE. |
| 6 | Switch-on inhibited | 1 | SWITCH-ON INHIBITED. |
| | | 0INHIBITED | - |
| 7 | Alarm | 1 | Alarm is active. |
| | | 0 | No alarm is active. |
| 8 | Setpoint | 1 | OPERATING. Actual value equals reference = is within tolerance limits (see parameters 46.21...46.23). |
| | | 0 | Actual value differs from Reference = is outside tolerance limits. |
| 9 | Remote cmd | 1 | Drive control location: REMOTE (Ext1 or Ext2). |
| | | 0 | Drive control location: LOCAL. |
| 10 | Above limit | - | See bit 10 of 06.17 Drive status word 2 . |
| 11 | User bit0 | - | See parameter 06.30 MSW bit 11 selection . |
| 12 | User bit1 | - | See parameter 06.31 MSW bit 12 selection . |
| 13 | User bit2 | - | See parameter 06.32 06.32 . |
| 14 | User bit3 | - | See parameter 06.33 MSW bit 14 selection . |
| 15 | Reserve | | |

■ The state diagram

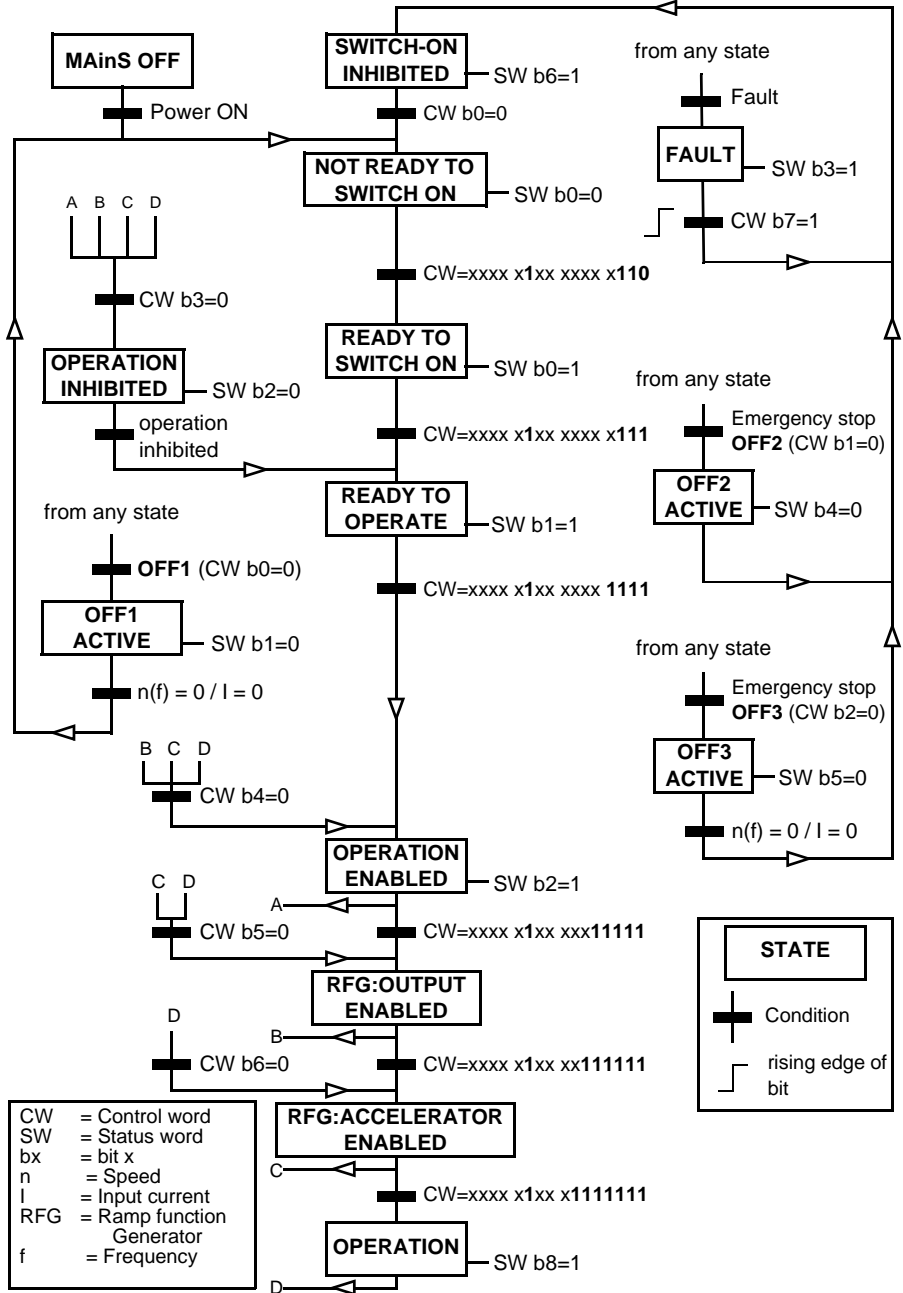

Setting up the drive for fieldbus control

1. Install the fieldbus adapter module mechanically and electrically according to the instructions given in the User's manual of the module.
 2. Power up the drive.
 3. Enable the communication between the drive and the fieldbus adapter module with parameter [50.01 FBA A Enable](#).
 4. With [50.02 FBA A communication loss function](#) select how the drive should react to a fieldbus communication break.
Note: This function monitors both the communication between the fieldbus master and the adapter module and the communication between the adapter module and the converter.
 5. Through parameter [50.03 FBA A communication loss time out](#), define the time elapsed between detecting a communication break and selecting an action.
 6. Select application-specific values for the rest of the parameters in group [50 Fieldbus adapter \(FBA\)](#), starting from [50.04 Examples of appropriate values are shown in the tables below](#).
 7. Set the fieldbus adapter module configuration parameters in parameters group [51 FBA A settings](#). As a minimum, set the required node address and the communication profile.
 8. Define the process data transferred to and from the drive in parameter groups [52 FBA A data in](#) and [53 FBA A data out](#).
Note: Depending on the communication protocol and profile being used, the Control word and Status word may already be configured to be sent/received by the communication system.
 9. Save the effective parameter value to permanent memory by setting parameter [96.07 Parameter save manually](#) to *Save*.
 10. Validate the settings made in parameter groups 51, 52 and 53 by setting parameter [51.27 FBA A parameter update](#) to *Configure*.
 11. Configure control locations EXT1 and EXT2 to allow control and reference signals to come from the fieldbus. Examples of appropriate values are shown in the tables below.
-

■ Parameter setting examples: FPBA (PROFIBUS DP)

This example shows how to configure a basic speed control application that uses the PROFI drive communication profile with PPO Type 2. The start/stop commands and reference are according to the PROFI drive profile, speed control mode.

The reference values sent to the fieldbus have to be scaled within the drive so they have the desired effect. The reference value ± 16384 (4000h) corresponds to the range of speed set in parameter *46.01 Speed fieldbus scaled value* (both forward and reverse directions). For example, if *46.01* is set to 480 rpm, then 4000h sent over fieldbus will request 480 rpm.

| Direction | PZD1 | PZD2 | PZD3 | PZD4 | PZD5 | PZD6 |
|-----------|--------------|--------------------|------------------------|------|------------------------|------|
| Out | Control word | Speed reference | Acceleration time 1 | | Deceleration time 1 | |
| In | Status word | Speed Actual value | Motor current | | Dc voltage | |

The table below gives the recommended drive parameter settings.

| Drive parameter | Setting for ACS530 drives | Description |
|-------------------------------------|-------------------------------|---------------------------------------------------------------------------------------------------------------------------|
| <i>50.01 FBA A Enable</i> | 1 = [slot number] | Enables communication between the drive and the fieldbus adapter module. |
| <i>50.04 FBA A Reference 1 type</i> | 4 = <i>Speed</i> | Selects the fieldbus A reference 1 type and scaling. |
| <i>50.07 FBA A Actual 1 type</i> | 0 = <i>Speed or Frequency</i> | Selects the actual value type and scaling according to the currently active Ref1 mode defined in parameter <i>50.04</i> . |
| <i>51.01 FBA A type</i> | 1 = FPBA ¹⁾ | Displays the type of the fieldbus adapter module. |
| 51.02 Node address | 3 ²⁾ | Defines the PROFIBUS node address of the fieldbus adapter module. |
| 51.03 Baud rate | 12000 ¹⁾ | Displays the current baud rate on the PROFIBUS network in kbit/s. |
| 51.04 MSG type | 1 = PPO1 ¹⁾ | Displays the telegram type selected by the PLC configuration tool. |
| 51.05 Profile | 0 = PROFIdrive | Selects the Control word according to the PROFI drive profile (speed control mode). |
| 51.07 RPBA mode | 0 = disabled | Disables the RPBA emulation mode. |
| 52.01 FBA data in1 | 4 = SW 16bit ¹⁾ | Status word |
| 52.02 FBA data in2 | 5 = Act1 16bit | Actual value 1 |
| 52.03 FBA data in3 | 01.07 ²⁾ | Motor current |
| 52.05 FBA data in5 | 01.11 ²⁾ | Dc voltage |
| 53.01 FBA data out1 | 1 = CW 16bit ¹⁾ | Control word |

| Drive parameter | Setting for ACS530 drives | Description |
|-------------------------------------|---------------------------|-------------------------------------------------------------------------------------------------------------|
| 53.02 FBA data out2 | 2 = Ref1 16bit | Reference 1 (speed) |
| 53.03 FBA data out3 | 23.12 ²⁾ | Acceleration time 1 |
| 53.05 FBA data out5 | 23.13 ²⁾ | Deceleration time 1 |
| <i>51.27 FBA A parameter update</i> | 1 = <i>Configure</i> | Validates the configuration parameter settings. |
| <i>20.01 Ext1 commands</i> | 12 = <i>Fieldbus A</i> | Selects fieldbus adapter A as the source of the start and stop commands for external control location EXT1. |
| <i>20.02 Ext1 start trigger</i> | 1 = <i>Level</i> | Selects a level-triggered start signal for external control location EXT1. |

1) Read only or automatically detected/set

2) Example

The start sequence for the parameter example above is given below.

Control word:

- 477h(1143 decimal)→ READY TO SWITCH ON
- 47Fh (1151 decimal)→ OPERATINGOPERATING (decimal)



Fault tracing

What this chapter contains

The chapter lists warning and fault information, including possible causes and corrective actions. The causes of most warnings and faults can be identified and corrected using the information in this chapter. If not, contact an ABB service representative. If you have a possibility to use the Drive composer PC tool, send the Support package created by the Drive composer to the ABB service representative.

Warnings and faults are listed below in separate tables. Each table is sorted by warning/fault code.

Safety



Warning! Only qualified electricians are allowed to service the drive. Read the *instructions* in chapter at the beginning of the *Hardware manual* of the drive before working on the drive.

Indications

■ Warnings and faults

Warnings and faults indicate an abnormal drive status. The codes and names of active warnings and faults are displayed on the control panel of the drive as well as in the Drive composer PC tool. Only the codes of warnings and faults are available over fieldbus.

Warnings do not need to be reset; they stop showing when the cause of the warning ceases. Warnings do not latch and the drive will continue to operate the motor.

Faults do latch inside the drive and cause the drive to trip, and the motor stops. After the cause of a fault has been removed, the fault can be reset from a selectable source by parameter [31.11 Fault reset selection](#), such as the control panel, Drive composer PC tool, digital inputs of the drive or fieldbus. Resetting the fault creates an event [64FF Fault reset](#). After the reset, the drive can be restarted.

Note that some faults require a reboot of the control unit (either by switching the power off and on, or using parameter [96.08 Control board boot](#)) – this is mentioned in the fault listing wherever appropriate.

■ Pure events

In addition to warnings and faults, there are pure events that are only recorded in the event log of the drive. The codes of these events are included in the [Warning information](#) table on page [353](#)).

Warning/fault history

■ Event logs

All indications are stored in the event log with a time stamp and other information. The event log stores information on

- the last 8 fault recordings, that is, faults that tripped the drive or fault resets
- The last 10 warnings or pure events that occurred.

See section [352](#) on page [Viewing warning/fault information](#).

Auxiliary code

Some events may generate auxiliary code which is helpful for pinpointing problem. On the control panel, the auxiliary code is stored as part of the details of the event; in the Drive composer PC tool, the auxiliary code is shown in the event list.

■ Viewing warning/fault information

The drive is able to store a list of the active faults actually causing the drive to trip at the present time. The drive also stores a list of faults and warnings that have previously occurred.

For active faults and warnings, see

- parameters in group [04 Warnings and faults](#) (page [136](#)).

For previously occurred faults and warnings, see

- parameters in group [04 Warnings and faults](#) (page [136](#)).

The event log can also be accessed (and reset) using the Drive composer PC tool. See *Drive composer PC tool user manual (3AUA0000094606 [English]*.

Warning information

Note: The list below also contains events that only appear in the Event log.

| Code (hex) | Warning / Aux. code | Cause | What to do |
|------------|---------------------|-------------------------------------------------------------------------------------------------------------------------------------------------------------------------------|------------------------------------------------------------------------------------------------------------------------------------------------------------------------------------------------------------------------------------------------------------------------------------------------------------------------------------------------------------------------------------------------------------------------------------------------------------------------------------------------------------------------------------------------------------------------------------------------------------------------------------------------------------------------------------------------------------------------------------------------------------------------------------------------------------------------------------------------------------------------------------------------------------------------------------------|
| 64FF | Fault reset | A fault has been reset from the panel, Drive composer PC tool, fieldbus or I/O. | Event. Informative only. |
| A2A1 | Current calibration | Current offset and gain measurement calibration will occur at next start. | Informative warning. |
| A2B1 | Over current | Output current has exceeded internal fault limit. In addition to an actual overcurrent situation, this warning may also be caused by an ground fault or supply phase loss. | <p>Check motor load. 28 Frequency reference chain acceleration time in (frequency control). Also check parameters 46.01 Speed fieldbus scaled value, 46.02 Frequency fieldbus scaled value and 46.03 Torque fieldbus scaled value.</p> <p>Check motor and motor cable (including phasing and delta/star connection). Check for an ground fault in motor or motor cables by measuring the insulation resistances of motor and motor cable. See section <i>Check assemble insulation</i> in the Chapter of Electrical installation in drive hardware manual.</p> <p>Check there are no contactors opening and closing in motor cable. Check that the start-up data in parameter group 99 Motor data corresponds to the motor rating plate.</p> <p>Check there are no power factor correction capacitors or surge absorbers in motor cable.</p> |
| A2B3 | Earth leakage | Drive has detected load unbalance typically due to ground fault in motor or motor cable. | <p>Check there are no power factor correction capacitors or surge absorbers in motor cable.</p> <p>Check for an ground fault in motor or motor cables by measuring the insulation resistances of motor and motor cable. See section <i>Check assemble insulation</i> in the Chapter of Electrical installation in drive hardware manual. If an ground fault is found, fix or change the motor cable and/or motor. If no ground fault can be detected, contact your local ABB representative.</p> |

| Code (hex) | Warning / Aux. code | Cause | What to do |
|------------|------------------------------------|---------------------------------------------------------------------------------------------------------------------------------------------|----------------------------------------------------------------------------------------------------------------------------------------------------------------------------------------------------------------------------------------------------------------------------------------------------------------------------------------------------------------------------------------------------------------------------------------------------------------------------------------------|
| A2B4 | Short circuit | Short-circuit in motor cable(s) or motor. | <p>Check motor and motor cable for cabling errors.</p> <p>Check motor and motor cable (including phasing and delta/star connection).</p> <p>Check for an ground fault in motor or motor cables by measuring the insulation resistances of motor and motor cable.</p> <p>See section <i>Check assemble insulation</i> in the Chapter of Electrical installation in drive hardware manual.</p> <p>Check there are no power factor correction capacitors or surge absorbers in motor cable.</p> |
| A2BA | IGBT overload | Excessive IGBT junction to case temperature. This warning protects the IGBT (s) and can be activated by a short circuit in the motor cable. | <p>Check motor cable.</p> <p>Check ambient conditions.</p> <p>Check air flow and fan operation</p> <p>Check heat sink fins for dust pick-up.</p> <p>Check motor power against drive power.</p> |
| A3A1 | DC bus over voltage | Intermediate circuit DC voltage too high (when the drive is stopped). | <p>Check the supply voltage setting (parameter 95.01Supply volt). Note that the wrong setting of the parameter may cause the motor to rush uncontrollably, or may overload the brake chopper or resistor.</p> <p>Check supply voltage.</p> |
| A3A2 | DC bus under voltage | Intermediate circuit DC voltage too low (when the drive is stopped). | <p>If the problem persists, contact your local ABB representative.</p> |
| A3AA | DC not charged | The voltage of the intermediate DC circuit has not yet risen to operating level. | <p>If the problem persists, contact your local ABB representative.</p> |
| A480 | Motor cable overload | Calculated motor cable temperature has exceeded warning limit. | <p>Check settings of parameters 35.61 and 35.62.</p> <p>Check the motor cable size against necessary load.</p> |
| A490 | Incorrect temperature sensor setup | Sensor type mismatch. | <p>Check the settings of temperature source parameters 35.11 and 35.21 corresponding to 91.24 and 91.21.</p> |
| | | Faulty wiring between an encoder interface module and the temperature sensor. | <p>Check the wiring of the sensor.</p> <p>Auxiliary code may identify interface module. (0 = module 1, 1 = module 2).</p> |
| A491 | Ext Tmp1 (Editable message text) | Measured temperature 1 has exceeded warning limit. | <p>Check the value of parameter 35.02Measured temperature 1.</p> <p>Check the cooling of the motor (or other equipment whose temperature is being measured)</p> |
| A492 | Ext Tmp2 (Editable message text) | Measured temperature 2 has exceeded warning limit. | <p>Check the value of parameter 35.03Measured temperature 2.</p> <p>Check the cooling of the motor (or other equipment whose temperature is being measured).</p> |

| Code (hex) | Warning / Aux. code | Cause | What to do |
|------------|-------------------------------|----------------------------------------------------------------------------------|--------------------------------------------------------------------------------------------------------------------------------------------------------------------------------------------------------------------------------------------------------------------------------------------------------------------------------------------------------------------------------------------------------------------------------------------------------|
| A4A0 | Control board temperature | Control unit overtemperature | Check the auxiliary code. See the corresponding action of each code below. |
| | (N/A) | Temperature has exceeded warning limit. | Check ambient conditions. Check air flow and fan operation. Check heatsink fins for dust pick-up. |
| | 1 | Thermistor broken | Contact an ABB service representative for control unit replacement. |
| A4A1 | IGBT overtemperature | Estimated drive IGBT temperature is excessive. | Check ambient conditions. Check air flow and fan operation. Check heat sink fins for dust pick-up. Check motor power against drive power. |
| A4A9 | Cooling | Drive module temperature is excessive. | Check ambient temperature. If it exceeds 40 °C/104 °F (frames R5 ...R9) or if it exceeds 50 °C /122 °F (frames B0...R9), ensure that load current does not exceed derated load capacity of drive. See section <i>Derating</i> in the Chapter of Technical Data of drive hardware manual. Check drive module cooling air flow and fan operation. Check inside of cabinet and heatsink of drive module for dust pick-up. Clean whenever necessary. |
| A4B0 | Excess temperature | Power unit module temperature is excessive. | Check ambient conditions. Check air flow and fan operation. Check heat sink fins for dust pick-up. Check motor power against drive power. |
| A4B1 | Excess temperature difference | High temperature difference between the IGBTs of different phases. | Check motor cabling. Check cooling of the drive module(s). |
| A4B2 | PCB plate cooling | Temperature difference between ambient and drive module PCB space is excessive. | Check the cooling fan inside PCB plate. |
| A4F6 | IGBT temperature | Drive IGBT temperature is excessive. | Check ambient conditions. Check air flow and fan operation. Check heat sink fins for dust pick-up. Check motor power against drive power. |
| A580 | PU communication | Communication errors detected between the drive control unit and the power unit. | Check the connection between the drive control unit and the power unit. |

| Code (hex) | Warning / Aux. code | Cause | What to do |
|------------|------------------------------------------------------------------------------|-----------------------------------------------------------------------------------------------------------------------------------------------------|--------------------------------------------------------------------------------------------------------------------------------------------------------------------------------------------------------------------------------------------------------------------------------------------------------------------------------------------------------------------------------------------------------------------------------------------------------------------------------------------------------------------------------------------------------------------------------------------------------------------------------|
| A581 | Fan | Cooling fan is stuck or disconnected. | Check auxiliary code to identify fan. Code 0 represents main fan 1. Other code (format XYZ): "X" represents status code (1 : ID operation, 02 : Normal). "Y" specifies the index connected to BCU inverter unit (0...n , ZCU control unit is 0). "Z" specifies the index of the fan (0 : Main fan 1, 1 : Main fan 2, 2 : Main fan 3, 3 : Auxiliary fan 1, 4 : Auxiliary fan 2, 5 : Auxiliary fan 3, 6 : Filter fan 1, 7 : Filter fan 2, 8 : Filter fan 3). Check fan operation and connection. Replace faulty fan. |
| A582 | Auxiliary fan lost | Auxiliary cooling fan (connected to fan connector of control unit) is stuck or disconnected. | Check auxiliary fan(s) and connection(s). Replace faulty fan. Ensure the front cover of transmission module is correctly positioned and fastened. If it is necessary to remove the cover for debugging transmission, even if corresponding fault become invalid, the warning is still generated. |
| A5A0 | Delete safe torque Programmable warning: <i>31.22STO indication run/stop</i> | Delete safe torque function is active, i.e. safety circuit signal(s) connected to connector STO is lost. | Check safety circuit connections. For more information, see description in chapter <i>Delete safe torque function</i> as well as parameter <i>31.22STO indication run/stop</i> (page 207) of drive hardware manual. |
| A5EA | Measurement circuit temperature | Problem with internal temperature measurement of the drive. | Contact your local ABB representative. |
| A5EB | PU board powerfail | Power unit power supply failure. | Contact your local ABB representative. |
| A5EC | PU internal communication | Communication errors detected between the drive control unit and the power unit. | Check the connection between the drive control unit and the power unit. |
| A5ED | Measurement circuit ADC | Measurement circuit fault. | Contact your local ABB representative. |
| A5EE | Measurement circuit DFF | Measurement circuit fault. | Contact your local ABB representative. |
| A5EF | PU state feedback | State feedback from output phases does not match control signals. | Contact your local ABB representative. |
| A5F0 | Charging feedback | Charging feedback signal missing. | Check the feedback signal coming from the charging system. |
| A5F3 | Switch frequency is below requirement | Due to limited switch frequency (for example, parameter <i>95.15</i>), sufficient motor control cannot be reached under required output frequency. | Informative warning. |
| A683 | Data saving to power unit | An error in saving data to the power unit. | Contact local ABB representative. |

| Code (hex) | Warning / Aux. code | Cause | What to do |
|------------|-----------------------------|--------------------------------------------------------------------------------------------------------------------------------------------------------------------------------|--------------------------------------------------------------------------------------------------------------------------------------------------------------------------------------------------------------------------------------------------------------------------------------------------------------------------------------------------------------------------------------------------------|
| A684 | SD card | Error related to SD card used to store data (BCU control unit only). | Check the auxiliary code. See the corresponding action of each code below. |
| | 1 | No SD card | Insert a compatible and writeable SD card into the SD CARD slot of the BCU control unit. |
| | 2 | SD card write-protected | |
| | 3 | SD card is non-writeable | |
| A685 | Power fail saving | Power fail saving is requested too frequently due to oscillating power supply to the control unit. Some of the requests may have been discarded potentially causing data loss. | Check the power supply of the control unit. If powered internally from the transmission, check the supply voltage of the transmission. |
| A6A4 | Motor nominal value | Motor parameters are set incorrectly. | Check the settings of the motor configuration parameters in group 99. |
| | | The drive is not dimensioned correctly. | Check that the drive is sized correctly for the motor. |
| | 1 | Slip frequency is too small | Check the settings of the motor configuration parameters in group 98 and 99. Check that the drive is sized correctly for the motor. |
| | 2 | Synchronous speed differs too much from nominal speed | |
| | 3 | Nominal speed is higher than synchronous speed with one pole-pair number. | |
| | 4 | Nominal current is outside limits | |
| | 5 | Nominal voltage is outside limits | |
| | 6 | Nominal power is higher than apparent power | |
| A6A5 | No motor data | Parameters in group 99 have not been set. | |
| A6A6 | Voltage category unselected | The voltage category has not been defined. | Set voltage category in parameter <i>95.01 Supply volt.</i> |
| A6D1 | FBA A parameter conflict | The drive does not have a functionality requested by a PLC, or requested functionality has not been activated. | Check PLC programming. Check settings of parameter groups <i>50 Fieldbus adapter (FBA)</i> . |
| A6E5 | AI parameterization | The current/voltage hardware setting of an analog input does not correspond to parameter settings. | Check event record of auxiliary code. The code identifies the analog input whose settings are in conflict. Adjust either the hardware setting (on the drive control unit) or parameter <i>12.15/ 12.25</i> . Note: Control board reboot (either by cycling the power or through parameter <i>96.08 Control board boot</i>) is required to validate any changes in the hardware settings. |
| A6E6 | ULC configuration | User load curve configuration error. | Check the auxiliary code (format XXXX ZZZZ). "ZZZZ" indicates the problem (see actions for each code below). |

| Code (hex) | Warning / Aux. code | Cause | What to do |
|------------|---------------------------------------------------------------------------|---------------------------------------------------------------------------------------------------------------------------------|------------------------------------------------------------------------------------------------------------------------------------------------------------------------------------------------------------------------------------------------------------------------------------------------------------------------------------------------------------------|
| | 0000 | Speed points inconsistent. | Check that each speed point (parameters 37.11...37.15) has a higher value than the previous point. |
| | 0001 | Frequency points inconsistent. | Check that each frequency point (37.20...37.16) has a higher value than the previous point. |
| | 0002 | Underload point above overload point. | Check that each overload point (37.31...37.25) has a higher value than the corresponding underload point (37.21...37.25). |
| | 0003 | Overload point below underload point. | |
| A780 | Motor stall Programmable warning: 31.24 Stall function | Motor is operating in stall region because of, e.g., excessive load or insufficient motor power. | Check the motor load and drive ratings. Check fault function parameters. |
| A781 | Motor fan | Feedback from external fan is not received. | Check external fan one by one (or other controllable equipment). |
| A784 | Motor disconnect | All three output phases are disconnected from motor. | Check that switches between drive and motor are closed. Check that all cables between drive and motor are connected and secured. If no issue was detected and drive output was actually connected to motor, contact ABB. |
| A791 | Brake resistors | Brake resistor broken or not connected. | Check that a brake resistor has been connected. Check the condition of the brake resistor. |
| A793 | Brake resistor temperature is excessive | Brake resistor temperature has exceeded warning limit defined by parameter 43.12 Brake resistor warning limit . | Stop the drive. Let resistor cool down. Check resistor overload protection function settings (parameter group 43 Brake chopper). Check warning limit setting, parameter 43.12 Brake resistor warning limit . Check that the resistor has been dimensioned correctly. Check that braking cycle meets allowed limits. |
| A794 | BR data | Brake resistor data has not been given. | Check the resistor data settings (parameters 43.08...43.10). |
| A79B | Short circuit in brake chopper | Short circuit in brake chopper IGBT. | Replace brake chopper (if external). Drives with internal choppers will need to be returned to ABB. Ensure connection and no damages to brake resistor. |

| Code (hex) | Warning / Aux. code | Cause | What to do |
|------------|---------------------------------------------------------------------------------------------------|--------------------------------------------------------------------------------------------------------------------------------------------------------------------------------------------------------------------------|------------------------------------------------------------------------------------------------------------------------------------------------------------------------------------------------------------------------------------------------------------------------------------------------------------------------------------------------------------------------------------------------------------------------------------------------------------------------------------------|
| A79C | BC IGBT excess temperature | Brake chopper IGBT temperature has exceeded internal warning limit. | Let chopper cool down. Check for excessive ambient temperature. Check for cooling fan failure. Check for obstructions in the air flow. Check the dimensioning and cooling of the cabinet. Check resistor overload protection function settings (parameters 43.06...43.10). Check minimum allowed resistor value for the chopper being used. Check that braking cycle meets allowed limits. Check that drive supply AC voltage is not excessive. |
| A7AB | Failure of I/O configuration extension | It is mainly used for B0...B2 module. For example, if B0...B2 does not have RII0-01 extension module, to be inserted while the inverter adopts parameters of extended IO such as DI3, DI4, the drive will give an alarm. | View whether the inverter parameter adopts signals related to DI3 - DI6, AI1, AI2, AO1, AO2, RO2, RO3. These signals come from external IOboards. |
| A7C1 | FBA A communication Programmable warning: 50.02 FBA A communication loss function | Cyclical communication between drive and fieldbus adapter module A or between PLC and fieldbus adapter module A is lost. | Check status of fieldbus communication. See user documentation of fieldbus interface. Check settings of parameter group 50 Fieldbus adapter (FBA) , 51 FBA A settings , 52 FBA A data in and 53 FBA A data out . Check cable connections. Check if communication master is able to communicate. |
| A7CE | EFB comm loss Programmable warning: 58.14 Communication loss action | Communication break in embedded fieldbus (EFB) communication. | Check the status of the fieldbus master (online/offline/error etc.). Check the cable connections to the EIA-485/X5 terminals 29, 30 and 31 on the control unit. |
| A7EE | Control Panel loss Programmable warning: 49.05 Communication loss action | Control panel or PC tool selected as active control location for drive has ceased communicating. | Check PC tool or control panel connection. Check the control panel connector. Check the mounting platform (if being used). Disconnect and reconnect the control panel. |
| A8A0 | AI supervision Programmable warning: 12.03 AI supervision function | An analog signal is outside the limits specified for the analog input. | Check signal level at the analog input. Check the wiring connected to the input. Check the minimum and maximum limits of the input in parameter group 12 Standard AI . |
| A880 | Motor bearing | Warning generated by an ontime timer or a value counter. | Check the auxiliary code. Check warning signal source according to relevant code. |

| Code (hex) | Warning / Aux. code | Cause | What to do |
|------------|---------------------------------------------|---------------------------------------------------------------|---------------------------------------------------------------------------------------------------------------------------------------------------------------------------------------------------------------------------------------------------------------------------------------------------------------------------------------------------------------------------------------------------------------------------------------------------------------------------------------------------------------------------------------------------------------------------------------|
| A881 | Output relay | Warning generated by an edge counter. | Check the auxiliary code. Check warning signal source according to relevant code. |
| A882 | Motor start | | |
| A883 | Energized | | |
| A884 | Main contactors | | |
| A885 | DC-charge | | |
| A886 | real time 1 (editable information text) | Warnings generated by 1 realtime timer. | Check the warning signal source . |
| A887 | real time 2 (editable information text) | Warnings generated by 2 realtime timer. | Check the warning signal source . |
| A888 | Edge counter 1 (editable information text) | Warnings generated by 1 edge counter. | Check the warning signal source. |
| A889 | Edge counter 2 (editable information text) | Warnings generated by 2 edge counter. | Check the warning signal source . |
| A88A | Value counter 1 (editable information text) | Warnings generated by 1 value counter | Check the warning signal source . |
| A88B | Value counter 2 (editable information text) | Warnings generated by 2 value counter. | Check the warning signal source . |
| A88C | Device clear | Warnings generated by realtime timer. | Warnings generated by realtime timer. |
| A88D | DC capacitors | | |
| A88E | Cabinet fans | | |
| A88F | Cooling fan | | |
| A890 | Additional cooling | | |
| A8A0 | AI supervision | Analog signal exceeds the limit specified by the analog input | Check the auxiliary code (format XYY). "X" specifies the location of the input (0 : on the control unit; AI ; 1: I/O expansion module 1, etc), "YY" specifies input and limit (01 : AI1 lower than the minimum value, 02 : AI1 higher than the maximum value, 03 : AI2 lower than the minimum value, 04 : AI2 higher than the maximum value). Check signal level at the analog input. Check the wiring connected to the input. Check the minimum and maximum limits of the input in parameter group 12 Standard AI . |

| Code (hex) | Warning / Aux. code | Cause | What to do |
|------------|------------------------------------------------------------------------------------------------------------------------------------------------------------------------------------------------------------------|-----------------------------------------------------------------------------------------------------------------------------------------------------------------------|----------------------------------------------------------------------------------------------------------------------------------------------------------------------------------------------------------------------------------------------------------|
| A8B0 | Signal supervision (Editable message text) Programmable warning: 32.06 Supervision 1 action 32.16 Supervision 2 action 32.26 Supervision 3 action | Warning generated by a signal supervision function. | Check the warning signal source (parameter 32.07 , 32.17 or 32.27). |
| A8BE | ULC overload warning Programmable fault: 37.03 ULC overload actions | Selected signal has exceeded the user overload curve. | Check for any operating conditions increasing the monitored signal (for example, the loading of the motor if the torque or current is being monitored). Check the definition of the load curve (parameter group 37 User load curve). |
| A8BF | ULC underload warning Programmable fault: 37.03 ULC overload actions | Selected signal has fallen below the user underload curve. | Check for any operating conditions decreasing the monitored signal (for example, loss of load if the torque or current is being monitored). Check the definition of the load curve (parameter group 37 User load curve). |
| A8A1 | RO life warning | The relay has changed states more than the recommended number of times. | Change the control board or stop using the relay output. |
| | 0001 | Relay output 1 | Change the control board or stop using relay output 1. |
| | 0002 | Relay output 2 | Change the control board or stop using relay output 2. |
| | 0003 | Relay output 3 | Change the control board or stop using relay output 3. |
| A8A2 | RO toggle warning | The relay output is changing states faster than recommended, eg. if a fast changing frequency signal is connected to it. The relay lifetime will be exceeded shortly. | Replace the signal connected to the relay output source with a less frequently changing signal. |
| | 0001 | Relay output 1 | Select a different signal with parameter 10.24 RO1 source . |
| | 0002 | Relay output 2 | Select a different signal with parameter 10.27 RO2 source . |
| | 0003 | Relay output 3 | Select a different signal with parameter 10.30 RO3 source . |
| A981 | External warning 1 (Editable message text) Programmable warning: 31.01 External event 1 source 31.02 External event 1 type | Fault in external device 1 | Check the external device. Check setting of the parameter 31.01 External event 1 source . |

| Code (hex) | Warning / Aux. code | Cause | What to do |
|------------|------------------------------------------------------------------------------------------------------------------------------------------------------------------------|-------------------------------------------------------------------------------|-------------------------------------------------------------------------------------------------------------------------------------------------------------------------------------------------------------------------------------------------------------|
| A982 | External warning 2 (Editable message text) Programmable warning: 31.03 External event 2 source 31.04 External event 2 type | Fault in external device 2 | Check the external device. Check setting of the parameter 31.03 External event 2 source . |
| A983 | External warning 3 (Editable message text) Programmable warning: 31.05 External event 3 source 31.06 External event 3 type | Fault in external device 3 | Check the external device. Check setting of the parameter 31.05 External event 3 source . |
| A984 | External warning 4 (Editable message text) Programmable warning: 31.07 External event 4 source 31.08 External event 4 type | Fault in external device 5 | Check the external device. Check setting of the parameter 31.07 External event 4 source . |
| A985 | External warning 5 (Editable message text) Programmable warning: 31.09 External event 5 source 31.10 External event 5 type | Fault in external device 5 | Check the external device. Check setting of the parameter 31.09 External event 5 source . |
| AF88 | Season configuration warning | You have configured a season which starts before the previous season. | Configure the seasons with increasing start dates, see parameters 34.60 Season 1 start date... 34.63 Season 4 start date . |
| AF8C | Process PID sleep mode | The drive is entering sleep mode. | Informative warning. See section of Sleep and boost functions for process PID control . (page 75) and parameters 40.43... 40.48 . |
| AFAA | Autoreset | A fault is about to be autoreset. | Informative warning. See the settings in parameter group 31 Fault functions . |
| AFE1 | Emergency stop (off2) | Drive has received an emergency stop (mode selection off2) command. | Check whether it can continue to operate safely. Then return emergency stop push button to normal position. Restart drive. If the emergency stop was unintentional, check the source selected by parameter 21.05 Emergency stop source . |
| AFE2 | Emergency stop (off1 or off3) | Drive has received an emergency stop (mode selection off1 or off3) command. | |
| AFF5 | Override new start required | The Safe torque off function was active and has been reset while in Override. | A new start signal is required to start the drive again. |

| Code (hex) | Warning / Aux. code | Cause | What to do |
|------------|-----------------------------------------------------------------------------------|--------------------------------------------------------------------------------------------------------------------------------------------------------------------------------------------------------------------|-----------------------------------------------------------------------------------------------------------------------------------------------------------------------------------------------------------------------------------------------|
| AFE7 | Autophasing | Autophasing routine will be performed at next start to determine the angular position of the magnetic flux (with a permanent magnet synchronous motor) or the magnetic axis (with a synchronous reluctance motor). | Informative warning. |
| AFE9 | Start delay | The start delay is active and the drive will start the motor after a predefined delay. | Informative warning. See parameter 21.22Start delay . |
| AFEB | Run enable missing | No run enable signal is received. | Check setting of the parameter 20.12 Run enable 1 source . Switch signal on (e.g., in the fieldbus Control Word) or check wiring of selected source. |
| AFEC | External power signal missing | 95.04 Control board supply is set to External 24V but no voltage is connected to the control unit. | Check the external 24 V DC power supply to the control unit, or change the setting of parameter 95.04 . |
| AFED | Enable to rotate | Signal enable to rotate has not been received within a fixed time delay. | Switch enable to rotate signal on (eg. In digital inputs). Check the setting of (and source selected by) parameter 20.22Enable to rotate . |
| B5A0 | STO event Programmable event : 31.22STO indication run/stop | Delete safe torque function is active, i.e. safety circuit signal(s) connected to connector STO is lost. | Check safety circuit connections. For more information, see description in chapter <i>Delete safe torque function</i> as well as parameter 31.22STO indication run/stop (page 207) of drive hardware manual. |

Fault messages

| Code (hex) | Fault / Aux. code | Cause | What to do |
|------------|-------------------------------------------------------------------------------------|-----------------------------------------------------------------------------------------------------------------------------------------------------------------------------|-----------------------------------------------------------------------------------------------------------------------------------------------------------------------------------------------------------------------------------------------------------------------------------------------------------------------------------------------------------------------------------------------------------------------------------------------------------------------------------------------------------------------------------------------------------------------------------------------------------|
| 1080 | Backup/Restore timeout | Panel or PC tool has failed to communicate with the drive when backup was being made or restored. | Request backup or restore again. |
| 1081 | Rating ID fault | Drive software has not been able to read the rating ID of the drive. | Reset the fault to make the drive try to reread the rating ID. If the fault reappears, cycle the power to the drive. You may have to repeat this. If the fault persists contact your local ABB representative. |
| 2310 | Over current | Output current has exceeded internal fault limit. In addition to an actual overcurrent situation, this fault may also be caused by an ground fault or supply phase loss. | Check motor load. Check motor and motor cable (including phasing and delta/star connection). Check there are no contactors opening and closing in motor cable. Check that the start-up data in parameter group 99 corresponds to the motor rating plate. Check there are no power factor correction capacitors or surge absorbers in motor cable. Check for an ground fault in motor or motor cables by measuring the insulation resistances of motor and motor cable. See section <i>Check assemble insulation</i> in the Chapter of Electrical installation in drive hardware manual. |
| 2330 | Earth leakage Programmable fault: 31.20 Ground fault | Drive has detected load unbalance typically due to ground fault in motor or motor cable. | Check there are no power factor correction capacitors or surge absorbers in motor cable. Check for an ground fault in motor or motor cables by measuring the insulation resistances of motor and motor cable. If no ground fault can be detected, contact your local ABB representative. |
| 2340 | Short circuit | Short-circuit in motor cable(s) or motor | Check motor and motor cable for cabling errors. Check there are no power factor correction capacitors or surge absorbers in motor cable. Cycle the power to the drive. |
| 2381 | IGBT overload | Excessive IGBT junction to case temperature. This fault protects the IGBT(s) and can be activated by a short circuit in the motor cable. | Check motor cable. Check ambient conditions. Check air flow and fan operation. Check heat sink fins for dust pick-up. Check motor power against drive power. |
| 3130 | Supply phase loss Programmable fault: 31.21 Supply phase loss | Intermediate circuit DC voltage is oscillating due to missing input power line phase or blown fuse. | Check input power line fuses. Check for loose power cable connections. Check for input power supply imbalance. |

| Code (hex) | Fault / Aux. code | Cause | What to do |
|------------|------------------------------------------------------------------------------------|-----------------------------------------------------------------------------------------------------------------------------------|--------------------------------------------------------------------------------------------------------------------------------------------------------------------------------------------------------------------------------------------------------------------------------------------------------------------------------------------------------------------------------------------------------------------------------------------------------------------------------------------------------------------------------------------------------------|
| 3181 | Cross connection Programmable fault: 31.23 Cross connection | Incorrect input power and motor cable connection (ie. input power cable is connected to drive motor connection). | Check input power connections. |
| 3210 | DC bus overvoltage | Excessive intermediate circuit DC voltage. | Check that overvoltage control is on (parameter 30.30 Overvoltage control). Check that the supply voltage matches the nominal input voltage of the drive. Check the supply line for static or transient overvoltage. Check brake chopper and resistor (if present). Check deceleration time. Use coast-to-stop function (if applicable). Retrofit the drive with brake chopper and brake resistor. Check that the brake resistor is dimensioned properly and the resistance is between acceptable range for the drive. |
| 3220 | DC bus undervoltage | Intermediate circuit DC voltage is not sufficient because of a missing supply phase, blown fuse or fault in the rectifier bridge. | Check supply cabling, fuses and switchgear. |
| 3280 | Standby time-out | Automatic restart failed. | Check power condition (voltage, cable, fuse, switch). |
| 3381 | Output phase loss Programmable fault: 31.19 Motor phase loss | Motor circuit fault due to missing motor connection (None of the three phases is connected). | Connect motor cable. |
| 4000 | Motor cable overload | Calculated motor cable temperature has exceeded warning limit. | Check the settings of 35.61 and 35.62 . Check the motor cable size against necessary load. |
| 4110 | Control board temperature | Control board temperature is excessive. | Check proper cooling of the drive. Check the auxiliary cooling fan. |
| 4210 | IGBT overtemperature | Estimated drive IGBT temperature is excessive. | Check ambient conditions. Check air flow and fan operation. Check heat sink fins for dust pick-up. Check motor power against drive power. |
| 4290 | Cooling | Drive module temperature is excessive. | Check ambient temperature. If it exceeds 40 °C/104 °F (frames R5 ...R9) or if it exceeds 50 °C /122 °F (frames B0...R9), ensure that load current does not exceed derated load capacity of drive. See section <i>Derating</i> in the Chapter of Technical Data of drive hardware manual. Check drive module cooling air flow and fan operation. Check inside of cabinet and heatsink of drive module for dust pick-up. Clean whenever necessary. |

| Code (hex) | Fault / Aux. code | Cause | What to do |
|------------|--------------------------------------------------------------------------------------|----------------------------------------------------------------------------------------------------------------------------------|------------------------------------------------------------------------------------------------------------------------------------------------------------------------------------------------------------------------------------------------------------------------------------------------------------|
| 42F1 | IGBT temperature | Drive IGBT temperature is excessive. | Check ambient conditions. Check air flow and fan operation. Check heat sink fins for dust pick-up. Check motor power against drive power. |
| 4310 | Excess temperature | Power unit module temperature is excessive. | Check ambient conditions. Check air flow and fan operation. Check heat sink fins for dust pick-up. Check motor power against drive power. |
| 4380 | Excess temperature difference | High temperature difference between the IGBTs of different phases. | Check motor cabling. Check cooling of the drive module(s). |
| 4381 | PCB plate cooling | Temperature difference between ambient and drive module PCB space is excessive. | See A4B2 PCB plate cooling (page 355). |
| 4981 | Ext Tmp 1 (Editable message text) | Measured temperature 1 has exceeded fault limit. | Check the value of parameter 35.02 Measured temperature 1 . Check the cooling of the motor (or other equipment whose temperature is being measured). |
| 4982 | Ext Tmp2 (Editable message text) | Measured temperature 2 has exceeded fault limit. | Check the value of parameter 35.03 Measured temperature 2 . Check the cooling of the motor (or other equipment whose temperature is being measured). |
| 5080 | Fan | Cooling fan is stuck or disconnected. | See A581 Fan (page 356). |
| 5081 | Auxiliary fan broken | An auxiliary cooling fan (connected to the fan connectors on the control unit) is stuck or disconnected. | Check auxiliary fan(s) and connection(s). Replace faulty fan. Make sure the front cover of the drive module is in place and tightened. Reboot the control unit (using parameter 96.08 Control board boot) or by cycling power. |
| 5090 | STO hardware failure | STO hardware diagnostics has detected hardware failure. | Contact your local ABB representative for hardware replacement. |
| 5091 | Delete safe torque Programmable fault: 31.22 STO indication run/stop | Delete safe torque function is active, i.e. safety circuit signal(s) connected to connector XSTO is missing during start or run. | Check safety circuit connections. For more information, see description in chapter <i>Delete safe torque function</i> as well as parameter 31.22 STO indication run/stop (page 207) of drive hardware manual. Check the value of parameter 95.04 Control board supply . |
| 5092 | PU logic error | Power unit memory has cleared. | Contact your local ABB representative. |
| 5093 | Rating ID mismatch | The hardware of the drive does not match the information stored in the memory. This may occur eg. after a firmware update. | Cycle the power to the drive. You may have to be repeat this. |

| Code (hex) | Fault / Aux. code | Cause | What to do |
|------------|---------------------------------|-------------------------------------------------------------------------------------------------------------------------|--------------------------------------------------------------------------------------------------------------------------------------------------------------------------|
| 5094 | Measurement circuit temperature | Problem with internal temperature measurement of the drive. | Contact your local ABB representative. |
| 5095 | Redundant measurement | Redundant measurement supervision has indicated a difference in the duplicated measurements that is outside the limits. | Contact your local ABB representative. |
| 50A0 | Fan | Cooling fan is stuck or disconnected. | Check fan operation and connection. Replace faulty fan. |
| 5681 | PU communication | Communication errors detected between the drive control unit and the power unit. | Check the connection between the drive control unit and the power unit. Check the value of parameter 95.04 Control board supply . |
| 5682 | Power unit lost | Connection between the drive control unit and the power unit is lost. | Check the connection between the control unit and the power unit. |
| 5690 | PU internal communication | Internal communication error. | Contact your local ABB representative. |
| 5691 | Measurement circuit ADC | Measurement circuit fault. | Contact your local ABB representative. |
| 5692 | PU board powerfail | Power unit power supply failure. | Contact your local ABB representative. |
| 5693 | Measurement circuit DFF | Measurement circuit fault. | Contact your local ABB representative. |
| 5696 | PU state feedback | State feedback from output phases does not match control signals. | Contact your local ABB representative. |
| 5697 | Charging feedback | Charging feedback signal missing. | Check the feedback signal coming from the charging system |
| 5698 | Unknown power fault | Unidentified power unit logic fault. | Check power unit logic and firmware compatibility. Contact local ABB representative. |
| 6000 | Internal software error | Internal error. | Contact local ABB representative. Quote the auxiliary code (check the event details in the event log). |
| 6181 | FPGA version incompatible | Firmware and FPGA versions are incompatible. | Reboot the control unit (using parameter 96.08 Control board boot) or by cycling power. If the problem persists, contact your local ABB representative. |
| 6306 | FBA A mapping file | Fieldbus adapter A mapping file read error. | Contact your local ABB representative. |
| 6481 | Task overload | Internal fault. | Reboot the control unit (using parameter 96.08 Control board boot) or by cycling power. If the problem persists, contact your local ABB representative |
| 6487 | Stack overflow | Internal fault. | Reboot the control unit (using parameter 96.08 Control board boot) or by cycling power. If the problem persists, contact your local ABB representative. |

| Code (hex) | Fault / Aux. code | Cause | What to do |
|------------|--------------------------------------------------------------------------------------------------|------------------------------------------------------------------------------------------------------------------------------------------------------------------------------------------------------------------------------------------|--------------------------------------------------------------------------------------------------------------------------------------------------------------------------|
| 64A1 | Internal file load | File read error. | Reboot the control unit (using parameter 96.08 Control board boot) or by cycling power. If the problem persists, contact your local ABB representative. |
| 64B2 | User group fault | Loading of user parameter group failed because <ul style="list-style-type: none"> Requested group does not exist set is not compatible with control program Drive switches off during the load process. | Ensure that a valid user parameter group exists. Reload if uncertain. |
| 64E1 | Kernel overload | Operating system error. | Reboot the control unit (using parameter 96.08 Control board boot) If the problem persists, contact your local ABB representative |
| AFF7 | Fault reset | A fault has been reset from the control panel, Drive composer PC tool, fieldbus or I/O. | Event. Informative only. |
| 6581 | Parameter system | Unable to load or save parameter. | Try forcing a save using parameter 96.07 Parameter save manually . Retry. |
| 65A1 | FBA A parameter conflict | The drive does not have a functionality requested by a PLC, or requested functionality has not been activated. | Check PLC programming. Check settings of parameter groups 50 Fieldbus adapter (FBA) and 51 FBA A settings . |
| 64B3 | Macro parameterization error | Macro parameterization failed, because parameter default value that cannot be changed has been attempted to write. | |
| 6681 | EFB Communication loss Programmable fault: 58.14 Communication loss action | Communication break in embedded fieldbus (EFB) communication. | Check the status of the fieldbus master (online/offline/error etc.) Check the cable connections to the EIA-485/X5 terminals 29, 30 and 31 on the control unit. |
| 6682 | EFB profile | Embedded fieldbus (EFB) configuration file could not be read. | Contact your local ABB representative. |
| 6683 | EFB invalid parameterization | Embedded fieldbus (EFB) parameter settings inconsistent or not compatible with selected protocol. | Check the settings in parameter group 58 Embedded fieldbus . |
| 6684 | EFB load fault | Embedded fieldbus (EFB) protocol firmware could not be loaded. | Contact your local ABB representative. |
| | | Version mismatch between EFB protocol firmware and drive firmware. | |
| 6685 | EFB fault 2 | Fault reserved for the EFB protocol application. | Check the documentation of the protocol. |
| 6686 | EFB fault 3 | Fault reserved for the EFB protocol application. | Check the documentation of the protocol. |

| Code (hex) | Fault / Aux. code | Cause | What to do |
|------------|-------------------------------------------------------------------------------------------|-----------------------------------------------------------------------------------------------------------------------------|---------------------------------------------------------------------------------------------------------------------------------------------------------------------------------------------------------------------------------------------------------------------------------------------------|
| 6882 | Text 32-bit table overflow | Internal fault. | Reset the fault. If the fault persists contact your local ABB representative. |
| 6885 | Text file overflow | Internal fault. | Reset the fault. If the fault persists contact your local ABB representative. |
| 7081 | Control panel loss programmable fault: 49.05 Communication loss action | Control panel or PC tool selected as active control location for drive has ceased communicating. | Check PC tool or control panel connection. Check the control panel connector. Disconnect and reconnect the control panel. |
| 7082 | Expansion I/O communication lost | The I/O extension module types specified by parameters do not match the detected configuration. | Check auxiliary code (format XXYY YYYY). "XX" specifies I/O number of the I/O extension module. "YY YYYY" indicates problem (See the corresponding action of each code below). |
| | 00 0001 | Communication between modules failed. | Check whether the module is correctly installed in slot. Check whether the module and slot connector is damaged. Try to install the module into another slot. |
| | 00 0002 | Module is not found. | Check module type and position settings (parameter 15.01/14.02 , 15.01/15.02 or 16.01/16.02). |
| | 00 0003 | Configuration of module failed. | |
| | 00 0004 | Configuration of module failed. | Check whether the module is correctly installed in slot. Check whether the module and slot connector is damaged. Try to install the module into another slot. |
| 7121 | Motor stall Programmable fault: 31.24 Stall function | Motor is operating in stall region because of, e.g., excessive load or insufficient motor power. | Check the motor load and drive ratings. Check fault function parameters. |
| 7181 | Brake resistors | Brake resistor broken or not connected. | Check that a brake resistor has been connected. Check the condition of the brake resistor. Check the size of the brake resistor. |
| 7183 | Brake resistor temperature is excessive | Brake resistor temperature has exceeded fault limit defined by parameter 43.11 Brake resistor fault limit . | Stop the drive. Let resistor cool down. Check resistor overload protection function settings (parameter group 43 Brake chopper). Check fault limit setting, parameter 43.11 Brake resistor fault limit . Check that braking cycle meets allowed limits. |
| 7184 | Brake resistor wiring | Brake resistor short circuit or brake chopper control fault. Brake resistor temperature is excessive | Check brake chopper and brake resistor connection. Ensure brake resistor is not damaged. |

| Code (hex) | Fault / Aux. code | Cause | What to do |
|------------|-------------------------------------------------------------------------------------------------|------------------------------------------------------------------------------------------------------------------------------------------------------------------------------------------------------------------------|--------------------------------------------------------------------------------------------------------------------------------------------------------------------------------------------------------------------------------------------------------------------------------------------------------------------------------------------------------------------------|
| 7086 | AI Overvoltage | An overvoltage has been detected on an analog input. The analog input has temporarily been changed to voltage mode and will be changed back to current mode when the AI signal level is back within acceptable limits. | Check AI signal levels. |
| 7191 | Short circuit in brake chopper | Short circuit in brake chopper IGBT. | Ensure the brake resistor is connected and not damaged. Check the electrical specifications of the brake resistor against chapter <i>Resistor brake</i> of drive hardware manual. Replace brake chopper (if replaceable). |
| 7192 | Brake chopper IGBT temperature is excessive. | Brake chopper IGBT temperature has exceeded internal fault limit. | Let chopper cool down. Check for excessive ambient temperature. Check for cooling fan failure. Check for obstructions in the air flow. Check resistor overload protection function settings (parameter group 43 Brake chopper). Check that braking cycle meets allowed limits. Check that drive supply AC voltage is not excessive. |
| 71B1 | Motor fan | No feedback signals of external fan have been received. | Check external fan one by one (or other controllable equipment). |
| 73B0 | Emergency ramp failed | Emergency stop did not finish within expected time. | Check the predefined ramp times 23.11...23.15 , for (mode Off1, 23.23 for mode Off3). |
| 7510 | FBA A communication Programmable fault: 50.02 FBA A communication loss function | Cyclical communication between drive and fieldbus adapter module A or between PLC and fieldbus adapter module A is lost. | Check status of fieldbus communication. See user documentation of fieldbus interface. Check settings of parameter group 50 Fieldbus adapter (FBA) , 51 FBA A settings , 52 FBA A data in and 53 FBA A data out . Check cable connections. Check if communication master is able to communicate. |
| 8001 | ULC underload fault | User load curve: Signal has been too long under the underload curve. | See parameter 37.04 ULC overload actions . |
| 8002 | ULC overload fault | User load curve: Signal has been too long over the overload curve. | See parameter 37.04 ULC overload actions . |
| 80A0 | AI supervision Programmable fault: 12.03 AI supervision function | An analog signal is outside the limits specified for the analog input. | Check signal level at the analog input. Check the wiring connected to the input. Check the minimum and maximum limits of the input in parameter group 12 Standard AI . |

| Code (hex) | Fault / Aux. code | Cause | What to do |
|------------|-------------------------------------------------------------------------------------------------------------------------------------------------------------------------------------------------------------|------------------------------------------------------------------|--------------------------------------------------------------------------------------------------------------------------------------------------------|
| 80B0 | Signal supervision (Editable message text) Programmable fault: 32.06 Supervision 1 action 32.16 Supervision 2 action 32.26 Supervision 3 action | Fault generated by a signal supervision function. | Check the source of the fault (parameter 32.07 , 32.17 or 32.27). |
| 9081 | External fault 1 (Editable message text) Programmable fault: 31.01 External event 1 source 31.02 External event 1 type | Fault in external device 1 | Check the external device. Check setting of the parameter 31.01 External event 1 source . |
| 9082 | External fault 2 (Editable message text) Programmable fault: 31.03 External event 2 source 31.04 External event 2 type | Fault in external device 2 | Check the external device. Check setting of the parameter 31.03 External event 2 source . |
| 9083 | External fault 3 (Editable message text) Programmable fault: 31.05 External event 3 source 31.06 External event 3 type | Fault in external device 3 | Check the external device. Check setting of the parameter 31.05 External event 3 source . |
| 9084 | External fault 4 (Editable message text) Programmable fault: 31.07 External event 4 source 31.08 External event 4 type | Fault in external device 5 | Check the external device. Check setting of the parameter 31.07 External event 4 source . |
| 9085 | External fault 5 (Editable message text) Programmable fault: 31.09 External event 5 source 31.10 External event 5 type | Fault in external device 5 | Check the external device. Check setting of the parameter 31.09 External event 5 source . |
| FA81 | Delete safe torque 1 | Safe torque off function is active, ie, STO circuit 1 is broken. | Check safety circuit connections. For detailed information, see the description of parameter 31.22 STO indication run/stop (page 207). |
| FA82 | Delete safe torque 2 | Safe torque off function is active, ie, STO circuit 2 is broken. | Check the value of parameter 95.04 Control board supply . |

| Code (hex) | Fault / Aux. code | Cause | What to do |
|-------------------|--------------------------|---------------------------------------------------------------------------------|--------------------------------------------------|
| FF81 | FB A force trip | A fault trip command has been received through fieldbus adapter A. | Check the fault information provided by the PLC. |
| FF8E | EFB force trip | A fault trip command has been received through the embedded fieldbus interface. | Check the fault information provided by the PLC. |



Control chain diagrams

What this chapter contains

The chapter presents the reference chains of the drive. The control chain diagrams can be used to trace how parameters interact and where parameters have an effect within the converter parameter system.

For a more general diagram, see section [Operating modes of the drive](#) (page 66).

Frequency reference selection

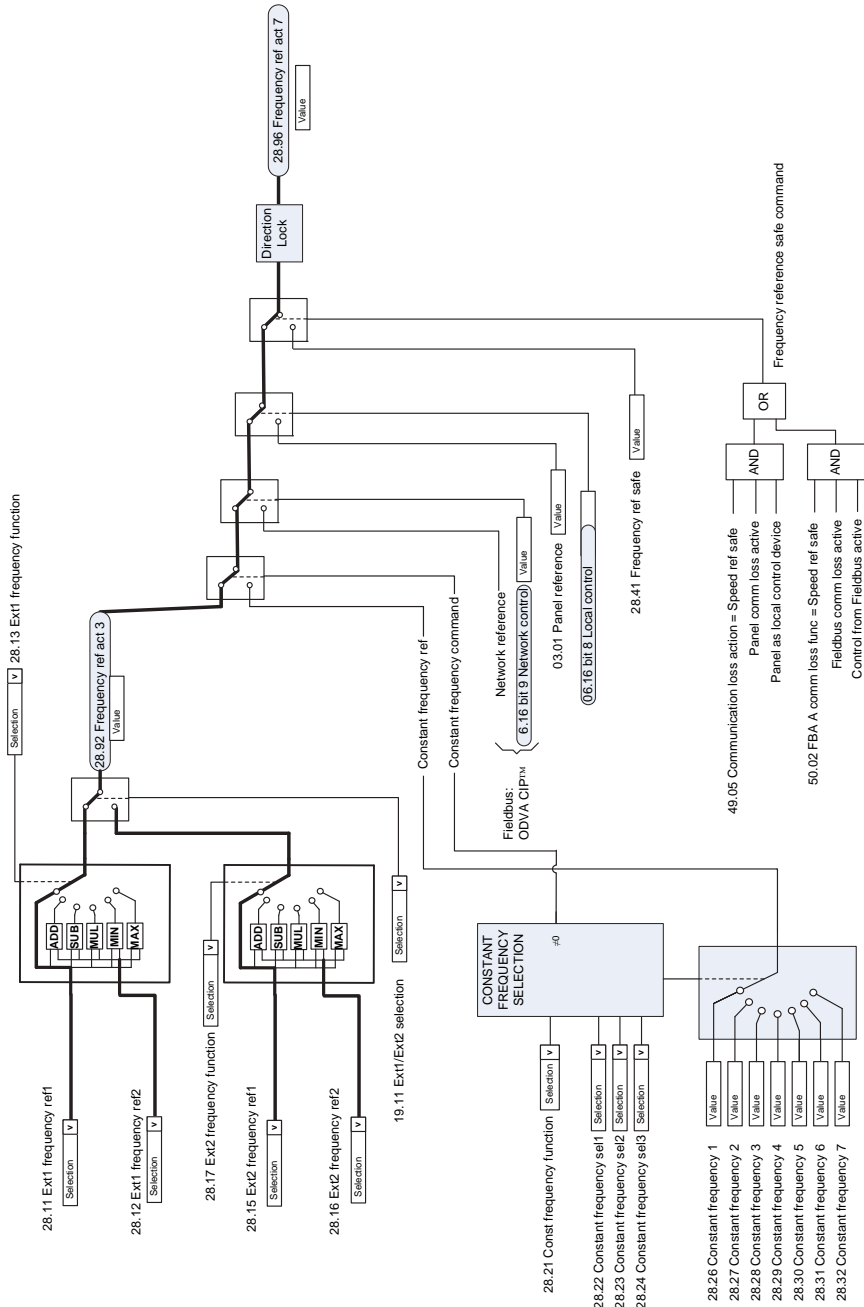

Frequency reference modification

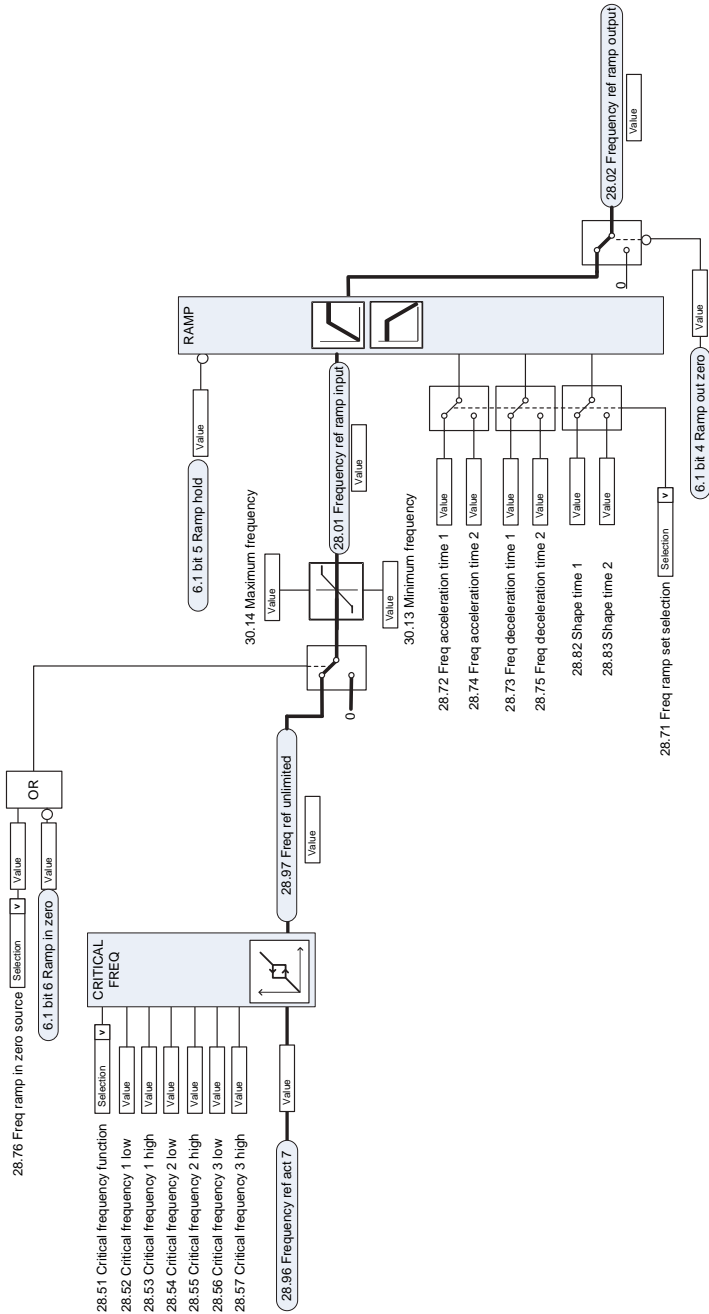

Process PID setpoint and feedback source selection

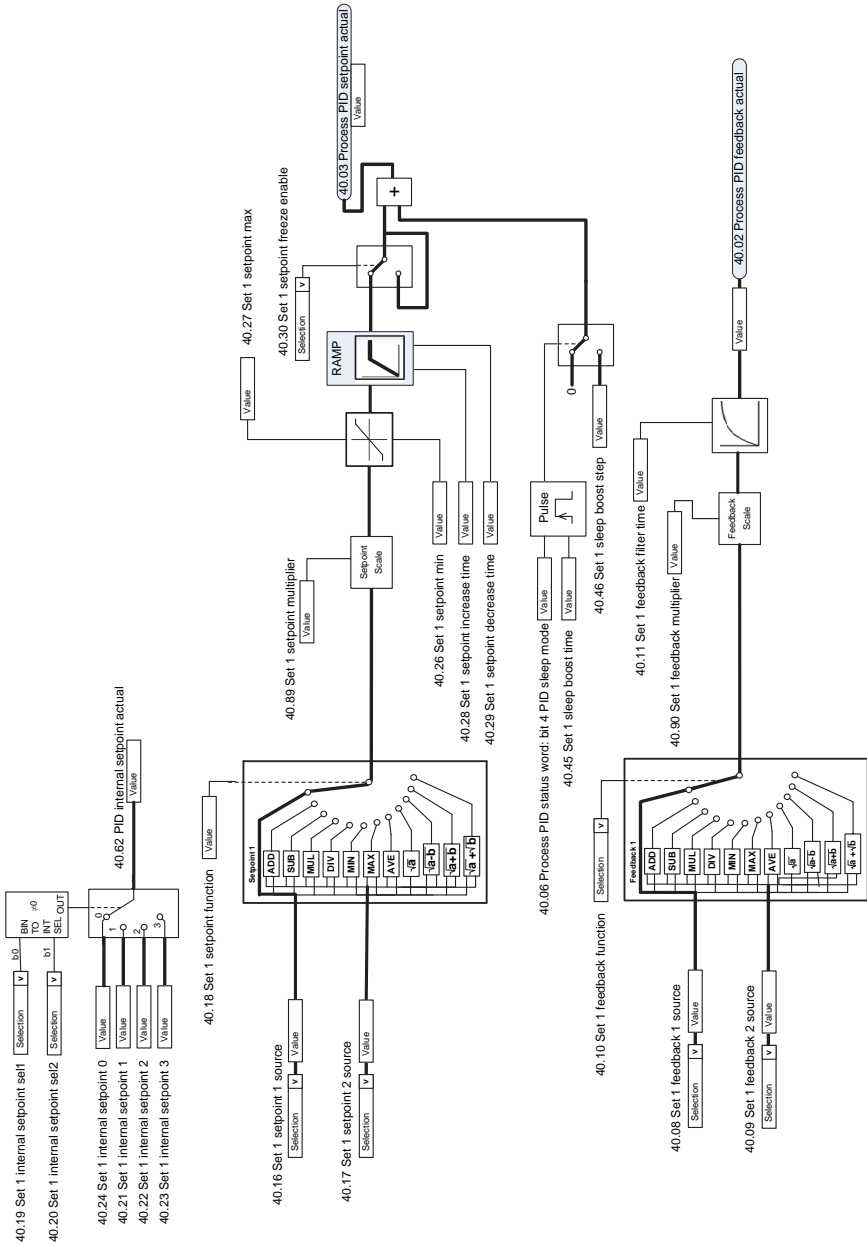

Process PID controller

PROCESS PID FUNCTION

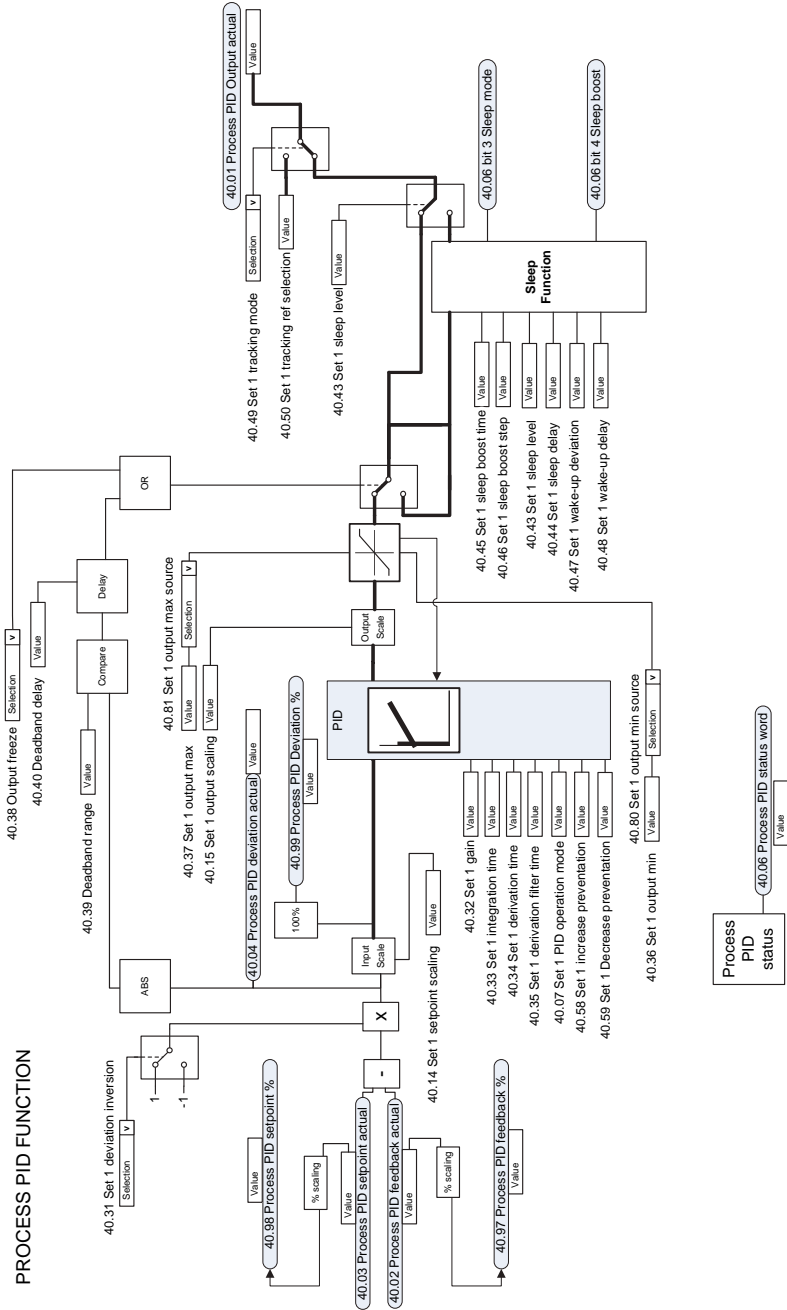

Process PID status
40.06 Process PID status word
Value

Direction lock

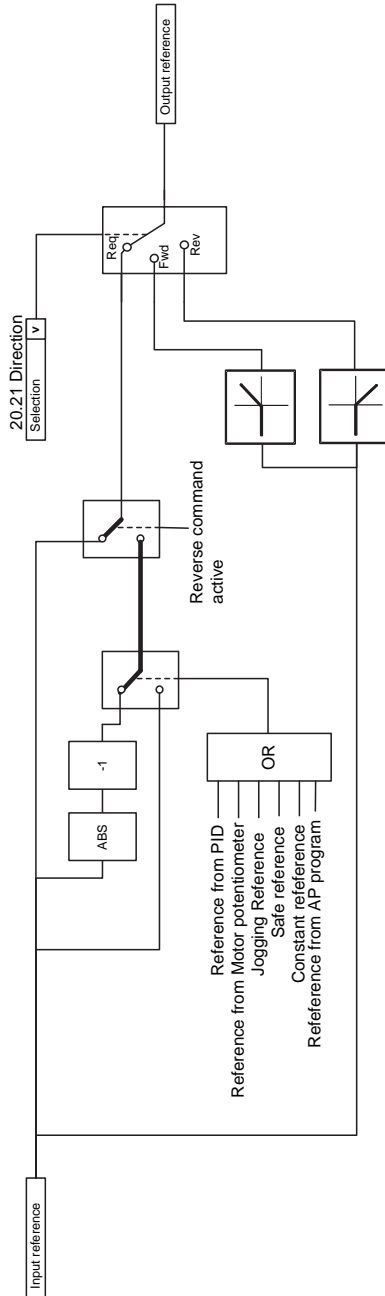

Further information

Product and service inquiries

Address any inquiries about the product to your local ABB representative, quoting the type designation and serial number of the unit in question. A listing of ABB sales, support and service contacts can be found by navigating to new.abb.com/channel-partners/search

Product training

For information on ABB product training, navigate to new.abb.com/service/training

Providing feedback on ABB Drives manuals

Your comments on our manuals are welcome. Navigate to new.abb.com/drives/manuals-feedback-form

Document library on the Internet

You can find manuals and other product documents in PDF format on the Internet at library.abb.com



abb.com/drives