

**SIEMENS**  
*Ingenuity for life*



# SINAMICS V20

The cost-effective, reliable  
and easy-to-use drive for  
basic applications

[usa.siemens.com/sinamics-v20](http://usa.siemens.com/sinamics-v20)

# SINAMICS V20

The perfect drive solution for basic applications



## SINAMICS V20, the versatile drive for basic applications

Today, in an increasing number of applications in plant and machinery construction, individual automation and drive solutions are demanded that automate simple motion sequences with low associated requirements.

With its compact SINAMICS V20, Siemens offers a simple and cost-effective drive solution for these types of applications. SINAMICS V20 sets itself apart with its quick commissioning times, ease of operation, robustness and cost efficiency.

With seven frame sizes, it covers a power range extending from 0.12 kW up to 30 kW (1/6 hp up to 40 hp).

## Minimize your costs

Engineering, commissioning and operating costs as well as those in operation must be kept as low as possible. Well, with our SINAMICS V20, you have precisely the right answer.

To increase energy efficiency, the drive is equipped with a control technique to achieve optimal energy efficiency through automatic flux reduction. Not only this, it displays the actual energy consumption and has additional, integrated energy-saving functions.



## Highlights

### Easy-to-install

- Push-through and wall mounting—side-by-side is possible
- USS and Modbus RTU at terminals
- Integrated braking chopper for 7.5 kW to 30 kW (10 hp up to 40 hp)
- Electromagnetic compatibility (EMC) category C1/C2

### Easy-to-use

- Parameter loading without power supply
- Easy commissioning with mobile device or laptop with web server module SINAMICS V20 Smart Access
- Integrated application and connection macros
- Keep Running mode for uninterrupted operation
- Wide voltage range, advanced cooling design and coated PCBs increase robustness

### Easy to save money

- ECO mode for V/f, V<sup>2</sup>/f / Hibernation mode
- Monitoring energy and water flows
- High overload and low overload mode for FSE

Power range	Voltage range	Control modes
0.12 kW to 30 kW (1/6 hp up to 40 hp)	1AC 200V ... 240V (–10% / +10%) <sup>1), 2)</sup> 3AC 380V ... 480V (–15% / +10%)	V/f V <sup>2</sup> /f FCC V/f multi-point

<sup>1)</sup> Single-phase devices can also be connected to two phases of a 3-phase 120/240V supply system. The voltage between L1 and L2 should be in the 200V to 240V, –10% to 10% (whether phase to phase or phase to neutral). You can find detailed information here: <http://support.industry.siemens.com/cs/document/109476260>

<sup>2)</sup> Voltage tolerance for FSAA/FSAB (–15% / +10%)

# Typical applications and SINAMICS V20 benefits

<p><b>Pumping, ventilating and compressing</b></p> <ul style="list-style-type: none"> <li>Centrifugal pumps</li> <li>Radial/axial fans</li> <li>Compressors</li> </ul>  	<p><b>Advantages</b></p> <ul style="list-style-type: none"> <li>High availability through automatic restart and flying restart after power failures</li> <li>Broken belt detection by monitoring the load torque</li> <li>Pump protection against cavitation</li> <li>Hammer start and blockage clearing modes for clogged pumps</li> <li>PID controller for process values (e.g. temperature, pressure, level, flow)</li> <li>PID auto tuning to optimize controller parameters</li> <li>Hibernation mode stops the motor when demand is low</li> <li>Motor staging extends the flow range by adding two more fixed-speed drives (cascade)</li> <li>Frost and condensation protection prevents moisture in motors under extreme environmental conditions</li> </ul>
<p><b>Moving</b></p> <ul style="list-style-type: none"> <li>Belt conveyors</li> <li>Roller conveyors</li> <li>Chain conveyors</li> <li>Bucket conveyors</li> <li>Treadmills</li> </ul>  	<p><b>Advantages</b></p> <ul style="list-style-type: none"> <li>Soft, jerk-free acceleration reduces the stress on the gear units, bearings, drums and rollers</li> <li>Super torque start for conveyor belts with high breakaway torque</li> <li>Dynamic behavior by using braking resistor or DC braking</li> <li>Direct control of mechanical holding brake</li> <li>Broken belt detection by monitoring the load torque</li> <li>Precise stopping with Quick Stop (switch-off positioning) independently from the control cycle</li> </ul>
<p><b>Processing</b></p> <ul style="list-style-type: none"> <li>Single drives</li> <li>Main drives</li> </ul>  	<p><b>Advantages</b></p> <ul style="list-style-type: none"> <li>Single drives in the process industry such as mills, mixers, kneaders, crushers, agitators, centrifuges</li> <li>Single drives in commercial appliances such as kitchen ovens, mixers, washing machines</li> <li>Main drives in machines with mechanically coupled axes such as ring spinning machines, braiding machines for textile, ropes and cables</li> <li>Frost and condensation protection prevents moisture in motors under extreme environmental conditions</li> <li>Higher productivity with uninterrupted production due to Keep Running mode</li> <li>Exchange of regenerative energy via the DC link</li> <li>Super torque start for machines with a high breakaway torque</li> </ul>

# Easy-to-install

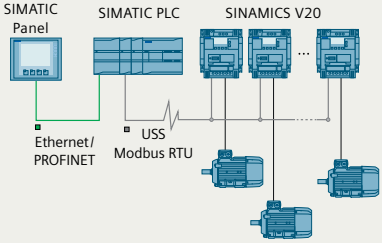

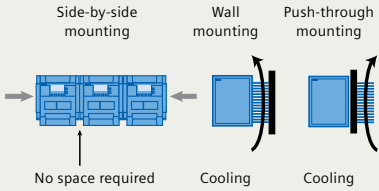
SINAMICS V20 feature	Your benefits
<p><b>Everything from a single source</b></p>	
	<p>Together with SIMATIC PLC/HMI, tested and ready-to-run application examples to connect a V20 drive to a controller are available.</p> <ul style="list-style-type: none"> <li>■ Different application examples can be downloaded free of charge from the online support portal</li> </ul> <p>For more information, see also page 9 or go directly to: <a href="http://siemens.com/sinamics-applications">siemens.com/sinamics-applications</a></p>

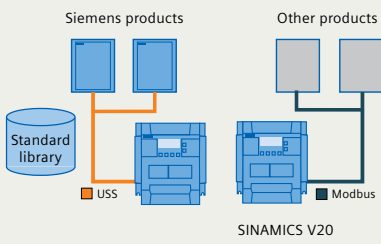
Installation	
	<p>Compact design, side-by-side mounting and flexible device installation for both wall mounting and push-through mounting.</p> <p>Operation without additional option modules possible.</p> <ul style="list-style-type: none"> <li>■ Compact installation allows smaller cabinets to be used</li> <li>■ Push-through mounting allows the cabinet to be cooled more easily</li> <li>■ Can be run "out-of-the-box" without other options</li> <li>■ Basic operator actions at a built-in BOP (Basic Operator Panel)</li> <li>■ Frame sizes FSAA and FSAB (1AC 230V) 24% smaller compared to previous frame size FSA within the same power range</li> </ul>

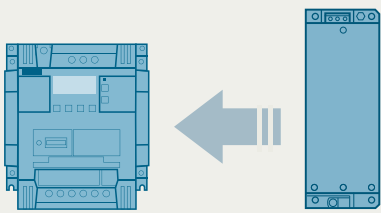
Communication	
	<p>The communication port is available at terminals.</p> <p>The preset parameters of the USS and Modbus RTU are defined in the connection macro.</p> <ul style="list-style-type: none"> <li>■ Easy integration into existing systems and micro-automation systems</li> <li>■ Easier commissioning through standard libraries and connection macros</li> <li>■ Full flexibility of Modbus RTU settings within the communication with controllers</li> <li>■ Simple connection to a control system (SIMATIC PLC)</li> </ul>

EMC category C1	
	<p>SINAMICS V20 in frame sizes FSAA and FSAB, 1AC 230 V with integrated category C1 EMC filter are available.</p> <ul style="list-style-type: none"> <li>■ Can be operated in EMC-sensitive environments such as residential areas, without requiring additional external filters</li> </ul>

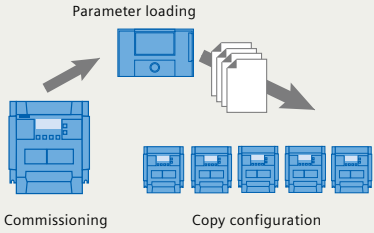
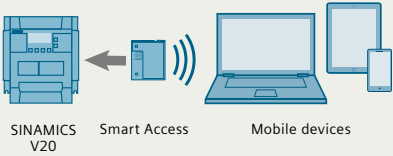
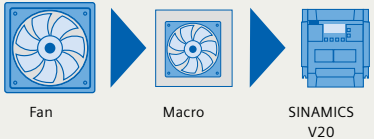
# Easy-to-use

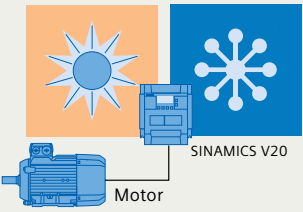
	SINAMICS V20 feature	Your benefits
<h3>Parameter cloning</h3>	 <p>Parameter loading</p> <p>Commissioning</p> <p>Copy configuration</p> <p>Parameter settings can be easily transferred from one unit to another using the parameter loader — even without a power supply.</p>	<ul style="list-style-type: none"> <li>■ Less technical support required</li> <li>■ Short commissioning time</li> <li>■ The product is delivered to the customer already preset</li> </ul>
<h3>SINAMICS V20 Smart Access</h3>	 <p>SINAMICS V20</p> <p>Smart Access</p> <p>Mobile devices</p> <p>Wireless commissioning, operation and diagnostics via mobile device or laptop with web server module SINAMICS V20 Smart Access (option)</p>	<ul style="list-style-type: none"> <li>■ Provides easy access to the drive even if it is located in difficult-to-access areas</li> <li>■ Easy operation due to intuitive web user interface and commissioning wizard</li> <li>■ Full flexibility in choosing your end device for engineering as the SINAMICS V20 Smart Access is a web server approach that works with any operating system and any HTML5 capable web browser</li> </ul>
<h3>Macro approach</h3>	 <p>Fan</p> <p>Macro</p> <p>SINAMICS V20</p> <p>Connection and application macros to simplify I/O configuration and make the appropriate settings.</p>	<ul style="list-style-type: none"> <li>■ Shorter training and commissioning time</li> <li>■ Integrated and optimized application setting</li> <li>■ Simple connection and application macros can be selected instead of configuring long complicated parameter lists</li> <li>■ Errors caused by wrong parameter settings can be avoided</li> </ul>
<h3>Keep Running mode</h3>	 <p>SINAMICS V20</p> <p>Motor</p> <p>The function provides higher productivity in production by automatic adaptation in the case of unstable line supplies.</p>	<ul style="list-style-type: none"> <li>■ Stable operation under difficult line supply conditions</li> <li>■ Higher productivity through prevention of interruptions of the production line</li> <li>■ Adaptation to application-relevant reactions through flexible definition in case of fault / alarm</li> </ul>
<h3>Robustness</h3>	 <p>SINAMICS V20</p> <p>Motor</p> <p>Wider voltage range, better cooling design and coated PCB increase robustness of the drive in difficult application environments.</p>	<ul style="list-style-type: none"> <li>■ Operation possible when the line supply voltage fluctuates</li> <li>■ Reliable operation for line voltages: 1AC 200V ... 240V (–10% / +10%)<sup>1)</sup> 3AC 380V ... 480V (–15% / +10%)</li> <li>■ Operation at ambient temperatures between –10° C and 60° C</li> </ul>

<sup>1)</sup> Voltage tolerance for FSAA/FSAB (–15% / +10%)

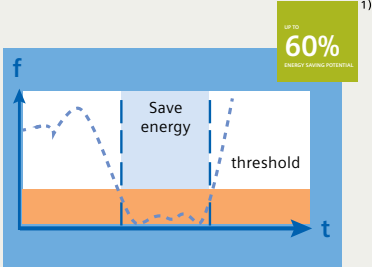

# Easy to save money

	SINAMICS V20 feature	Your benefits
<b>ECO mode/Hibernation mode — energy reduction during operation and standby</b>		
 <p><sup>1)</sup></p>	<p>Integrated ECO mode for <math>V/f</math> and <math>V^2/f</math> automatically adapts the flux to save energy. The energy consumption can be shown in kWh, CO<sub>2</sub> or even in the local currency.</p> <p>Hibernation mode, drive and motor are only activated when used by the plant or machine.</p>	<p>ECO mode:</p> <ul style="list-style-type: none"> <li>■ Energy saving during low dynamic load cycles</li> <li>■ Tells end users the actual energy that has been saved</li> </ul> <p>Hibernation mode:</p> <ul style="list-style-type: none"> <li>■ Smart hibernation saves energy</li> <li>■ Extended lifetime of motor</li> </ul>

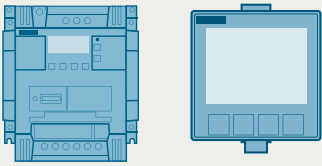
<b>Integrated energy and water flow monitoring</b>		
 <p>V20      Power meter for power measurement</p>	<p>Energy consumption and savings are monitored without the need for power measurement equipment.</p>	<ul style="list-style-type: none"> <li>■ Intuitive values of power consumption and savings without additional investments for measurement equipment</li> <li>■ Values can be shown as kWh, CO<sub>2</sub> or as a currency</li> </ul>

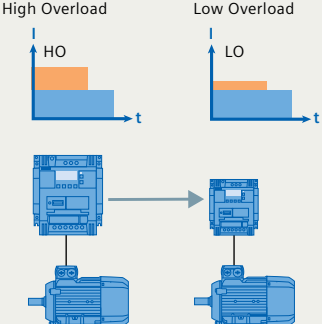
<b>Cost-saving for low overload applications</b>		
	<p>SINAMICS V20 FSE (22 kW/30 hp and 30 kW/40hp) have two different load cycles.</p> <ul style="list-style-type: none"> <li>■ Low Overload (LO): 110% I<sub>L</sub><sup>2)</sup> for 60s (cycle time: 300s)</li> <li>■ High Overload (HO): 150% I<sub>H</sub><sup>3)</sup> for 60s (cycle time: 300s)</li> </ul>	<ul style="list-style-type: none"> <li>■ With low overload cycle, the drive can reach a higher output current and power. A smaller drive can be used.</li> <li>■ Optimally designed for a variety of applications: <ul style="list-style-type: none"> <li>▪ Low Overload for applications with a low dynamic response (continuous duty)</li> <li>▪ High Overload for applications with a high dynamic response (cyclic duty)</li> </ul> </li> </ul>

<sup>1)</sup> Application and machine-type dependent    <sup>2)</sup> The output current I<sub>L</sub> is based upon the duty cycle for low overload (LO).    <sup>3)</sup> The output current I<sub>H</sub> is based upon the duty cycle for high overload (HO).

# Integrated and innovative support

## Fast product selection and ordering



### The DT Configurator supports you with:

- Selecting the best drive based upon the application
- Selecting the correct part number

### The DT Configurator supplies you with:

- A drive that is optimally tailored to your requirements
- 2D models
- 3D models
- Data sheets
- EPLAN macros

You can directly order the selected components through Industry Mall—the Siemens e-commerce website—and without having to duplicate entries. In order to avoid making mistakes while ordering, the order number is checked to ensure that it is correct.

[siemens.com/dt-configurator](http://siemens.com/dt-configurator)

### SINAMICS SELECTOR app

- Find part numbers quickly and easily
- Scan this QR-code to download the SINAMICS SELECTOR app free-of-charge



## Industry Mall — comprehensive online information and services



### Industry Mall supports you with:

- Selecting products, services and trainings

### Industry Mall supplies you with:

- A product selection of the complete and up-to-date Siemens automation and drive technology product spectrum
- System configuration
- Download of CAX data, data sheets and schematic diagrams
- Online shopping cart orders
- Price and order overview
- Availability check and order tracking

[mall.industry.siemens.com](http://mall.industry.siemens.com)

## SINAMICS V20 — best-in-class service and support

### USA hotline support

(423) 262-5710 or (800) 333-7421

### At home or across the globe

- Global hotline support
- Comprehensive service network of factory-trained repair specialists
- Multiple language web-based support and FAQs

### Online support

The comprehensive online information platform supports you in all aspects of our service and support at any time and from any location in the world.

[siemens.com/automation/service&support](http://siemens.com/automation/service&support)

### Technical support

Expert advice on technical questions with a wide range of demand-optimized services for all our products and systems.

[siemens.com/automation/support-request](http://siemens.com/automation/support-request)



# Complete motion control solutions from Siemens

SINAMICS V20 and SIMATIC – Siemens offers comprehensive solutions from a single source for general motion control applications. Through the optimized interaction between SIMATIC control and SINAMICS drive technology, as shown in our “SINAMICS Application Examples,” we can provide you with highly efficient systems.

Siemens application examples comprise	Customer benefits
<ul style="list-style-type: none"> <li>Ready-to-run application examples, including wiring diagrams, parameter descriptions</li> <li>Sample configurations for connecting SINAMICS with SIMATIC, including hardware, software and wiring examples, installation instructions for the supplied S7 project, drive parameterization, and HMI sample projects</li> </ul>	<ul style="list-style-type: none"> <li>Basis for customer-specific configurations</li> <li>Optimal leveraging of TIA advantages</li> </ul> <p>Free download via the Online Support Portal: <b>siemens.com/sinamics-applications</b></p>

## Example—speed control of a V20 with S7-1200 (TIA Portal) via USS® protocol/MODBUS RTU with HMI

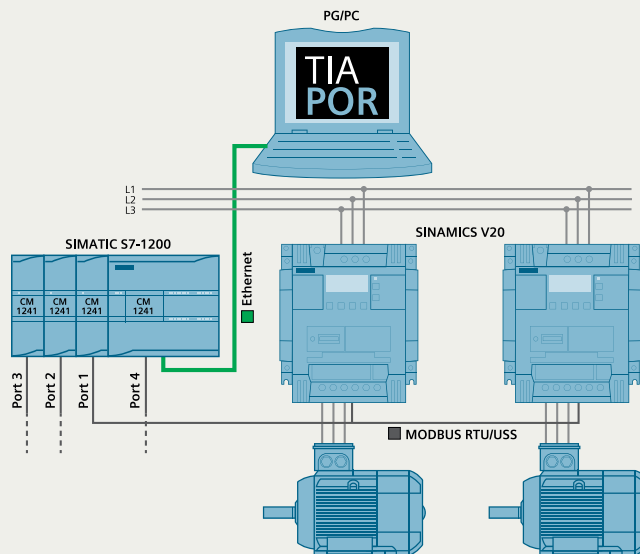

Task	Solution
<p><b>USS communication</b></p> <ul style="list-style-type: none"> <li>Cyclic write/read access of a SIMATIC S7-1200 to selected SINAMICS V20 process/control data, the transmission of which is supported by a STEP 7 instruction</li> <li>Connections of up to 64 drives are possible</li> </ul> <p><b>MODBUS communication</b></p> <ul style="list-style-type: none"> <li>Cyclic write/read access of a SIMATIC S7-1200 to selected SINAMICS V20 process/control data that can be triggered via a STEP 7 instruction via MODBUS register numbers</li> </ul>	<p>With up to three communication modules CM1241 added to the SIMATIC S7-1200 and one communication board CB1241, a USS® or MODBUS communication can be established to SINAMICS V20 drives.</p> <p><b>USS communication</b></p> <ul style="list-style-type: none"> <li>Up to 16 drives can be operated per port. The user function blocks use STEP 7 instructions USS_PORT, USS_DRV, USS_RPM and USS_WPM</li> </ul> <p><b>MODBUS communication</b></p> <ul style="list-style-type: none"> <li>Up to 32 drives can be operated per port (with repeaters, up to 247). The user function blocks use the STEP 7 instructions MB_COMM_LOAD and MB_MASTER</li> </ul> <p><b>siemens.com/sinamics-applications</b></p>

# Technical information



## Overload characteristics (Frame size E only\*)

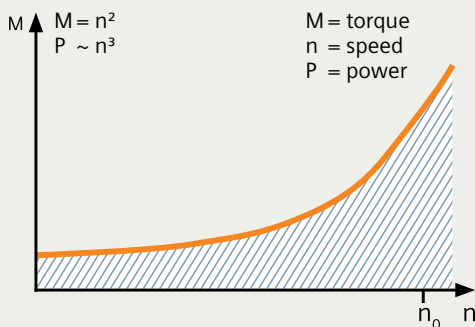

**Low Overload (LO)** is generally used for applications demanding a low level of dynamic performance (continuous duty), square-law torque characteristic with low breakaway torque and low speed precision.

**For example:** centrifugal pumps, radial/axial fans, reciprocating blowers, radial compressors, vacuum pumps, agitators, etc.

### Low overload (LO) capability

110%  $I_L$ <sup>1)</sup> for 60 s within a cycle time of 300 s

<sup>1)</sup> The output current  $I_L$  is based on the duty cycle for low overload (LO).

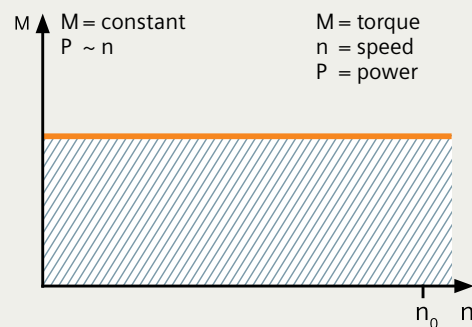

**High Overload (HO)** is generally used for applications demanding a higher dynamic performance (cyclic duty), as well as constant torque characteristics with a high breakaway torque.

**For example:** conveyor belts, geared pumps, eccentric worm pumps, mills, mixers, crushers, vertical conveying equipment, centrifuges, etc.

### High overload (HO) capability

150%  $I_H$ <sup>2)</sup> for 60 s within a cycle time of 300 s

<sup>2)</sup> The output current  $I_H$  is based on the duty cycle for high overload (HO).

\* All other frame sizes AA–D have HO rating only

## Easy accessibility from outside the cabinet plus wireless commissioning and operation



Power and control	
Voltage	1AC 230V: 1AC 200V ... 240V (-10% ... +10%) <sup>1)</sup> 3AC 480V: 3AC 380V ... 480V (-15% ... +10%)
Maximum output voltage	100% of input voltage
Supply frequency	50/60 Hz
Line supply type	TN, TT, TT earthed line, IT <sup>2)</sup>
Power range	1AC 230V 0.12 ... 3.0 kW (1/6 ... 4 hp) 3AC 480V 0.37 ... 30 kW (1/2 ... 40 hp)
cos φ / Power factor	≥ 0.95 / 0.72
Overload capability	up to 15 kW: High Overload (HO): 150% I <sub>H</sub> for 60 s within a cycle time of 300 s from 18.5 kW: Low Overload (LO): 110% I <sub>L</sub> for 60 s within a cycle time of 300 s High Overload (HO): 150% I <sub>H</sub> for 60 s within a cycle time of 300 s
Output frequency	0 ... 550 Hz resolution: 0.01 Hz
Efficiency factor	98%
Control modes	Voltage / frequency control mode: linear V/f, square law V/f, multi-point V/f Flux current control mode: FCC

<sup>1)</sup> Single-phase devices can also be connected to two phases of a 3-phase 120/240V 2-supply system. The voltage between L1 and L2 should be in the range of 200V to 240V -10% to 10% (either phase to phase or phase to neutral). You can find detailed information here: <http://support.industry.siemens.com/cs/document/109476260>

<sup>2)</sup> 1AC 230V FSAA/AB unfiltered devices as well as 3AC 480V unfiltered devices, can be operated at IT network.

Standards	
Standards	CE, cULus, RCM, KC
EMC standards, radiated emissions and disturbance voltage (conducted emissions and radiated emissions when installed according to EMC requirements)	<p><b>EN61800-3 category C1, 1st environment (residential):</b></p> <ul style="list-style-type: none"> <li>1AC 230V 0.12 to 0.75 kW with integrated EMC filter, or unfiltered with external line filter, shielded cables <math>\leq 5</math> m</li> </ul> <p><b>EN61800-3 category C2, 1st environment (domestic premises):</b></p> <ul style="list-style-type: none"> <li>1AC 230V 1.1 to 3 kW with integrated EMC filter, shielded cables <math>\leq 25</math> m</li> <li>3AC 480V without integrated EMC filter with external line filter, shielded cables FSA<sup>3)</sup> up to FSE <math>\leq 25</math> m</li> </ul> <p><b>EN61800-3 category C3, 2nd environment (industrial premises):</b></p> <ul style="list-style-type: none"> <li>3AC 480V with integrated EMC filter, shielded cables FSA <math>\leq 10</math> m, FSB up to FSD <math>\leq 25</math> m, FSE <math>\leq 50</math> m</li> </ul>

Features	
Energy savings	<ul style="list-style-type: none"> <li>ECO mode</li> <li>Hibernation mode</li> <li>Energy consumption monitoring</li> </ul>
Ease-of-use	<ul style="list-style-type: none"> <li>Connection and application macro</li> <li>Parameter cloning</li> <li>Web server module for wireless commissioning, operation, diagnostics and maintenance (option)</li> <li>Keep Running Mode</li> <li>USS/Modbus RTU communication</li> <li>Customized default value</li> <li>List of modified parameters</li> <li>Drive status at fault</li> <li>Automatic restart</li> <li>Flying start</li> <li>DC-link voltage control</li> <li>I<sub>max</sub> control</li> </ul>
Application	<ul style="list-style-type: none"> <li>PID controller</li> <li>BICO function</li> <li>Hammer start</li> <li>Super torque mode</li> <li>Blockage clearing mode</li> <li>Motor staging</li> <li>Flexible boost control</li> <li>Wobble function</li> <li>Slip compensation</li> <li>Dual ramp</li> <li>Adjustable PWM modulation</li> </ul>
Protection	<ul style="list-style-type: none"> <li>Frost protection</li> <li>Condensation protection</li> <li>Cavitation protection</li> <li>Kinetic buffering</li> <li>Load failure detection</li> </ul>

Signal inputs and outputs	
Analog inputs	<ul style="list-style-type: none"> <li>AI1: bipolar current/voltage mode, 12-bit resolution</li> <li>AI2: unipolar current/voltage mode, 12-bit resolution</li> <li>Can be used as digital inputs</li> </ul>
Analog outputs	AO1: 0 ... 20 mA
Digital inputs	DI1–DI4, optically isolated PNP/NPN selectable by terminal
Digital outputs	DO1: transistor output DO2: relay output <ul style="list-style-type: none"> <li>250V AC 0.5 A with resistive load</li> <li>30V DC 0.5 A with resistive load</li> </ul>

<sup>3)</sup> To achieve 25 m shielded motor cable length also with FSA, unfiltered devices with external filter have to be used.

## Connection diagram

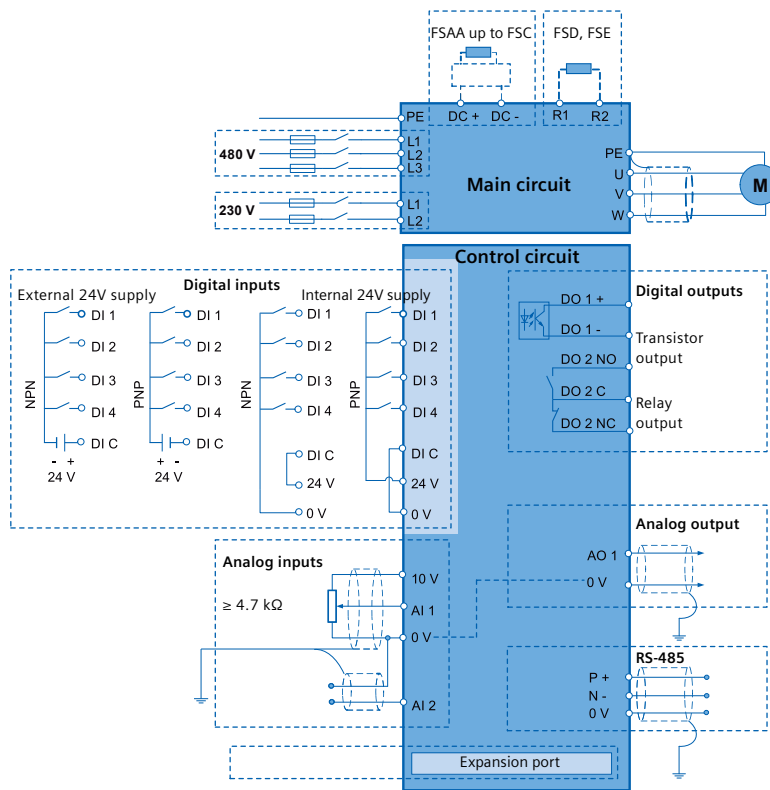

## Mounting and environment

Degree of protection	IP20
Mounting	Wall mounting, side-by-side mounting, push-through mounting for FSB, FSC, FSD and FSE
Cooling	<ul style="list-style-type: none"> <li>0.12 to 0.75 kW: convection cooling</li> <li>All frame sizes: power electronics cooled using heat sinks with external fan</li> </ul>
Ambient temperature	<p>In operation</p> <ul style="list-style-type: none"> <li>-10 ... 60° C (14 ... 140° F)</li> <li>40 ... 60° C (104 ... 140° F) with derating</li> </ul> <p>In Storage</p> <ul style="list-style-type: none"> <li>-40 ... 70° C (-40 ... 158° F)</li> </ul>
Relative humidity	95% (non-condensing)
Altitude	<ul style="list-style-type: none"> <li>Up to 4000 m above sea level</li> <li>1000 ... 4000 m: output current derating</li> <li>2000 ... 4000 m: supply voltage derating</li> </ul>
Motor cable length	<ul style="list-style-type: none"> <li>Unshielded cable: 50 m for FSSA up to FSD, 100 m for FSE</li> <li>Shielded cable: 25 m for FSSA up to FSD, 50 m for FSE</li> <li>Longer motor cables possible with output reactor (see options)</li> </ul>
Dynamic braking	Option module for FSSA to FSC; integrated for FSD and FSE

# Dimensions

## SINAMICS V20 drive

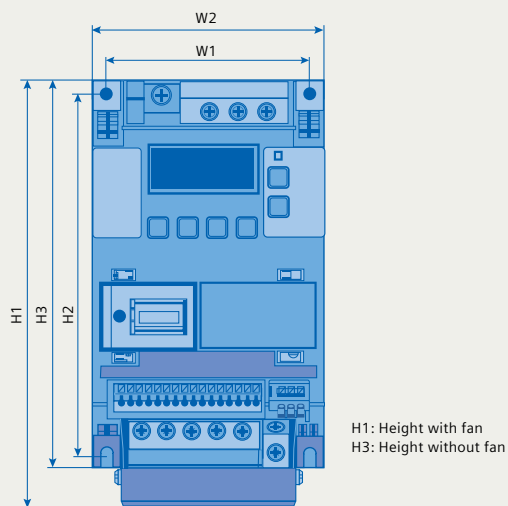
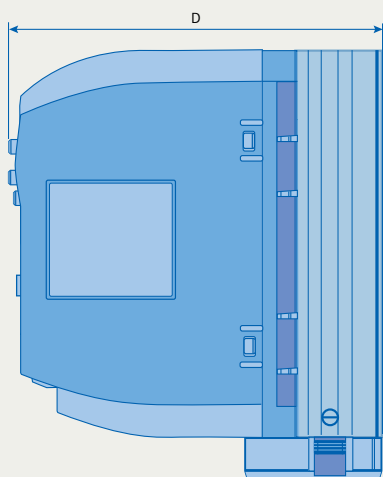

Frame size	Width (mm)		Height (mm)			Depth (mm)	Weight (kg)
	W1	W2	H1	H2	H3	D	WT approx.
FSAA	58	68	–	132	142	107.8	0.7
FSAB	58	68	–	132	142	127.8	0.9
FSA	79	90	166	140	150	145.5	1.05
FSB	127	140	160	135	–	164.5	1.8
FSC	170	184	182	140	–	169	2.6
FSD	223	240	206.5	166	–	172.5	4.3
FSE	228	245	264.5	206	–	209	6.6

## V20 Basic Operator Panel (BOP)

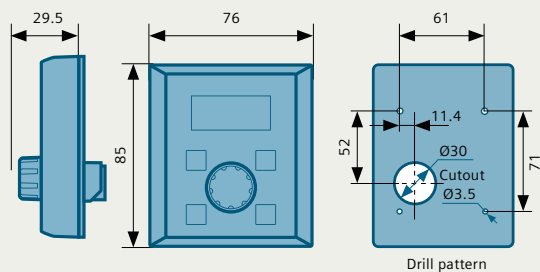

## V20 Basic Operator Panel (BOP) interface

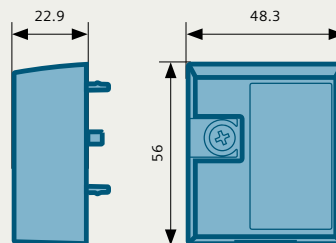

## V20 Smart Access (web server module)

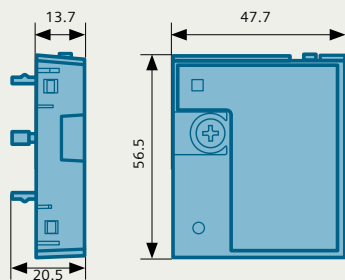

## V20 Parameter loader

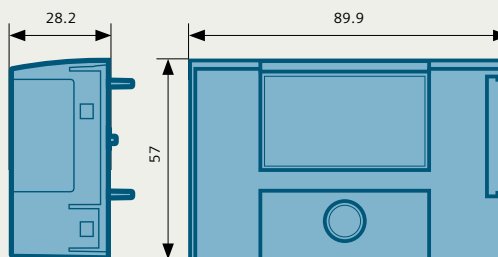



## We made it even smaller



Frame size FSAA



Frame size FSAB

Frame size FSAA and FSAB, 1AC 230V 0.12 to 0.75 kW with integrated EMC filter

### 1AC 200–240V options

P <sub>rated</sub> (HO) kW 1AC 230V	hp	FS	Braking resistors				Line reactors				Output reactors				Braking module				Line filter class B			
			W	H	D	WT	W	H	D	WT	W	H	D	WT	W	H	D	WT	W	H	D	WT
0.12	1/6	AA	72	230	43.5	1	75.5	200	50	0.5	75	200	50	1.3	90	150	88	0.71	73	200	43.5	0.5
0.25	1/3																					
0.37	1/2																					
0.55	≤	AB	149	239	1.6	150	213	1.2	150	213	80	4.1	149	213	50.5	1						
0.75	1																					
1.1	1.5	B	185	285	150	3.8	185	245	1.0	185	245	6.6	-									
1.5	2	C																				
2.2	3																					
3	4																					

### 3AC 380–480V options

P <sub>rated</sub> (LO) kW 3AC 400V	hp	FS	Braking resistors				Line reactors				Output reactors				Braking module				Line filter class B			
			W	H	D	WT	W	H	D	WT	W	H	D	WT	W	H	D	WT	W	H	D	WT
0.37	1/2	A	105	295	100	1.48	125	120	71	1.1	178	175	73	3.4	90	150	80	0.71	73	202	65	1.75
0.55	≤																					
0.75	1																					
1.1	1.5	B	105	345	100	1.80	125	140	71	2.1	178	180	73	3.9	100	297	85	4				
1.5	2																					
2.2	3	C	175	345	100	2.73	125	145	91	2.95	243	215	100	10.1	integrated	140	359	95	7.3			
3	4																					
4	5	D	250	490	140	6.20	190	220	81	7.8	243	235	115	11.2	100	400	140	7.6				
5.5	7.5																					
7.5	10	E	270	515	175	7.4	275	455	84	13	225	210	150	10.7	179	16.1						
11	15																					
15	20																					
22	30																					
30	40																					

FS = frame size, WT = weight in kg, W = width in mm, H = height in mm, D = depth in mm

# System at a glance

## SINAMICS V20

3AC 380V ... 480V

1AC 200V ... 240V

1AC 200V ... 240V



F5AA

F5AB

F5A

F5B

F5C

F5D

F5E



SINAMICS V20 BOP  
(Basic Operator Panel)



SINAMICS V20  
BOP interface



SINAMICS V20  
Smart Access



SINAMICS V20  
Parameter loader



SINAMICS V20  
Braking module

## SINAMICS V20—Options



Braking resistor



Line reactor



Output reactor

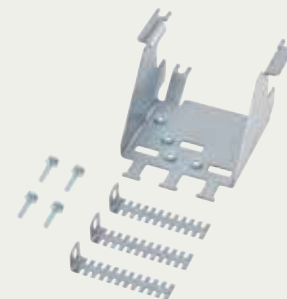

Shield connection kit



Line filter



Standard fuse



Circuit breaker



Replacement fan



Standard RJ45 LAN cable

# Full range of options

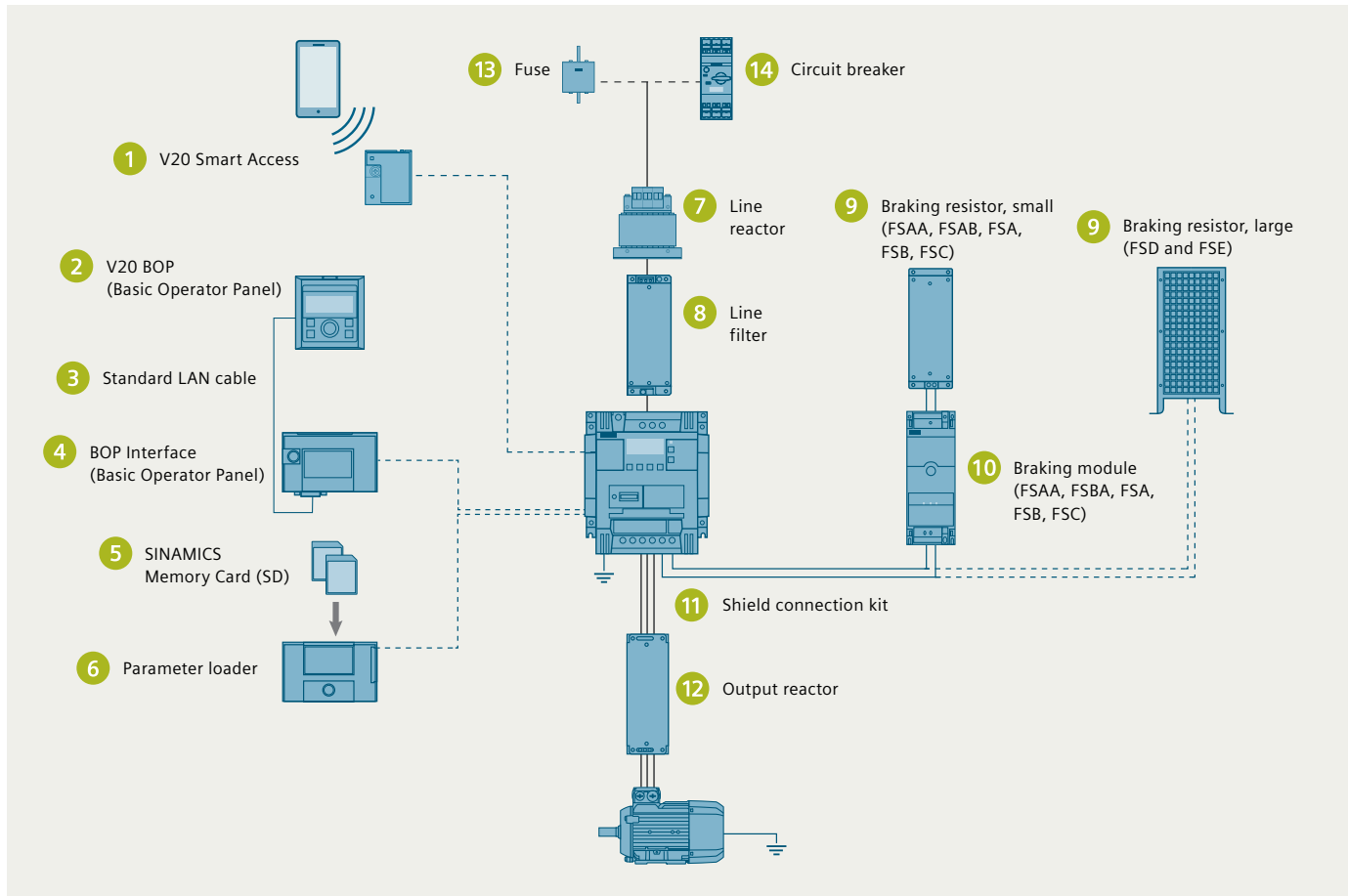

## 1 V20 Smart Access

Wireless commissioning, operation and diagnostics with mobile device or laptop with web server module

## 2 V20 BOP

Same function as the integrated BOP (Basic Operator Panel), but can be used for remote mounting. The value and setpoint are changed by rotating the wheel. For remote mounting with IP54 and UL Type 1 enclosure protection level from outside.

## 3 BOP cable

The cable is not included in the delivery. You can use any standard LAN cable with standard RJ45 connector.

## 4 BOP interface

- Connection between drive and BOP
- RJ45 interface is compatible with standard LAN cable

## 5 SINAMICS Memory Card (SD)

- 512 MB (Standard SD cards up to 32 GB are supported)

## 6 Parameter loader

Up to 100 parameter sets with parameter settings can be written from the memory card (SD card up to 32 GB supported) to the drive or saved from the drive to the memory card without connecting the drive to the line supply.

## 7 Line reactor

- Reduces the harmonic current
- Improves the power factor
- Recommended if input current (RMS value) is higher than the rated current of the drive

## 8 Line filter

- Improved EMC performance
- Longer motor cable for FSAA, FSAB, FSA

## 9 Braking resistor

- Dissipates regenerative energy as heat
- 5% duty cycle as default setting

## 10 Braking module

- Shortens the deceleration ramp time
- Suitable for 1AC 230V and 3AC 480V
- Adjustable duty cycle from 5% to 100%
- FSD and FSE already have an integrated braking unit

## 11 Shield connection kit

- Shield connection
- Strain relief

## 12 Output reactor

- Longer motor cable:
- 3AC 480V shielded and unshielded cable: 150 m for FSA to FSD, 200 m / 300 m for FSE
  - 1AC 230V shielded and unshielded cable: 200 m

## 13 Fuse

Recommended fuse corresponding to the EC/UL standard

## 14 Circuit breaker

Recommended circuit breaker corresponding to the EC/UL standard

1AC 200–240V<sup>1)</sup>

Rated data						
P <sub>rated</sub> (HO)		I <sub>H</sub>	Part number	Fans		Frame size
kW	hp	A				
0.12	1/6	0.9	6SL3210-5BB11-2	V1	–	FSAA
0.25	1/3	1.7	6SL3210-5BB12-5	V1	–	
0.37	1/2	2.3	6SL3210-5BB13-7	V1	–	
0.55	3/4	3.2	6SL3210-5BB15-5	V1	–	FSAB
0.75	1	4.2	6SL3210-5BB17-5	V1	1	FSB
1.1	1–1/2	6	6SL3210-5BB21-1	V0	1	
1.5	2	7.8	6SL3210-5BB21-5	V0	1	
2.2	3	11	6SL3210-5BB22-2	V0	1	FSC
3	4	13.6	6SL3210-5BB23-0	V0	1	

EMC Standards	
Without integrated filter	U
With integrated line filter category C2 <sup>2)</sup> (only available for FSB and FSC from 1.1 to 3 kW)	A
With integrated line filter category C1 <sup>3)</sup> (only available for FSAA and FSAB up to 0.75 kW)	B

<sup>1)</sup> Single-phase devices can also be connected to two phases of a 3-phase 120/240V 2-supply system. The voltage between L1 and L2 should be in the range of 200V to 240V –10% to 10% (either phase to phase or phase to neutral. You can find detailed information here: <http://support.industry.siemens.com/cs/document/109476260>

<sup>2)</sup> Disturbance suppression limits according to EN 61800-3 category C2 use in first environment (residential, domestic). The drive system must be installed by specialized personnel under consideration of regional regulations with respect to line harmonics.

<sup>3)</sup> Disturbance suppression limits according to EN 61800-3 category C1 use in first environment (residential, domestic). The drive system must be installed by specialized personnel under consideration of regional regulations with respect to line harmonics.

<sup>4)</sup> Disturbance suppression limits according to EN 61800-3 category C3 use in second environment (industry).

<sup>5)</sup> See specification of EMC standards, page 10

<sup>6)</sup> Additional information about the listed fuses and circuit breakers can be found in Catalogs LV 10, IC 10 and IC 10 AO <http://siemens.com/drives/infocenter>

<sup>7)</sup> BOP interface and BOP integrated standard RJ45 connector compatible for standard Ethernet cable.

<sup>8)</sup> The cable is not included in the delivery. You can use any standard LAN cable with standard RJ45 connector.

<sup>9)</sup> For installation of FSA with fan, please refer to SINAMICS V20 manual. Installation of FSAA/AB, DIN Rail Mounting Kit for FSA install with migration mounting kit together.

<sup>10)</sup> The output current I<sub>l</sub> is based on the duty cycle for low overload (LO).

<sup>11)</sup> The output current I<sub>H</sub> is based on the duty cycle for high overload (HO).

1AC 200–240V options

FS	P <sub>rated</sub> (HO) kW	Braking resistor 6SE6400-...	Line reactor 6SE6400-...	Output reactor 6SE6400-...	Shield connection kit 6SL3266-...	Line filter class B <sup>5)</sup> 6SE6400-...	Corresponding to the IEC standard		
							Standard fuse <sup>6)</sup>		Circuit breaker <sup>6)</sup>
							Current in A	Part number	Part number
FSAA	0.12	4BC05-0AA0	3CC00-4AB3	3TC00-4AD3	1AR00-0VA0	6SL3203-0BB21-8VA0	10	3NA3803	3RV2011-1DA10
	0.25								3RV2011-1FA10
	0.37		3RV2011-1HA10						
FSAB	0.55	4BC11-2BA0	3CC01-0AB3	3TC01-0BD3	1AB00-0VA0	6SE6400-2FL02-6BB0	16	3NA3805	3RV2011-1JA10
	0.75		3RV2011-1KA10						
FSB	1.1	4BC11-2BA0	3CC02-6BB3	3TC01-0BD3	1AB00-0VA0	6SE6400-2FL02-6BB0	20	3NA3807	3RV2021-4BA10
	1.5								3RV2021-4CA10
FSC	2.2	4BC12-5CA0	3CC03-5CB3	3TC03-2CD3	1AC00-0VA0	–	35	3NA3814	3RV2021-4EA10
	3				3RV1031-4FA10				

Accessories

Name	Part number
Parameter loader	6SL3255-0VE00-0UA1
V20 BOP (Basic Operator Panel)	6SL3255-0VA00-4BA1
BOP interface <sup>7)</sup> (Basic Operator Panel)	6SL3255-0VA00-2AA1
SINAMICS V20 Smart Access (web server module)	6SL3255-0VA00-5AA0 <span style="background-color: orange; color: white; padding: 2px;">New</span>
SINAMICS Memory Card (512 MB)	6SL3054-4AG00-2AA0
Braking module ■ 1AC 230V: 8A ■ 3AC 480V: 7A	6SL3201-2AD20-8VA0
BOP cable <sup>8)</sup>	–
RS485 Terminators (Content 50 pieces)	6SL3255-0VC00-0HA0
DIN Rail mounting kit	FSA/FSAA/FSAB: 6SL3261-1BA00-0AA0 <sup>9)</sup> FSB: 6SL3261-1BB00-0AA0
Migration Mounting Kit to fit FSAA/AB to former FSA	6SL3266-1ER00-0VA0
SINAMICS V20 training demo case (includes Frame AB drive and Smart Access module)	6AG1067-2AA0-0AB9

Spare parts

Replacement fan	
Frame size	Part number
FSA	6SL3200-0UF01-0AA0
FSB	6SL3200-0UF02-0AA0
FSC	6SL3200-0UF03-0AA0
FSD	6SL3200-0UF04-0AA0
FSE	6SL3200-0UF05-0AA0

3AC 380–480V

Rated data									
P <sub>rated</sub> (LO)		I <sub>L</sub> 480 V <sup>(10)</sup>	P <sub>rated</sub> (HO)		I <sub>H</sub> 480 V <sup>(11)</sup>	Part number	Fans	Frame size	
kW	hp	A	kW	hp	A				
0.37	1/2	1.3	0.37	1/2	1.3	6SL3210-5BE13-7	V0	–	FSA
0.55	3/4	1.7	0.55	3/4	1.7	6SL3210-5BE15-5	V0	–	
0.75	1	2.2	0.75	1	2.2	6SL3210-5BE17-5	V0	–	
1.1	1–1/2	3.1	1.1	1–1/2	3.1	6SL3210-5BE21-1	V0	1	
1.5	2	4.1	1.5	2	4.1	6SL3210-5BE21-5	V0	1	
2.2	3	4.8	2.2	3	4.8	6SL3210-5BE22-2	V0	1	
3	4	7.3	3	4	7.3	6SL3210-5BE23-0	V0	1	FSB
4	5	8.24	4	5	8.24	6SL3210-5BE24-0	V0	1	
5.5	7–1/2	11	5.5	7–1/2	11	6SL3210-5BE25-5	V0	1	FSC
7.5	10	16.5	7.5	10	16.5	6SL3210-5BE27-5	V0	2	FSD
11	15	21	11	15	21	6SL3210-5BE31-1	V0	2	
15	20	31	15	20	31	6SL3210-5BE31-5	V0	2	
22	30	40	18.5	25	34	6SL3210-5BE31-8	V0	2	FSE
30	40	52	22	30	40	6SL3210-5BE32-2	V0	2	
EMC Standards									
With integrated line filter category C3 <sup>(4)</sup>							C		
Without integrated filter							U		

3AC 380–480V options

FS	P <sub>rated</sub> (LO) kW	P <sub>rated</sub> (HO) kW	Braking resistor 6SL3201-...	Line reactor 6SL3203-...	Output reactor 6SL3202-...	Shield connection kit 6SL3266-...	Line filter class B <sup>(5)</sup> 6SL3203-...	Corresponding to the IEC standard		
								Standard fuse <sup>(6)</sup>		Circuit breaker <sup>(6)</sup>
								Current in A	Part number	Part number
FSA	0.37	0.37	OBE14-3AA0	OCE13-2AA0	0AE16-1CA0	1AA00-0VA0	OBE17-7BA0	6	3NA3801	3RV2011-1CA10
	0.55	0.55								3RV2011-1DA10
	0.75	0.75								3RV2011-1EA10
	1.1	1.1		3RV2011-1FA10						
	1.5	1.5		3RV2011-1HA10						
	2.2	2.2		3RV2011-1JA10						
FSB	3	3	OBE21-0AA0	OCE21-0AA0	0AE18-8CA0	1AB00-0VA0	OBE21-8BA0	16	3NA3805	3RV2011-1KA10
	4	4		0AE21-8CA0						3RV2021-4AA10
FSC	5.5	5.5	OBE21-8AA0	OCE21-8AA0	0AE23-8CA0	1AC00-0VA0	32	3NA3812	3RV2021-4BA10	
FSD	7.5	7.5	OBE23-8AA0	OCE23-8AA0	0AE23-8CA0	1AD00-0VA0	OBE23-8BA0	63	3NA3822	3VL1103-1KM30-0AA0
	11	11								3VL1104-1KM30-0AA0
	15	15								3VL1105-1KM30-0AA0
FSE	22	18.5	6SE6400-...	6SE6400-...	6SE6400-...	6SL3266-...	6SL3203-...	63	3NA3024	3VL1108-1KM30-0AA0
	30	22	4BD21-2DA0	OJC24-5AA0	3TC05-4DD0	1AE00-0VA0	OBE27-5BA0			

Selecting SIMATIC S7-1200 PLC for SINAMICS V20 drives

The shown SIMATIC S7 selection is only a suggestion. For detailed and further information, please refer to the SIMATIC S7-1200 brochure, catalog or web page: [siemens.com/simatic-s7-1200](http://siemens.com/simatic-s7-1200)

CPU			Communication module	
		Part number	RS485 communication for USS or Modbus RTU	Part number
CPU 1211C	1211 CPU AC/DC/Rly	6ES7 211-1BE40-0XB0	CB 1241 RS 485 or CM 1241 RS 485/422	6ES7241-1CH30-1XB0 or 6ES7241-1CH32-0XB0
	1211 CPU DC/DC/DC	6ES7 211-1AE40-0XB0		
	1211 CPU DC/DC/Rly	6ES7 211-1HE40-0XB0		
CPU 1212C	1212 CPU AC/DC/Rly	6ES7 212-1BE40-0XB0		
	1212 CPU DC/DC/DC	6ES7 212-1AE40-0XB0		
	1212 CPU DC/DC/Rly	6ES7 212-1HE40-0XB0		
CPU 1214C	1214 CPU AC/DC/Rly	6ES7 214-1BG40-0XB0		
	1214 CPU DC/DC/DC	6ES7 214-1AG40-0XB0		
	1214 CPU DC/DC/Rly	6ES7 214-1HG40-0XB0		
CPU 1215C	1215 CPU AC/DC/Rly	6ES7 215-1BG40-0XB0		
	1215 CPU DC/DC/DC	6ES7 215-1AG40-0XB0		
	1215 CPU DC/DC/Rly	6ES7 215-1HG40-0XB0		
CPU 1217C	1217 CPU DC/DC/DC	6ES7 217-1AG40-0XB0		

**There's more to it.**

**[usa.siemens.com/sinamics](http://usa.siemens.com/sinamics)**

---

**Everything about our drive family can be found online.**

**SINAMICS — one family, one source, all applications**

**Published by  
Siemens Industry, Inc.**

5300 Triangle Parkway, Suite 100  
Norcross, GA 30092

1-800-879-8079

Order No. DRBR-V2001-0217

Printed in USA

© 2017 Siemens Industry, Inc.

[usa.siemens.com/motioncontrol](http://usa.siemens.com/motioncontrol)

This brochure contains only general descriptions or performance features, which do not always apply in the manner described in concrete application situations or may change as the products undergo further development. Performance features are valid only if they are formally agreed upon when the contract is closed.

Siemens is a registered trademark of Siemens AG. Product names mentioned may be trademarks or registered trademarks of their respective companies. Specifications are subject to change without notice.